



RICOH SP-2230N/SP-2240N Getting Started Instructions préliminaires

Download the installer
Télécharger le programme d'installation



www.pfu.ricoh.com/sp/d
(<https://www.pfu.ricoh.com/sp/d/>)

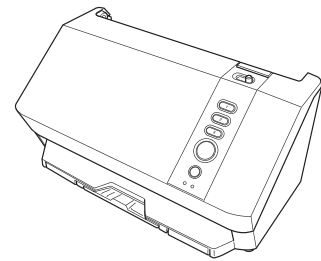
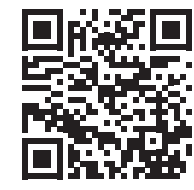

Scanner
Scanneur

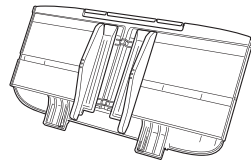

ADF paper chute
(feeder)
Plateau d'alimentation de l'AAD
(chargeur)

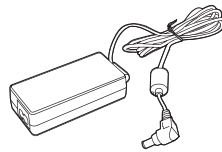

AC adapter
Adaptateur CA



AC cable
Câble CA

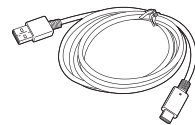

USB cable
Câble USB

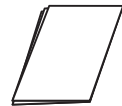

Safety Precautions
Consignes de sécurité

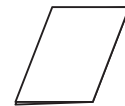

Getting Started (This sheet)
Instructions préliminaires (Cette page)

EN The contents may vary depending on the country and the model purchased.

FR Le contenu risque de différer selon le pays d'achat et le modèle.

DE Je nach Land und Modell können sich die Inhalte unterscheiden.

IT I contenuti possono variare a seconda del Paese e del modello acquistato.

ES Los contenidos pueden diferir de acuerdo al modelo y al país donde adquirió.

RU Содержимое может изменяться в зависимости от страны и выбранной модели сканера.

PT O conteúdo pode variar dependendo do país e do modelo adquirido.

TR Paket içeriği ülkeye ve satın alınmış modele göre farklılık gösterebilir.

ID Isi produk dapat berbeda tergantung pada negara dan model yang dibeli.

AR زاهدال زارطو دلبال فالخالاب تاوتحملا فلتخت دق.

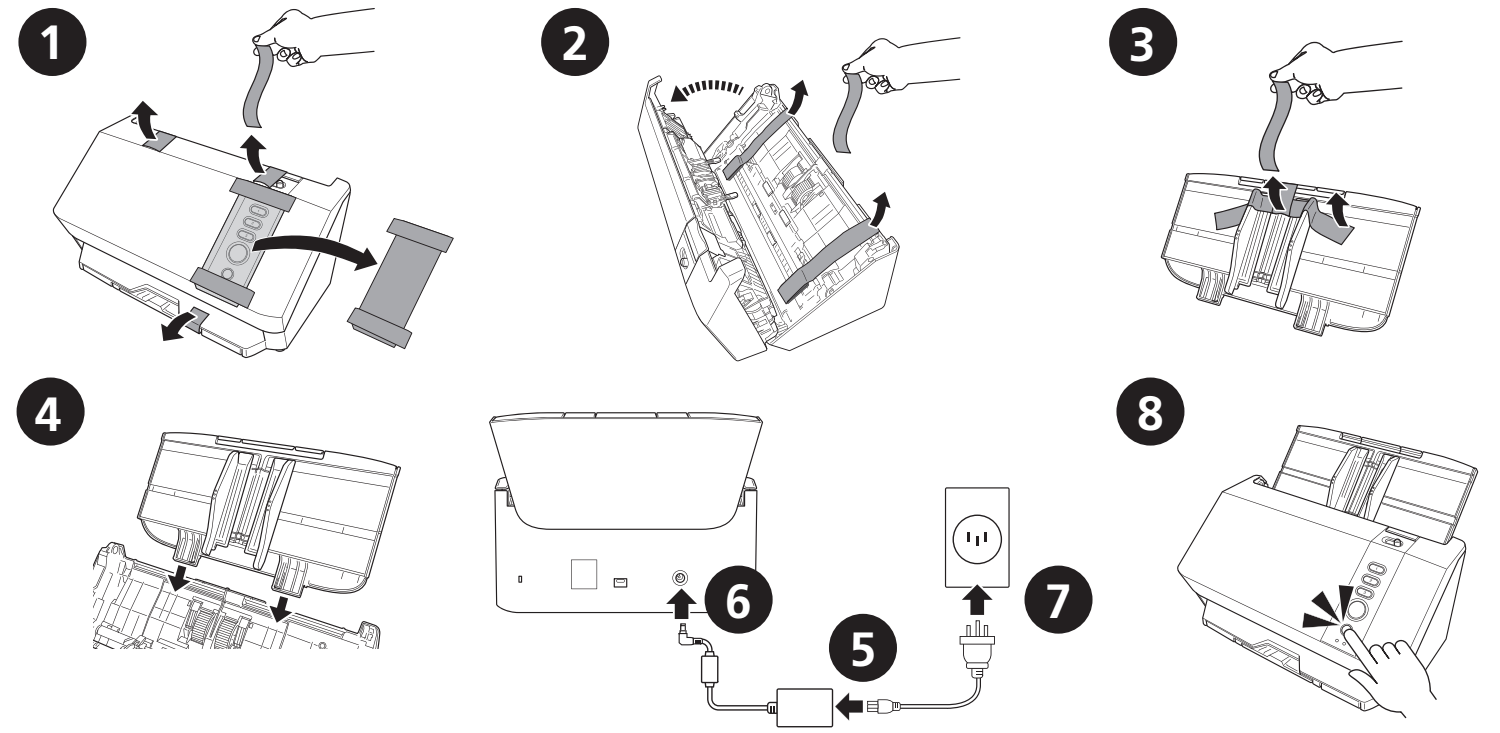

9 Download the installer / Télécharger le programme d'installation



www.pfu.ricoh.com/sp/d
(<https://www.pfu.ricoh.com/sp/d/>)

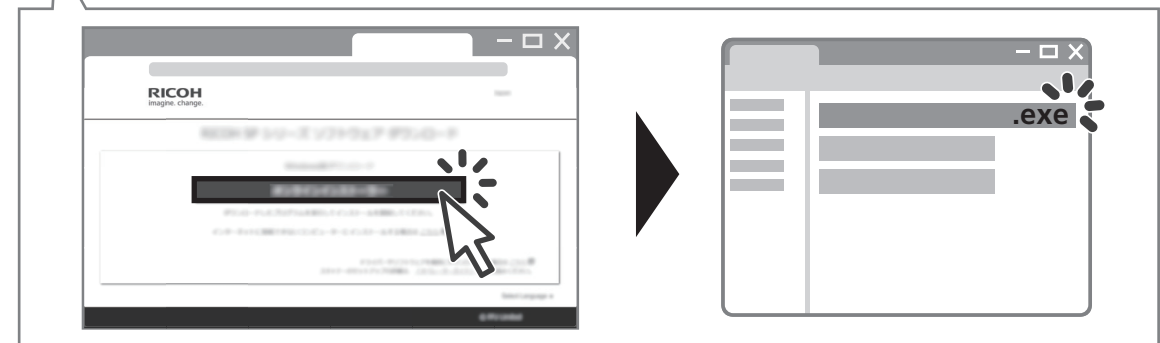

10 Connect using a USB cable Connectez-vous à l'aide d'un câble USB

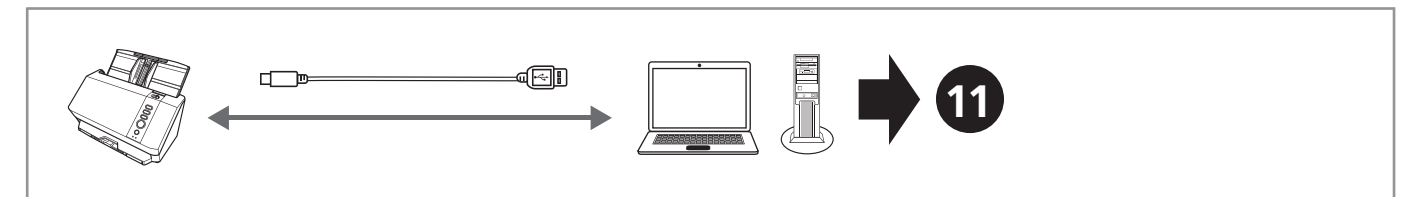

Connect using a LAN cable Connectez-vous à l'aide d'un câble LAN

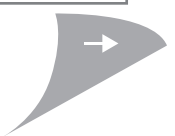
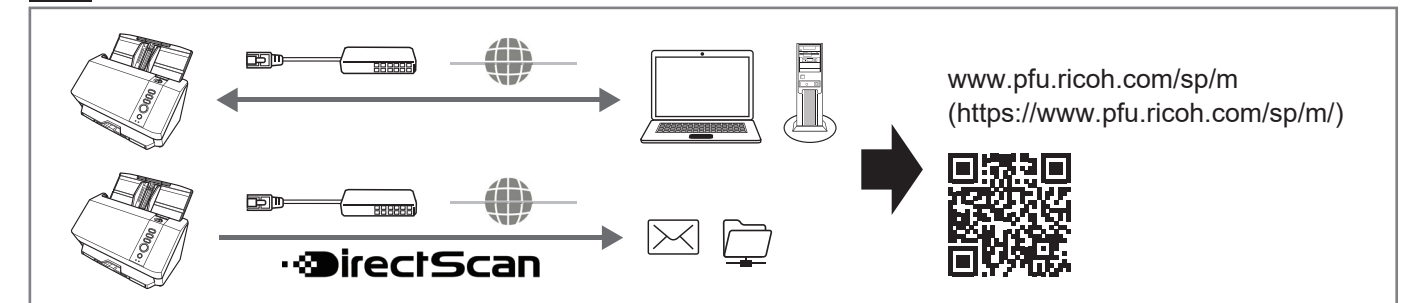

11

- EN Run the installer to set up your scanner.
- FR Exécutez le programme d'installation pour configurer votre scanner.
- DE Führen Sie das Installationsprogramm aus, um Ihren Scanner einzurichten.
- IT Eseguire il programma di installazione per configurare lo scanner.
- ES Ejecute el instalador para configurar su escáner.
- RU Для настройки компьютера запустите установщик.
- PT Execute o arquivo de instalação para configurar o seu scanner.
- TR Tarayıcınızı ayarlamak için kurulum programını çalıştırın.
- ID Jalankan penginstal untuk menyiapkan alat pemindai.
- AR كتحسام دادغل تي بثلت الام ان رب ل غش

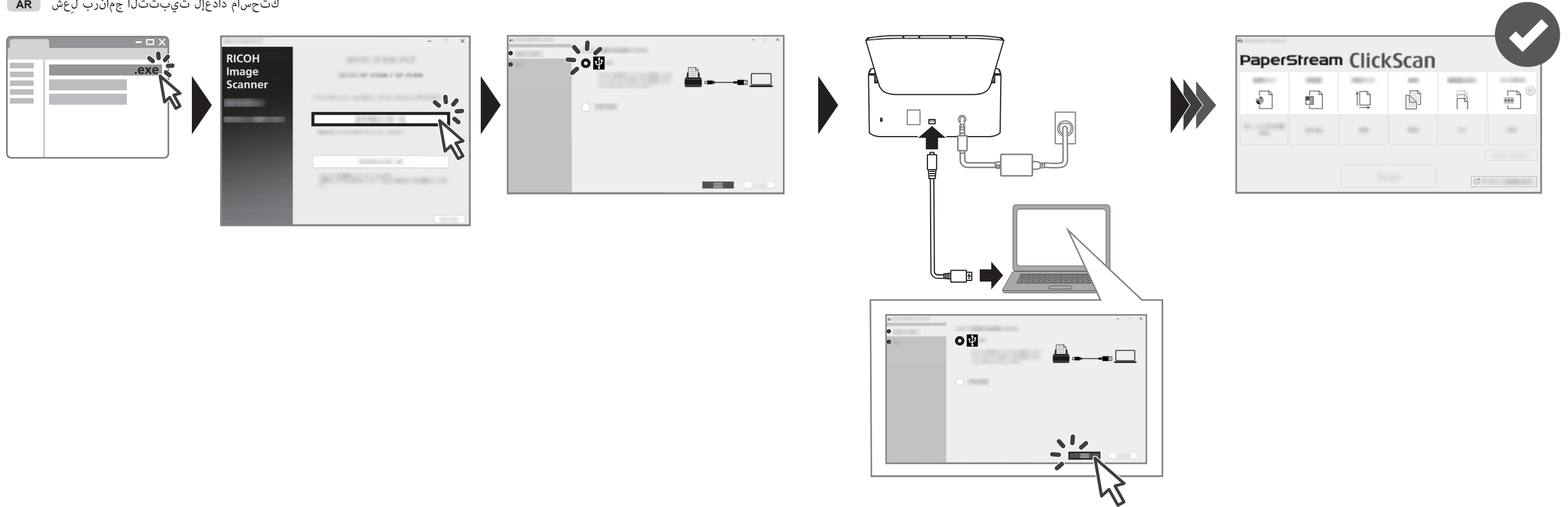

12

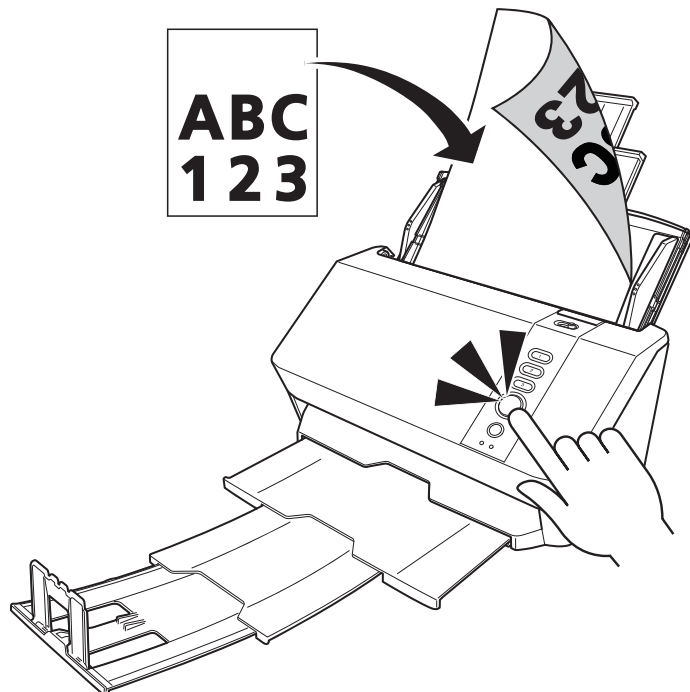



Learn more / En savoir plus

www.pfu.ricoh.com/sp/m
[\(https://www.pfu.ricoh.com/sp/m/\)](https://www.pfu.ricoh.com/sp/m/)

