

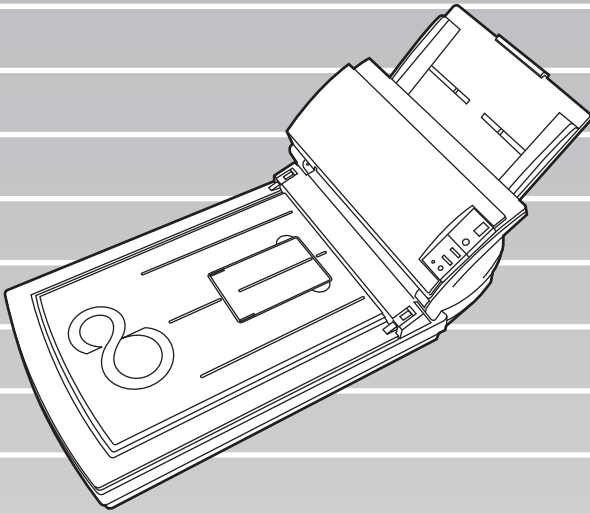

P3PC-E937-02EN

fi-4220C2 Image Scanner

Getting Started



CONTENTS

■ Regulatory Information	ii
■ Note, Liability	iv
■ Safety Precautions	v
Chapter 1 PREPARING THE SCANNER.....	1
1.1 Checking the Contents of the Scanner Package.....	1
1.2 Names and Functions of Parts.....	1
1.3 Operator Panel.....	2
Chapter 2 INSTALLATION OF THE SCANNER.....	3
2.1 Installing the Scanner	3
2.2 Connecting the Scanner to Your PC.....	4
2.3 Installing the Scanner Application	5
Appendix 1 TROUBLESHOOTING.....	AP-1
Appendix 2 DAILY CARE	AP-4
Appendix 3 REPLACING CONSUMABLES.....	AP-5

INTRODUCTION

Thank you for purchasing the fi-4220C2 Duplex Color Scanner product.

This document describes how to handle fi-4220C2 Duplex Color and basic operation methods. Before you start using fi-4220C2 Duplex Color be sure to thoroughly read this manual to ensure correct use.

The "Operator's Guide" is stored on the Setup Disk. The guide provides useful and detailed information on Operations when you would like to using advanced features, daily maintenance of the scanner, replacement of consumables. Please also read the Operator's Guide for your reference.

■ Regulatory Information

FCC Declaration

This equipment has been tested and found to comply with the limits for a Class B digital device, pursuant to Part 15 of the FCC Rules. These limits are designed to provide reasonable protection against harmful interference in a residential installation. This equipment generates, uses, and can radiate radio frequency energy and, if not installed and used in accordance with the instruction manual, may cause harmful interference to radio communications. However, there is no guarantee that interference will not occur in a particular installation. If this equipment does cause harmful interference to radio or television reception, which can be determined by turning the equipment off and on, the user is encouraged to try to correct the interference by one or more of the following measures:

- Reorient or relocate the receiving antenna.
- Increase the separation between the equipment and receiver.
- Connect the equipment into an outlet on a circuit different from that to which the receiver is located.
- Consult your dealer or an experienced radio/TV technician.

FCC warning: Changes or modifications not expressly approved by the party responsible for compliance could void the user's authority to operate the equipment.



The use of a shielded interface cable is required to comply with the Class B limits of Part 15 of FCC rules.

The length of the AC cable must be 2 meters (6.6 feet) or less.



Canadian DOC Regulations

This digital apparatus does not exceed the Class B limit for radio noise emissions from digital apparatus set out in the Radio interference Regulations of the Canadian Department of Communications.

This Class B digital apparatus complies with Canadian ICES-003.

Le présent appareil numérique n'émet pas de bruits radioélectriques dépassant les limites applicables aux appareils numériques de la classe B prescrites dans le Règlement sur le brouillage radioélectrique dicté par le ministère des Communications du Canada.

Cet appareil numérique de la classe B est conforme à la norme NMB-003 du Canada.

Bescheinigung des Herstellers / Importeurs

Hiermit wird bescheinigt, daß *der/die/das*

fi-4220C2

- In Übereinstimmung mit den Bestimmungen der EN45014(CE) funktentstört ist.
- Laut Maschinenlärminformationsverordnung 3. GS GV, 18.01.1991: Der höchste Schalldruckpegel beträgt 70 dB (A) oder weniger gemäß ISO/7779.

International ENERGY STAR® Program

As an ENERGY STAR® Partner, PFU LIMITED has determined that this product meets the ENERGY STAR® guidelines for energy efficiency.

The International ENERGY STAR® Office Equipment Program is an international program that promotes energy saving through the penetration of energy efficient computers and



other office equipment. The program backs the development and dissemination of products with functions that effectively reduce energy consumption. It is an open system in which business proprietors can participate voluntarily. The targeted products are office equipment such as computers, monitors, printers, facsimiles, copiers, scanners, and multifunction devices.

Their standards and logos () are uniform among participating nations.

Use in High-safety Applications

This product has been designed and manufactured on the assumption that it will be used in office, personal, domestic, regular industrial, and general-purpose applications. It has not been designed and manufactured for use in applications (simply called "high-safety applications" from here on) that directly involve danger to life and health when a high degree of safety is required, for example, in the control of nuclear reactions at nuclear power facilities, automatic flight control of aircraft, air traffic control, operation control in mass-transport systems, medical equipment for sustaining life, and missile firing control in weapons systems, and when provisionally the safety in question is not ensured. The user should use this product with adopting measures for ensuring safety in such high-safety applications. PFU LIMITED assumes no liability whatsoever for damages arising from use of this product by the user in high-safety applications, and for any claims or compensation for damages by the user or a third party.

About the Use of Mercury

	<p>Lamp(s) inside this product contain mercury and must be recycled or disposed of according to local, state, or federal laws.</p>
-------------------------------------------------------------------------------------	------------------------------------------------------------------------------------------------------------------------------------

To avoid unexpected injury, read the following carefully. Doing the following actions may result in serious personal injuries:

- Do not put the substance contained in the lamp in your mouth as it has mercury.
- Do not breathe the chemical liquid contained in the scanner lamps.
- Do not incinerate, crush, or shred the lamps or scanner parts.

Trademarks

Microsoft, Windows, and Windows NT are registered trademarks of Microsoft Corporation in the United States and/or other countries.

ISIS, QuickScan and their respective logos are trademarks or registered trademarks of Pixel Translations, a division of Captiva Software Corporation in the United States.

Adobe, the Adobe logo, and Acrobat are either registered trademarks of Adobe Systems Incorporated in the United States and/or other countries.

Other product names are the trademarks or registered trademarks of the respective companies.

How Trademarks Are Indicated In This Manual

References to operating systems (OS) and applications are indicated as follows:

Adobe Acrobat 6.0	Adobe® Acrobat® 6.0 Standard
Windows 95	Microsoft® Windows® 95 operating system
Windows 98	Microsoft® Windows® 98 operating system.
Windows Me	Microsoft® Windows® Millennium Edition operating system.
Windows NT 4.0	Microsoft® Windows® NT 4.0 Server operating system, Microsoft® Windows® NT 4.0 Workstation operating system.
Windows 2000	Microsoft® Windows® 2000 Professional operating system.
Windows XP	Microsoft® Windows® XP Professional operating system, Microsoft® Windows® XP Home Edition operating system.

Where there is no distinction between the different versions of the above operating system, the general term "Windows " is used.

Manufacturer

PFU LIMITED

International Sales Dept., Imaging Business
Division, Products Group
Solid Square East Tower, 580 Horikawa-cho,
Saiwai-ku, Kawasaki-shi Kanagawa 212-8563,
Japan
Phone : (81-44) 540-4538

All Rights Reserved, Copyright© PFU LIMITED 2004-2009.

Note, Liability

BEFORE USING THIS PRODUCT, PLEASE READ THIS MANUAL CAREFULLY. IF THIS PRODUCT IS NOT USED CORRECTLY, UNEXPECTED INJURY CAN OCCUR TO USERS OR BYSTANDERS.

Keep this manual in a safe place so that it can be easily referred to during use of this product.

While all efforts have been made to ensure the accuracy of all information in this manual, PFU assumes no liability to any party for any damage caused by errors or omissions or by statements of any kind in this manual, its updates or supplements, whether such errors are omissions or statements resulting from negligence, accidents, or any other cause. PFU further assumes no liability arising from the application or use of any product or system described herein; nor any liability for incidental or consequential damages arising from the use of this manual. PFU disclaims all warranties regarding the information contained herein, whether expressed, implied, or statutory.

Warning Indications Used In This Manual



This indication alerts operators to an operation that, if not strictly observed, may result in severe injury or death.



This indication alerts operators to an operation that, if not strictly observed, may result in safety hazards to personnel or damage to equipment.

Symbols Used In This Manual

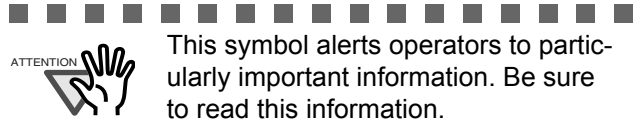

This symbol alerts operators to particularly important information. Be sure to read this information.

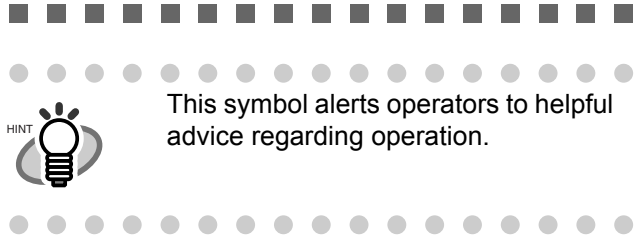

This symbol alerts operators to helpful advice regarding operation.



A TRIANGLE symbol indicates that special care and attention is required.

The drawing inside the triangle shows the specific caution.



A CIRCLE with a diagonal line inside shows action which users may not perform.

The drawing inside or under the circle shows the specific action that is not allowed.



Outline characters on a colored background show instructions users should follow.

It may also include the drawing that shows the specific instruction.

Warning Label



The glass surface inside the ADF becomes hot during the operation. Be careful not to touch the glass surface inside the ADF.

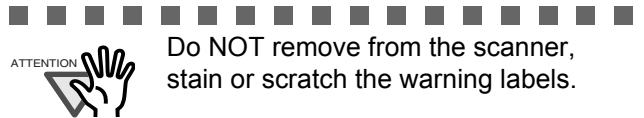

Do NOT remove from the scanner, stain or scratch the warning labels.

Screen Examples In This Manual

The screen examples in this manual are subject to change without notice in the interest of product improvement. If the actual displayed screen differs from the screen examples in this manual, operate by following the actual displayed screen while referring to the User's Manual of the scanner application you are using.

The screenshots in this manual were captured from FUJITSU TWAIN32 scanner driver, ScandAll 21 Image Capturing Utility Software,

About Maintenance

The user must not perform repairs on this scanner. Contact the store where you purchased the scanner or an authorized FUJITSU Image Scanner service provider to have repairs done on this product.

■ Safety Precautions



Do not damage the AC cable.



A damaged AC cable may cause fire or electric shock. Do not place heavy objects on AC cables, or pull, bend, twist, heat, damage or modify AC cables. Do not use damaged AC cables or power plugs, or install any cables or power plugs to loose wall sockets.

Use only specified AC cables and connector cables.



Use only specified AC cables and connector cables. Failure to use the correct cables might cause electric shock and/or equipment failure.

Use this scanner only at the indicated power voltage. Do not connect to multiple-power strips.



Use this scanner only at the indicated power voltage and current. Improper power voltage and current might cause fire or electric shock. Do not connect to multiple-power strips.

Do not touch the AC cable with wet hands.



Do not touch the power plug with wet hands. Doing so might cause electric shock.

Wipe any dust from the power plug.



Wipe off any dust from metal parts on the power plug or metal fittings with a soft, dry cloth. Accumulated dust might cause fire or electric shock.

Do not install the device in locations that has oil smoke, steam, humidity, and dust.



Do not install the scanner in locations subject to oil smoke, steam, humidity, and dust. Doing so might cause a fire or electric shock.

Turn the scanner OFF if it is damaged.



If the scanner is damaged for any reason, turn the scanner off and unplug the power cable. Contact the store where you purchased the scanner.

Do not put liquids inside the scanner.



Do not insert or drop metal objects in to the scanner. Do not scan wet documents or documents with paper clips or staples. Do not splash or allow the scanner to get wet.



If foreign objects (water, small metal objects, liquids, etc.) get inside the scanner, immediately turn off the scanner and disconnect the power plug from the power outlet. Then, contact the store where you bought the scanner or the Maintenance Service Center. Pay particular attention to this warning in households where there are small children.



Do not touch the inside of the scanner unless necessary.



Do not take apart or modify the scanner. The inside of the scanner contains high-voltage components. Touching these components might cause electric shock or fire.

Do not use the scanner if you smell a strange odor.



If you detect heat coming from the device or detect other problems such as smoke, strange smells or noises, immediately turn off the scanner and then disconnect its power plug. Make sure that any smoke coming from it has stopped, before contacting the store where you bought the scanner or an authorized FUJITSU scanner service provider.



Do not install the scanner on unstable surfaces.



Make sure that the scanner is installed on a flat, level surface and that none of its parts extend beyond the surface top, such as a desk or table. Do not install the scanner on unstable surfaces. Install the scanner on a level surface that is free of vibration to prevent it from falling.



Install the scanner on a strong surface that will support the weight of the scanner and other devices.

Do not block the ventilation ports.



Do not block the ventilation ports. Blocking the ventilation ports generates heat inside of scanner, which may result in fire or scanner failure.

Do not place heavy objects or climb on top of the scanner.



Do not place heavy objects on the scanner or use the scanner's surface top to perform other work. Improper installation might cause injuries and equipment failure.

Firmly insert the power plug.



Firmly insert the power plug as far it can go into the power outlet.

Avoid any contact when scanner is in use.



Avoid touching any scanner mechanism during scanning since this may cause injuries.

Do not use the scanner immediately after moving it from a cold place into a warm room.



Do not use the device immediately after moving it from a cold place into a warm room. Condensation may occur, which might lead to scanning errors. Let the device dry about one or two hours before you use it.

Before moving the scanner, disconnect the power plug from the power outlet.



Do not move the scanner with the power and interface cables connected as this can damage the cables, which can later cause fire, electric shock as well as injury. Before moving the scanner, be sure to disconnect the power plug from the power outlet, and all other data cables. Make sure that the floor is free of any obstructions.

Protect the scanner from static electricity.



Install the scanner away from strong magnetic fields and other sources of electronic noise. Also, protect the scanner against any static electricity, which can cause the scanner to malfunction.

Do not use aerosol sprays near the scanner.



Do not use aerosol sprays to clean the scanner. Aerosol sprays can blow dirt and dust inside the scanner, resulting in scanner failure or malfunction.

Disconnect the power plug from the power outlet when the scanner is not used for a long period of time.



When the scanner is not going to be used for a long period of time, be sure to disconnect the power plug from the power outlet for safety.

Do not install the scanner in the direct sunlight.



Do not install the scanner under direct sunlight or near heating apparatus. Doing so might cause excessive heat to build up inside the scanner, which can cause scanner trouble or even fire. Install the scanner in a well-ventilated location.

Before moving the scanner, make sure the shipping lock is locked.



When moving the scanner, be sure to lock the shipping lock in order to prevent damages to the scanner.

Be aware of the pick spring.



When you perform cleaning, make sure that the inside of the scanner is free of any foreign object, and be careful not to get your hand or the cloth caught on the pick spring (metal part) as a deformed pick spring (metal part) may cause injury.

Chapter 1 PREPARING THE SCANNER

1.1 Checking the Contents of the Scanner Package

When you open the scanner package, please handle the main unit and its attachments carefully. Make sure it contains all the parts listed in the package contents list that is included in the package box. If any parts are missing or defective, contact your sales representative. Handle the scanner and accessories with care.

1.2 Names and Functions of Parts

This section describes the scanner parts and their functions.

■ Front

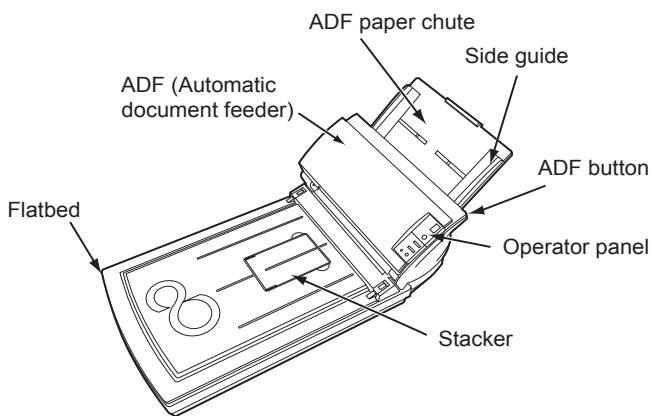

■ Inside

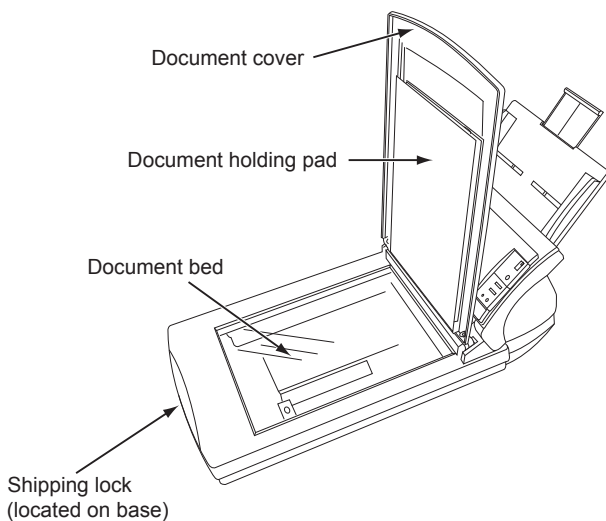

■ Rear

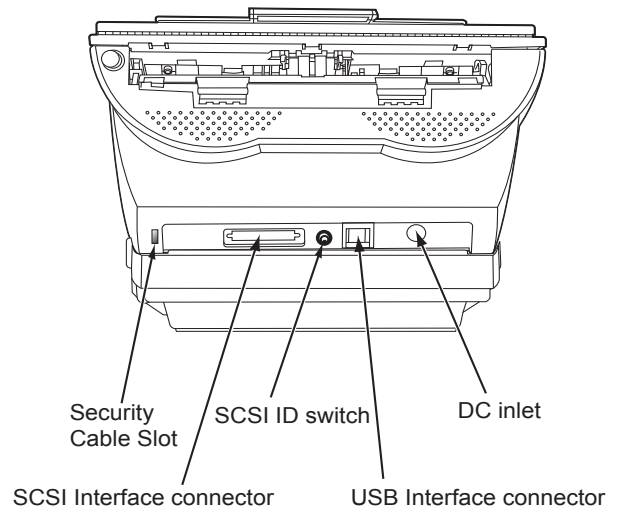

■ Removable Parts

Parts that can be removed from the scanner are displayed below.

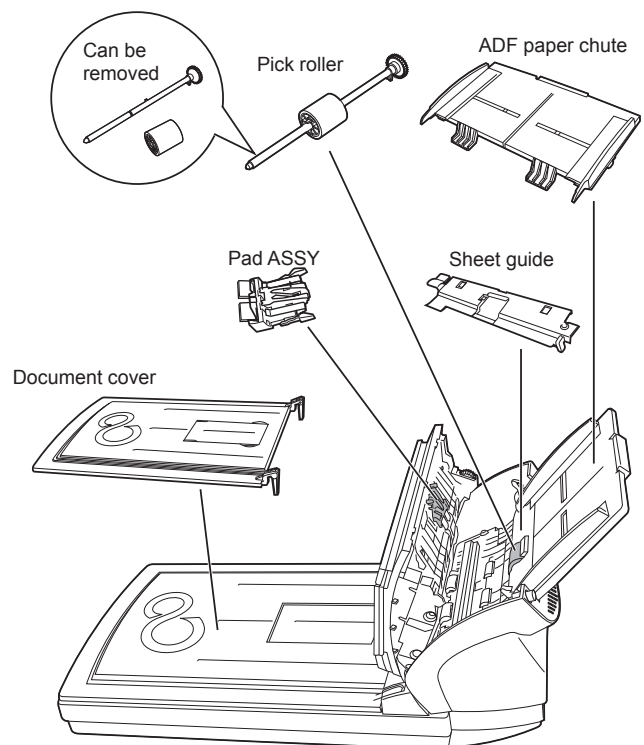

1.3 Operator Panel

The operator panel is located on the right side of the scanner. This panel comprises of a Function Number display, four buttons and a LED.

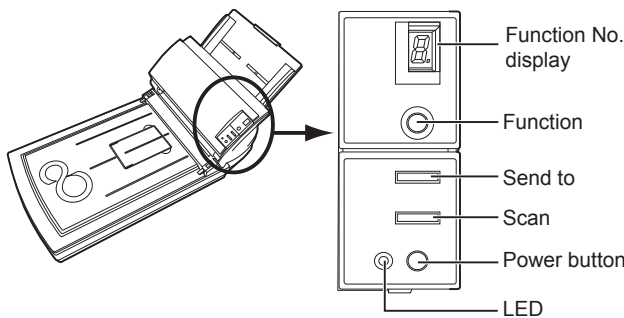

Name		Function
Function Number display		Indicates the function Number and error status.
Buttons	Function	Changes the Function activated by the Send to button (*).
	Send to	Launches the linked application software (*).
	Scan	
Power button		Turns the scanner ON and OFF.
LED	-	Lights when the scanner is turned ON.

*) About the settings on the launcher, refer to FUJITSU TWAIN32 scanner driver help and the "fi-4220C2 Operator's Guide" in the Setup CD-ROM.

■ Indications on the Function Number Display

- **8**
Blinks only one time upon turning on the scanner.
- **P**
Indicates that the scanner has been turned ON and is being initialized.
- **0**
Indicates that initialization will soon end.
- **1**
Indicates that initialization has ended successfully.
The scanner is now in "Ready Status".
- **U**
Indicates that a temporary error occurred when documents were being scanned. A number appearing in alternation following the U (i.e., 1 or 2, etc.) refers to the type of error. To return the scanner to the ready status ("1"), press "Scan" or "Send to" button.
- **E**
Indicates that a device (hardware) alarm has occurred during scanning of documents. "E" and the alarm Number (2 to 9, c and d) will appear alternately.
To return the scanner to the ready status ("1"), press "Scan" or "Send to" button.
If this alarm occurs, turn the power off and on again. If the alarm continues after turning the power on again, contact your service engineer.

Chapter 2 INSTALLATION OF THE SCANNER

2.1 Installing the Scanner

1. Place the scanner at its installation site.

For details on the scanner's dimensions and required installation space, refer to "fi4220C Operator's Guide" "7.2 Installation Specifications" in the Setup CD-ROM.

2. Unlock the Shipping lock.

The carrier unit inside the scanner is fixed in place by the shipping lock to prevent the scanner from becoming damaged during transportation from the factory.

After transporting and placing the scanner, tilt the scanner (approx. 30 degrees) and release the Shipping lock.

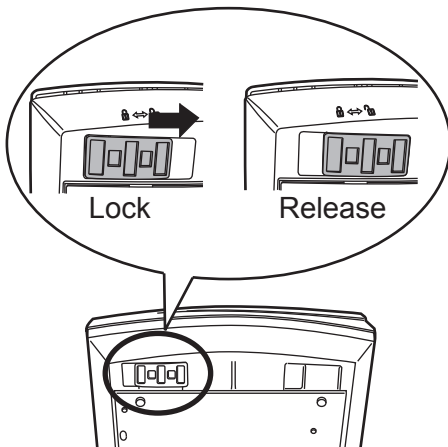
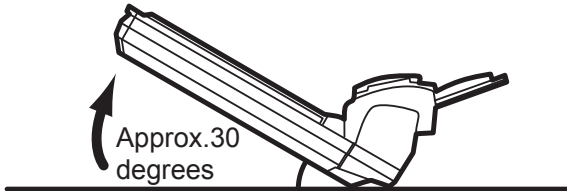

3. Attach the ADF paper chute.

Hold the ADF paper chute and insert its tabs into the corresponding slots in the scanner as shown in the figure below.

The Side guides of the ADF paper chute have to face up.

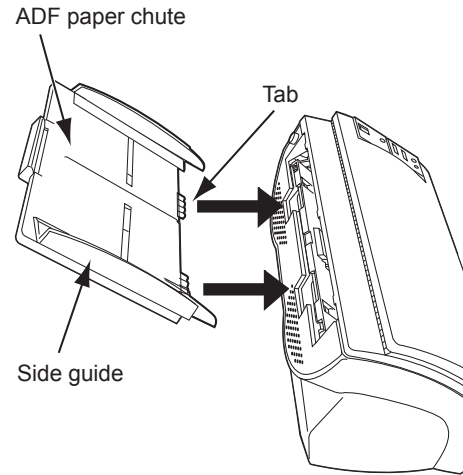

4. Connect the AC adapter.



Use only the AC adapter provided by the manufacturer.

- 1) Connect the AC cable to the AC adapter.

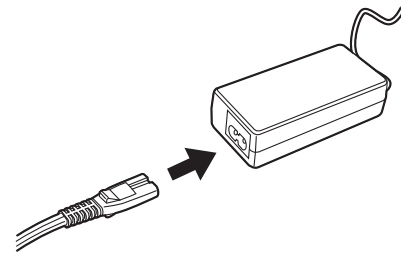

- 2) Connect the AC adapter connector to the scanner's DC inlet.

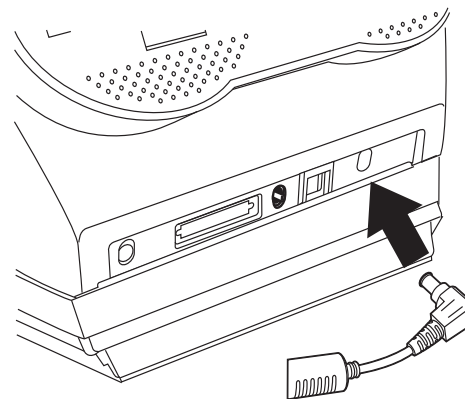

- 3) Plug the AC cable into the outlet.



The Function Number Display and the LED may flash for an instant when plugging the AC cable into the scanner.

2.2 Connecting the Scanner to Your PC

When running Windows 95 or Windows NT 4.0, connect the SCSI interface cable. When running Windows 98, Windows Me, Windows 2000, or Windows XP, connect either the USB interface cable or the SCSI interface cable.



Connect only one of the USB or SCSI interface cables. Windows 95 and Windows NT 4.0 do not support USB interface.



■ Connecting the USB Interface Cable

1. Connect the USB interface cable to the USB interface connector.

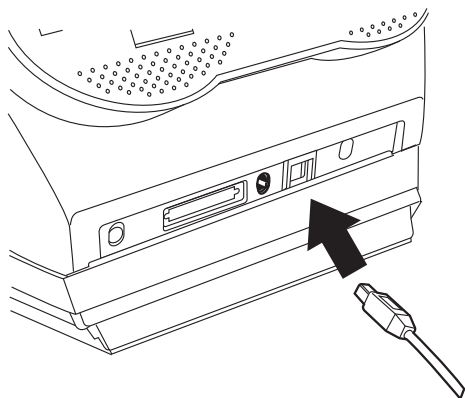

2. Connect the other end of the USB interface cable to the PC.



- Be sure to use the USB cable which comes as an accessory with this scanner. Correct operation with commercially available cables is not guaranteed.
- When connecting to an USB hub, use the first stage USB hub that is closest to the computer. If you use the second or later hub stages, the scanner may not operate correctly.
- This scanner is provided with two interfaces: Ultra SCSI and USB 1.1. On this scanner, each of the SCSI and USB interface is controlled not to be used simultaneously. Scanner can be only connected to either USB or SCSI interface.



■ Connecting the SCSI Interface Cable

When using the scanner with SCSI interface, a commercially available SCSI interface cable and SCSI card must be purchased.

- SCSI interface cable:
Use a connector which complies with Ultra SCSI. A 50 Pin Contact Shielded High-Density SCSI Device Connector is used.
- SCSI card:
Find the recommended SCSI card information in the Fujitsu web site (FAQ).
<http://imagescanner.fujitsu.com/>



- When connecting the SCSI interface cable, turn the scanner off. Be sure to first connect the SCSI interface cable and, then turn on the power of the scanner and the personal computer.
- In a SCSI daisy chain formation, connect the scanner so that it is the terminated device.



1. Insert the SCSI interface cable into the interface connector until both sides click.

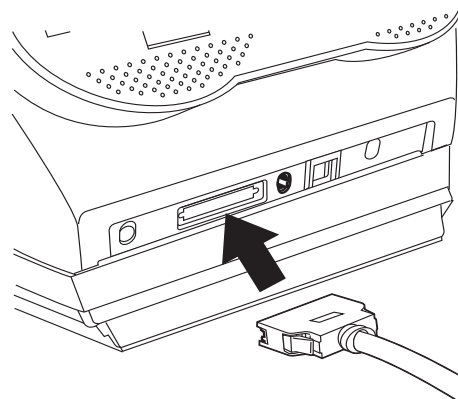

2. Connect the other end of the cable to the personal computer.



Be careful not to bend the pins of the SCSI cable when connecting to the scanner .





The factory default setting for SCSI ID is "ID 5". If the SCSI ID of another SCSI device is set to the same ID, either change the scanner's SCSI ID or SCSI ID of the other SCSI device. Set the device address using the SCSI ID switch on the back of the image scanner.

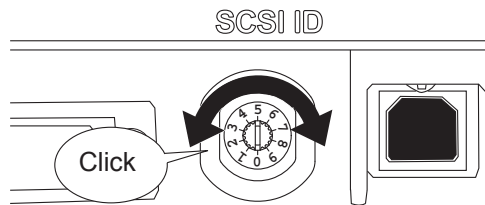

This scanner supports two interfaces: Ultra SCSI and USB 2.0/1.1. On this scanner, each of the SCSI and USB interface can not be used simultaneously. Scanner can only connect to the USB or SCSI interface.

2.3 Installing the Scanner Application

Both the scanner driver and image capturing application software (called "application" hereafter) must be installed on your PC.

Two types of drivers for scanner, FUJITSU TWAIN 32 Scanner Driver and FUJITSU ISIS Scanner Driver, as well as two software applications, ScandAll 21 and QuickScan Pro™, are provided with this product. The following sections describe how to install each driver and application.

For FUJITSU TWAIN32 Scanner Driver

■ Preparation

Confirm the following items before installing the application.

- Remove the Setup CD-ROM from its package, but do not insert the Setup CD-ROM into the CD driver yet.
- Confirm that the scanner is correctly connected to your PC.



For details on how to connect the scanner, refer to "2.2 Connecting the Scanner to Your PC" on page 4.

- Uninstall any older versions of FUJITSU TWAIN 32 driver if already installed.



Uninstall [Scanner Utility for Microsoft Windows] from [Add/Remove Programs] of the control panel.

- There are two types of FUJITSU TWAIN 32: One of the following driver software will be installed automatically according to your Operating System (OS).

For Windows 98, Windows Me, Windows 2000, and Windows XP:

FUJITSU TWAIN32 V9

For Windows 95, Windows NT 4.0:

FUJITSU TWAIN32 V8

ASPI Manager V4.01 or later is required (generally comes with SCSI board products).

■ Installing the FUJITSU TWAIN32 Scanner Driver



Windows XP screenshots are used in this section as examples. The windows and operations may slightly vary depending on your OS.

1. Press the power button to turn on the scanner.
2. Turn on your PC and log on to Windows.



When using Windows NT 4.0, Windows 2000 or Windows XP, log on as a user with "Administrator" privileges (privileges of the administrator of your PC).

- If the scanner is automatically detected, [Found New Hardware Wizard] or [Add/Remove Hardware Wizard] dialog box will appear. Click [Cancel] to close the Wizard window.

Windows XP screenshots are used in this section.



HINT  The windows and operations may vary slightly depending on your OS.

- Insert the Setup CD-ROM into the CD drive.
⇒ <SETUP DISK START UP SCREEN> appears.

ATTENTION  This screen may not appear when the "Autoplay" setting of your PC is OFF. In this case, run "Install.exe" in this CD-ROM directly from the "Explorer" or "My Computer".

- Click [INSTALL PRODUCTS].

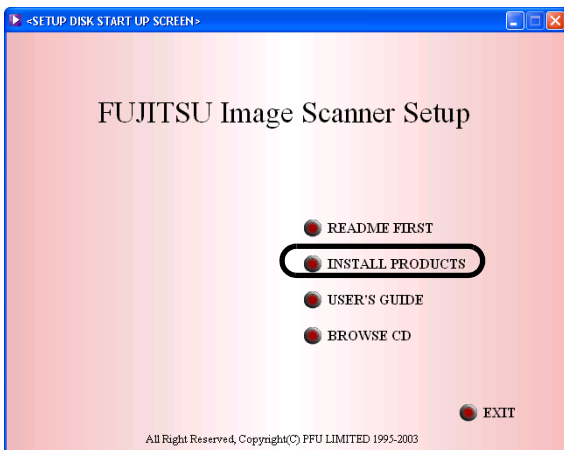

- Click [TWAIN Driver] on the window below.



- Error Recovery Guide Installation window appears.
Error Recovery Guide is a software that displays troubleshooting information on screen when any scanner error occurs. Although this software's installation is highly recommended, the performance of the scanner would not be affected if not installed.

ATTENTION  When you select [Yes] for installing the Error Recovery Guide, [Choose Setup Language] window appears. Select a language and follow the instructions on the window. Error Recovery Guide will automatically continue finishing its installation. Please wait until the installation of TWAIN driver automatically starts.

- Select a language used for installation on [Choose Setup Language] window and click [OK].

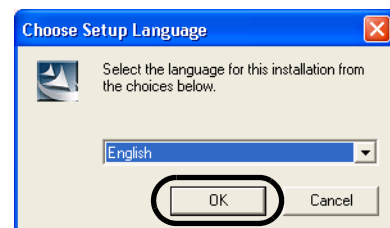

- Follow the instructions on the window to install the application.

10. When the [InstallShield Wizard Complete] window appears, click [Finish].

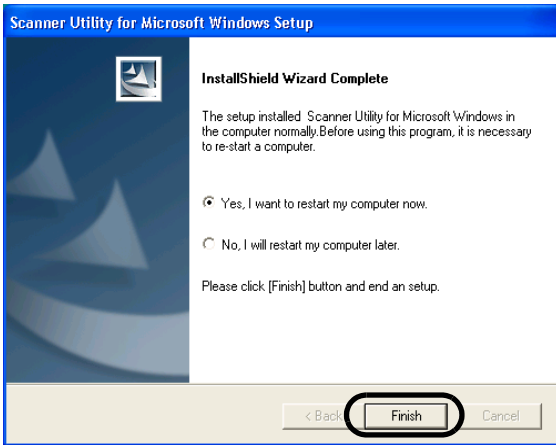

Your computer will be restarted and the scanner will be detected. Do not remove the Setup CD-ROM from the CD drive until your PC has completely restarted.



Depending on the OS, these operations may be necessary.

For Windows 98:

When a request for inserting the CD-ROM for Windows 98 appears, insert it into the CD drive and click the [OK] button.

For Windows 2000:

When [Digital Signature not Found] appears, click [Yes].

For Windows XP:

1. When [Found New Hardware Wizard] appears, confirm that the Setup CD-ROM is set in the CD drive, then click the [Next] button.
2. When any alarm is displayed on [Hardware Installation] window, click the [Continue Anyway] button.
3. Click the [Finish] button.



Installation of the scanner driver is completed.



To confirm whether the installation was successful, perform a scanning operation with an application that complies with the TWAIN regulations such as ScandAll 21.



■ Installing ScandAll 21

"Scandall 21" is an image capturing software that complies with the TWAIN standard. The FUJITSU TWAIN 32 scanner driver enables you to capture images with a FUJITSU image scanner fi-series product



When using Windows NT 4.0, Windows 2000 or Windows XP, log on as a user with "Administrator" privileges (privileges of the administrator of your PC).



1. Insert the Setup CD-ROM into the CD drive.
⇒ <SETUP DISK START UP SCREEN> appears.
2. Click [INSTALL PRODUCTS].

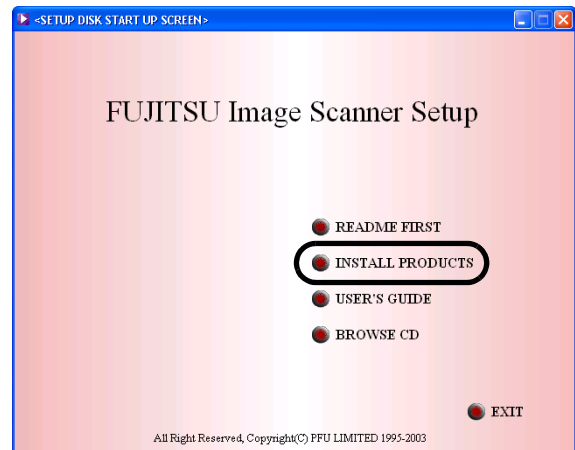

3. Click [ScandAll 21] on the window below.



4. Select a language used for installation on [Choose Setup Language] window and click [OK].



5. Install the application following the instructions on the window.
6. When the [InstallShield Wizard Complete] window appears, click [Finish]

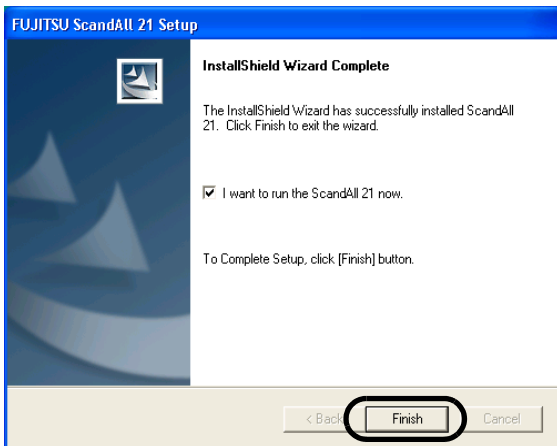

For finishing the installation, it may be necessary to restart your computer. Follow the instructions on the window.

■ Confirming Installation

1. Set documents on the ADF paper chute.
For details on how to set documents, refer to the "1.2 Loading Documents on the ADF for Scanning" in the fi-4220C2 Operator's Guide provided in the CD-ROM.
2. Start ScandAll21
Select [Start] - [Programs] - [Scanner Utility for Microsoft Windows] - [ScandAll 21].
3. Specify the scanner (that you will use)

Select [Select Source...] from the [Scan] menu of ScandAll 21.

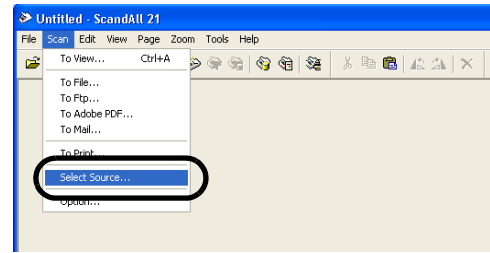

4. Select "FUJITSU fi-4220C2dj" or "FUJITSU TWAIN32" on the dialog box.

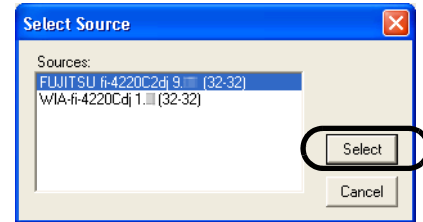

□For Windows 98, Windows Me, Windows 2000, Windows XP:

[FUJITSU fi-4220C2dj]

□For Windows 95, Windows NT 4.0:

[FUJITSU TWAIN32]

5. Select [To View...] from the [Scan] menu.
6. Set scanning resolution, document size, etc. on the [TWAIN driver] window (for setting details of scanning) and click the [Scan] button.

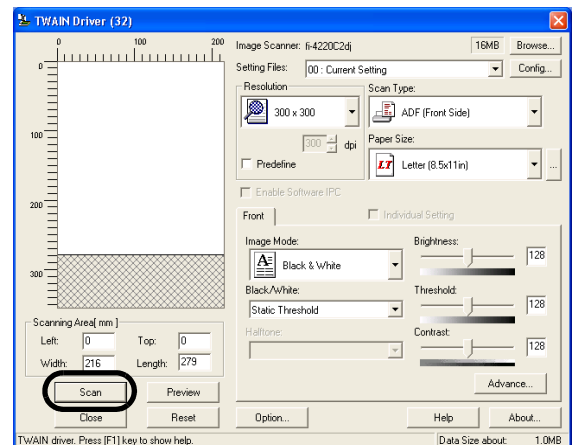

For details on [TWAIN driver], refer to the "FUJITSU TWAIN32 Scanner Driver User's Guide" provided on the Setup CD-ROM.

- Documents are scanned, and the scanned images are displayed on the [ScandAll 21] window.

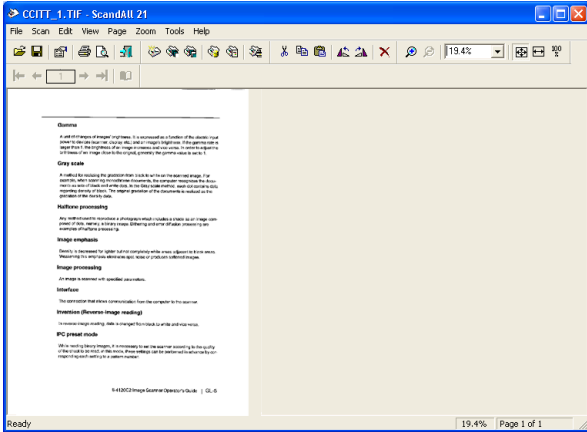

If the scanning completes without any trouble, the installation performed successfully.

For details on various types of scanning, refer to the "fi-4220C2 Operator's Guide" on the Setup CD-ROM.

For FUJITSU ISIS Scanner Driver

■ Preparation

Confirm the following items before installing the driver application.

- Remove the Setup CD-ROM from its package, but do not insert the Setup CD-ROM into the CD driver yet.
- Confirm that the scanner is correctly connected to your PC.

 For details on how to connect the scanner, refer to "2.2 Connecting the Scanner to Your PC" on page 4.

■ Installing the FUJITSU ISIS Scanner Driver

 Windows XP screenshots are used in this section as examples. The windows and operations may vary slightly depending on your OS.

- Press the power button to turn ON the scanner.

- Turn your PC on and log on to Windows.

 When using Windows NT 4.0, Windows 2000 or Windows XP, log on as a user with "Administrator" privileges (privileges of the administrator of your PC).

- If the scanner is automatically detected, [Found New Hardware Wizard] or [Add/Remove Hardware Wizard] dialog box will appear. Click [Cancel] to close the Wizard window.



 The windows and operations may vary slightly depending on your OS.

- Insert the "Setup CD-ROM" into the CD drive.
⇒ <SETUP DISK START UP SCREEN> appears.

 This screen may not appear when the "Autoplay" setting of your PC is OFF. In this case, run "Install.exe" in this CD-ROM directly from the "Explorer" or "My Computer".

5. Click [INSTALL PRODUCTS].

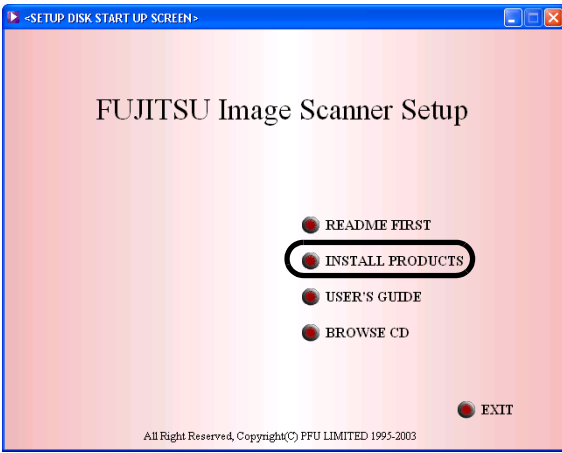

6. Click [ISIS Driver] on the window below.



7. Error Recovery Guide Installation window appears.
 Error Recovery Guide is a software that displays troubleshooting information on screen if any scanner error occurs. Although this software's installation is highly recommended, the performance of the scanner would not be affected if not installed.



When you select [Yes] for installing Error Recovery Guide, the [Choose Setup Language] window appears. Select a language and follow the instructions on the window. The Error Recovery Guide will automatically continue finishing its installation. Please wait until the installation of TWAIN driver automatically starts.

8. Select a language used for installation on [Choose Setup Language] window and click [OK].



9. Follow the instructions on the window to install the application.
10. When the [InstallShield Wizard Complete] window appears, click [Finish].
11. Your computer will be restarted and the scanner will be detected. Do not remove the Setup CD-ROM from the CD drive until your PC has completely restarted



Depending on the OS, these operations may be necessary.

For Windows 98:

When a request for inserting the CD-ROM for Windows 98 appears, insert it into the CD drive and click the [OK] button.

For Windows 2000:

When [Digital Signature not Found] appears, click [Yes].

For Windows XP:

1. When [Found New Hardware Wizard] appears, confirm that the Setup CD-ROM is set in the CD drive, then click the [Next] button.
2. When any alarm is displayed on [Hardware Installation] window, click the [Continue Anyway] button.
3. Click the [Finish] button.



Now the installation of the scanner driver is completed.

■ Installing QuickScan Pro™

"QuickScan Pro™" is an image capturing software that complies with the ISIS standard. The FUJITSU ISIS scanner driver enables you to capture images with a FUJITSU image scanner fi-series product



When using Windows NT 4.0, Windows 2000 or Windows XP, log on as a user with "Administrator" privileges (privileges of the administrator of your PC).

1. Insert the Setup CD-ROM into a CD drive.
⇒ <SETUP DISK STARTUP SCREEN> appears.
2. Click [INSTALL PRODUCTS].

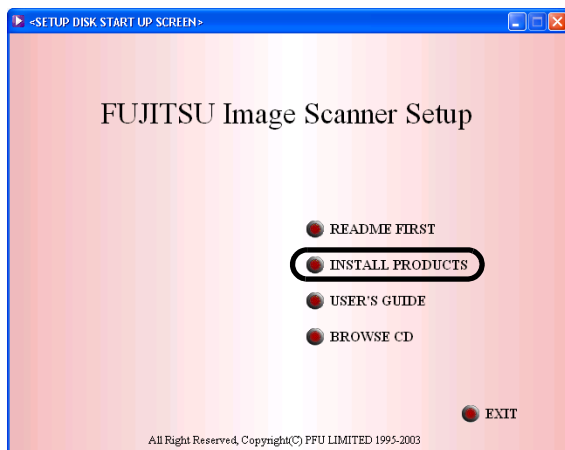

3. Click [QuickScan PRO (Trial)] on the window below.



4. Continue to install the application following the instructions on the window.

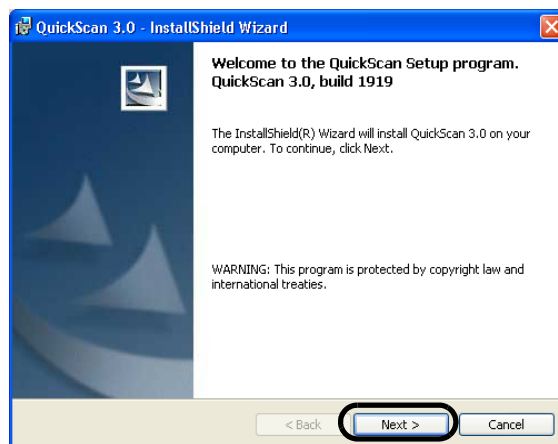

5. Enter the required information, then click [Next >] button.

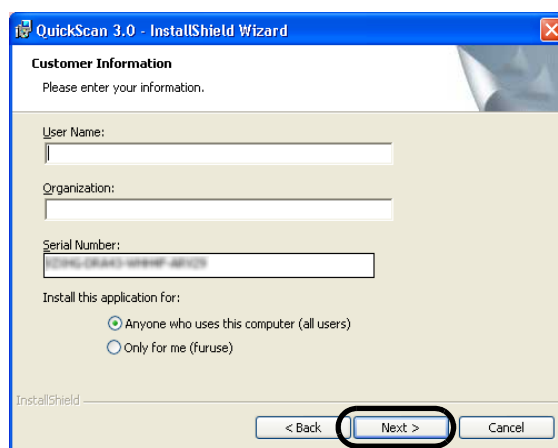

"QuickScan Pro™" included in the Setup CD-ROM is an evaluation version. For further use after the expiration of its evaluation period of up to 30 launches, it is necessary to purchase a fully functional version of QuickScan Pro™. (When you install the evaluation version, do not change the Serial Number already displayed.)

6. Install the application following the instructions on the window.

■ Confirming Installation

1. Load the documents on to the scanner.
For details on loading documents, refer to "1.2 Loading Documents on the ADF for Scanning" in the fi-4220C2 Operator's Guide on the Setup CD-ROM.

2. Start QuickScan Pro™.

From the [Start] menu select [Programs]-[QuickScan]-[QuickScan].

3. Select [Select Scanner...] from [Scan] menu in QuickScan Pro™.

And select fi-4220C2 from the list of [Scanner:], and then click the [OK] button.

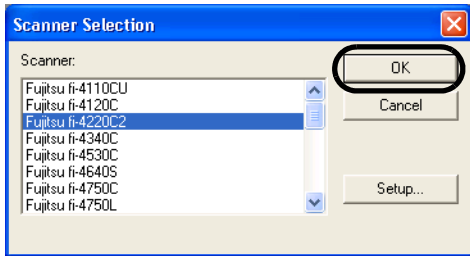

4. Select [Preview Settings...] from the [Scan] menu. Set the scan resolution, paper size and other scanning requirements, and then click [OK].

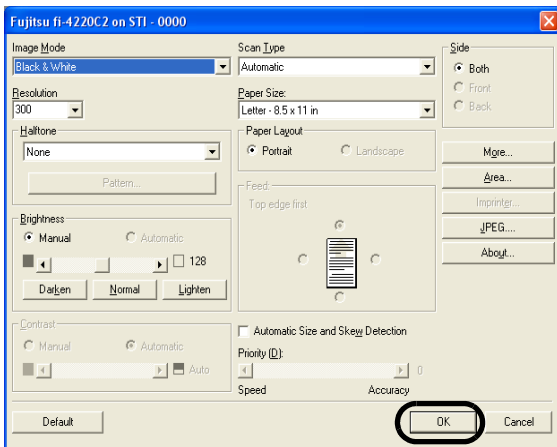

5. Select [Preview Scan] from the [Scan] menu. And then the document is scanned.

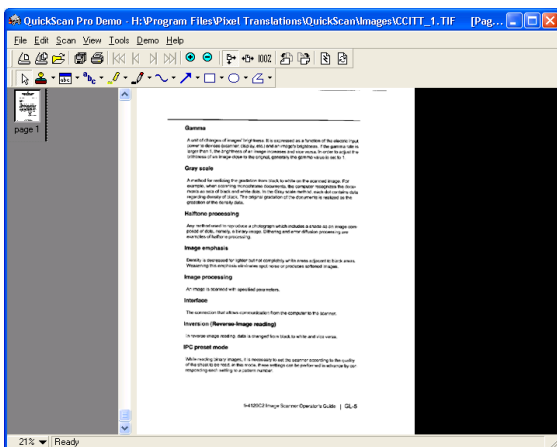

If the scanning completes without any trouble, the installation performed successfully.

HINT  Refer to "QuickScan Overview" or "QuickScan Help" for information about QuickScan Pro™ functions and operations. On the [Start] menu, point to [Programs]-[QuickScan] and click the file.

Error Recovery Guide

If you did not install together the Error Recovery Guide with the driver, please proceed with the procedures given below for installing it.

Error Recovery Guide is a software that displays troubleshooting information on screen if any scanner error occurs.

1. Insert the Setup CD-ROM in your CD drive. The <SETUP DISK STARTUP SCREEN> will be displayed.
2. Click [Install Products].

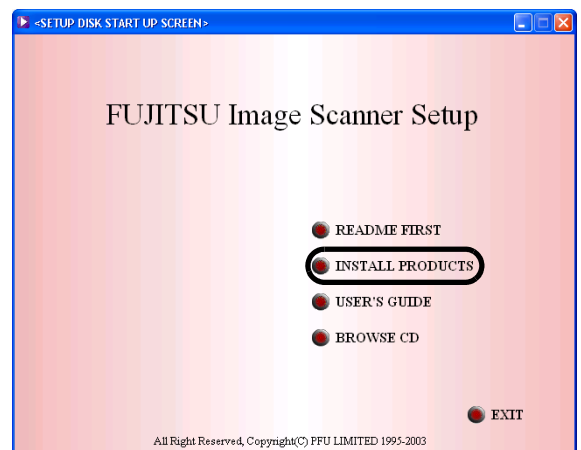

3. Click [Error Recovery Guide] on the next screen.



- Select a language to use for the installation in the <Choose Setup Language> window and click [OK].



- Install the application following the instructions in the window.
- When the [InstallShield Wizard Complete] screen displays, click [Finish].

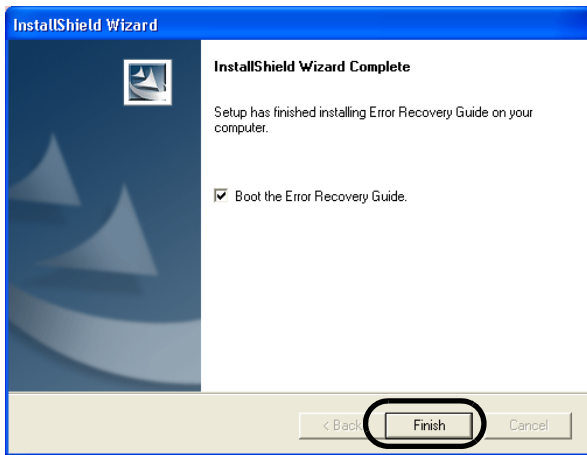

Image Processing Software Option (Trial)

To install the image processing software option (trial version), please refer to the "Image Processing Software Option User's Guide".

Adobe® Acrobat®

Install Adobe Acrobat from the "Adobe Acrobat 6.0 CD-ROM" provided with this scanner.



Adobe Acrobat 6.0 Standard is not supported by Microsoft Windows 95, Microsoft Windows 98 (Except for Microsoft Windows 98 Second Edition.), Microsoft Windows NT4.0, Microsoft Windows Me.

To use Acrobat 6.0 with FUJITSU scanners, FUJITSU TWAIN32 Scanner Driver Version 8.11.32 or later, or Version 9.11.32 or later is required.



Adobe Acrobat is required for displaying the manuals stored in the CD-ROM.

* Installation of Adobe Acrobat 6.0 is not necessary if it has already been installed in your PC.

- Insert the Adobe Acrobat 6.0 CD-ROM into your CD-ROM drive.
The CD-ROM is automatically recognized and the "Adobe Acrobat6.0 AutoPlay" screen will be displayed.



The <Adobe Acrobat 6.0 AutoPlay> screen may not appear when the "Autoplay" setting of your PC is turned off. In this case, run "AutoPlay.exe" on the CD-ROM directly from the explorer or "My Computer".

- Click the [Install] button when the screen below displays. Then click the [Install Acrobat 6.0 Standard] button.



- Click the [Next] button when the following screen is displayed.



4. After the setup screen displays, proceed with the instructions on the screen to perform the installation.



For more detailed information about Adobe Acrobat 6.0 installation, please read the "Read me" instructions on the screen of operation 2. For the Adobe Acrobat 6.0 operations, please refer to the "Adobe Acrobat 6.0 help".



Support and User registration for Adobe products
Refer to the technical support information stored in the [Customer Support] folder on Adobe Acrobat 6.0 Standard CD-ROM. (Note that free person-to-person support is not available for this is bundled product.)



Appendix 1 TROUBLESHOOTING

■ Troubleshooting checklist

Symptom	Check this item	Remedy
Scanner does not turn on.	Have you pressed the power button on?	Push the power button in to turn the scanner.
	Are the AC cable and AC adapter properly connected to the scanner?	Correctly connect the AC cable and the AC adapter. Disconnect the AC cable and the AC adapter from the scanner, then connect them again. If this does not restore the power supply, contact the store where you purchased the scanner or an authorized FUJITSU scanner service provider.
	Are you using the correct AC cable and AC adapter supplied with the scanner from the manufacture?	You must use the AC adapter and cable supplied with your scanner by the manufacture. Please get the correct AC adapter and cable to connect to your scanner.
Scanning does not commence.	Are the documents loaded properly on to the ADF paper chute?	Realign and reload the documents on to ADF paper chute.
	Is the ADF closed completely?	Close the ADF completely.
	Is the USB cable or SCSI cable connected securely?	Connect the cable. (When a USB hub is used, check the hub's power supply.)
	When using a SCSI interface, Is SCSI ID set correctly?	Use the SCSI ID switch at the rear of the scanner to set the SCSI ID.
	Does the Function Number display indicates an alarm or an error?	When the Function Number display indicates an alarm or an error, refer to the "Chapter 5. TROUBLESHOOTING" in the fi-4220C2 Operator's Guide for removing the alarm or the error.
	The alarm status remain displayed even after the scanner has been turned off and on again?	Turn off and on the power button. If this does not eliminate the alarm status, contact the store where you purchased the scanner or an authorized FUJITSU scanner service provider.
Vertical lines appear in the printed image.	Are the glass dirty?	Clean the glass as instructed in the Operator's Guide "3. Daily Care".
The printed scanned image shifts or is distorted.	Are the documents loaded correctly?	Load the documents correctly.
Quality of scanned image is unsatisfactory.	Are the glass clean?	Clean dirty locations.

Symptom	Check this item	Remedy
Paper frequently multi feeds	Have the document requirements of the fi-4220C2 Operator's Guide's "Document Quality" and the "Multi feed Detection Conditions" of chapter 6 been satisfied?	Use document conditions that meet the "Document Quality" and the "Multi feed Detection Conditions" in chapter 6 of the fi-4220C2 Operator's Guide.
	Are the documents placed properly in the ADF paper chute?	Fan the documents before scanning. Correctly align the document stack and load them on the ADF paper chute. Refer to "2.1 Installing the Scanner" on page 3 for details.
	Is the stack of document thicker than 5 mm?	Reduce the number of sheets of the stack to a thickness of 5 mm or less.
	Is the Pad ASSY dirty?	Clean the Pad ASSY. Refer to Operator's Guide in "3.3. Cleaning the ADF".
	Is the Pad ASSY worn out?	Replace the Pad ASSY. Refer to Operator's Guide in "4.2. Replacing the Pad ASSY".
Paper does not feed (pick error occurs frequently, or document stops midway).	Have the document requirements of the fi-4220C2 Operator's Guide's "Document Quality" and the "Multi feed Detection Conditions" of chapter 6 been satisfied?	Use document conditions that meet the "Document Quality" and the "Multi feed Detection Conditions" in the chapter 6 of the fi-4220C2 Operator's Guide.
	Is the Pick roller dirty?	Clean the Pick roller. Refer to Operator's Guide in "3.3. Cleaning the ADF".
	Is the Pick roller worn out?	Change the Pick roller. Refer to Operator's Guide in "4.3. Replacing the Pick Roller".
	Is there any dirt or dust in the document feed path?	Remove any dirt or dust from the document feed path.
Are the scanned images elongated?	Are the Feed rollers dirty?	Clean the Feed rollers. Refer to Operator's Guide in "3.3. Cleaning the ADF".
	Have you adjusted the scan scale?	For Windows 98, Windows Me, Windows 2000, WindowsXP, select "Scanners and Cameras" in the control panel, then click the [Device Set] tab to adjust scale. For Windows 95, Windows NT 4.0, right click the Scanner Control Center in the task tray, select [Options] and adjust the scan scale.
Is there a shadow on the leading edge of the scanned image?	Are the Feed rollers dirty?	Clean the Feed rollers. Refer to Operator's Guide in "3.3. Cleaning the ADF".
	Adjust the offset.	For Windows 98, Windows Me, Windows 2000, WindowsXP, adjust the [Sub-scan Setting] on [Scanners and Cameras] in the control panel. For Windows 95, Windows NT 4.0, right click the Scanner Control Center, select [Options]-[Sub-scan Setting] and adjust the offset.

■ Temporary error

Indication	Meaning
U0	Shipping lock error
U1	Paper feed error
U2	Multi feed error
U4	The ADF cover is opened.

To troubleshoot the indicated errors above:

- "U0" error
 - Confirm that the shipping lock is released.
- "U1" error
 - Remove all jammed documents.
 - Confirm that the documents meet the paper conditions for scanning.
 - Refer to fi-4220C2 Operator's Guide "5. Troubleshooting" on the Setup CD-ROM.
- "U2" error
 - Remove all jammed documents.
 - Confirm that the documents are within the required paper preconditions for scanning.
 - Refer to fi-4220C2 Operator's Guide "6.2 Document Quality" on the Setup CD-ROM.
- "U4" error
 - Close the ADF cover completely. For the details, refer to "5 TROUBLESHOOTING" in the "fi-4220C2 Operator's Guide" on the Setup CD-ROM.

■ Device alarm (Non-Temporary error)

Indication	Meaning
E0	Flatbed motor malfunction.
E1	Trouble in the optical system (Flatbed).
E2	Trouble in the optical system (front).
E3	Trouble in the optical system (back).
E4	The motor's fuse has blown out.
E6	Trouble in the operator panel.
E7	Trouble occurred in the EEPROM.
E8	The SCSI interface fuse has blown out.
E9	An error in the image memory.
Ec	An alarm in the memory.
Ed	Trouble with the SCSI interface controller.
EF	Trouble with the background switching mechanism.

When you encounter any alarm on the display, turn the scanner off and on. If the alarm is still displayed on the Function Number display, contact the store where you purchased the scanner or an authorized FUJITSU scanner service provider.

Appendix 2 DAILY CARE



- The glass surface inside the ADF becomes hot during the operation. Before you clean inside the scanner, turn off its power and unplug the AC adapter from the outlet. Wait for at least 15 minutes.
- Do not turn off the scanner when you clean the Feed rollers.
- When you perform cleaning, make sure that the inside of the scanner is free of any foreign object, and be careful not to get your hand or the cloth caught on the pick spring (metal part) as a deformed pick spring (metal part) may cause injury.

■ Cleaning Materials

Cleaning Materials	Parts Number	Remarks
Cleaner F1 (or isopropyl alcohol)	CA99501-0013	1 bottle Moisten the cloth with this fluid and wipe the scanner clean. (*)
Lint-free dry cloth	Commercially available one	

* For details about cleaning materials, contact the FUJITSU scanner dealer where you purchased the scanner.

■ Cleaning Method

The ADF must be cleaned with a lint-free cloth moistened with the Cleaner F1.

■ Parts to Clean and When

Part to clean	Standard Cleaning Cycle
Pad ASSY	Clean these parts after every 1,000 scans.
Pick roller	
Feed rollers	
Plastic rollers	
Glass	



The scanner must be cleaned frequently if you scan any of the following type of paper sheets:

- Documents of coated paper
- Documents that are almost completely covered with printed text or graphics
- Chemically treated documents such as carbonless paper
- Documents containing a large amount of calcium carbonate
- Handwritten documents

For details on the cleaning the ADF, refer to "3.3 Cleaning the ADF" in fi-4220C2 Operator's Guide on the Setup CD-ROM".

Appendix 3 REPLACING CONSUMABLES



The glass surface inside the ADF becomes hot during the operation. Before replacing the consumables, turn its power off and unplug the AC adapter from the outlet. Wait at least 15 minutes.



■ Consumables and Replacement Cycles

Below are specifications of consumable items and their recommended replacement cycles.

Description	Parts Number	Standard Replacement Cycle
Pad ASSY	PA03289-0111	After 50,000 scans or one year
Pick roller	PA03289-0001	After 100,000 sheets or one year

To purchase consumables, contact the store where you purchased the scanner or an authorized FUJITSU scanner service provider.

The replacement cycles above are rough guidelines when using A4 or Letter woodfree or wood containing paper 64 g/m² (17 lb). This cycle varies according to the type of paper and how frequently the scanner is used and cleaned.



Use only the specified consumables.
Do not use other consumables.



The illustration below demonstrates the locations of the replacement parts. Refer to "Chapter 4 Replacing Consumables" fi-4220C2 Operator's Guide on the Setup CD-ROM.

■ Replacing the Pad ASSY

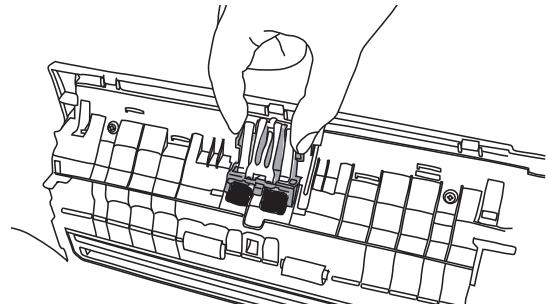

■ Replacing the Pick Roller

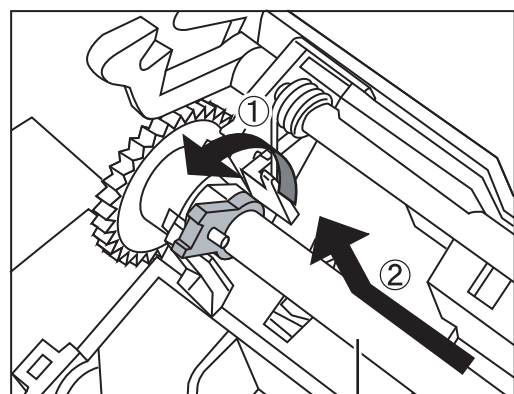
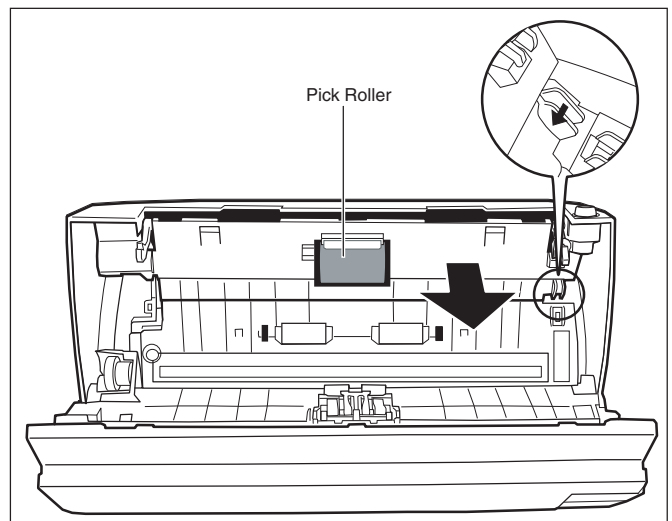

Pick Roller's Shaft

fi-4220C2 Image Scanner Getting Started

P3PC-E937-02EN

Date of issuance: October, 2009

Issuance responsibility: PFU LIMITED

- Copying of the contents of this manual in whole or in part and copying of the scanner application is forbidden under the copyright law.
- The contents of this manual are subject to change without notice.
- PFU LIMITED. is not liable whatsoever for any damages resulting from use of this scanner and procedures described in this manual, profit due to defects, and any claims by a third party.