

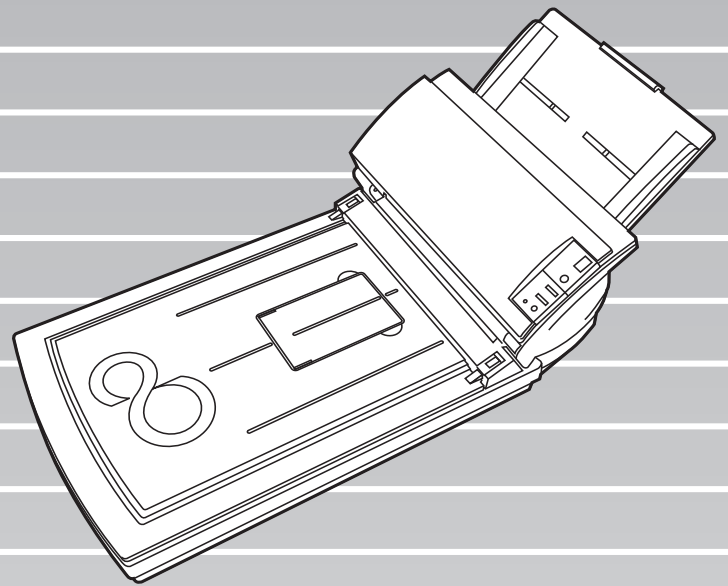

P3PC-E927-02EN

fi-4220C2 Image Scanner

Operator's Guide



CONTENTS



INTRODUCTION.....	v
■ Regulatory Information	v
■ Note, Liability	viii
■ Safety Precautions	x
Chapter 1 BASIC SCANNER OPERATIONS.....	1
1.1 Turning the Scanner ON	2
1.2 Loading Documents on the ADF for Scanning	3
1.3 Loading Documents on the Flatbed for Scanning.....	7
1.4 Scanning Documents	8
1.5 How to Use the Scanner Driver	10
Chapter 2 SCANNING VARIOUS TYPES OF DOCUMENTS	25
.....	
2.1 Scanning Double Sided Documents	26
2.2 Scanning Books.....	28
2.3 Scanning Large Documents with Flatbed	30
2.4 Scanning Documents longer than A4 size	31
2.5 Scanning Different-width Documents.....	34
2.6 Saving Scanned Images in PDF Format.....	35
2.7 Excluding a Color in the Image (dropout color)	41

2.8	Skipping blank pages.....	42
2.9	Detecting Multi feeds.....	44
2.10	Correcting skewed documents.....	46
Chapter 3	DAILY CARE	49
3.1	Cleaning Materials and Locations requiring Cleaning..	50
3.2	Cleaning the Flatbed	51
3.3	Cleaning the ADF	53
Chapter 4	REPLACING CONSUMABLES	57
4.1	Consumable and Replacement Cycle.....	58
4.2	Replacing the Pad Assy	63
4.3	Replacing the Pick Roller.....	66
Chapter 5	TROUBLESHOOTING	73
5.1	Removing Jammed Documents	74
5.2	Remedying Typical Troubles	77
5.3	Items to Check Before Contacting the Agent Where You Bought the Scanner.....	90
5.4	Checking Labels on the Scanner	92
Chapter 6	ADF AND PAPER SPECIFICATION	93
6.1	Document Size	94
6.2	Document Quality	95

6.3	Maximum Document Loading Capacity.....	97
6.4	Area not to be perforated.....	98
6.5	Multi feed Detection Conditions.....	99
Chapter 7	SCANNER SPECIFICATION.....	101
7.1	Basic Specifications.....	102
7.2	Installation Specifications	104
7.3	External Dimensions	105
APPENDIX A	Before using the [Scan] or the [Send to] button	AP-1
GLOSSARY OF TERMS	GL-1
INDEX	IN-1

INTRODUCTION



Thank you for purchasing the fi-4220C2 Duplex Color Scanner product. This document describes how to handle fi-4220C2 Duplex Color and basic operation methods. Before you start using fi-4220C2 Duplex Color be sure to thoroughly read this manual to ensure correct use.

Regulatory Information

FCC Declaration

This equipment has been tested and found to comply with the limits for a Class B digital device, pursuant to Part 15 of the FCC Rules. These limits are designed to provide reasonable protection against harmful interference in a residential installation. This equipment generates, uses, and can radiate radio frequency energy and, if not installed and used in accordance with the instruction manual, may cause harmful interference to radio communications. However, there is no guarantee that interference will not occur in a particular installation. If this equipment does cause harmful interference to radio or television reception, which can be determined by turning the equipment off and on, the user is encouraged to try to correct the interference by one or more of the following measures:

- Reorient or relocate the receiving antenna.
- Increase the separation between the equipment and receiver.
- Connect the equipment into an outlet on a circuit different from that to which the receiver is located.
- Consult your dealer or an experienced radio/TV technician.

FCC warning: Changes or modifications not expressly approved by the party responsible for compliance could void the user's authority to operate the equipment.

		The use of a shielded interface cable is required to comply with the Class B limits of Part 15 of FCC rules.	
		The length of the AC cable must be 2 meters (6.6 feet) or less.	

Canadian DOC Regulations

This digital apparatus does not exceed the Class B limit for radio noise emissions from digital apparatus set out in the Radio interference Regulations of the Canadian Department of Communications.

This Class B digital apparatus complies with Canadian ICES-003.

Le présent appareil numérique n'émet pas de bruits radioélectriques dépassant les limites applicables aux appareils numériques de la classe B prescrites dans le Règlement sur le brouillage radioélectrique dicté par le ministère des Communications du Canada.

Cet appareil numérique de la classe B est conforme à la norme NMB-003 du Canada.

Bescheinigung des Herstellers / Importeurs

Hiermit wird bescheinigt, daß *der/die/das* **fi-4220C2**

- In Übereinstimmung mit den Bestimmungen der EN45014 (CE) funktentstört ist.
- Laut Maschinenlärminformationsverordnung 3. GS GV, 18.01.1991: Der höchste Schalldruckpegel beträgt 70 dB (A) oder weniger gemäß ISO/7779.

International ENERGY STAR® Program

As an ENERGY STAR® Partner, PFU LIMITED has determined that this product meets the ENERGY STAR® guidelines for energy efficiency.

The International ENERGY STAR® Office Equipment Program is an international program that promotes energy saving through the penetration of energy efficient computers and other office equipment. The program backs the development and dissemination of products with functions that effectively reduce energy consumption. It is an open system in which business proprietors can participate voluntarily. The targeted products are office equipment such as computers, monitors, printers, facsimiles, copiers, scanners, and multifunction devices. Their standards and logos () are uniform among participating nations.



Use in High-safety Applications

This product has been designed and manufactured on the assumption that it will be used in office, personal, domestic, regular industrial, and general-purpose applications. It has not been designed and manufactured for use in applications (simply called "high-safety applications" from here on) that directly involve danger to life and health when a high degree of safety is required, for example, in the control of nuclear reactions at nuclear power facilities, automatic flight control of aircraft, air traffic control, operation control in mass-transport systems, medical equipment for sustaining life, and missile firing control in weapons systems, and when provisionally the safety in question is not ensured. The user should use this product with adopting measures for ensuring safety in such high-safety applications. PFU LIMITED assumes no liability whatsoever for damages arising from use of this product by the user in high-safety applications, and for any claims or compensation for damages by the user or a third party.

About the Use of Mercury



Lamp(s) inside this product contain mercury and must be recycled or disposed of according to local, state, or federal laws.

To avoid unexpected injury, read the following carefully.

Doing the following actions may result in serious personal injuries:

- Do not put the substance contained in the lamp in your mouth as it has mercury.
- Do not incinerate, crush, or shred the lamps or scanner parts.
- Do not breathe the chemical liquid contained in the scanner lamps.

Trademarks

Microsoft, Windows, and Windows NT are registered trademarks of Microsoft Corporation in the United States and/or other countries.

ISIS, QuickScan and their respective logos are trademarks or registered trademarks of Pixel Translations, a division of Captiva Software Corporation in the United States.

Adobe, the Adobe logo, and Acrobat are either registered trademarks of Adobe Systems Incorporated in the United States and/or other countries.

Other product names are the trademarks or registered trademarks of the respective companies.

How Trademarks Are Indicated In This Manual

References to operating systems (OS) and applications are indicated as follows:

Windows 95	Microsoft® Windows® 95 operating system.
Windows 98	Microsoft® Windows® 98 operating system.
Windows Me	Microsoft® Windows® Millennium Edition operating system.
Windows NT 4.0	Microsoft® Windows® NT 4.0 Server operating system, Microsoft® Windows® NT 4.0 Workstation operating system.
Windows 2000	Microsoft® Windows® 2000 Professional operating system.
Windows XP	Microsoft® Windows® XP Professional operating system, Microsoft® Windows® XP Home Edition operating system.

Where there is no distinction between the different versions of the above operating system, the general term "Windows" is used.

Adobe Acrobat 6.0	Adobe® Acrobat® 6.0 Standard
-------------------	------------------------------

Manufacturer

PFU LIMITED

International Sales Dept., Imaging Business Division, Products Group

Solid Square East Tower, 580 Horikawa-cho, Saiwai-ku, Kawasaki-shi Kanagawa 212-8563, Japan

Phone: (81-44) 540-4538

All Rights Reserved, Copyright© PFU LIMITED 2004-2009



Outline characters on a colored background show instructions users should follow.
It may also include the drawing that shows the specific instruction.

Warning Label



The glass surface inside the ADF becomes hot during the operation. Be careful not to touch the glass surface inside the ADF.

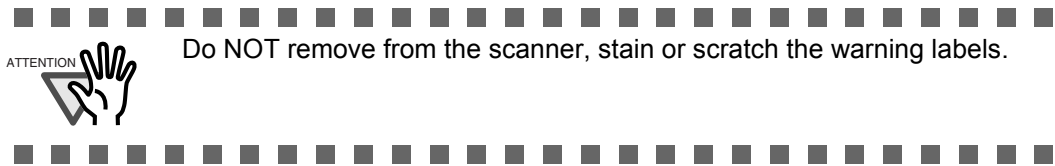

Do NOT remove from the scanner, stain or scratch the warning labels.

Screen Examples In This Manual

The screen examples in this manual are subject to change without notice in the interest of product improvement. If the actual displayed screen differs from the screen examples in this manual, operate by following the actual displayed screen while referring to the User's Manual of the scanner application you are using. The screenshots in this manual were captured from the FUJITSU TWAIN32 scanner driver, ScandAll 21 Image Capturing Utility Software, FUJITSU ISIS scanner driver, QuickScan™ image capturing software and Adobe® Acrobat®.

About Maintenance

The user must not perform repairs on this scanner.
Contact the store where you purchased the scanner or an authorized FUJITSU Image Scanner service provider to have repairs done on this product.

■ Safety Precautions



Do not damage the AC cable.



A damaged AC cable may cause fire or electric shock. Do not place heavy objects on AC cables, or pull, bend, twist, heat, damage or modify AC cables. Do not use damaged AC cables or power plugs, or install any cables or power plugs to loose wall sockets.

Use only specified AC cables and connector cables.



Use only specified AC cables and connector cables. Failure to use the correct cables might cause electric shock and/or equipment failure.

Use this scanner only at the indicated power voltage. Do not connect to multiple-power strips.



Use this scanner only at the indicated power voltage and current. Improper power voltage and current might cause fire or electric shock. Do not connect to multiple-power strips.

Do not touch the AC cable with wet hands.



Do not touch the power plug with wet hands. Doing so can cause electric shock.

Wipe any dust from the power plug.



Wipe off any dust from metal parts on the power plug or metal fittings with a soft, dry cloth. Accumulated dust can cause fire or electric shock.

Do not install the device in locations that has oil smoke, steam, humidity, and dust.



Do not install the scanner in locations subject to oil smoke, steam, humidity, and dust. Doing so might cause a fire or electric shock.

Turn the scanner OFF if it is damaged.



If the scanner is damaged for any reason, turn the scanner off and unplug the power cable. Contact the store where you purchased the scanner.

Do not put liquids inside the scanner.



Do not insert or drop metal objects in to the scanner. Do not scan wet documents or documents with paper clips or staples. Do not splash or allow the scanner to get wet.



If foreign objects (water, small metal objects, liquids, etc.) get inside the scanner, immediately turn off the scanner and disconnect the power plug from the power outlet. Then, contact the store where you bought the scanner or the Maintenance Service Center. Pay particular attention to this warning in households where there are small children.



Do not touch the inside of the scanner unless necessary.



Do not take apart or modify the scanner. The inside of the scanner contains high-voltage components. Touching these components might cause electric shock or fire.

Do not use the scanner if there is a strange odor.



If you detect heat coming from the device or detect other problems such as smoke, strange smells or noises, immediately turn off the scanner and disconnect its power plug. Make sure that any smoke coming from it has stopped, before contacting the store where you bought the scanner or an authorized FUJITSU scanner service provider.



Do not install the scanner on unstable surfaces.



Make sure that the scanner is installed on a flat, level surface and that none of its parts extend beyond the surface top, such as a desk or table. Do not install the scanner on unstable surfaces. Install the scanner on a level surface that is free of vibration to prevent it from falling.



Install the scanner on a strong surface that will support the weight of the scanner and other devices.

Do not block the ventilation ports.



Do not block the ventilation ports. Blocking the ventilation ports generates heat inside of scanner, which may result in fire or scanner failure.

Do not place heavy objects or stand on top of the scanner.



Do not place heavy objects on the scanner or use the scanner's surface top to perform other work. Improper installation might cause injuries and equipment failure.

Firmly insert the power plug.



Firmly insert the power plug as far it can go into the power outlet.

Avoid any contact when scanner is in use.



Avoid touching any scanner mechanism during scanning since this may cause injuries.

Do not use the scanner immediately after moving it from a cold place into a warm room.



Do not use the device immediately after moving it from a cold place into a warm room. Condensation may occur, which might lead to scanning errors. Let the device dry about one or two hours before you use it.

Before moving the scanner, disconnect the power plug from the power outlet.



Do not move the scanner with the power and interface cables connected as this can damage the cables, which can later cause fire, electric shock as well as injury. Before moving the scanner, be sure to disconnect the power plug from the power outlet, and all other data cables. Make sure that the floor is free of any obstructions.

Protect the scanner from static electricity.



Install the scanner away from strong magnetic fields and other sources of electronic noise. Also, protect the scanner against any static electricity, which can cause the scanner to malfunction.

Do not use aerosol sprays near the scanner.



Do not use aerosol sprays to clean the scanner. Aerosol sprays can blow dirt and dust inside the scanner, resulting in scanner failure or malfunction.

Disconnect the power plug from the power outlet when the scanner is not used for a long period of time.



When the scanner is not going to be used for a long period of time, be sure to disconnect the power plug from the power outlet.

Do not install the scanner in direct sunlight.



Do not install the scanner under direct sunlight or near heating apparatus. Doing so might cause excessive heat to build up inside the scanner, which can cause scanner trouble or even fire. Install the scanner in a well-ventilated location.

Before moving the scanner, make sure the shipping lock is locked.



When moving the scanner, be sure to lock the shipping lock in order to prevent damages to the scanner.

Be aware of the pick spring.



When you perform cleaning, make sure that the inside of the scanner is free of any foreign object, and be careful not to get your hand or the cloth caught on the pick spring (metal part) as a deformed pick spring (metal part) may cause injury.

Chapter 1

BASIC SCANNER OPERATIONS

This chapter describes basic scanner operations.

In this chapter Windows XP screenshots are illustrated.

The screens and operations may differ slightly if the OS that you are using is other than Windows XP.

Also, when FUJITSU TWAIN32 or FUJITSU ISIS is updated the screens and operations noted in this chapter will differ slightly.

1.1 Turning the Scanner ON	2
1.2 Loading Documents on the ADF for Scanning.....	3
1.3 Loading Documents on the Flatbed for Scanning	7
1.4 Scanning Documents.....	8
1.5 How to Use the Scanner Driver	10

1.1 Turning the Scanner ON

This section describes how to turn the scanner ON.

The following shows the procedure for turning the scanner ON.

1. Press the power button on the operator panel.

The scanner is turned ON, and the green LED on the operator panel lights.

Also, while the scanner is being initialized, the indication of the Function Number display changes as follows:

"8" -> "P" -> "0" -> "1"

The indication "1" means that the operator panel is in the ready status.

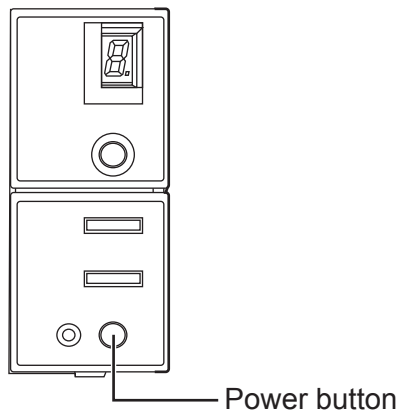

To turn the scanner OFF, hold the power button down for at least two seconds.

■ Power Save Mode

The Power Save mode keeps the scanner in a low-powered state after it has been turned ON.

If no operation is performed on the scanner for 15 minutes, the scanner automatically switches to the Power Save mode.

In the Power Save mode, the indication of the Function Number display on the operator panel goes out, but the green LED stays lit.

To return from the Power Save mode, perform one of the following:

- Load the document on the ADF paper chute.
- Press any button on the operator panel.
The scanner will be turned OFF when pressing down the power button for at least two seconds.
- Execute a command from the scanner driver.

1.2 Loading Documents on the ADF for Scanning

1. Align the edges of the documents.
 - 1) Confirm that all the documents have the same width.
 - 2) Check the number of sheets in the document stack.

The standard number of sheets that can be loaded on the scanner is as follows:

 - A4-size paper or smaller that makes a document stack of 5mm or less
 - Maximum 50 sheet at A4, 20 lb, or 80 g/m²

2. Fan the documents as follows:

- 1) Lightly grip both ends of the document with both hands, and bend the document as follows.

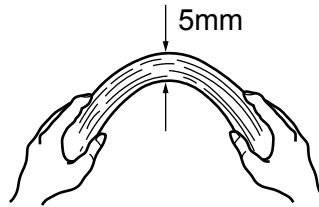

- 2) Firmly holding the document with both hands, bend back the document as follows so that the bent section rises up in the middle of the document as follows.



- 3) Repeat steps 1) to 2) a few times.
- 4) Rotate the document 90 degrees, and fan again.

3. Align the top of the documents.

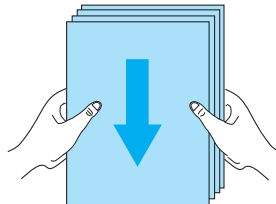

4. Load the document on the ADF paper chute.

Set the documents face-down in the ADF paper chute (so that the side to be scanned faces towards the ADF paper chute).

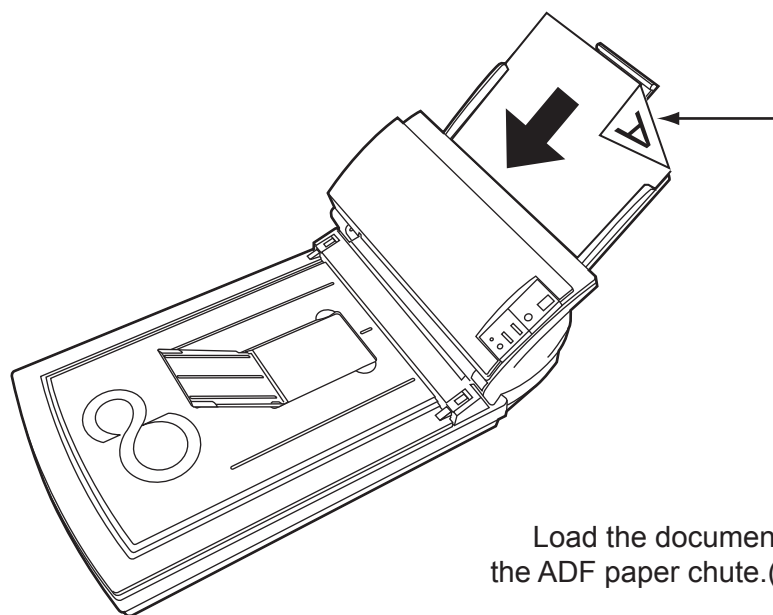

Load the document facing the ADF paper chute.(face down)

 HINT Before loading A4-size documents, pull out the ADF paper chute extension.

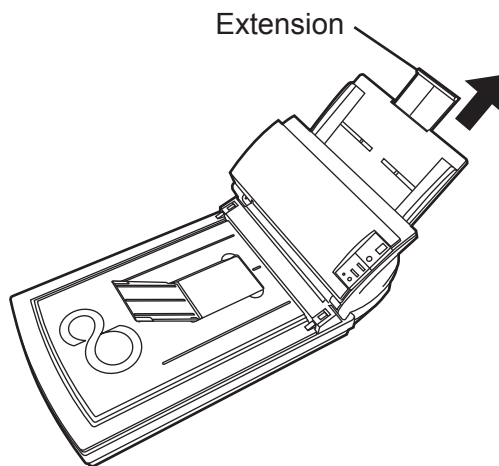



In case of operating with Windows XP OS:

When the document is set on the ADF paper chute the following window may appear on the screen.

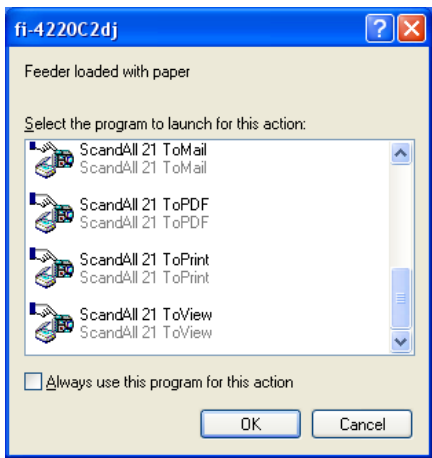

In this window, you can select the application program which will perform the scanning.

By selecting the application program from the "Select the program to launch for this action" menu and clicking the [OK] button, the selected program will be initiated.

For further information, please refer to "APPENDIX A Before using the [Scan] or the [Send to] button" (page AP- 1)

5. Adjust the side guides to the width of the documents.

Move the side guides so that they touch both sides of the documents. If there is any space between the side guides and the edges of documents, the scanned image may be skewed.

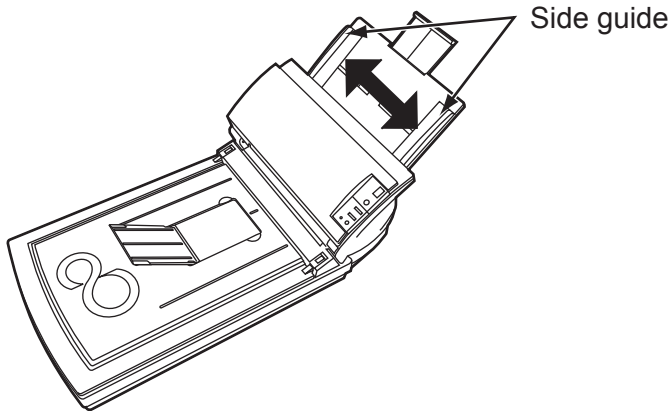



The stacker prevents document sheets from dropping after they are scanned.
Lift the paper stop and swing it forward by inserting your fingertips into the indentations on the scanner as shown in the figure below.

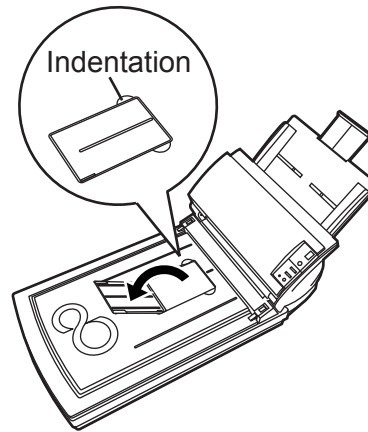

6. Start up the scanner application, and scan the document.

For details on how to scan documents using the ScandAll 21 application, refer to "1.4 Scanning Documents" (page. 8).

1.3 Loading Documents on the Flatbed for Scanning

1. Lift up the document cover.

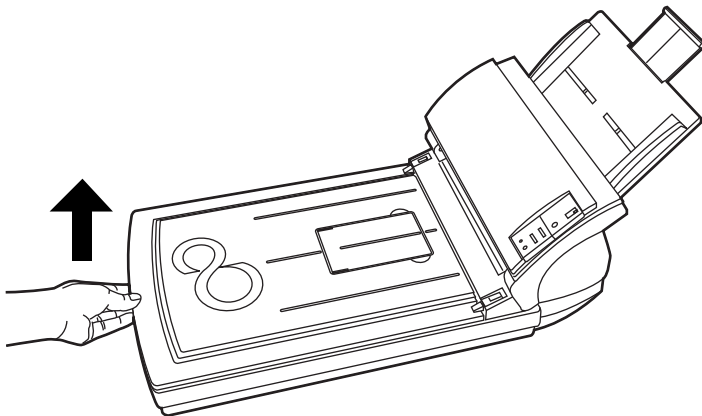

2. Load the document on the document bed with the scanning face down and the top left corner aligned with the reference point.

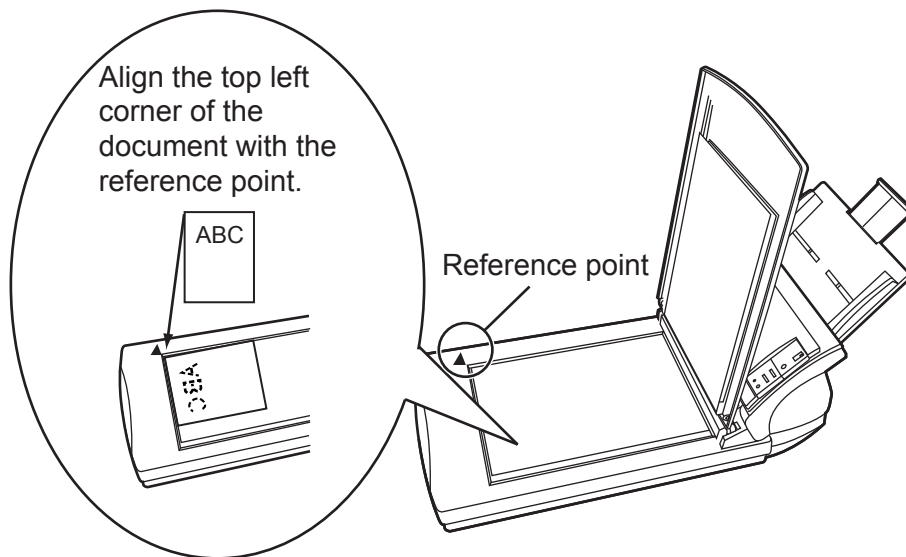

3. Gently close the document cover.
4. Start up the scanner application, and scan the document.

For details on how to scan documents using the ScandAll 21 application, see "1.4 Scanning Documents" (page. 8).

1.4 Scanning Documents

1. Load the document on the scanner's ADF paper chute or Flatbed.
For details on how to load documents, see "1.2 Loading Documents on the ADF for Scanning" (page. 3) and "1.3 Loading Documents on the Flatbed for Scanning" (page. 7).
2. Start up ScandAll 21.
Select [Start] - [Program] - [Scanner Utility for Microsoft Windows] - [ScandAll 21].
This starts up ScandAll 21.
3. Select the scanner to be used.
Select [Select Source] from the [Scan] menu.

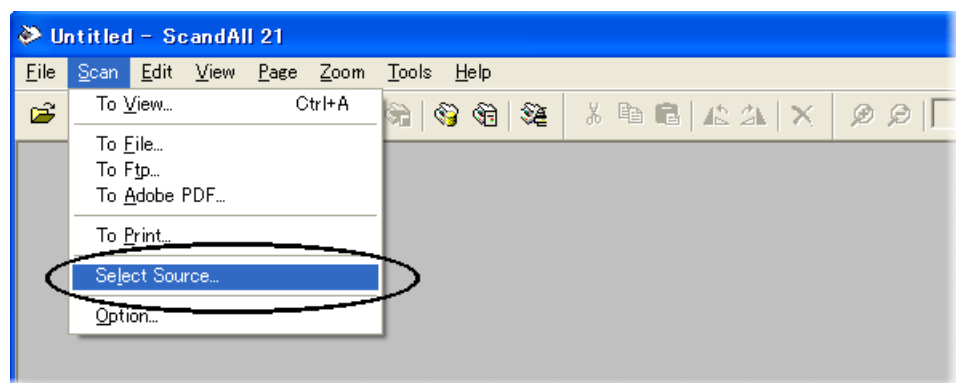

⇒ The [Select Source] dialog box appears.

Select "FUJITSU fi-4220C2dj" (for Windows 95 and WindowsNT 4.0, select "FUJITSU TWAIN 32") and click the [Select] button.

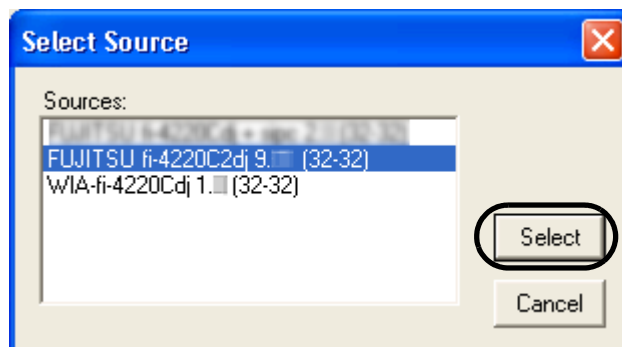

- Click the [Scan To View] button on the tool bar.

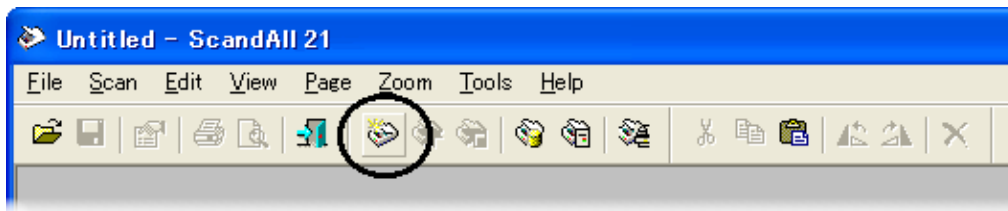

⇒ The [TWAIN Driver] dialog box (screen for setting the scan conditions) appears.

- Set the scan resolution, paper size and other scan conditions, and click the [Scan] button.

For details on settings in the [TWAIN Driver] dialog box, refer to "1.5 How to Use the Scanner Driver" (page. 10).

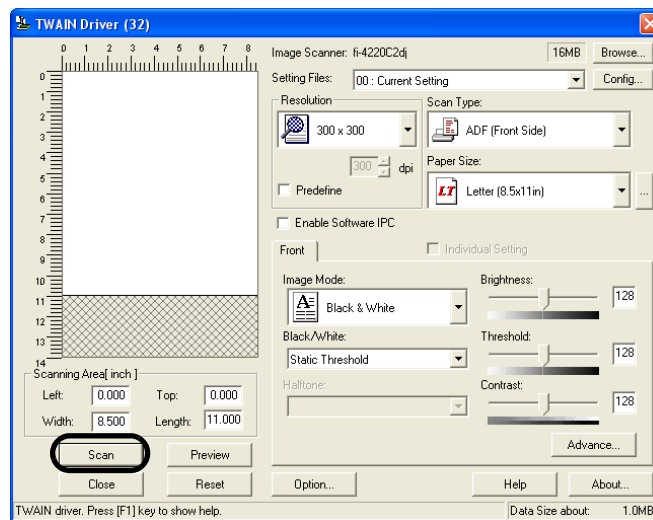

⇒ The document is scanned, and an image of the scanned document appears on the ScandAll 21 screen.

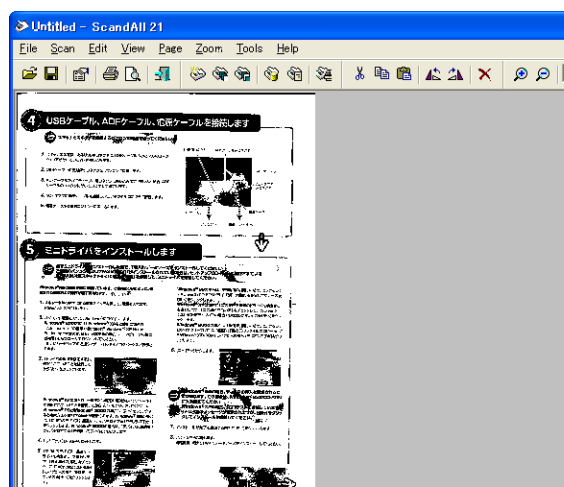

For details on scanning other types of documents, refer to "Chapter 2 SCANNING VARIOUS TYPES OF DOCUMENTS" (page. 25).

For details on ScandAll 21 functions and operations, refer to ScandAll 21 Help.

1.5 How to Use the Scanner Driver

■ FUJITSU TWAIN32 Scanner Driver

FUJITSU TWAIN32 Scanner Driver is designed for scanning documents with FUJITSU image scanner fi series by using application software that complies with the TWAIN standard. The following describes the procedure with examples of ScandAll 21 for ordinary scanning by using this driver software.

1. Procedure for Basic Scanning Operation

1) Startup the application.

From the [Start] menu, select [Programs]-[Scanner Utility for Microsoft Window] and click [ScandAll 21].

2) Select your scanner on the window below.

Select [Select Source] from the [Scan] menu.

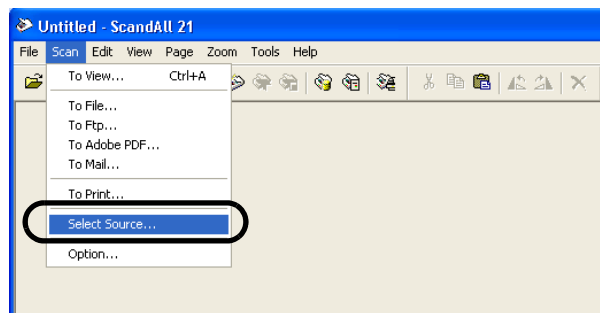

3) Select the scanner to use, then click the [Select] button.

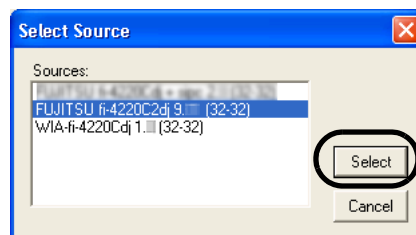

Select

- [FUJITSU fi-4220C2dj] for FUJITSU TWAIN32 V9

or

- [FUJITSU TWAIN32] for FUJITSU TWAIN32 V8

then click the [Select] button.

4) Load the documents on the scanner.

For details on loading documents, refer to "1.2 Loading Documents on the ADF for Scanning" (page. 3).

- 5) Open the TWAIN Driver window.
Select [Scan To View] from the [Scan] menu.



ScandAll 21 provide scanning methods as follows:

- [To View...]: Displays scanned images on the window.
- [To File...]: Saves scanned images as files (*.BMP, *.TIF, *.JPG).
- [To FTP...]: Transfers scanned images to a FTP server.
- [To Adobe PDF...]: Saves scanned images as PDF files. (*Adobe Acrobat must be installed beforehand.)
- [To Microsoft SharePoint Portal Server...]: Transfers scanned images to Microsoft Share Point Portal Server.
- [To Mail...]: Launches mailer software and attaches scanned images to e-mail.

For details, refer to "ScandAll 21 Help".

- 6) Configure settings for scanning and click the [Scan] button.

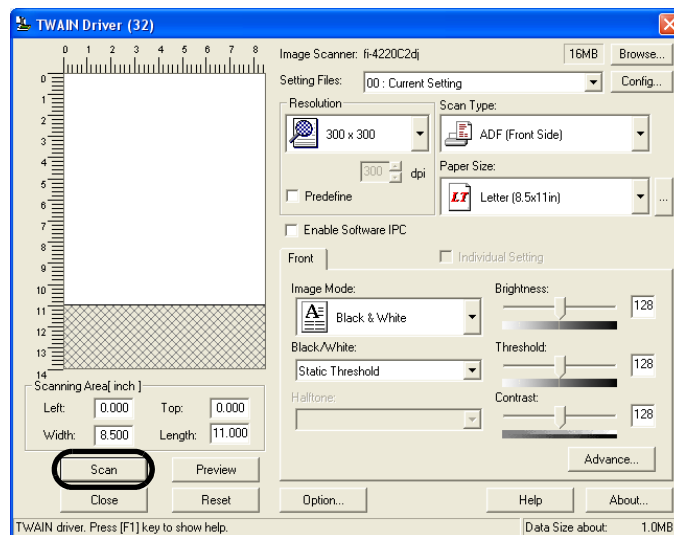

For details about the settings on this window, refer to "Setting Window for FUJITSU TWAIN32 Scanner Driver" (page. 13).

⇒ The images of scanned documents are displayed on the [ScandAll 21] window.

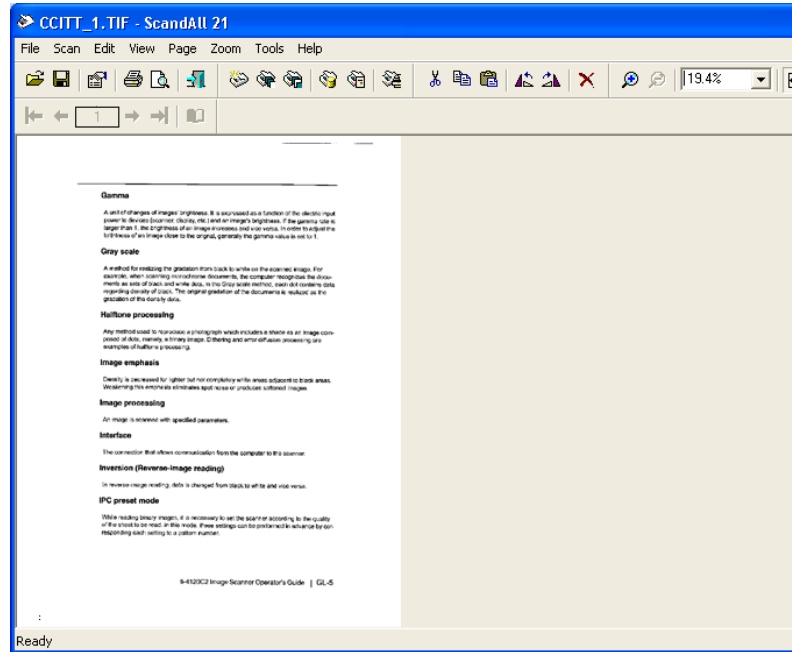

Depending on the settings of the application software, images may not be displayed. For details, refer to the documentation or Help file of your application. e.x.) When you select [To File...] from the [Scan] menu of ScandAll 21, images of scanned documents are not displayed on the window.

- 7) Save the scanned images.
Select [Save As...] from the [File] menu to save the scanned images.

If you wish to start another scanning, return to procedure 4.
- 8) End the application.
Select [Exit] from the [File] menu.

2. Setting Window for FUJITSU TWAIN32 Scanner Driver

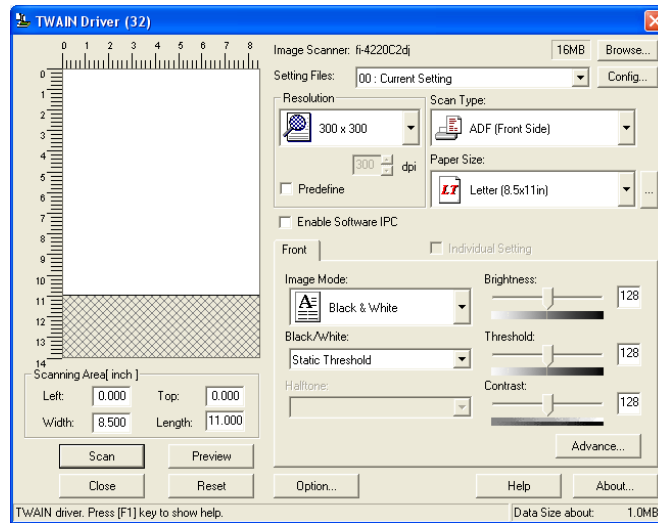

You can configure settings for the FUJITSU TWAIN32 Scanner Driver on this window. The following describes the main setting items.

- For details on each functions, refer to "FUJITSU TWAIN32 Scanner Driver Help" (appears by pressing [Help] or [F1] button).
- Depending on the type of your scanner, available setting items or range of setting values vary.

Resolution

Specifies the resolution of scanning.

It can be specified by selecting a default value from the list or customizing (specify any resolution in 1 dpi unit).

By marking the [Predefine] checkbox, you can select one from three predefined settings as [Normal], [Fine], [Super Fine] to scan documents instead of setting details by yourself.

Otherwise, you can change the details of the predefined settings on the [Resolution Setting] window, which appears when you click on the [...] button.

Scan Type

Specifies the feeding method, the side(s) to be scanned (Front Side, Back Side, Duplex, flatbed) or details of Long page (the size of documents longer than A4).

Paper Size

Select the size of documents to be scanned from this list.

Windows for customizing the paper size will appear when you click on [...] besides the list. You can save any document size as a customized setting (up to three) or for changing the order of the paper size in the list.

Image Mode

Specifies the image type for the scanned documents.

Black & White	Documents are scanned in binary (black and white).
Halftone	Documents are scanned through halftone processing in black and white.
Grayscale	Documents are scanned in gradations from black to white. For this mode you can select 256 gradations or 4 bit (16 gradations).
Color	Documents are scanned in color. For this mode, you can select 24 bit Color, 256 Color or 8 Color.

[Scan] button

Starts scanning documents with the current settings.

[Preview] button

Documents are scanned preliminarily before the actual scanning.
You can confirm the image of the documents in the preview window.

[Close] button

Saves the current settings and closes this window.

[Reset] button

Used to undo changes of settings.

[Help] button

Opens the "FUJITSU TWAIN32 Scanner Driver Help" window. The window also opens by pushing the [F1] key.

[About...] button

Opens an information window about the FUJITSU TWAIN32 Scanner Driver's version.

[Option...] button

You can set up the details of optional functions on the window below.

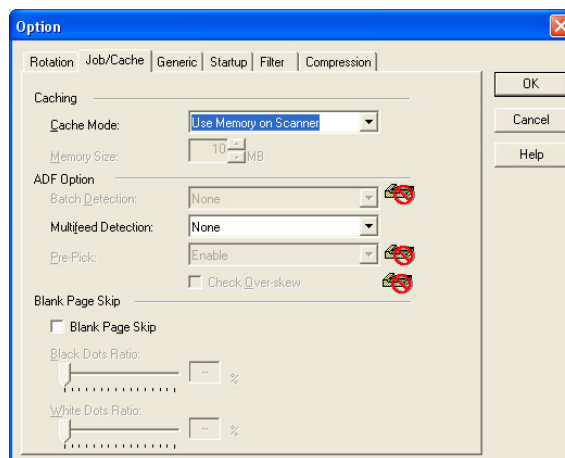

[Rotation] tab

Select this tab when setting image rotation, detection of document size, etc.

[Job/Cache] tab

Select this tab when setting cache mode, multi feed detection, blank page skipping, etc.

[Generic] tab

Select this tab to change the unit displayed on the Setting Window for the FUJITSU TWAIN32 Scanner Driver. (Millimeters, Inches, and Pixels are available)

[Startup] tab

Select this tab for setting the Scanner Operation Panel.

[Filter] tab

Select this tab for setting the image processing filter(s).

Page Edge Filler: Fills up the margins of the scanned documents with a selected color.

Digital Endoser: A character string, such as the alphabet and numbers, can be added in the scanned document.

[Compression] tab

Select this tab for setting the compression rate of JPEG Transfer.

[Advance...] button

Click this button for settings of the advanced image processing.

You can set Edge Extract, Gamma Pattern, White Level Follower, Dropout Color, Reverse, etc.

[Config...] button

Click this button for configuring the Setting Files.

You can save the changed settings as a Setting File. From next scanning, the settings are quickly changed by using these Setting Files.

For details of each function, refer to the "FUJITSU TWAIN32 Scsnnr Driver Help".

■ FUJITSU ISIS Scanner Driver

FUJITSU ISIS Scanner Driver is designed for scanning documents with FUJITSU image scanner fi series by using application software that complies with The ISIS standard.

The following describes the procedure with examples of QuickScan for ordinary scanning by using this driver software.

The procedure may vary depending on your application. If you use an application other than QuickScan, please refer to its Guide or Help for further information.

1. Procedure for Basic Scanning Operation

1) Startup the application.

From the [Start] menu, select [Programs] - [QuickScan] and click [QuickScan].

2) Select your scanner on the window below.

Select [Scan] - [Select Scanner] on the menu bar.

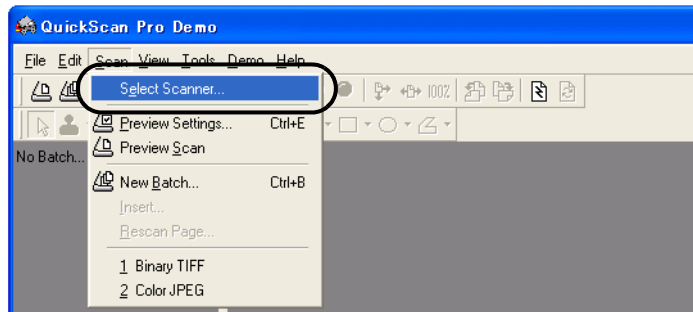

3) Select fi-4220C2, then click the [OK] button.

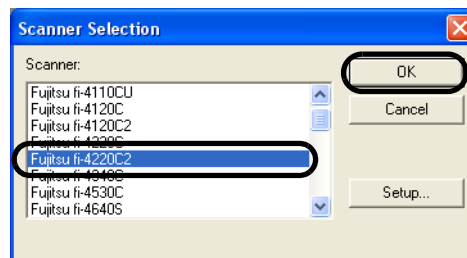

4) Select [Scan] - [New Batch] on the menu bar.

- 5) Select the profile for scanning.

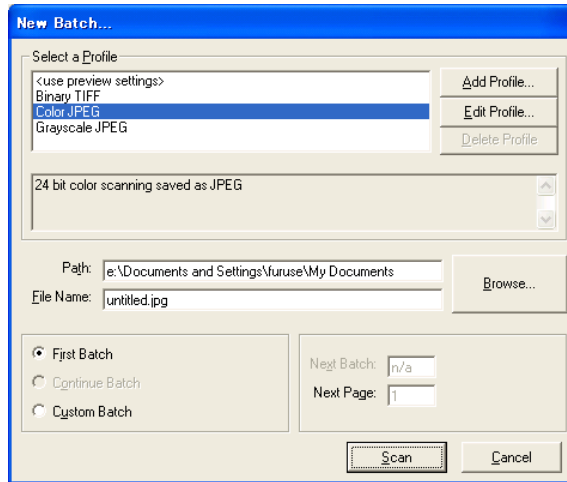

- When creating a new profile
Select one from already existing profiles and click [Add Profile...]
⇒ A new profile will be created based on the profile you select.
 - When changing the settings of already existing profiles
Select one from already existing profiles and click [Edit Profile...]
⇒ The settings of the selected profile can be changed.
 - When using an existing profile
Select one from an already existing profiles.
⇒ Scanning will be started according to the settings of the selected profile.
Go to procedure 9.
- 6) Open the window of ISIS Driver.
Select the [Scan] tab and click the [Scanner Settings] on the [Profile Editor] window.

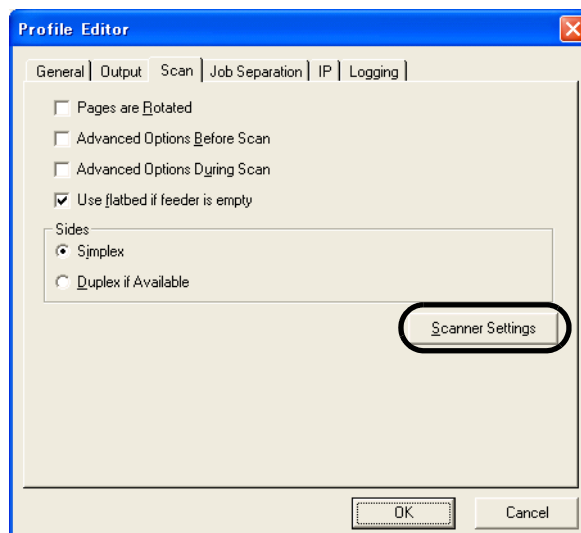

⇒ The configuration window of ISIS driver appears.

- 7) Configure settings for scanning and click the [OK] button.

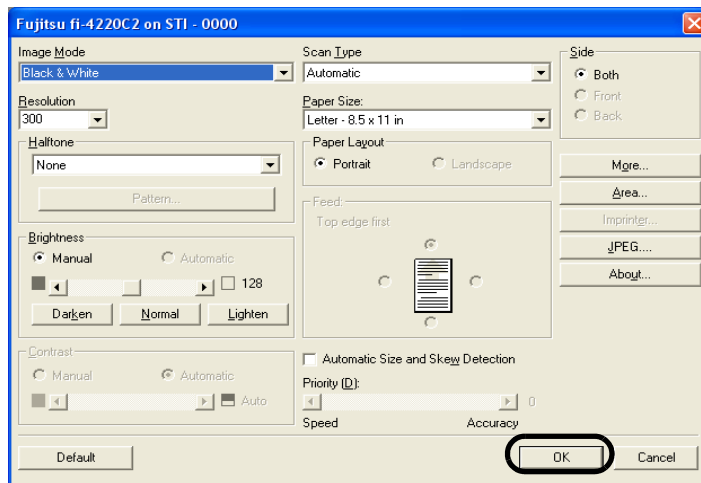

For details on this dialog box, refer to "Configuration Window of FUJITSU ISIS Scanner Driver" (page. 19).

- 8) The [Profile Editor] window appears. Click the [OK] button to return to [New batch] dialog.
- 9) Load the documents on the scanner.
- 10) Click the [Scan] button.

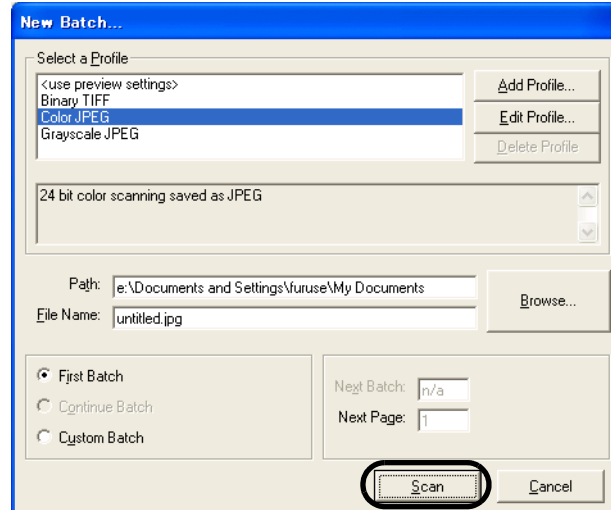

⇒ Scanned images are displayed on the window.

Refer to the "QuickScan Overview" or the "QuickScan Help" for further information on functions and operations of QuickScan. After the installation of QuickScan, it is registered in the [Start] menu.

2. Configuration Window of FUJITSU ISIS Scanner Driver

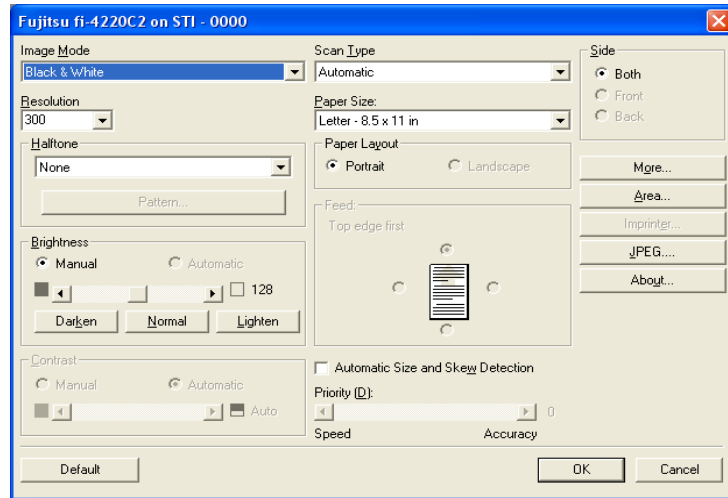
**Image Mode**

Select a color mode suitable for the purpose from the menu.

Black & White	Scans data in binary (black and white). Distinguishes black from white according to the fixed threshold. This scanning mode is suitable for scanning line drawings and text documents.
16-level Grayscale	Scans data by 14 shades of gray plus black and white. This mode uses 4 bits per pixel.
256-level Grayscale	Scans data by 254 shades of gray plus black and white. This mode uses 8 bits per pixel. This mode is suitable for scanning monochrome photographs.
24-bit Color	Scans data as full-colored image using 24 bits per pixel. This mode is suitable for scanning color photographs.
Image Processing	Binary processing is applied to the scanned images. This mode is available only when Image Processing Software Option (separately sold) is installed. Please refer to the "User's Guide of Image Processing Software Option" for details.

Resolution

Specifies the number of pixels (dots) per inch.

Select a fixed resolution from the list or enter any value (from 50 to 600) manually.

A higher resolution produces finer image, but requires much more memory.

Halftone

Select the halftone pattern for halftone scanning. This setting is available when "Black & White" is selected in the "Image Mode".

Dither Pattern 0	This setting is suitable for scanning dark photographs.
Dither Pattern 1	This setting is suitable for scanning dark-colored documents containing both text and photographs.
Dither Pattern 2	This setting is suitable for scanning light photographs.
Dither Pattern 3	This setting is suitable for scanning light-colored documents containing both text and photographs.
Error Diffusion	This function minimizes differences of color levels due to subtractive color process by diffusing the difference to the adjacent pixels. This mode is suitable for scanning images of photographs, etc.
Download	Executes processing with the dithered download pattern specified in the dithered download file.

Brightness

Sets the brightness of the entire image. Specify the brightness as a number within the range of 1 (dark) to 255 (bright). To brighten the entire image, increase the value of the setting. To darken the entire image, decrease the value.

Contrast

Sets the contrast between light and shadow of the scanned image. Specify the contrast as a number within the range of 1 (low [soft]) to 255 (high [sharp]). Increasing this value makes the contrast sharper.

Scan Type

Selects the scanning method.

Automatic	Detects the document loaded onto the scanner and determines automatically whether to scan from the ADF, or from the Flatbed.
Flatbed	Scans the document placed on the flatbed.
ADF (Front Side)	Scans only the front sides of documents.
ADF (Back Side)	Scans only back sides of documents.
ADF (Duplex)	Scans both front and the back sides of documents. When this option is selected, the both sides of documents are scanned simultaneously. This option can be used only for the models that support duplex scanning.

Paper Size

Selects a paper size according to the size of the document to be scanned. Select a standard paper size from the list.

Paper Layout

Specifies orientation of the documents as portrait or landscape.

Automatic Size and Skew detection

This option will adjust the output to the detected page size, and it will detect and automatically correct the skew of the document.

With [Priority] slider control, you can change accuracy of Automatic Page Size Detection. Move the slider to the right when improving the detection accuracy.

[Area...] button

Opens the Scan Area dialog box.

Specify scan area for the document size.

The size can be set by dragging the frame with mouse.

Otherwise, enter any value for the setting.

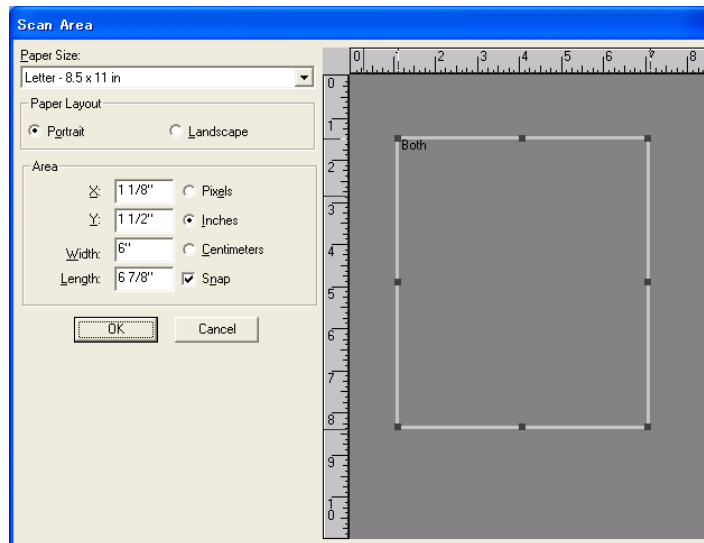
**[JPEG...] button**

Opens the JPEG Settings dialog box. Used for setting the compression rate of JPEG transfer.

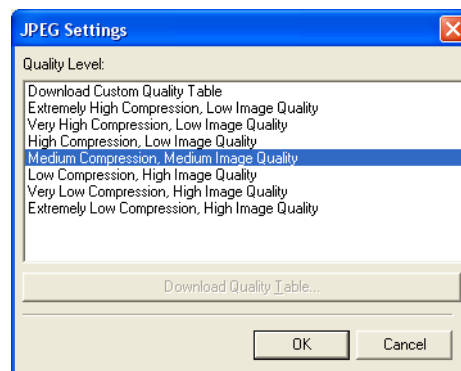
**[About...] button**

This button displays the version information.

[More...] button

Opens [More Settings] window. Used for setting advanced features.

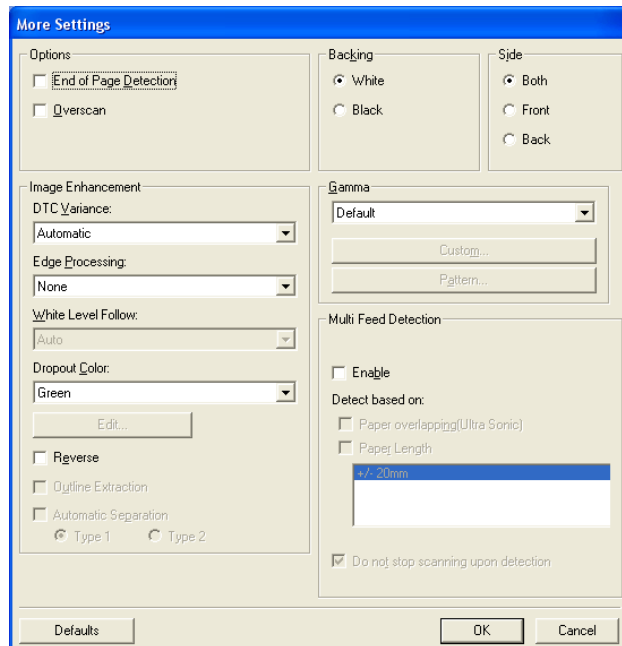

End of Page Detection

Scans the edge (bottom) of the documents and outputs data adjusted to the document length. When any page shorter than specified "Paper Size" is included, the output size is adjusted to the detected short size.

Overscan

This function makes the scanned images larger than the original documents by adding margins.

Backing

With this function, the outside of document paper becomes black / white by selecting [black] / [white] background.

Gamma

Specifies Gamma correction. Correction patterns are: "Normal", "Soft", "Sharp", "Custom", or "Download".

DTC Variance

This option specifies the value for adjusting the variance based on the brightness of the image.

Edge Processing

This option specifies the sharpness of contour extraction.

Low, Mid, High Emphasizes contour of images. Available settings are: Low, Mid, High

Smoothing Smoothes jaggy images.

Dropout Color

This option excludes selected color (the three primary colors of light i.e. green, red, blue) from scanned images. For example, if the document contains black text in a red frame and when the red color is selected, the scanner reads only the text and eliminate (drop out) the red frame.

If you do not wish to have any colors dropped out select "None".

Reverse

Colors of scanned images are reversed.

Multi feed Detection

Detects Multi feeds (phenomena that two or more sheets are accidentally fed). You can set conditions for detecting Multi feeds so that the scanner should stop and display error messages. Multi feeds are scanned by the differences in document lengths or thicknesses.

Chapter 2

SCANNING VARIOUS TYPES OF DOCUMENTS

This chapter describes how to scan various types of documents.

In this chapter Windows XP screenshots are illustrated.

The screens and operations may differ slightly if the OS that you are using is other than Windows XP.

Also, when FUJITSU TWAIN32 or FUJITSU ISIS is updated the screens and operations noted in this chapter will differ slightly.

2.1 Scanning Double Sided Documents	26
2.2 Scanning Books	28
2.3 Scanning Large Documents with Flatbed	30
2.4 Scanning Documents longer than A4 size.....	31
2.5 Scanning Different-width Documents	34
2.6 Saving Scanned Images in PDF Format.....	35
2.7 Excluding a Color in the Image (dropout color)	41
2.8 Skipping blank pages	42
2.9 Detecting Multi feeds	44
2.10 Correcting skewed documents	46

2.1 Scanning Double Sided Documents

The following shows the procedure for reading the double sided documents.

1. Load the document on the ADF paper chute.

For details on how to load documents, see "1.2 Loading Documents on the ADF for Scanning" (page. 3).

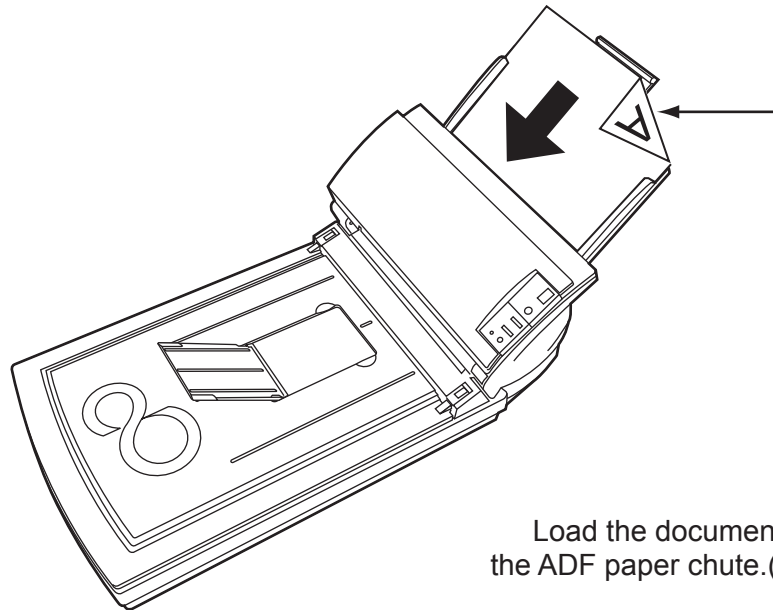

Load the document facing the ADF paper chute.(face down)

2. Adjust the side guides to the width of the documents.

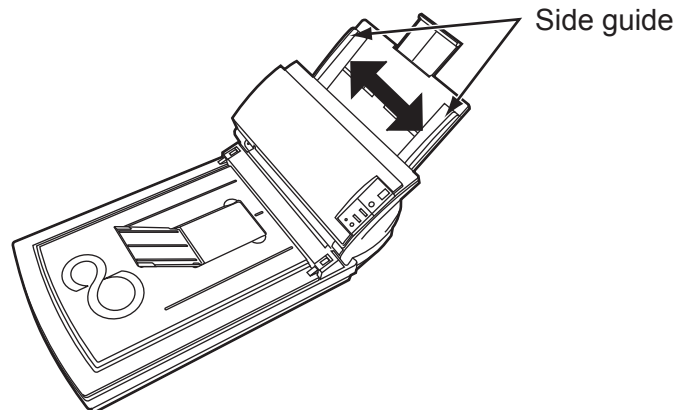

3. Start up ScandAll 21.

From [Start] menu, select [Program] - [Scanner Utility for Microsoft Windows] - [ScandAll 21]. This starts up ScandAll 21.

4. Select fi-4220C2.

5. Click [Scan To View] on the tool bar. The [TWAIN Driver] dialogbox appears.

6. Select [ADF (Duplex)] from [Scan Type].

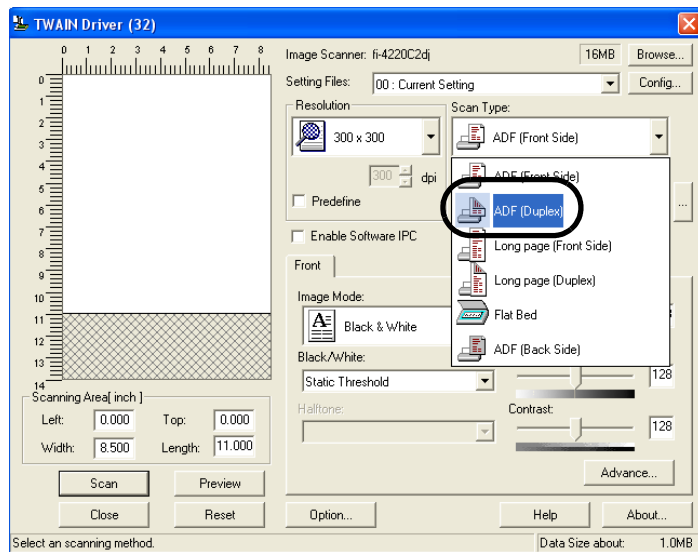

7. Click the [Scan] button.

For [TWAIN Driver] dialog box setting, refer to "1.5 How to Use the Scanner Driver" (page. 10).

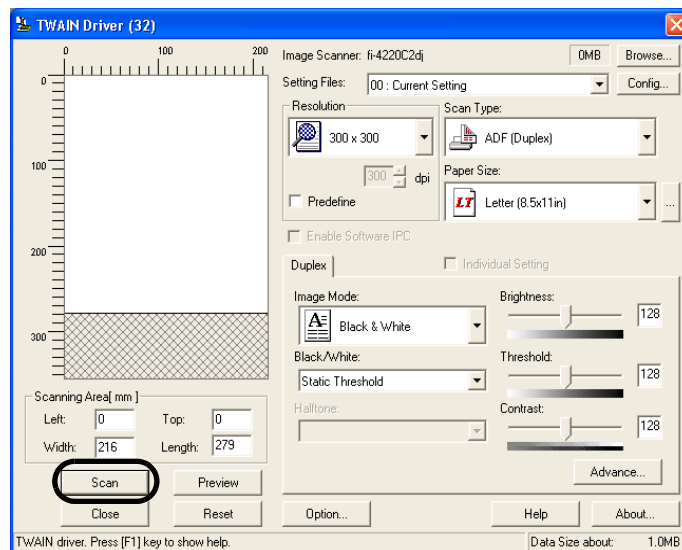

⇒ The document is scanned, and an image of the scanned document appears on the ScandAll 21 screen. For ScandAll functions and operation, refer to [ScandAll 21 Help].

2.2 Scanning Books



Never look directly the light source during scanning.

1. Open the document cover.

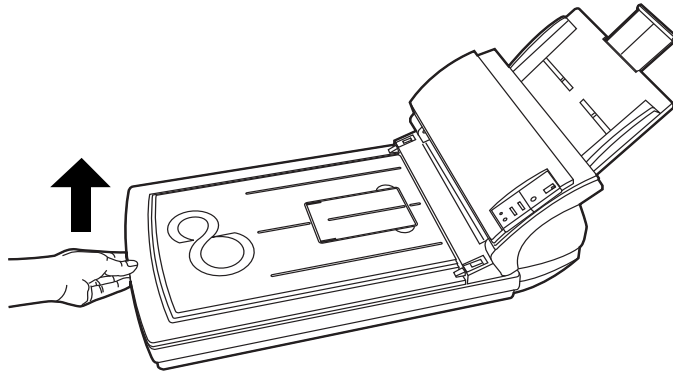

2. Remove the document cover as shown in the figure below.

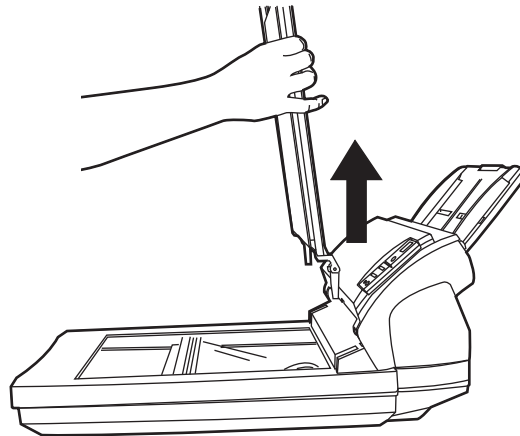

3. Read the document on the document bed face down.

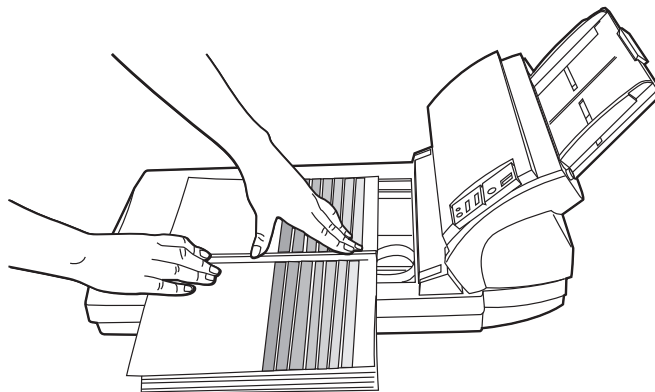

4. Issue the scan command on the host system.

For details on scanning commands, refer to "1.4 Scanning Documents" (page. 8).

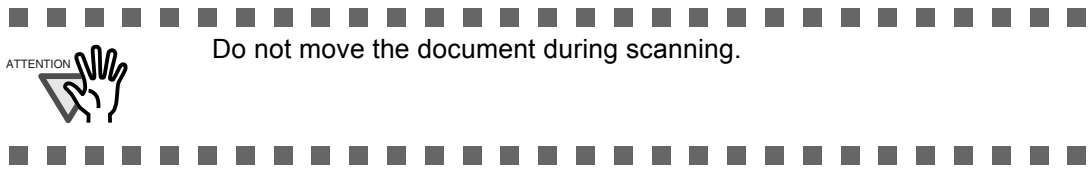

5. When scanning ends, re-attach and gently close the document cover.

2.3 Scanning Large Documents with Flatbed



Never look directly the light source during scanning.

1. Remove the document cover as shown in the figure below.

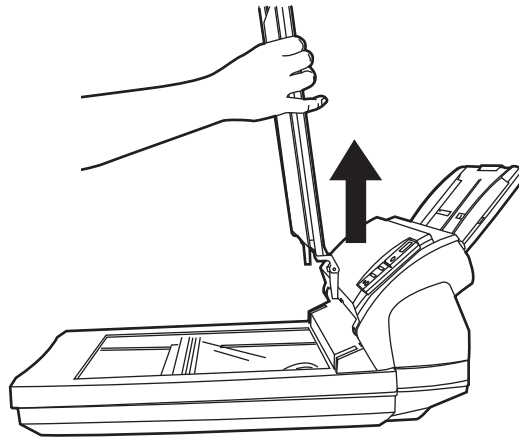

2. Load the document on the document bed face down.

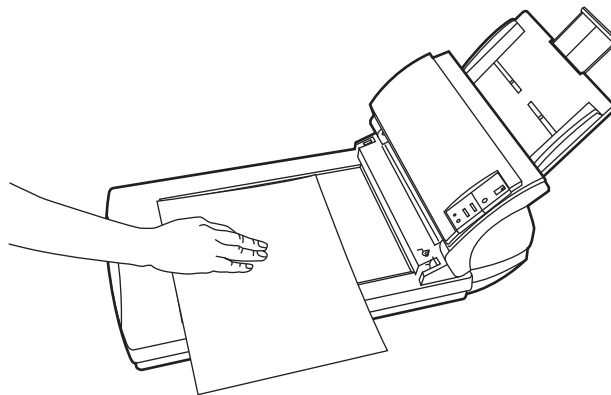

3. Issue the scan command on the host system.

For details on scanning commands, refer to "1.4 Scanning Documents" (page. 8).



Do not move the document during scanning.



4. When scanning ends, re-attach and gently close the document cover.

2.4 Scanning Documents longer than A4 size

1. Load the documents on the ADF paper chute.

For details on loading documents, refer to "1.2 Loading Documents on the ADF for Scanning" (page. 3)

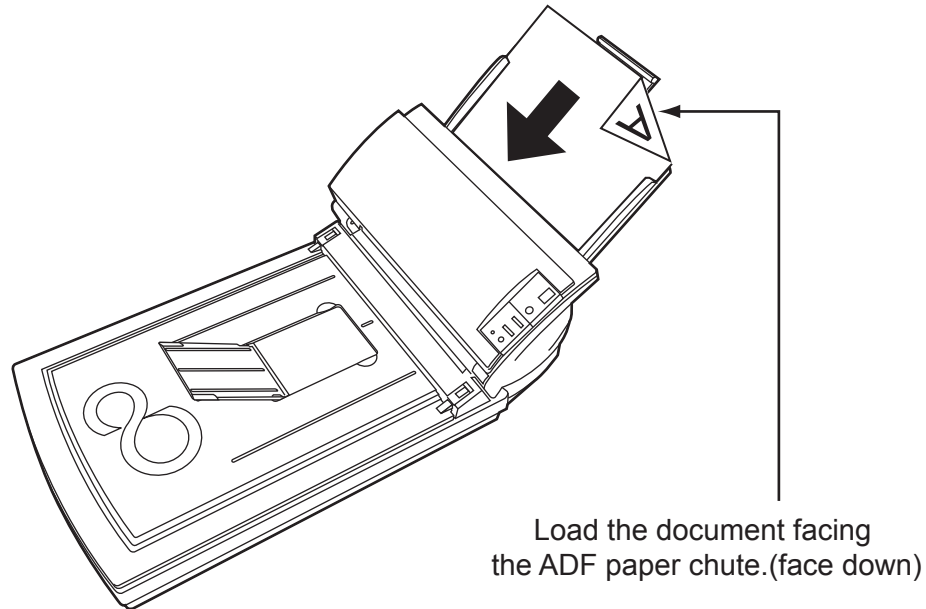

2. Adjust the side guides to the document width.

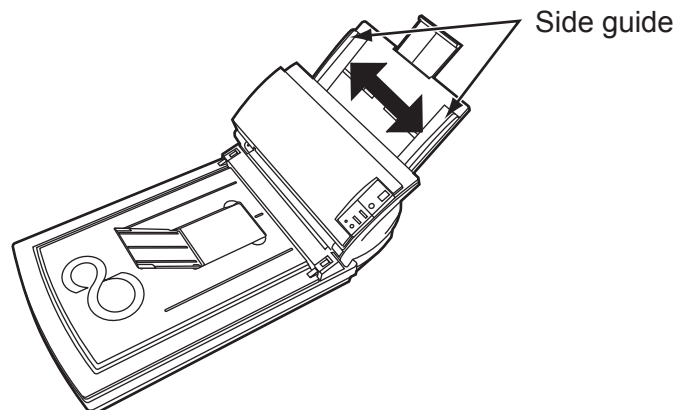

3. Start up ScandAll 21.

For starting up ScandAll 21, select [Programs] - [Scanner Utility for Microsoft Windows] - [ScandAll 21] from [Start].

4. Select fi-4220C2.

5. Click [Scan To View] on the tool bar.

⇒ The [TWAIN Driver] dialogbox appears.

6. Select [Long page (Front Side)] or [Long page (Duplex)] from [Scan Type].

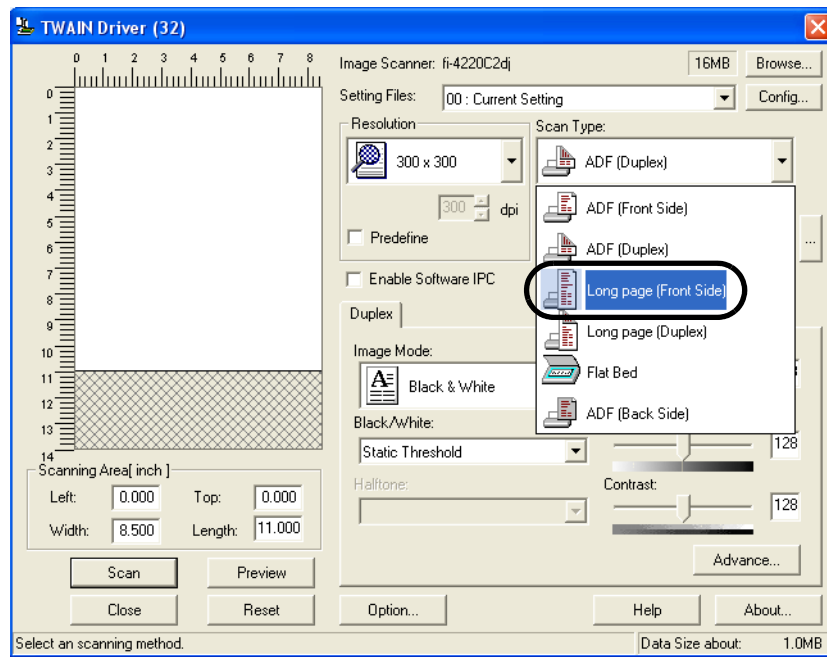

7. Specify the length of documents.

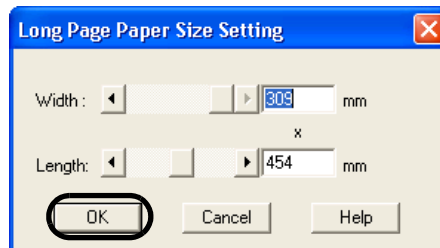

8. Click the [Scan] button.

For settings in the [TWAIN Driver] dialogbox, refer to "1.5 How to Use the Scanner Driver" on page 10.

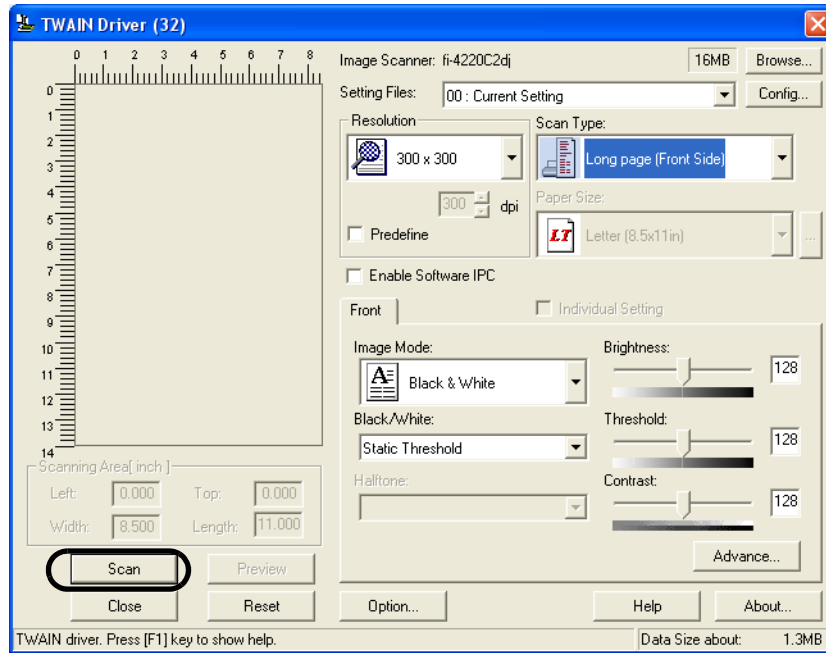

⇒ Images of scanned documents are displayed on the window of ScandAll 21.

For details on functions and operations of ScandAll 21, refer to "ScandAll 21 Help".

2.5 Scanning Different-width Documents

When you scan a batch of documents with different widths by using the ADF, you may get skewed images from smaller sized documents.

Be sure to scan only documents of the same width together.

The following shows the procedure for scanning a batch of mixed size documents.

1. Sort out the batch into stacks of the same width.
2. Adjust the side guides to the width of each document stack.
3. Scan the batches of the same widths separately one by one.

For details on how to load documents, see "1.4 Scanning Documents" (page. 8).

2.6 Saving Scanned Images in PDF Format

To save scanned images in PDF format, Adobe Acrobat 6.0 or later must be installed on your PC. Adobe Acrobat 6.0 can be installed from the provided Adobe Acrobat CD-ROM.

There are 2 ways for saving scanned images in PDF format.

1. Using ScandAll 21

This method is recommended for color or grayscale scanning and when smaller PDF file size is required.

The benefits are:

- Reduced PDF data size
- Simplified method for creating PDF files with no troublesome operations

2. Using Adobe Acrobat 6.0

This method is recommended for faster creation of PDF files and for black and white scanning.

The benefits are:

- Quick creation of PDF files with the original scan resolution
- Flexible creation of PDF files by changing the PDF compression rates

Grayscale or color scanning creates larger file sizes than black and white scanning.

If the file size is very large, you can reduce the file size by configuring the properties of Acrobat Distiller before saving scanned images.

For details, please refer to the hints on page 40.

■ Using ScandAll 21

1. Load the documents on the ADF paper chute or the flat bed.
2. Start up ScandAll 21.

From [Start] menu, select [Program] - [Scanner Utility for Microsoft Windows] - [ScandAll 21]. This starts up ScandAll 21.

3. From the menu bar select [Scan] and then [To Adobe PDF] from the pull down menu.

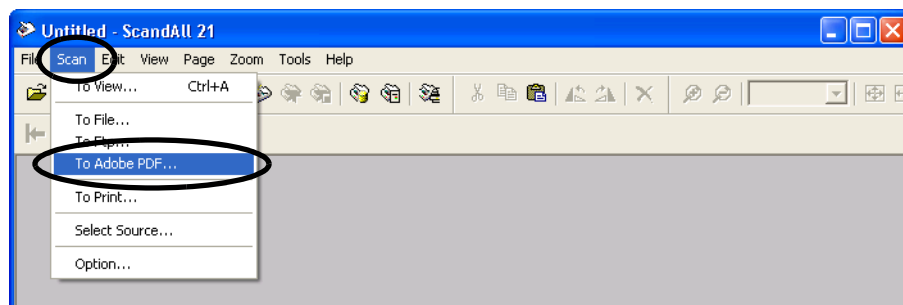

⇒ [TWAIN Driver] dialog box is displayed.

4. Select the scan resolution, document size and other scan conditions, and then click the [Scan] button.

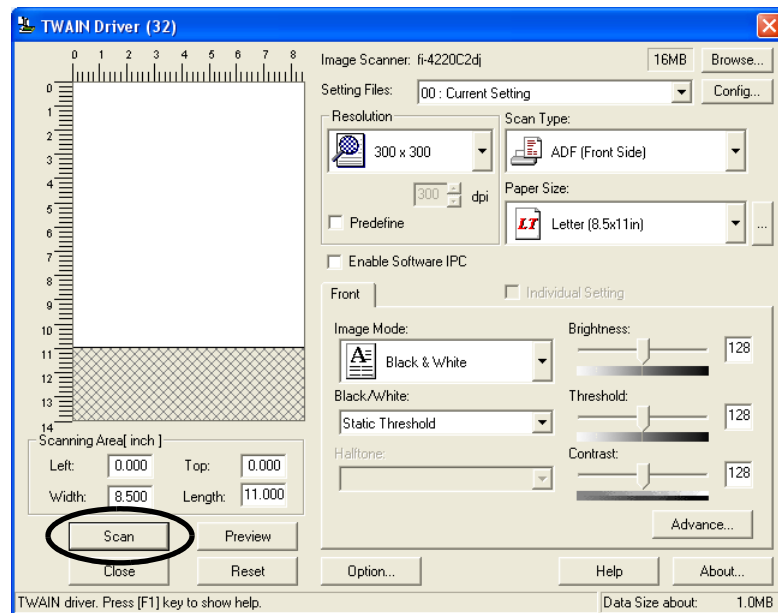

5. To end scanning, click the [Close] button.
6. Enter the file name and select the destination to save the scanned image.
For details, refer to ScandAll 21 Help.

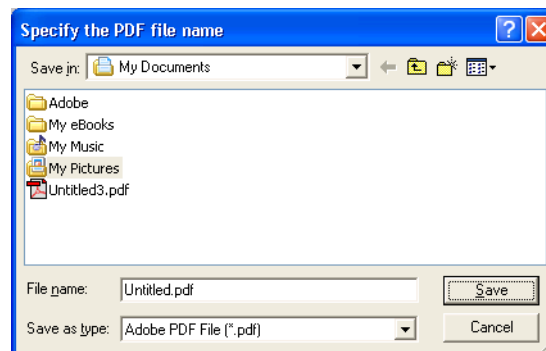

■ Using Adobe Acrobat 6.0

1. Load the documents on the ADF paper chute or flat bed.
2. Start up Adobe Acrobat 6.0.
Select [Program] - [Adobe Acrobat 6.0] from the [Start] menu. This starts up Adobe Acrobat 6.0.
3. From the [File] menu select [Create PDF] - [From Scanner].

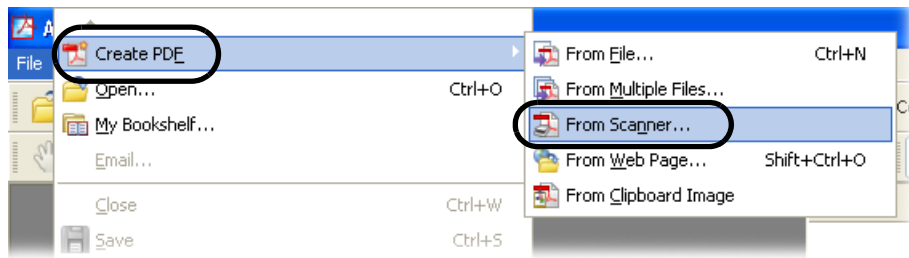

⇒ [Acrobat Scan Plug-in] dialog box is displayed.

4. Select [FUJITSU fi-4220C2dj] ([FUJITSU TWAIN 32] for WindowsNT 4.0) at [Device] and click [Scan] button.

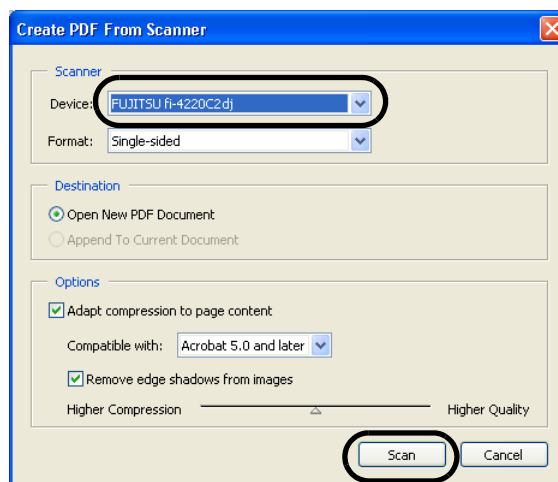

⇒ [TWAIN driver] dialog box is displayed.

5. Select the scan resolution, document size and other scan conditions, and click the [Scan] button.

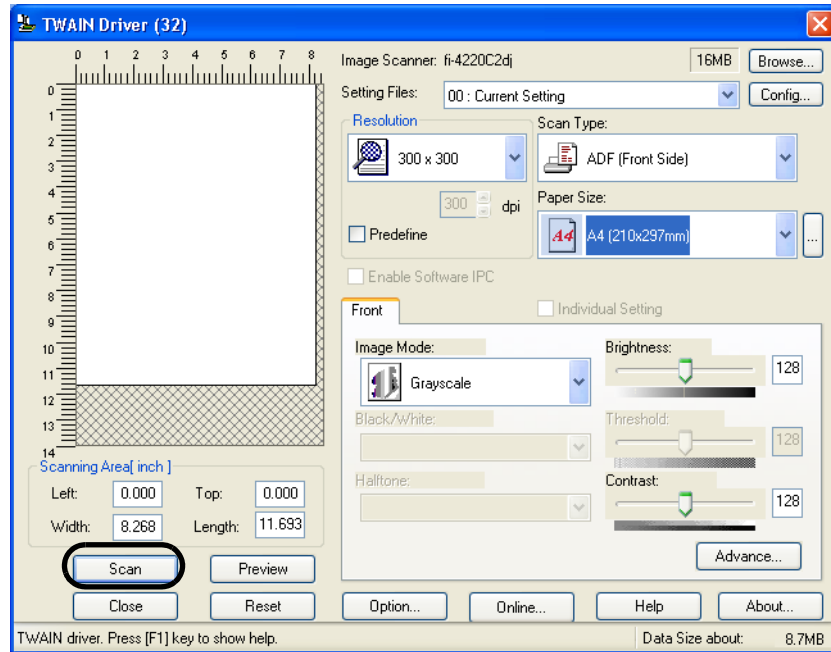

6. To end scanning, click the [Done] button.

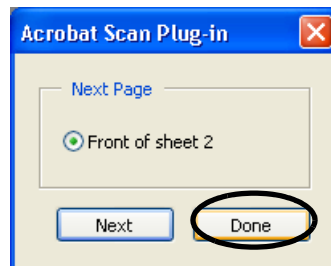

⇒ The scanned image is displayed.

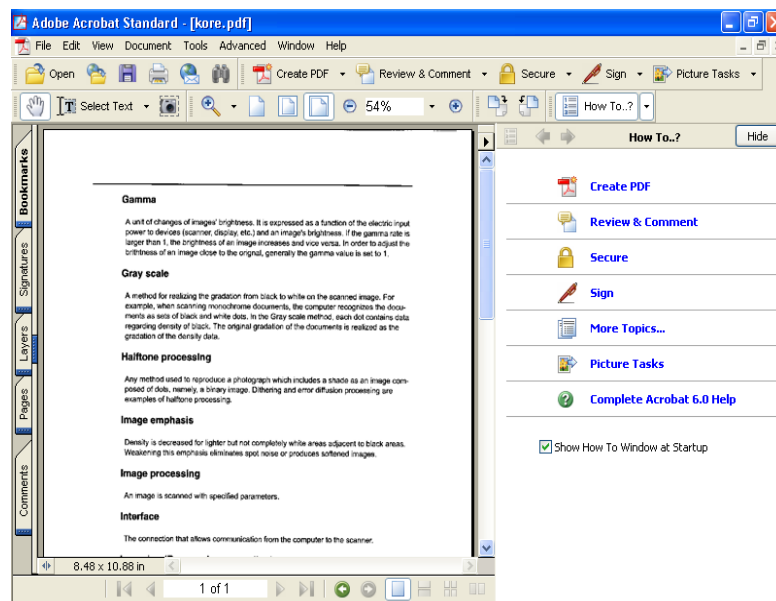

7. Select [Save as...] or [Save] from [File] menu to save the scanned image.

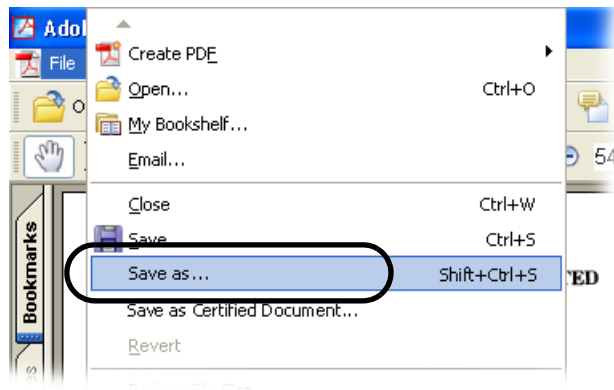

For the details on Adobe Acrobat 6.0 operations, refer to the Adobe Acrobat 6.0 manual and Help.



If you save scanned documents using this procedure, the file size may increase. For reducing the file size, please follow the procedure below. (It may take more time than usual)

1. Select [File] - [[Print...]].
2. On the following dialog specify [Adobe PDF] for [Name].

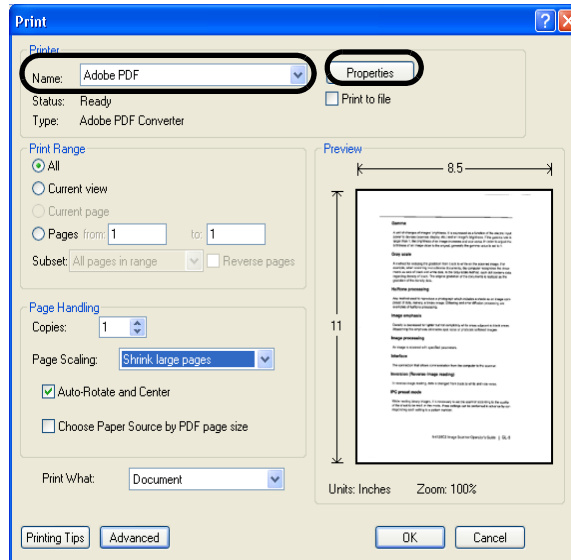

3. Click the [Properties] button.
4. Click the [Adobe PDF settings] tab.
5. Select one from [Default Settings].
The following shows an example of [Standard].

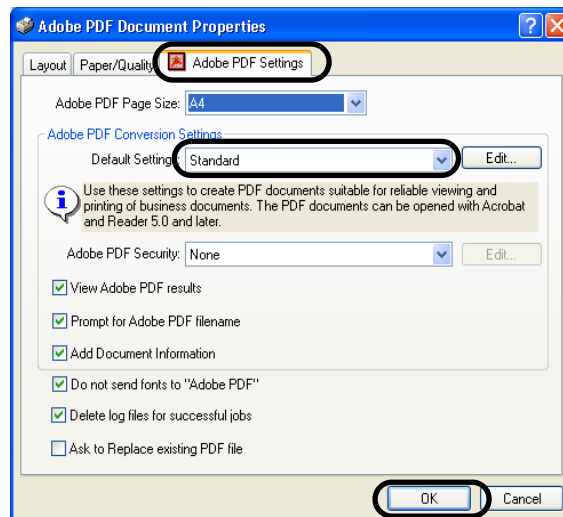

6. Click [OK] button.
7. Enter a file name and click the [Save] button on the [Save PDF File As] dialogbox.

2.7 Excluding a Color in the Image (dropout color)

A selected color (primary colors: red, green or blue) can be removed (dropped out) from the scanned image data.

For example, if the document contains black text in a green frame, you can set the scanner to read only the text and eliminate (drop out) the green frame.

To set the scanner to drop out a color, change the settings in the [TWAIN Driver] dialogbox before scanning.

1. Click the [Advance...] button in the [TWAIN Driver] dialog box.

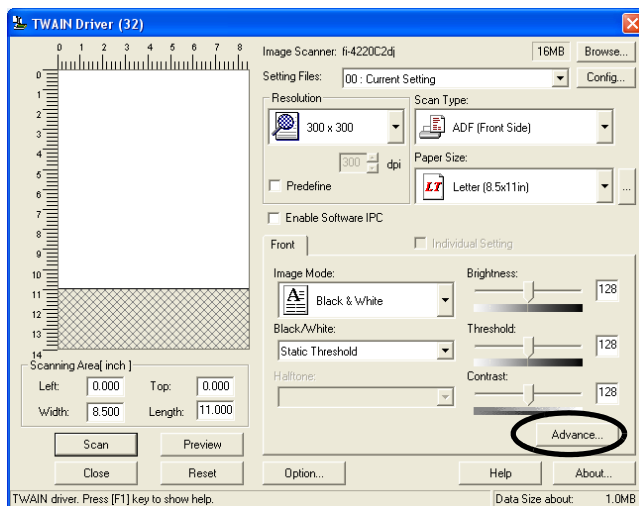

⇒ The [Advance] dialog box appears.

2. Select the color to be drop out from [Dropout Color] under [More].

For example, if the document contains black text in green frame, select [Green] so that the scanner only reads the text and eliminates the frames.

If you do not wish to have any colors dropped out select "None".

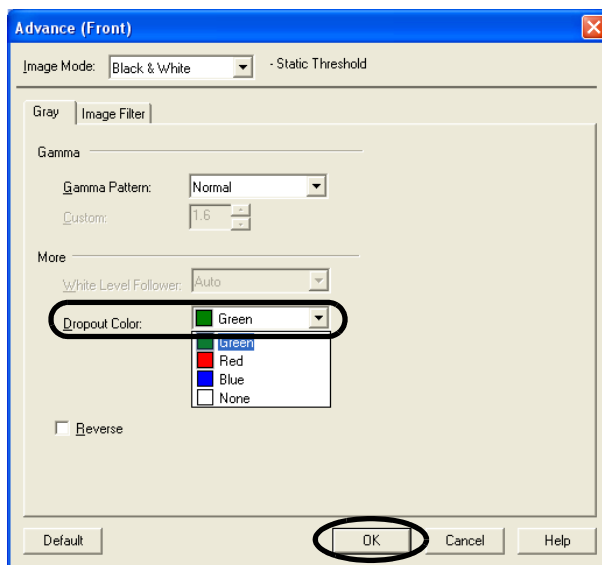

3. Click the [OK] button.

The [TWAIN Driver] dialog box will be redisplayed. Continue scanning from this dialog box.

2.8 Skipping blank pages

Change settings in the [TWAIN Driver] dialog box for skipping blank pages at scanning documents.

1. Click [Option] button in the [TWAIN Driver] dialog box.

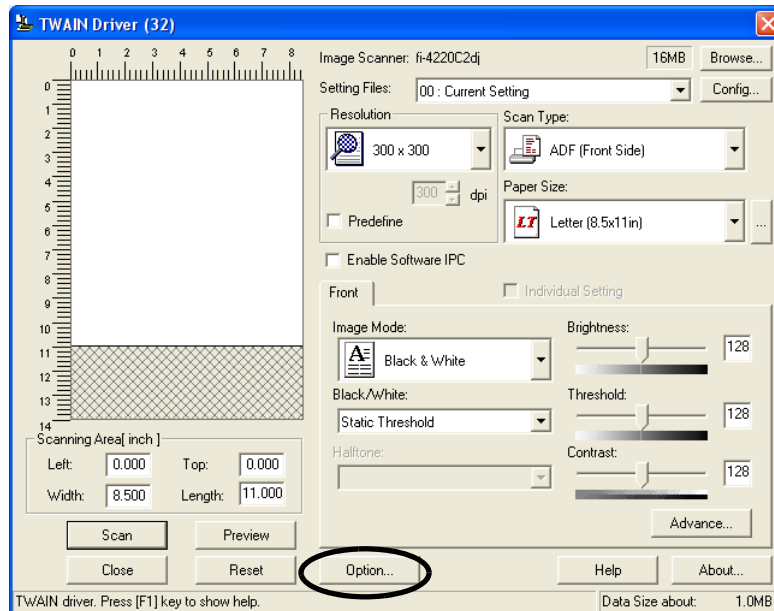

⇒The [Option] dialog box appears.

2. Click the [Job/Cache] tab.

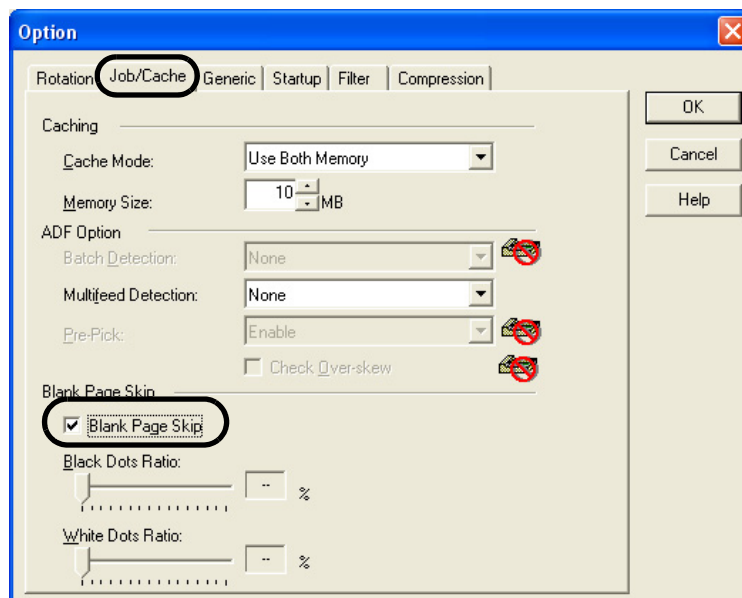

3. Check the [Blank Page Skip] box.

If an item other than “Ram cache” or “Use Both Memory” has been selected in the [Cache Mode:] and this check box is marked, it will change to “Ram cache”.

4. With the slider control under [Blank Page Skip], specify the Blank Page Skip degree.

<In Binary/Halftone mode>

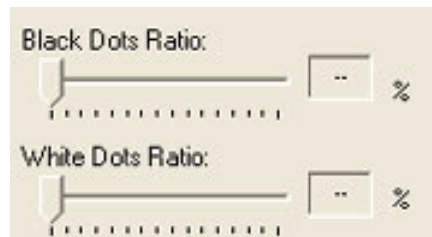

For white pages, use the [Black Dots Ratio] slider bar to set the skip condition. For black pages, use the [White Dots Ratio] scroll bar to set the skip condition.

The value displayed to the right of the scroll bar displays the noise ratio(*1). If a scanned document is below this value, it is recognized as a blank page. The setting range is OFF(-) and 0.2% to 3.0% (in increments of 0.2%).

*1: Ratio of black dots included in the scanning area. (for white pages)

<In Color/Grayscale mode>



Use the slider bar to set the skip condition in five stages from 1 to 5. To make the blank pages easy to skip, increase the value of the setting.

2.9 Detecting Multi feeds

"Multi feed" is a feeding error that occurs when two or more sheets in the ADF paper chute are fed simultaneously into the scanner.

You can set the scanner to detect multi feed, stop scanner operation, and display an error message. To set the scanner to detect multi feed, change the settings in the [TWAIN Driver] dialog box.

1. Click the [Option...] button in the [TWAIN Driver] dialog box.

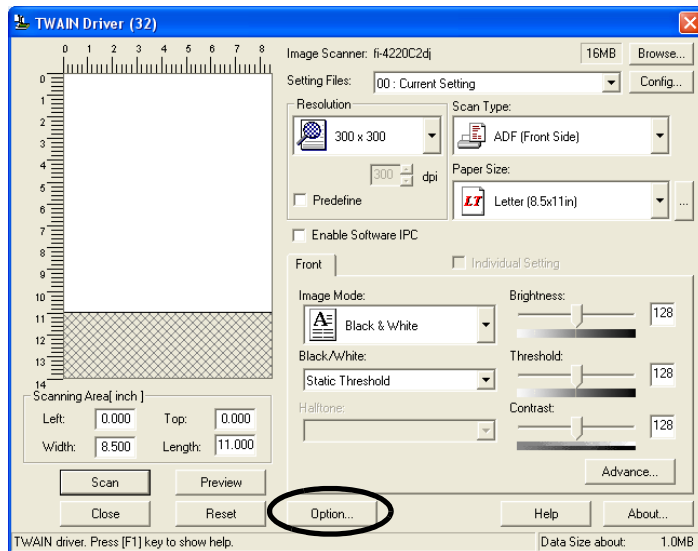

⇒ The [Option] dialog box appears.

2. Click the [Job/Cache] tab.
3. Select the detection conditions from "Multi Feed Detection" under "ADF Option".

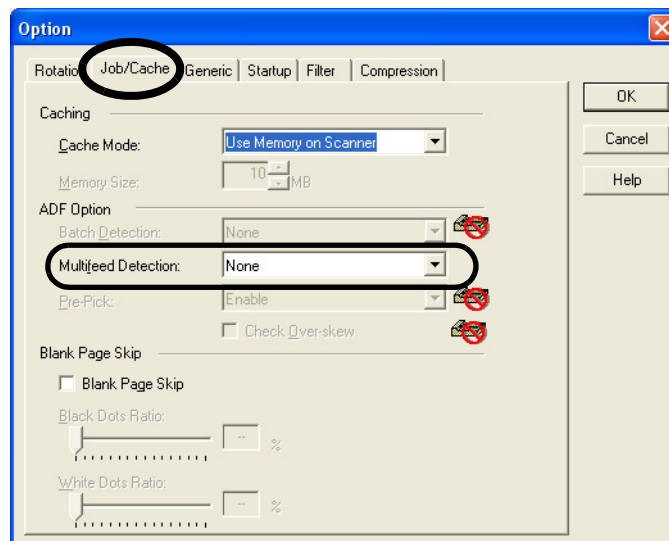

The following detection conditions are provided:

- None : Multi feed detection is not performed.
- Check thickness : The scanner monitors the thickness of documents. It detects a multi feed by differences in document thickness when two or more document sheets are fed overlapping.
- Check length : The scanner monitors the length of documents. It detects a multi feed by changes in the document length when two or more document sheets are fed overlapping.
- Check thickness and length:
The scanner monitors both document thickness and length to detect multi feed.

Furthermore, see "6.5 Multi feed Detection Conditions" (page. 99) for detailed information about the document for multi feed detection.

4. Click the [OK] button.

The display returns to the [TWAIN Driver] dialog box. Continue scanning from this dialog box.

2.10 Correcting skewed documents

You can set the scanner so that skew of documents are detected and corrected automatically when skewed documents are fed into the ADF. Change the setting in the [TWAIN Driver] dialog box to enable this function. The following shows the procedure for changing the setting in the dialog box:

1. Click [Option] button in the [TWAIN Driver] dialog box.

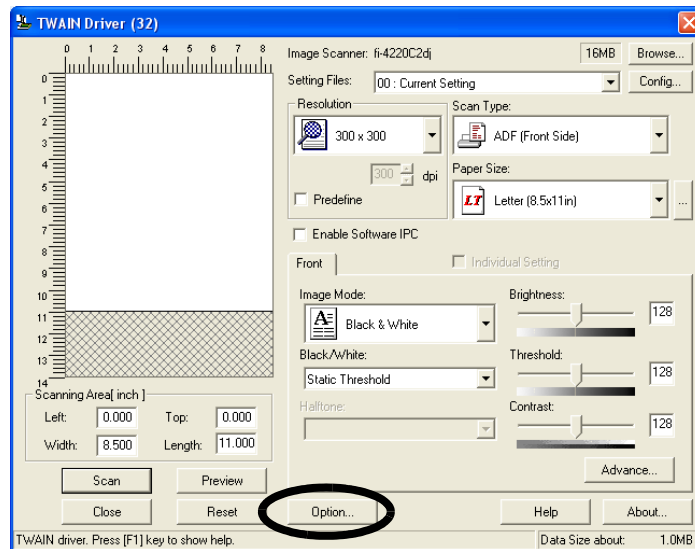

⇒ The [Option] dialog box appears.

2. Click the [Rotation] tab.
3. Select the [Automatic page size detection] from the [Automatic Size and Skew Detection] menu.

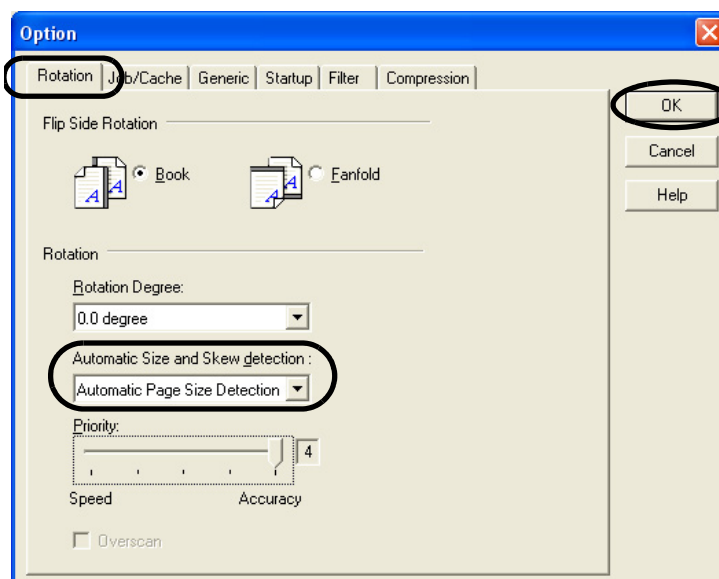

4. Click the [OK] button. The display returns to [TWAIN Driver] dialog box. Perform the scanning operation on the dialog box.



With [Priority] slider control, you can change accuracy of Automatic Page Size Detection. Move the slider to the right when improving the detection accuracy. (Note that higher accuracy setting requires much more processing time and scanning speed becomes slower.)

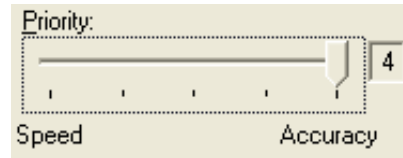

When using either of the following documents, the automatic page size detection may not function correctly:

- Paper of weight 52g/m² or less
- Not rectangular documents
- Documents which their edges are filled

Chapter 3



DAILY CARE

This chapter describes how to clean the scanner.



When operating the scanner, the ADF's glass becomes very hot.
Before you clean inside the scanner, turn off its power and unplug the AC adapter from the outlet. Wait for at least 15 minutes.
Do not turn off the scanner when you clean the Feed rollers

3.1 Cleaning Materials and Locations requiring Cleaning	50
3.2 Cleaning the Flatbed	51
3.3 Cleaning the ADF	53

3.1 Cleaning Materials and Locations requiring Cleaning

■ Cleaning Materials

The table below shows the cleaning materials that are used on this scanner.

Cleaning Materials	Part No.	Remarks
Cleaner F1 (or isopropyl alcohol) 	CA99501-0013	1 bottle (100 ml) Moisten cloth with this fluid and wipe the scanner clean.
Soft, dry cloth	-	-

For details on Cleaner F1, consult the agent where you bought your scanner.

■ Locations and Cycle for Cleaning

Location	Standard Cleaning Cycle
Pad ASSY	Clean every 1000 scanned sheets.
Pick roller	
Feed roller	
Plastic roller	
Glass	
Document holding pad	
Document bed	



The scanner must be cleaned more frequently when the following documents are used:

- Documents of coated paper
- Documents with printed text or graphics almost covering the entire surface
- Chemically treated documents such as carbonless paper
- Documents containing a large amount of calcium carbonate
- Documents with Handwritten documents



3.2 Cleaning the Flatbed



Detergent for cleaning windows or glass cleaner can be used instead of cleaning fluid. However, do not use paint thinner or other organic solvents.

■ Cleaning the Flatbed

The following parts need to be cleaned in the Flatbed area:

- Document holding pad
- Document bed

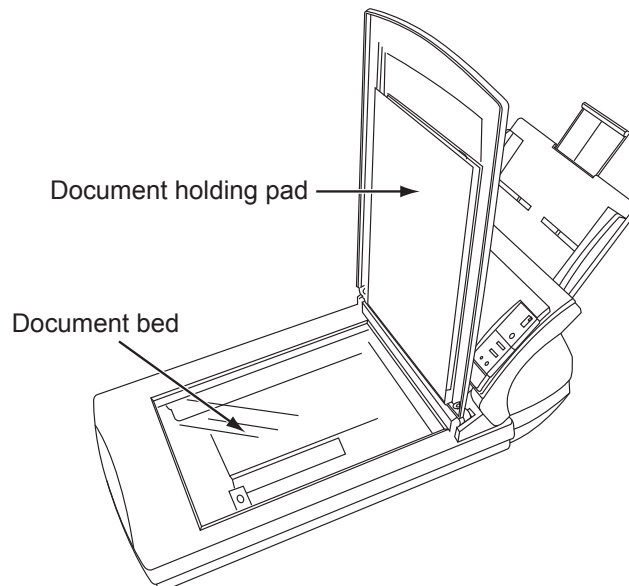

3.3 Cleaning the ADF

As a Guideline, clean the ADF every 1,000 scanned sheets. Note that this guideline varies according to the type of documents you scan. For example, it may be necessary to clean the ADF more frequently if documents are scanned when the toner is not sufficiently fixed on the printout.



- The glass surface of the ADF becomes hot during the operation of the scanner. Before you start to clean the inner parts of the scanner, disconnect the AC adapter from the power outlet, and wait at least 15 minutes to let the glass cool down.
- When you perform cleaning, make sure that the inside of the scanner is free of any foreign object, and be careful not to get your hand or the cloth caught on the pick spring (metal part) as a deformed pick spring (metal part) may cause injury.

■ Cleaning the ADF

1. Open the ADF by pushing on the ADF button and turning the ADF cover to the front.

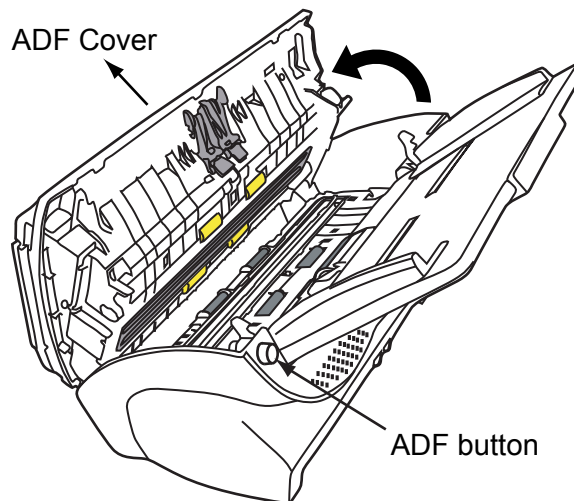

Be careful, the ADF cover may close and pinch your finger.

2. Clean the following locations with a soft, dry cloth moistened with Cleaner F1.

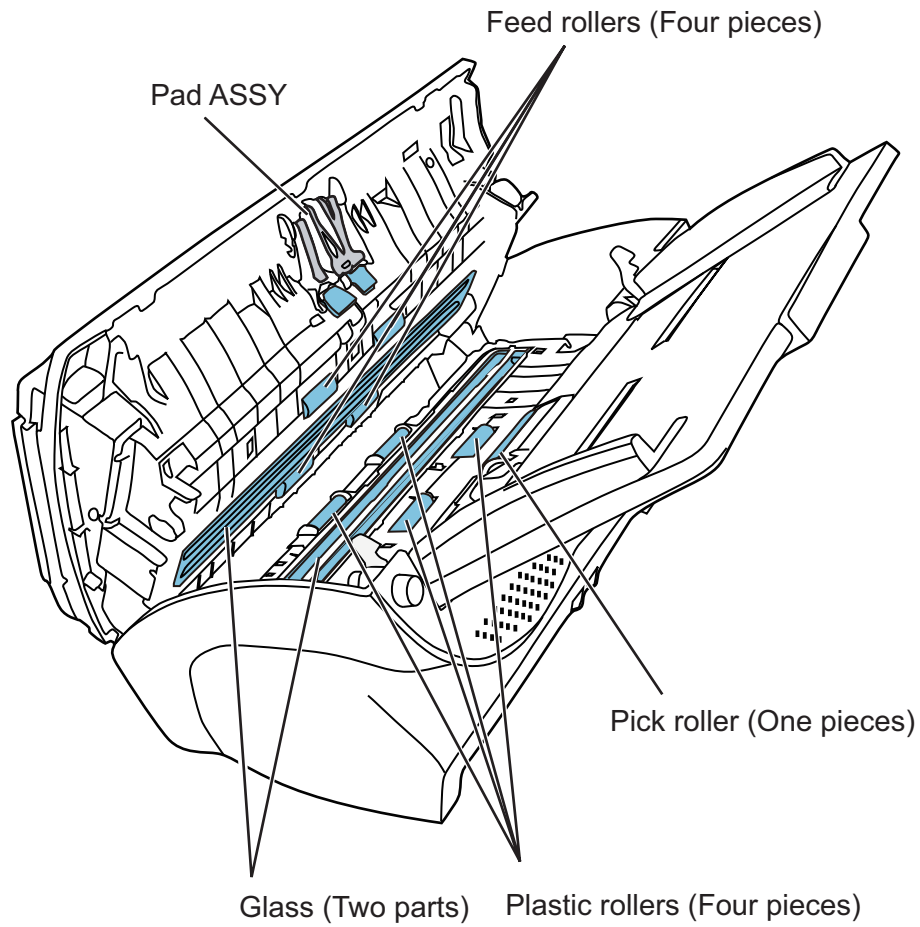

- Pad ASSY

Wipe the pad assy downwards. When cleaning the pad assy, be careful not to get your hand or the cloth caught on the pick spring (metal part).

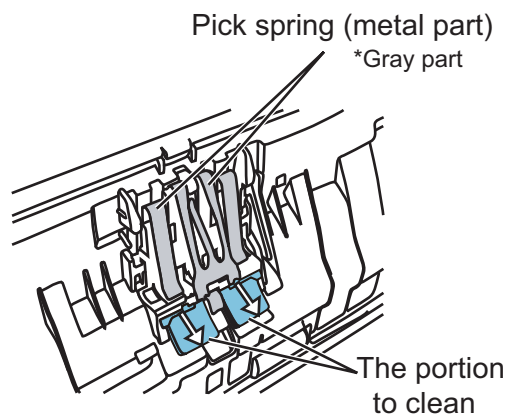

- Pick roller

In step 2, all the Feed rollers turn at the same time. When cleaning the Feed rollers positioned in the lower part of the ADF, be careful not to touch the other Feed rollers.

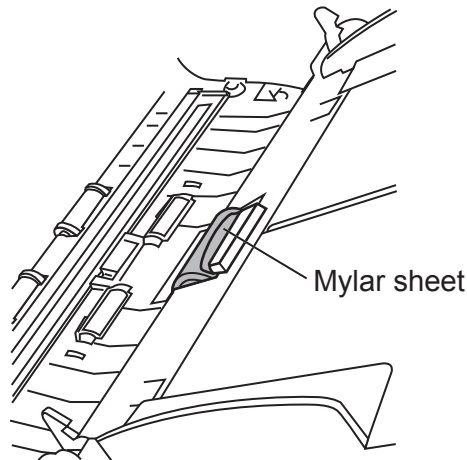

- Feed roller

- 1) Open the ADF by pushing on the ADF button.

If you open the ADF cover when the indication of the Function Number display is "P" or "0", the Feed rollers do not rotate even you perform the operation of step 2) below. So open the ADF cover when the indication is not "P" or "0".

- 2) Simultaneously hold down the "Send to" and "Scan" buttons on the operator panel. The Feed rollers start to rotate slowly. The location of "Send to" and "Scan" buttons are shown in the following illustration.

- 3) Hold a soft, dry cloth moistened with cleaning fluid against the surface of the rotating Feed rollers so that it lightly cleans the surface of the rollers. Take particular care when cleaning these rollers as black debris matter on these rollers affects document pick performance.

As a guideline, seven presses of the "Send to" and "Scan" buttons make the Feed rollers to rotate one full turn.

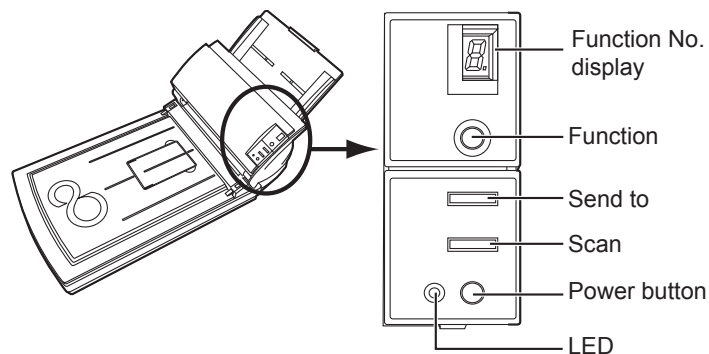

- Plastic roller

Clean lightly the surface of these rollers to avoid damaging it. Take particular care when cleaning these rollers as black debris matter on it affects document pick performance. Be careful not to damage the sponges beside the rollers.



In step 2, all the Feed rollers turn at the same time. When cleaning the Feed rollers positioned in the lower part of the ADF, be careful not to touch the other Feed rollers.

- Glass

Clean lightly.



If the glass is dirty, vertical black streaks may appear in the scanned images.

3. Press down on the center of the ADF to return it to its original position until the ADF button locks.

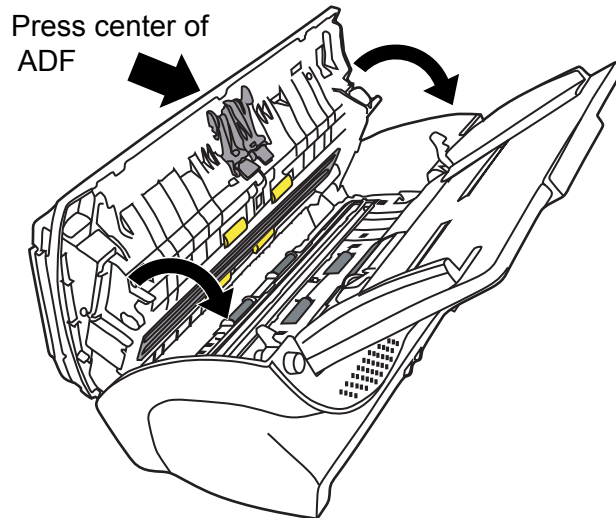

When the ADF has returned to its original position, make sure that it is completely closed. Paper jams or feeding errors may occur if the ADF is not closed completely.

Chapter 4



REPLACING CONSUMABLES

This chapter describes how to replace scanner consumables.

In this chapter Windows XP screenshots are illustrated.

The screens and operations may differ slightly if the OS that you are using is other than Windows XP.

Also, when FUJITSU TWAIN32 or FUJITSU ISIS is updated the screens and operations noted in this chapter will differ slightly.



When operating the scanner, the ADF's inside glass becomes very hot.

Before you replace the consumables, turn off its power and unplug the AC adapter from the outlet. Wait for at least 15 minutes.

4.1 Consumable and Replacement Cycle	58
4.2 Replacing the Pad Assy.....	63
4.3 Replacing the Pick Roller	66

■ Guidelines for Consumable Replacement Cycle

With this product, you can learn how many times the consumables are used so that you can estimate the right timing for the replacement.

- **For Windows 98 / Windows Me / Windows 2000 / Windows XP**

1. When turning on the power, check that the scanner is connected to the PC.
Refer to "2.2 Connecting the Scanner to a PC" in fi-4220C2 Getting Started on the Setup CD-ROM for information about connecting the scanner to a personal computer.
2. Double click the "Printer and Other Hardware" icon on the operator panel of the host computer.

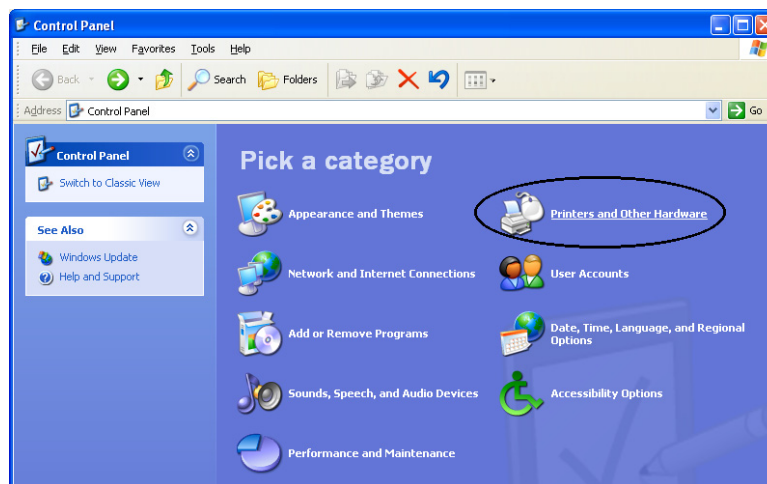

⇒ The [Printer and Other Hardware] screen is displayed.

3. In the [Printer and Other Hardware] screen, double click the "Scanners and Cameras" icon.

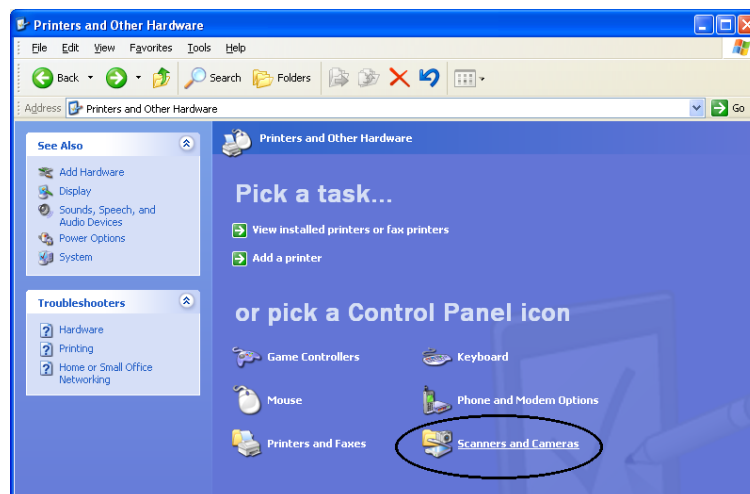

⇒ The [Scanners and Cameras] screen is displayed.

- On "fi-4220C2dj" icon, right click and select [Properties] (for Windows Me, Windows XP), or double click (for Windows 98, Windows 2000)

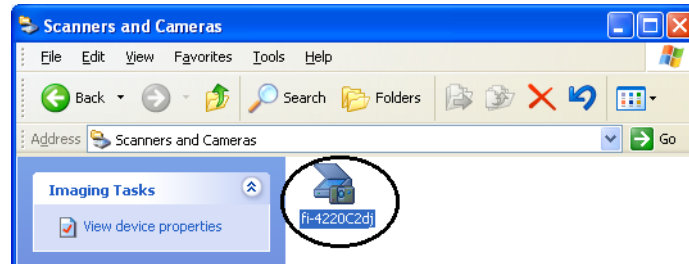

⇒ The [fi-4220C2dj Properties] dialog box appears.

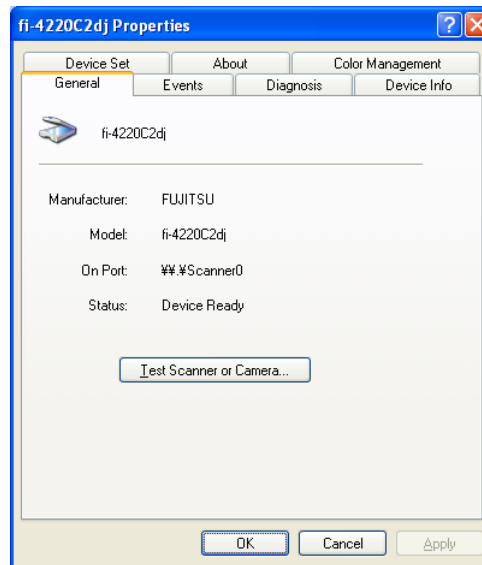

- Click the "Device Set" tab.

⇒ The following screen is displayed.

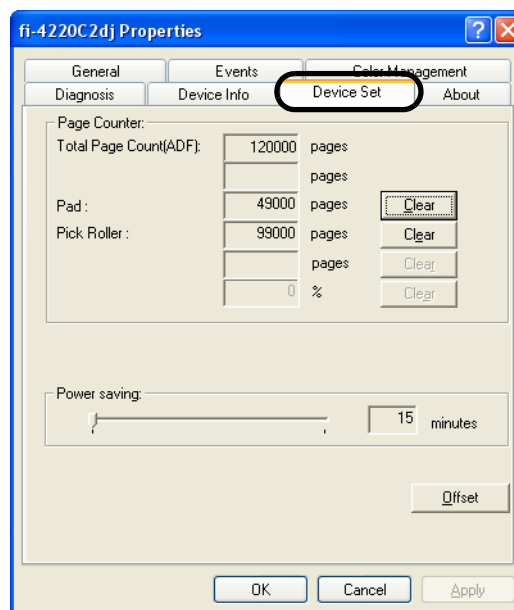

You can confirm the following information in this panel:

- Total number of scans
- Pad counter (approximate number of scans after resetting the pad counter)
- Pick roller counter (approximate number of scans after resetting the Pick roller counter)

- **For Windows 95 / Windows NT 4.0**

1. When turning on the power, check that the scanner is connected to your PC.
2. Right click the "FUJITSU Scanner Control Center" icon displayed in the task tray, then select "Option".
3. Click "Device Setting" tab.
⇒The following screen is displayed.

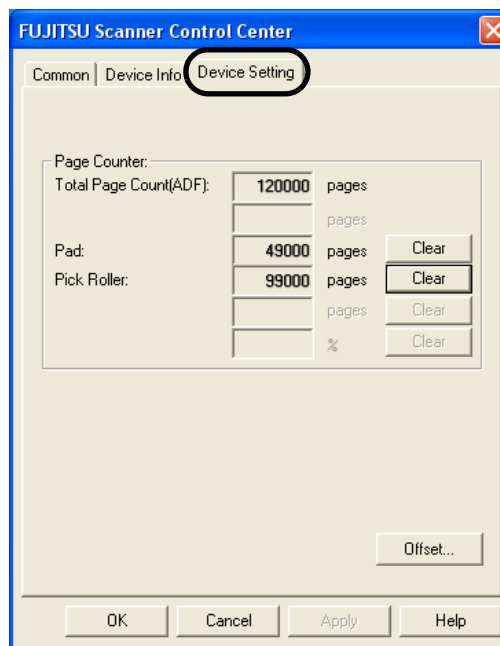

You can confirm the following information in this panel:

- Total number of scans
- Pad counter (approximate number of scans after resetting the pad counter)
- Pick roller counter (approximate number of scans after resetting the Pick roller counter)

The following message sometimes appears when the scanner is being used:

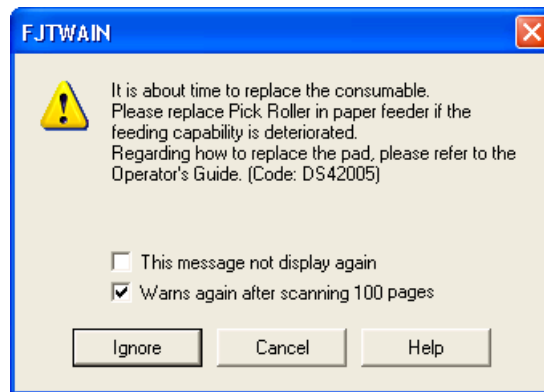

Replace consumables when this message is displayed.

■ When Replacing Consumables Immediately

1. To replace consumables after completing the scanning of all the document sheets in the ADF, click the [Ignore] button.
To abort scanning and replace the consumables immediately, click the [Cancel] button.
2. Replace the consumables.
For details on how to replace consumables, see "4.2 Replacing the Pad Assy" (page. 63) and "4.3 Replacing the Pick Roller" (page. 66).
3. To disable display of this message, mark the "This message not display again" checkbox.
Note that when the "This message not display again" checkbox is marked, this message is not displayed until the consumables counter is reset.

■ When Consumables Cannot Be Replaced Immediately

1. To continue scanning of the current document, click the [Ignore] button.
To discontinue scanning, click the [Cancel] button.
2. Replace the consumable as soon as possible.
For details on how to replace consumables, see "4.2 Replacing the Pad Assy" (page. 63) and "4.3 Replacing the Pick Roller" (page. 66).
3. To disable display of this message, mark the "This message not display again" checkbox.
Note that when the "This message not display again" checkbox is marked, this message is not displayed until the consumables counter is reset.
To display the message again after scanning 100 sheets, mark the [Warns again after scanning 100 pages] checkbox.

4.2 Replacing the Pad Assy

1. Remove any documents on the ADF paper chute.
2. Open the ADF by pushing the ADF button.

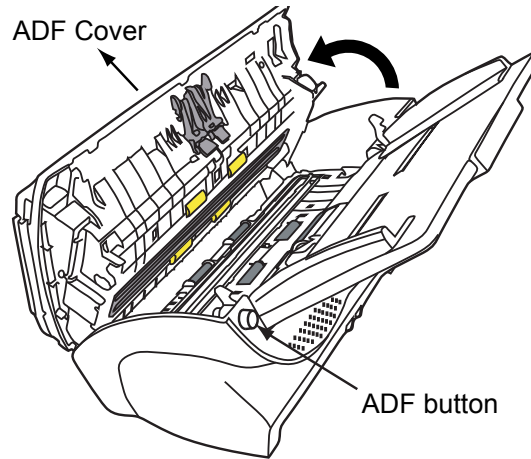

Be careful, the ADF cover may close and pinch your finger.

3. Remove the Pad ASSY.

Press the knobs on both ends of the Pad ASSY, and pull the Pad ASSY upwards and towards you.

When doing this, take care not to catch the pick springs.

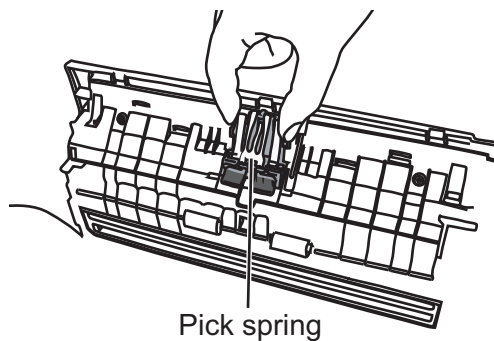

4. Attach the new Pad ASSY.

Hold both ends of the new Pad ASSY and attach it to its installation location.

When doing this, take care not to catch the pick springs.



Make sure that the Pad ASSY is firmly attached. When the Pad ASSY is not correctly attached, document jams or other feeding errors may occur.

5. Press down on the center of the ADF to return it into its original position and lock the ADF button.

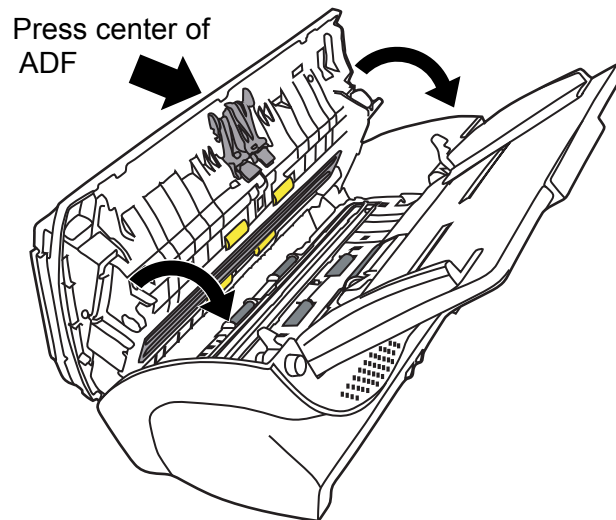

6. Reset the pad counter.
 - For Windows 98 / Windows Me / Windows 2000 / Windows XP
 - 1) When turning on the power, check that the scanner is connected to your PC.
 - 2) Open the [Scanners and Cameras] from the control panel of your PC.
 - 3) Open the [Properties] of [fi-4220C2dj] from the [Scanners and Cameras].
 - 4) The [fi-4220C2dj Properties] dialogbox appears.
 - 5) Click the "Device Set" tab.
 - ⇒ The following screen is displayed.

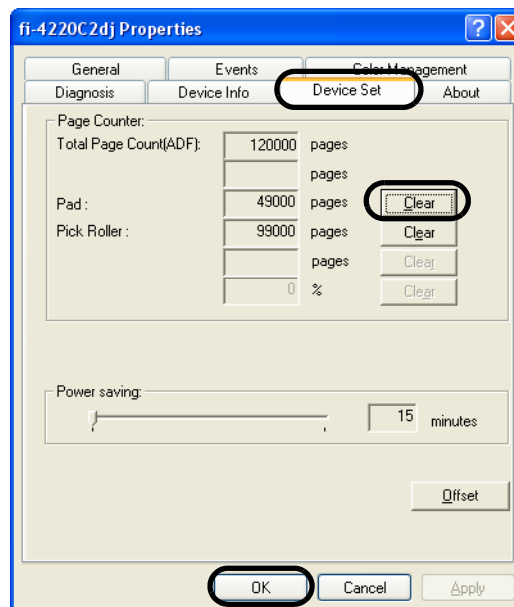

- 6) After clicking the [Clear] button beside "Pad" in "Page Counter", click the [OK] button.

⇒ The following panel appears.

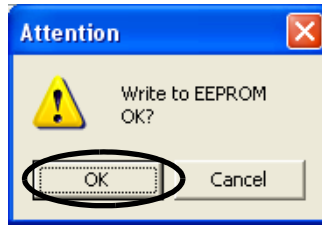

Click the [OK] button.
This returns the pick counter to "0".

- For Windows 95 / Windows NT 4.0
 - 1) When turning on the power, check that the scanner is connected to your PC.
 - 2) Right click the "FUJITSU Scanner Control Center" icon displayed in the task tray, then select "Option".
 - 3) Click the "Device Setting" tab.

⇒ The following screen is displayed.

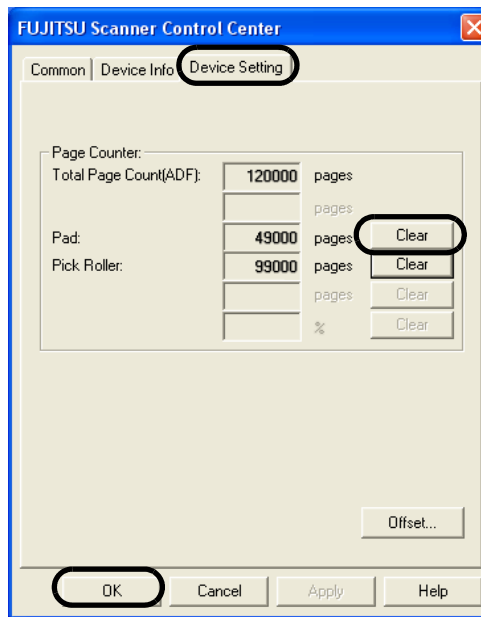

- 4) After clicking the [Clear] button beside "Pad" in "Page Counter", click the [OK] button.

⇒ The following message is displayed.

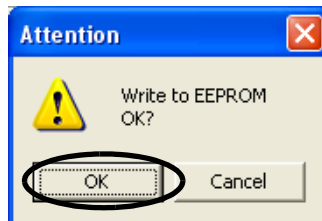

Click the [OK] button.
The Pad counter returns to "0".

4.3 Replacing the Pick Roller

1. Remove any documents on the ADF paper chute.
2. Remove the ADF paper chute.

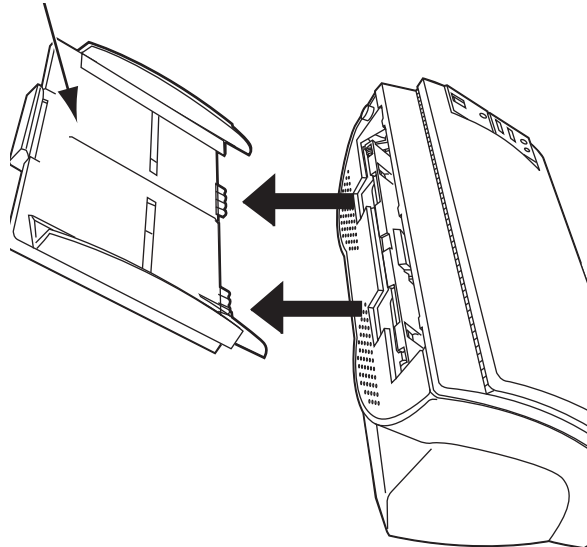

3. Open the ADF by pushing the ADF button.

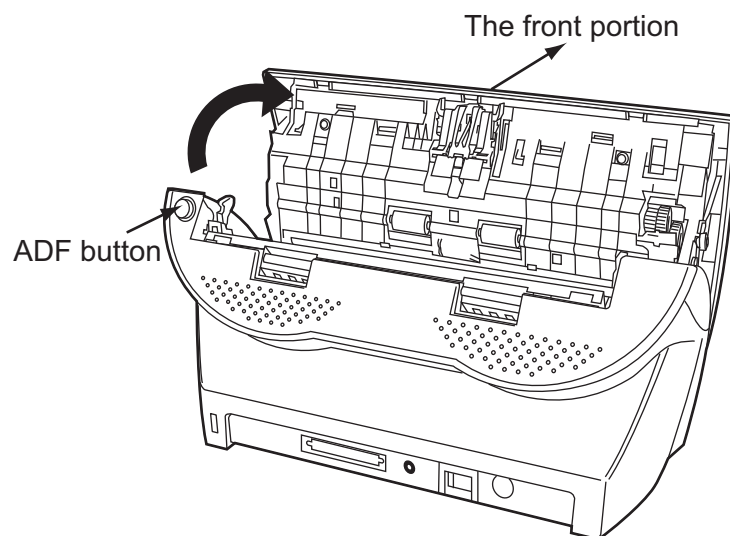

Be careful, the ADF cover may close and pinch your finger.

4. Remove the Pick roller from the scanner.

- 1) Grip the knobs on the sheet guide with your fingers, and lift it up to remove.

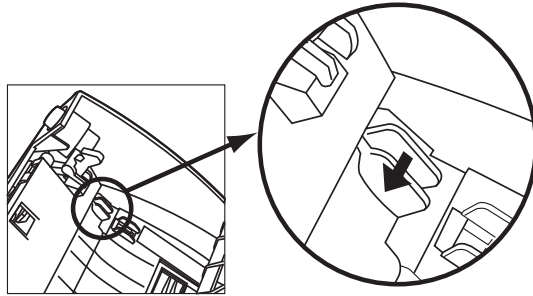

- 2) Rotate the Pick roller bushing in the direction of the arrow.

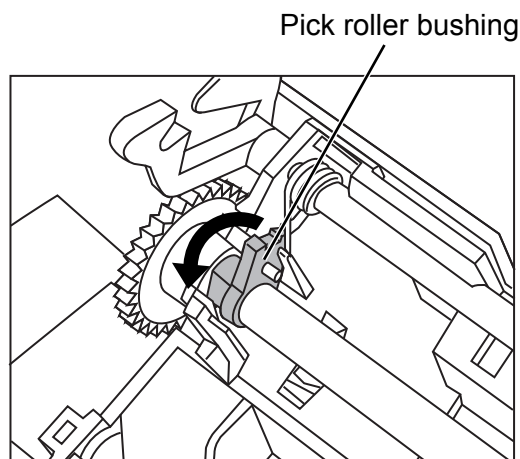

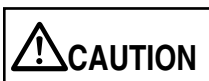
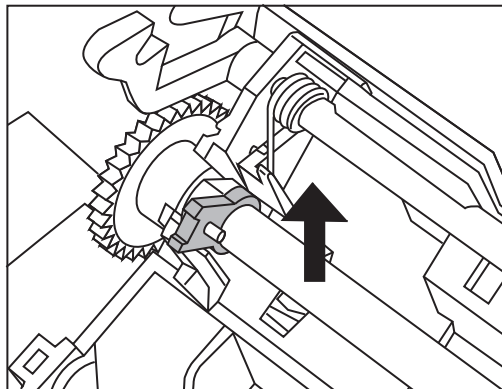

- 3) Remove the Pick roller while lifting it up in the direction of the arrow.

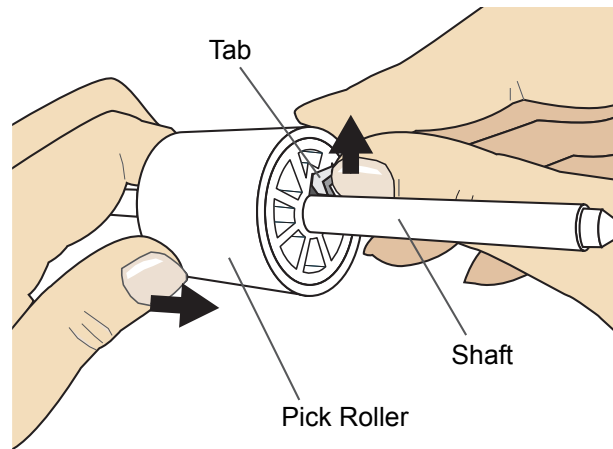

The Pick roller Bushing is hard. Do not turn this bearing with your fingernails. Use a paper clip for turning the roller bushing If you can not rotate it with your finger.

-
- Remove the Pick roller from the shaft while lifting up the tab on the Pick roller.
Pull out the shaft from the pick roller while lifting up its tab.



ATTENTION  If you push up the pick roller tab using your fingernail, it may hurt or get chipped your fingernail. If you worry about that, you push up the pick roller tab using a paper clip.

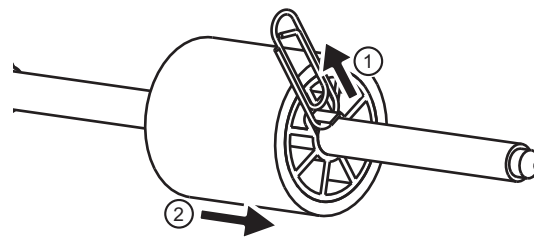

-
- Attach the new Pick roller.
Insert the new Pick roller aligning the protrusion on the shaft with the slot for the screw in the Pick roller.

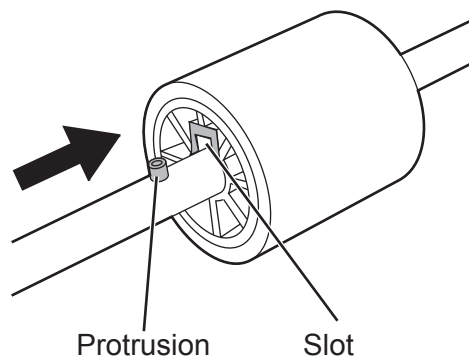



Make sure that the Pick roller is completely attached. An incompletely attached Pick roller might cause document jams or other feed errors. When attaching the Pick roller, make sure that the roller clicks in to place.

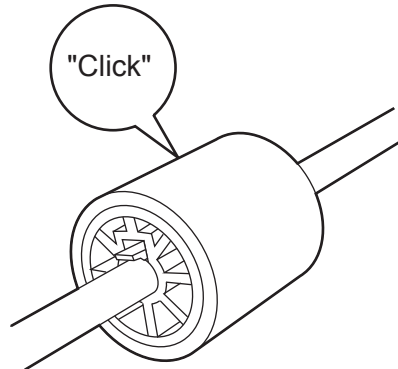

7. Attach the Pick roller to the scanner.

Attach the Pick roller to the scanner in reverse order of the procedure for removing.

- 1) Turn the Pick roller bushing in the direction indicated by the arrow.

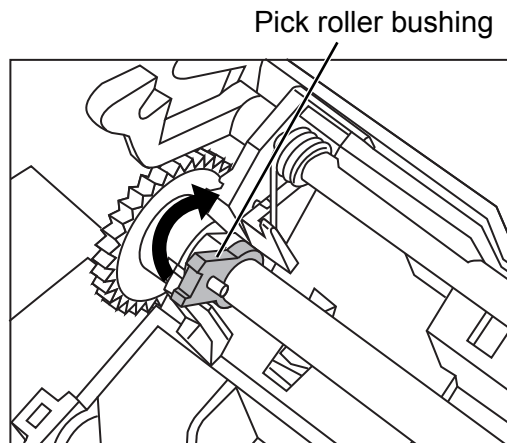

- 2) Move the sheet guide claws in the direction indicated by the arrow to fix the sheet guide.

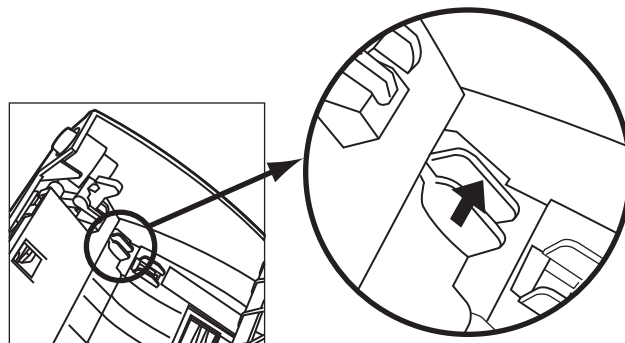

-
8. Press down the center of the ADF to return it to its original position and lock the ADF button.

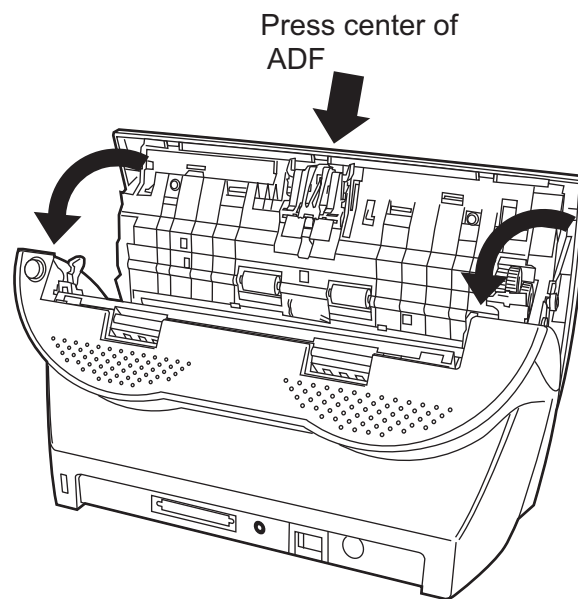

9. Attach the ADF paper chute.

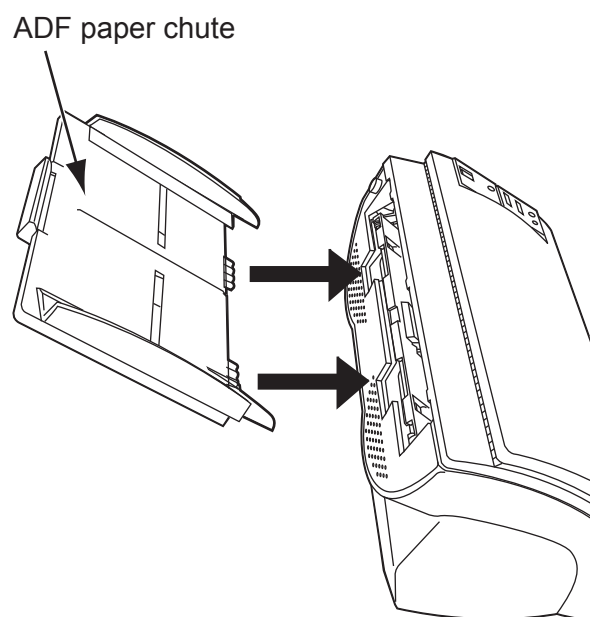

10. Reset the pick counter.

- For Windows 98 / Windows Me / Windows 2000 / Windows XP
 - 1) When turning on the power, check that the scanner is connected to your PC.
 - 2) Open the [Scanners and Cameras] from the control panel of your PC.
 - 3) Open the [Properties] of [fi-4220C2dj] from the [Scanners and Cameras].
 - 4) The [fi-4220C2dj Properties] dialogbox is displayed.
 - 5) Click the "Device Setting" tab.
 - ⇒ The following panel appears.

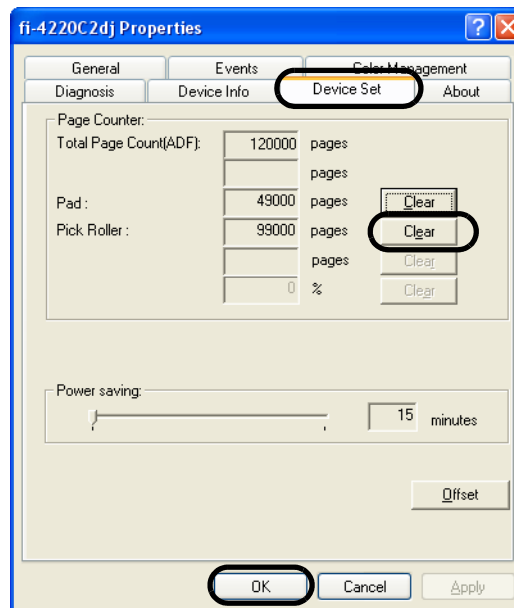

- 6) After clicking the [Clear] button beside "Pick Roller" in "Page Counter", click the [OK] button.

⇒ The following panel appears.

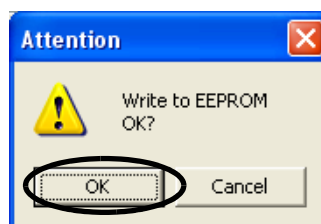

Click the [OK] button.

This returns the pick counter to "0".

- For Windows 95 / Windows NT 4.0
 - 1) When turning on the power, check that the scanner is connected to your PC.
 - 2) Right click the "FUJITSU Scanner Control Center" icon displayed in the task tray, then select "Option".
 - 3) Click the "Device Setting" tab.
⇒ The following screen is displayed.

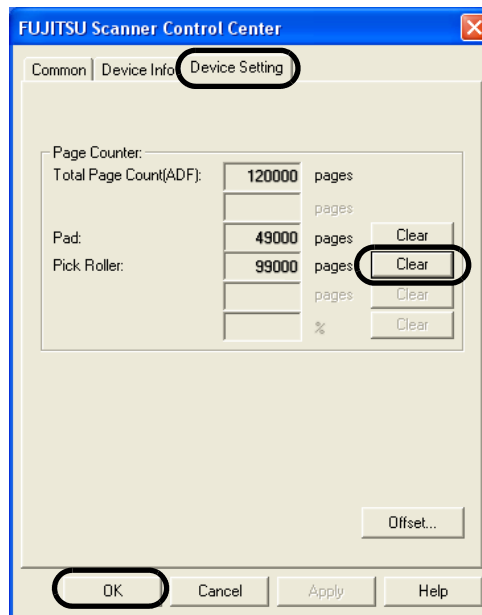

- 4) After clicking the [Clear] button beside "Pick Roller" in "Page Counter", click the [OK] button.
⇒ The following message is displayed.

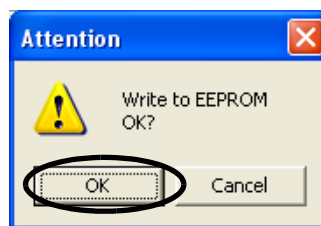

Click the [OK] button.

The Pick counter (The Pick roller counts) returns to "0".

5.1 Removing Jammed Documents

If a document jam occurred, follow the procedure below to remove the jammed documents.



- Take care not to get injured when removing jammed documents.
 - Be careful not to get neckties, necklaces, etc. entangled in the scanner when removing the jammed documents
 - The surface of the glass may become hot during operation. Take care not to get burned.
1. Remove any documents on the ADF paper chute.
 2. Open the ADF by pushing on the ADF button.

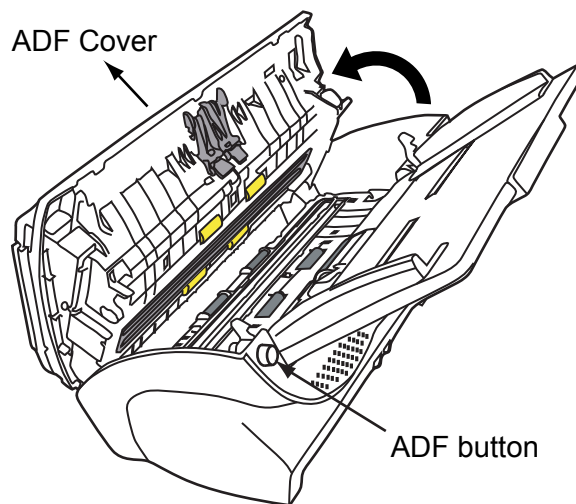

Be careful, the ADF cover may close and pinch your finger.

3. Remove the jammed document.



- Staples, paper clips, etc. cause document jams. Be sure to fully check the document and feed path, and remove any small metal objects such as these.
Also, before you start scanning, be sure to remove any staples, clips, etc. from the document.
- Take care not to pull the pick springs when removing jammed documents.

- 4. Press down on the center of the ADF to return it to its original position and lock the ADF button.

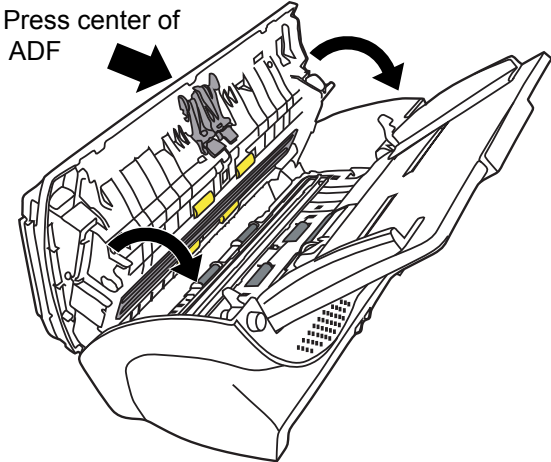

- Make sure that the ADF is completely closed. When it is not completely closed, document jams or feeding errors may occur.
- When the scanning is completed or canceled, the documents might remain inside the ADF even though any error message is not displayed.

Follow the procedure below to remove the documents remaining in the ADF.

1. Remove all documents from the ADF paper chute.
2. Open the ADF by pushing down the ADF button.
3. Remove the remaining documents.
4. Push in the center of the ADF to close it until the ADF button is locked.



If a document jam or Multi Feed errors occur frequently, follow the procedures below .

1. Align the edges of the document sheets.

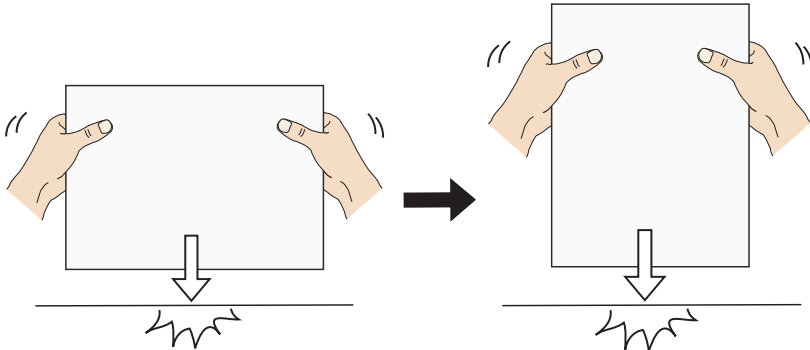

-
2. Hold both the left and right sides of the document with both hands, and, as shown below, bend the document, bring back and release one side of the stack.

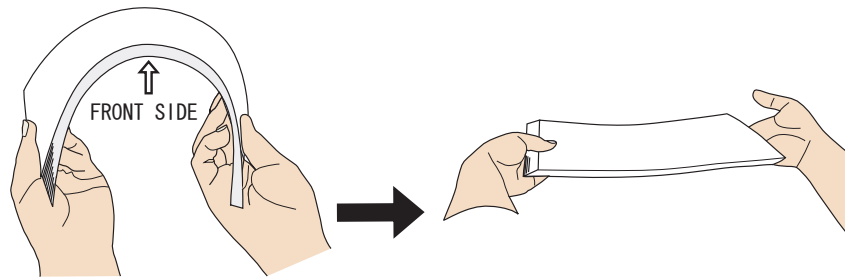

3. The document edges will be slightly misaligned, as shown in the picture.



4. Load the documents into the ADF chute, as shown in the picture.

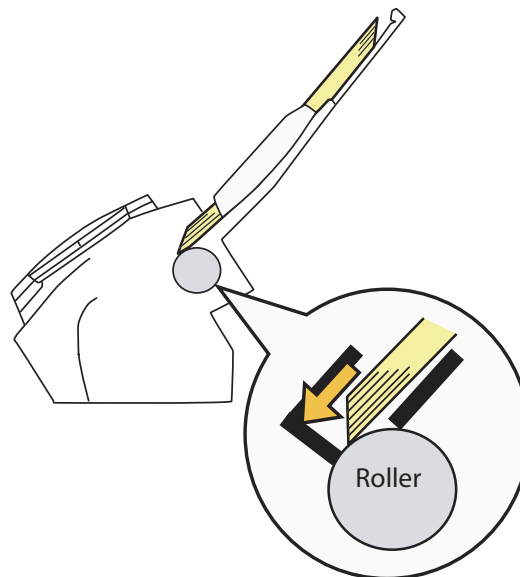

5.2 Remediating Typical Troubles

This section describes troubles that may occur during scanning and how to remedy that trouble. Before you ask for repair, check the following flowcharts.

If the remedies in these flowcharts do not solve the problem, check the items in "5.3 Items to Check Before Contacting the Agent Where You Bought the Scanner" (page. 90) and then contact the agent where you bought the scanner.

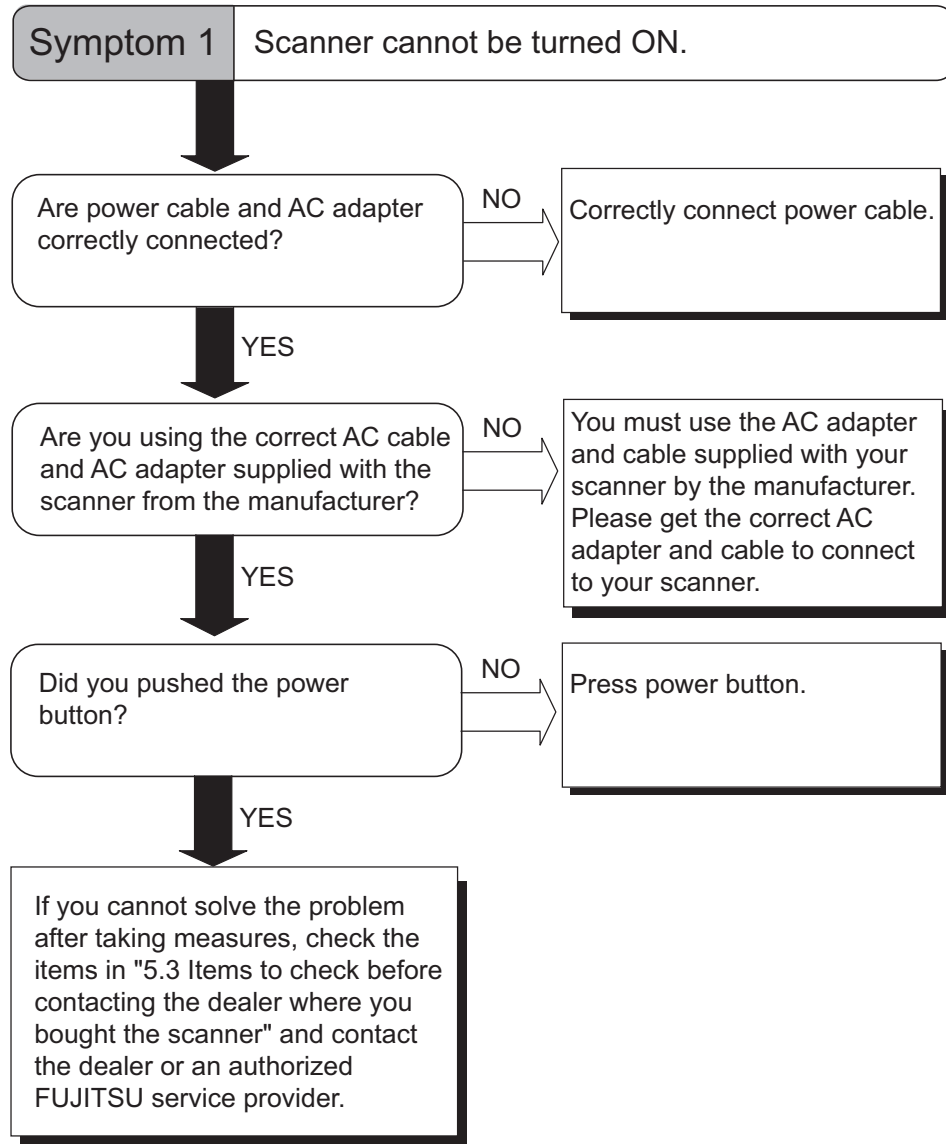

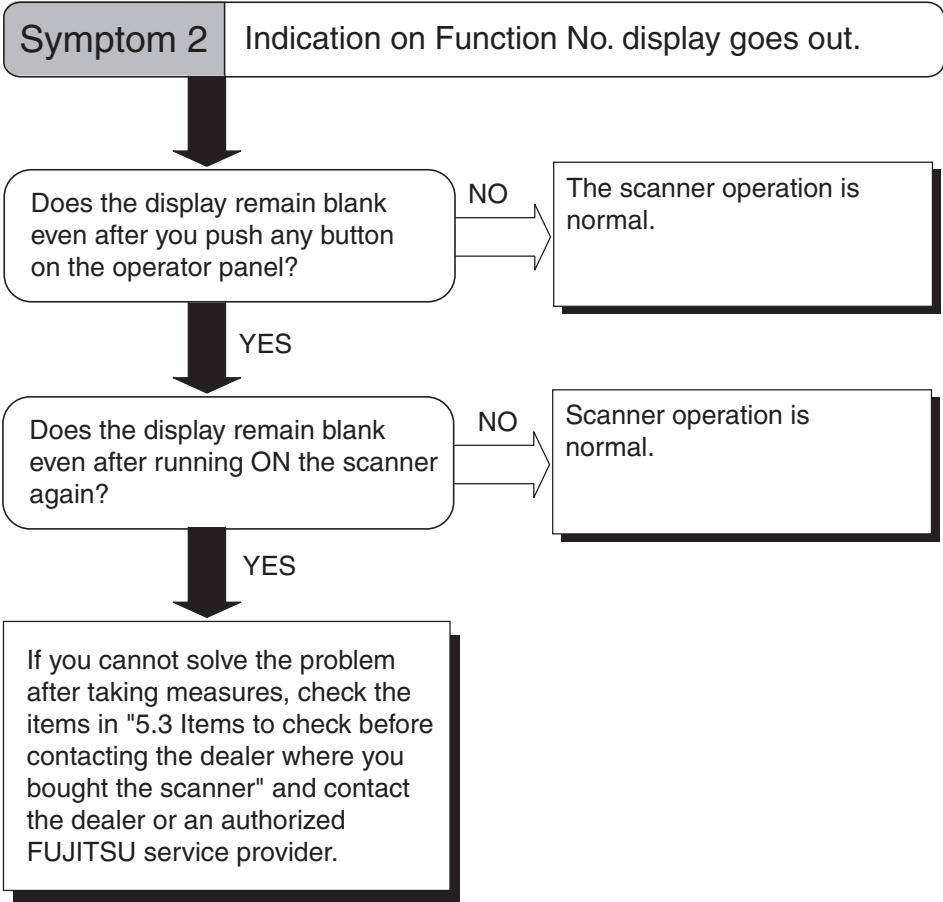

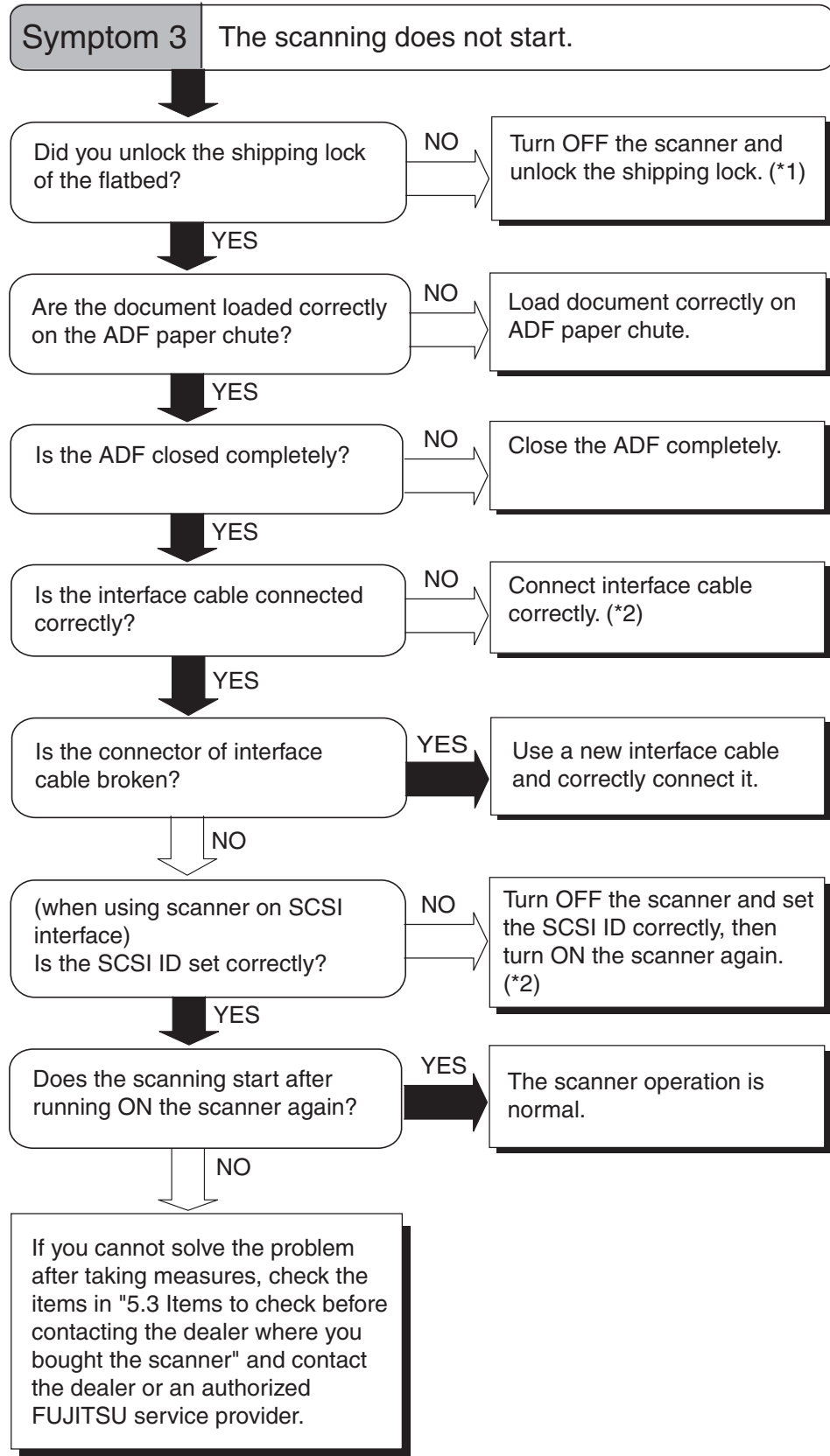

*1) For details, refer to "Getting Started" 2.1 Installing the Scanner.

*2) For details, refer to "Getting Started" 2.2 Connecting the scanner to your PC.

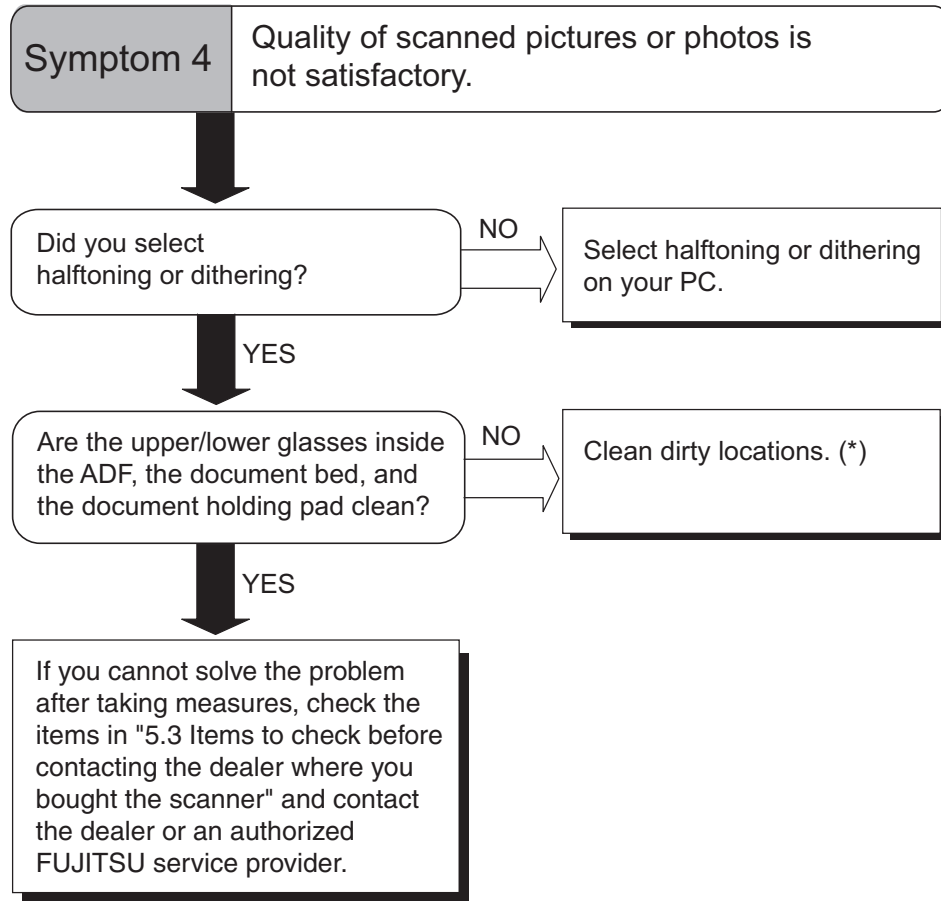

*) For details on how to clean dirty locations, see "Chapter 3 DAILY CARE" (page. 49).

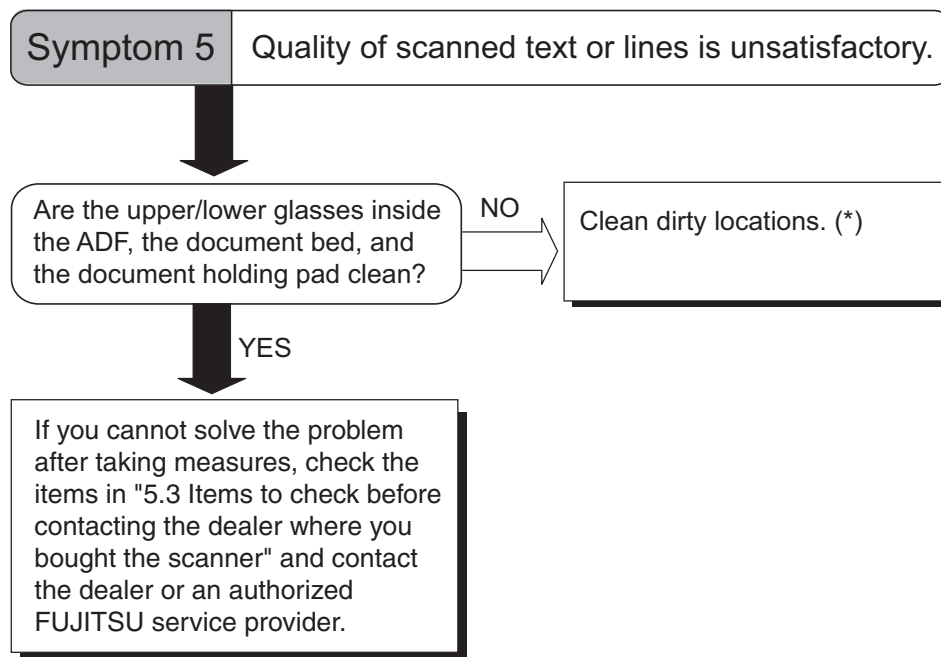

*) For details on how to clean dirty locations, see "Chapter 3 DAILY CARE" (page. 49).

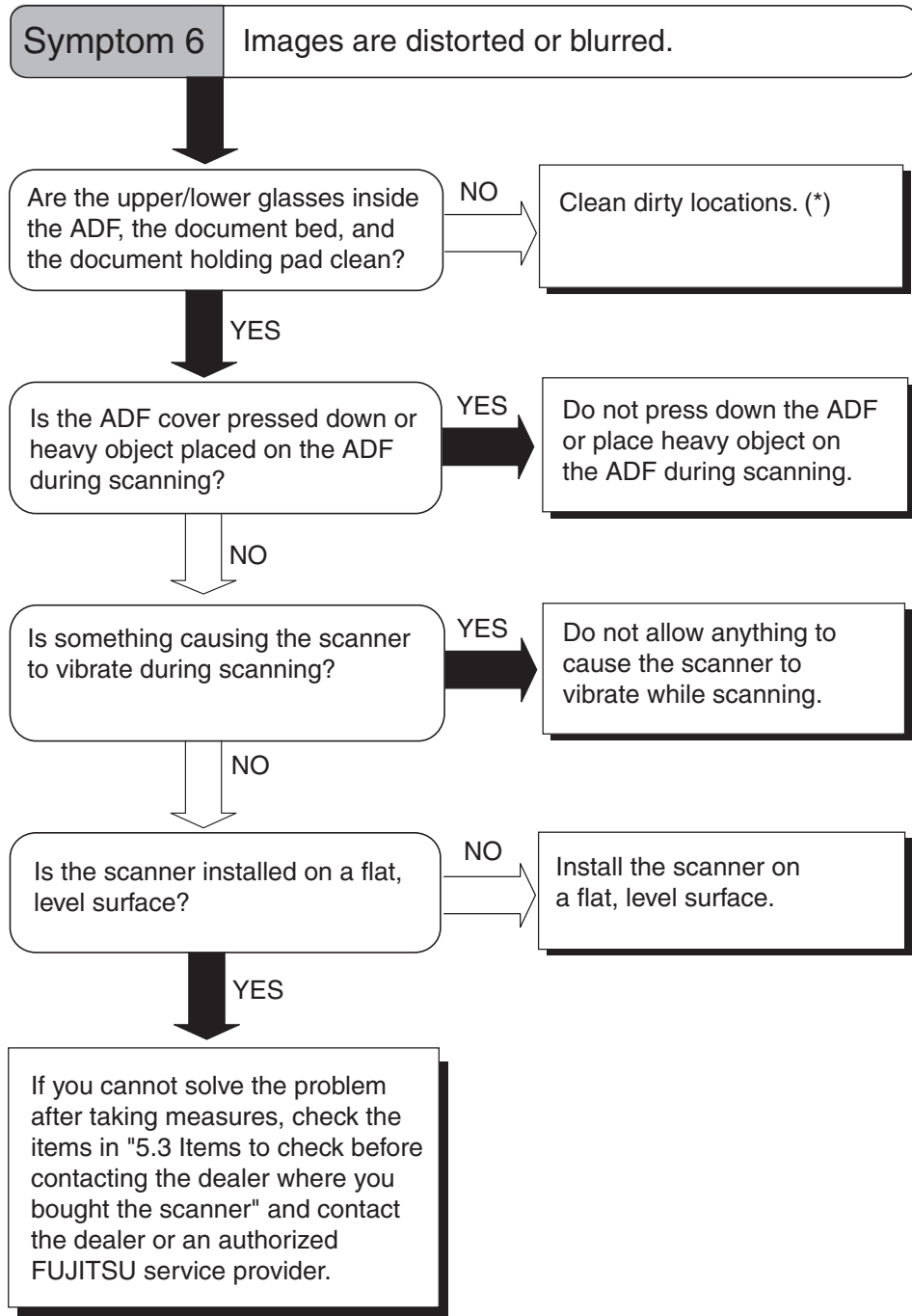

*) For details on how to clean dirty locations, see "Chapter 3 DAILY CARE" (page. 49).

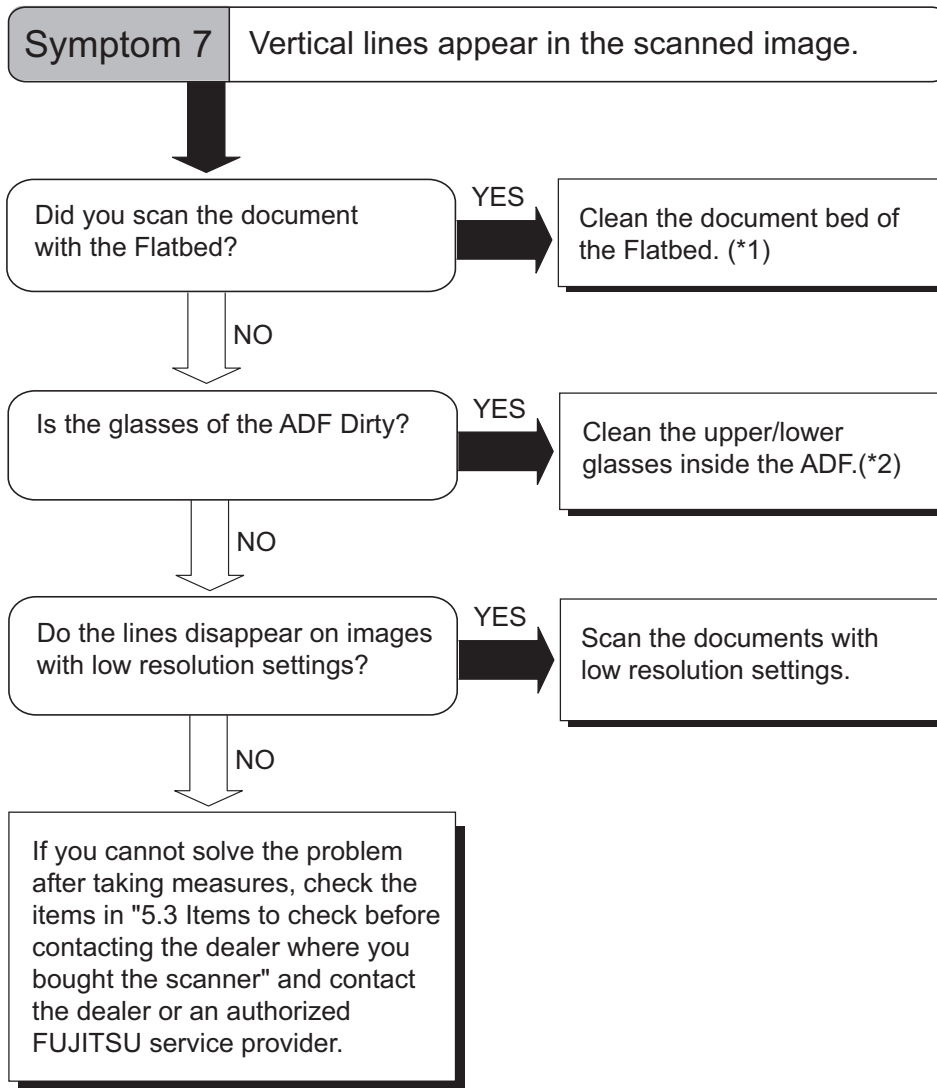

*1) For cleaning the Flatbed, refer to "3.2 Cleaning the Flatbed" (page. 51).

*2) For cleaning the inside of the ADF, refer to "3.3 Cleaning the ADF" (page. 53).

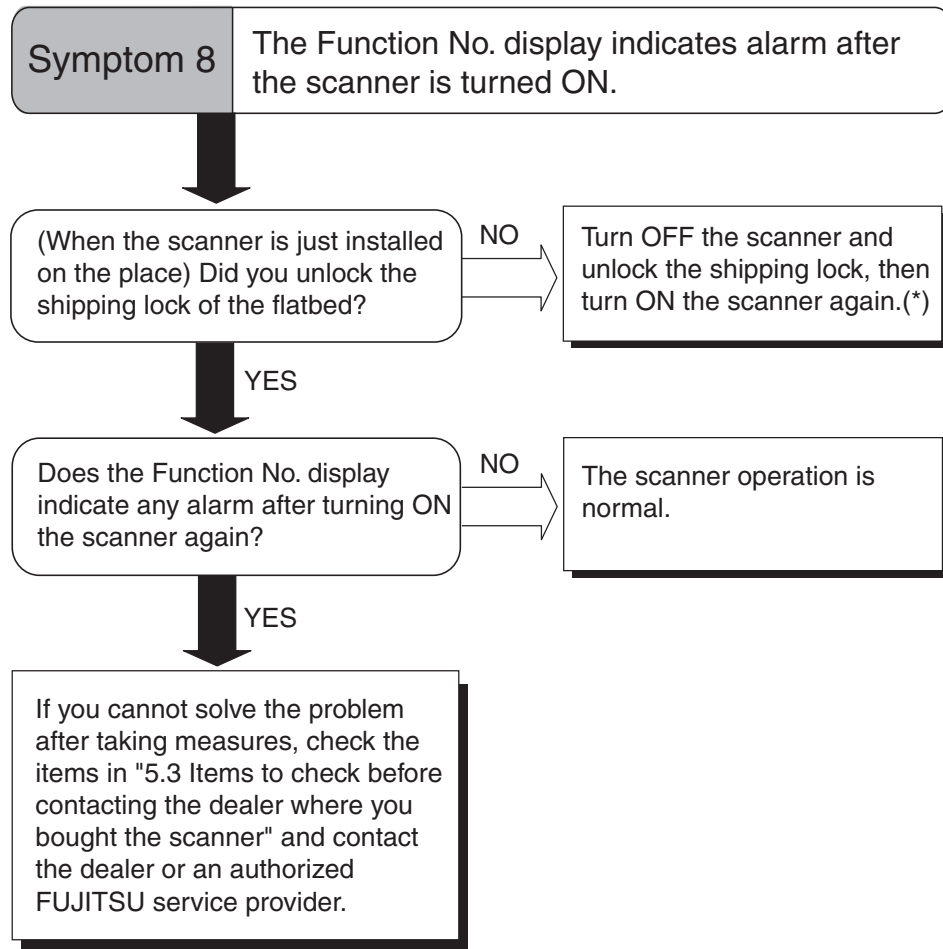

*) For details, refer to "Getting Started" 2.1 Installing the Scanner.

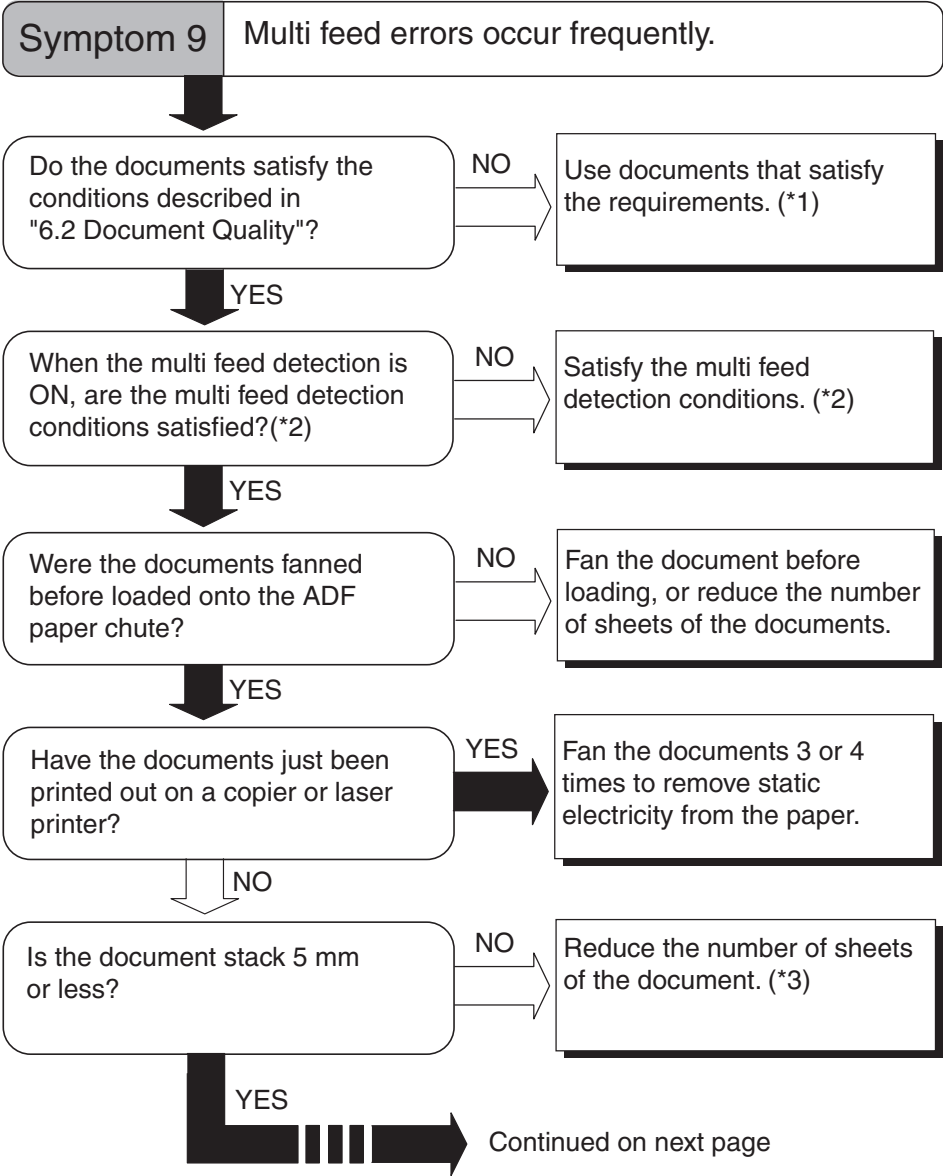

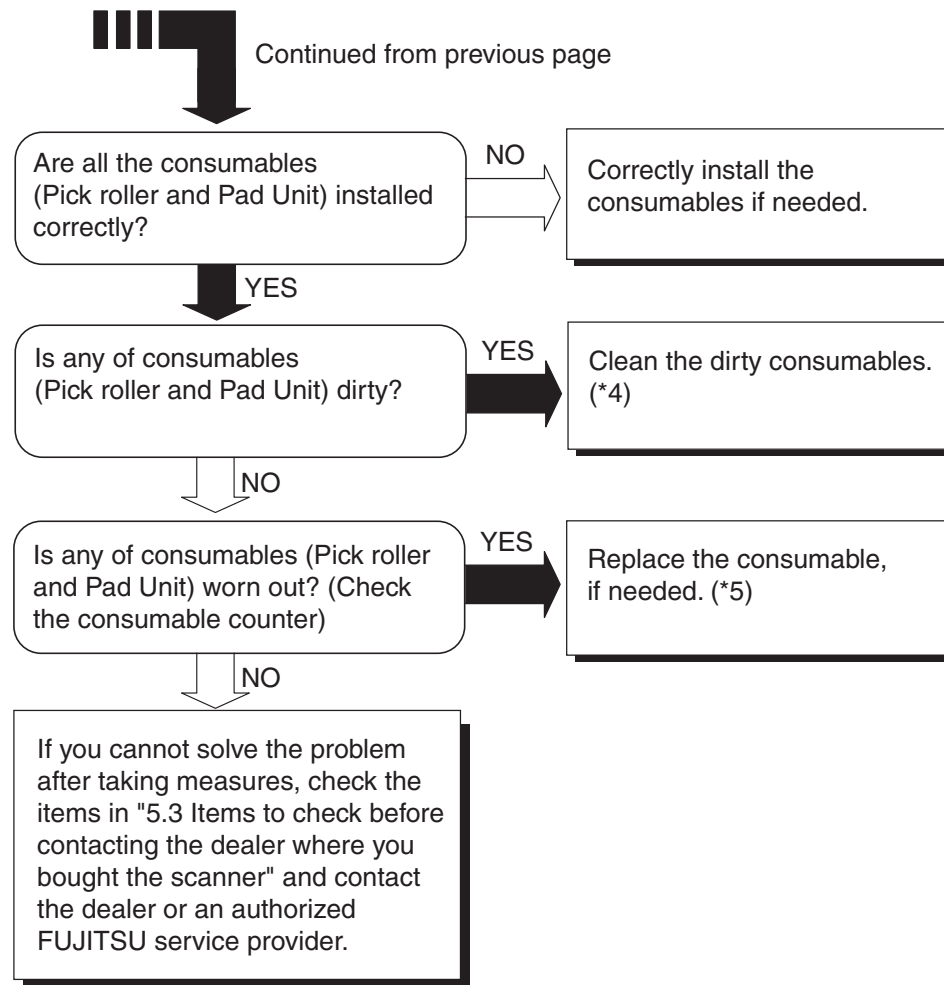

*1) For details on requirements, see "6.2 Document Quality" (page. 95).

*2) For details on multi feed, see "6.5 Multi feed Detection Conditions" (page. 99).

*3) For details on requirements, see "6.3 Maximum Document Loading Capacity" (page. 97)

*4) For details on how to clean the consumables, see "3.3 Cleaning the ADF" (page. 53).

*5) For details on how to replace and attach consumables, see "4 REPLACING CONSUMABLES" (page. 57).

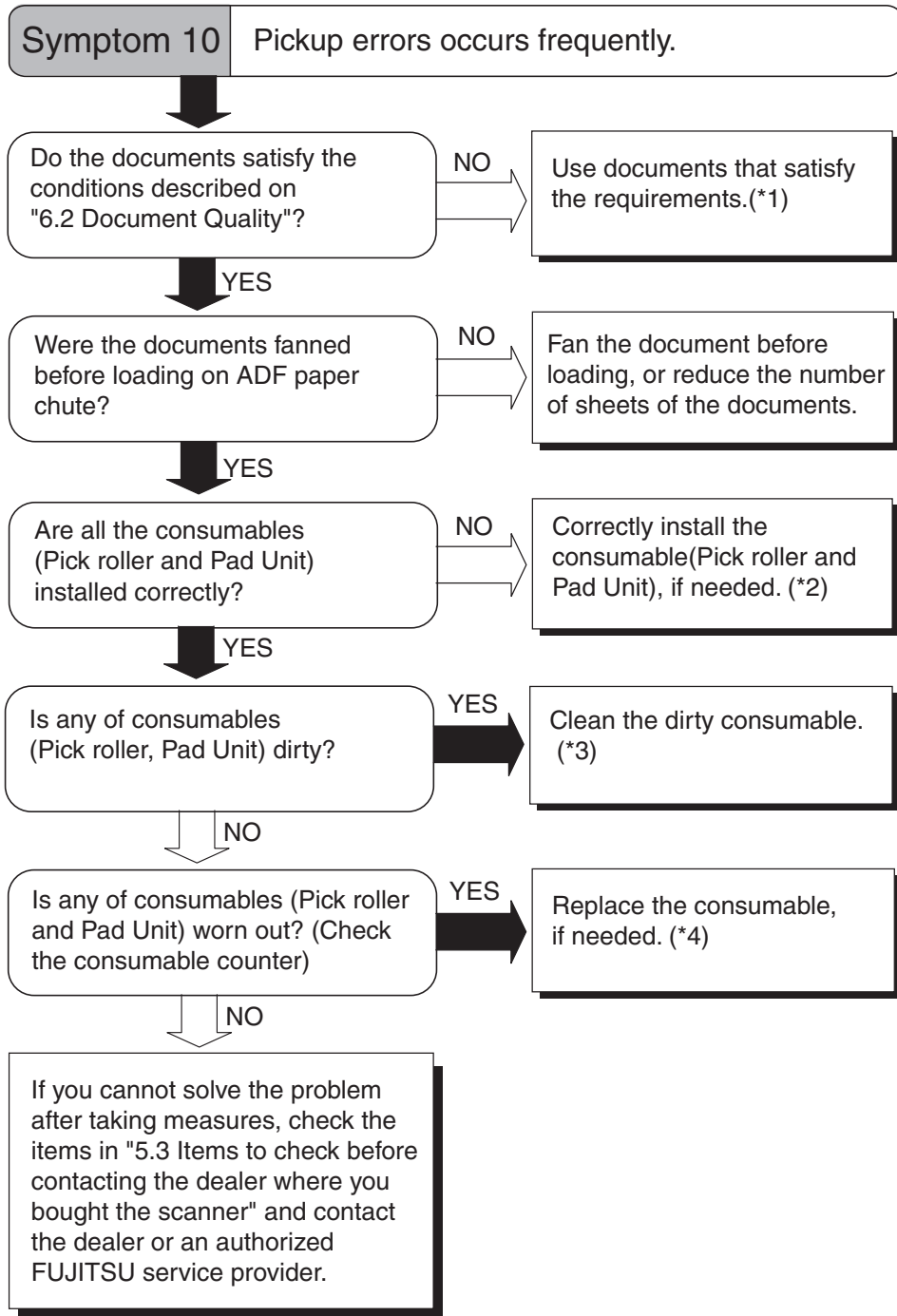

*1) For details on requirements, see "6.2 Document Quality" (page. 95).

*2) For details on how to install the consumables, see "4 REPLACING CONSUMABLES" (page. 57).

*3) For details on how to clean the consumables, see "3.3 Cleaning the ADF" (page. 53).

*4) For details on how to replace the consumables, see "4 REPLACING CONSUMABLES" (page. 57).

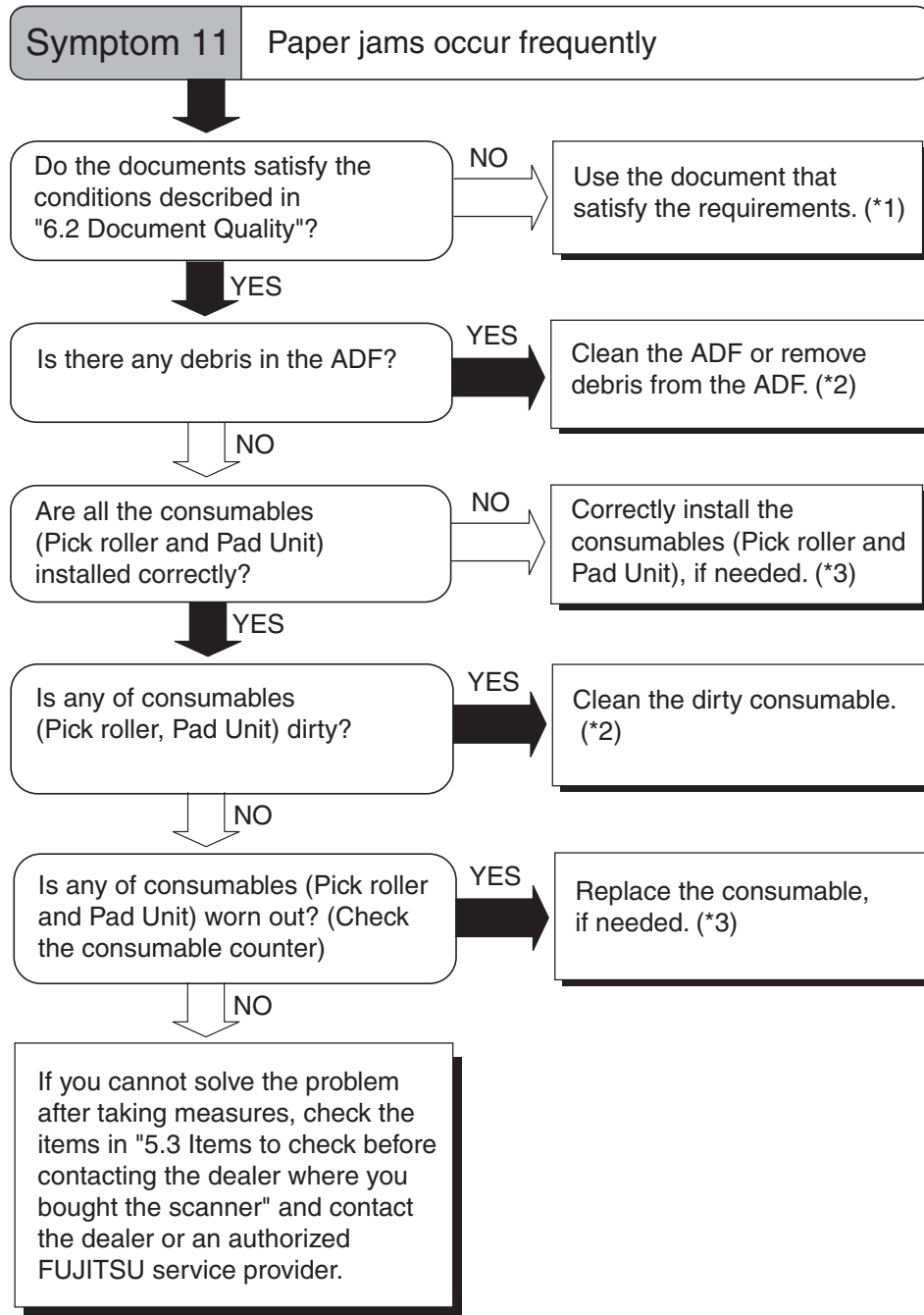

*1) For details on requirements, see "6.2 Document Quality" (page. 95).
 *2) For details on how to clean the ADF, see "3.3 Cleaning the ADF" (page. 53).
 *3) For details on how to attach the consumables, see "4 REPLACING CONSUMABLES" (page. 57).

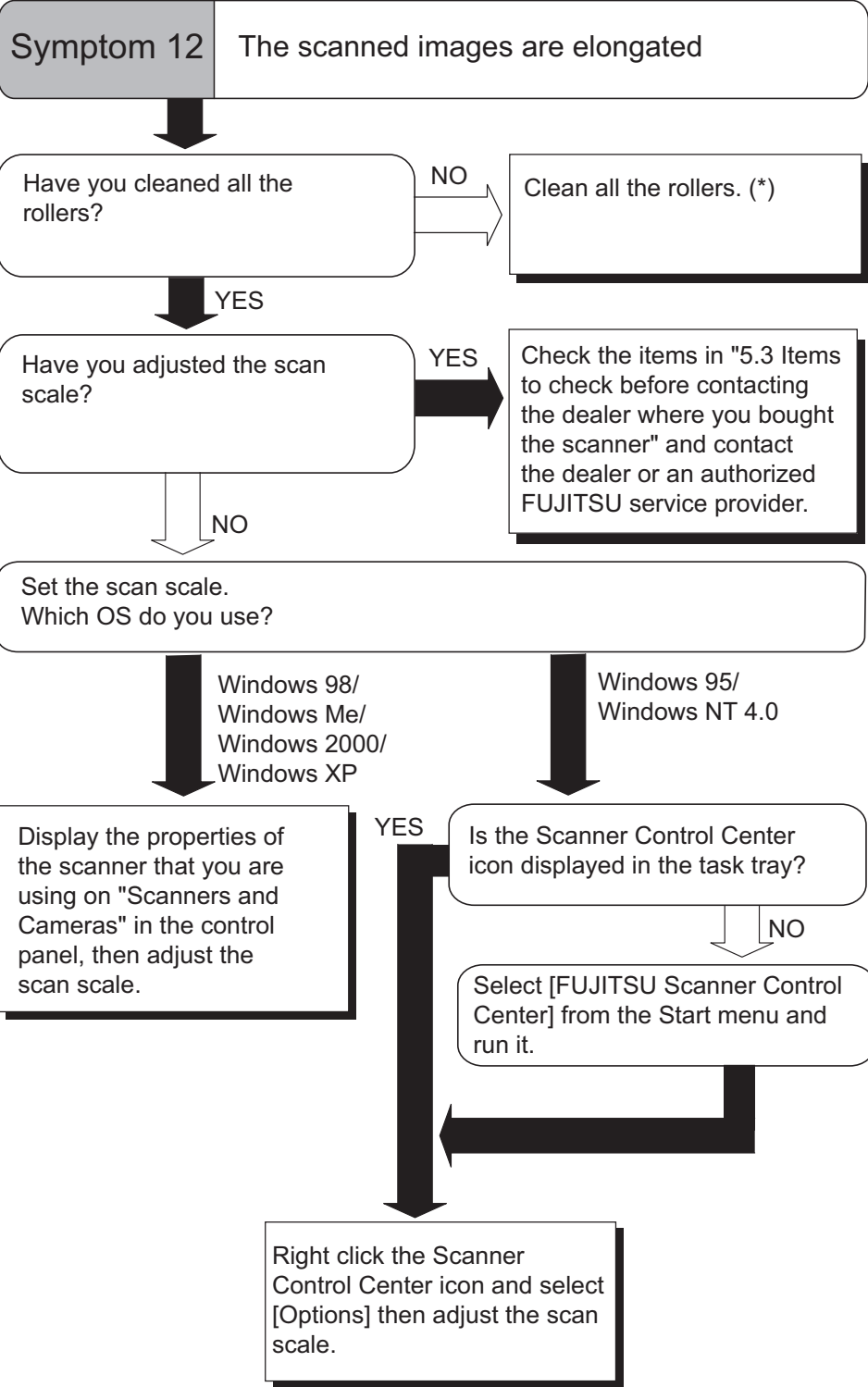

*) For details on how to clean the rollers, see "3.3 Cleaning the ADF" (page. 53).

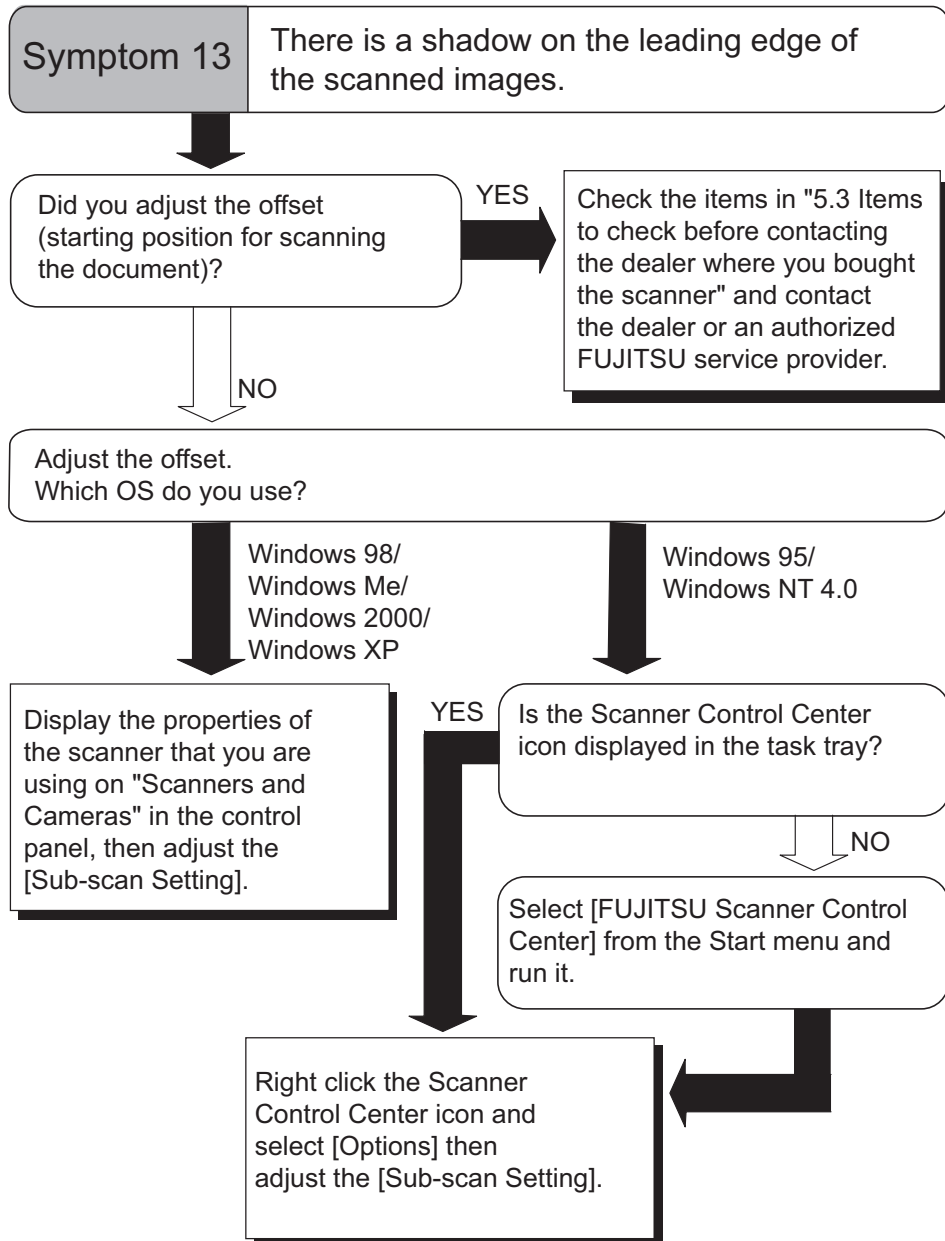

5.3 Items to Check Before Contacting the Agent Where You Bought the Scanner

Check the following items before you contact the agent where you bought the scanner.

■ General Details

Item	findings
Model	(Example) fi-4220C2 For details on model, see "5.4 Checking Labels on the Scanner" (page. 92).
Serial No.	(Example) 000001 For details on serial No., see "5.4 Checking Labels on the Scanner" (page. 92).
Production date	(Example) 2004-5 (May, 2004) For details on production date, see "5.4 Checking Labels on the Scanner" (page. 92).
Date of purchase	
Symptom	
Frequency of trouble	

■ Installation or PC connection issues

■ Problem at the time of personal computer connection

Item	findings
OS (Windows)	
Displayed error message	
Application	(Example) SCSI interface
Interface controllers	(Example) made by Adaptec SCSI Card 2940AU

■ Feed system trouble

Item	findings
Document type	
Main purpose of use	
Last cleaning date	
Last consumables replacement date	
Operator panel status at trouble	

■ Imaging system trouble

Item	findings
Type and version of scanner driver	
Type of interface controller	(Example) made by Adaptec SCSI Card 2940AU
OS (Windows)	
Application software	(Example) ScandAll 21 (Example) Acrobat

■ Other

Item	findings
Can both the original document and scanner image be sent by e-mail or Fax?	

5.4 Checking Labels on the Scanner

This section describes how to check the labels on the scanner.

■ Positions of Labels on the Scanner

The following shows where the two labels are located on the scanner.

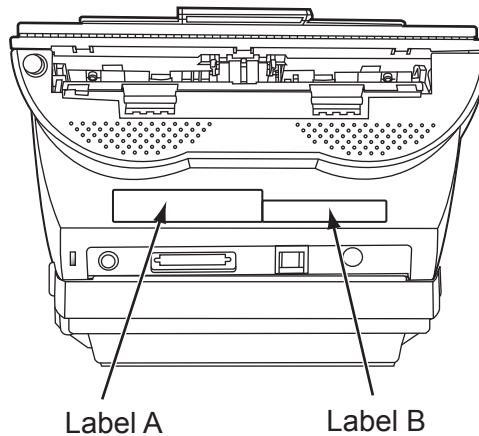

Label A (example): Indicates scanner information.

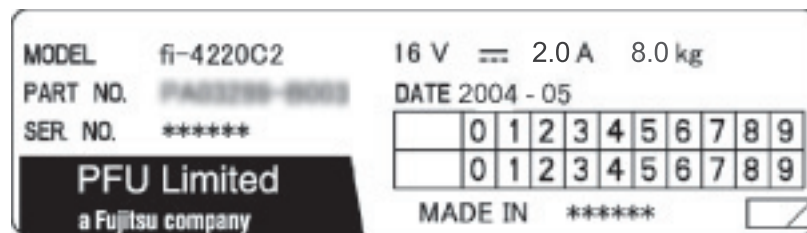

Label B (example): Indicates various standards that the scanner conforms with.



Chapter 6



ADF AND PAPER SPECIFICATION

This chapter describes the required document size and paper quality for ensuring correct operation when scanning documents on the ADF.

6.1 Document Size.....	94
6.2 Document Quality.....	95
6.3 Maximum Document Loading Capacity	97
6.4 Area not to be perforated	98
6.5 Multi feed Detection Conditions	99

6.1 Document Size

The following shows the size of documents that can be scanned on the ADF.

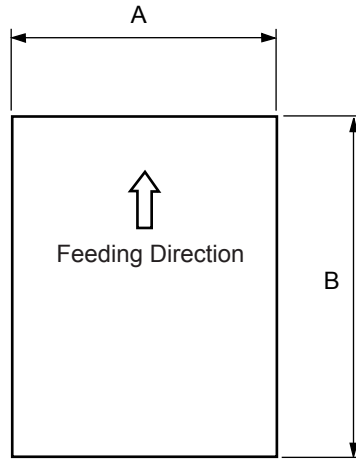

Maximum		Minimum	
A	B	A	B
216 (8.5 in)	356 (14 in)	53 (2.1 in)	74 (2.9 in)

(Unit : mm)

6.2 Document Quality

■ Document Type

The following paper types are recommended for document use:

- Woodfree paper
- Wood containing paper

When using documents of paper type other than the above, check whether or not the document can be scanned by test-scanning a few sheets before executing the actual document.

■ Document Thickness

Paper thickness is expressed by "paper weight." The following shows the paper weights that can be used on this scanner:

- 52 g/m² to 127 g/m²
Only paper weight of 127 g/m² is acceptable for A8-size documents.

■ Precautions

The following documents may not be scanned successfully:

- Documents of non-uniform thickness (e.g. envelopes)
- Wrinkled or curled documents (See HINT on page 96.)
- Folded or torn documents
- Tracing paper
- Coated paper
- Carbon paper
- Carbonless paper
- Photosensitive paper
- Perforated or punched documents
- Documents that are not square or rectangular
- Very thin documents

Do not use the following documents:

- Paper-clipped or stapled documents
- Documents on which the ink is still wet
- Documents smaller than A8 (Portrait) in size
- Documents wider than A4 or Letter size (216mm)
- Documents other than paper such as fabric, metal foil, or transparencies



- When scanning semi-transparent documents, slide the [Brightness] bar to light to avoid bleed through.
- To prevent the rollers from becoming dirty, avoid scanning documents containing large areas written or filled in pencil. If scanning of such documents is unavoidable, clean the rollers frequently.



- Carbonless paper contains chemical substances that may damage the Pad ASSY or rollers (e.g. Pick roller) when documents are fed. Pay attention to the following:

Cleaning: If pick errors occur frequently, clean the Pad ASSY and Pick rollers.

For details on cleaning the Pad ASSY and Pick rollers, see "3.3 Cleaning the ADF" (page. 53).

Replacing parts: The service life of the Pad ASSY and Pick rollers is sometimes shortened when scanning medium-grade paper documents.

- When the manuscript of Wood containing paper is read, the life of a Pad ASSY and a Pick roller may become short compared with the case where the manuscript of Woodfree paper is read.



When using the ADF, the leading edge of all document sheets must be evenly aligned. Make sure that curling at the leading edge is within the following tolerances:

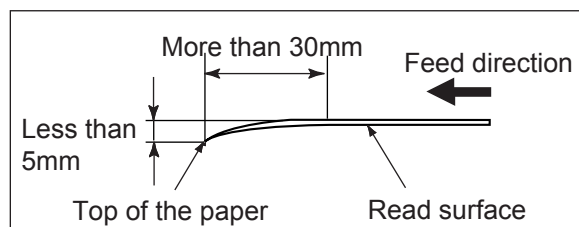
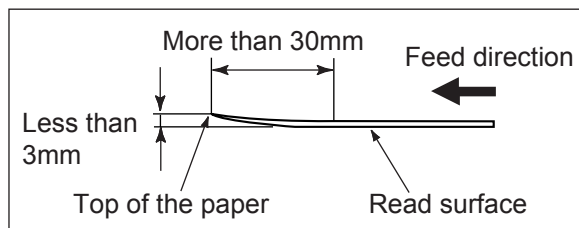

6.3 Maximum Document Loading Capacity

The maximum number of sheets that can be loaded on the ADF paper chute is determined by the size and weight of the document. The following graph shows the maximum document loading capacity of ADF according to paper weight.

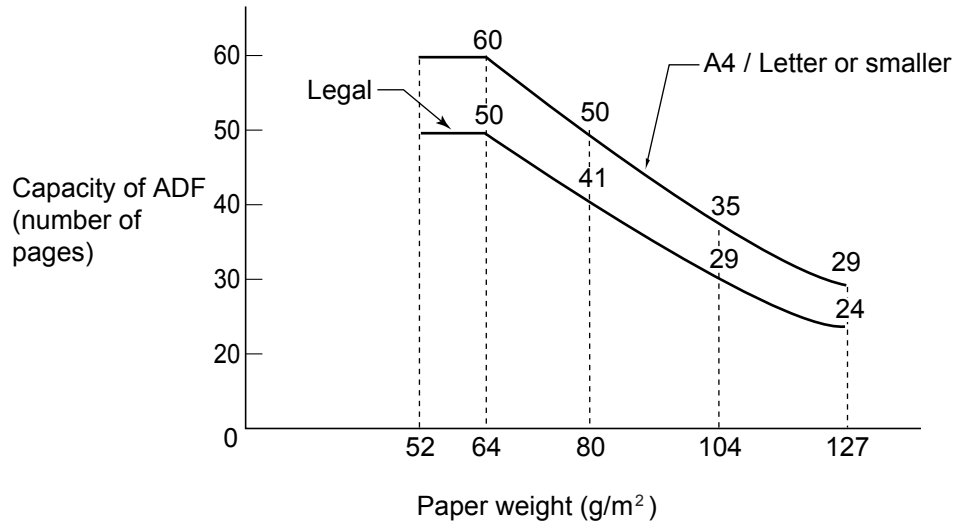

Paper weight conversion table

Unit	Conversion						
g/m ²	52	64	75	80	90	104	127
lb	14	17	20	21	24	28	34

6.4 Area not to be perforated

When using the ADF, document trouble might occur if there are punched holes in the shaded area in the following figure. If hole-punched documents must be scanned, use the Flatbed.

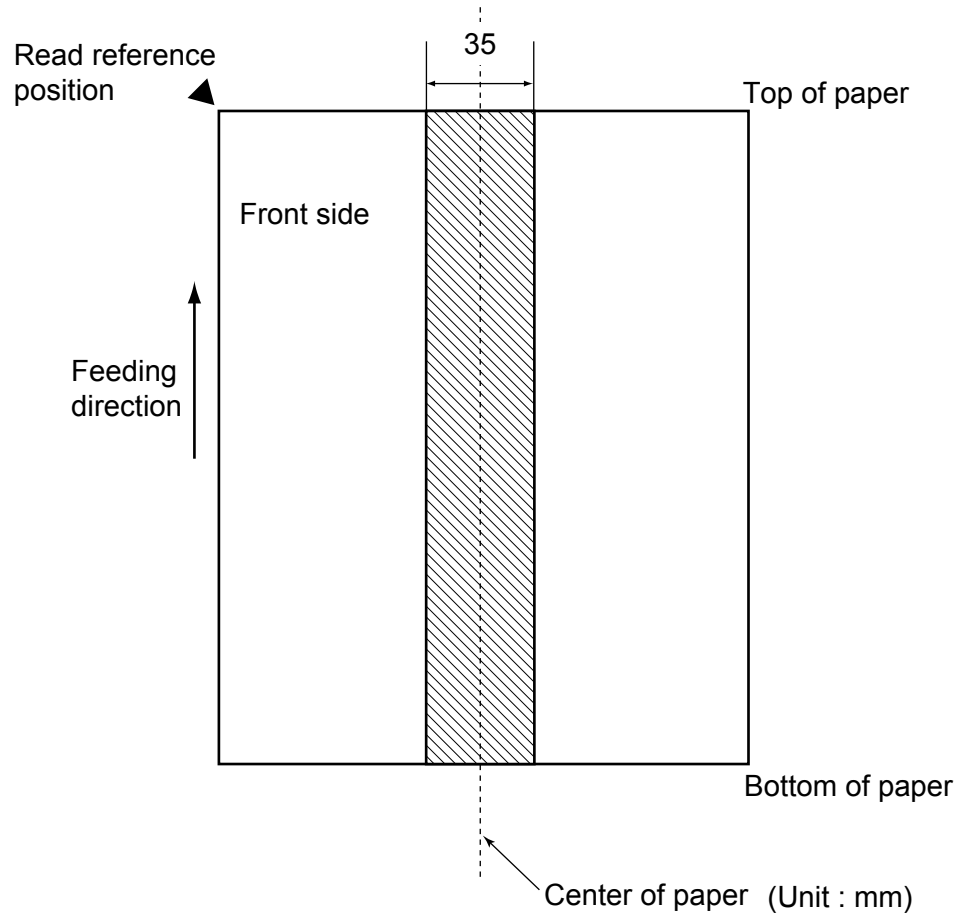

6.5 Multi feed Detection Conditions

There are three multi feed detection modes: document thickness, document length, and both document thickness and length. The following conditions must be satisfied in each of these detection modes.

■ Detection by Document Thickness

Sheets of the same thickness shall be set in the ADF at a time.

- Document thickness: 0.065 to 0.15mm
- Printed area: 12% or less
- No black printed areas are allowed at the center area (26 x 10mm) at the leading edge of the document.
- Punched holes are not allowed within 35mm of the vertical center line of the document.
- The deviation in the amount of the light transmitted through background areas must not be less than 10%.

■ Detection by Document Length

Sheets of the same length shall be set in the ADF at a time.

- Document length deviation: 1% or less
- Punched holes are not allowed within 35mm of the vertical center line of the document.

■ Detection by Document Thickness and Length

Sheets of the same thickness and length shall be set in the ADF at a time.

- Document thickness: 0.065 to 0.15mm
- Document length deviation: 1% or less
- Printed area: 12% or less
- No black printed areas are allowed at the center area (26 x 10mm) at the leading edge of the document.
- Punched holes are not allowed within 35mm of the vertical center line of the document.
- The deviation in the amount of the light transmitted through background areas must not be less than 10%.



The type of document and document conditions sometimes cause the multi feed detection rate to drop.

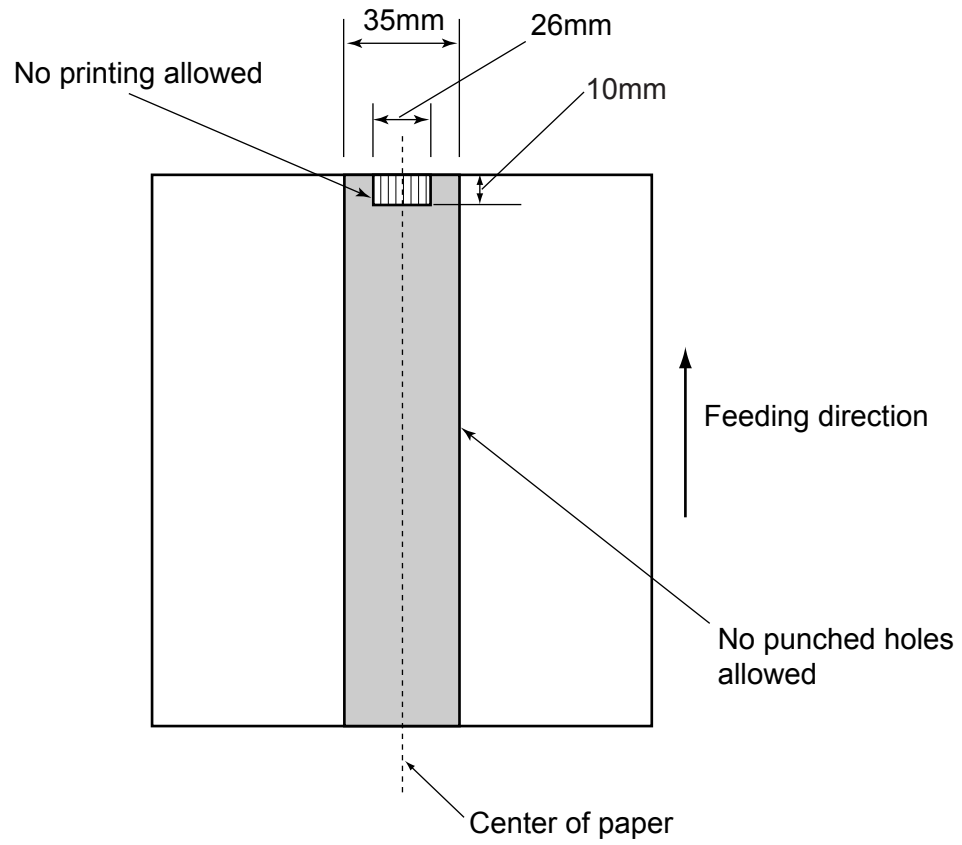

Chapter 7



SCANNER SPECIFICATION

This chapter lists the scanner specifications.



7.1 Basic Specifications.....	102
7.2 Installation Specifications	104
7.3 External Dimensions	105

7.1 Basic Specifications

1	Scanner Type		ADF(Automatic Document Feeder),Flatbed	-
2	Image sensor		CCD x 3	Front / Back / Flatbed
3	Light source		White cold cathode fluorescent lamp x 3	Front / Back / Flatbed
4	Scanning area	Minimum	A8 (Portrait)	ADF 127 g/m ² paper (Note (*1))
		Maximum	Flatbed: 216 x 297mm (8.50 x 11.69in) ADF: Legal (Long page scanning: 216 x 864mm or 8.50 x 34in)	-
5	Paper Weight		52 g/m ² to 127g/m ² (14 to 34lb)	(Note (*2))
6	Scanning Speed (A4 Portrait) (Note (*3))	Binary (monochrome)	Simplex: 25 sheets/min. Duplex: 50 sides/min.	200 dpi (Note (*4))
		Color	Simplex: 25 sheets /min. Duplex: 50 sides/min.	150 dpi (Note (*4))
7	Capacity of ADF		50 sheets	A4, 80 g/m ² (20lb) (Note (*5))
8	Optical Resolution		600 dpi	-
9	Output resolution	Binary (monochrome)	50 - 600 dpi	Scalable in 1 dpi increments
		Grayscale	50 - 600 dpi	Scalable in 1 dpi increments
		Color	50 - 600 dpi	Scalable in 1 dpi increments
10	Grayscale level (internal)		8 bits per color	Internal 10 bits
11	Halftone Patterns		Dither / error diffusion	-
12	Interface (Note (*6))		Ultra SCSI	Shield-type 50 pin (pin-type) halfpich
			USB 2.0 / 1.1 (Note (*7))	B type
13	Other function		JPEG compression	-

- *1) The minimum size for scanning is A8 when using the ADF. When using the Flatbed to scan the minimum scanning range is virtually unlimited.
- *2) The manuscript thicknesses noted are for when using the ADF. When using the Flatbed to scan the manuscript thickness is unlimited.
For details, see "Chapter 6 ADF AND PAPER SPECIFICATION" (page. 93).
- *3) The scanning speed is the maximum speed of the scanner hardware. Software processing time such as data transfer time is added to the actual scanning time.
- *4) The scanning speed noted is the value when using the ADF to scan.
- *5) The maximum stacking capacity varies according to the document thickness. For details, see "Chapter 6 ADF AND PAPER SPECIFICATION" (page. 93).
- *6) The Ultra SCSI and USB 2.0 / 1.1 interfaces cannot be used at the same time.
- *7) If you connect the scanner with USB 2.0, it is required that the USB port and the Hub are compliant with USB 2.0. The scanning speed may slow down when you connect the scanner with USB 1.1. If your omputer has the compatible USB 2.0 port, please use it.

7.2 Installation Specifications

Item		Specification		
Dimensions (mm) (Without ADF paper chute)		Depth	Width	Height
		569 (22.4 in)	302 (11.9 in)	229 (9.0 in)
Installation Space (mm) (D x W x H)		800 (31.5 in) x 400 (15.8 in) x 450 (17.8 in)		
Weight (kg)		8.0 (17.64 lb)		
Input power	Voltage	100 to 120 VAC \pm 10% 220 to 240 VAC \pm 10%		
	Phases	Single-phase		
	Frequency	50 / 60 \pm 3Hz		
Power consumption		34 W or less		



Installation Space is the reference value of an installation space required to read A4 manuscript.

Item		Specification	
Ambient condition	Device status	Operating	Not operating
	Temperature	5 to 35 °C (41 to 95°F)	-20 to 60 °C (-4 to 140°F)
	Humidity	20 to 80 %	8 to 95 %
Heat capacity		29.3 kcal / H or less	
Shipping Weight (kg)		11.5 (25.35 lb)	

7.3 External Dimensions

The following shows the external dimensions of the fi-4220C2:

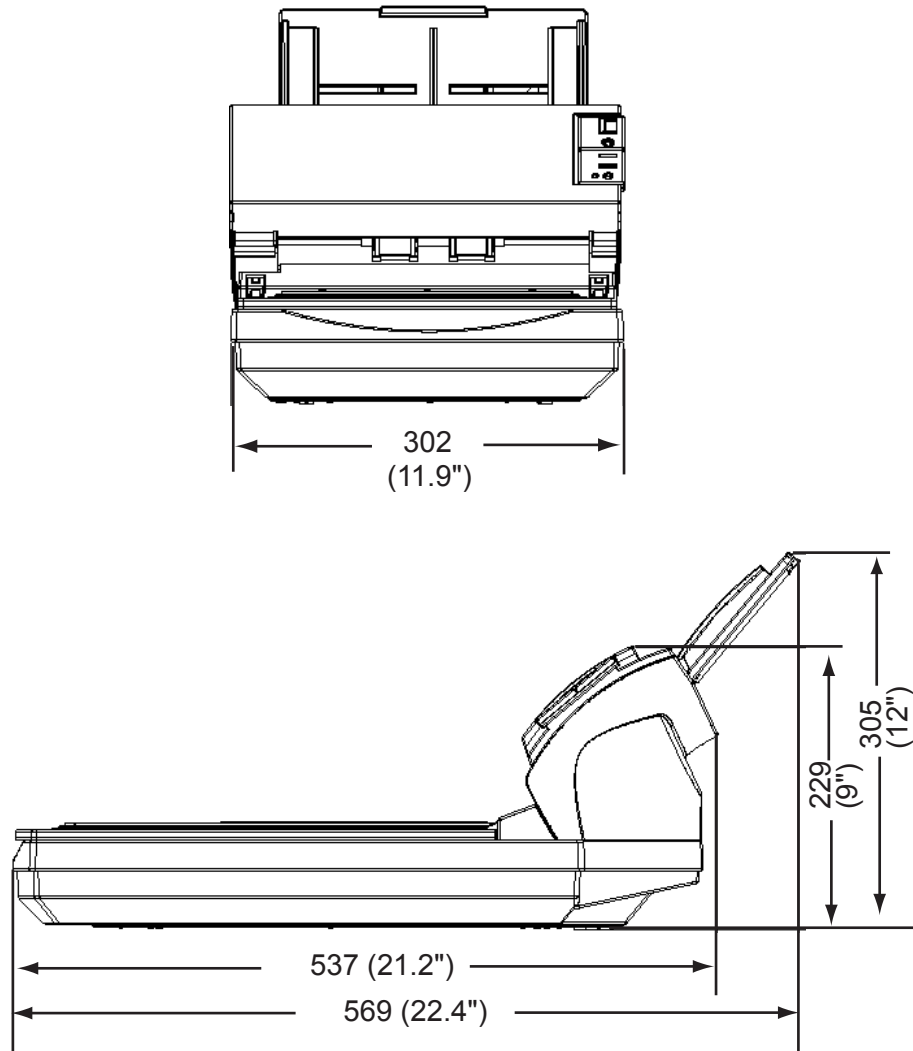

(Unit : mm)

APPENDIX A



Before using the [Scan] or the [Send to] button

By setting the link of the application software to the [Scan] or [Send to] button, you can launch the linked application by simply pushing the button.

■ For Windows 98, Windows Me, Windows 2000, Windows XP

1. Select [Start]-[Control Panel].
2. Select [Scanners and Cameras]-[Properties].
3. Select the [Events] tab.
4. Select an Event. For Windows XP, select the event for starting up any application from the [Select an event] menu.

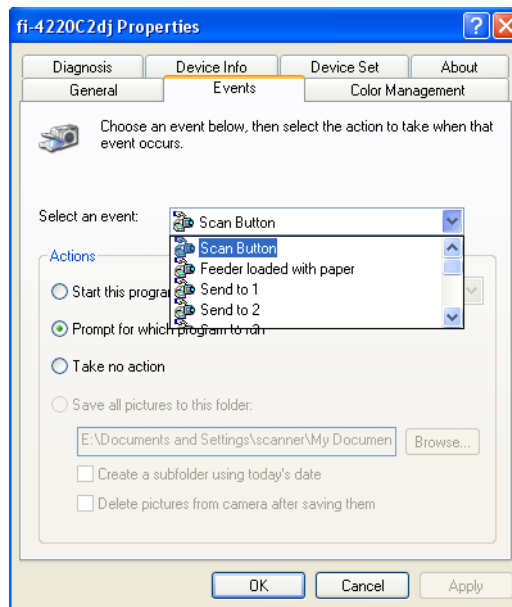

The events available for this function are:

- Scan button (When pushing the [Scan] button)
- Feeder loaded with paper (When setting the documents in the ADF)
- Send to 1-9 (When pushing the [Send] to button)

5. Select the application with its process, executed by the event. For Windows XP, click [Start this program] under [Actions] and select the application and process from the menu.

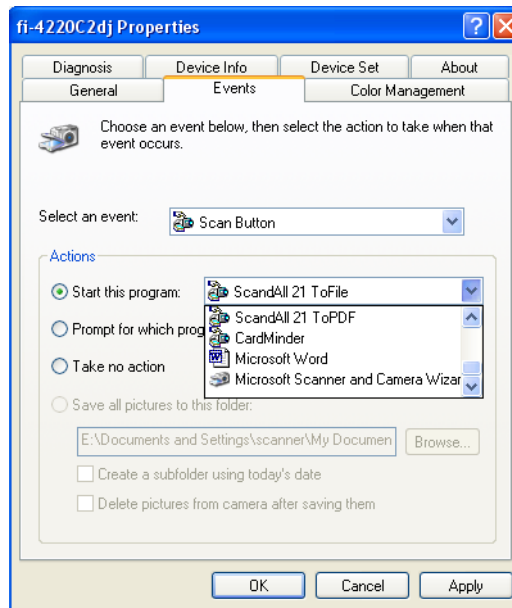

6. Click [OK] button.

.....

HINT  A window may appear when documents are set on the ADF. If you wish not to display this window, select [Feeder loaded with paper] from [Select an event] and click [Take no action], then click [OK].

.....

HINT  The window and operations may vary depending on your OS.

.....

■ For Windows 95, WindowsNT 4.0

1. Right click the [FUJITSU Scanner Control Center] in the task tray and select [Option].
2. Select the event for starting up the application from the [Event] menu.

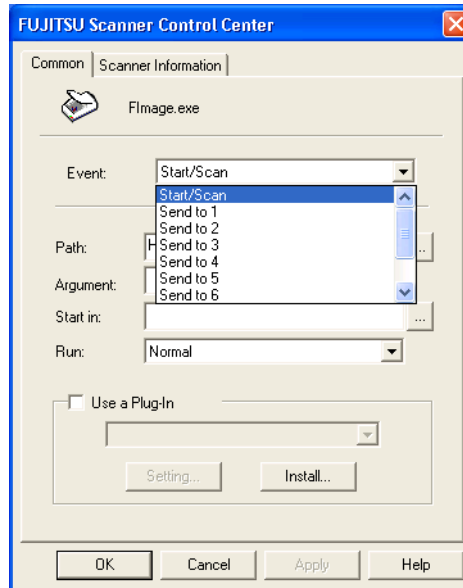

The events available for this function are:

- Start/Scan button (When pushing the [Scan] button)
- Send to 1-9 (When pushing the [Send] to button)

3. Click [...] button right to the entry field of [Path].
4. Click [OK].

A



GLOSSARY OF TERMS



A4 size

A standard paper size. Paper size is 210 x 297 mm.

A5 size

A standard paper size. Paper size is 148 x 210 mm.

A6 size

A standard paper size. Paper size is 105 x 148 mm.

A7 size

A standard paper size. Paper size is 74 x 105 mm.

A8 size

A standard paper size. Paper size is 53 x 74 mm.

ADF (Automatic Document Feeder)

A unit that allows the user to scan a number of pages consecutively. Fed documents are transported from the ADF paper chute (or hopper) to the Stacker. Actual scanning operation is executed by the mechanism inside of this unit. Backside reading = Back-side scanning Refers to reading the backside of the document, specifically in Duplex reading mode.

Automatic separation

An image processing method in which the scanner automatically detects difference between text and photos, and chooses the threshold accordingly. This function allows the scanner to switch between line mode and half tone mode in one pass.

Automatic size/skew detection

A function that automatically detects the documents' page size and adjusts output data to the detected page size. Document skewing is automatically detected and corrected for the output image.

Brake roller

A roller that prevents two or more sheets of paper from being fed simultaneously into the ADF.

Brightness

Refers to the brightness of scanned images in this manual.

Canadian DOC Regulations

"A standard issued by Industry Canada, a department of the Canadian government, which sets out the technical requirements relative to the radiated and conducted radio noise emissions from digital apparatus. "

CCD (Charged Coupling Device) Image Sensor

A semiconductor device inside the scanner that registers light reflected from the original image and converts it into a digitized (electronic) form. CCD technology is the basis of high-quality image acquisition in scanners, cameras, and other specialized devices.

Cleaning paper

Sheets used with the F1 cleaner for cleaning the rollers (pick rollers, feed rollers, etc.) and complete document path in the scanner. Used in daily maintenance of the low volume production scanner to reduce paper transport problems. Note: these sheets are not meant to replace the more thorough periodic cleaning of the scanner.

Cleaning sheet

Adhesive sheets used for cleaning the rollers (pick rollers, feed rollers, etc.) and complete document path in the scanner. Used in daily maintenance of the high volume production level scanner to reduce paper transport problems. Note: these sheets are not meant to replace the more thorough periodic cleaning of the scanner.

Color balance

Balance of colors in images.

Default settings

Pre-set values for optional menus.

Density

In this manual, refers to a measurement of the depth of the display.

Dither

The process by which a group of dots is arranged to represent a shade of gray. The predetermined dot pattern simulates shades of gray. This scanning process offers the advantage of reduce memory requirements compared to multilevel gray.

Document jam

A warning that appears when document is jammed in the transport unit, or transportation is Interrupted because the paper is slipping.

dpi

Dots per inch. Number of dots lined along one inch A measurement of resolution normally used for scanners and printers. Higher dpi means better resolution.

Driver software

In this manual, driver software refers to software that allows the scanning application software to communicate with the scanner.

Dropout color

A color which is used in the document but does not appear in the read image.

Duplex reading mode

A mode for scanning both sides of the document in one pass.

Eject rollers

Rollers that transport documents from the ADF onto the Stacker.

Energy Star

ENERGY STAR is an international standard for energy-efficient electronic equipment. It was created by the US Environment Protection Agency (EPA) in 1992. The standard program has now been adopted by several countries around the world.

Equipment Error

An error that cannot be fixed by the operator. The operator should call the manufacturer for service.

Error diffusion

High-quality halftone (pseudo-grayscale) image production based on black-and-white pixel binarization. A pixel's optical density and that of adjacent pixels are summed, with black pixels relocated in their order of density as they relate to adjacent pixels. The purpose of this technique is to minimize the average error between read and printed densities. Density data for adjacent pixels is modified by diffusing errors on the objective pixel into several pixels, which are then binarized. This maintains high grayscale levels and resolution during reading, while suppressing more patterns by dotted halftone images such as newspaper photographs.

FCC

Acronym for "The Federal Communications Commission", an independent United States government agency which is in charge of regulating interstate and international communications via radio, television, wire, satellite and cable. The Part 15 of the FCC regulations mentioned in this manual is designed to prevent harmful interferences on radio communication of radio receivers and other devices which radiate radio frequency energy, and provides for the certification of radio receivers. It also provides the certification of low power transmitters and the operation of certificated transmitters without a license.

Feeds rollers

Rollers that feed documents through the ADF.

Filtering

A correction method that improves the read quality of handwritten documents. The read quality of images written in pencil or ball-pointed pen depends on the reflective light characteristics of the specific ink or lead used. Dropped pixels may produce outlines, gaps, or thin, barely connected lines due to uneven optical density. Filtering detects areas lighter than their surroundings and increases their density to improve image clarity.

Flat bed An input device of the scanner, where documents are placed and scanned. Generally used for scanning pages out of a book, or paper that is out of the feeding specification of the ADF. Also used to scan a small volume of documents by manual operation.

Flat bed

An input device of the scanner, where documents are placed and scanned. Generally used for scanning pages out of a book, or paper that is out of the feeding specification of the ADF. Also used to scan a small volume of documents by manual operation.

Gamma

A unit of changes of images' brightness. It is expressed as a function of the electric input power to devices (scanner, display, etc.) and an image's brightness. If the gamma rate is larger than 1, the brightness of an image increases and vice versa. In order to adjust the brightness of an image close to the original, generally the gamma value is set to 1.

Gray scale

A method for realizing the gradation from black to white on the scanned image. For example, when scanning monochrome documents, the computer recognizes the documents as sets of black and white dots. In the Gray scale method, each dot contains data regarding density of black. The original gradation of the documents is realized as the gradation of the density data.

Halftone processing

Any method used to reproduce a photograph which includes a shade as an image composed of dots, namely, a binary image. Dithering and error diffusion processing are examples of halftone processing.

Image emphasis

Density is decreased for lighter but not completely white areas adjacent to black areas. Weakening this emphasis eliminates spot noise or produces softened images.

Image processing

An image is scanned with specified parameters.

Interface

The connection that allows communication from the computer to the scanner.

Inversion (Reverse-image reading)

In reverse-image reading, data is changed from black to white and vice versa.

IPC preset mode

While reading binary images, it is necessary to set the scanner according to the quality of the sheet to be read. In this mode, these settings can be performed in advance by corresponding each setting to a pattern number.

ISIS (Image Scanner Interface Specification)

A standard of API (Application Program Interface) or protocol for imaging devices (scanners, digital cameras, etc.) developed by Pixel Translations, a division of Captiva Software. In order to use imaging devices designed on the ISIS standard, it is necessary to install the driver software of the same standard.

Jaggy images

Images that have sharp projections or irregular shape on their edges.

Job separation sheet

A sheet inserted between documents in a batch for separating different jobs.

Landscape

A document is transported and read with the Short side parallel to the moving direction.

Landscape orientation

A document is transported and scanned with the long side vertical to the moving direction.

Letter size

A standard paper size used in the U.S.A. and other countries. Paper size is 8-1/2 x 11 inches.

Linedrawing mode

Selecting linedrawing mode makes threshold and contrast settings effective but prevents brightness from being set. The specified threshold value determines whether black or white pixels are scanned. Line drawing mode is therefore appropriate for scanning text and line art images.

Multi feed detection

A scanner function which detects accidental feeding of multiple sheets into the ADF. This can be set as both enabled/disabled.

Mirror image

The read image is symmetrically flipped to produce a mirror image of the original detected in the main scanning direction.

Moire Patterns

Recurrent patterns on scanned images caused by incorrect settings of angles.

Noise removal

Isolated noise from an image appearing as black spots in white areas and voids in black areas is removed to improve image quality.

Removes particles from the document image. Common particles include toner and fax particles. Noise reduction works via an algorithm that removes pixels up to 5 x 5 dots apart. A dot is 1/400 inch. A particle can be distinguished from a character as it is not connected to another dot within 5 pixels.

OCR (optical character recognition)

Devices or technologies for identifying characters on documents and converting them into text data that can be manipulated. The documents are checked by light and the differences of light reflection are recognized as character shapes.

Operator panel

A panel consists of indicators and buttons. The operator panel is used to control scanner operations such as, selecting features, and changing settings.

Optical sensor

A type of sensor for detecting multi feeding by light transmission. It also detects multi feeding by recognizing differences in length of documents.

Outline extraction

The boundary between black and white areas is traced and the outline extracted for closed areas.

Pad ASSY (Pad Assembly)

This part is used to separate a sheet of paper from a batch before feeding documents into the ADF. This assembly is made out of rubber.

Photograph mode (White level follower OFF)

Selecting photograph mode makes brightness and contrast settings effective but prevents the threshold from being set. With photograph mode, the darkness of image corresponds to the black-pixel density, making it suitable in scanning images such as photographs having gradations.

Pick roller

Roller(s) that picks the page from the batch of paper in the paper chute and feed it into the ADF.

Pick start time

The period from the manual insertion of the document until picking starts after the document passes the hopper empty sensor.

Pixel (Picture Element)

The tiny dots that make up a scanned image.

Portrait

Orientation of documents or images. Documents/images are set or displayed vertically.

Portrait orientation

A document is transported and read with the long side parallel to the moving direction.

Resolution

The measure of the details or grain of images displayed on a computer screen. As a metric of the resolution, dpi is customarily used.

SCSI (Small Computer System Interface)

An abbreviation for "Small Computer System Interface". SCSI is a standard for interfaces, used to connect devices such as hard disks, scanners, etc. Up to seven devices can be connected through this interface (daisy chain). The data transfer rates are different between "Fast SCSI" (Max. 10MB/sec.) and "Wide SCSI" (Max. 20MB/sec.).

SCSI-ID

Used to specify a particular SCSI device when the initiator selects a target or the target reconnects to the initiator.

Separation roller

A roller that separates the sheets of paper from each other.

Simplex reading mode

A mode for scanning only the front side of the document.

Smoothing

A process that eliminates "jaggies" from slanted lines and curves. Irregular convexities are deleted and irregular concavities filled in. This is useful in OCR applications, for example.

Storage temperature/humidity

The temperature and humidity levels necessary for proper storage of the scanner.

Temporary Error

An error that can be fixed by the operator.

Terminator

Devices with a SCSI interface can be daisy-chained. A resistor that includes terminal circuits needs to be placed at both ends of the SCSI chain when devices are daisy-chained. If a device (such as a scanner) is the last device in a chain, leaving an interface connector unused, a Terminator therefore must be attached to provide those terminal circuits.

Third Party Interface

Used to install optional board provided by Fujitsu or interface board manufactured by a third party.

Threshold

A value used as a metric for judging a color as black or white. For scanning an image with gray gradation, this value must be defined. The threshold setting determines which pixels are converted to black and which will become white.

TUV

"An institution that controls products for conformity with various standards of security, usability and environmental matters. "

TWAIN (Technology Without Any Interesting Name)

A standard for API (Application Program Interface) or protocol for imaging devices (scanners, digital cameras, etc.) developed by TWAIN Working Group. In order to use devices that comply with this standard, it is necessary to install driver software based on the same standard.

Ultrasonic sensor

A type of sensor for detecting multi feeding by ultrasonic sound. Scanners detect multi feeding by recognizing differences in the amount of ultrasonic waves that penetrates the documents.

USB (Universal Serial Bus)

An abbreviation for "Universal Serial Bus". A standard for interfaces used to connect devices such as key boards, scanners, etc. Up to 127 devices can be connected through this interface. USB devices can be plugged/unplugged without turning off their power. Data transfer rates are different between the "Low speed mode" (1.5Mbps) and "High speed mode" (Max. 12Mbps).

White level follower

A function to correct the difference between white colors in unbleached paper (e.g. wood containing paper, etc.) and in scanned images.

White Reference Stripe

The white part located in the ADF that defines the lightest area in an image, causing all other areas to be adjusted accordingly.

INDEX



A		F	
Ambient condition	104	Feed roller	55
B		FUJITSU ISIS Scanner Driver	16
Before using the (Scan) or the (Send to) button	1	FUJITSU TWAIN32 Scanner Driver	10
C		G	
Capacity of ADF	102	Glass	56
Checking Labels on the Scanner	92	Grayscale level	102
Cleaning Materials	50	H	
Cleaner F1	50	Halftone Patterns	102
Cleaning the ADF	53	Heat capacity	104
Cleaning the Flat bed	51	How to use the Scanner Driver	10
Configuration Window of FUJITSU ISIS		I	
Scanner Driver	19	Image sensor	102
Consumable and Replacement Cycle	58	Input power	104
D		Installation Space	104
Detecting Multi feeds	44	Interface	102
Document specifications	93	L	
Area not to be perforated	98	Light source	102
Document paper quality	95	Loading Documents on the ADF for Scanning	3
E		Loading Documents on the Flatbed for Scanning	7
Excluding a Color in the Image (dropout color)	41	Locations for cleaning	54
Extension	4	Feed rollers	54
External Dimensions	104, 105	Glass	54
		Pad ASSY	54

Pick roller	54
Plastic rollers	54

M

Maximum Document Loading Capacity ..	97
Multi feed Detection Conditions	99

O

Optical Resolution	102
Other function	102
Output resolution	102

P

Pad ASSY	54, 58
Paper Weight	102
Paper weight	97
Pick roller	55, 58
Plastic roller	56
Power button	2
Power consumption	104
Power save mode	2

R

Remedying Typical Troubles	77
Removing Jammed Documents	74
Replacing the Pad ASY	63
Replacing the Pick roller	66
Reset	
the pad counter	64
the pick counter	71

S

Saving Scanned Images in PDF Format	
.....	35
Using Adobe Acrobat 6.0	37

Using ScandAll 21	35
Scanner specifications	101
Ambient condition	104
Capacity of ADF	102
Dimensions	104
Grayscale level	102
Halftone patterns	102
Heat capacity	104
Image sensor	102
Input power	104
Installation Space	104
Interface	102
Light source	102
Optional resolution	102
Other function	102
Output resolution	102
Paper Weight	102
Power consumption	104
Scanner Type	102
Scanning area	102
Scanning Speed	102
Shipping Weight	104
Weight	104
Scanner Type	102
Scanning area	102
Scanning Books	28
Scanning Different-width Documents	34
Scanning Documents	8
Scanning Documents longer than A4 size	
.....	31
Scanning Double Sided Documents	26
Scanning Large Documents with Flatbed	
.....	30
Scanning Speed	102
Setting Window for FUJITSU TWAIN32	
Scanner Driver	13
Shipping Weight	104

Side guide	5
Standard Cleaning Cycle	50

T

TROUBLESHOOTING	73
Turning the Scanner ON	2

W

Weight	104
--------------	-----

fi-4220C2 Image Scanner Operator's Guide

P3PC-E927-02EN

Date of issuance: October, 2009

Issuance responsibility: PFU LIMITED

- Copying of the contents of this manual in whole or in part and copying of the scanner application is forbidden under the copyright law.
- The contents of this manual are subject to change without notice.
- PFU LIMITED. is not liable whatsoever for any damages resulting from use of this scanner and procedures described in this manual, profit due to defects, and any claims by a third party.