

# ***M4099D Image Scanner***

## Operator's Guide

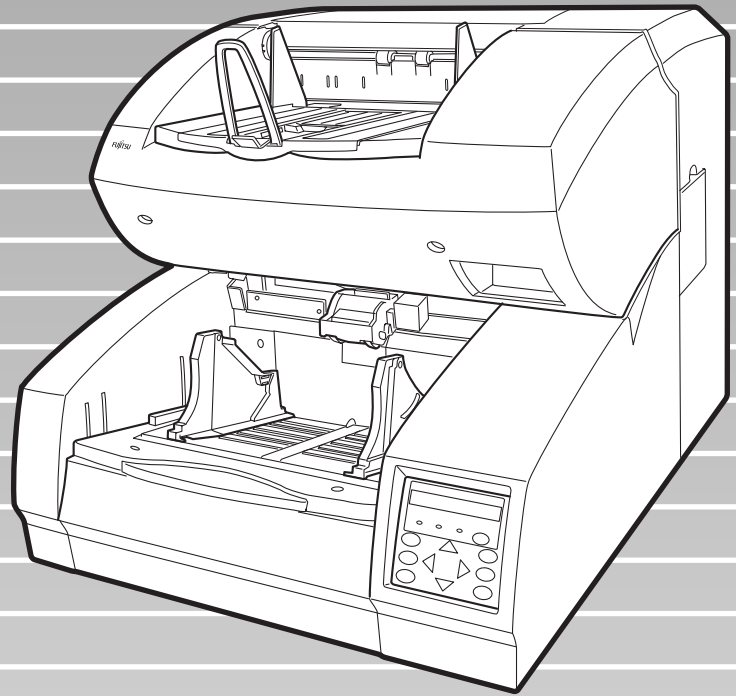

# Note

---

## **Treatment of This Manual**

READ ALL OF THIS MANUAL CAREFULLY BEFORE USING THIS PRODUCT, IF NOT USED CORRECTLY, UNEXPECTED INJURY MAY BE CAUSED TO USERS OR BYSTANDERS.

While all efforts have been made to ensure the accuracy of all information in this manual, PFU assumes no liability to any party for any damage caused by errors or omissions or by statements of any kind in this manual, its updates or supplements, whether such errors are omissions or statements resulting from negligence, accidents, or any other cause. PFU further assumes no liability arising from the application or use of any product or system described herein; nor any liability for incidental or consequential damages arising from the use of this manual. PFU disclaims all warranties regarding the information contained herein, whether expressed, implied, or statutory.

PFU reserves the right to make changes to any products herein, to improve reliability, function, or design, without further notice and without obligation.

## **EMC and Safety**

This equipment has been tested and found to comply with the limits for a Class A digital device, pursuant to Part 15 of the FCC Rules. These limits are designed to provide reasonable protection against harmful interference when the equipment is operated in a commercial environment. This equipment generates, uses, and can radiate radio frequency energy and, if not installed and used in accordance with the instruction manual, may cause harmful interference to radio communications. Operation of this equipment in a residential area is likely to cause harmful interference in which case the user will be required to correct the interference at his own expense.

This digital apparatus does not exceed the Class A limit for radio noise emissions from digital apparatus set out in the Radio interference Regulations of the Canadian Department of Communications.

This class A digital apparatus complies with Canadian ICES-003.

Le présent appareil numérique n'émet pas de bruits radioélectriques dépassant les limites applicables aux appareils numériques de la classe A prescrites dans le Règlement sur le brouillage radioélectrique dicté par le ministère des Communications du Canada.

Cet appareil numérique de la classe A est conforme à la norme NMB-003 du Canada.

### **Bescheinigung des Herstellers/Importeurs**

Hiermit wird bescheinigt, daß *der/die/das*

- fi-4099C in Übereinstimmung mit den Bestimmungen der
- AmtsbIVfg 243/1991 funktentstört ist. Der Deutschen Bundespost wurde das Inverkehrbringen dieses Gerätes angezeigt und die Berechtigung zur Überprüfung der Serie auf Einhaltung der Bestimmungen eingeräumt.
- Maschinenlärminformationsverordnung 3. GS GV, 18.01.1991:  
Der höchste Schalldruckpegel beträgt 70 dB (A) oder weniger gemäß ISO7779.

### **Warning on Use Requiring Extremely High Safety Levels**

This Product is designed, developed and manufactured as contemplated for general use, including without limitation, general office use, personal use and household use, but is not designed, developed and manufactured as contemplated for use accompanying fatal risks or dangers that, unless extremely high safety is secured, could lead directly to death, personal injury, severe physical damage or other loss (hereinafter "High Safety Required Use"), including without limitation, nuclear power core control, airplane control, air traffic control, mass transport operation control, life support, weapon launching control. You shall not use this Product without securing the sufficient safety required for the High Safety Required Use. If you wish to use this Product for High Safety Required Use, please consult with our sale person in charge before such use.

### **Warning on Reproduction**

Reproducing bills, coins, government securities and passports, licenses issued by public author or civilian organizations, official documents and private paper is illegal and brought to justice.

### **About Copyright**

Literary works like books, paintings, wood-block prints, maps, drawings and photographs should not be reproduced other than the personal or domestic use or the use within other limit without the rightful person's permission.

## Trademark Acknowledgment

- Windows® and Windows NT® are registered trademarks of Microsoft Corporation America in the United States and any other countries.
- ISIS is a registered trademark of Pixel Translations, A Division of Actionpoint Inc.
- All other brand names and product names of this manual are trademarks or registered trade marks.

- Reproducing in whole or in part of this manual against the Copyright law.
- The contents of this manual may be revised without prior notice.
- We are unaccountable for any damages or passive damages from the use of this equipment or this manual and any compensation of third party.

All Rights Reserved, Copyright © 1999-2003 PFU LIMITED.

## Conventions for Alert Messages

Special information, such as warnings, cautions, and notes are indicated as follows:

### WARNING

WARNING indicates that serious personal injury may result if you do not follow a procedure correctly.

### CAUTION

CAUTION indicates that minor personal injury, loss of data, or damage to the scanner may result if you do not follow a procedure correctly.

### NOTE

NOTE indicates remarks, tips, and other useful supplementary information.

The following symbols are used in this manual.



Used for general WARNING and CAUTION.



Used for NOTE.

# PFU Offices

Please send your comments on this manual or on PFI products to the following addresses:

PFU LIMITED  
Computer Products Business Group  
658-1 Tsuruma Machida-shi, Tokyo 194-8510,  
Japan  
Phone: (81-42)796-5211  
Fax: (81-42)788-7651  
Website: <http://www.pfu.fujitsu.com>  
E-mail: [imaging@pfu.fujitsu.com](mailto:imaging@pfu.fujitsu.com)

Corporate headquarters  
Nu 98-2 Unoke, Unoke-machi, kahoku-gun,  
Ishikawa 929-1192, Japan  
Phone: (81-76)283-1212  
Fax: (81-76)283-4689

## North America

FUJITSU COMPUTER PRODUCTS OF  
AMERICA, INC.  
2904 Orchard Parkway,  
San Jose, California CA95134-2009, U.S.A.  
Phone: 1-800-591-5924;(1-408)432-6333  
Technical Assistance Center: (1-800)626-4686  
Fax: (1-408)894-1709  
Website: <http://www.fcpc.com/>  
E-mail: [info@fcpc.fujitsu.com](mailto:info@fcpc.fujitsu.com)

FUJITSU CANADA, INC.  
2800 Matheson Boulevard East,  
Mississauga, Ontario L4W 4X5, Canada  
Phone: (1-905)602-5454  
Fax: (1-905)602-5457  
Website: <http://www.fujitsu.ca/>  
E-mail: [imaging@fujitsu.ca](mailto:imaging@fujitsu.ca) (for sales questions)  
[scantech@fujitsu.ca](mailto:scantech@fujitsu.ca) (for technical questions)

## Europa

FUJITSU EUROPE LTD.  
Hayes Park Central, Hayes End Road, Hayes  
Middlesex UB4 8FE, England  
Phone: (44-208)573-4444  
Fax: (44-208)573-2643  
Website: <http://www.fujitsu-europe.com/home/>  
E-mail: [iwebmaster@fujitsu-europe.com](mailto:iwebmaster@fujitsu-europe.com)

FUJITSU DEUTSCHLAND GMBH.  
Frankfurter Ring 211,  
80807 München 40, Germany  
Phone: (49-89)323-78-0  
Fax: (49-89)323-78-100  
Website: <http://www.fujitsu.de/>  
E-mail: [webmaster@fujitsu.de](mailto:webmaster@fujitsu.de)

FUJITSU NORDIC AB  
Kung Hans Väg 12,  
S-192 68 Sollentuna, Sweden  
Phone: (46-8)626-45-00  
Fax: (46-8)626-45-88  
Website: <http://www.fujitsu-europe.com/home/>

FUJITSU ITALIA S.p.A.  
Via Nazario Sauro, 38  
20099 Sesto San Giovanni (Milan), Italy  
Phone: (39-02)26294-1  
Fax: (39-02)26294-201  
Website: <http://www.fujitsu-europe.com/home/>

FUJITSU FRANCE S.A.  
1, Place des Etats-Unis,  
Silic 310, 94588 Rungis Cedex, France  
Phone: (33-1)41-80-38-88  
Fax: (33-1)41-80-3850  
Website: <http://www.fujitsu-europe.com/home/>

FUJITSU ICL ESPAÑA, S.A.  
Camino Cerro de los Gamos, 1 28224,  
Pozuelo de Alarcon, Madrid, Spain  
Phone: (34-91)784-9000  
Fax: (34-91)784-9317  
Website: <http://www.fujitsu-europe.com/home/>  
E-mail: [imagemaster@mail.fujitsu.es](mailto:imagemaster@mail.fujitsu.es)

## Australia

FUJITSU AUSTRALIA LTD.  
2 Julius Avenue  
North Ryde, N.S.W 2113 Australia  
Phone: (61-2)9776-4555  
Fax: (61-2)9776-4556  
CompuServe: GO FUJITSU  
Website: <http://www.fujitsu.com.au/>

---

## Asia

FUJITSU COMPUTER (SINGAPORE) PTE. LTD.  
20 Science Park Road, #03-01, Tele Teck Park  
Singapore Science Park II, Singapore 117674  
Phone: (65)777-6577  
Fax: (65)771-5499  
Website: <http://www.fujitsu-computers.com.sg>  
E-mail: [inquiry@fcsf.fujitsu.com.sg](mailto:inquiry@fcsf.fujitsu.com.sg)

FUJITSU TAIWAN LTD.  
19th Fl., No39, 1 Sec. chung-Hwa Rd.,  
Taipei, Taiwan  
Phone: (886-2)2311-2255  
Fax: (886-2)2311-2277

FUJITSU HONG KONG LTD.  
10/F., Lincoln House,  
979 King's Road,  
Taikoo Place,  
Island East, Hong Kong  
Phone: (852)2827-5780  
Fax: (852)2827-4724  
E-mail: [scanner@fujitsu.com.hk](mailto:scanner@fujitsu.com.hk)

FUJITSU SYSTEMS BUSINESS (THAILAND)  
LTD.  
12th Fl., Olympia Thai Tower,  
444 Rachadapisek Road, Samsennok,  
Huay kwang, Bangkok 10320, Thailand  
Phone: (662)512-6066  
Fax: (662)512-6068

FUJITSU KOREA LTD.  
5-11 Fl., Coryo Finance Center Building,  
Yuido-Dong 23-6, Young DungPo-gu,  
Seoul, Korea, 150-010  
Phone: (82-2)3787-5970  
Fax: (82-2)3787-6070  
Website: <http://www.fujitsu.co.kr>  
E-mail: [webmaster@fkl.fujitsu.co.kr](mailto:webmaster@fkl.fujitsu.co.kr)

FUJITSU SYSTEMS BUSINESS (MALAYSIA)  
SDN, BHD.  
Fujitsu Plaza 1A, Japan Tandang 204, P.O.Box  
636,  
Jalan Sultan, 46770, Petaling Jaya Selangor Darul  
Ehsan, Malaysia  
Phone: (60-3)793-3888  
Fax: (60-3)7783-0888

FUJITSU PHILIPPINES, INC  
2nd Fl., United Life Building, Pasay Road,  
Legaspi Village Makati, Metro Manila, Philippines  
Phone: (63-2)812-4002  
Fax: (63-2)817-7576

# Preface

This manual explains how to use the M4099D image scanner. This scanner can be equipped with an optional endorser; however, Illustrations in this manual do not include the endorser except those in Chapter 5. For details of the endorser, refer to its Operator Guide.

This manual contains COMPONENTS, INSTALLATION AND CONNECTIONS, OPERATING INSTRUCTION, DOCUMENT SPECIFICATION, SPECIFICATIONS, and SETUP, BROWSE, AND TEST MODES.

Refer to the CD-ROM for the information about the routine operation of the M4099D.

The CD-ROM contains OPERATING INSTRUCTION, CLEANING, REPLACEMENT OF PARTS, ADJUSTMENT and TROUBLESHOOTING.

The M4099D is very fast and highly functional image scanner developed for volume filing, using charge-coupled device (CCD) image sensors. This scanner features duplex scanning and high quality image processing with an automatic document feeder (ADF).

Edition	Date published	Revised contents
01	December, 1999	First edition
02	February, 2000	Setup descriptions reviewed
03	March, 2003	Setup functions added
Manual code: P3PC-E452-03EN		

# CONTENTS

❑	<b>CHAPTER 1 COMPONENTS</b>	
	Checking the Components .....	1-1
	Units and Assemblies .....	1-2
	Operator Panel .....	1-5
	Buzzer .....	1-8
❑	<b>CHAPTER 2 INSTALLATION AND CONNECTIONS</b>	
	Precautions .....	2-1
	Inspection .....	2-2
	Cable Connection .....	2-4
❑	<b>CHAPTER 3 OPERATING INSTRUCTION</b>	
	Turning the Power On .....	3-1
	Basic Operation of the Operator Panel .....	3-2
❑	<b>CHAPTER 4 DOCUMENT SPECIFICATION</b>	
	Document Size .....	4-1
	Document Quality .....	4-2
❑	<b>CHAPTER 5 SPECIFICATIONS</b>	
	Installation Specifications .....	5-1
	External Dimensions .....	5-2
	Consumables .....	5-3
	Options .....	5-4
❑	<b>CHAPTER 6 SETUP, BROWSE, AND TEST MODES</b>	
	Setup, Browse, and Test Modes .....	6-1
	Activating the Setup or Browse Mode .....	6-2
	Contents of the Setup or Browse Mode .....	6-4
	Activating the Test Mode .....	6-54
	Contents of the Test Mode .....	6-56
❑	<b>GLOSSARY OF TERMS</b> .....	GL-1
❑	<b>INDEX</b> .....	IN-1
❑	<b>DECLARATION OF CONFORMITY</b>	



**CHAPTER 1** COMPONENTS

COMPONENTS

**CHAPTER 2** INSTALLATION AND CONNECTIONS

INSTALLATION AND CONNECTIONS

**CHAPTER 3** OPERATING INSTRUCTION

OPERATING INSTRUCTION

**CHAPTER 4** DOCUMENT SPECIFICATION

DOCUMENT SPECIFICATION

**CHAPTER 5** SPECIFICATIONS

SPECIFICATIONS

**CHAPTER 6** SETUP, BROWSE, AND TEST MODES

SETUP, BROWSE, AND TEST MODES

**GLOSSARY OF TERMS**

GLOSSARY OF TERMS

**INDEX**

INDEX

# ***COMPONENTS***

---

*After unpacking the scanner, confirm that all the components have been received. This chapter describes the components of the scanner, part names, and operator panel arrangement and their function.*

## **Checking the Components**

### **Units and Assemblies**

### **Operator Panel**

### **Buzzer**

# Checking the Components

These high precision components must be handled with care.  
Confirm that all the components shown in the following figure have been received. Mount the stop lever on the stacker of the scanner.  
If any component is missing, please contact your sales agent.

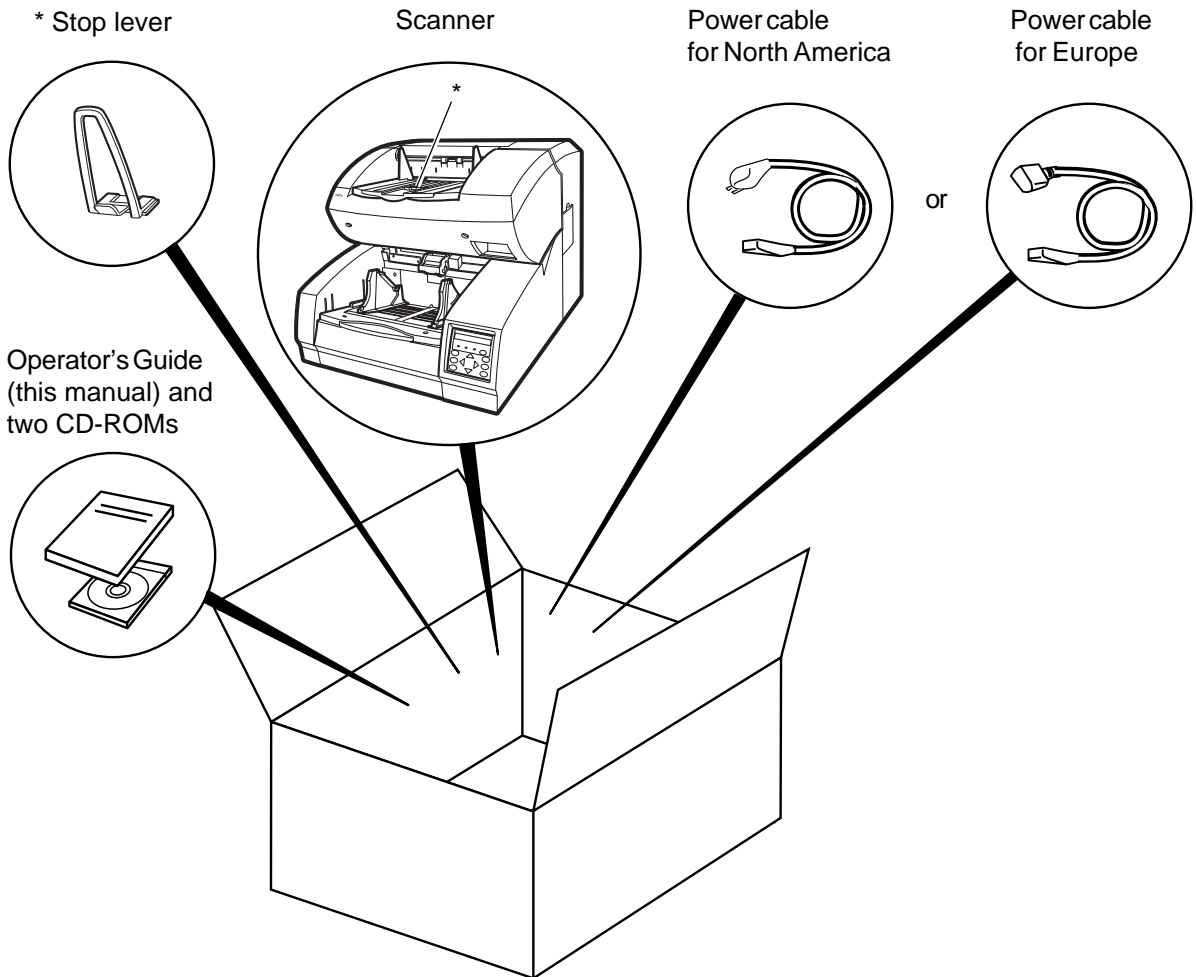

# Units and Assemblies

This section shows the exterior view and assemblies of the scanner. This section also provides names of each part and describes their functions.

## ■ Units

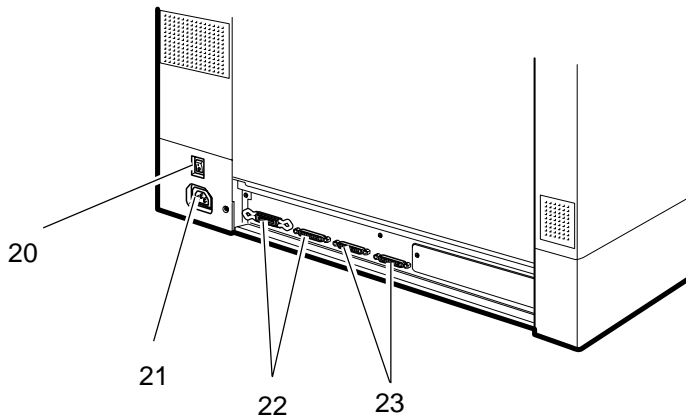
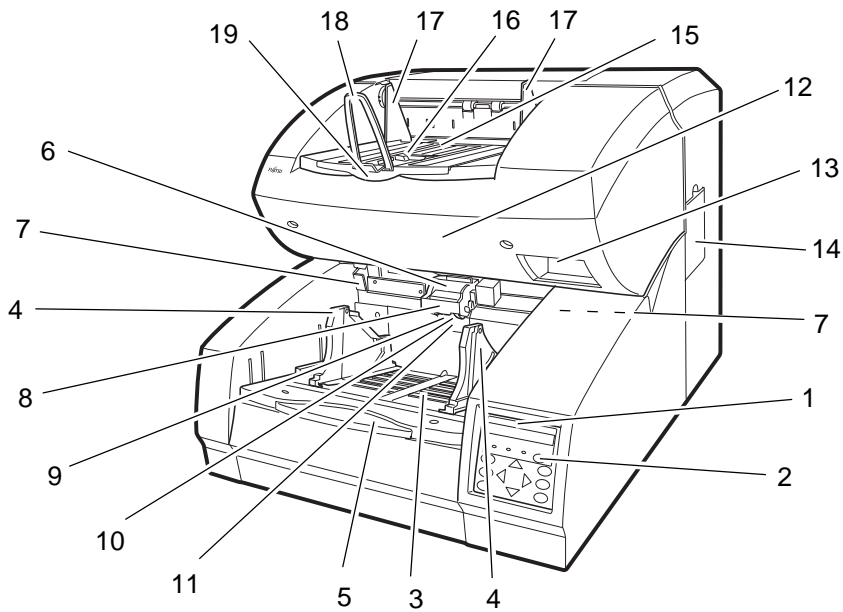

<b>No.</b>	<b>Name</b>	<b>Function</b>
1	Operator panel	Used to operate the scanner.
2	Power switch	Used to power on or off.
3	Hopper	Document input tray.
4	Hopper guides	Used to adjust the document width.
5	Hopper extension	For use with long documents.
6	Automatic document feeder (ADF)	Feeds documents automatically.
7	ADF release lever	Used to open the ADF.
8	Pick roller unit	Picks top page in document stack.
9	Guide plate	The pad is mounted on.
10	Pad	Separates top page from document stack.
11	Brake roller	Separates top page from document stack.
12	Upper transport unit	Opens for easy access.
13	Lever	Used to open the upper transport unit.
14	Side cover	Opens to access back-side lamp.
15	Stacker	Document exit tray.
16	Check stopper	Adjustable stopper for shorter length documents.
17	Stacker guides	Helps guide documents into stacker.
18	Stop lever	Used to keep documents in the stacker.
19	Stacker extension	For use with long documents.
20	Main line switch	Controls supply of line power to the scanner.
21	Power inlet	Power cable connection.
22	Interface connectors	Video and RS-232C
23	Interface connectors	Two SCSIs.

## ■ Assemblies

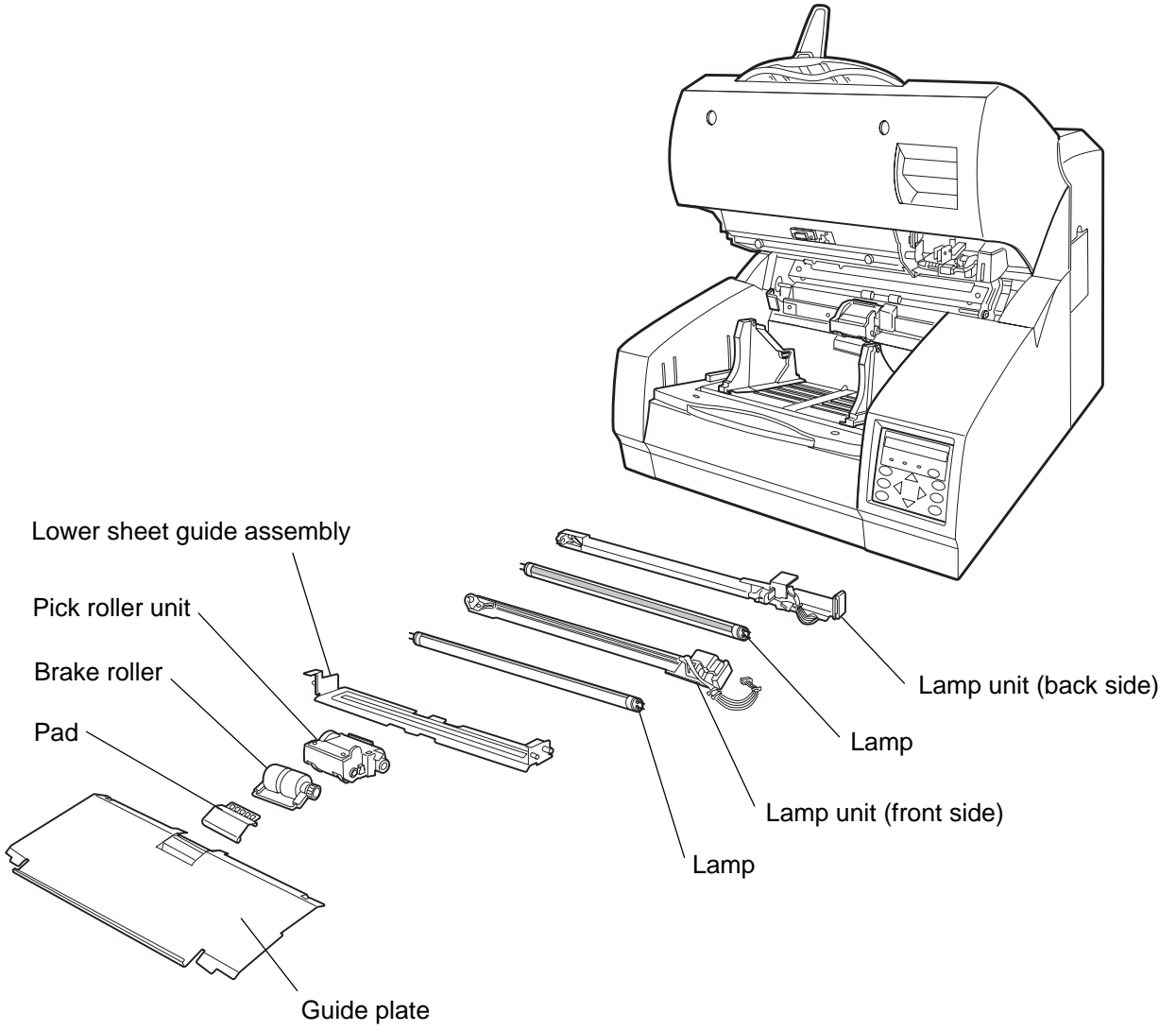

# Operator Panel

The operator panel is located at the lower right hand side of the scanner. The panel consists of an LCD (24 character x 2 line), LEDs, and buttons.



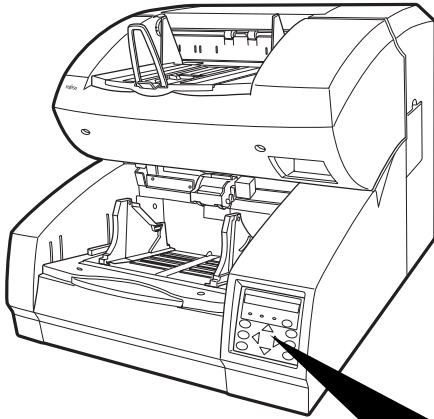



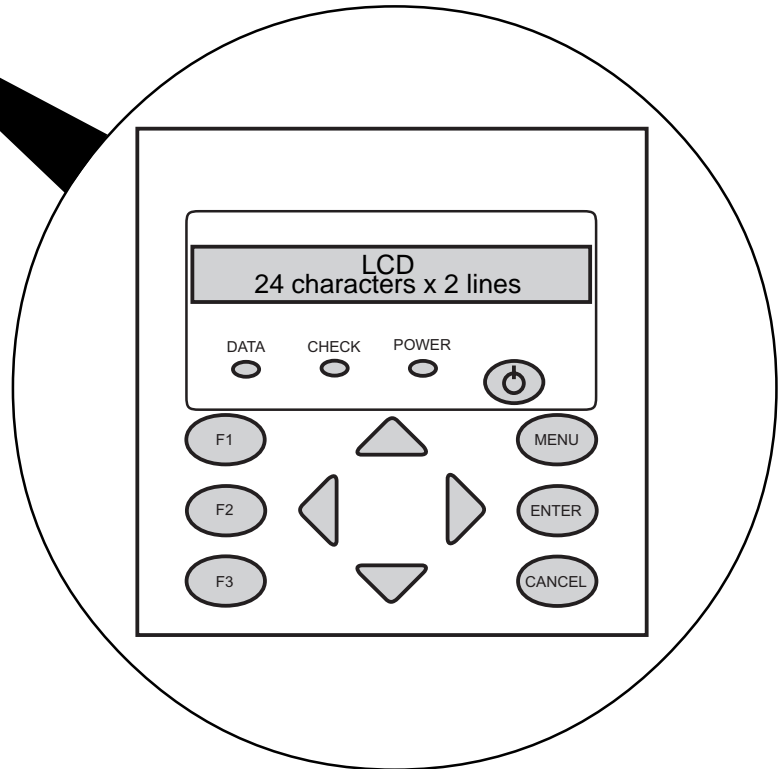

## ■ Arrangement

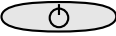



Operator panel

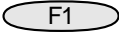
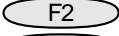
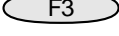

## ■ Button/LED Function

Button name	Function
	Turns on or off the power when the main line switch is set to "I".
	Sets the scanner in setup or browse mode. It is also used to set test mode. (See Chapter 6) Setup mode is used for customizing the scanner. Browse mode is used for glancing conditions of the scanner. Test mode is used for testing the scanner offline.
	Used in setup, browse, or test mode.
	<ul style="list-style-type: none"> <li>• Clears an error if any.</li> <li>• Stops current scanning when the video interface is used.</li> <li>• Used in setup, browse, or test mode.</li> </ul>
	<ul style="list-style-type: none"> <li>• Lifts the hopper in normal mode without errors.</li> <li>• Used in setup, browse, or test mode.</li> </ul>
	<ul style="list-style-type: none"> <li>• Lowers the hopper in normal mode without errors.</li> <li>• Used in setup, browse, or test mode.</li> </ul>
	Used in setup, browse, or test mode.
	Used in setup, browse, or test mode.
  	Available as shortcut keys when functions are defined in setup mode.

LED	Function
	Lights when the power is on.
	Lights when the image buffer contains data.
	Blinks when an equipment error occurs.

## ■ LCD Display

LCD	Function
	Displays equipment status or error contents.



## Operation status display

After power is turned on, the LCD indicates the following messages in normal mode.

Please wait

Wait for a moment. This is indicated when processing takes a long time.

When this is displayed after turning power on, the second line indicates initializing messages.

Ready

The scanner can receive a command from the host computer and can be set in setup or browse mode.

Manual Feeding

Load documents on the hopper table manually.

Feeding

The scanner is feeding documents. The second line indicates the number of documents fed per batch.

Transferring Data

The scanner is sending data to the host computer.

---

## Error status display

When the scanner detects errors, the LCD indicates the following messages. There are two types of errors: temporary errors and equipment errors.

Temporary errors:

The message is cleared just by following the next message.

Hopper empty

Mis-pick

Cover open

Equipment errors:

To clear the message, you must clean or replace the specified part.

Optical error: Front

# Buzzer

The scanner has a buzzer to indicate that an error has occurred or an operator panel button is pressed. The buzzer function can be set on or off by following the procedure “Buzzer” in Chapter 6 SETUP, BROWSE, AND TEST MODES.

<b>Sound condition</b>	<b>Function</b>
Error occurred	Sounds continuously. The buzzer turns off when any button is pressed or the power is turned off. Even when a button is pressed, the scanner continues to display the error.
Button pressed	Sounds briefly. This sound cannot be disabled by the buzzer setup.

# ***INSTALLATION AND CONNECTIONS***

---

*The chapter describes how to install and connect the scanner.*

**Precautions**

**Inspection**

**Cable Connection**

# Precautions



## **WARNING**

Place the machine with no portion of the scanner hangs over the desktop. Never attempt to move or relocate the machine without help. And hold the horizontal plane of the scanner bottom. (Not inclined plane)



## **ACHTUNG**

Stellen Sie den Scanner sicher auf eine waagerechte, ebene Fläche. Bewegen Sie den Scanner nicht ohne Hilfe.

This section describes precautions when installing the scanner.

Do not install the scanner in the following places and environments.

- Place the scanner away from electrical noise sources, strong magnetic fields and air flow. If the scanner is used near an air conditioner, copying machine, or TV set, the scanner may operate incorrectly.
- Keep the scanner out of the sun and away from heaters. These environments may shorten the scanner life or cause hardware failures.
- Do not install the scanner in a place where vibrations may occur. This environment may cause hardware failures or may cause the scanner to operate incorrectly.
- Do not install the scanner in a humid, dusty, or damp places. These environments may shorten the scanner life or cause hardware failures. Do not place the scanner where liquid spills may occur.
- Be aware of the static electricity. Be sure that the flooring and the desk are made of materials that do not generate the static electricity.

See Chapter 5 SPECIFICATIONS for the information such as the size of the installation space.



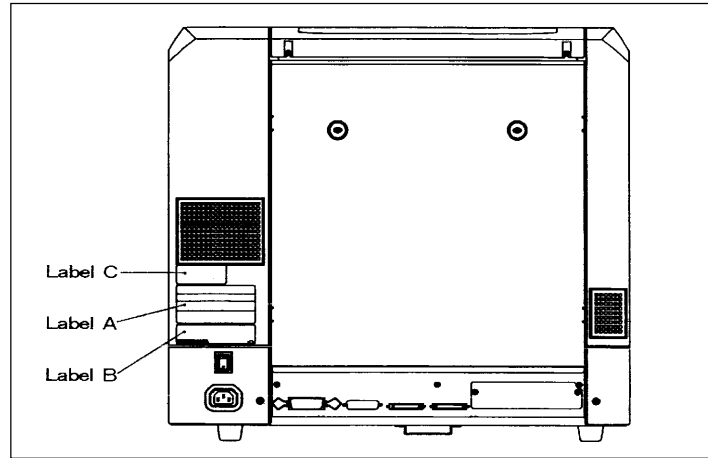

# Inspection

This section describes how to check the labels.

## Three labels



## Label A (An example)

この装置は、クラスA情報技術装置です。この装置を家庭環境で使用すると電波妨害を引き起こすことがあります。この場合には使用者が適切な対策を講ずるよう要求されることがあります。		
VCCI-A		
This device complies with Part 15 of the FCC Rules. Operation is subject to the following two conditions: (1) This device may not cause harmful interference, and (2) this device must accept any interference received including interference that may cause undesired operation.		
 LR53350 MITSUBISHI		 
電源を接続する前に必ず設置説明書をご覧ください。 See installation instructions before connecting to the supply. Voir la notice d'installation avant de raccorder au réseau. Bitte lesen sie die Bedienungs-Anleitung bevor sie das Gerät in Betrieb setzen.		

Label B (An example)

MODEL M4099D	IMAGE SCANNER		
PART NO. CA04315-B002		AC100-240V	
SER. NO.		1 phase	50/60Hz
DATE 1999-10		2.9/1.5A	65 kgf
<b>PFU Limited</b>		MADE IN JAPAN	

Label C (An example)

MODEL NAME	M4099D
PART NO.	CA04315-B002
MODEL	- 0 1 2 3 4 5 6 7 8 9
REV.	- 0 1 2 3 4 5 6 7 8 9
	- 0 1 2 3 4 5 6 7 8 9

# Cable Connection

This section describes how to connect the cables.

Connect the cables as follows:

## ■ Turning the main line switch off

Press “O” side of the main line switch to turn the power off.

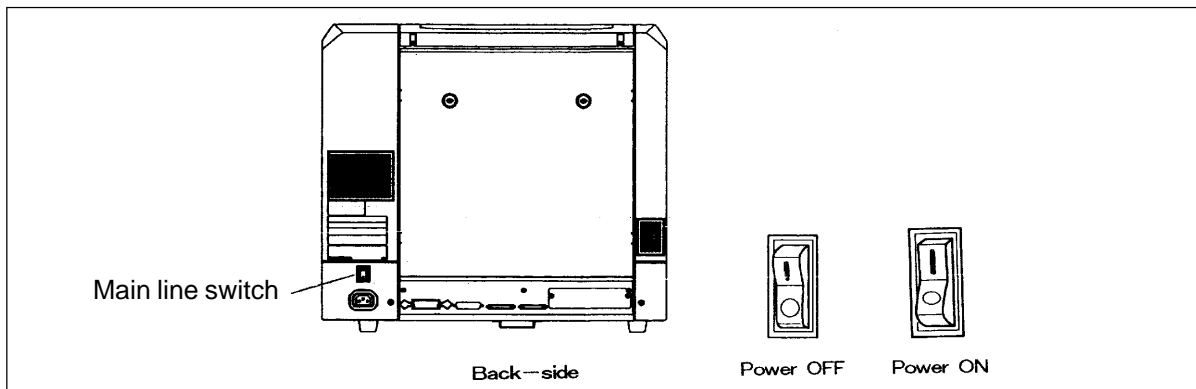

## ■ Connecting the power cable

Connect the power cable to the power inlet of the device and a power outlet.

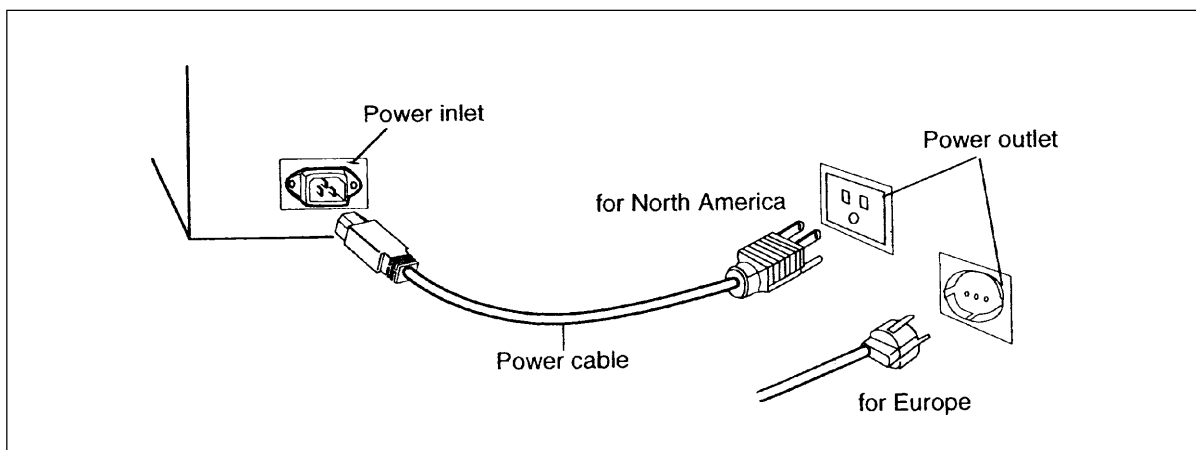

## ■ Connecting the interface cable

Connect the video interface, RS-232C interface, or SCSI interface cables and secure them with hooks or screws. Connect the other ends to the host computer.

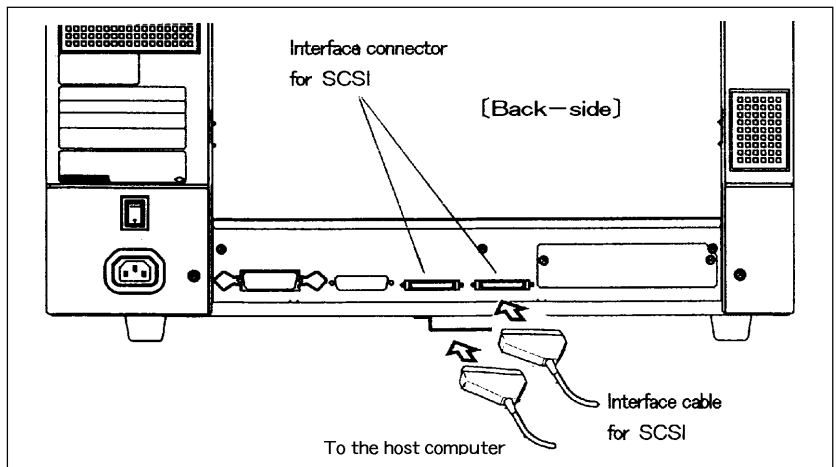
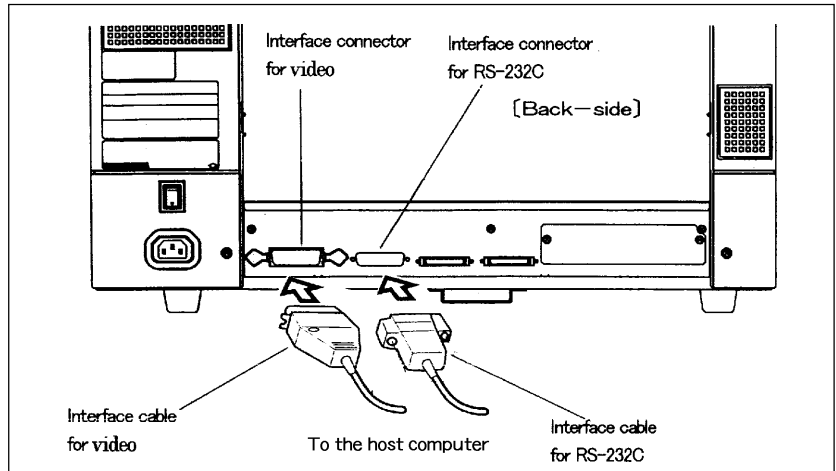

### NOTE

- SCSI-ID is set to No. 5 at shipment. Refer to Chapter 6 when changing the setting.
- No SCSI terminator is required for an open connector thanks to the automatic switch function.



# ***OPERATING INSTRUCTION***

---

*This chapter describes how to turn the power on, and also describes how to operate the operator panel (basic operation). Refer to Reference Guide about information on loading document and opening/closing the upper transport unit.*

**Turning the Power On**

**Basic Operation of the Operator Panel**

# Turning the Power On

This section describes how to turn the power on.

Press “I” side of the main line switch located at the back of the scanner. Press the power switch of the operator panel. The power goes on and the green POWER lamp at the operator panel lights.

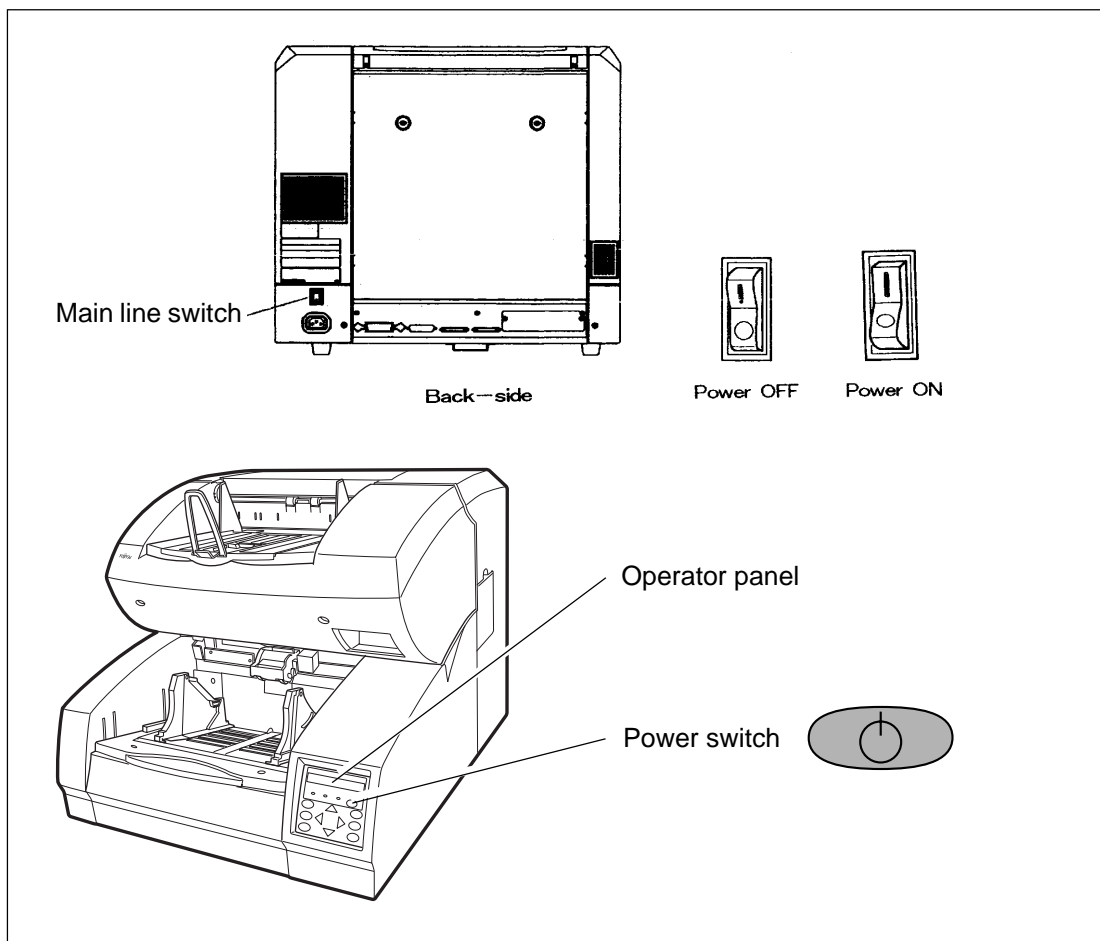

# Basic Operation of the Operator Panel

---

This section describes basic operation of the operator panel including how to enter the mode selection in which you can use setup mode, browse mode, and test mode.

## ■ Displaying detailed information if an error occurred

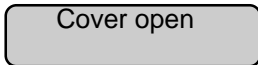

If an error occurs, the CHECK LED blinks and the error message is displayed on the LCD. For example, the LCD indicates as follows:



Press **CANCEL** to clear the error (depending on an error, it cannot be cleared).

---

## ■ Lifting or lowering the hopper

When the scanner has no error (the CHECK LED does not light), pressing  lifts the hopper and pressing  lowers the hopper.

### CAUTION

*During hopper height adjustment, do not touch the hopper table or do not put anything on the hopper table to prevent your fingers from being caught. If something is caught in the mechanism, the scanner may be damaged.*

This function is valid when:



Ready

is displayed.

In details:

- The DATA LED does not light (the scanner contains no data),
- The scanning operation is not in progress,
- The scanner is not in test mode (except the offline feed test), and
- The scanner is not in setup or browse mode.

The hopper stops at the pick position or at the 250-, 500-, or 1000-sheet position depending on the hopper height adjustment in setup mode. At the pick position, the top paper of stack (the hopper table when no paper is loaded on the hopper) is aligned to the pick roller. At the 250-sheet position, for example, the hopper table can load about 250 sheets of paper.

Each time you press  or , the hopper lifts or lowers by one position. Pressing  when paper is loaded, the hopper lifts up to the pick position.

---

## ■ Clearing a consumable life alarm

This scanner has the consumable counter to estimate the life of consumables. When the consumable counter reaches the prescribed value, the LCD indicates an alarm that the consumable may be expired. For example, the following message appears:

Consumable life alarm

In this case, press **CANCEL**. The LCD indicates the following message:

Reset Consumable Counter?  
Yes:Enter No:Cancel

Yes (press **ENTER**): The scanner resets the consumable counter to zero.

No (press **CANCEL**): The scanner does not reset the consumable counter. In this case, the consumable life alarm recurs when the next sheet is fed.

---

## ■ Confirming the number of sheets processed by the scanner



The LCD indicates the numbers of sheets scanned during online or in test mode (offline feed test).  
The LCD indicates the numbers as follows:

Scanning  
AAAAAAAA      MMMM

Value	Meaning	Description
AAAAAAAA	Abrasion counter	Eight columns of numbers indicate the accumulative number of sheets fed by this scanner.
MMMM	Batch counter	Four columns of numbers indicate the number of sheets fed per hopper.

---

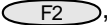
## ■ Using the function buttons (F1, F2, and F3)

This scanner has the three function buttons (, , and ) to one of which you can allot a setup function which involves tedious operation. Use these buttons as shortcut keys when you frequently use certain setup functions for your jobs. See Chapter 6 for details.

You can use function buttons after allocating a setup function to it. This allocation can be done in setup mode. After allocation, the allocated function can be easily accessed just by pressing the function button. For allocatable setup functions, see Chapter 6.

The function buttons are available when:

A rectangular button with rounded corners and a thin black border, containing the word "Ready" in a sans-serif font.

is displayed.

In details:

- The DATA LED does not light (the scanner contains no data),
- The scanning operation is not in progress,
- The scanner is not in test mode, and
- The scanner is not in setup or browse mode.

The function buttons are available even in the setup mode lock state (see Chapter 6).

---

## ■ Using the setup, browse, and test modes

This scanner has the setup mode, browse mode, and test mode for customizing the scanner, glancing setup conditions of the scanner, and testing the scanner offline respectively.

There are two ways to enter these modes:

- Press **MENU** when the LCD indicates “Ready”. [In this case, the test mode is unavailable.]
- Turn the power on while pressing **MENU**.

Available functions differ with the two ways. For details, see Chapter 6.

In the following way, you can use the setup mode and browse mode.

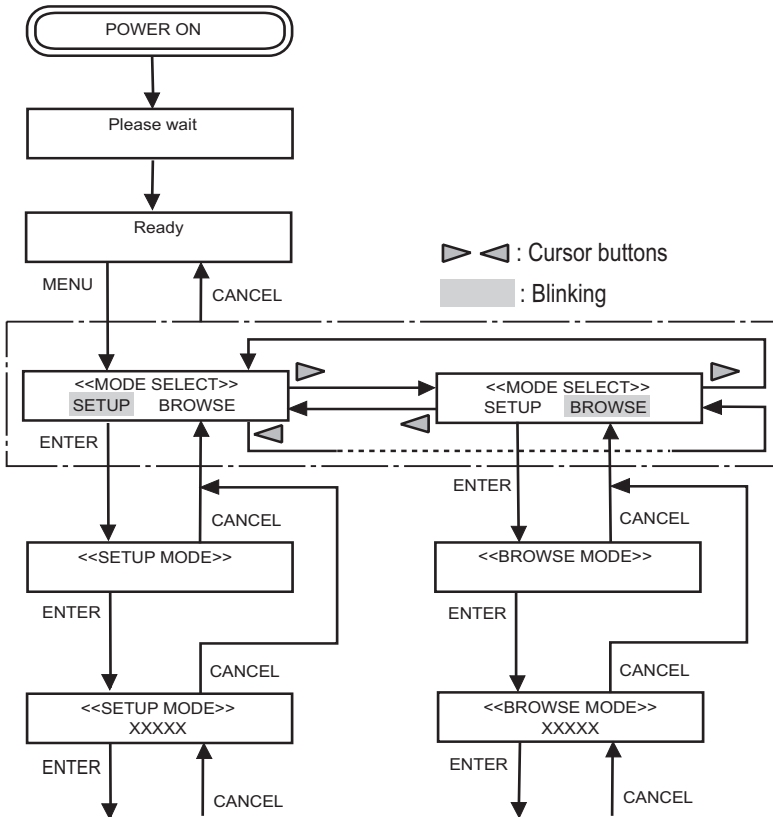



In the following way, you can use the test mode in addition to the setup mode and browse mode.  
To quit these modes, turn the power off.

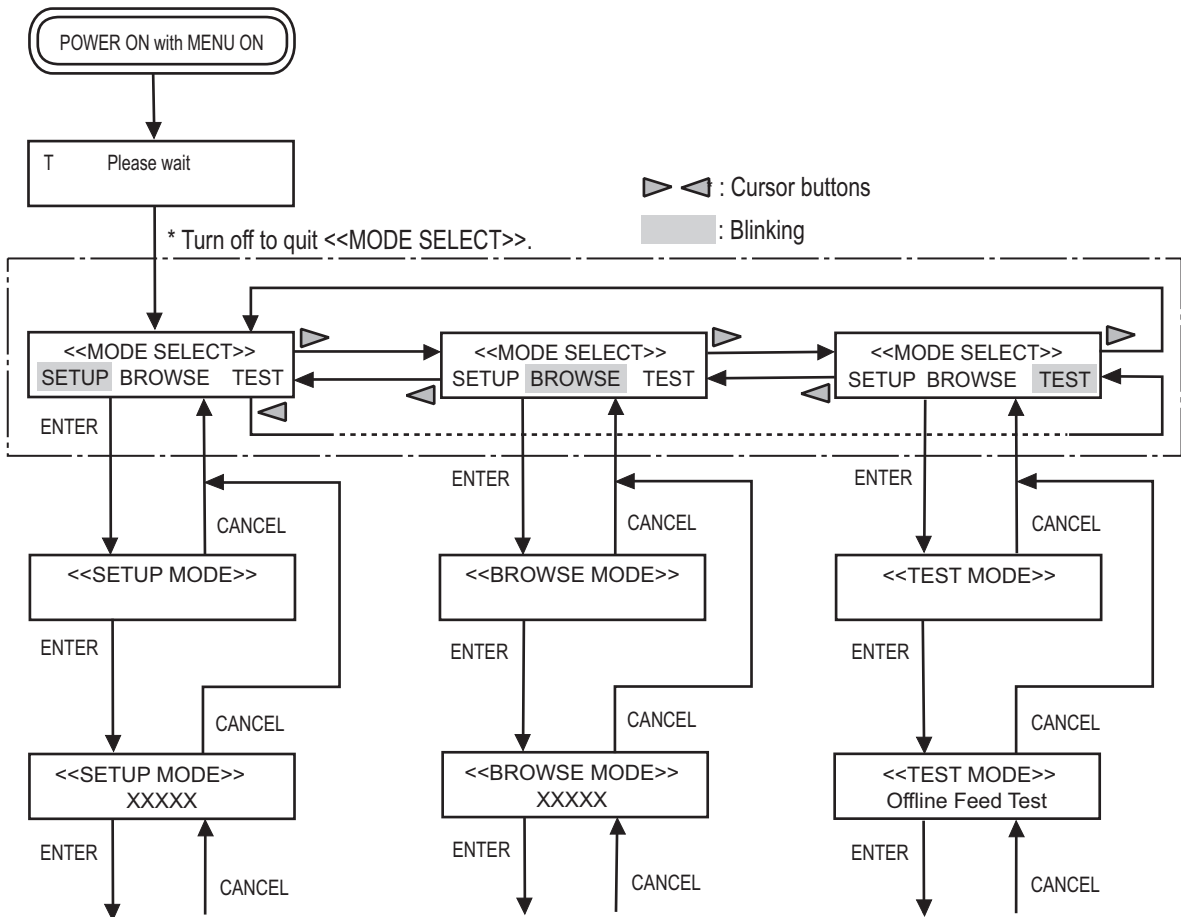

## ■ Transition of operator panel status and display

The following outlines the transition of status and display of the operator panel.

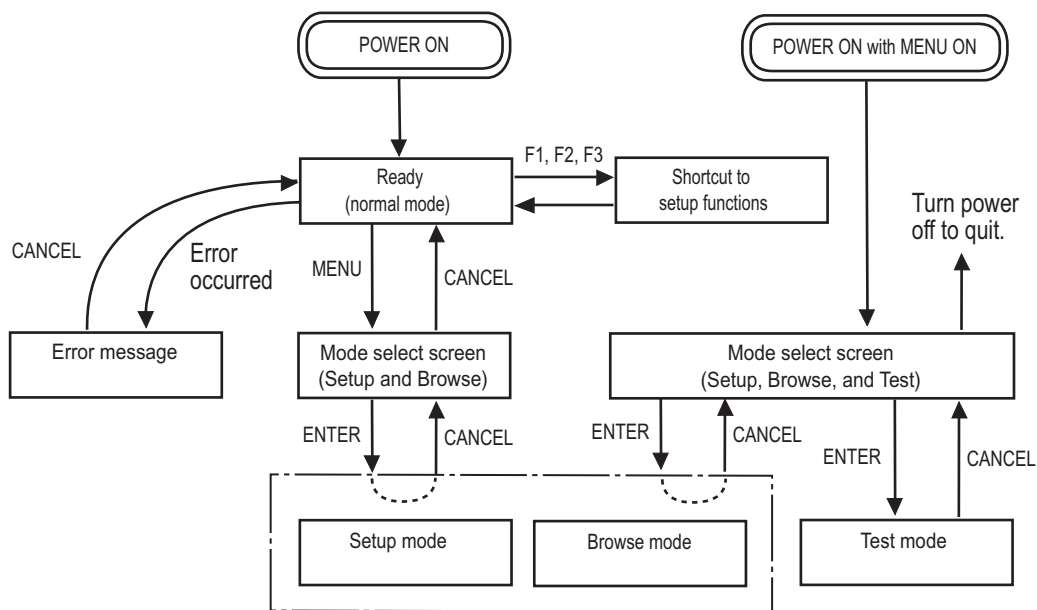

# ***DOCUMENT SPECIFICATION***

---

*This chapter describes the document size and document quality of the scanner.*

**Document Size**

**Document Quality**

# Document Size

The following figure shows document sizes that the scanner can read.

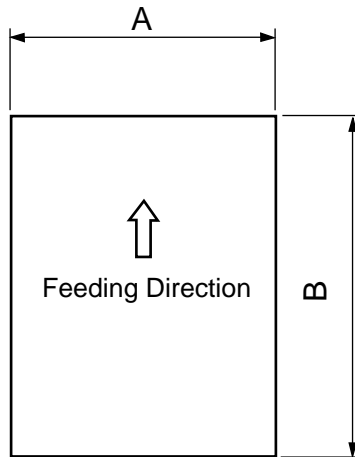

Scanner	Maximum		Minimum
	A	B	
M4099D	297 (11.7 in)	432 (17 in)	A7 size = 74 (2.9 in) x 105 (4.1 in): Available in both portrait and landscape orientations

(Unit : mm)

# Document Quality

---

This section describes paper types of documents and ream weights of paper available for the scanner, and precautions.

## ■ Paper types of documents

The recommended paper types of documents are as follows:



Use the specified paper. (Otherwise, double feeding or document damage may occur.)

- Fine paper
- Plain paper (for example, the paper specified for XEROX4024)
- OCR paper

When using any other paper types of documents, perform feed tests with the ADF in advance.



Because documents may be damaged when an error occurs, do not feed an important original document.

## ■ Ream weight of paper

The ream weight of paper is as follows:

- 52 to 127 g/m<sup>2</sup> (13.9 to 34 lb)



lb indicates the pound weight of 500 sheets of 17 x 22 inch paper (3.76 g/m<sup>2</sup>).

## ■ Precautions

Be careful not to scan the following document. Preliminary document feed test may be necessary to avoid the unexpected errors. If the document slips in ADF (JAM error) or double feed occurs frequently, refer to “Improving Document Separation” in Reference Guide.

- Paper with clips or staples
- Paper with wet ink
- Paper of which thickness is not constantly equal. (like envelope)
- Paper with large rumples or curl. (See NOTE on the next page.)
- Paper with folds or tears
- Tracing paper
- Coating paper
- Carbon paper
- Carbonless paper
- Paper smaller than A7 size, or larger than A3 size
- Other than paper: clothes, metal foils, or OHP films
- Photographic paper
- Paper with notches on its side
- Other than rectangle paper

When scanning a translucent document, set the density to light mode.

To prevent roller smudging, avoid scanning a document filled out in pencil. Clean the roller as often as possible when scanning many document. Once every 1000 sheets is recommended.

The chemical composition of some carbonless papers may react with the roller rubber and damage the rubber. Check the carbonless papers before use.

When using carbonless paper, follow these conditions:

- Ream weight of the paper is 52 g/m<sup>2</sup> (13.9 lb) or more.
- Hopper load is 500 sheets or fewer.

 **NOTE**

- If carbonless papers are used, clean the roller twice as often as usual.
- Documents should be straightened to fit the condition below.

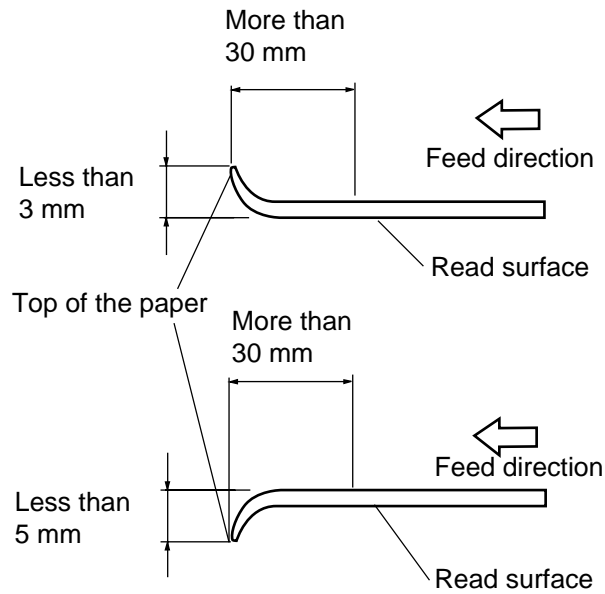

- When you read curled, wrinkled, or creased documents, documents may not be successfully arranged in the stacker.

# ***SPECIFICATIONS***

---

*This chapter describes the installation specifications, external dimensions, consumables, option.*

**Installation Specifications**

**External Dimensions**

**Consumables**

**Options**



# Installation Specifications

The following table lists the installation specifications of the scanner.

Item		Specification	
Dimensions (mm)	Width	590 (23.2 in)	
	Depth	690 (27.2 in)	
	Height	540 (21.3 in) without optional endorser 610 (24.0 in) with optional endorser	
Weight (kg)		65 (143 lb.)	
Input power	Voltage	100 to 240 VAC $\pm$ 10 %	
	Phases	Single-phase	
	Frequency	50/60 Hz + 2% -4%	
Power consumption		250 VA or less	
Ambient condition	Device status	Operating	Not operating
	Temperature	15 to 35°C (60 to 95°F)	-20 to 60°C (-4 to 140°F)
	Humidity	20 to 80 %	8 to 95 %
Life of the scanner		5 years or 2,000,000 sheets	

## NOTE

- The life span of this scanner is 5 years after you purchase the scanner or 2,000,000 scanned sheets, whichever comes first.
- If you are using the scanner after the expiration of the scanner life, the scanner may be damaged or the reading performance may be degraded.

# External Dimensions

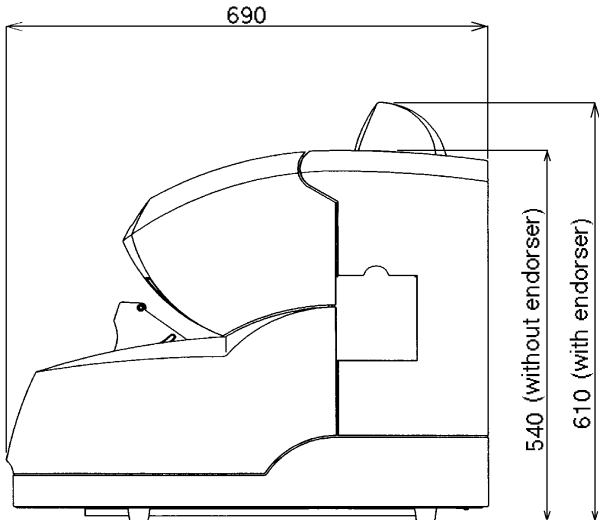
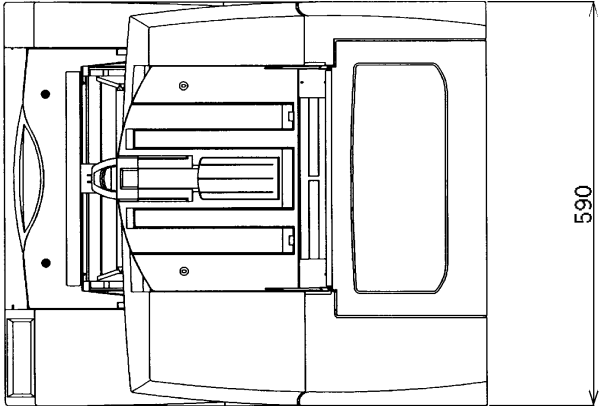

(unit: mm)

# Consumables

The following table lists consumables used for the scanner. Be sure to prepare consumables before their expiration. Customer is responsible to change these consumables periodically. The consumable counter can be used to check the number of scanned documents. (See page 3-4.)

Name	Specification	Service life and remarks
Lamp	CA04315-0430	1000 hours or more. Two lamps used per scanner.
Brake roller	CA04315-F705	300,000 sheets or one year.
Pick roller unit	CA04315-F711	300,000 sheets or one year.
Pad	CA04315-G730	300,000 sheets or one year.
Print head	CA01023-0701	20,000 sheets (10 characters/sheet). Black ink cartridge for endorser.

## NOTE

- The above values are not absolute ones, but show guidelines. These service lives (replacement cycles) may be shortened depending on paper types of documents scanned or the degree of cleaning the scanner.
- When using special paper like carbon-less paper, the replacement cycle is shortened. So, these parts need replacing earlier than the above.

# Options

The following table lists options of this scanner.

Name	Specification	Remark
Endorser	CA04315-D201	Ink jet printing method <ul style="list-style-type: none"><li>• Back-side print</li><li>• Max. 30 characters</li></ul>
Black background kit	CA04315-E250	

Contact your Fujitsu sales agent for more information.

# ***SETUP, BROWSE, AND TEST MODES***

---

*This chapter describes the setup, browse, and test modes of the scanner.*

**Setup, Browse, and Test Modes**

**Activating the Setup or Browse Mode**

**Contents of the Setup or Browse Mode**

**Activating the Test Mode**

**Contents of the Test Mode**

# Setup, Browse, and Test Modes

This scanner has the setup mode, browse mode, and test mode to ease setting up.

- Setup mode for customizing the scanner for user requirements
- Browse mode for glancing setup conditions of the scanner
- Test mode for testing the scanner offline

There are two ways to enter these modes:

- Way 1

Press **MENU** when the LCD indicates “Ready”.

You can use the setup mode and browse mode. To quit a mode, press **CANCEL**.

- Way 2

Turn the power on while pressing **MENU**.

You can use the test mode in addition to the setup mode and browse mode. To quit a mode, turn off the power.

Available functions differ with modes or with ways. For details, see descriptions of each function.

## ■ Functions not available in setup mode

Way	Functions not available
<b>MENU</b> pressed in Ready status	Interface, TP_IF baud rate, RS232C baud rate, SCSI ID, Product ID, Function key, Setup mode lock, Black background
Power on with <b>MENU</b> pressed	Settings

## ■ Functions not available in browse mode

Functions not available
Paper thickness setup

# Activating the Setup or Browse Mode

To activate the setup mode, follow these steps:

1. While the LCD is indicating "Ready", press **MENU**.  
The <<MODE SELECT>> screen appears with "SETUP" blinking.
2. Press **ENTER**.  
The <<SETUP MODE>> initial screen (\*) appears.
3. Press **ENTER**.  
The <<SETUP MODE>> menu screen (\*\*) appears.

Ready

<<MODE SELECT>>  
SETUP BROWSE

\* <<SETUP MODE>> Initial screen

<<SETUP MODE>>





\*\* <<SETUP MODE>> menu screen

<<SETUP MODE>>  
XXXXX

To activate the browse mode, press  before step 2 to make "BROWSE" blinking, then follows steps 2 and 3. The <<BROWSE MODE>> screen appears.

To quit the setup mode, press **CANCEL**.

## ■ Button functions in setup or browse mode

Button name	Function
<b>MENU</b>	Returns to the <<SETUP MODE>> menu screen without saving the change (*).
<b>ENTER</b>	Returns to the previous screen while saving the change (*).
<b>CANCEL</b>	Returns to the previous screen without saving the change (*).
	<ul style="list-style-type: none"> <li>• Displays the next function at the right in the menu.</li> <li>• Moves to the right item.</li> </ul>
	<ul style="list-style-type: none"> <li>• Displays the next test function at the left in the menu.</li> <li>• Moves to the left item.</li> </ul>
	Changes parameters.
	Changes parameters.

\* In browse mode, "saving the change" does not occur.

## ■ Mode selection (MENU pressed in Ready status)

There is another mode selection which enables you to execute the user test on the scanner without the host computer. See “Activating the Test Mode” later in this chapter.

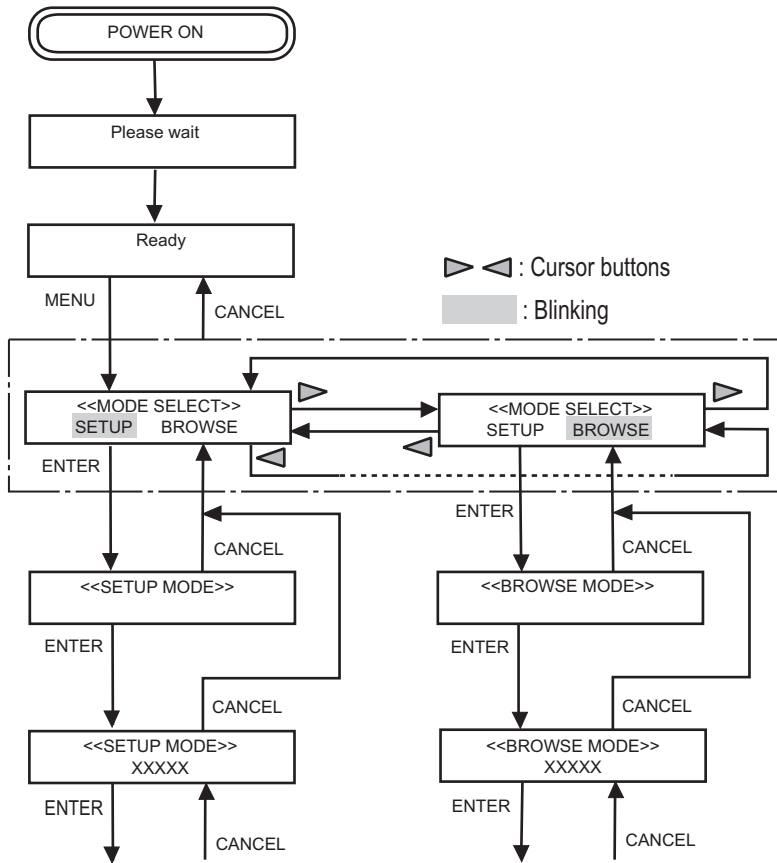



# Contents of the Setup or Browse Mode

This section describes the contents of the setup mode.  
The setup mode can be classified into 26 types.

Setup item	Description	Remarks
Settings	Sets simplex/duplex scanning, paper size, density, resolution, and halftone.	<ul style="list-style-type: none"> <li>• Not displayed in setup mode selected by turning power on with <b>MENU</b> pressed.</li> <li>• Displayed when the video or TP interface is used.</li> <li>• Parameters set by the host computer cannot be changed.</li> </ul>
Paper length check	Enables or disables the function which detects a paper length error.	The selection set by the host computer cannot be changed.
Paper thickness check	Makes the paper thickness detection function enabled or disabled, and sets the detection method.	The selection set by the host computer cannot be changed.
Paper thickness setup	Sets the permissible paper thickness to detect a double feed error.	
Skew check	Enables or disables the function which detects a skew error.	
IPC-3 mode	Selects a pattern to be set in the image processing option.	Overrides the selection set by the host computer.
Hopper height	Sets the initial position of the hopper.	
Paper separation level	Sets the power of separating sheets of paper.	
Drop-out color	Selects a drop-out color.	The selection set by the host computer cannot be changed.
Consumable counter	Sets the interval (in ten thousands) in which a consumable alarm occurs.	
Consumable counter reset	Resets the accumulated count of the consumable counter.	Displayed in setup mode selected by turning power on with <b>MENU</b> pressed.
Consumable alarm mode	Sets how to notify the alarm when the accumulated count of the consumable counter reaches the set value.	Displayed in setup mode selected by turning power on with <b>MENU</b> pressed.
Buzzer	Activates or inactivates the buzzer sound when an error occurs.	
Buzzer volume	Sets the volume of buzzer or click sound.	
LCD contrast	Sets the contrast of the LCD.	
Picking speed	Selects the speed of the pick roller.	

Setup item	Description	Remarks
Interface	Selects the host interface.	Displayed in setup mode selected by turning power on with <b>MENU</b> pressed.
TP_IF baud rate	Selects the control data transfer rate (2400, 4800, 9600, or 19200) for the TP interface.	Displayed in setup mode selected by turning power on with <b>MENU</b> pressed.
RS232C baud rate	Selects the transfer rate (2400, 4800, 9600, or 19200) for the RS-232C interface.	Displayed in setup mode selected by turning power on with <b>MENU</b> pressed.
SCSI ID	Sets the SCSI ID of this scanner.	Displayed in setup mode selected by turning power on with <b>MENU</b> pressed.
Product ID	Sets the product ID of this scanner.	Displayed in setup mode selected by turning power on with <b>MENU</b> pressed.
Pre-pick	Enables or disables pre-picking.	
Pick start time	Sets the period from when paper is loaded manually to when the pick operation starts.	
Manual feed timeout	Sets the waiting period from when the host computer issues a scan command to when paper is loaded manually.	
Paper pick retry	Sets the pick motor operation time and retry count.	
Paper feed retry	Sets the feed motor operation time and retry count.	
Function key	Allocates setup functions to <b>F1</b> , <b>F2</b> , and <b>F3</b> buttons.	Displayed in setup mode selected by turning power on with <b>MENU</b> pressed.
Setup mode lock	Inhibits the operator panel from entering setup mode from normal mode.	<ul style="list-style-type: none"> <li>• Displayed in setup mode selected by turning power on with <b>MENU</b> pressed.</li> <li>• Setup functions allocated to <b>F1</b>, <b>F2</b>, and <b>F3</b> buttons are always valid regardless of this setting.</li> </ul>
Black background	Set this function enabled when the black background is mounted.	Displayed in setup mode selected by turning power on with <b>MENU</b> pressed.
Language	Selects an operation panel LCD language (Japanese or English).	
White follower mode	Sets how to follow the white color as the reference.	Displayed in setup mode selected by turning power on with <b>MENU</b> pressed.



## ■ Settings

This function sets simplex/duplex scanning mode, paper size/orientation, density, resolution, and halftone processing. It is valid when the scanner operates in normal mode through the video or TP (third party) interface. It is also valid in the offline feed test in test mode. You cannot change settings if they are set by the host computer.

LCD display	Options	Remarks
Settings	<p>S/D: xxx: A3P, DLP, LGP, B4P, A4P, LTP, B5P, A5P, A4L, LTL, B5L, A5L, NPS</p> <p>■ □ ● ● □ (5 combinations), AT1, AT2</p> <p>xxx: 200, 240, 300, 400 xxx: LA, HT1, HT2, LH1, LH2</p>	<p><b>Scanning mode</b> (simplex or duplex) <b>Paper size/orientation</b> P: portrait L: landscape An: standard size A Bn: standard size B DL: double letter LG: legal LT: letter NPS: nonstandard size, displayed if it is set by the host computer</p> <p><b>Density</b> ■ □ □ □ □: Light ■ ■ ■ ■ ■: Dark AT1: automatic AT2: simple automatic</p> <p><b>Resolution</b> (unit: dpi) <b>Halftone processing</b> LA: line art (no halftone) HT1: dither HT2: error diffusion LH1: line art for character area and dither for halftone area LH2: line art for character area and error diffusion for halftone area</p>

\* Symbols of density may differ from the actual symbols used in the LCD.

The following is an example of operation when you change the resolution.

### NOTE

- The “Settings” screen does not appear when your scanner is not controlled through the video or TP interface.
- You cannot use this function when the setup mode is brought by turning power on with  pressed.

1. In <<SETUP MODE>> initial screen, press **ENTER**.  
The <<SETUP MODE>> menu screen (Settings) appears.

<<SETUP MODE>>

<<SETUP MODE>>  
Settings

2. Press **ENTER** again.  
The option list screen indicates the current options with S blinking (blinking indicates "selected").



S	A4P	AT2	200	LA
		AT2		LA

3. Press  three times.  
The current resolution 200 blinks.

S	A4P	AT2	200	LA
		AT2		LA

4. Press **ENTER**.  
RESOLUTION screen appears with 200 blinking (blinking indicates "changeable").

RESOLUTION  
200

5. Press  or .  
The displayed option changes (240, 300, or 400).

RESOLUTION  
400

6. When the desired value appears, press **ENTER** to save the change.  
The option list screen appears with the new value blinking.

S	A4P	AT2	400	LA
		AT2		LA

7. Press **CANCEL** three times.  
The LCD returns to the Ready screen.

Ready

## ■ Paper length check

This function sets and detects a difference in paper length. You cannot change settings if they are set by the host computer.

LCD display	Options	Remarks
Paper Length Check	On, Off (Default: Off) 10 mm, 15 mm, 20 mm (Default: 10 mm)	<b>Checked or not</b> <b>Difference:</b> XX mm means that it is not regarded as an error when the actual difference of paper length is within the limits of $\pm XX$ mm.

The following is an example of operation when you use this function.

- In <<SETUP MODE>> initial screen, press **ENTER**.  
The <<SETUP MODE>> menu screen (Settings) appears.

<<SETUP MODE>>

<<SETUP MODE>>  
Settings

### NOTE

The “Settings” screen does not appear and the “Paper Length Check” screen first appears when your scanner is not controlled through the video or TP interface.

- When the menu screen indicates “Settings”, press .  
The <<SETUP MODE>> menu screen (Paper Length Check) appears.



<<SETUP MODE>>  
Paper Length Check

- Press **ENTER**.  
The option select screen indicates the current options with ON blinking (blinking indicates “changeable”).

Paper Length Check  
ON 10 mm

4. Press .  
The current difference 10 mm blinks (blinking indicates “changeable”).

Paper Length Check  
ON 10 mm

5. Press  or .  
The displayed option changes (15 mm or 20 mm).

Paper Length Check  
ON 20 mm

6. When the desired value appears, press  to save the change.  
The LCD returns to the <<SETUP MODE>> menu screen (Paper Length Check).

<<SETUP MODE>>  
Paper Length Check

7. Press  two times.  
The LCD returns to the Ready screen.

Ready

## ■ Paper thickness check

This function determines whether or not to enable the paper thickness which is set by the “paper thickness setup” function to detect a double feed error. You cannot change settings if they are set by the host computer.

LCD display	Options	Remarks
Paper Thickness Check	Off, Thickness & Roller, Thickness Check (Default: Off)	Off: sets the double feed check disabled. Thickness & Roller: detects a double feed error by checking the document transmissivity and the rotation of the brake roller. Thickness Check: detects a double feed error by checking the document transmissivity.

The following is an example of operation when you use this function.



1. In <<SETUP MODE>> initial screen, press **ENTER**.  
The <<SETUP MODE>> menu screen (Settings or Paper Length Check) appears.

 **NOTE**

The “Settings” screen does not appear and the “Paper Length Check” screen first appears when your scanner is not controlled through the video or TP interface.

2. Press .  
The <<SETUP MODE>> menu screen (Paper Thickness Check) appears.

3. Press **ENTER**.  
The option select screen appears with the current option OFF blinking (blinking indicates “changeable”).

4. Press  or .  
The displayed option changes (Thickness & Roller blinks).

5. Press **ENTER** to save the change.  
The LCD returns to the <<SETUP MODE>> menu screen (Paper Thickness Check).

6. Press **CANCEL** two times.  
The LCD returns to the Ready screen.

<<SETUP MODE>>

<<SETUP MODE>>  
Settings

<<SETUP MODE>>  
Paper Length Check

<<SETUP MODE>>  
Paper Thickness Check

Paper Thickness Check  
OFF

Paper Thickness Check  
Thickness & Roller

<<SETUP MODE>>  
Paper Thickness Check

Ready

## ■ Paper thickness setup

This function sets the paper thickness which is used as the reference for detecting a double feed error. Whether this function is enabled or disabled is determined by the “paper thickness check” function in setup mode.

 **NOTE**

This setting cannot be displayed in browse mode.

The following is an example of operation when you use this function.



1. In <<SETUP MODE>> initial screen, press **ENTER**.  
The <<SETUP MODE>> menu screen (Settings or Paper Length Check) appears.

 **NOTE**

The “Settings” screen does not appear and the “Paper Length Check” screen first appears when your scanner is not controlled through the video or TP interface.

2. Press  twice.  
The <<SETUP MODE>> menu screen (Paper Thickness Setup) appears.
3. Press **ENTER**.  
The paper load prompting screen appears, requesting adjustment paper.
4. Select thickest paper used for your jobs and put the paper on the hopper.
5. Press **ENTER**.  
The “Adjusting!!” message appears. The scanner lifts the hopper, feeds the paper, and adjusts the sensing level of the sensor, then saves its value.  
After ejecting the sheet, the “Finished!!” message appears for two seconds, then the LCD returns to the <<SETUP MODE>> menu screen (Paper Thickness Setup).  
*If an error (for example, Mis-pick) occurs during adjustment, remove the paper and press **CANCEL**. The paper load prompting screen appears again. Repeat steps 4 and 5.*
6. Press **CANCEL** two times.  
The LCD returns to the Ready screen.

<<SETUP MODE>>

<<SETUP MODE>>  
Settings

<<SETUP MODE>>  
Paper Length Check

<<SETUP MODE>>  
Paper Thickness Setup

Paper Thickness Setup  
Set the adjustment paper

Paper Thickness Setup  
Adjusting!!

Paper Thickness Setup  
Finished!!

<<SETUP MODE>>  
Paper Thickness Setup

Ready

## ■ Skew check

This function determines if abnormal skew is detected or not. You cannot change the setting if it is set by the host computer.



LCD display	Options	Remarks
Skew Check	On, Off (Default: Off)	

The following is an example of operation when you use this function.

- In <<SETUP MODE>> initial screen, press **ENTER**.  
The <<SETUP MODE>> menu screen (Settings or Paper Length Check) appears.

### NOTE

The “Settings” screen does not appear and the “Paper Length Check” screen first appears when your scanner is not controlled through the video or TP interface.

- Press  three times.  
The <<SETUP MODE>> menu screen (Skew Check) appears.
- Press **ENTER**.  
The option select screen appears with the current option OFF blinking (blinking indicates “changeable”).
- Press  or .
- The displayed option changes (ON blinks).
- Press **ENTER** to save the change.  
The LCD returns to the <<SETUP MODE>> menu screen (Skew Check).
- Press **CANCEL** two times.  
The LCD returns to the Ready screen.

<<SETUP MODE>>

<<SETUP MODE>>  
Settings

<<SETUP MODE>>  
Paper Length Check

<<SETUP MODE>>  
Skew Check

Skew Check  
Check: OFF

Skew Check  
Check: ON

<<SETUP MODE>>  
Skew Check

Ready

## ■ IPC-3 mode

This function selects a pattern to be set in the IPC-3 image processing feature.



LCD display	Options	Remarks
IPC-3 Mode	0, 1, 2, 3, 4, 5	0: do not select any pattern 1 to 5: select pattern numbers 1 to 5

The following is an example of operation when you use this function.

- In <<SETUP MODE>> initial screen, press **ENTER**.  
The <<SETUP MODE>> menu screen (Settings or Paper Length Check) appears.

### NOTE

The “Settings” screen does not appear and the “Paper Length Check” screen first appears when your scanner is not controlled through the video or TP interface.

- Press  four times.  
The <<SETUP MODE>> menu screen (IPC-3 Mode) appears.
- Press **ENTER**.  
The option select screen appears with the current setting 0 blinking (blinking indicates “changeable”).
- Press  or .
- The displayed option changes (1, 2, 3, 4, 5).
- When the desired pattern number appears, press **ENTER** to save the change.  
The LCD returns to the <<SETUP MODE>> menu screen (IPC-3 Mode).

<<SETUP MODE>>

<<SETUP MODE>>  
Settings

<<SETUP MODE>>  
Paper Length Check

<<SETUP MODE>>  
IPC-3 Mode

IPC-3 Mode  
0

IPC-3 Mode  
5

<<SETUP MODE>>  
IPC-3 Mode

 **NOTE**

When you set from the Function Key, the dialogue appears whether you want to save the revised data. If you want to save the process, press **ENTER**. If you do not want to save the process, press **CANCEL**.

6. Press **CANCEL** three times.  
The LCD returns to the Ready screen.

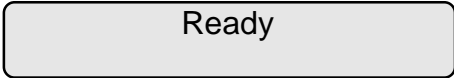

● **Paper types and corresponding pattern numbers**

User's paper is classified into five types in line art (no halftone) mode as shown in the following table.

- The horizontal axis shows the density and color of background on paper.
- The vertical axis shows the density of characters or lines.

		Background density		Background color		
		Normal ←	→ Dark	Red	Green	Blue
Character density	Normal ↑	1: Normal background and normal character	3: Dark background and normal character			
	Light ↓	2: Normal background and light character		4: Light character on red or similar background	5: Light character on green or similar background	

\* 1 to 5 are pattern numbers.

 **NOTE**

When IPC-3 mode is executed in online status, the reading parameter is valid or invalid (host setting is invalid) as follows:

## ● Reading parameter validity

	Reading parameter							
	Reading mode	Transfer mode	Transfer rate	Reduction	Start of reading	Density	Line-art/Photo	Halftone
Valid	X	X	X	X	X			
Invalid						X	X	X

	Reading parameter							
	DTC	Size	Portrait/Landscape	Picking	Document selection	r patterns	Contrast	Automatic separation
Valid		X	X	X	X			
Invalid	X					X	X	X

	Reading parameter					
	Conversion	Sharpness	Outline extraction	Overlay	Simplified DTC	Zooming
Valid	X					X
Invalid		X	X	X	X	

## ■ Hopper height

This function sets the initial height of the hopper. Set the height which you frequently use.



LCD display	Options	Remarks
Hopper Height	250 sheets, 500 sheets, 1000 sheets	

The following is an example of operation when you use this function.



1. In <<SETUP MODE>> initial screen, press .  
The <<SETUP MODE>> menu screen (Settings or Paper Length Check) appears.

 **NOTE**

The “Settings” screen does not appear and the “Paper Length Check” screen first appears when your scanner is not controlled through the video or TP interface.

2. Press  repeatedly until “Hopper Height” appears in the lower line of the menu screen.
3. Press .  
The option select screen appears with the current height setting 1000 sheets blinking (blinking indicates “changeable”).
4. Press .  
The hopper moves to the 500-sheet position and the new height setting 500 sheets blinks.

 **NOTE**

Each time you press  or , the hopper moves to the next position and its position is automatically saved. Repeat this operation until the hopper is positioned at the desired height.

*If an error occurs during positioning, press . The LCD returns to the option select screen. Repeat step 4.*

<<SETUP MODE>>

<<SETUP MODE>>  
Settings

<<SETUP MODE>>  
Paper Length Check

<<SETUP MODE>>  
Hopper Height

Hopper Height  
1000 sheets

Hopper Height  
500 sheets

5. Press **CANCEL** three times.  
The LCD returns to the Ready screen.

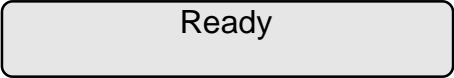

After this setting, the hopper is set at the new height whenever power is turned on.

## ■ Paper separation level



This function sets the power of the brake roller for proper paper separation in picking documents.

LCD display	Options	Remarks
Paper Separation Level	Thick, Medium Thick, Normal, Medium Thin, Thin (Default: Normal)	Thick: strong braking power for thick paper   (changes according to paper thickness) Thin: weak braking power for thin paper

If the following errors frequently occur, set the braking power as explained below.

- Double feed
- Mis-pick
- SF2 did not detect leading edge of paper

Set “braking power” according to the table below.

Setting	Braking power	“Double feed” frequently occurs.	“Mis-pick” or “SF2 ...” frequently occurs.
Thick	Strong	 <p>Make the braking power stronger.</p>	 <p>Make the braking power weaker.</p>
Medium Thick	Less strong		
Normal	Medium (factory default)		
Medium Thin	Less weak		
Thin	Weak		



The following is an example of operation when you use this function.

1. In <<SETUP MODE>> initial screen, press **ENTER**.  
The <<SETUP MODE>> menu screen (Settings or Paper Length Check) appears.



**NOTE**

The “Settings” screen does not appear and the “Paper Length Check” screen first appears when your scanner is not controlled through the video or TP interface.

2. Press  repeatedly until “Paper Separation Level” appears in the lower line of the menu screen.
3. Press **ENTER**.  
The option select screen appears with the current option Normal blinking (blinking indicates “changeable”).
4. Press  or .  
The displayed option changes (Thick to Thin).
5. When the desired option appears, press **ENTER** to save the change.  
The LCD returns to the <<SETUP MODE>> menu screen (Paper Separation Level).
6. Press **CANCEL** two times.  
The LCD returns to the Ready screen.

<<SETUP MODE>>

<<SETUP MODE>>  
Settings

<<SETUP MODE>>  
Paper Length Check

<<SETUP MODE>>  
Paper Separation Level

Paper Separation Level  
Normal

Paper Separation Level  
Medium Thin

<<SETUP MODE>>  
Paper Separation Level

Ready



## ■ Drop-out color

This function sets a drop-out color for front and back sides of paper respectively. You cannot change settings if they are selected by the host computer.



LCD display	Options	Remarks
Drop-out Color	Front: Green, Red, Blue (Default: Green) Back: Green, Red, Blue (Default: Green)	

The following is an example of operation when you use this function.

- In <<SETUP MODE>> initial screen, press **ENTER**.  
The <<SETUP MODE>> menu screen (Settings or Paper Length Check) appears.

### NOTE

The “Settings” screen does not appear and the “Paper Length Check” screen first appears when your scanner is not controlled through the video or TP interface.

- Press  repeatedly until “Drop-out Color” appears in the lower line of the menu screen.
- Press **ENTER**.  
The option select screen appears with the current setting Green (for Front) blinking (blinking indicates “changeable”).
- Press .  
Green (current option for Back) blinks (blinking indicates “changeable”).

<<SETUP MODE>>





<<SETUP MODE>>  
Settings

<<SETUP MODE>>  
Paper Length Check

<<SETUP MODE>>  
Drop-out Color

Drop-out Color  
Front: Green Back: Green

Drop-out Color  
Front: Green Back: Green

5. Press  or .  
The displayed option changes (Blue or Red).
6. When the desired option appears, press  to save the change.  
The LCD returns to the <<SETUP MODE>> menu screen (Drop-out Color).
7. Press  two times.  
The LCD returns to the Ready screen.

Drop-out Color  
Front: Green Back: Red

<<SETUP MODE>>  
Drop-out Color

Ready

## ■ Consumable counter

This function displays or sets a value of the counter which informs the user of the life (replacement cycle) of a consumable. When the number of sheets fed reaches the set value, an alarm occurs. Set this value according to types of paper you use. When using fine paper, the standard replacement cycle of pick roller units, brake rollers, and pads is per three hundred thousands of sheets fed. So, we recommend you to set the value to 0300000.

LCD display	Options	Remarks
Consumable Counter	10000 to 2560000 sheets (Default: 2560000 sheets)	This setting can be changed in ten thousands of sheets. The least four digits of zeros are automatically added.

The following is an example of operation when you use this function.

- In <<SETUP MODE>> initial screen, press **ENTER**.  
The <<SETUP MODE>> menu screen (Settings or Paper Length Check) appears.

### NOTE

The “Settings” screen does not appear and the “Paper Length Check” screen first appears when your scanner is not controlled through the video or TP interface.

- Press  repeatedly until “Consumable Counter” appears in the lower line of the menu screen.

<<SETUP MODE>>





<<SETUP MODE>>  
Settings

<<SETUP MODE>>  
Paper Length Check

<<SETUP MODE>>  
Consumable Counter

3. Press **ENTER**.  
The option select screen appears with the current value blinking (blinking indicates “changeable”).

Consumable Counter  
2560000 sheets

4. Press  or .  
The displayed value changes (1 to 256). (Value can be changed in ten thousands of sheets.) Pressing and holding down  or  speeds up the change.

Consumable Counter  
0300000 sheets

5. When the desired value appears, press **ENTER** to save the change.  
The LCD returns to the <<SETUP MODE>> menu screen (Consumable Counter).

<<SETUP MODE>>  
Consumable Counter

6. Press **CANCEL** two times.  
The LCD returns to the Ready screen.

Ready

## ■ Consumable counter reset

This function is to be used when the consumable parts are replaced before the accumulated count of the consumable counter reaches the set value.

### NOTE

You cannot use this function when the setup mode is brought by pressing **MENU** in the Ready status.



LCD display	Options	Remarks
Consumable Counter Reset	Yes, No	Yes: resets the accumulated value of the consumable counter. No: cancels the resetting of the consumable counter.

The following is an example of operation when you use this function.

- In <<SETUP MODE>> initial screen, press **ENTER**.  
The <<SETUP MODE>> menu screen (Settings or Paper Length Check) appears.

 **NOTE**

The “Settings” screen does not appear and the “Paper Length Check” screen first appears when your scanner is not controlled through the video or TP interface.

- Press  repeatedly until “Consumable Counter Reset” appears in the lower line of the menu screen.
- Press **ENTER**.  
The option select screen appears with the current setting NO blinking (blinking indicates “changeable”).
- Press  or .
- The displayed option changes (YES blinks).
- Press **ENTER** to reset the consumable counter.  
The LCD returns to the <<SETUP MODE>> menu screen (Consumable Counter Reset).
- To quit the <<SETUP MODE>>, turn off the power.

<<SETUP MODE>>

<<SETUP MODE>>  
Settings

<<SETUP MODE>>  
Paper Length Check

<<SETUP MODE>>  
Consumable Counter Reset

Reset	Counter Value
NO	00250000

Reset	Counter Value
YES	00250000

Finished resetting !!

<<SETUP MODE>>  
Consumable Counter Reset

## ■ Consumable alarm mode

This function is to be used how to notify the alarm when the accumulated count of the consumable counter reaches the set value.

### NOTE

You cannot use this function when the setup mode is brought by pressing **MENU** in the Ready status.

LCD display	Options	Remarks
Consumable Alarm Mode	Alarm & Stop scanning Message only	Alarm & Stop scanning: When the accumulated count reaches the set value of the consumable counter, the alarm is displayed on the LCD and the scanning operation stops. Message only: When the accumulated count reaches the set value of the consumable counter, the alarm is displayed on the LCD. (The scanning operation does not stop.)

The following is an example of operation when you use this function.

- In <<SETUP MODE>> initial screen, press **ENTER**.  
The <<SETUP MODE>> menu screen (Settings or Paper Length Check) appears.

### NOTE

The “Settings” screen does not appear and the “Paper Length Check” screen first appears when your scanner is not controlled through the video or TP interface.



- Press  repeatedly until “Consumable Alarm Mode” appears in the lower line of the menu screen.

<<SETUP MODE>>

<<SETUP MODE>>  
Settings

<<SETUP MODE>>  
Paper Length Check

<<SETUP MODE>>  
Consumable Alarm Mode

3. Press **ENTER**.  
The option select screen appears with the current setting "Alarm & Stop scanning" blinking (blinking indicates "changeable").
4. Press  or .  
The displayed option changes ("Message only" blinks).
5. Press **ENTER** to save the change.  
The LCD returns to the <<SETUP MODE>> menu screen (Consumable Alarm Mode).
6. To quit the <<SETUP MODE>>, turn off the power.

Consumable Alarm Mode  
Alarm & Stop scanning

Consumable Alarm Mode  
Message only

<<SETUP MODE>>  
Consumable Alarm Mode

## ■ Buzzer

This function enables or disables the buzzer sound when an error occurs.

### NOTE

The buzzer sounds regardless of this setting when use this function.



LCD display	Options	Remarks
Buzzer	On, Off (Default: Off)	

The following is an example of operation when you use this function.

1. In <<SETUP MODE>> initial screen, press **ENTER**.  
The <<SETUP MODE>> menu screen (Settings or Paper Length Check) appears.

 **NOTE**

The “Settings” screen does not appear and the “Paper Length Check” screen first appears when your scanner is not controlled through the video or TP interface.

2. Press  repeatedly until “Buzzer” appears in the lower line of the menu screen.
3. Press **ENTER**.  
The option select screen appears with the current setting OFF blinking (blinking indicates “changeable”).
4. Press  or .
5. Press **ENTER** to save the change.  
The LCD returns to the <<SETUP MODE>> menu screen (Buzzer).
6. Press **CANCEL** two times.  
The LCD returns to the Ready screen.

<<SETUP MODE>>

<<SETUP MODE>>  
Settings

<<SETUP MODE>>  
Paper Length Check

<<SETUP MODE>>  
Buzzer

Buzzer  
OFF

Buzzer  
ON

<<SETUP MODE>>  
Buzzer

Ready



## ■ Buzzer volume

This function sets the sound volume of the buzzer in six steps.



### NOTE

This setting is valid both for occurrence of an error and for press of an operator panel button.

LCD display	Options	Remarks
Buzzer Volume	 (Default:  )	Minimum to (six steps) Maximum

\* Symbols of volume may differ from the actual symbols used in the LCD.

The following is an example of operation when you use this function.

- In <<SETUP MODE>> initial screen, press **ENTER**.  
The <<SETUP MODE>> menu screen (Settings or Paper Length Check) appears.

<<SETUP MODE>>

<<SETUP MODE>>  
Settings

<<SETUP MODE>>  
Paper Length Check





### NOTE

The “Settings” screen does not appear and the “Paper Length Check” screen first appears when your scanner is not controlled through the video or TP interface.

- Press repeatedly until “Buzzer Volume” appears in the lower line of the menu screen.
- Press **ENTER**.  
The option select screen appears with the current setting (no blinking but changeable).

<<SETUP MODE>>  
Buzzer Volume

Buzzer Volume  
Min Max

4. Press  or .
- The displayed option changes (■ ■ ■ □ □ □ to ■ ■ ■ ■ ■ ■ or ■ □ □ □ □ □).

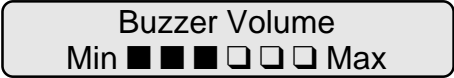

5. When the desired option appears, press **ENTER** to save the change.
- The LCD returns to the <<SETUP MODE>> menu screen (Buzzer Volume).

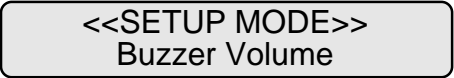

6. Press **CANCEL** two times.
- The LCD returns to the Ready screen.

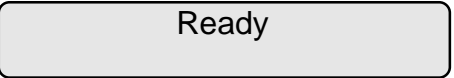

## ■ LCD contrast

This function sets the contrast of the LCD on the operator panel in six steps.

LCD display	Options	Remarks
LCD Contrast	■ □ □ □ □ □ to ■ ■ ■ ■ ■ ■ (Default: ■ ■ □ □ □ □)	Dark (low contrast) to Bright (high contrast) (six steps)

\* Symbols of volume may differ from the actual symbols used in the LCD.

The following is an example of operation when you use this function.

1. In <<SETUP MODE>> initial screen, press **ENTER**.
- The <<SETUP MODE>> menu screen (Settings or Paper Length Check) appears.

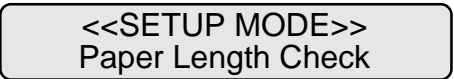
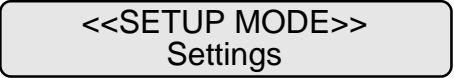
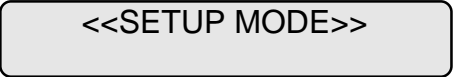



### NOTE





The “Settings” screen does not appear and the “Paper Length Check” screen first appears when your scanner is not controlled through the video or TP interface.

2. Press  repeatedly until "LCD Contrast" appears in the lower line of the menu screen.

<<SETUP MODE>>  
LCD Contrast

3. Press .  
The option select screen appears with the current setting  (no blinking but changeable).

LCD Contrast  
Dark  Bright

4. Press  or .  
The displayed option changes ( to  or .

LCD Contrast  
Dark  Bright

5. When the desired option appears, press  to save the change.  
The LCD returns to the <<SETUP MODE>> menu screen (LCD Contrast).

<<SETUP MODE>>  
LCD Contrast

6. Press  two times.  
The LCD returns to the Ready screen.

Ready

## ■ Picking speed

This function sets the rotational speed of the pick roller. Slow speed is recommended when you use thin or flexible paper which is liable to mis-pick.

LCD display	Options	Remarks
Picking Speed	Slow, Fast (Default: Fast)	

### NOTE

Processing speed of scanning in 200 dpi is reduced when the picking speed is set "Slow".

Set “picking speed” according to the table below.



Picking speed	“Mis-pick” frequently occurs.
Fast (factory default)	 Make the picking speed slow.
Slow	

The following is an example of operation when you use this function.

- In <<SETUP MODE>> initial screen, press **ENTER**.  
The <<SETUP MODE>> menu screen (Settings or Paper Length Check) appears.

 **NOTE**

The “Settings” screen does not appear and the “Paper Length Check” screen first appears when your scanner is not controlled through the video or TP interface.

- Press  repeatedly until “Picking Speed” appears in the lower line of the menu screen.
- Press **ENTER**.  
The option select screen appears with the current setting Fast blinking (blinking indicates “changeable”).
- Press  or .  
The displayed option changes (Slow blinks).
- Press **ENTER** to save the change.  
The LCD returns to the <<SETUP MODE>> menu screen (Picking Speed).
- Press **CANCEL** two times.  
The LCD returns to the Ready screen.

<<SETUP MODE>>

<<SETUP MODE>>  
Settings

<<SETUP MODE>>  
Paper Length Check

<<SETUP MODE>>  
Picking Speed

Picking Speed  
Fast

Picking Speed  
Slow

<<SETUP MODE>>  
Picking Speed

Ready

## ■ Interface

This function sets the host interface.



### NOTE

You cannot use this function when the setup mode is brought by pressing **MENU** in the Ready status.

LCD display	Options	Remarks
Interface	Auto, SCSI, Video, TP_IF (Default: Auto)	Auto: The scanner automatically detects the interface through which a host computer issues a command. TP_IF: Third party's interface

The following is an example of operation when you use this function.

- In <<SETUP MODE>> initial screen, press **ENTER**.  
The <<SETUP MODE>> menu screen (Settings or Paper Length Check) appears.



### NOTE

The "Settings" screen does not appear and the "Paper Length Check" screen first appears when your scanner is not controlled through the video or TP interface.

- Press **▶** repeatedly until "Interface" appears in the lower line of the menu screen.
- Press **ENTER**.  
The option select screen appears with the current setting AUTO blinking (blinking indicates "changeable").



<<SETUP MODE>>

<<SETUP MODE>>  
Settings

<<SETUP MODE>>  
Paper Length Check

<<SETUP MODE>>  
Interface

Interface  
AUTO

4. Press  or .  
The displayed option changes (SCSI, VIDEO, TP\_IF).
5. When the desired interface appears, press  to save the change.  
The LCD returns to the <<SETUP MODE>> menu screen (Interface).
6. To quit the <<SETUP MODE>>, turn off the power.

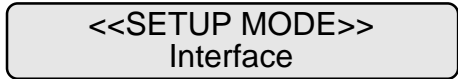

## ■ TP\_IF baud rate

This function sets the baud rate (signaling speed) according to the baud rate of the third party interface (TP\_IF). Set the speed slower than that of the host interface.

### NOTE

You cannot use this function when the setup mode is brought by pressing  in the Ready status.

LCD display	Options	Remarks
TP_IF Baud Rate	2400, 4800, 9600, 19200 (Default: 9600)	Unit: baud



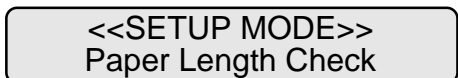
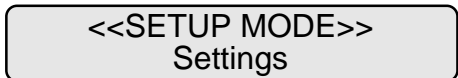
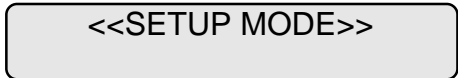

The following is an example of operation when you use this function.

1. In <<SETUP MODE>> initial screen, press .  
The <<SETUP MODE>> menu screen (Settings or Paper Length Check) appears.



### NOTE

The "Settings" screen does not appear and the "Paper Length Check" screen first appears when your scanner is not controlled through the video or TP interface.

2. Press  repeatedly until "TP\_IF Baud Rate" appears in the lower line of the menu screen.
3. Press .  
The option select screen appears with the current setting 9600 blinking (blinking indicates "changeable").
4. Press  or .  
The displayed option changes (19200, 2400, 4800 ).
5. When the desired option appears, press  to save the change.  
The LCD returns to the <<SETUP MODE>> menu screen (TP\_IF Baud Rate).
6. To quit the <<SETUP MODE>>, turn off the power.

<<SETUP MODE>>  
TP\_IF Baud Rate

TP\_IF Baud Rate  
9600

TP\_IF Baud Rate  
19200

<<SETUP MODE>>  
TP\_IF Baud Rate

### ■ RS232C baud rate

This function sets the baud rate (signaling speed) according to the baud rate of the RS-232C interface. Set the speed slower than that of the host interface.

 **NOTE**

You cannot use this function when the setup mode is brought by pressing  in the Ready status.



LCD display	Options	Remarks
RS232C Baud Rate	2400, 4800, 9600, 19200 (Default: 4800)	Unit: baud

The following is an example of operation when you use this function.

1. In <<SETUP MODE>> initial screen, press **ENTER**.  
The <<SETUP MODE>> menu screen (Settings or Paper Length Check) appears.

 **NOTE**

The “Settings” screen does not appear and the “Paper Length Check” screen first appears when your scanner is not controlled through the video or TP interface.

2. Press  repeatedly until “RS232C Baud Rate” appears in the lower line of the menu screen.
3. Press **ENTER**.  
The option select screen appears with the current setting 4800 blinking (blinking indicates “changeable”).
4. Press  or .
5. When the desired option appears, press **ENTER** to save the change.  
The LCD returns to the <<SETUP MODE>> menu screen (RS232C Baud Rate).
6. To quit the <<SETUP MODE>>, turn off the power.

<<SETUP MODE>>

<<SETUP MODE>>  
Settings

<<SETUP MODE>>  
Paper Length Check

<<SETUP MODE>>  
RS232C Baud Rate

RS232C Baud Rate  
4800

RS232C Baud Rate  
19200

<<SETUP MODE>>  
RS232C Baud Rate



## ■ SCSI ID

This function sets the ID number for the SCSI interface.

### NOTE

You cannot use this function when the setup mode is brought by pressing **MENU** in the Ready status.

LCD display	Options	Remarks
SCSI ID	0 to 7 (Default: 5)	

The following is an example of operation when you use this function.

- In <<SETUP MODE>> initial screen, press **ENTER**.  
The <<SETUP MODE>> menu screen (Settings or Paper Length Check) appears.



<<SETUP MODE>>

<<SETUP MODE>>  
Settings

<<SETUP MODE>>  
Paper Length Check

### NOTE

The “Settings” screen does not appear and the “Paper Length Check” screen first appears when your scanner is not controlled through the video or TP interface.

- Press  repeatedly until “SCSI ID” appears in the lower line of the menu screen.
- Press **ENTER**.  
The option select screen appears with the current setting 5 blinking (blinking indicates “changeable”).
- Press  or .

<<SETUP MODE>>  
SCSI ID

SCSI ID  
5

SCSI ID  
3

- When the desired value appears, press **ENTER** to save the change.  
The LCD returns to the <<SETUP MODE>> menu screen (SCSI ID).
- To quit the <<SETUP MODE>>, turn off the power.

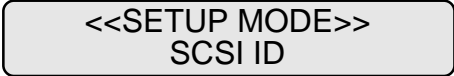

## ■ Product ID

This function sets the product ID of the scanner. Usually, you need not change this setting.

### NOTE

You cannot use this function when the setup mode is brought by pressing **MENU** in the Ready status.

LCD display	Options	Remarks
Product ID	M4099D, M3099G (Default: M4099D)	Model number of this scanner

\* The model number of this scanner is M4099D.

The following is an example of operation when you use this function.

- In <<SETUP MODE>> initial screen, press **ENTER**.  
The <<SETUP MODE>> menu screen (Settings or Paper Length Check) appears.

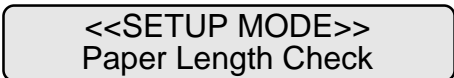
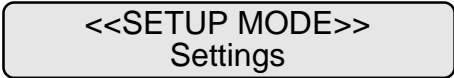
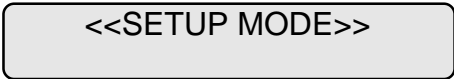

### NOTE



The “Settings” screen does not appear and the “Paper Length Check” screen first appears when your scanner is not controlled through the video or TP interface.

2. Press  repeatedly until "Product ID" appears in the lower line of the menu screen.

<<SETUP MODE>>  
Product ID

3. Press .  
The option select screen appears with the current setting M4099D blinking (blinking indicates "changeable").

Product ID  
M4099D

4. Press  or .  
The displayed option changes (M3099G blinks).

Product ID  
M3099G

5. Press  to save the change.  
The LCD returns to the <<SETUP MODE>> menu screen (Product ID).

<<SETUP MODE>>  
Product ID

6. To quit the <<SETUP MODE>>, turn off the power.

## ■ Pre-pick

This function enables or disables pre-picking of paper.



LCD display	Options	Remarks
Pre-pick	On, Off (Default: On)	

The following is an example of operation when you use this function.

1. In <<SETUP MODE>> initial screen, press **ENTER**.  
The <<SETUP MODE>> menu screen (Settings or Paper Length Check) appears.

 **NOTE**

The “Settings” screen does not appear and the “Paper Length Check” screen first appears when your scanner is not controlled through the video or TP interface.

2. Press  repeatedly until “Pre-pick” appears in the lower line of the menu screen.
3. Press **ENTER**.  
The option select screen appears with the current setting ON blinking (blinking indicates “changeable”).
4. Press  or .
5. Press **ENTER** to save the change.  
The LCD returns to the <<SETUP MODE>> menu screen (Pre-pick).
6. Press **CANCEL** two times.  
The LCD returns to the Ready screen.

<<SETUP MODE>>

<<SETUP MODE>>  
Settings

<<SETUP MODE>>  
Paper Length Check

<<SETUP MODE>>  
Pre-pick

Pre-pick  
ON

Pre-pick  
OFF

<<SETUP MODE>>  
Pre-pick

Ready

## ■ Pick start time

This function sets the period from when paper is manually put on the hopper to when the pick operation starts.



LCD display	Options	Remarks
Pick start time	00.2 S to 29.8 S (Default: 01.0 S)	In units of 0.2 second

The following is an example of operation when you use this function.

- In <<SETUP MODE>> initial screen, press **ENTER**.  
The <<SETUP MODE>> menu screen (Settings or Paper Length Check) appears.

### NOTE

The “Settings” screen does not appear and the “Paper Length Check” screen first appears when your scanner is not controlled through the video or TP interface.

- Press  repeatedly until “Pick start time” appears in the lower line of the menu screen.
- Press **ENTER**.  
The option select screen appears with the current setting 01.0S blinking (blinking indicates “changeable”).
- Press  or .
- The displayed option changes (00.2S to 29.8S). The value changes in 0.2 seconds.
- When the desired value appears, press **ENTER** to save the change.  
The LCD returns to the <<SETUP MODE>> menu screen (Pick start time).

<<SETUP MODE>>

<<SETUP MODE>>  
Settings

<<SETUP MODE>>  
Paper Length Check

<<SETUP MODE>>  
Pick start time

Pick start time  
01.0 S

Pick start time  
05.0 S

<<SETUP MODE>>  
Pick start time

6. Press **CANCEL** two times.  
The LCD returns to the Ready screen.

Ready

## Manual feed timeout

This function sets the waiting time from when the host computer issues a scan command to when paper is manually put on the hopper. A manual feed timeout error occurs if this time elapses without putting paper on the hopper.

LCD display	Options	Remarks
Manual Feed Timeout	1 S to 255 S (Default: 30 S)	Unit: second

The following is an example of operation when you use this function.

1. In <<SETUP MODE>> initial screen, press **ENTER**.  
The <<SETUP MODE>> menu screen (Settings or Paper Length Check) appears.

<<SETUP MODE>>

<<SETUP MODE>>  
Settings

<<SETUP MODE>>  
Paper Length Check

### NOTE



The "Settings" screen does not appear and the "Paper Length Check" screen first appears when your scanner is not controlled through the video or TP interface.

2. Press  repeatedly until "Manual Feed Timeout" appears in the lower line of the menu screen.

<<SETUP MODE>>  
Manual Feed Timeout

3. Press **ENTER**.  
The option select screen appears with the current setting 30 S blinking (blinking indicates "changeable").

Manual Feed Timeout  
30 S

4. Press  or .  
The displayed option changes (1 S to 255 S).  
The value changes in seconds.

Manual Feed Timeout  
10 S

5. When the desired value appears, press **ENTER** to save the change.  
The LCD returns to the <<SETUP MODE>> menu screen (Manual Feed Timeout).

<<SETUP MODE>>  
Manual Feed Timeout

6. Press **CANCEL** two times.  
The LCD returns to the Ready screen.

Ready

## ■ Paper pick retry

This function sets the pick motor rotation period and the retry count.





LCD display	Options	Remarks
Paper Pick retry	Step: 1 to 7 (Default: 2) Times: 1 to 7 (Default: 4)	1 to 7: one time to seven times the standard steps 1 to 7: one retry to seven retries

The following is an example of operation when you use this function.

1. In <<SETUP MODE>> initial screen, press **ENTER**.  
The <<SETUP MODE>> menu screen (Settings or Paper Length Check) appears.

 **NOTE**

The “Settings” screen does not appear and the “Paper Length Check” screen first appears when your scanner is not controlled through the video or TP interface.

2. Press  repeatedly until “Paper Pick retry” appears in the lower line of the menu screen.
3. Press **ENTER**.  
The option select screen appears with the current setting 2 (for Step) blinking (blinking indicates “changeable”).
4. Press .  
The current count setting 4 blinks.
5. Press  or .  
The displayed option changes (1, 2, 3, 4, 5, 6, 7).
6. When the desired value appears, press **ENTER** to save the change.  
The LCD returns to the <<SETUP MODE>> menu screen (Paper Pick retry).
7. Press **CANCEL** two times.  
The LCD returns to the Ready screen.

<<SETUP MODE>>

<<SETUP MODE>>  
Settings

<<SETUP MODE>>  
Paper Length Check

<<SETUP MODE>>  
Paper Pick retry

Paper Pick retry  
Step: 2 Times: 4

Paper Pick retry  
Step: 2 Times: 4

Paper Pick retry  
Step: 2 Times: 7

<<SETUP MODE>>  
Paper Pick retry

Ready



## ■ Paper feed retry

This function sets the feed motor rotation period and the retry count.

LCD display	Options	Remarks
Paper Feed Retry	Step: 1 to 7 (Default: 1) Times: 1 to 7 (Default: 4)	1 to 7: one time to seven times the standard steps 1 to 7: one retry to seven retries

The following is an example of operation when you use this function.

- In <<SETUP MODE>> initial screen, press **ENTER**.  
The <<SETUP MODE>> menu screen (Settings or Paper Length Check) appears.

### NOTE

The “Settings” screen does not appear and the “Paper Length Check” screen first appears when your scanner is not controlled through the video or TP interface.

- Press  repeatedly until “Paper Feed retry” appears in the lower line of the menu screen.
- Press **ENTER**.  
The option select screen appears with the current setting 1 (for Step) blinking (blinking indicates “changeable”).





<<SETUP MODE>>

<<SETUP MODE>>  
Settings

<<SETUP MODE>>  
Paper Length Check

<<SETUP MODE>>  
Paper Feed retry

Paper Feed retry  
Step: 1 Times: 4

4. Press .  
The current count setting 4 blinks.
5. Press  or .  
The displayed option changes (1, 2, 3, 4, 5, 6, 7).
6. When the desired value appears, press  to save the change.  
The LCD returns to the <<SETUP MODE>> menu screen (Paper Feed retry).
7. Press  two times.  
The LCD returns to the Ready screen.

Paper Feed retry  
Step: 1 Times: 4

Paper Feed retry  
Step: 1 Times: 7

<<SETUP MODE>>  
Paper Feed retry

Ready

## ■ Function key

This function allocates setup functions to **F1**, **F2**, and **F3** buttons. You can allocate up to three setup functions.

### NOTE

- You cannot use this function when the setup mode is brought by pressing **MENU** in the Ready status.
- You cannot allocate the following functions: Interface, TP\_IF Baud Rate, RS232C Baud Rate, SCSI ID, Product ID, Setup Mode Lock, Black Background, and Function Key itself.

Allocatable setup functions and other special functions	Remarks
Setup functions noted above START key EJECT key (Default: Undefined)	START: starts the operation stopped by EJECT and sends data to the host computer. EJECT: stops operation and ejects the paper in the transport unit.

The **F1**, **F2**, or **F3** button can be used as a shortcut key which enables you to access the allocated setup function just by pressing the button whenever the scanner is in the Ready state. This function is valid even in the setup mode lock state (refer to the next function). However, the **F1**, **F2**, and **F3** buttons are invalid in setup, browse, and test modes.

The following is an example of operation when you allocate START and EJECT keys to the **F1** and **F2** buttons respectively.

1. In <<SETUP MODE>> initial screen, press **ENTER**.  
The <<SETUP MODE>> menu screen (Settings or Paper Length Check) appears.











### NOTE

The “Settings” screen does not appear and the “Paper Length Check” screen first appears when your scanner is not controlled through the video or TP interface.

<<SETUP MODE>>

<<SETUP MODE>>  
Settings

<<SETUP MODE>>  
Paper Length Check

2. Press  repeatedly until "Function Key" appears in the lower line of the menu screen.
3. Press . The function key select screen appears with F1 blinking (blinking indicates "selectable").
4. Press . The F1 selection screen appears with the current setting Undefined blinking (blinking indicates "changeable").
5. Press  or . The setup functions, START key, and EJECT key are displayed in sequence at the lower line.
6. When START key is displayed, press . The LCD returns to the function key select screen with F1 blinking.
7. Press  twice. F3 blinks.
8. Press . The F3 selection screen appears with the current setting Undefined blinking (blinking indicates "changeable").
9. Press  or . The setup functions, START key, and EJECT key are displayed in sequence at the lower line.
10. When STOP key is displayed, press  to save the change. The LCD returns to the function key select screen with F3 blinking.
11. To quit the <<SETUP MODE>>, turn off the power.

<<SETUP MODE>>  
Function Key

Function Key  
F1      F2      F3

F1 selection  
Undefined

F1 selection  
START key

Function Key  
F1      F2      F3

Function Key  
F1      F2      F3

F3 selection  
Undefined

F3 selection  
EJECT key

Function Key  
F1      F2      F3

## ■ Setup mode lock

This function inhibits the operator panel from entering setup mode from normal mode, protecting the operator panel from misoperation. Once the operator panel is locked, you cannot use the setup items except those allocated to the **F1**, **F2**, and **F3** buttons.

### NOTE

You cannot use this function when the setup mode is brought by pressing **MENU** in the Ready status.

LCD display	Options	Remarks
Setup Mode Lock	On, Off (Default: Off)	

To cancel the setup mode lock state, turn off the power and turn on the power while pressing the **MENU** button to enter the setup mode. In the setup mode, select the Setup Mode Lock function and set the option to OFF.

The following is an example of operation when you use this function.

- In <<SETUP MODE>> initial screen, press **ENTER**.  
The <<SETUP MODE>> menu screen (Settings or Paper Length Check) appears.

### NOTE

The “Settings” screen does not appear and the “Paper Length Check” screen first appears when your scanner is not controlled through the video or TP interface.



- Press  repeatedly until “Setup Mode Lock” appears in the lower line of the menu screen.

<<SETUP MODE>>

<<SETUP MODE>>  
Settings

<<SETUP MODE>>  
Paper Length Check

<<SETUP MODE>>  
Setup Mode Lock

3. Press **ENTER**.  
The option select screen appears with the current setting OFF blinking (blinking indicates “changeable”).
4. Press  or .
5. Press **ENTER** to save the change.  
The LCD returns to the <<SETUP MODE>> menu screen (Setup Mode Lock).
6. To quit the <<SETUP MODE>>, turn off the power.

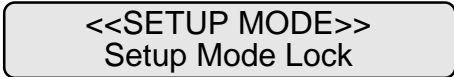
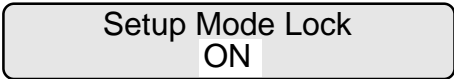

## ■ Black background

This function is set to ON when the “Black Background” is mounted on the scanner. After mounting the “Black Background”, set this function to ON and adjust the gain of the amplifier by the “Amp Gain Adjustment” in the test mode.



**NOTE (Image Quality):**

The quality of the scanned image becomes low when the “Black Background” function is set to ON without mounting the “Black Background”.



**NOTE**

You cannot use this function when the setup mode is brought by pressing **MENU** in the Ready status.







LCD display	Options	Remarks
Black Background	Front: On, Off (Default: Off) Back: On, Off (Default: Off)	

The following is an example of operation when you change the setting.

1. In <<SETUP MODE>> initial screen, press **ENTER**.  
The <<SETUP MODE>> menu screen (Settings or Paper Length Check) appears.

 **NOTE**

The “Settings” screen does not appear and the “Paper Length Check” screen first appears when your scanner is not controlled through the video or TP interface.

2. Press  repeatedly until “Black Background” appears in the lower line of the menu screen.
3. Press **ENTER**.  
The option select screen appears with the current setting OFF (for Front) blinking (blinking indicates “changeable”).
4. Press  or .  
The displayed option changes (ON blinks).
5. Press .  
OFF (current option for Back) blinks (blinking indicates “changeable”).
6. Press  or .  
The displayed option changes (ON blinks).
7. When the desired option appears, press **ENTER** to save the change.  
The LCD returns to the <<SETUP MODE>> menu screen (Black Background).
8. To quit the <<SETUP MODE>>, turn off the power.

<<SETUP MODE>>

<<SETUP MODE>>  
Settings

<<SETUP MODE>>  
Paper length Check

<<SETUP MODE>>  
Black Background

Black Background  
Front: OFF Back: OFF

Black Background  
Front: ON Back: OFF

Black Background  
Front: ON Back: OFF

Black Background  
Front: ON Back: ON

<<SETUP MODE>>  
Black Background

## ■ Language

This function sets the message language of the LCD to English or Japanese.



LCD display	Options	Remarks
Language	English, カタカナ (Default: English)	

The following is an example of operation when you change the setting.

1. In <<SETUP MODE>> initial screen, press **ENTER**.  
The <<SETUP MODE>> menu screen (Settings or Paper Length Check) appears.

### NOTE

The “Settings” screen does not appear and the “Paper Length Check” screen first appears when your scanner is not controlled through the video or TP interface.

2. Press  repeatedly until “Language” appears in the lower line of the menu screen.
3. Press **ENTER**.  
The option select screen appears with the current setting English blinking (blinking indicates “changeable”).
4. Press  or .  
The displayed option changes (カタカナ blinks).
5. When the desired option appears, press **ENTER** to save the change.  
The LCD returns to the <<SETUP MODE>> menu screen (Language).
6. Press **CANCEL** two times.  
The LCD returns to the ドウサカノウ screen.

<<SETUP MODE>>

<<SETUP MODE>>  
Settings

<<SETUP MODE>>  
Paper Length Check

<<SETUP MODE>>  
Language

Language  
English

Language  
カタカナ

<<SETUP MODE>>  
Language

ドウサカノウ



## ■ White follower mode

This function sets how to follow the white color as the reference during scanning documents. When the whole ground of a document is colored and “1” is set in this mode, the scanner scans the leading edge of the document as the white reference. Then the ground of the scanned image will be white.

### NOTE

- The area about 3 mm from the leading edge of a document must be in the same color when “1” is set.
- You cannot use this function when the setup mode is brought by pressing **MENU** in the Ready status.

LCD display	Options	Remarks
White follower mode	1, 0 (Default: 0)	0: The white background in the scanner is regarded as the white reference. 1: The leading edge of the paper is regarded as the white reference.

The following is an example of operation when you change the setting.

1. In <<SETUP MODE>> initial screen, press **ENTER**.  
The <<SETUP MODE>> menu screen (Settings or Paper Length Check) appears.

### NOTE

The “Settings” screen does not appear and the “Paper Length Check” screen first appears when your scanner is not controlled through the video or TP interface.



2. Press  repeatedly until “White follower mode” appears in the lower line of the menu screen.

<<SETUP MODE>>

<<SETUP MODE>>  
Settings

<<SETUP MODE>>  
Paper Length Check

<<SETUP MODE>>  
White follower mode

3. Press **ENTER**.  
The option select screen appears with the current setting 0 blinking (blinking indicates “changeable”).
4. Press  or .
5. Press **ENTER** to save the change.  
The LCD returns to the <<SETUP MODE>> menu screen (Language).
6. To quit the <<SETUP MODE>>, turn off the power.

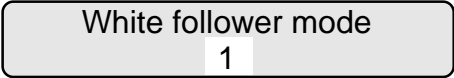
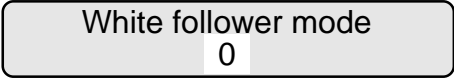

# Activating the Test Mode

To activate the test mode:

1. Turning power on with **MENU** pressed.  
The LCD indicates "Please wait" then "<<MODE SELECT>>" with "SETUP" blinking.
2. Press  twice.  
"TEST" blinks (blinking indicates "selectable").
3. Press **ENTER**.  
The <<TEST MODE>> initial screen (\*) appears.
4. Press **ENTER**.  
The <<TEST MODE>> menu screen (\*\*) appears.

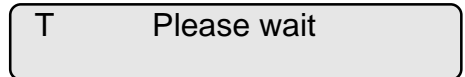

\* <<TEST MODE>> Initial screen

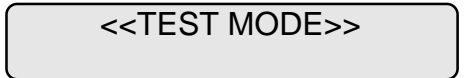





\*\* <<TEST MODE>> menu screen



To quit the test mode, turn power off.

## ■ Button functions in test mode

Button name	Function
<b>MENU</b>	Returns to the <<TEST MODE>> menu screen.
<b>ENTER</b>	<ul style="list-style-type: none"> <li>• Executes the test.</li> <li>• Returns to the previous screen.</li> <li>• Displays the next lower level screen, if any.</li> </ul>
<b>CANCEL</b>	Returns to the previous screen without saving the change.
	<ul style="list-style-type: none"> <li>• Displays the next function at the right in the menu.</li> <li>• Moves to the right item.</li> </ul>
	<ul style="list-style-type: none"> <li>• Displays the next test function at the left in the menu.</li> <li>• Moves to the left item.</li> </ul>
	Scrolls the option downward.
	Scrolls the option upward.

## ■ Mode selection (power on with MENU pressed)

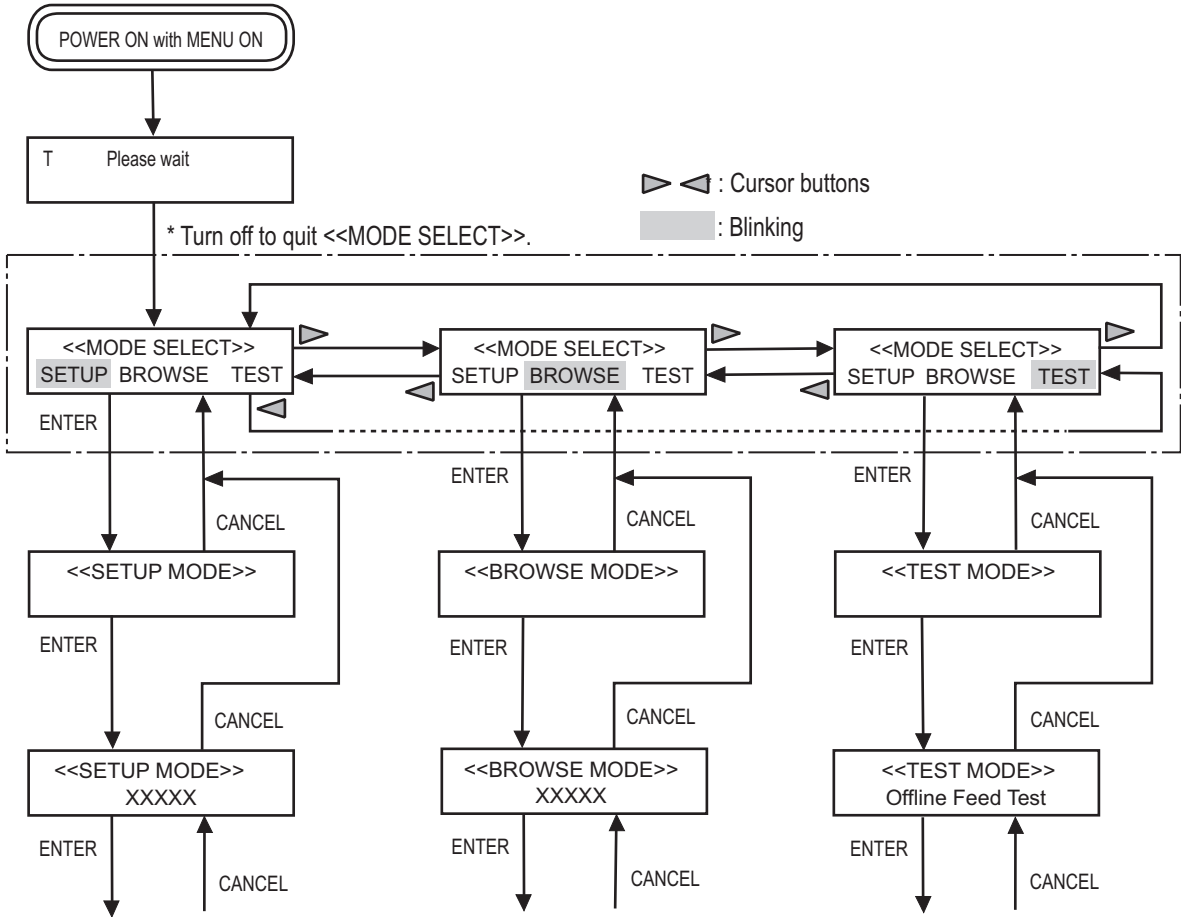

# Contents of the Test Mode

The test mode includes the user test functions listed in the following table. This section explains “Offline feed test”, “Options”, and “Device life” which are necessary for users.

## NOTE

If you must need to use user test functions other than “Offline feed test”, “Options”, and “Device life”, contact your dealer.

The user test functions are as follows:

Test item	Description
Offline feed test	Scans sheets continuously for checking conditions of paper feeding.
Options	Displays the options installed in the scanner.
Device life	Displays the accumulative number of sheets fed and the accumulative number of hours for lamps lit since the scanner has been installed, to estimate the life of the device.
Sensor auto adjustment	Automatically adjusts sensors.
Offset auto adjustment	Adjusts offset using adjustment sheets.
Operation panel test	Tests functions of the LCD, LEDs, and buttons to check the operator panel.
ROM revision	Displays the revision of the program EPROM.
Sensor status	Displays the status of the sensors.
Sensor adjustment	Changes the current and slice level of sensors to adjust the sensors.
+5V voltage check	Displays the voltage of +5 volts.
EEPROM edit	Writes arbitrary data in EEPROM (address 00 to 127) to confirm or change the set values.
Image memory capacity	Displays the capacity of the image memory.
Amp gain adjustment	Adjusts the gain of the amplifier when the “Black Background” is mounted.



## ■ Offline feed test

This function scans sheets of paper continuously for checking entire operation of the mechanism without a host computer. You can use the Settings function in setup mode to modify scanning parameters (scanning mode, paper size/orientation, density, resolution, and halftone processing) for scanning documents.

LCD display	Test items	Remarks
Offline Feed Test	START and SETUP	START: begins the test. SETUP: changes settings of scanning parameters.

\* For SETUP operation, see the “Settings” function previously described in this chapter.

The following is an example of operation when you start the offline feed test after setting scanning parameters.

- Put sheets of paper on the hopper table.
- In the <<TEST MODE>> initial screen, press **ENTER**.  
The <<TEST MODE>> menu screen (Offline Feed Test) appears.
- Press **ENTER** again.  
The scanning parameters screen indicates the current parameters with START blinking (blinking indicates “selectable”).
- Press .  
SETUP blinks (blinking indicates “selectable”).
- Press **ENTER**.  
The LCD changes to the parameter set screen with S (simplex mode) blinking (blinking indicates “selectable”).
- Press .  
A4P (A4 size in portrait orientation) blinks (blinking indicates “selectable”).

<<TEST MODE>>

<<TEST MODE>>  
Offline Feed Test

S A4P AT2 200 LA  
START SETUP

S A4P AT2 200 LA  
START SETUP

S A4P AT2 200 LA  
AT2 LA

S A4P AT2 200 LA  
AT2 LA

7. Press **ENTER**.  
The PAPER SIZE screen appears with the current setting A4P blinking (blinking indicates “changeable”).

PAPER SIZE  
A4P

8. Press  or .  
The displayed parameter changes (LTP, B5P, A5P, A4L, etc.).

PAPER SIZE  
LTP

9. When the desired parameter appears, press **ENTER** to save the change.  
The parameter set screen appears with the new parameter blinking.

S LTP AT2 200 LA  
AT2 LA

10. Press **CANCEL**.  
The scanning parameters screen appears with the new parameter replaced and with SETUP blinking (blinking indicates “selectable”).

S LTP AT2 200 LA  
START SETUP

11. Press .  
START blinks (blinking indicates “selectable”).

S A4P AT2 200 LA  
START SETUP

12. Press **ENTER**.  
The scanner feeds and scans documents continuously until it detects an error (usually “Hopper empty”). During feeding, the upper line indicates “Feeding!!” and the lower line indicates the number of sheets fed.

Feeding!!  
12345678 1234

- To halt the test, press **CANCEL**.
- To restart the test, press **ENTER**.
- To restart from a hopper empty status, put sheets of paper on the hopper table and press **CANCEL**.
- To quit the offline feed test, press **CANCEL** in the halted state.

13. To quit the <<TEST MODE>>, turn off the power.

## ■ Options

This function displays the options installed in the scanner.

LCD display	Displayed options	Remarks
Options	Endorser, IPC-3D	Endorser: printer that prints back side of documents. IPC-3D: image processing feature (standard installation).

\* When an option is installed, ON is displayed under the option. When an option is not installed, OFF is displayed under the option.

The following is an example when you use this function.

- In the <<TEST MODE>> initial screen, press **ENTER**.  
The <<TEST MODE>> menu screen (Offline Feed Test) appears.
- Press .  
The <<TEST MODE>> menu screen (Options) appears.
- Press **ENTER**.  
The current options list screen appears. You can check options installed.
- To quit the <<TEST MODE>>, turn off the power.

<<TEST MODE>>

<<TEST MODE>>  
Offline Feed Test

<<TEST MODE>>  
Options

Endorser	IPC-3D
OFF	ON



## ■ Device life

This function displays the accumulative number of sheets fed and the accumulative number of hours during which the lamp is lit since the scanner has been installed. These values are helpful for estimating the life of devices.

LCD display	Displayed devices	Remarks
Device Life	COUNT, LAMP F, and LAMP B	COUNT: accumulative number of sheets fed. LAMP F: accumulative number of operating hours for the front-side lamp. LAMP B: accumulative number of operating hours for the back-side lamp.

\* The unit of each value is not displayed on the LCD.

The following is an example operation when you use this function.

- In the <<TEST MODE>> initial screen, press **ENTER**.  
The <<TEST MODE>> menu screen (Offline Feed Test) appears.
- Press  four times.  
The <<TEST MODE>> menu screen (Device Life) appears.
- Press **ENTER**.  
The current value display screen appears.  
You can estimate the device life.
- To quit the <<TEST MODE>>, turn off the power.

<<TEST MODE>>

<<TEST MODE>>  
Offline Feed Test

<<TEST MODE>>  
Device Life

COUNT LAMP F: 1234567  
12345678 B: 1234567

# ***GLOSSARY OF TERMS***

---

## **A4 size**

A standard paper size used in Japan and other countries. Paper size is 210 x 297 mm (8.25 x 11.6 inches).

## **ASCII**

The acronym for American Standard Code for Information Interchange.

ASCII is a set of 128 codes (numbered 0 to 127) used to communicate information between a computer and another device such as scanner.

## **Automatic separation**

The image processing method to detect the difference between text and photos and choose the threshold accordingly. Automatic separation allows the scanner to switch between line mode and half tone mode in one pass.

## **Automatic start mode (<--> manual start mode)**

In this mode the reading operation is activated only by START command.

## **Back-side reading = Back-side scanning**

Refers to reading the back-side of the document, specifically in Duplex reading mode.

## **Bit**

The smallest unit of information in computer memory. A bit is a single digit, either a 1 or a 0, in the binary numbering system.

Eight bits equal one byte.

## **Browse mode**

The mode in which users can glance setup conditions of the scanner in offline status.

## **Consumable counter**

Indicates when consumables like a lamp should be replaced. The number of read document accumulates until an operator resets the counter. It should be reset when consumables are replaced.

## **Density**

Degree of darkness of an image. Also percent of screen used in an image.

---

## **Dither**

Technique for producing halftone images representing the entire grayscale using two pixel levels black and white.

## **dpi**

Dots per inch.

## **Drop-out color**

A color which is used to the document but does not appear in the read image.

## **Duplex reading mode**

Both sides of the document are read in this mode.

## **Endorser**

The unit for printing characters before or after scanning. These character may be used for collation of the documents and the image data.

## **Equipment Error**

An error that is not recoverable by operator. Call an authorized maintenance engineer.

## **Error diffusion**

High-quality halftone (pseudo-grayscale) image production based on black-and-white pixel binarization. A pixel's optical density and that of adjacent pixels are summed, with black pixels relocated in their order of density as they relate to adjacent pixels.

The purpose of this technique is to minimize the average error between read and printed densities. Density data for adjacent pixels is modified by diffusing errors on the objective pixel into several pixels, which are then binarized. This maintains high grayscale levels and resolution during reading, while suppressing more patterns by dotted halftone images such as newspaper photo graphs.

## **Filtering**

The quality of images written in pencil or ball-pointed pen and read depends on the reflective light characteristics of the ink or lead.

Dropped pixel's may produce out lines, gaps or thin, barely connected lines due to even optical density. Filtering detects areas lighter than their surroundings and increases their density to improve image clarity.

---

## **Front-side reading = Front-side scanning**

Refers to reading the front-side of the document, specifically in Duplex reading mode.

## **Halftone processing**

Used to reproduce photographs which usually contain different shades to display images. These shades are composed of dots resulting in a binary image. Dithering and error diffusion processing are examples of the halftone processing.

## **Hexadecimal**

A base-16 numbering system (also commonly referred to as hex numbers). Since a base-16 system requires 16 digits, numbers 0 through 9 and letters A through F are used. It is convenient to express binary numbers in hexadecimal because fewer digits are required.

## **Image emphasis**

Density is decreased for lighter but not completely white areas adjacent to black areas. Weakening this emphasis eliminates spot noise or produces softened images.

## **Image processing**

An image is read with specified parameters.

## **Initial screen**

A screen displayed when the power is turned on or when reading is activated by the command from the host computer.

## **Interface**

The connection that allows communication from one part of a system to another. For example, electrical signals are transferred between the computer and scanner over an interface cable.

## **Inversion (Reverse-image reading)**

In reverse-image reading, data is changed from black to white and vice versa.

## **IPC-3 mode**

While reading binary images, it is necessary to set the scanner according to the quality of the sheet to be read. In this mode these settings can be performed in advance by corresponding each setting to a pattern number.

---

## **IRAS**

Initialization of the hardware.

## **Landscape**

A document is transported and read with the long side vertical to the moving direction.

## **Letter size**

A standard paper size used in the U.S.A. and other countries. Paper size is 8-1/2 x 11 inches (215.9 x 279.4 mm).

## **Linedrawing mode**

Selecting linedrawing mode makes threshold and contrast settings effective but prevents brightness from being set. The specified threshold value determines whether black or white pixels are scanned. Linedrawing mode is therefore appropriate for scanning text and line art images.

## **Manual Feed mode = Manual Mode**

Requires the operator to feed each document manually to the hopper table.

## **Mirror image**

The read image is symmetrically flipped to produce a mirror image of the original detected in the main scanning direction.

## **Noise removal**

Isolated noise from an image appearing as black spots in white areas and voids in black areas is removed to improve image quality.

## **Operator panel**

A panel containing the scanner indicators and buttons. The operator panel is used to control scanner operations such as loading document, selecting features, and changing setup options.

## **Outline extraction**

The boundary between black and white areas is traced and the outline extracted for closed areas.

---

## **Paper Jam**

A warning informing the user that document is jammed in the transport unit, or that transportation is disabled because the transport unit is slippery. This warning also appears when a double fed is detected.

## **Photograph mode (White level follower OFF)**

Selecting photograph mode makes brightness and contrast settings effective but prevents the threshold from being set. With photograph mode, the darkness of image corresponds to the black-pixel density, making it suitable in scanning images such as photographs having gradations.

## **Photo mode = photograph mode**

A photograph is read properly in this mode.

## **Picking start time**

The period from the manual insertion of the document until picking starts after the document passes the hopper empty sensor.

## **Picking time**

The period from the start of picking until the document reaches SF1 sensor. Specify a little longer picking time for the document with a large friction factor.

## **Pick speed**

A speed when a document is picked. Set the pick speed to SLOW to prevent JAM or MISS PICK.

## **Portrait**

A document is transported and read with the long side parallel to the moving direction.

## **Pre-picking**

A setting in which a document to be read next is placed at the front of the reading unit while the previous document is read. Setting the pre-picking makes the process speedier.

## **Readable status**

A status when the power is turned on or when reading is activated by the command from the host computer.

## **Read operation**

Refers to the reading operation including Simplex reading and Duplex reading.

---

## **RS-232C interface**

A type of serial interface. See Serial interface.

## **SCSI-ID**

Used to specify a particular SCSI device when the initiator selects a target or the target re-connects to the initiator.

## **Serial interface**

A standard computer interface. Information is transferred between devices over a single wire (although other wires are used for control).

With a serial interface, an interface cable greater than 3 meters (10 feet) can be used. This is often necessary in networking environments, where the scanner may be shared.

## **Setup mode**

In this mode, users can set a variety of functions in offline status for customizing the scanner for user requirements.

## **SF1 sensor**

The document detection sensor. It detects the light that transmits the paper. It also detects the double feed error.

## **Simplex reading mode**

Only the front side of the document is read in this mode. Place the documents face-up at the center of the hopper table.

## **Smoothing**

Smoothing eliminates jaggies from slanted lines and curves. Irregular convexities are deleted and irregular concavities filled in. This is useful in OCR applications, for example.

## **Start command time-out**

Occurs if START command does not arrive before the specified time after reading the previous document is complete. In this case the hopper table is lowered.

## **Temporary Error**

An error that is recoverable by operator.

---

## **Terminator**

Devices with SCSI interface are daisy-chained. A resistor that includes terminal circuits needs to be placed at both ends of a cable when devices are daisy-chained.

## **Test mode**

The mode in which users can test the scanner in offline status.



# INDEX

- A**
  - Abrasion counter 3-5
  - Activating the
    - Setup or Browse Mode 6-2
    - Test Mode 6-54
  - ADF release lever 1-3
  - Ambient condition 5-1
  - Arrangement 1-5
  - Assemblies 1-4
  - Automatic document feeder (ADF) 1-3
- B**
  - Basic Operation of the Operator
    - Panel 3-2
  - Batch counter 3-5
  - Black background 6-49
  - Brake roller 1-3, 1-4, 5-3
  - Braking power 6-18
  - Browse mode 3-7
  - Button
    - /LED Function 1-6
  - Button functions
    - in setup or browse mode 6-2
    - in test mode 6-54
  - Buzzer 1-8, 6-26
  - Buzzer volume 6-28
- C**
  - Cable Connection 2-4
  - CANCEL button 1-6, 3-2, 3-4, 6-2, 6-54
  - CD-ROM 1-1
  - CHECK LED 1-6, 3-2
  - Check stopper 1-3
  - Checking the Components 1-1
  - Clearing a consumable life alarm 3-4
  - Confirming the number of sheets processed
    - by the scanner 3-5
  - Connecting
    - the interface cable 2-5
    - the power cable 2-4
  - Consumable
    - alarm mode 6-25
    - counter 3-4, 6-22
    - counter reset 6-23
    - life alarm 3-4
  - Consumables 5-3
  - Contents of the
    - Setup Mode 6-4
    - Test Mode 6-56
  - Conventions iii
  - Curl of paper 4-3
  - Cursor buttons 1-6, 6-2, 6-54
- D**
  - DATA LED 1-6
  - Density 6-7
  - Device life 6-60
  - Difference 6-9
  - Dimensions 5-1, 5-2
  - Displaying detailed information if an error occurred 3-2
  - Document
    - Quality 4-2
    - Size 4-1
  - Document type 4-2
  - Double feed 6-18
  - Drop-out color 6-20
- E**
  - EJECT key 6-46
  - ENTER button 1-6, 6-2, 6-54
  - Equipment errors 1-7
  - Error message 3-2
  - Error status display 1-7
- F**
  - F1, F2, and F3 buttons 1-6, 3-6
  - Feeding direction 4-1
  - Fine paper 4-2
  - Function key 6-46

Function buttons 3-6, 6-46  
Functions not available  
    in browse mode 6-1  
    in setup mode 6-1

**G** Guide plate 1-3, 1-4

**H** Halftone processing 6-7  
Hopper 1-3  
Hopper extension 1-3  
Hopper guide 1-3  
Hopper height 6-16  
Hopper height adjustment 3-3

**I** IMPORTANT NOTE TO USERS i  
Input power 5-1  
Inspection 2-2  
Installation Specifications 5-1  
Interface 6-32  
Interface  
    cable 2-5  
    connectors 1-3  
IPC-3 mode 6-14

**L** Label  
    A 2-2  
    B 2-3  
    C 2-3  
Lamp 1-4, 5-3  
Lamp unit 1-4  
Language 6-51  
LCD 1-5, 1-6  
LCD contrast 6-29  
LCD Display 1-6  
LED 1-6  
Lever 1-3  
Lifting or lowering the hopper 3-3

Lower sheet guide assembly 1-4

**M** Main line switch 1-3, 2-4, 3-1  
Manual feed timeout 6-41  
MENU button 1-6, 3-7, 6-2, 6-54  
Mis-pick 6-18, 6-31  
Mode selection  
    (MENU pressed in Ready status) 6-3  
    (power on with MENU pressed) 6-55

**O** OCR paper 4-2  
Offline feed test 6-58  
Operation status display 1-7  
Operator's Guide 1-1  
Operator panel 1-3, 1-5, 3-2  
Options 5-4  
Options (setup item) 6-60

**P** Pad 1-3, 1-4, 5-3  
Paper, curl of 4-3  
Paper feed retry 6-44  
Paper length check 6-9  
Paper pick retry 6-42  
Paper separation level 6-18  
Paper thickness check 6-10  
Paper thickness setup 6-11  
Paper  
    orientation 6-7  
    ream weight 4-2  
    size 6-7  
Pattern number 6-15  
Pick roller unit 1-3, 1-4, 5-3  
Pick start time 6-40  
Picking speed 6-30  
Plain paper 4-2

## Power

- cable 1-1, 2-4
- consumption 5-1
- inlet 1-3
- LED 1-6
- switch 1-3, 1-6, 3-1

## Precautions 2-1, 4-2

## Preface ii

## Pre-pick 6-38

## Product ID 6-37

## R

### Reading parameter 6-16

### Ream weight of paper 4-2

### Resolution 6-7

### RS232C baud rate 6-34

### RS-232C interface 2-5

## S

### Scanner 1-1

### Scanning mode 6-7

### SCSI ID 6-36

### SCSI interface 2-5

### Screen transition 3-7, 3-8, 3-9, 6-3, 6-6, 6-55

### Settings 6-7

### Setup, Browse, and Test Modes 6-1

### Setup items

- Black background 6-49
- Buzzer 6-26
- Buzzer volume 6-28
- Consumable alarm mode 6-25
- Consumable counter 6-22
- Consumable counter reset 6-23
- Drop-out color 6-20
- Function key 6-46
- Hopper height 6-16
- Interface 6-32
- IPC-3 mode 6-14
- Language 6-51

### LCD contrast 6-29

### Manual feed timeout 6-41

### Paper feed retry 6-44

### Paper length check 6-9

### Paper pick retry 6-42

### Paper separation level 6-18

### Paper thickness check 6-10

### Paper thickness setup 6-11

### Pick start time 6-40

### Picking speed 6-30

### Pre-pick 6-38

### Product-ID 6-37

### RS-232C baud rate 6-34

### SCSI-ID 6-36

### Settings 6-7

### Setup mode lock 6-48

### Skew check 6-13

### TP\_IF baud rate 6-33

### White follower mode 6-52

### Setup mode 3-7, 6-1

### Setup mode, contents of 6-4

### Setup mode lock 6-48

### SF2 did not detect leading edge of paper 6-18

### Side cover 1-3

### Skew check 6-13

### Specifications 5-1

### Stacker 1-3

### Stacker extension 1-3

### Stacker guide 1-3

### START key 6-46

### Status display, transition of 3-9

### Stop lever 1-1, 1-3

## T

### Temporary errors 1-7

### Test items

#### Device life 6-60

#### Offline feed test 6-58

#### Options 6-60

---

Test mode 3-7, 6-54  
Test mode, contents of 6-56  
TP\_IF baud rate 6-33  
Transition of  
    screens in setup mode 6-6  
    operator panel status and display 3-9  
Turning  
    the Power On 3-1  
    the main line switch off 2-4

**U** Units 1-2  
Units and Assemblies 1-2  
Upper transport unit 1-3  
Using the function buttons 3-6  
Using the setup, browse, and test modes  
    3-7

**V** Video interface 2-5

**W** Weight 5-1  
White follower mode 6-52

This product sold in Europe conforms to the standards in accordance with EC Directives. The copy of "Declaration of Conformity" is attached below:



## Declaration of Conformity

According to EN45014

**PFU Limited, Unoke-Machi Kahoku-Gun Ishikawa 929-1192 Japan**

**declares under our sole responsibility that the product including the options or accessories**

**Product Type:** Image Scanner

**Model Number:** M4099D

**to which this declaration relates is in conformity with the following standards:**

Electromagnetic Compatibility Directive 89/336/EEC, 92/31/EEC, 93/68/EEC  
Low Voltage Directive 73/23/EEC, 93/68/EEC

**European Standards:**

EN55022 1998 Class B  
EN55024 1998  
EN61000-4-2 1995  
EN61000-4-3 1996  
EN61000-4-4 1995  
EN61000-4-5 1995  
EN61000-4-6 1996  
EN61000-4-8 1993  
EN61000-4-11 1994  
EN61000-3-2 1995+A1+A2  
EN61000-3-3 1995  
EN60950 1992+A1+A2+A3+A4+A11

**The product of safety has been evaluated to EN60950 and has been confirmed to comply with all related requirements of EN60950.**

**Importer / Distributor in EU:**

**Fujitsu Europe Ltd.,**

**Hayes Park Central, Hayes End Road, Hays, Middlesex, UB4 8FE, England, UK.**

**Place of Issue:** Japan

**Date of Issue:** September 1, 2001

**Authorized by:** Masaki Morita

**Title of Authority:** Executive Director

Signature:

**PFU Limited  
Unoke-Machi,  
Kahoku-Gun,  
Ishikawa 929-1192,  
Japan**

FUJITSU