

N7100E

Operator's Guide

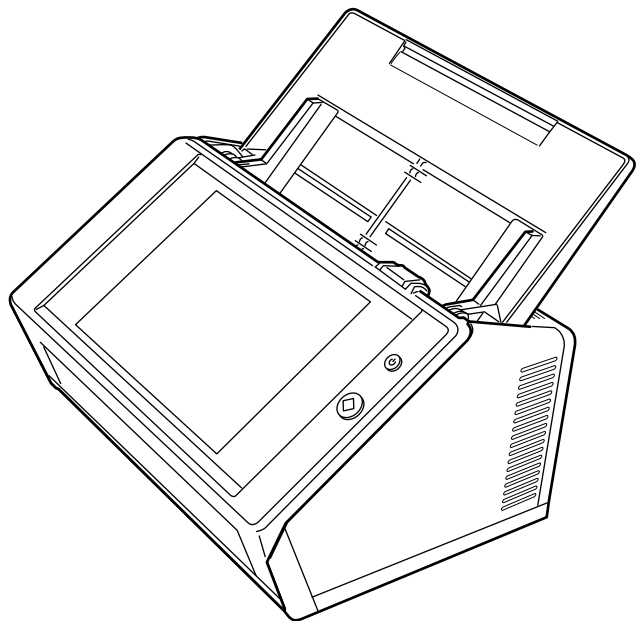

Contents

| | |
|---|-----------|
| Introduction | 15 |
| ■ Manuals | 16 |
| ■ About This Manual | 17 |
| Chapter 1 Overview | 21 |
| 1.1 Scanner Features | 22 |
| ■ Basic Uses for Scanned Data | 22 |
| ■ Configure and Manage with Ease | 23 |
| ■ Advanced Security Measures | 25 |
| 1.2 Part Names and Functions | 26 |
| ■ Front View | 26 |
| ■ Rear View | 27 |
| ■ Removable Parts | 28 |
| 1.3 User Types and Operations | 29 |
| 1.3.1 Operations with Administrator Right..... | 30 |
| 1.3.2 Regular User Operations..... | 34 |
| 1.4 Required Scanner Function Settings (Administrator) | 35 |
| 1.5 System Requirements | 40 |
| 1.5.1 Requirements for Admin Tool and User Editor..... | 40 |
| 1.5.2 Requirements for Related Servers | 42 |
| 1.5.3 Port Number List | 46 |
| Chapter 2 Basic Scanner Operations | 48 |
| 2.1 Turning the Power On/Off | 49 |
| 2.1.1 Turning the Power On | 49 |
| 2.1.2 Turning the Power Off | 50 |
| 2.2 Using the Scanner Buttons | 51 |
| ■ Using the Power Button | 51 |
| ■ Using the Scan Button | 53 |
| 2.3 Using the Touch Panel | 54 |

| | | |
|------------------|--|-----------|
| 2.4 | Using the On-Screen Keyboard | 55 |
| | ■ Showing/Hiding the On-Screen Keyboard | 55 |
| | ■ Using the On-Screen Keyboard | 56 |
| | ■ Keyboard Layout | 56 |
| Chapter 3 | Software Installation | 57 |
| 3.1 | Setting Up Internet Explorer | 58 |
| | ■ Checking the Internet Explorer Cache Settings | 58 |
| | ■ Setting Trusted Sites for Internet Explorer | 59 |
| 3.2 | Showing the Software Download Window | 60 |
| 3.3 | Installing the Admin Tool | 62 |
| 3.4 | Uninstalling the Admin Tool | 64 |
| 3.5 | Installing the Central Admin Console and Central Admin Server | 65 |
| Chapter 4 | Administrator Operations (Touch Panel and Admin Tool) | 66 |
| 4.1 | Windows | 67 |
| | 4.1.1 Administrator Windows via the Touch Panel..... | 67 |
| | 4.1.2 Administrator Windows via the Admin Tool..... | 68 |
| 4.2 | Administrator Login | 70 |
| | 4.2.1 Administrator Login: via the Touch Panel..... | 70 |
| | ■ When Automatic Login is Not Set | 70 |
| | ■ When Automatic Login is Set | 71 |
| | 4.2.2 Administrator Login: via the Admin Tool..... | 72 |
| 4.3 | Setting the System Settings | 75 |
| | 4.3.1 Configuring the Setting Mode..... | 75 |
| | 4.3.2 Setting the System Settings with the Installation Wizard | 76 |
| 4.4 | Configuring the System | 78 |
| | 4.4.1 Setting the Scanner Name | 78 |
| | 4.4.2 Setting the Language | 80 |
| | 4.4.3 Setting the Region/Timezone | 81 |
| | 4.4.4 Setting the Date/Time..... | 82 |
| | 4.4.5 Setting the Keyboard..... | 83 |

| | | |
|-------------|--|------------|
| 4.4.6 | Managing Certificates..... | 84 |
| ■ | Importing a Certificate File | 84 |
| ■ | Deleting a Certificate File | 85 |
| 4.5 | Setting the Scan Options | 86 |
| 4.5.1 | Setting the Multifeed Detection Method | 86 |
| 4.5.2 | Adjusting the Scan Starting Position (Offset/Magnification)..... | 88 |
| 4.5.3 | Setting General Scanner Settings..... | 89 |
| 4.6 | Configuring the Login-Related Settings | 90 |
| 4.6.1 | Setting the Login Settings | 90 |
| 4.6.2 | Setting the Login Settings (Details)..... | 93 |
| 4.6.3 | Setting the Standby Mode | 95 |
| 4.6.4 | Changing the Admin Password | 97 |
| 4.6.5 | Setting the LAN Manager Authentication Level..... | 98 |
| 4.7 | Configuring the Network Settings | 99 |
| 4.7.1 | Giving the Scanner an IP Address/DHCP | 99 |
| 4.7.2 | Setting the DNS Server | 101 |
| 4.7.3 | Setting the WINS Server | 102 |
| 4.7.4 | Setting the NTP Server | 103 |
| 4.7.5 | Setting the Proxy Server | 104 |
| 4.7.6 | Configuring the SNMP Settings..... | 105 |
| 4.7.7 | Configuring the SMB 1.0/CIFS Settings | 106 |
| 4.7.8 | Configuring Network Advanced Settings | 107 |
| 4.8 | Checking the Network Status | 108 |
| 4.8.1 | Checking the Network Connection with a Ping Test | 108 |
| 4.8.2 | Checking the Network Operating Status | 109 |
| 4.9 | Configuring the Network Admin Settings | 110 |
| 4.9.1 | Setting the Admin Connection..... | 110 |
| 4.9.2 | Setting a Central Admin Server..... | 111 |
| 4.9.3 | Setting a Central Admin Server (Details) | 113 |
| 4.10 | Setting the Authentication Server | 114 |
| 4.10.1 | Setting the Login LDAP Server | 114 |
| ■ | LDAP Search Target | 116 |
| 4.10.2 | Setting the e-Mail LDAP Server | 121 |
| 4.10.3 | Setting the Schema | 122 |
| 4.10.4 | Setting the LDAP Search Parameters..... | 123 |

| | | |
|-------------|---|------------|
| 4.11 | Configuring the e-Mail-Related Settings | 125 |
| 4.11.1 | Setting the SMTP Server | 125 |
| 4.11.2 | Setting the SMTP Server (Extension) | 126 |
| 4.11.3 | Configuring Settings for Sending e-Mail | 127 |
| 4.11.4 | Setting a File Name Format for When Attaching Scanned Data to e-Mail | 128 |
| 4.12 | Setting the Fax Server | 129 |
| 4.13 | Setting Folders for Saving Scanned Data | 130 |
| 4.13.1 | Setting the Network Folders | 130 |
| ■ | Registering a Network Folder (Network Tree) | 131 |
| ■ | Registering a Network Folder (Network Path) | 133 |
| ■ | Renaming a Network Folder | 134 |
| ■ | Removing a Network Folder | 134 |
| ■ | Viewing the Network Folder Details | 135 |
| 4.13.2 | Setting the FTP Server Folders | 136 |
| ■ | Registering an FTP Server Folder | 137 |
| ■ | Changing the FTP Server Folder Settings | 138 |
| ■ | Removing an FTP Server Folder | 138 |
| ■ | Viewing the FTP Server Folder Details | 139 |
| 4.13.3 | Setting the SharePoint Folders | 140 |
| ■ | Registering a SharePoint Folder | 140 |
| ■ | Changing the SharePoint Folder Settings | 142 |
| ■ | Removing a SharePoint Folder | 142 |
| ■ | Viewing the SharePoint Folder Details | 143 |
| 4.13.4 | Setting a File Name Format for When Saving Scanned Data | 144 |
| 4.14 | Setting the Network Printers | 146 |
| ■ | Checking the Printer Drivers | 149 |
| ■ | Setting the Printer Properties (via the Print Server) | 150 |
| ■ | Checking the Printer Name or the IP Address for the Printer (for Direct Printing) | 152 |
| ■ | Checking the Driver Name for the Printer (for Direct Printing) | 152 |
| ■ | Registering a Network Printer (Network Tree) (via the Print Server) | 153 |
| ■ | Registering a Network Printer (Network Path) | 155 |
| ■ | Changing the Network Printer Settings | 157 |
| ■ | Removing a Network Printer | 157 |
| ■ | Viewing the Network Printer Details | 158 |

| | |
|--|------------|
| 4.15 Viewing the Scanner Details | 159 |
| 4.15.1 Viewing the System Status..... | 159 |
| 4.15.2 Viewing the Usage Status | 160 |
| ■ Viewing the Status of Consumable Parts | 160 |
| ■ Resetting the Usage Counter | 160 |
| 4.15.3 Viewing the Status of Installed Options..... | 161 |
| 4.15.4 Managing the User Log..... | 162 |
| ■ Viewing the User Log Details | 162 |
| ■ Downloading the User Logs in CSV Format | 163 |
| ■ Clearing the User Logs | 163 |
| 4.15.5 Managing the System Log..... | 164 |
| ■ Viewing the System Log Details | 164 |
| ■ Downloading the System Log in CSV Format | 165 |
| ■ Clearing the System Log | 165 |
| 4.16 Managing the User Data Store and System Settings | 166 |
| 4.16.1 Maintaining the User Data Store | 166 |
| ■ Backing up the User Data Store | 168 |
| ■ Restoring the User Data Store | 169 |
| ■ Clearing the User Data Store | 169 |
| 4.16.2 Maintaining the System Settings..... | 170 |
| ■ Downloading the System Settings in CSV Format | 170 |
| ■ Backing up System Settings | 171 |
| ■ Restoring the System Settings | 172 |
| ■ Resetting to Factory Defaults | 173 |
| 4.17 Maintaining the System | 174 |
| 4.17.1 Updating the Scanner's System Software..... | 174 |
| 4.17.2 Checking for New Updates..... | 176 |
| ■ Checking for New Updates Manually | 176 |
| ■ Checking for Updates at Scanner Startup | 177 |
| ■ Requesting e-Mail Notification When a New Update is Available | 177 |
| 4.17.3 Maintaining Add-in Modules..... | 178 |
| ■ Installing an Add-in Module | 178 |
| ■ Uninstalling an Add-in Module | 179 |
| ■ Viewing the Add-in Status | 179 |
| ■ Uploading an Add-in Settings File | 180 |
| ■ Setting Whether to Show the Keyboard Icon When Running an Add-in ... | 180 |
| 4.17.4 Setting the Information Output Level..... | 181 |
| 4.17.5 Obtaining Technical Support..... | 182 |
| 4.17.6 Setting the Destination for Alert Notifications | 183 |

| | |
|--|------------|
| 4.17.7 Getting a Screenshot on the Touch Panel | 185 |
| 4.18 Setting a Job Sequence | 187 |
| 4.18.1 Job Setting Quick User Guide | 189 |
| 4.18.2 Setting a Job Sequence | 191 |
| ■ Adding a Job Sequence | 191 |
| ■ Cloning a Job Sequence | 197 |
| ■ Editing a Job Sequence | 197 |
| ■ Deleting a Job Sequence | 198 |
| ■ Filtering Job Sequences | 198 |
| ■ Filtering the LDAP List | 199 |
| ■ Splitting an Output File | 200 |
| 4.18.3 Setting a Job Menu | 201 |
| ■ Adding a Job Menu | 201 |
| ■ Cloning a Job Menu | 204 |
| ■ Editing a Job Menu | 204 |
| ■ Deleting a Job Menu | 205 |
| ■ Viewing the Detailed Settings for a Job Menu | 205 |
| 4.18.4 Setting a Job Group | 206 |
| ■ Adding a Job Group | 206 |
| ■ Cloning a Job Group | 209 |
| ■ Editing a Job Group | 209 |
| ■ Deleting a Job Group | 210 |
| ■ Viewing the Detailed Settings for a Job Group | 210 |
| ■ Assigning Job Menus to Users Not Included in a Job Group | 211 |
| ■ Filtering the LDAP List | 212 |
| 4.19 Messages | 213 |
| 4.19.1 Administrator Window Messages | 214 |
| Chapter 5 Regular User Operations | 215 |
| 5.1 Loading Documents | 216 |
| 5.1.1 How to Load Documents | 216 |
| 5.1.2 Loading Documents Using a Carrier Sheet..... | 220 |
| 5.2 Using Touch Panel Windows: Regular User | 223 |
| 5.2.1 [Main Menu] Window | 223 |
| 5.2.2 [Job Menu] Window | 224 |
| 5.2.3 Regular User Settings Overview | 225 |
| 5.3 Logging in: Regular User Mode | 226 |

| | | |
|------------|--|------------|
| 5.4 | Sending the Scanned Data by e-Mail | 229 |
| 5.4.1 | Selecting an e-Mail Target from the e-Mail Address Book | 232 |
| 5.4.2 | Adding an e-Mail Target to the e-Mail Address Book | 236 |
| 5.4.3 | Editing an e-Mail Target in the e-Mail Address Book | 240 |
| 5.4.4 | Deleting an e-Mail Target from the e-Mail Address Book..... | 242 |
| 5.5 | Sending the Scanned Data by Fax | 243 |
| 5.5.1 | Selecting a Fax Number from the Fax Number List | 245 |
| 5.5.2 | Adding a Contact to the Fax Number List | 247 |
| 5.5.3 | Editing the Fax Number List..... | 249 |
| 5.5.4 | Deleting a Contact from the Fax Number List | 250 |
| 5.6 | Printing the Scanned Data | 251 |
| 5.6.1 | Scaling..... | 254 |
| 5.6.2 | Positioning..... | 258 |
| 5.6.3 | Print Side | 260 |
| 5.7 | Saving the Scanned Data to a Network Folder | 261 |
| 5.8 | Setting the Scan Options | 264 |
| 5.8.1 | Relational Changes among Scan Setting Items..... | 265 |
| ■ | Basic | 265 |
| ■ | Save | 269 |
| ■ | Image Correction | 273 |
| ■ | Page | 274 |
| ■ | Paper Feeding | 275 |
| ■ | Batch | 275 |
| 5.8.2 | Setting Image Mode | 276 |
| 5.8.3 | Setting Paper..... | 277 |
| 5.8.4 | Resolution | 278 |
| 5.8.5 | Configuring Settings for a Carrier Sheet | 279 |
| 5.8.6 | File Format | 280 |
| 5.8.7 | Setting a PDF Password | 282 |
| 5.8.8 | Searchable PDF | 283 |
| 5.8.9 | Setting a Keyword for the PDF | 284 |
| 5.8.10 | Compression | 288 |
| 5.8.11 | Thresholding..... | 290 |
| 5.8.12 | Controlling the image quality of scanned data (Control Image Tone) | 291 |
| 5.8.13 | Optimizing Scanned Data (Cleanup)..... | 292 |
| ■ | In [Color] or [Grayscale] mode | 292 |
| ■ | In [Black & White] mode | 293 |
| 5.8.14 | Reducing Vertical Streaks | 294 |

| | |
|---|------------|
| 5.8.15 Removing Colors from Scanned Images (Dropout Color)..... | 295 |
| 5.8.16 Page Orientation | 296 |
| 5.8.17 Filling the Edge of Scanned Image (Edge Correction)..... | 298 |
| 5.8.18 Skipping Blank Pages from the Scanned Data | 300 |
| 5.8.19 Detecting Multifeeds..... | 301 |
| 5.8.20 Outputting Index Information | 302 |
| ■ Index Information File Format | 303 |
| 5.9 Enabling/Disabling the Scan Viewer | 306 |
| 5.10 Editing the Scanned Data in the Scan Viewer | 309 |
| 5.10.1 Switching the Page Order of the Scanned Data..... | 310 |
| 5.10.2 Viewing the Scanned Data | 311 |
| ■ Changing the Display Size of Scanned Data | 312 |
| 5.10.3 Editing Scanned Data on the Scan Viewer Details Window..... | 312 |
| ■ Rotating Scanned Data | 312 |
| ■ Deleting Scanned Data | 313 |
| 5.10.4 Editing Scanned Data on the [Assisted Scan] Window | 313 |
| ■ Changing the Display Size of Scanned Data | 315 |
| ■ Resetting a Processed Image | 315 |
| ■ Undoing and Redoing a Process | 315 |
| ■ Rotating Scanned Data | 315 |
| ■ Changing the Image Mode of Scanned Data | 315 |
| 5.10.5 Editing a Separator..... | 316 |
| 5.10.6 Deleting a Separator | 317 |
| 5.10.7 Scanning an Additional Page | 317 |
| 5.10.8 Editing Marked Characters to Be Set as Keywords | 318 |
| 5.11 Viewing the Send Status | 319 |
| 5.11.1 Viewing Details on Send Operations That Were Completed (User Log)... | 319 |
| 5.11.2 Viewing Details on Send Operations That Are In Progress..... | 320 |
| 5.12 Maintenance | 322 |
| 5.13 Processing a Job | 324 |
| 5.13.1 Enabling/Disabling the Message Screen..... | 326 |
| 5.13.2 Changing a File Name (for Save/e-Mail Attachment)..... | 328 |
| 5.13.3 Checking the Number of Sheets to Be Scanned..... | 329 |
| 5.13.4 Splitting a File Using Patch Codes | 332 |
| 5.14 Changing a User Password | 334 |

| | |
|---|----------------|
| Chapter 6 Scanner Care | 335 |
| 6.1 Cleaning Supplies and Parts to Clean | 336 |
| ■ Cleaning Supplies | 336 |
| ■ Which Parts and When | 337 |
| 6.2 Cleaning the Exterior of the Scanner | 338 |
| ■ Cleaning the Scanner Body | 338 |
| ■ Cleaning the Touch Panel | 338 |
| 6.3 Cleaning Inside the Scanner | 339 |
| 6.4 Cleaning a Carrier Sheet | 345 |
| 6.5 Replacing Parts | 346 |
| 6.5.1 Part Numbers and Replacement Cycle | 346 |
| 6.5.2 Checking the Consumable Alert Status..... | 347 |
| 6.5.3 Replacing the Roller Set..... | 348 |
| 6.5.4 Purchasing a Carrier Sheet..... | 355 |
| 6.6 Performing a Scan Test | 356 |
| ■ Regular User | 356 |
| ■ Administrator | 358 |
| 6.7 Calibrating the Touch Panel | 359 |
| Chapter 7 Troubleshooting | 360 |
| 7.1 Removing Jammed Documents | 361 |
| 7.2 Network Connection Troubleshooting | 364 |
| 7.2.1 Basic Network Operation Tests..... | 364 |
| ■ Checking Basic Network Operation with a Ping Test | 364 |
| ■ Checking the Network Operating Status | 367 |
| ■ Checking the NTP Server Settings by Synchronizing the System Time ... | 368 |
| ■ Checking the Mail Server by Sending a Test Mail | 369 |
| 7.2.2 Other Network Connection Troubleshooting..... | 370 |
| ■ Failure to Connect to a Server Using Its IP Address | 370 |
| ■ Failure to Connect to a Server Using Its Host Name or FQDN | 372 |
| ■ Failure to Add the Scanner as a Domain Member, or Failure to Login to a Domain | 372 |
| ■ Failure to Add a Network Printer | 373 |
| ■ Failure to Print on a Network Printer | 374 |
| ■ Failure to Add a Network Folder | 374 |
| ■ Failure to Save to a Network Folder | 375 |

| | | |
|-------------------|--|------------|
| 7.2.3 | Failure to Access the Scanner Using Internet Explorer, the Admin Tool, the Central Admin Server, or the User Editor..... | 376 |
| 7.3 | Other Troubleshooting | 379 |
| ■ | Scanner Cannot Be Turned On | 380 |
| ■ | Scanner Does Not Start Up | 380 |
| ■ | I Want to Reset the Scanner to Factory Defaults | 381 |
| ■ | Data Cannot Be Scanned Properly | 381 |
| ■ | Scanned Data Is Inappropriate | 384 |
| ■ | Cannot Login | 386 |
| ■ | Operation Does Not Work | 386 |
| 7.4 | Points to Check before Contacting Your FUJITSU Scanner Dealer | 388 |
| 7.4.1 | General Details..... | 388 |
| 7.4.2 | Error Status | 389 |
| ■ | Problem When Connecting to the Scanner via Computer | 389 |
| ■ | Document Feed Trouble | 389 |
| ■ | Sending an Original Document and Scanned Data | 390 |
| 7.5 | Checking the Scanner Labels | 391 |
| 7.6 | Pre-Maintenance Preparations | 392 |
| Appendix A | Paper Specifications | 393 |
| A.1 | Paper Size | 394 |
| A.2 | Paper Quality | 395 |
| A.3 | Maximum Document Loading Capacity | 397 |
| A.4 | Area not to be Perforated or Affixed with Other Papers | 398 |
| A.5 | Multifeed Detection Conditions | 399 |
| A.6 | Conditions for Using a Carrier Sheet | 400 |
| A.6.1 | Paper Size..... | 400 |
| A.6.2 | Paper Quality..... | 400 |
| Appendix B | Management Settings and Limits | 401 |
| B.1 | e-Mail Address Setting Values | 402 |
| B.2 | Limits for Setting Items | 403 |

| | |
|---|------------|
| Appendix C Compatibility and Connectivity | 405 |
| C.1 Compatibility | 406 |
| C.1.1 Add-in Performance | 406 |
| C.1.2 Using System Settings in Other Scanners | 407 |
| C.1.3 Using User Data in Other Scanners | 408 |
| C.1.4 Sharing User Data | 408 |
| C.1.5 Sharing Job Settings | 409 |
| C.1.6 Distribution from the Central Admin Console Server | 410 |
| C.2 Connectivity | 411 |
| C.2.1 Connectivity with the Admin Tool | 411 |
| C.2.2 Connectivity with the User Editor (AddressBookEditor) | 411 |
| C.2.3 Connectivity with the Central Admin Server | 412 |
| C.2.4 Root Certification Authority List | 412 |
| C.2.5 SMTP Server Settings for Using Webmail | 413 |
| Appendix D Scanner Specifications | 414 |
| D.1 Installation Specifications | 415 |
| D.2 Basic Scanner Specifications | 416 |
| D.3 Software Function List | 417 |
| D.4 Changing the Functions on the On-Screen Keyboard | 419 |
| D.4.1 Switching the Keyboard Layout | 419 |
| D.5 Barcode Types and Detection Conditions | 421 |
| ■ One-dimensional Barcodes | 421 |
| ■ Detection Conditions for One-dimensional Barcodes | 421 |
| Appendix E SNMP Settings | 423 |
| E.1 Corresponding MIB | 424 |
| E.2 MIB Information | 425 |
| ■ ScannerInfo | 425 |
| ■ BrakeRoller | 425 |
| ■ PickRoller | 426 |
| ■ TrapEvent | 426 |
| E.3 SNMP Trap Notification | 427 |

| | |
|--|------------|
| Appendix F Editing Using User Editor | 428 |
| F.1 What is User Editor? | 429 |
| F.2 Pre-settings | 430 |
| F.2.1 Installing User Editor | 430 |
| F.2.2 Uninstalling User Editor..... | 431 |
| F.3 Windows of User Editor | 432 |
| F.4 Starting/Exiting User Editor | 434 |
| ■ Starting User Editor | 434 |
| ■ Exiting User Editor | 434 |
| F.5 Viewing the e-Mail Address Book/Local Accounts | 435 |
| ■ Loading from a Scanner | 435 |
| ■ Loading from a File | 436 |
| ■ File Format of e-Mail Address Book Loaded from a File | 436 |
| ■ File Format of Local Accounts Loaded from a File | 437 |
| F.6 Editing an e-Mail Target in the e-Mail Address Book | 438 |
| F.6.1 Setting a Group | 438 |
| ■ Adding a Group | 438 |
| ■ Changing the Group Name | 439 |
| ■ Deleting a Group | 439 |
| F.6.2 Setting a Distribution List..... | 440 |
| ■ Adding a Distribution List | 440 |
| ■ Editing a Distribution List | 441 |
| ■ Deleting a Distribution List | 441 |
| F.6.3 Setting an e-Mail Address | 442 |
| ■ Adding an e-Mail Address | 442 |
| ■ Editing an e-Mail Address | 443 |
| ■ Deleting an e-Mail Address | 443 |
| F.7 Editing Local Accounts | 444 |
| F.7.1 Adding a Local Account..... | 444 |
| F.7.2 Editing a Local Account..... | 445 |
| F.7.3 Deleting a Local Account..... | 445 |
| F.8 Discarding the Edited e-Mail Address Book or Local Accounts | 446 |
| F.9 Saving the e-Mail Address Book/Local Account | 447 |
| ■ Saving the Edited Information to the Scanner | 447 |
| ■ Saving the Edited Information to a File | 448 |

| | | |
|--------------------------|--|------------|
| F.10 | User Editor Information Shown in User Log | 449 |
| F.11 | User Editor Information Shown in System Log | 450 |
| Appendix G | IPv6 Settings | 451 |
| G.1 | About IPv6 Support for the Scanner | 452 |
| | ■ Software That Is Not Updated to Support IPv6 | 452 |
| G.2 | Configuring IPv6 Settings for the Scanner | 453 |
| G.2.1 | Installing the IPv6 Function | 453 |
| | ■ Enabling the IPv6 Function | 453 |
| | ■ Configuring an IPv6 Communication Environment | 453 |
| | ■ Using the Office Functions via IPv6 | 454 |
| G.2.2 | Linked Server | 454 |
| G.2.3 | Port Number List | 456 |
| G.3 | Configuring IPv6 Communication Environment | 457 |
| G.3.1 | Giving the Scanner an IPv4 Address | 457 |
| G.3.2 | Giving the Scanner an IPv6 Address | 458 |
| G.3.3 | Setting the DNS Server (IPv4) | 460 |
| G.3.4 | Setting the DNS Server (IPv6) | 461 |
| G.3.5 | Checking the Network Operating Status | 462 |
| G.4 | Using the Settings of the IPv6 Function for the Scanner in Other Scanners | 463 |
| G.4.1 | Distributing System Settings from the Central Admin Server..... | 463 |
| G.4.2 | Backing-up and Restoring System Settings | 464 |
| Glossary | | 465 |
| About Maintenance | | 468 |
| Copyright | | 469 |
| Index | | 476 |

Introduction

Thank you for purchasing FUJITSU Image Scanner N7100E (hereinafter referred to as "the scanner").

This scanner is a network image scanner. This easy-to-operate scanner facilitates the optimal flow of office work for workgroups communicating via a network.

Trademarks

Adobe, Acrobat, and Reader are either registered trademarks or trademarks of Adobe in the United States and/or other countries.

Intel is a trademark of Intel Corporation or its subsidiaries in the U.S. and/or other countries.

ABBYY™ FineReader™ Engine © ABBYY. OCR by ABBYY

ABBYY and FineReader are trademarks of ABBYY Software, Ltd. which may be registered in some jurisdictions.

Linux® is the registered trademark or trademark of Linus Torvalds in the U.S. and other countries.

Red Hat is a registered trademark or trademark of Red Hat, Inc. in the United States and other countries.

ScanSnap and the ScanSnap logo are registered trademarks or trademarks of PFU Limited in Japan.

Other company names and product names are the registered trademarks or trademarks of the respective companies.

Manufacturer

PFU Limited
YOKOHAMA i-MARK PLACE, 4-4-5 Minatomirai, Nishi-ku, Yokohama, Kanagawa,
220-8567, Japan

© PFU Limited 2019-2021

■ Manuals

Types of Manuals

The following manuals are prepared for the scanner. Read them as needed.

| Manual | Description |
|--|--|
| N7100E Getting Started (paper) | Contains important information regarding safety. Also describes the procedure from installing the scanner to starting the scanner operation. Read this manual first. Referred to as "Getting Started" in this manual. |
| N7100E Operator's Guide (this manual)(PDF) | Contains information about the scanner overview, basic operations, daily cleaning, replacement of consumables, and troubleshooting. Referred to as "Operator's Guide" in this manual. |
| N7100E Help (HTML) | Provides information about items on the screens, and descriptions and actions to take for the messages. Read it as needed. |
| Scanner Central Admin User's Guide (PDF) | Provides information about overview, introduction procedure, operation procedure, and maintenance procedure for Scanner Central Admin. Read it as needed. |

Accessing the Manuals

- The manuals can be accessed by downloading them from the scanner.
- When the [Help] button is available on the window or dialog box that is displayed during the operation, you can open Help by clicking it.

On the touch panel,  is displayed as a Help button.

■ About This Manual

Warning Indications Used in This Manual

The following indications are used in this manual to obviate any chance of accident or damage to you and people near you, and your property. Warning labels indicate the warning level and statements. The symbols indicating warning levels and their meanings are as follows:



This indication alerts operators to an operation that, if not strictly observed, may result in severe injury or death.



This indication alerts operators to an operation that, if not strictly observed, may result in safety hazards to personnel or damage to the product.

Symbols Used in This Manual

Besides warning indicators, the following symbols are also used in this manual:

| | |
|--|--|
| | <p>This symbol is used to indicate information about administrator operations. Each operation method is indicated by the following symbols:</p> <ul style="list-style-type: none"> ● Administrator operating via the touch panel. ● Administrator operating via the network interface using the Network Scanner Admin Tool. ● Administrator operating via the network interface using the Scanner Central Admin Console. |
| | <p>This symbol is used to indicate information about regular user operations.</p> |

Arrow Symbols in This Manual

Right-arrow symbols (→) are used to connect icons or menu options you should select in succession.

Example: Select the [Start] menu → [Computer].

Screen Examples in This Manual

Microsoft product screenshots are reprinted with permission from Microsoft Corporation. The actual windows and operations may differ depending on the operating system. If the actual screen differs from the screen examples in this manual, operate by following the actual displayed screen.

Screen examples in this manual are based on screens shown on the touch panel.

Screens, setting items, and operations are different for the Admin Tool and Central Admin Console. For details about screens, refer to Help.

Abbreviations Used in This Manual

The following abbreviations are used in this manual:

| Abbreviation Used | Option |
|------------------------|--|
| Windows | Windows [®] operating system |
| Windows 8.1 | Windows [®] 8.1 operating system (32-bit/64-bit) Windows [®] 8.1 Pro operating system (32-bit/64-bit) Windows [®] 8.1 Enterprise operating system (32-bit/64-bit) |
| Windows 10 | Windows [®] 10 Home operating system (32-bit/64-bit) Windows [®] 10 Pro operating system (32-bit/64-bit) Windows [®] 10 Enterprise operating system (32-bit/64-bit) Windows [®] 10 Education operating system (32-bit/64-bit) |
| Windows Server 2012 | Windows Server [®] 2012 Standard (64-bit) |
| Windows Server 2012 R2 | Windows Server [®] 2012 R2 Standard (64-bit) |
| Windows Server 2016 | Windows Server [®] 2016 Standard (64-bit) |
| Windows Server 2019 | Windows Server [®] 2019 Standard (64-bit) |
| Exchange | Microsoft [®] Exchange Server 2010 (supported by 64-bit operating systems only) Microsoft [®] Exchange Server 2013 (supported by 64-bit operating systems only) Microsoft [®] Exchange Server 2016 (supported by 64-bit operating systems only) Microsoft [®] Exchange Server 2019 (supported by 64-bit operating systems only) |
| .NET Framework | Microsoft [®] .NET Framework |

| Abbreviation Used | Option |
|------------------------------|--|
| SharePoint (*1) | Microsoft® SharePoint® Server 2010 (supported by 64-bit operating systems only) Microsoft® SharePoint® Server 2013 (supported by 64-bit operating systems only) Microsoft® SharePoint® Server 2016 (supported by 64-bit operating systems only) Microsoft® SharePoint® Server 2019 (supported by 64-bit operating systems only) |
| SharePoint Online (*1) | Microsoft® SharePoint® Online |
| Solaris | Solaris 10 or later |
| Red Hat Enterprise Linux | Red Hat® Enterprise Linux® 5 or later |
| SUSE Linux Enterprise Server | SUSE™ Linux Enterprise Server 10 or later |
| Internet Explorer | Microsoft® Internet Explorer® Windows® Internet Explorer® |
| IIS | Microsoft® Internet Information Services 6.0 Microsoft® Internet Information Services 7.0 Microsoft® Internet Information Services 7.5 Microsoft® Internet Information Services 8.0 Microsoft® Internet Information Services 8.5 Microsoft® Internet Information Services 10.0 |
| Adobe Acrobat | Adobe® Acrobat® Adobe® Acrobat® DC |
| Adobe Reader | Adobe® Reader® Adobe® Acrobat® Reader® DC |
| RightFax | RightFax Business Server (Version 9.3) |
| Kofax Communication Server | Kofax® Communication Server |
| WPF | Windows Presentation Foundation |
| MIB | Management Information Base |
| N7100E | FUJITSU Image Scanner N7100E |
| N7100 | FUJITSU Image Scanner N7100 |

| Abbreviation Used | Option |
|-----------------------|--|
| N1800 | ScanSnap N1800 |
| fi-6010N | FUJITSU Image Scanner iScanner fi-6010N |
| Scanner | N7100E |
| Admin Tool | Network Scanner Admin Tool |
| User Editor | Network Scanner User Editor |
| Central Admin Console | Scanner Central Admin Console |
| Central Admin Server | Scanner Central Admin Server |
| SDK | Network Scanner Control SDK |
| Gmail | Gmail [®] Webmail Service |
| Yahoo! Mail | YAHOO! [®] Mail |
| AOL Mail | AOL [®] Mail |
| Network Folder | A folder that is set to save scanned data in the file server |
| FTP Server Folder | A folder that is set to save scanned data in the FTP server |
| SharePoint Folder | A folder that is set to save scanned data in the SharePoint server |

(*1): Where there is no distinction between SharePoint and SharePoint Online, the general term "SharePoint" is used.

Chapter 1

Overview

Admin User

- 1.1 Scanner Features 22
- 1.2 Part Names and Functions 26
- 1.3 User Types and Operations 29
- 1.4 Required Scanner Function Settings (Administrator) 35
- 1.5 System Requirements 40

1.1 Scanner Features

■ Basic Uses for Scanned Data

This easy-to-operate network image scanner is used to scan documents for further use:

1. Scanned data can be sent as an e-mail attachment.
2. Scanned data can be sent by fax.
3. Scanned data can be printed on a network printer.
4. Scanned data can be saved in a network folder.
5. Scanned data can be saved in an FTP server folder.
6. Scanned data can be saved in a SharePoint folder.

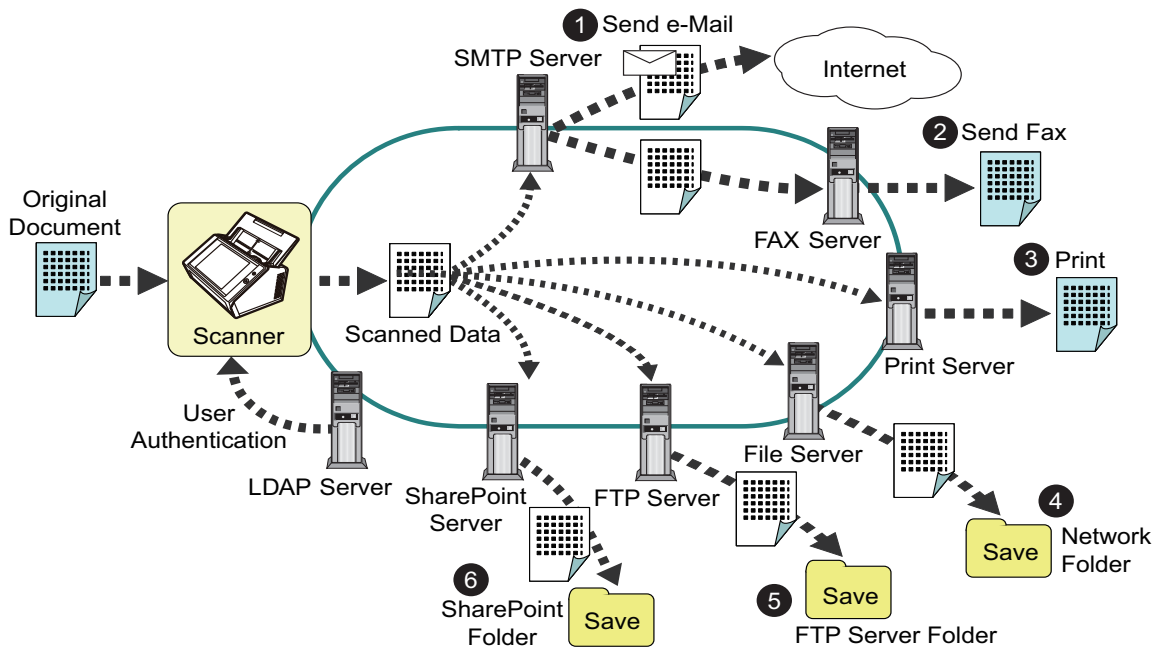

■ Configure and Manage with Ease

Configuration and management of the scanner can be easily performed via the touch panel on the scanner or via the "Admin Tool" or the "Central Admin Console" installed on a computer.

When you use the scanner, login to the scanner as a user with the administrator right or regular user right.

For more details about the operation rights, refer to ["1.3 User Types and Operations" \(page 29\)](#).

Configuration and management of the scanner must be performed by an administrator.

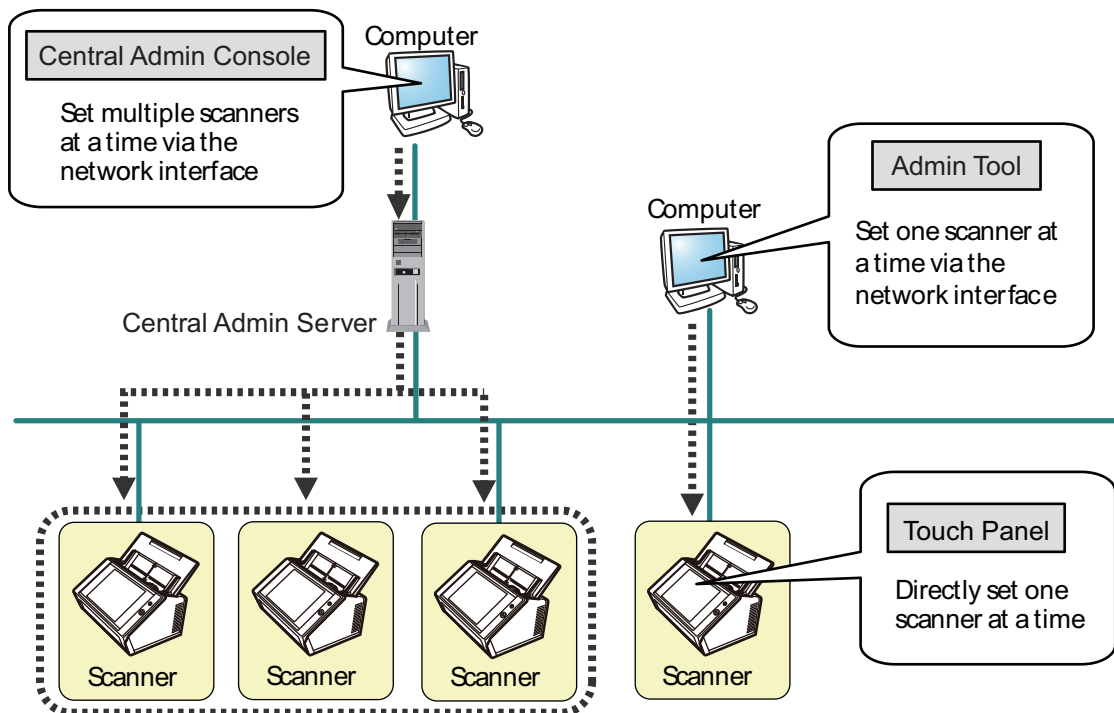

- **Touch panel**

Scanner settings management can be implemented directly via the scanner's touch panel.

Setting mode

The administrator can operate the touch panel in the following setting modes.

- **Basic mode**
A setting mode for Administrators with basic knowledge of computers. Basic required scanner settings can be performed.
- **Advanced mode**
A setting mode for Administrators with advanced knowledge of networks and servers. Settings which are more advanced than those of Basic mode, such as authentication server, server environment, and advanced scanning settings, can be configured.

For details about the configuration of setting modes, refer to ["4.3.1 Configuring the Setting Mode" \(page 75\)](#).

In addition, using the Installation Wizard on the touch panel allows you to configure the minimum scanner settings required to operate the scanner. You can also use the Installation Wizard to restrict the configurable functions. For details about the configuration with the wizard, refer to "[4.3.2 Setting the System Settings with the Installation Wizard](#)" (page 76).

- **Admin Tool**

Application that connects to each scanner and configures the scanner settings. Scanner settings management and updates can be implemented via the network interface by using Admin Tool installed on a computer. The settings can be configured for one scanner at a time.
- **Central Admin Console**

Application that configures operation settings for multiple scanners, and monitors their operating status. Scanner settings management and updates can be implemented via the network interface by using Central Admin Console installed on a computer. The settings can be configured for multiple scanners at a time. This application is used for connecting with Central Admin Server, which manages multiple scanners at the same times. In this case, settings made with Central Admin Console are applied to scanners via a Central Admin Server. To use Central Admin Console, the scanner needs to be turned on. For details about Central Admin Console, refer to the Scanner Central Admin User's Guide.

■ Advanced Security Measures

The following security functions are provided for the scanner:

- Login authentication can restrict user access.
- Scanned data can be converted to password protected PDF files.
- Scanned data can be protected.

Since the scanner is intended to be shared by multiple users, data privacy is an important factor. The following security measures are used to protect the data against untoward access:

- Encryption

The scanned data is temporarily saved in the scanner while being e-mailed, faxed, printed, or saved in a folder.

The data is always saved in the disk in an encrypted form in case the disk contents are analyzed. Encrypted data will prevent the data from exposure.

- Scanned data deletion

After the scanned data has been e-mailed, faxed, printed or saved, the temporary data is deleted.

Check whether or not the scanned data has been e-mailed, faxed, printed, or saved properly in the user log. If you find any errors in the user log, try scanning again.

Even if an error interrupts this process, leaving some scanned data in the scanner, this will automatically be deleted at the next start up.

- Secure initialize

When initializing the data in the scanner, the free disk space is also overwritten with random data with no meaning. When the user data store is cleared from the scanner, the old cipher key is deleted and a new cipher key is generated.

This totally eliminates the possibility of access to any user data remaining in the free disk space.

Input pathways for files from an external memory media and for files from outside via a network are limited to a minimum by the scanner. Security patches will be provided as needed to protect the scanner against virus attacks. Taking these measures enables the scanner to be protected against virus infection.

1.2 Part Names and Functions

■ Front View

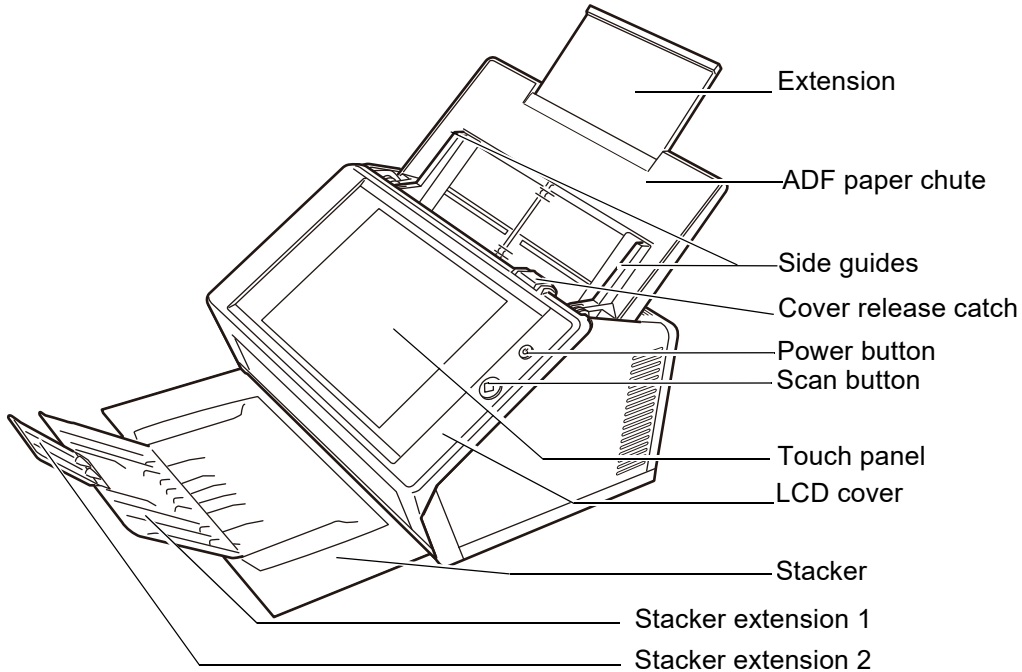

| Part Name | Function |
|---------------------|--|
| Extension | Can be pulled out and adjusted to the size of the document being scanned. |
| ADF paper chute | Holds the documents waiting to be scanned. |
| Side guides | Adjust to the width of the paper, to prevent skewing of the scanned pages. |
| Cover release catch | Pull to open the LCD cover. |
| Power button | Turns on scanner or brings up the [Login] window from standby mode or power off status. For details, refer to "Using the Power Button" (page 51) . |
| Scan button | Starts the scan process. For details, refer to "Using the Scan Button" (page 53) . |
| Touch panel | Shows menus. Operations can be performed by touching the displayed menu. For details, refer to "Using the Touch Panel" (page 54) . |
| LCD cover | Open by pulling the cover release catch towards you, and holding the LCD cover by the sides to replace consumable parts or clean inside the scanner. |

| Part Name | Function |
|---------------------|---|
| Stacker | Pull out before scanning. Scanned documents are ejected on the stacker. |
| Stacker extension 1 | Lift up towards you to adjust to the document length. |
| Stacker extension 2 | Lift up towards you to adjust to the document length. |

■ **Rear View**

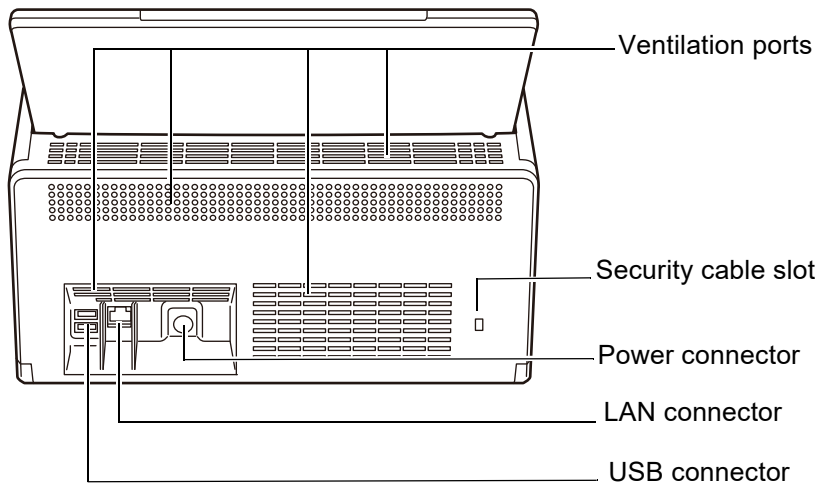

| Part Name | Function |
|---------------------|---|
| Ventilation ports | Lets out the heated air from the inside of the scanner to the outside. |
| Security cable slot | Slot for commercially available security cable to prevent against theft. The following security cable is recommended: Cylindrical part: diameter 25 mm (max), length 50 mm (max) Type: Right angle (includes bent part if a straight cable is used) |
| Power connector | Connects the power cable to the scanner. |
| LAN connector | Connects the LAN cable to the scanner. |
| USB connector | Connects a USB device to the scanner. |

■ Removable Parts

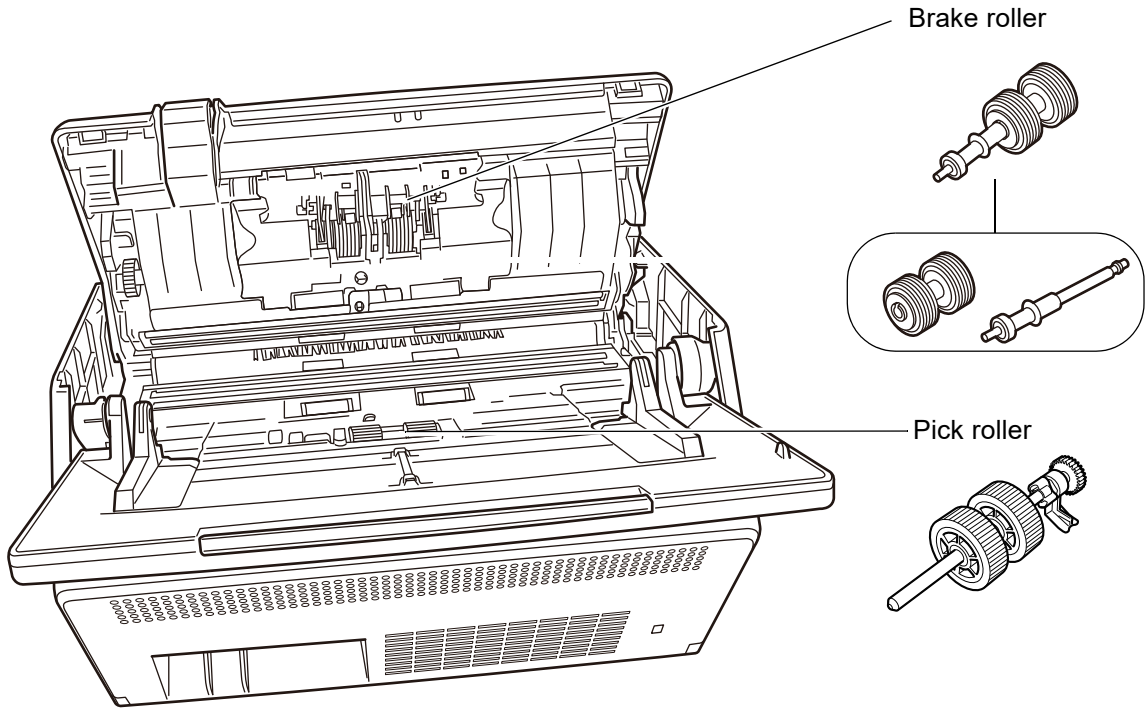

| Part Name | Function |
|--------------|---|
| Pick roller | Helps to guide documents from the ADF paper chute to the stacker. |
| Brake roller | Helps to separate each sheet off documents loaded in the ADF paper chute. |

1.3 User Types and Operations

When you use the scanner, login to the scanner as a user with the following operation right:

- **Regular user rights**
Operation rights given when you login to the scanner with a regular user account. For an account with regular user rights, an LDAP account, a local account, and a default account (guest account) can be used.
When you login to the scanner with these rights, you are a "regular user" of the scanner.
A regular user can scan documents and then send, print, or save the resulting data.
- **Administrator rights**
Operation rights given when you login to the scanner with an administrator account.
For an account with administrator rights, a default account (admin account) and a local account (administrator) can be used.
When you login to the scanner with these rights, you are an "administrator" of the scanner.
An administrator can set up and manage the scanner.
An administrator cannot scan documents (an administrator can perform a scan test only).

HINT

Local accounts can be edited in User Editor. For details, refer to ["Appendix F Editing Using User Editor" \(page 428\)](#).

Note that the method of login to the scanner varies depending on the user type as follows:

| Operation rights | Login method | | |
|----------------------|--------------|------------|-----------------------|
| | Touch panel | Admin Tool | Central Admin Console |
| Regular user rights | Yes | — | — |
| Administrator rights | Yes | Yes | Yes |

Yes: Available —: Not available

The following table lists the operations available for the administrator and regular users.

1.3.1 Operations with Administrator Right

| Item | Touch panel | | | Admin Tool | Central Admin Console |
|---|-------------|------------|---------------|------------|-----------------------|
| | Wizard | Basic mode | Advanced mode | | |
| Admin Menu | | | | | |
| Select Mode (P.75) | — | Yes | Yes | — | — |
| Installation Wizard (P.76) | — | Yes | Yes | — | — |
| Local Settings | | | | | |
| Import Scanner Settings (*1) | — | — | — | — | Yes |
| Scanner Name (P.78) | Yes | Yes | Yes | Yes | — |
| Language Selection (P.80) | — | Yes | Yes | Yes | — |
| Region / Timezone (P.81) | Yes | Yes | Yes | Yes | Yes |
| Date / Time (P.82) | Yes | Yes | Yes | Yes | Yes (*2) |
| Keyboard Settings (P.83) | — | — | Yes | Yes | Yes |
| Certificate Management (P.84) | — | — | Yes (*3) | Yes | Yes |
| Scanner Settings | | | | | |
| Multifeed Settings (P.86) | — | — | Yes | Yes | Yes |
| Scanner Adjustment (P.88) | — | — | Yes | Yes | — |
| General Scanner Settings (P.89) | — | — | Yes | Yes | Yes |
| Login Settings | | | | | |
| Login Settings (P.90) | Yes | — | Yes | Yes | Yes |
| Login Settings Details (P.93) | Yes | — | Yes | Yes | Yes |
| Standby Mode (P.95) | — | — | Yes | Yes | Yes |
| Admin Password (P.97) | Yes | Yes | Yes | Yes | — |
| LAN Manager authentication level (P.98) | — | — | Yes | Yes | Yes |

| Item | Touch panel | | | Admin Tool | Central Admin Console |
|--|-------------|------------|---------------|------------|-----------------------|
| | Wizard | Basic mode | Advanced mode | | |
| Network Settings (when the IPv6 function is disabled) | | | | | |
| IP Address (P.99) | Yes | Yes | Yes | Yes | — |
| DNS Server (P.101) | Yes | Yes | Yes | Yes | Yes |
| WINS Server (P.102) | — | Yes | Yes | Yes | Yes |
| NTP Server (P.103) | — | — | Yes | Yes | Yes (*4) |
| Proxy Server (P.104) | — | — | Yes | Yes | Yes |
| SNMP Settings (P.105) | — | — | Yes | Yes | Yes |
| SMB 1.0/CIFS (P.106) | — | — | Yes | Yes | — |
| Network Advanced Settings (P.107) | — | — | Yes | Yes | — |
| Network Settings (when the IPv6 function is enabled) (*5) | | | | | |
| IPv4 Address (P.457) | Yes | Yes | Yes | Yes | — |
| IPv6 Address (P.458) | Yes | Yes | Yes | Yes | — |
| DNS Server (IPv4) (P.460) | Yes | Yes | Yes | Yes | — |
| DNS Server (IPv6) (P.461) | Yes | Yes | Yes | Yes | — |
| WINS Server (P.102) | — | Yes | Yes | Yes | — |
| NTP Server (P.103) | — | — | Yes | Yes | — |
| Proxy Server (P.104) | — | — | Yes | Yes | — |
| SNMP Settings (P.105) | — | — | Yes | Yes | — |
| SMB 1.0/CIFS (P.106) | — | — | Yes | Yes | — |
| Network Advanced Settings (P.107) | — | — | Yes | Yes | — |
| Check Network Status | | | | | |
| Ping (P.108) | — | Yes | Yes | Yes | — |
| Network Status (P.109) (P.462) | — | Yes | Yes | Yes | — |
| Network Admin | | | | | |
| Admin Connection (P.110) | — | Yes | Yes | Yes | Yes (*6) |
| Scanner Central Admin Server (P.111) | Yes | Yes | Yes | Yes | Yes (*7) |
| Scanner Central Admin Server Details (P.113) | Yes | Yes | Yes | Yes | Yes (*7) |

| Item | Touch panel | | | Admin Tool | Central Admin Console |
|-------------------------------|-------------|------------|---------------|------------|-----------------------|
| | Wizard | Basic mode | Advanced mode | | |
| Authentication Server | | | | | |
| Login LDAP Server (P.114) | — | — | Yes | Yes | Yes |
| e-Mail LDAP Server (P.121) | — | — | Yes | Yes | Yes |
| Schema (P.122) | — | — | Yes | Yes | Yes |
| Customize LDAP Search (P.123) | — | — | Yes | Yes | Yes |
| e-Mail | | | | | |
| SMTP Server (P.125) | — | Yes | Yes | Yes | Yes |
| SMTP Server Extension (P.126) | — | Yes | Yes | Yes | Yes |
| Send e-Mail (P.127) | — | — | Yes | Yes | Yes |
| File Names (e-Mail) (P.128) | — | — | Yes | Yes | Yes |
| Fax | | | | | |
| Fax Server (P.129) | — | Yes | Yes | Yes | Yes |
| Save | | | | | |
| Network Folder (P.130) | — | Yes | Yes | Yes | Yes (*8) |
| FTP Server Folder (P.136) | — | Yes | Yes | Yes | Yes (*8) |
| SharePoint Folder (P.140) | — | Yes | Yes | Yes | Yes (*8) |
| File Names (Save) (P.144) | — | — | Yes | Yes | Yes |
| Print | | | | | |
| Network Printer (P.146) | — | Yes | Yes | Yes | Yes (*8) |
| Status Details | | | | | |
| System Status (P.159) | — | Yes | Yes | Yes | Yes (*9) |
| Usage Status (P.160) | — | Yes | Yes | Yes | — |
| Installed Options (P.161) | — | — | Yes | Yes | Yes (*9) |
| User Log (P.162) | — | Yes | Yes | Yes | — |
| System Log (P.164) | — | Yes | Yes | Yes | — |
| Data Management | | | | | |
| User Data Store (P.166) | — | — | Yes (*10) | Yes | — |
| System Settings File (P.170) | — | — | Yes (*10) | Yes | — |

| Item | Touch panel | | | Admin Tool | Central Admin Console |
|-----------------------------------|-------------|------------|---------------|------------|-----------------------|
| | Wizard | Basic mode | Advanced mode | | |
| Maintenance | | | | | |
| System Update (P.174) (P.176) | — | — | Yes (*11) | Yes | Yes (*12) |
| Add-in Software (P.178) | — | — | Yes (*11) | Yes | Yes (*12)(*13) |
| Technical Support (P.181) (P.182) | — | — | Yes (*11) | Yes | — |
| Alert Notification (P.183) | — | — | Yes | Yes | Yes |
| Device Test | | | | | |
| Calibrate Screen (P.359) | — | Yes | Yes | — | — |
| Scan Test (P.356) | — | Yes | Yes | — | — |
| Job Menu Settings | | | | | |
| Job Sequences (P.191) | — | — | — | Yes | Yes |
| Job Menus (P.201) | — | — | — | Yes | Yes |
| Job Groups (P.206) | — | — | — | Yes | Yes |

Yes: Available —: Not available

- (*1): For the operations, refer to the Scanner Central Admin User's Guide.
- (*2): The [Date / Time] input field and [Get Time] button cannot be used.
- (*3): Certificates cannot be imported.
- (*4): Synchronization not possible.
- (*5): If you set [IPv6 Function] to [On] on the window that is displayed when [Network Advanced Settings] under [Network Settings] is selected, the menu that is displayed on the window is switched to the menu that supports the enabled IPv6 function.
- (*6): Contents of the SSL Certificate are not shown.
- (*7): [Address] and [Port Number] cannot be set.
- (*8): Printers, folders and SharePoint folders that can be accessed from the Central Admin Server can be set.
- (*9): This can be viewed on the Central Admin Console [Scanner Details] window. This cannot be viewed on the scanner settings edit window, which is displayed by pressing the [Edit Scanner Settings] button in the Central Admin Console [Scanner Settings] window.
- (*10): When using the touch panel, only the following operations can be performed:
Clearing the user data store, system settings reset, and secure initialize

- (*11): When using the touch panel, the following operations cannot be performed.
Update, add-in installation/uninstallation, and obtaining technical support information
- (*12): This can be operated from the Central Admin Console [Scanner Admin Operations] window.
This cannot be operated from the scanner settings edit window, which is displayed by pressing the [Edit Scanner Settings] button in the Central Admin Console [Scanner Settings] window.
- (*13): For Central Admin Console, selection whether to show the on-screen keyboard is not possible.

1.3.2 Regular User Operations

| Item | Touch panel | Admin Tool | Central Admin Console |
|-------------------------------|-------------|------------|-----------------------|
| e-Mail (P.229) | Yes | — | — |
| Fax (P.243) | Yes | — | — |
| Print (P.251) | Yes | — | — |
| Save (P.261) | Yes | — | — |
| Scan Settings (P.264) | Yes | — | — |
| Scan Viewer (P.306) | Yes | — | — |
| Maintenance | | | |
| Edit e-Mail Addresses (P.240) | Yes | — | — |
| Edit Fax Numbers (P.249) | Yes | — | — |
| Roller Cleaning (P.339) | Yes | — | — |
| Scan Test (P.356) | Yes | — | — |
| Administrator Login (P.70) | Yes | — | — |
| Change Password (P.334) | Yes | — | — |
| Consumable Alert (P.347) | Yes | — | — |
| Send Status (P.319) | Yes | — | — |
| Job (P.324) | Yes | — | — |

Yes: Available —: Not available

1.4 Required Scanner Function Settings (Administrator)

Which scanner settings are required differs according to scanner functions to be used by the regular user.

The function buttons are displayed on the [Main Menu] window for the regular user, in accordance with the settings specified by the administrator.

Buttons are displayed in accordance with the settings specified by the administrator

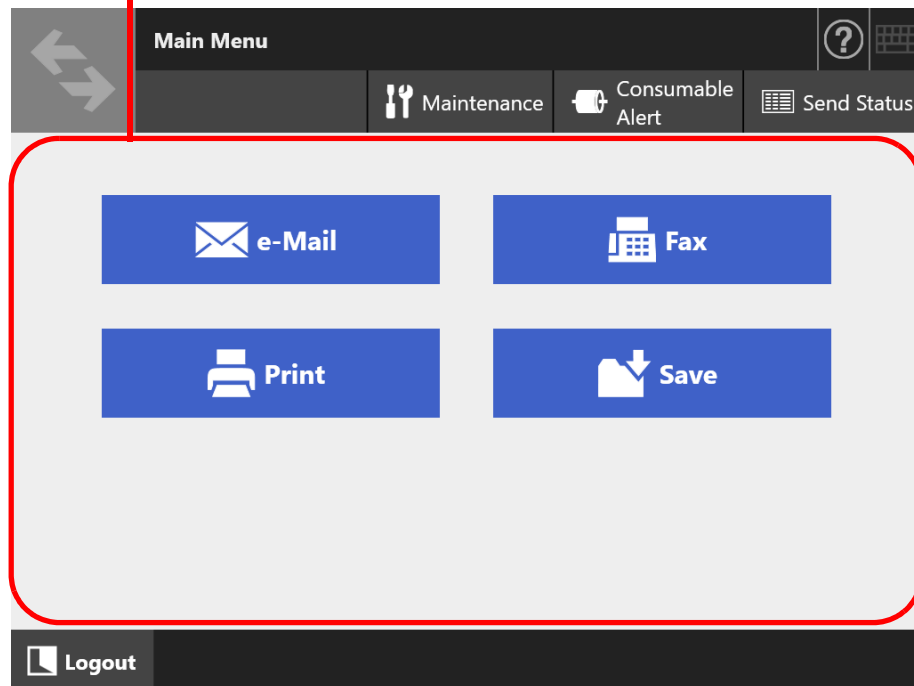

The following shows the necessary settings for each function to be used.

| Item | e-Mail | Fax | Print | Save |
|----------------------------|--------|-----|-------|------|
| Admin Menu | | | | |
| Select Mode (P.75) | A | A | A | A |
| Installation Wizard (P.76) | — | — | — | — |

1.4 Required Scanner Function Settings (Administrator)

| Item | e-Mail | Fax | Print | Save |
|--|--------|-----|-------|------|
| Local Settings | | | | |
| Import Scanner Settings (*1) | — | — | — | — |
| Scanner Name (P.78) | N | N | N | N |
| Language Selection (P.80) | — | — | — | — |
| Region / Timezone (P.81) | A | A | A | A |
| Date / Time (P.82) | A | A | A | A |
| Keyboard Settings (P.83) | N | N | N | N |
| Certificate Management (P.84) | — | — | — | — |
| Scanner Settings | | | | |
| Multifeed Settings (P.86) | — | — | — | — |
| Scanner Adjustment (P.88) | — | — | — | — |
| General Scanner Settings (P.89) | — | — | — | — |
| Login Settings | | | | |
| Login Settings (P.90) | — | — | — | — |
| Login Settings Details (P.93) | — | — | — | — |
| Standby Mode (P.95) | — | — | — | — |
| Admin Password (P.97) | A | A | A | A |
| LAN Manager authentication level (P.98) | — | — | — | — |
| Network Settings (when the IPv6 function is disabled) | | | | |
| IP Address (P.99) | N | N | N | N |
| DNS Server (P.101) | A | A | A | A |
| WINS Server (P.102) | A | A | A | A |
| NTP Server (P.103) | A | A | A | A |
| Proxy Server (P.104) | — | — | — | A |
| SNMP Settings (P.105) | — | — | — | — |
| SMB 1.0/CIFS (P.106) | — | — | A | A |
| Network Advanced Settings (P.107) | — | — | — | — |

1.4 Required Scanner Function Settings (Administrator)

| Item | e-Mail | Fax | Print | Save |
|--|--------|--------|--------|--------|
| Network Settings (when the IPv6 function is enabled) (*2) | | | | |
| IPv4 Address (P.457) | N (*3) | N (*3) | N (*3) | N (*3) |
| IPv6 Address (P.458) | N (*3) | N (*3) | N (*3) | N (*3) |
| DNS Server (IPv4) (P.460) | A | A | A | A |
| DNS Server (IPv6) (P.461) | A | A | A | A |
| WINS Server (P.102) | A | A | A | A |
| NTP Server (P.103) | A | A | A | A |
| Proxy Server (P.104) | — | — | — | A |
| SNMP Settings (P.105) | — | — | — | — |
| SMB 1.0/CIFS (P.106) | — | — | A | A |
| Network Advanced Settings (P.107) | — | — | — | — |
| Check Network Status | | | | |
| Ping (P.108) | — | — | — | — |
| Network Status (P.109) (P.462) | — | — | — | — |
| Network Admin | | | | |
| Admin Connection (P.110) | — | — | — | — |
| Scanner Central Admin Server (P.111) | — | — | — | — |
| Scanner Central Admin Server Details (P.113) | — | — | — | — |
| Authentication Server | | | | |
| Login LDAP Server (P.114) | A (*4) | A (*4) | A (*4) | A (*4) |
| e-Mail LDAP Server (P.121) | — | — | — | — |
| Schema (P.122) | — | — | — | — |
| Customize LDAP Search (P.123) | — | — | — | — |
| e-Mail | | | | |
| SMTP Server (P.125) | N | N | — | — |
| SMTP Server Extension (P.126) | A | — | — | — |
| Send e-Mail (P.127) | A | — | — | — |
| File Names (e-Mail) (P.128) | A | — | — | — |

1.4 Required Scanner Function Settings (Administrator)

| Item | e-Mail | Fax | Print | Save |
|-----------------------------------|--------|-----|-------|------|
| Fax | | | | |
| Fax Server (P.129) | — | N | — | — |
| Save | | | | |
| Network Folder (P.130) | — | — | — | N |
| FTP Server Folder (P.136) | — | — | — | N |
| SharePoint Folder (P.140) | — | — | — | N |
| File Names (Save) (P.144) | — | — | — | A |
| Print | | | | |
| Network Printer (P.146) | — | — | N | — |
| Status Details | | | | |
| System Status (P.159) | — | — | — | — |
| Usage Status (P.160) | — | — | — | — |
| Installed Options (P.161) | — | — | — | — |
| User Log (P.162) | — | — | — | — |
| System Log (P.164) | — | — | — | — |
| Data Management | | | | |
| User Data Store (P.166) | — | — | — | — |
| System Settings File (P.170) | — | — | — | — |
| Maintenance | | | | |
| System Update (P.174) (P.176) | — | — | — | — |
| Add-in Software (P.178) | — | — | — | — |
| Technical Support (P.181) (P.182) | — | — | — | — |
| Alert Notification (P.183) | — | — | — | — |
| Device Test | | | | |
| Calibrate Screen (P.359) | — | — | — | — |
| Scan Test (P.356) | — | — | — | — |
| Job Menu Settings | | | | |
| Job Sequences (P.191) | A | A | A | A |
| Job Menus (P.201) | A | A | A | A |
| Job Groups (P.206) | A | A | A | A |

N: Necessary A: Advisable —: Not required

- (*1): For the operations, refer to the Scanner Central Admin User's Guide.
- (*2): If you set [IPv6 Function] to [On] on the window that is displayed when [Network Advanced Settings] under [Network Settings] is selected, the menu that is displayed on the window is switched to the menu that supports the enabled IPv6 function.
- (*3): Set either an IPv4 address, an IPv6 address, or both.
- (*4): Required to link with a LDAP server.

1.5 System Requirements

1.5.1 Requirements for Admin Tool and User Editor

For use of Admin Tool and User Editor, the following requirements apply:

Software (English Versions)

- Operating system
 - Windows 8.1
 - Windows 10
 - Windows Server 2012
 - Windows Server 2012 R2
 - Windows Server 2016
 - Windows Server 2019
- .NET Framework (*1)
 - Admin Tool
 - .NET Framework 4.5.2
 - .NET Framework 4.6
 - .NET Framework 4.7
 - .NET Framework 4.8
 - User Editor
 - .NET Framework 3.5 (Service Pack 1 or later)
 - .NET Framework 4.5.2
 - .NET Framework 4.6
 - .NET Framework 4.7
 - .NET Framework 4.8
- Web browser
 - Internet Explorer 10 or later (*2)

(*1): If .NET Framework is not installed, the administrator will be notified. Download .NET Framework from the Microsoft Web site and install it into the computer. When installing .NET Framework, check that there is enough free disk space. Additional free disk space of at least 2 GB is required for .NET Framework 4.5.2.

(*2): For Admin Tool, confirm that the latest security patch has been applied. If the latest patch has not been applied, download operations (such as manual download) may not be possible. If download operations are not possible, clear the [Do not save encrypted pages to disk] check box on [Advanced] of [Internet Options] in Internet Explorer, and then try downloading again. Configure [Compatibility View settings] so that the specified URL is displayed in compatibility view.

ATTENTION

Make sure that the language settings for the computer where Admin Tool and User Editor are installed are the same as the language settings for the scanner.

Hardware

- Computer that runs the supported software and meets the following conditions:
 - 32 MB or more of free memory space
 - 64 MB or more of free disk space
- XGA monitor or better
- LAN cable
- Pointing device (input device such as mouse)

1.5.2 Requirements for Related Servers

For servers that can be linked with the scanner, the following requirements apply. For the supported versions and editions of each operating system, refer to "[Abbreviations Used in This Manual](#)" (page 18).

| Server | System Requirements | Function |
|------------------------------------|---|--------------------------|
| LDAP server (Active Directory) | Windows Server 2012 Windows Server 2012 R2 Windows Server 2016 Windows Server 2019 | Authentication |
| LDAP server (OpenLDAP) | OpenSolaris Solaris Red Hat Enterprise Linux SUSE Linux Enterprise Server | |
| SMTP Server (SMTP, Exchange) | Windows Server 2012 Windows Server 2012 R2 Windows Server 2016 Windows Server 2019 | e-Mail (SMTP Server) |
| File Server (Network Folder) | Windows Server 2012 Windows Server 2012 R2 Windows Server 2016 Windows Server 2019 | Save (Network Folder) |
| File Server (Samba) | OpenSolaris Solaris Red Hat Enterprise Linux SUSE Linux Enterprise Server | |
| FTP Server | Windows Server 2012 Windows Server 2012 R2 Windows Server 2016 Windows Server 2019 | Save (FTP Server Folder) |
| SharePoint Server | SharePoint 2010 SharePoint 2013 SharePoint 2016 SharePoint 2019 | Save (SharePoint Folder) |
| SharePoint Online | SharePoint Online | Save (SharePoint Folder) |

| Server | System Requirements | Function |
|---------------|---|------------------------------|
| Print Server | Windows Server 2012 Windows Server 2012 R2 Windows Server 2016 Windows Server 2019 | Print (Network Printer) (*1) |
| Fax Server | RightFax Kofax Communication Server Internet FAX | Fax (Fax Server) |
| DNS Server | Windows Server 2012 Windows Server 2012 R2 Windows Server 2016 Windows Server 2019 | DNS DNSv6 |
| WINS Server | Windows Server 2012 Windows Server 2012 R2 Windows Server 2016 Windows Server 2019 | WINS |
| DHCP Server | Windows Server 2012 Windows Server 2012 R2 Windows Server 2016 Windows Server 2019 | DHCP DHCPv6 |
| NTP Server | Windows Server 2012 Windows Server 2012 R2 Windows Server 2016 Windows Server 2019 Red Hat Enterprise Linux | NTP |
| SNMP Manager | Windows Server 2012 Windows Server 2012 R2 Windows Server 2016 Windows Server 2019 | SNMP |

(*1): To use as network printer, Windows 10 compatible printer driver must be installed.

LDAP Server

LDAP (Lightweight Directory Access Protocol) is a protocol for accessing a directory databases over a TCP/IP network. It can be used to administrate networked users e-mail addresses and operating environments.

When connected using encryption (SSL), this is called the "LDAPS Server".

The LDAP server can be used to perform the following:

- User authentication at various logins
- Finding or entering e-mail addresses in an address book

SMTP Server

SMTP (Simple Mail Transfer Protocol) is a protocol for sending e-mail.

The SMTP server can be used to perform the following:

- Sending the scanned data as an e-mail
- Sending the scanned data by fax

File Server

The file server shares the disk on a server with other computers on a network, and enables use of the disk from an external computer.

Using this file server enables scanned data to be saved to a network folder.

FTP Server

FTP (File Transfer Protocol) is a standard network protocol used for copying files between hosts on the network based on TCP/IP.

An FTP server which connects with SSL encryption is called an "FTPS Server".

Using this FTP server enables scanned data to be saved to an FTP server folder.

SharePoint Server

SharePoint is the collective name for the elements of a Web browser based document management platform provided by Microsoft.

Using a SharePoint server enables scanned data to be saved to a SharePoint folder.

Print Server

The print server refers to the computer or device used when multiple client computers use a printer on the network. It receives print requests from the client computers on the network and delivers them to the printer connected with the print server.

ATTENTION

- Windows 10 compatible printer drivers (64-bit) must be registered. Digitally signed printer drivers that have passed the WHQL authentication test are recommended.
- Printer must be able to spool print jobs (to hard disk or memory). Contact your printer dealer if uncertain whether your printer has a spool function.
- Printers that allow the status of print errors to be easily checked (via an LCD control panel, or similar) are recommended.

Fax Server

The fax server refers to the computer equipped with a fax modem or a dedicated fax board connected with a telephone line. It is used for sending faxes.

This scanner supports the following fax servers:

- RightFax
- Kofax Communication Server
- Internet FAX

This fax server can be used to send the scanned data by fax.

DNS server

The function of DNS servers is the translation (resolution) of humanly memorable host names and FQDN into the corresponding numeric IP addresses.

WINS Server

The WINS server handles name registration requests from WINS clients and registers their names and IP addresses with the server database. The WINS server responds to NetBIOS name queries submitted by clients and returns the IP address of the queried name if it is listed in the server database.

In addition, when a DNS name resolution fails, the query can be transferred to the WINS server.

DHCP Server

DHCP (Dynamic Host Configuration Protocol) is an auto-configuration protocol used for an IP network. Network administrator intervention is not required when the DHCP server is used because it assigns the IP addresses of scanners as well as computers automatically.

NTP Server

NTP (Network Time Protocol) is a protocol to synchronize the time of computers on the network with the correct time.

It is used when a client makes a time query through the network.

SNMP Manager

SNMP (Simple Network Management Protocol) is a protocol for managing network.

This scanner supports the SNMP version of SNMP v1 only.

The SNMP manager is software for managing devices that support the SNMP protocol.

1.5.3 Port Number List

| Function | From/To | Port Number | Protocol Number |
|---|--------------------------------|---|-----------------|
| Admin Tool Connection | Admin Tool ⇔ Scanner | 80 (HTTP) (*) | 6 (TCP) |
| | | 443 (HTTPS) (*) | 6 (TCP) |
| Central Admin Server Connection | Central Admin Server ⇔ Scanner | 80 (HTTP) (*) | 6 (TCP) |
| | | 443 (HTTPS) (*) | 6 (TCP) |
| | Scanner ⇔ Central Admin Server | 20444 (HTTP/HTTPS) (*) | 6 (TCP) |
| DHCP (Address Auto-configuration) | Scanner ⇔ DHCP server | 67 (DHCP) | 17 (UDP) |
| DNS (Domain Name System) | Scanner ⇔ DNS server | 53 (DNS) | 17 (UDP/TCP) |
| WINS (WINS Server) | Scanner ⇔ WINS server | 1512 (WINS) | 17 (UDP) |
| NTP (Synchronization) | Scanner ⇔ NTP server | 123 (SNTP) | 17 (UDP) |
| Proxy Connection | Scanner ⇔ Proxy server | Free | 6 (TCP) |
| SNMP | SNMP client ⇔ Scanner | 161 (SNMP) | 17 (UDP) |
| | Scanner ⇔ SNMP client | 162 (SNMP TRAP) | 17 (UDP) |
| LDAP Search (Authentication/ e-Mail Address Search) | Scanner ⇔ LDAP server | 389 (LDAP) (*) | 6 (TCP) |
| | | 636 (LDAPS) (*) | 6 (TCP) |
| | | 3268 (Active Directory Global Catalog) (*) | 6 (TCP) |
| | | 3269 (Active Directory Global Catalog over SSL) (*) | 6 (TCP) |
| Sending e-Mail | Scanner ⇔ SMTP server | 25 (SMTP) (*) | 6 (TCP) |
| | | 465 (SMTP over SSL) (*) | 6 (TCP) |
| | | 587 (SMTP over STARTTLS) (*) | 6 (TCP) |
| Sending Fax | Scanner ⇔ SMTP server | 25 (SMTP) (*) | 6 (TCP) |
| | | 465 (SMTP over SSL) (*) | 6 (TCP) |
| | | 587 (SMTP over STARTTLS) (*) | 6 (TCP) |

| Function | From/To | Port Number | Protocol Number |
|------------------------|--------------------------------------|-------------------------------------|---------------------|
| Print | Scanner ⇔ Print server | 137,138,139,445 (SMB) | 6 (TCP) 17 (UDP) |
| | Scanner ⇔ Network printer | 9100 (Standard TCP/IP port monitor) | 6 (TCP) |
| Scan to SharePoint | Scanner ⇔ SharePoint server | 80 (HTTP) (*) | 6 (TCP) |
| | | 443 (HTTPS) (*) | 6 (TCP) |
| Saving to FTP | Scanner ⇔ FTPS server | 20, 21 (FTP) (*) | 6 (TCP) |
| | Scanner ⇔ FTPS server | 989, 990 (FTPS) (*) | 6 (TCP) |
| Saving to a Folder | Scanner ⇔ File server | 137,138,139,445 (SMB) | 6 (TCP) 17 (UDP) |
| Ping | Scanner ⇔ Another computer or server | None | 1 (ICMP) |
| User Editor Connection | User Editor ⇔ Scanner | 80 (HTTP) (*) | 6 (TCP) |
| | | 443 (HTTPS) (*) | 6 (TCP) |

(*): Changing the port number is possible

Chapter 2

Basic Scanner Operations

| | |
|--|----|
| 2.1 Turning the Power On/Off | 49 |
| 2.2 Using the Scanner Buttons | 51 |
| 2.3 Using the Touch Panel | 54 |
| 2.4 Using the On-Screen Keyboard | 55 |

2.1 Turning the Power On/Off

2.1.1 Turning the Power On



Do not move or shake the scanner when it is turned on.
This may damage components in the scanner and cause data to be lost.



1. Press the power button.

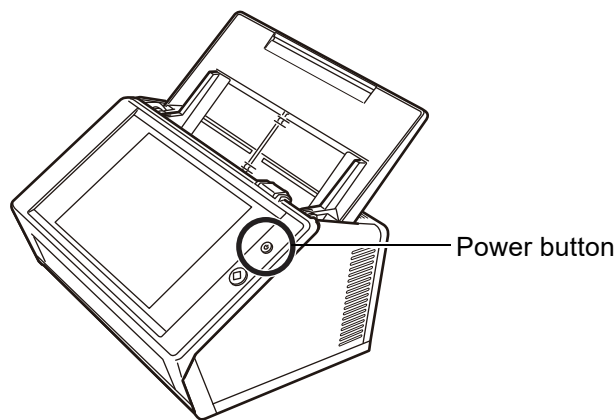

⇒ After the scanner starts up, the [Login] window appears.
The Installation Wizard may be shown depending on the settings.

ATTENTION

After turning the power off, wait for at least 10 seconds before turning the power back on again.

2.1.2 Turning the Power Off

1. Press the [Shutdown] button on the [Login] window.

ATTENTION

To turn the scanner off, make sure to press the [Shutdown] button.

Do not force the scanner to turn off by holding down the power button for 4 seconds or longer.

It may cause the scanner to function abnormally.

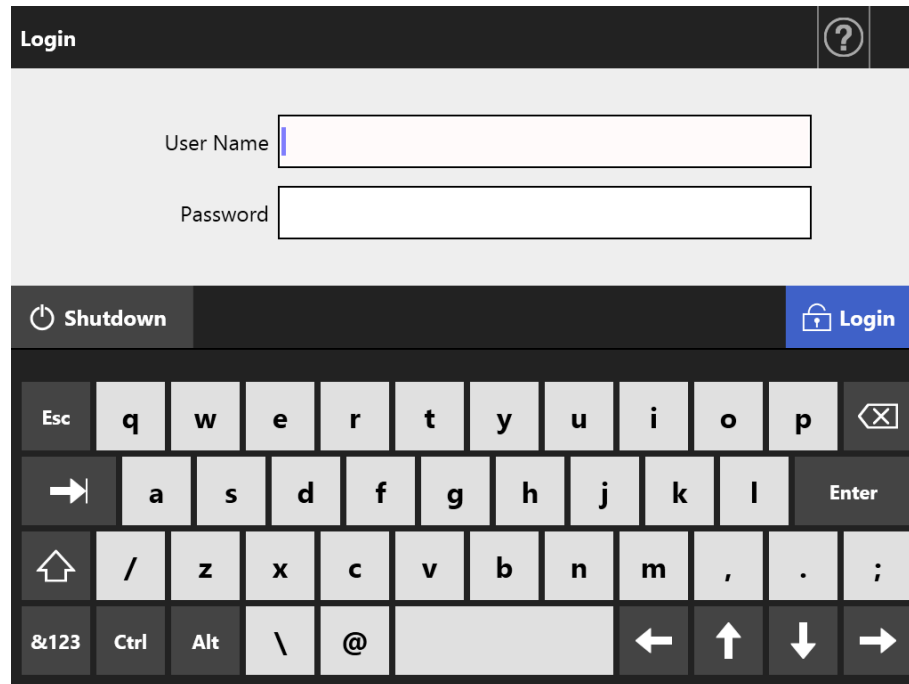

⇒ A confirmation window appears.

2. Press the [OK] button.

⇒ The scanner power is turned off.

2.2 Using the Scanner Buttons

■ Using the Power Button

When the scanner is off or in standby mode, pressing the power button will start the scanner up and display the [Login] window.

When the scanner is on, pressing the power button will show a message.

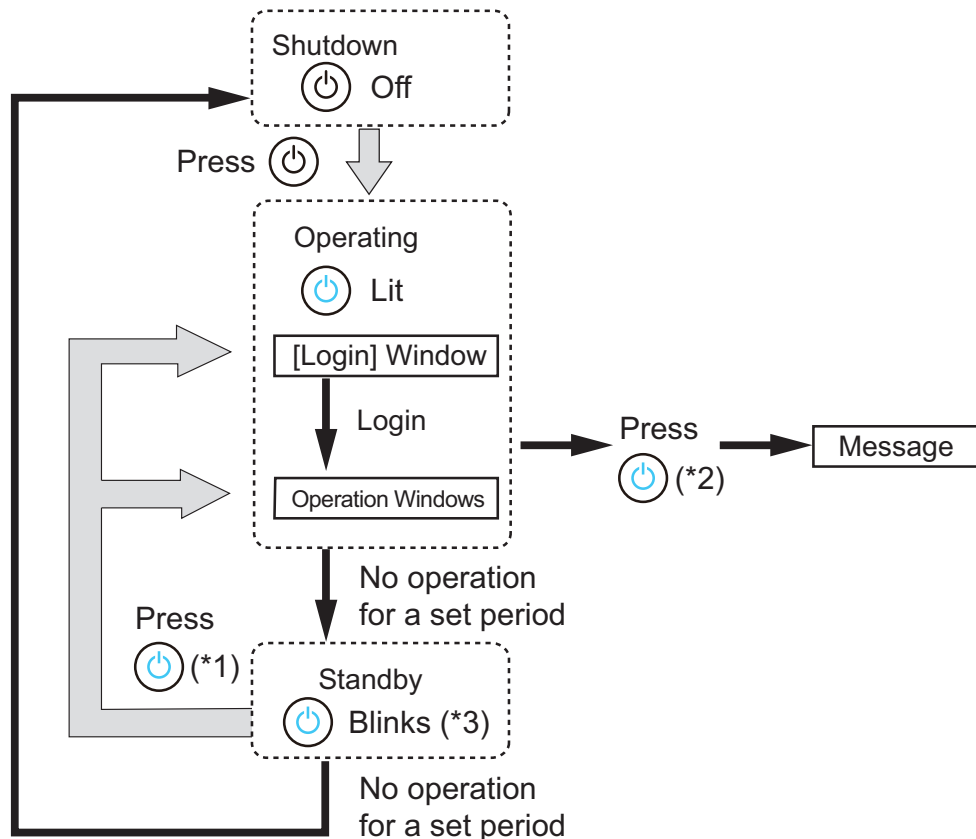

(*1): The following operation will start up the scanner from standby mode.

- Touching the touch panel

Depending on the device, if a human interface device such as an external keyboard is connected to the scanner via USB, any key operations will also startup the scanner.

The window displayed after restarting varies according to the automatic settings in the following way:

- If automatic login is enabled, the operation window is displayed.
- If automatic login is disabled, the [Login] window is displayed.

- (*2):
- When the scanner power button is pressed while a window displaying the [Shutdown] button is shown, the "Please release the power button and select shutdown to turn the scanner off." message appears.
 - When the scanner power button is pressed while a window not displaying the [Shutdown] button is shown, the "Please release the power button. Can not shutdown scanner because the system is in operation." message appears.
- (*3): If [Turn off the display only] is set for [Standby Mode] on the administrator window, only the display turns off. The power button stays lit up.

ATTENTION

- When the scanner is running or in standby mode, do not hold down the power button for 4 seconds or longer, as it may cause the scanner to shutdown. If this happens, saved scanned data may become unusable.
If you hold down the power button for 4 seconds or longer and the scanner is shutdown, remove the AC cable to ensure that the power is completely off.
- After turning the power off, wait for at least 10 seconds before turning the power back on again. To shutdown the scanner correctly, press the [Shutdown] button on the window.

HINT

- If the scanner is left in standby mode until the time set for [Power-off after], the power of the scanner is automatically turned off. Note that if this occurs, it takes time to turn the scanner on again.
- The time to enter standby mode and to power off the scanner can be changed. For details, refer to ["4.6.3 Setting the Standby Mode" \(page 95\)](#).
- Automatic login without displaying the [Login] window is possible. For details about how to set automatic login, refer to ["4.6.1 Setting the Login Settings" \(page 90\)](#).
- If automatic login is set, login via the Admin Tool is possible while the main menu or job menu is displayed.

■ Using the Scan Button

When a button with  is displayed on the touch panel, the Scan button can be used.

 is displayed in the lower right of the regular user window.

When a button with  is displayed, the Scan button can be pressed to start the scan.

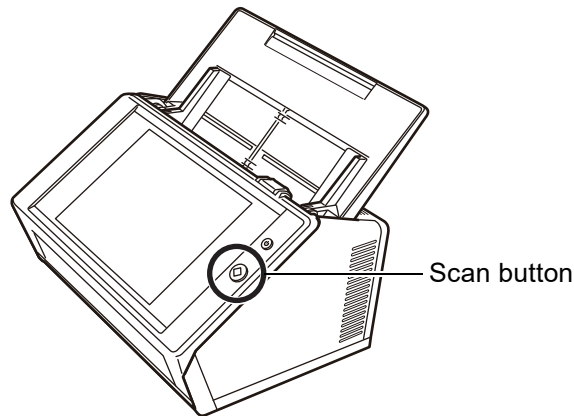

Buttons with  are as follows:

- [Scan]
- [Scan & Send]
- [Scan & Print]
- [Scan & Save]
- [Scan More]

One of those buttons on the touch panel can be pressed to start the scan.

2.3 Using the Touch Panel

When using the touch panel, buttons only need to be lightly pressed to select them.

For details about the touch panel, refer to the following:

- ["4.1.1 Administrator Windows via the Touch Panel" \(page 67\)](#)
- ["5.2 Using Touch Panel Windows: Regular User" \(page 223\)](#)

ATTENTION

- Do not use a pen or other hard objects on the touch panel.
The touch panel may be damaged.
- If the screen is dirty, this may cause the touch panel to malfunction. Clean the screen if it is visibly dirty.
For details about how to perform cleaning, refer to ["Cleaning the Touch Panel" \(page 338\)](#).



2.4 Using the On-Screen Keyboard

On the touch panel, the on-screen keyboard can be used to enter text in the input field on the window.

The on-screen keyboard can be used in the following ways.

■ Showing/Hiding the On-Screen Keyboard

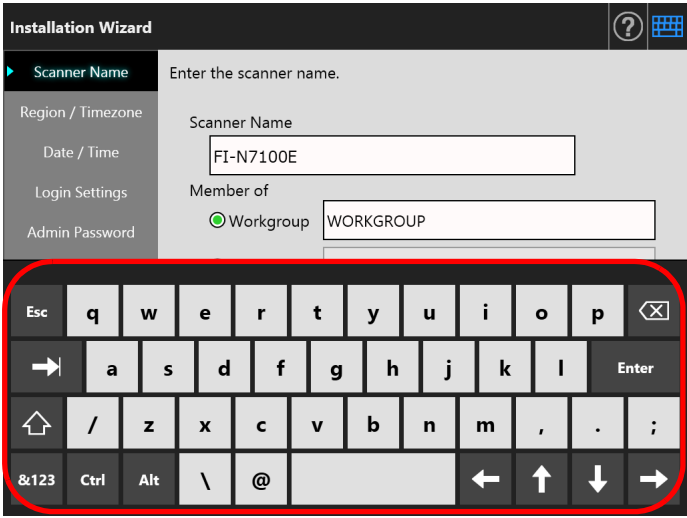
To show/hide the on-screen keyboard, press the following button displayed on the touch panel.

| Button | Description |
|---|---|
|  | <p>This button is displayed when the input field for an item is selected and the on-screen keyboard is shown.</p> <p>The on-screen keyboard is displayed to enable entering characters.</p>  |
|  | <p>This button is displayed when no input field is selected.</p> <p>In this state, the on-screen keyboard cannot be displayed.</p> |

In the [Login] window, the on-screen keyboard is automatically displayed.

HINT

- You can use the [Keyboard Settings] window to set the on-screen keyboard not to be displayed.
For details, refer to ["4.4.5 Setting the Keyboard" \(page 83\)](#).
- For an Add-in, you can use the [Add-in Software] window to set the on-screen keyboard not to be displayed when running an Add-in.
When you display the on-screen keyboard when running an Add-in, you can change the display location of the button used for displaying the on-screen keyboard.
For details, refer to ["4.17.3 Maintaining Add-in Modules" \(page 178\)](#).

■ Using the On-Screen Keyboard

| Key | Function |
|-------|--|
| Tab | Switches focus to the input field. |
| Enter | Performs the following. <ul style="list-style-type: none">● Closes the on-screen keyboard if it is displayed.● Inserts a line feed when multiple lines are input in the input field.● Commits the input in the [Login] window. |

HINT

When logged in via the touch panel, the administrator cannot select the menu items using the on-screen keyboard.

Select buttons in the menu on the touch panel.

■ Keyboard Layout

The on-screen keyboard is compliant with the QWERTY layout.

The keyboard layout of the on-screen keyboard can be switched by pressing a specific key. For details, refer to ["D.4 Changing the Functions on the On-Screen Keyboard" \(page 419\)](#).

Chapter 3

Software Installation

Admin

This chapter describes how to install the software required for scanner configuration and management as well as the pre-settings required for installation.

| | |
|--|-----------|
| 3.1 Setting Up Internet Explorer | 58 |
| 3.2 Showing the Software Download Window..... | 60 |
| 3.3 Installing the Admin Tool | 62 |
| 3.4 Uninstalling the Admin Tool | 64 |
| 3.5 Installing the Central Admin Console and Central Admin Server | 65 |

3.1 Setting Up Internet Explorer

This section describes the Internet Explorer settings required for installing the Admin Tool.

ATTENTION

- The setup procedure may differ depending on the version of Internet Explorer.
- Configure the network settings to not use a proxy server.

HINT

- If any updates or service packs are available for Internet Explorer, make sure they are applied.
- For the system requirements for using the Admin Tool, "[1.5.1 Requirements for Admin Tool and User Editor](#)" (page 40).

■ Checking the Internet Explorer Cache Settings

Check the Internet Explorer cache settings.

1. **Select [Internet Options] from the [Tools] menu in Internet Explorer.**
 - ⇒ The [Internet Options] dialog box appears.
2. **On the [General] tab, press the [Settings] button for [Browsing history].**
 - ⇒ The [Temporary Internet Files and History Settings] dialog box appears.
3. **For [Check for newer versions of stored pages], select [Automatically].**
4. **For [Disk space to use], specify 63 MB or above.**
5. **Press the [OK] button.**

■ Setting Trusted Sites for Internet Explorer

Add the URL of a target scanner to a local intranet or add it as a trusted site for Internet Explorer.

If not set, connection to a scanner is blocked, and certification cannot be installed.

Adding the Scanner to a Local Intranet

1. **Select [Internet Options] from the [Tools] menu in Internet Explorer.**
 - ⇒ The [Internet Options] dialog box appears.
2. **On the [Security] tab, select [Local Intranet].**
3. **Press the [Sites] button.**
 - ⇒ The [Local Intranet] dialog box appears.
4. **Press the [Advanced] button.**
5. **Clear the [Require server verification (https:) for all sites in this zone] check box.**
6. **Enter the URL of the scanner in the [Add this website to the zone] field, and press the [Add] button.**

Example: `http://IP_address or scanner_name/`

Adding the Scanner as a Trusted Site

1. **Select [Internet Options] from the [Tools] menu in Internet Explorer.**
 - ⇒ The [Internet Options] dialog box appears.
2. **On the [Security] tab, select [Trusted sites].**
3. **Press the [Sites] button.**
 - ⇒ The [Trusted sites] dialog box appears.
4. **Clear the [Require server verification (https:) for all sites in this zone] check box.**
5. **Enter the URL of the scanner in the [Add this website to the zone] field, and press the [Add] button.**

Example: `http://IP_address or scanner_name/`

3.2 Showing the Software Download Window

To show the download window for installing the software, follow the procedure below.

1. Access the scanner from Internet Explorer by specifying the scanner name in a URL.

According to the settings described in "[4.9.1 Setting the Admin Connection](#)" (page 110), specify the URL in one of the following ways:

- SSL is [Off], no port number change
`http://scanner_name or IP_address/`
- SSL is [Off], port number change
`http://scanner_name or IP_address:port_number/`
For port_number, enter the changed port number.
- SSL is [On], no port number change
`https://scanner_name or IP_address/`
- SSL is [On], port number change
`https://scanner_name or IP_address:port_number/`
For port_number, enter the changed port number.

With SSL, a security alert is displayed when the scanner is connected. Even so, continue browsing.

⇒ The login window appears.

2. Enter the user name and password of the administrator.

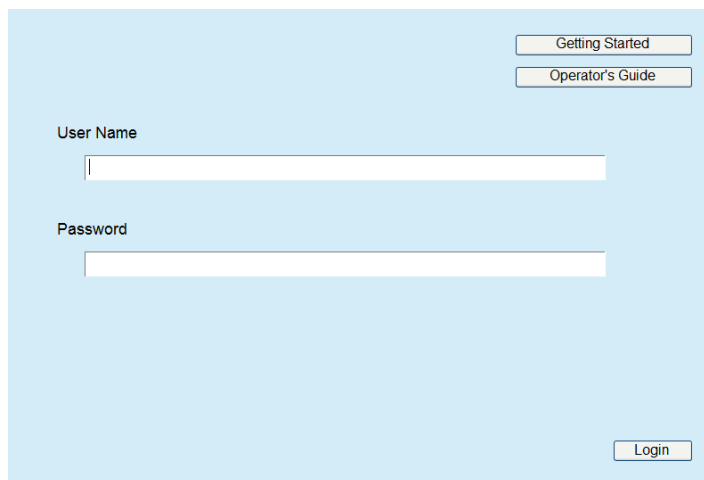

The screenshot shows a light blue login window. In the top right corner, there are two buttons: "Getting Started" and "Operator's Guide". Below these, on the left side, are the labels "User Name" and "Password" above two white text input fields. In the bottom right corner, there is a "Login" button.

3. Press the [Login] button.

⇒ The download window appears.

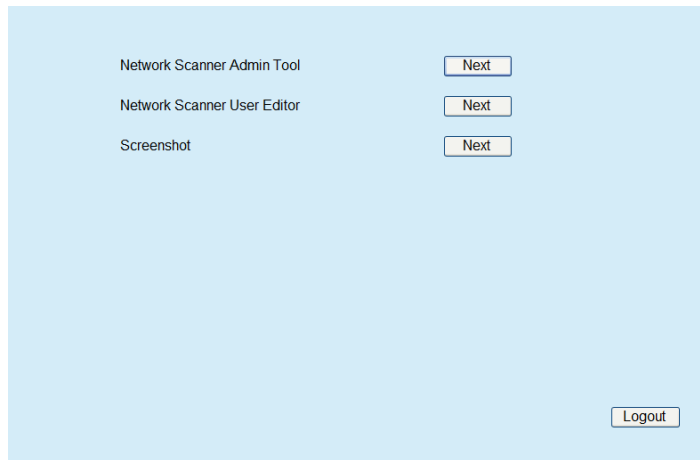

3.3 Installing the Admin Tool

To download and install the Admin Tool on a computer, follow the procedure below.

1. **Access the scanner from Internet Explorer by using the scanner name in a URL to show the download window.**

For details about how to display the download window, refer to ["3.2 Showing the Software Download Window" \(page 60\)](#).

2. **Press the [Next] button for [Network Scanner Admin Tool].**

⇒ The Admin Tool download window appears.

3. **Press the [Download] button.**

ATTENTION

- Downloading is not possible while a scanner operation is in process.
- Do not close Internet Explorer or log out until the installation is complete.
- Installation fails if the length of any installation path (folder path plus installation file name) exceeds 259 characters. Select an installation folder that respects this limit.

HINT

If .NET Framework is not installed, access the Microsoft Web site before installing Admin Tool.

After installing .NET Framework, try again from [Step 1](#).

⇒ From here on after, follow the instructions on the window to proceed the operation.

When "Network Scanner Admin Tool has been successfully installed" is displayed, the installation is complete. Press the [Close] button.

⇒ After the installation is complete, log out from the scanner by pressing the [Logout] button on the download window and close Internet Explorer.

⇒ After installation, Admin Tool can be started.

For details about how to start Admin Tool, refer to ["4.2.2 Administrator Login: via the Admin Tool" \(page 72\)](#).

ATTENTION

- From the [Tools] menu in Internet Explorer, select [Internet Options], and note the following points below about the settings shown in the [Internet Options] dialog box.
 - In the [Accessibility] dialog box shown when the [Accessibility] button is pressed on the [General] tab, do not change the formatting and user style sheet settings. If these settings are changed, the displayed style of the Admin Tool may be corrupted.
 - In the [Language Preference] dialog box shown when the [Languages] button is pressed on the [General] tab, move the same language as for the scanner to the top. If a different language is specified, a problem may occur with the input or displays for Admin Tool.
 - On the [Security] tab, if [Security level for this zone] is set to [High], part of the Admin Tool window may not be correctly displayed.
In this case, on the [Security] tab, add the scanner to the trusted site zone and press the [Default Level] button. Or press the [Custom Level] button and set [Binary and script behaviors] to [Enable].
- When the font size is large, part of the dialog box may not be shown correctly. In this case, use a smaller font size.

3.4 Uninstalling the Admin Tool

To uninstall Admin Tool, select [Control Panel] → [Programs] → [Programs and Features] on the computer where it is installed.

ATTENTION

Close Admin Tool before uninstalling.

If Admin Tool is uninstalled while still open, normal operation of the running Admin Tool is not guaranteed.

3.5 Installing the Central Admin Console and Central Admin Server

The Central Admin Console and Central Admin Server are necessary in order to enable management under central administration.

To install the Central Admin Console and Central Admin Server, go to the web page below and download the software.

<http://www.fujitsu.com/global/support/computing/peripheral/scanners/drivers/sca.html>

For details about the installation method, refer to the Scanner Central Admin User's Guide.

ATTENTION

To enable management with the Central Admin Console, the scanner and the Central Admin Server need to be connected by specifying settings in the following administrator windows.

- [Admin Connection] window
For details, refer to "[4.9.1 Setting the Admin Connection](#)" (page 110).
- [Scanner Central Admin Server] window
For details, refer to "[4.9.2 Setting a Central Admin Server](#)" (page 111).

Chapter 4

Administrator Operations (Touch Panel and Admin Tool)

Admin

This chapter provides an explanation of administrator operations (setting up and managing the scanner) via the scanner's touch panel, or via the network interface using the Admin Tool.

| | |
|---|------------|
| 4.1 Windows | 67 |
| 4.2 Administrator Login..... | 70 |
| 4.3 Setting the System Settings..... | 75 |
| 4.4 Configuring the System..... | 78 |
| 4.5 Setting the Scan Options | 86 |
| 4.6 Configuring the Login-Related Settings | 90 |
| 4.7 Configuring the Network Settings | 99 |
| 4.8 Checking the Network Status | 108 |
| 4.9 Configuring the Network Admin Settings..... | 110 |
| 4.10 Setting the Authentication Server | 114 |
| 4.11 Configuring the e-Mail-Related Settings..... | 125 |
| 4.12 Setting the Fax Server | 129 |
| 4.13 Setting Folders for Saving Scanned Data..... | 130 |
| 4.14 Setting the Network Printers..... | 146 |
| 4.15 Viewing the Scanner Details | 159 |
| 4.16 Managing the User Data Store and System Settings..... | 166 |
| 4.17 Maintaining the System..... | 174 |
| 4.18 Setting a Job Sequence..... | 187 |
| 4.19 Messages | 213 |

4.1 Windows

4.1.1 Administrator Windows via the Touch Panel

Selecting a menu displays the setting window for the menu in the right side of the window. Scrolling the area in the left side of the window displays all the menus.

Menu

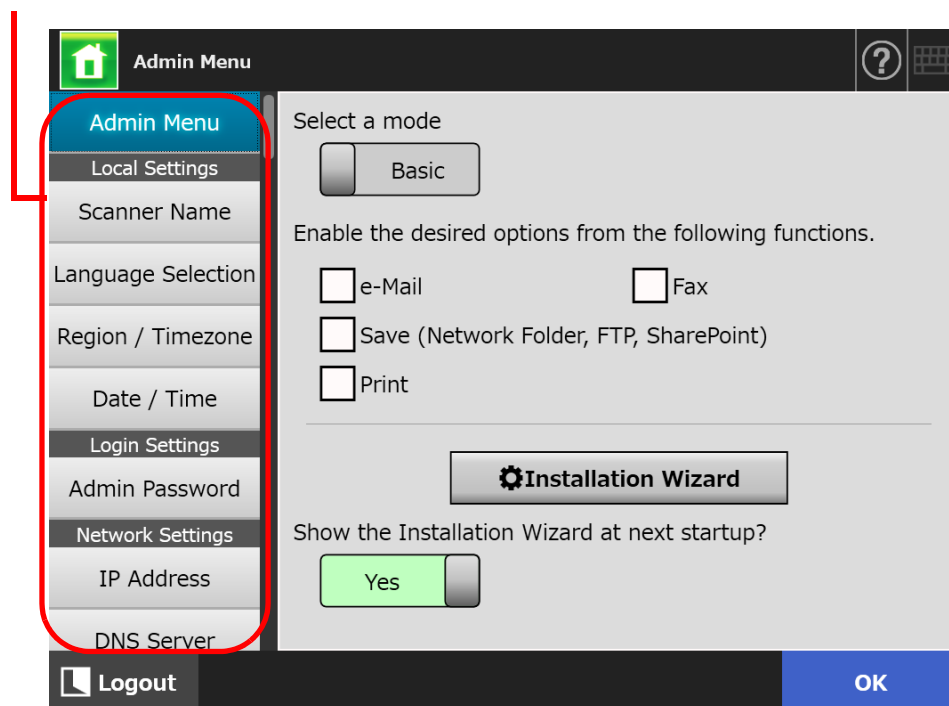

4.1.2 Administrator Windows via the Admin Tool

Administrator windows via the Admin Tool are as follows.

- When the [Scanner Settings] button is pressed
Press the [Scanner Settings] button on the Tool Menu, then select the menu to show the setting window for the menu in the right side of the window.
Scrolling the area in the left side of the window displays all the menus.

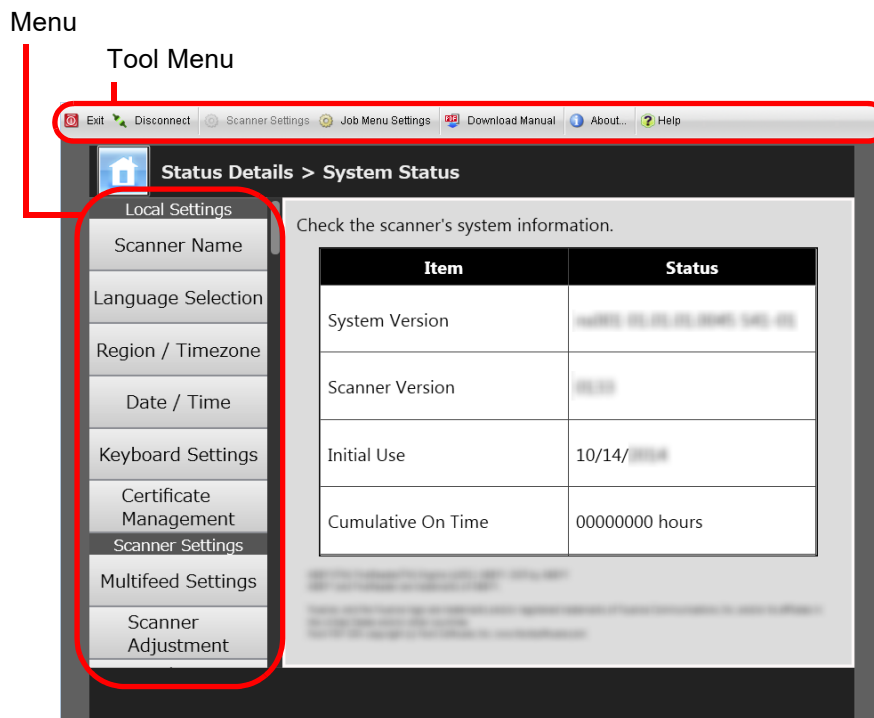

- When the [Job Menu Settings] button is pressed
Pressing the [Job Menu Settings] button on the Tool Menu shows the window for setting jobs.

Job Settings Menu

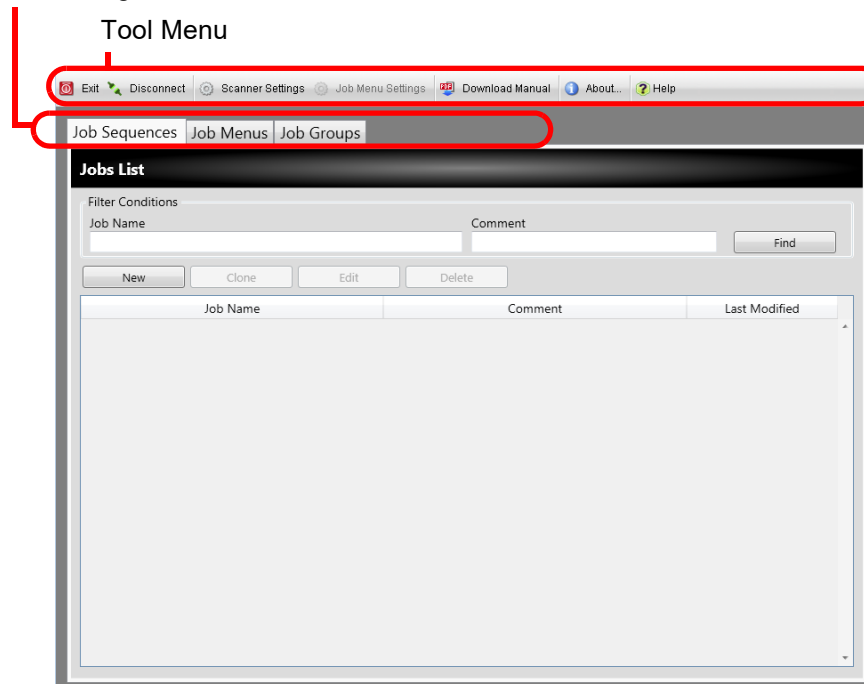

4.2 Administrator Login

HINT

- The default user name and password for the administrator are set as follows:
User name: admin
Password: password
- The scanner setup can be configured by one user.

4.2.1 Administrator Login: via the Touch Panel Touch Panel

■ When Automatic Login is Not Set

1. Enter the user name and password of the administrator.

The screenshot shows a touch panel interface for administrator login. At the top, there is a 'Login' header with a question mark icon. Below the header are two input fields: 'User Name' and 'Password'. At the bottom of the screen, there is a 'Shutdown' button with a power icon and a 'Login' button with a lock icon. A virtual keyboard is displayed below the input fields, showing keys for letters, numbers, and navigation.

HINT

If [Active Directory Global Catalog] is selected for the login LDAP server, the [UPN Suffix] input field is displayed.

A UPN suffix is not required when logging in as an administrator. Even if entered, it is ignored.

2. Press the [Login] button.

⇒ When authenticated, the administrator window is shown.

■ When Automatic Login is Set

When automatic login has been set, login to the administrator windows from the regular user window.

1. From the [Maintenance] window, press the [Administrator Login] button.

⇒ The [Administrator Login] window appears.

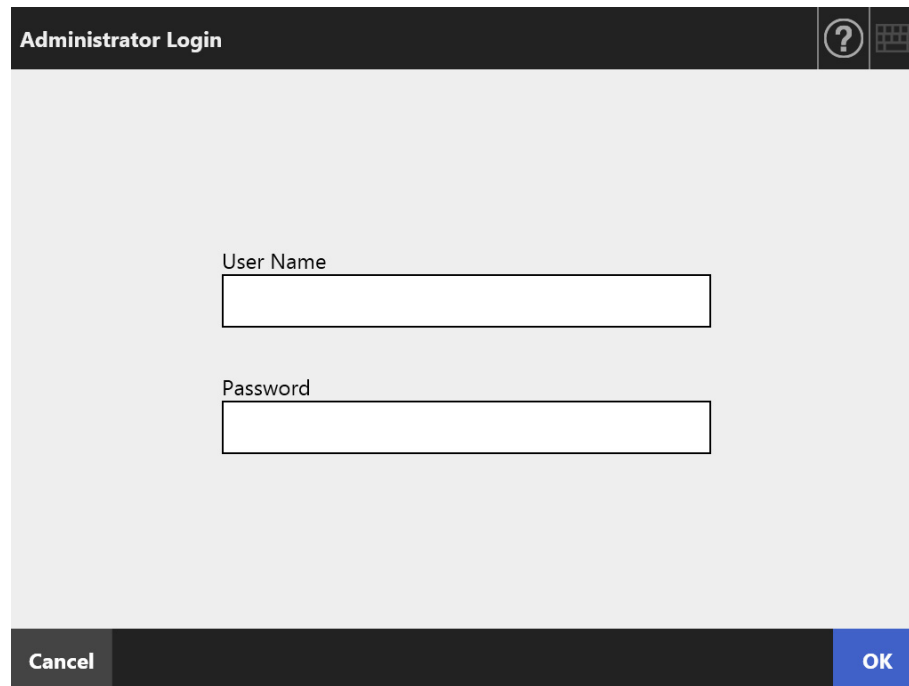

The image shows a dialog box titled "Administrator Login". The title bar is black with the text "Administrator Login" in white. On the right side of the title bar, there is a question mark icon and a keyboard icon. The main area of the dialog box is light gray and contains two text input fields. The first field is labeled "User Name" and the second is labeled "Password". At the bottom of the dialog box, there is a black bar with two buttons: "Cancel" on the left and "OK" on the right. The "OK" button is highlighted in blue.

2. Enter the user name and password of the administrator.

3. Press the [OK] button.

⇒ When authenticated, the administrator window is shown.

4.2.2 Administrator Login: via the Admin Tool

Using the Admin Tool allows the administrator to set up the scanner from a computer via the network interface.

This section explains how to login using the Admin Tool.

When an administrator or user is already logged into a scanner, login via the Admin Tool is not possible.

However, if automatic login is set, login via the Admin Tool is possible while the main menu or job menu is displayed.

ATTENTION

- If the normal screen display does not appear (for example: an "X" mark appears), wait for a few minutes and try again. If the problem still occurs, contact your FUJITSU scanner dealer or an authorized FUJITSU scanner service provider.
- If a button is rapidly pressed many times in succession, a "Communication error" message may appear. In this case, wait for a few minutes and try again.

HINT

- For details about the system requirements to manage the scanner via a computer, refer to ["1.5.1 Requirements for Admin Tool and User Editor" \(page 40\)](#).
- If you do not perform any of the following operations for 20 minutes or more while the Admin Tool is being used, the session times out.
 - Button or tab operations on the menu
 - Button operations on each setting window (except selecting items or inputting values)Also, when [Secure initialize] is performed on the [System Settings File] window, the session does not time out until the process is complete, because the [Secure initialize] process takes longer than 20 minutes.
- The following are required for administrator login via the Admin Tool:
 - ["4.4.1 Setting the Scanner Name" \(page 78\)](#)
 - ["4.6.4 Changing the Admin Password" \(page 97\)](#)
 - ["4.7.1 Giving the Scanner an IP Address/DHCP" \(page 99\)](#)
 - ["4.7.2 Setting the DNS Server" \(page 101\)](#)
 - ["4.7.3 Setting the WINS Server" \(page 102\)](#)
 - ["4.9.1 Setting the Admin Connection" \(page 110\)](#)

1. Start the Admin Tool.

- Windows Server 2012
Right-click the Start screen, and select [All apps] on the app bar → [Network Scanner Admin Tool] under [Network Scanner].
- Windows 8.1/Windows Server 2012 R2
Select [↓] on the lower left of the Start screen, and click [Network Scanner Admin Tool] under [Network Scanner].
To display [↓], move the mouse cursor.
- Windows 10/Windows Server 2016/Windows Server 2019
Select [Start] menu → [Network Scanner] → [Network Scanner Admin Tool].
⇒ The Admin Tool is started.

2. Specify the [Connect to] (of the scanner).

Enter the IP address, scanner name, or FQDN for the scanner to be setup or managed.

ATTENTION

- If the port number was changed in "[4.9.1 Setting the Admin Connection](#)" (page 110), enter the changed port number in [Port Number].
- When trying to connect with a port number other than the specified number, it takes up to 20 seconds before a connection error occurs.
- To use SSL, select the [Use HTTPS] check box.
- If the Admin Tool is started while there is insufficient free memory, an error may occur. Try again after ensuring that there is enough free memory.

3. Press the [Connect] button.

⇒ The login window appears.

4. Enter a [User Name] and [Password].

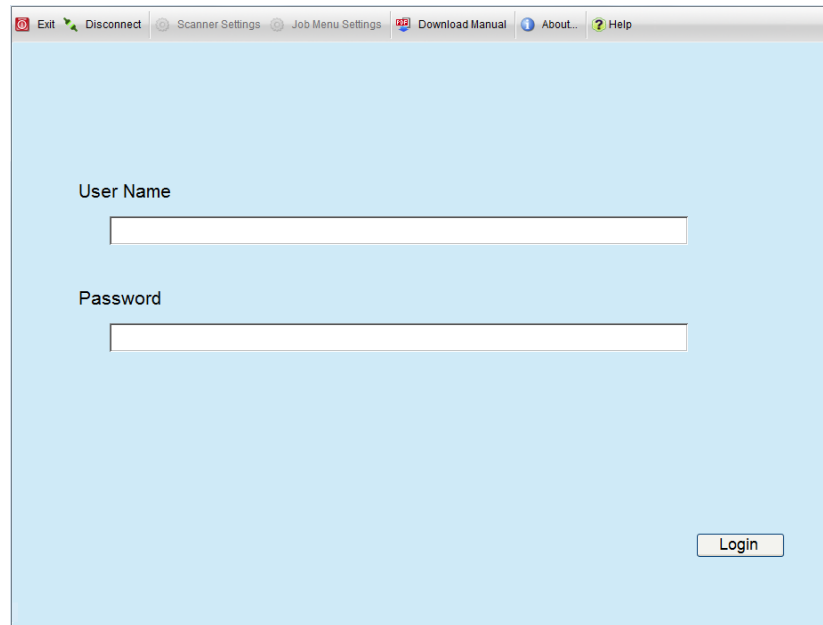

The image shows a software window titled "Administrator Login". The window has a light blue background and a menu bar at the top with the following items: Exit, Disconnect, Scanner Settings, Job Menu Settings, Download Manual, About..., and Help. Below the menu bar, there are two text input fields. The first is labeled "User Name" and the second is labeled "Password". Both fields are empty. In the bottom right corner of the window, there is a button labeled "Login".

5. Press the [Login] button.

⇒ When authenticated, the administrator window is shown.



4.3 Setting the System Settings

4.3.1 Configuring the Setting Mode Touch Panel



Set the setting mode used for configuring or managing system settings.

For details about the setting modes, refer to "[1.1 Scanner Features](#)" (page 22).

For details about the operations available in each setting mode, refer to "[1.3.1 Operations with Administrator Right](#)" (page 30).

1. On the administrator window, select [Admin Menu], or press  or .

HINT

Press  when [Basic] is selected for the setting mode. Press  when [Advanced] is selected.

⇒ The [Admin Menu] window appears.

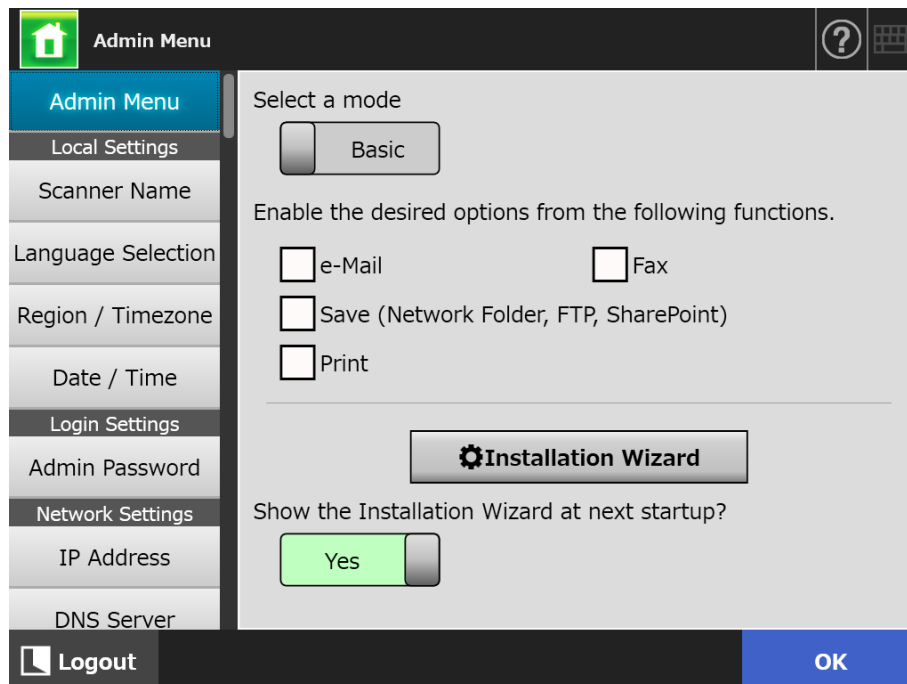

2. Select a setting mode.
3. Select the check boxes for functions that you want to make configurable.

4. Press the [OK] button.

⇒ The setting mode is set.

HINT

When you use the FAX function, enable the e-Mail function as well.

4.3.2 Setting the System Settings with the Installation Wizard Touch Panel



Using the Installation Wizard allows you to configure the minimum scanner settings required to operate the scanner.

The following items can be set.

- Scanner Name
- Region/Timezone
- Date/Time
- Login Settings
- Admin Password
- IP Address
- DNS Server
- Scanner Central Admin Server

1. On the administrator window, select [Admin Menu], or press  or

**HINT**

Press  when [Basic] is selected for the setting mode. Press  when [Advanced] is selected.

⇒ The [Admin Menu] window appears.

2. Press the [Installation Wizard] button.

⇒ The [Installation Wizard] window appears.

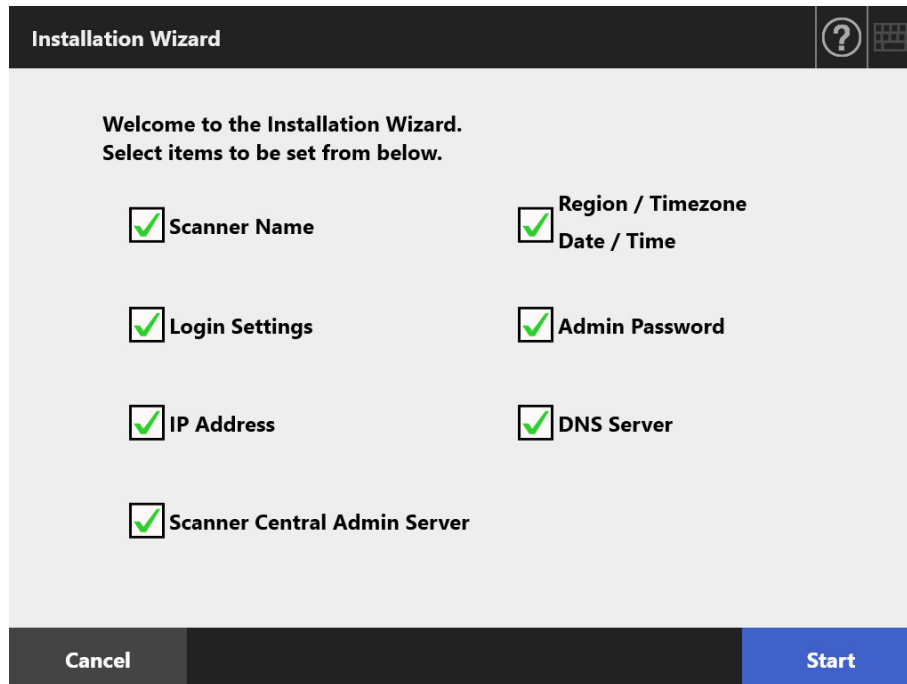

3. Select the check boxes for items you want to configure with the Installation Wizard.

HINT

When the [Region / Timezone Date / Time] check box is selected, the window for setting the region/timezone and the window for setting the date/time will be displayed.

4. Press the [Start] button.

⇒ Windows for configuring the selected items appear sequentially in the Installation Wizard.

5. Follow the wizard to configure the settings.

For details about the procedure for configuring system settings, refer to the "Getting Started".

6. Press the [Finish] button.

⇒ The window for confirming the settings of the Installation Wizard appears.

7. Confirm the settings and press the [OK] button.

⇒ The Installation Wizard closes and the [Admin Menu] window appears.

HINT

For [Show the Installation Wizard at next start up?], you can set whether or not to show the Installation Wizard immediately after starting the scanner.

4.4 Configuring the System

4.4.1 Setting the Scanner Name Touch Panel AdminTool

Set a scanner name to provide a network alias for the scanner.

ATTENTION
Do not use a name already being used in the network. Name duplication will cause a network connection error. In this case, try the following steps:

1. Disconnect the LAN cable.
2. Press the [Shutdown] button on the touch panel to turn the scanner off.
3. Press the power button to start the scanner with the LAN cable disconnected.
4. Enter a non-duplicated scanner name.
5. Reboot the scanner.
6. Re-connect the LAN cable to the scanner.

1. Select [Scanner Name] under [Local Settings].

⇒ The [Scanner Name] window appears.

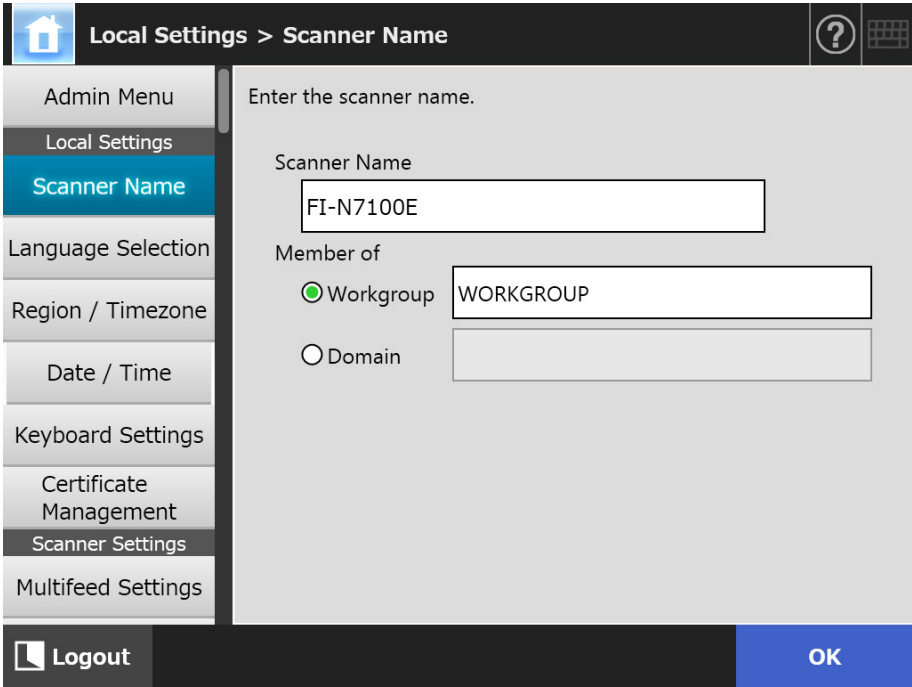

2. Specify each item.

3. Press the [OK] button.

⇒ The restart confirmation window appears.

HINT

In the following cases, the authentication window appears.

- When specifying the scanner as a domain member
- When changing the name of a scanner that is a member of a domain

Check the authentication information required for specifying the scanner as a domain member with the network administrator, and enter the valid user name and password. User names may be up to 256 characters long.

Passwords may be up to 256 characters long. [User Name] and [Password] are case sensitive.

If the user name and password are valid, the restart confirmation window appears.

4. Press the [Now] button.

⇒ The scanner is restarted.

HINT

The connection with the scanner is lost if the scanner name is changed via the Admin Tool. To continue with other settings, wait a short time for the scanner to restart, then access the scanner via the Admin Tool again.

4.4.2 Setting the Language Touch Panel AdminTool

1. Select [Language Selection] under [Local Settings].

⇒ The [Language Selection] window appears.

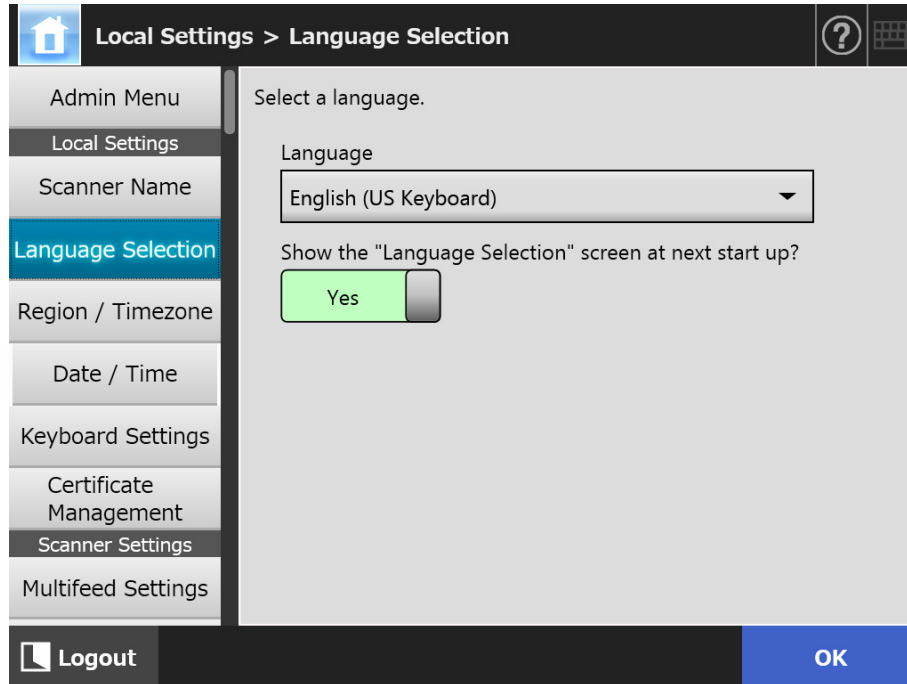

HINT

You can select whether or not to display this window again at the next scanner startup. To display the window again, for "Show the "Language Selection" screen at next start up?", select [Yes]. To not display this window at next start up, select [No].

2. Specify each item.

3. Press the [OK] button.

⇒ The information entered is set.

4.4.3 Setting the Region/Timezone Touch Panel AdminTool Central Admin Console

1. Select [Region / Timezone] under [Local Settings].

⇒ The [Region / Timezone] window appears.

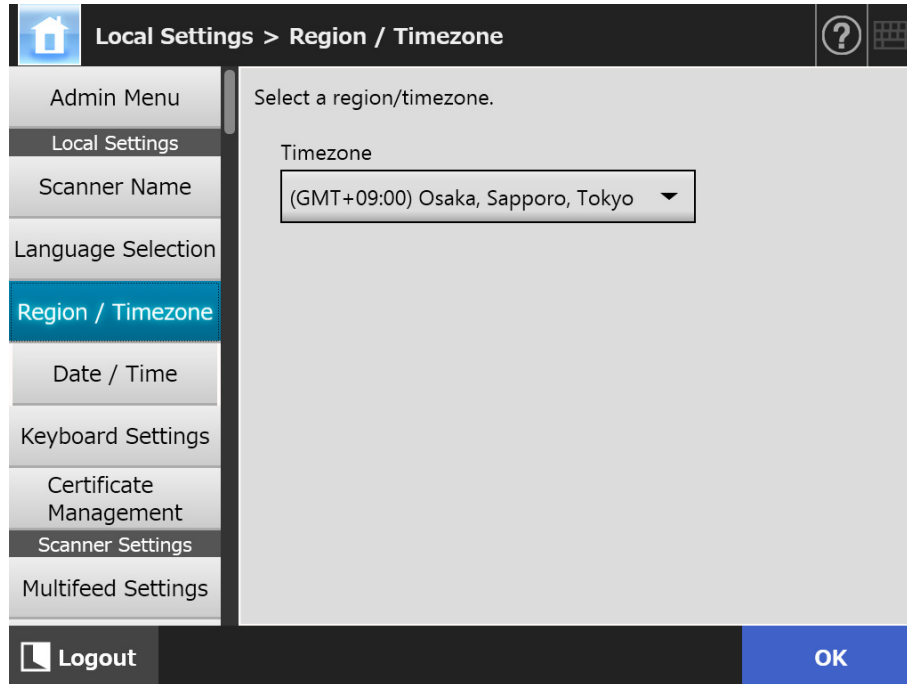

2. Specify each item.

3. Press the [OK] button.

⇒ The information entered is set.

HINT

If daylight savings time is on, daylight savings time and standard time switch automatically.

4.4.4 Setting the Date/Time Touch Panel AdminTool Central Admin Console

1. Select [Date / Time] under [Local Settings].

⇒ The [Date / Time] window appears.

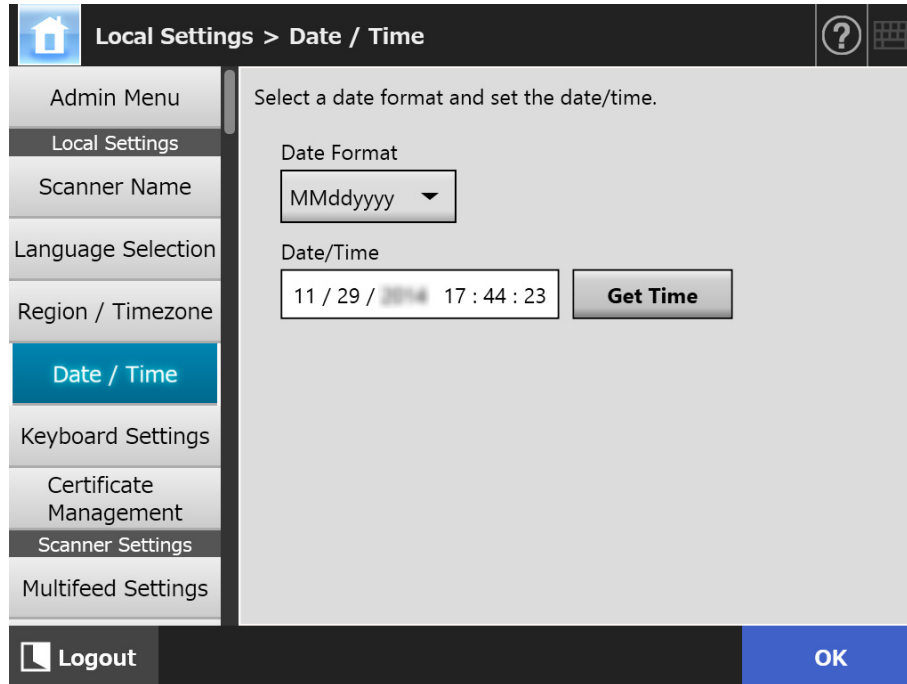

2. Specify each item.

3. Press the [OK] button.

⇒ The information entered is set.

4.4.5 Setting the Keyboard Touch Panel Admin Tool Central Admin Console

1. Select [Keyboard Settings] under [Local Settings].

⇒ The [Keyboard Settings] window appears.

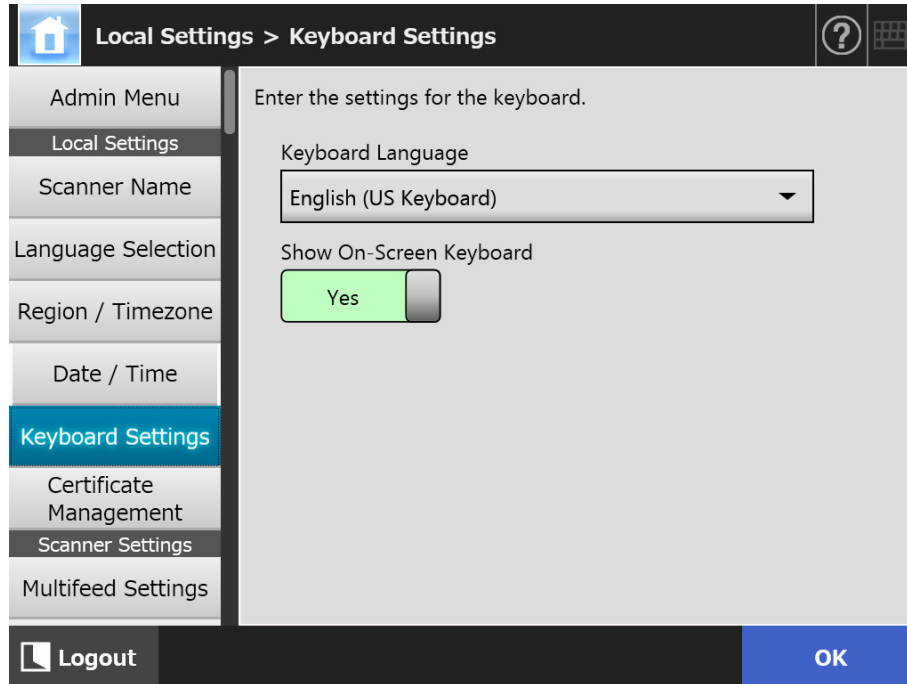

2. Specify each item.

3. Press the [OK] button.

⇒ The information entered is set.

ATTENTION

If [No] is set for the on-screen keyboard display, you need to connect a hardware keyboard additionally to enter characters.

4.4.6 Managing Certificates

Certificates to be used for server authentication in SSL communication can be imported or deleted.

■ Importing a Certificate File Admin Tool Central Admin Console

X.509 certificate files (*.cer, *.crt) can be imported.
Up to 100 certificate files can be imported.

1. Select [Certificate Management] under [Local Settings].

⇒ The [Certificate Management] window appears.

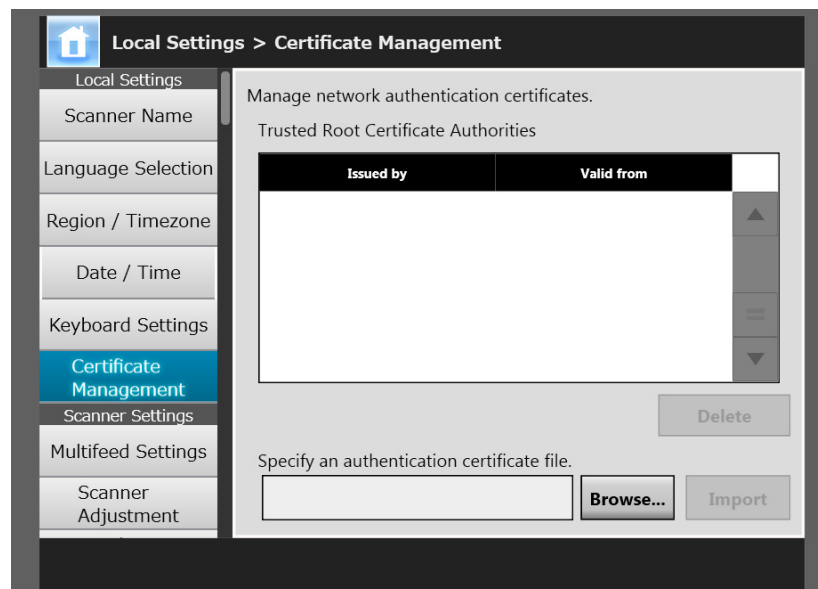

(Example of the Administrator Windows via the Admin Tool)

2. Press the [Browse] button and specify a certificate file.

3. Press the [Import] button.

⇒ The certificate file is imported.

The imported file is saved in the Trusted Root Certificate Authority store.

ATTENTION

When a certificate file is distributed from the Central Admin Server, any previously imported certificates will be deleted, and replaced by the contents of the new file.

■ Deleting a Certificate File   

- 1. Select [Certificate Management] under [Local Settings].**
 - ⇒ The [Certificate Management] window appears.
- 2. Select a certificate file to be deleted, and press the [Delete] button.**
 - ⇒ The delete confirmation window appears.
- 3. Press the [Yes] button.**
 - ⇒ The certificate file is deleted.

4.5 Setting the Scan Options

4.5.1 Setting the Multifeed Detection Method Touch Panel Admin Tool Central Admin Console

"Multifeed" is an error that occurs when two or more sheets are fed simultaneously into the ADF. The detection of the difference in length is also regarded as multifeed.

By default, multifeed detection monitors for paper overlaps in the central column (25 mm either side from the center of the document) of the document being scanned.

- Setting the multifeed detection zone

If stickies, slips, photos, or other paper ("attached paper" from here on) are attached on the documents, this section is considered to be an overlap causing unnecessary detection as multifeed. When scanning those documents, you can adjust the multifeed detection area to ignore a specific area with attachments such as photos and prevent mis-detections.

- Setting the intelligent multifeed detection

The "intelligent multifeed detection" allows the length and position of the attached paper to be memorized in the scanner so that the multifeed will not be detected from the next scan.

- Setting the function for scanning at a high altitude

Low atmospheric pressure at a high altitude may decrease the level of accuracy of the ultrasonic sensor to detect multifeeds.

The "high altitude mode" allows the scanner to be used at a high altitude of 2,000 m or more.

For document requirements for multifeed detection, refer to ["A.5 Multifeed Detection Conditions"](#) (page 399).

1. Select [Multifeed Settings] under [Scanner Settings].

⇒ The [Multifeed Settings] window appears.

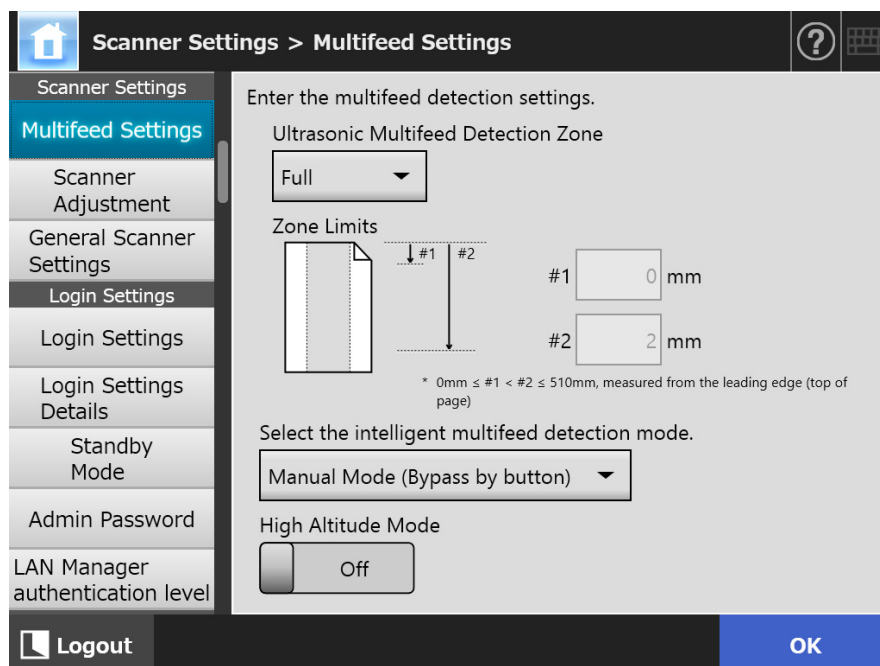

2. Specify each item.

If [Middle] or [Top & Bottom] is selected, enter both "#1" (upper limit) and "#2" (lower limit).

- Middle

Multifeeds will be detected in the shaded (a) area between "#1" (upper limit) and "#2" (lower limit).

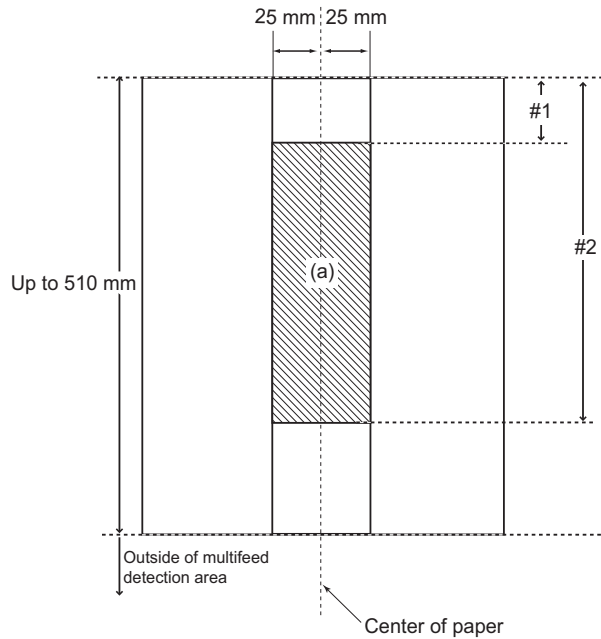

- Top & Bottom

Multifeeds will be detected from the top of the page to "#1" (upper limit), and from "#2" (lower limit) to the bottom of the page. (b)

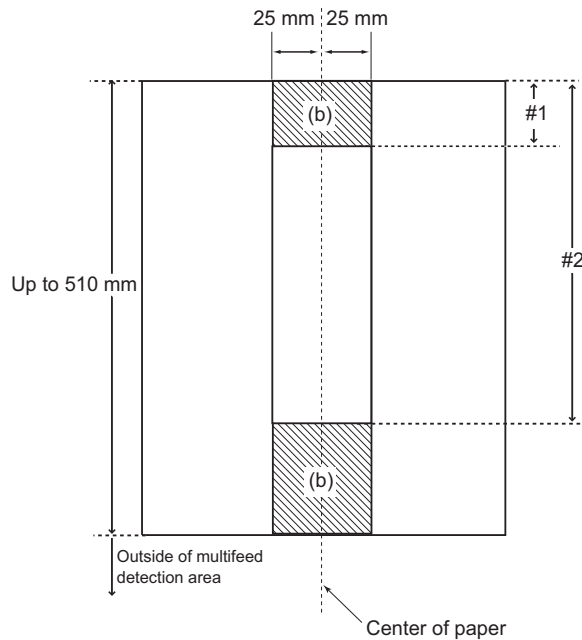

3. Press the [OK] button.

⇒ The information entered is set.

4.5.2 Adjusting the Scan Starting Position (Offset/

Magnification) Touch Panel AdminTool

Usually, it is not necessary to make any setting changes.

Configure the following setting items.

- Offset settings
When the scanned output is found to be displaced relative to the actual documents being scanned, the scan offsets can be adjusted.
- Length magnification setting
If the scanned output is found to be vertically distorted (stretched or squashed) relative to the actual documents being scanned, the length magnification in the vertical scanning direction can be adjusted.

1. Select [Scanner Adjustment] under [Scanner Settings].

⇒ The [Scanner Adjustment] window appears.

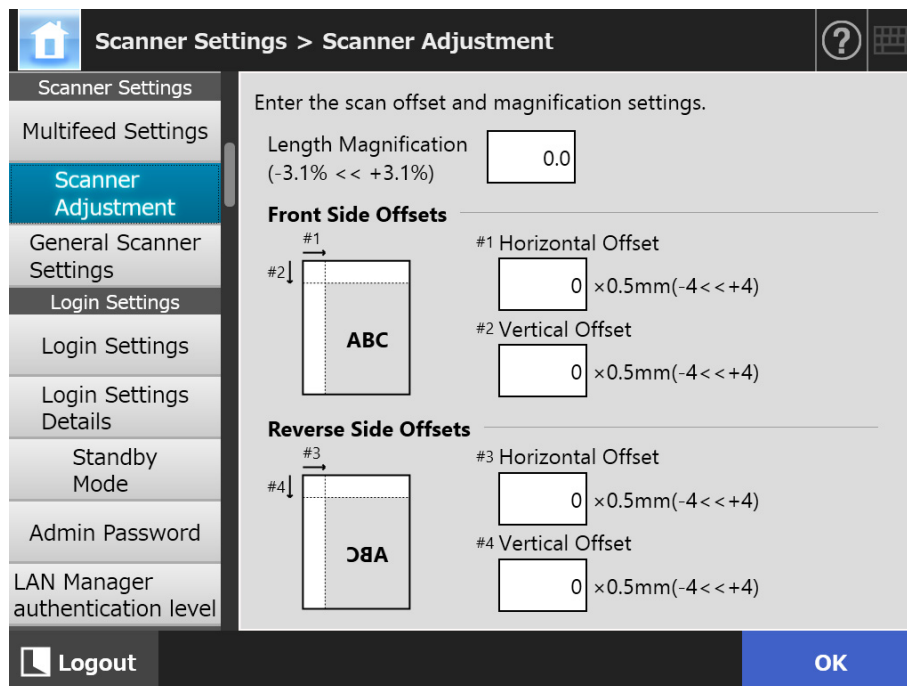

2. Specify each item.

3. Press the [OK] button.

⇒ The information entered is set.

4.5.3 Setting General Scanner Settings Touch Panel AdminTool Central Admin Console

Usually, it is not necessary to make any setting changes.
Configure the general scanner settings for scanning.

1. Select [General Scanner Settings] under [Scanner Settings].

⇒ The [General Scanner Settings] window appears.

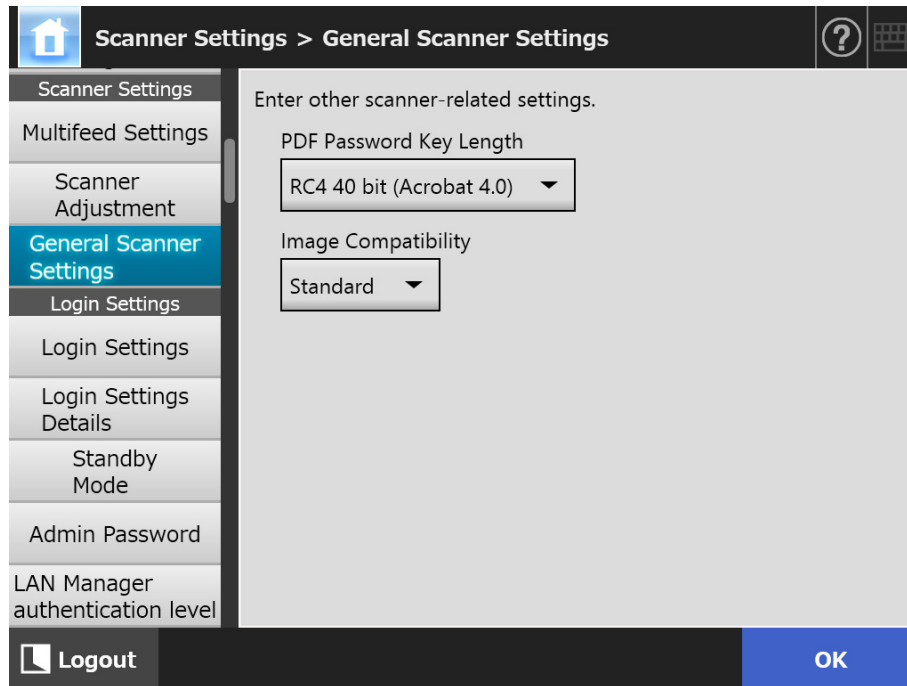

2. Specify each item.

3. Press the [OK] button.

⇒ The information entered is set.

4.6 Configuring the Login-Related Settings

4.6.1 Setting the Login Settings Touch Panel AdminTool Central Admin Console

Set the login settings.

- **Authentication mode setting**
Specify whether to use an LDAP server account or a local account saved on the scanner during the authentication process at login. If both accounts are used, you can set the search order for the authentication information.

HINT

If LDAP is included in the authentication mode, add an account in the LDAP server.
If local account is included in the authentication mode, add an account in User Editor.

- **Automatic login settings**
When the scanner is turned on or restarted, the system performs an automatic login without displaying the [Login] window.
For automatic login, the user name and password specified in the [Login Settings] window is used.
- **Guest account validity**
Set whether or not to enable login with the guest account.

1. Select [Login Settings] under [Login Settings].

⇒ The [Login Settings] window appears.

2. For [Authentication Mode], select an authentication mode.

HINT

When an alias is used for the administrator account, if a local account or LDAP user is set with the same alias account name, login will be processed for the administrator account. In this case, even if a password error occurs, login as a local account or LDAP user cannot be performed.

The priority of the authentication destinations for the login is as follows:

1. Alias account
2. Order specified by [Authentication Mode]

3. For [Auto Login], select whether or not to enable automatic login.

ATTENTION

- The automatic login setting is applied immediately after an administrator logout. To change the settings while the [Auto Login] is [ON], perform administrator login from the [Maintenance] window or perform the login via the Admin Tool.
- If Central Admin is enabled in a scanner for which automatic login is enabled, when the scanner is started or resumed from standby mode, preference is given to checking for available scanner settings, add-in installs and system settings in the Central Admin Server, over automatic login.

When scanner settings, Add-ins or system settings are available, they are installed in the scanner. If the number of scanners connecting to the Central Admin Server exceeds the maximum acceptable number, the installation is skipped, and automatic login is performed.

Updates will be applied to the scanner when a logout is performed from the [Administrator Login] window, when the scanner starts next time, or when the scanner resumes from standby mode.

4. When [Auto Login] is set to [On], enter a [User Name] and [Password].

The scanner follows the Active Directory user name format when authenticating the user login.

- For users registered in the LDAP server
 - When the [Server Type] of the LDAP server is [Active Directory] or [Active Directory Global Catalog]

| User Name Format | Authentication Process |
|--|--|
| SAM Account Name Does not contain @ | Authenticate the user login name (sAMAccountName). Example: user |
| User Principal Name Contains @ | Authenticate the user login name (userPrincipalName). Example: user@example.com |

HINT

When specifying a SAM account name with a domain name, describe "domain_name\SAM_account_name".

- When the [Server Type] of the LDAP server is [Other LDAP Server]

| User Name Format | Authentication Process |
|------------------|--|
| uid | Authenticate the user login name (uid). Example: user |
| cn | Authenticate the user login name (cn). Example: user |

- For users registered in a local account
Authenticate the specified user login name for a local account saved in the scanner.

HINT

If a UPN suffix is entered for a user name for automatic login, it is ignored. Even if entered, it is not used.

5. For [Guest Account], select whether or not logging in with the guest account is possible.
6. Press the [OK] button.
⇒ The information entered is set.

4.6.2 Setting the Login Settings (Details) Touch Panel AdminTool Central Admin Console

Set whether to use the factory default administrator account (admin) or a different account as the administrator account.

In addition, set whether to wait until the process of sending a scanned image is complete before the previously displayed menu appears, specify the number of retries and the interval between retries, and set whether to display the [Resend] button.

1. Select [Login Settings Details] under [Login Settings].

⇒ The [Login Settings Details] window appears.

2. Set [Admin Account] and [Admin User Name].

HINT

The password for [Alias] can be changed on the [Admin Password] window.

3. Set [Wait Job].

If you select [No], specify [Number of retries], [Retry interval], and [Show [Resend]].

ATTENTION

- If you select [No], when the process of sending is not complete, you cannot log out or turn the power off.
- If you select [Yes] for [Show [Resend]], when the send process remains in an error state, you cannot log out or turn the power off.

HINT

- If you select [Yes], the window indicating that the process is in progress appears until the process of sending a scanned image is complete. In this case, you can scan the next document as well as perform any other operations in the window after the process of sending is complete.
- If you select [No], you can scan the next document as well as perform any other operations in the window before the process of sending completes. The process of sending is temporarily saved and each process is performed in sequence.
- You can check the status of the send process in the [In progress] tab on the [Send Status] window, which is shown by pressing the [Send Status] button in the [Main Menu] window or the [Job Menu] window.
- If you select [Yes] for [Show [Resend]], the [Resend] button is displayed in the [In progress] tab on the [Send Status] window. Pressing the [Resend] button enables you to restart the send process that remains in an error state. For details, refer to "[5.11.2 Viewing Details on Send Operations That Are In Progress](#)" (page 320).

4. Press the [OK] button.

⇒ The information entered is set.

4.6.3 Setting the Standby Mode Touch Panel AdminTool Central Admin Console

You can set the transition time for automatic logout, the standby mode, and power-off.

- For any window that is opened after you logged in, if no operations are performed for the specified period of time for [Logout after], the scanner automatically logs you out.

HINT

- The scanner does not logout while the following operations are ongoing:
 - Scanning documents
 - e-Mailing a scan
 - Faxing a scan
 - Printing a scan
 - Saving a scan
 - Automatic login is enabled
- When automatic login is enabled, the main menu window appears (the job menu window appears if the job menu is selected for the initial post-login menu in the job groups tab) when the logout wait time has been exceeded.
- The time that is selected in [Logout after] never becomes invalid whether you enable the automatic login or not.

- [Standby Mode] is a function that automatically switches the scanner to standby mode if no operations are performed for a specified period of time on the [Login] window or any other window that is opened after you logged in.

By using the [Turn off the display only] setting, standby mode can be changed.

When the power button is pressed, the scanners start up from standby mode.

The window displayed after restarting varies according to the automatic login settings in the following way:

- If automatic login is enabled, the operation window is displayed.
- If automatic login is disabled, the [Login] window is displayed.

For details about window transitions, refer to ["Using the Power Button" \(page 51\)](#).

When setting the time for [Standby after], the time until the scanner logs the user out must also be included.

- If no operations are performed for the specified period of time for [Power-off after] when the scanner power is left on, the scanner power is automatically turned off. The scanner enters standby mode first. If no further operations are performed in standby mode, the scanner power is automatically turned off. When setting the time for [Power-off after], the time until the scanner enters standby mode must also be included.

1. Select [Standby Mode] under [Login Settings].

⇒ The [Standby Mode] window appears.

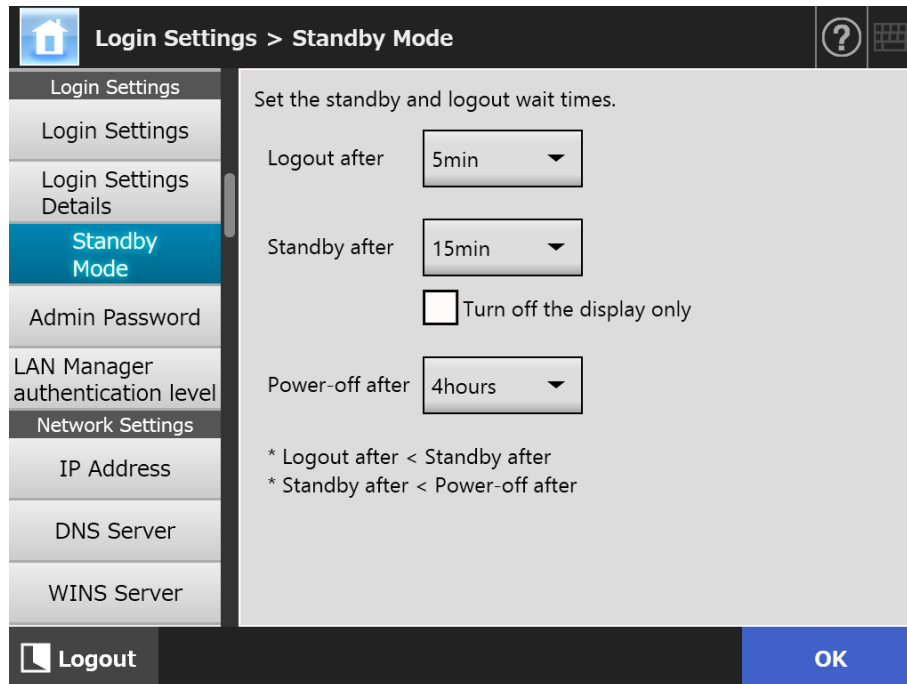
**2. Specify each item.****3. Press the [OK] button.**

⇒ The information entered is set.

4.6.4 Changing the Admin Password Touch Panel AdminTool

ATTENTION

If a password is lost or forgotten, login is not possible.

Manage passwords carefully.

If the password has been lost or forgotten, the same action that is taken when repairing the scanner is needed. Therefore, contact your FUJITSU scanner dealer or an authorized FUJITSU scanner service provider.

1. Select [Admin Password] under [Login Settings].

⇒ The [Admin Password] window appears.

The screenshot shows the 'Admin Password' window in the AdminTool interface. The window title is 'Login Settings > Admin Password'. On the left, there is a navigation menu with the following items: 'Login Settings', 'Login Settings Details', 'Standby Mode', 'Admin Password' (highlighted in blue), 'LAN Manager authentication level', 'Network Settings', 'IP Address', 'DNS Server', and 'WINS Server'. At the bottom left of the menu is a 'Logout' button. The main content area of the window is titled 'Change the administrator password.' and contains three input fields: 'Current Password', 'New Password', and 'Confirm New Password'. Below the input fields, there is a warning message: 'If the password is lost you will not be able to login. Keep a record of the new password in a safe location.' At the bottom right of the window is an 'OK' button.

2. Enter the current password and a new password.

3. Press the [OK] button.

⇒ The new admin password is set.

4.6.5 Setting the LAN Manager Authentication

Level Touch Panel AdminTool Central Admin Console

Set the LAN Manager authentication level for connecting the scanner to a server.

The LAN Manager authentication level setting is enabled in the following cases:

- The login LDAP server type is set to [Active Directory] or [Active Directory Global Catalog], and the scanner is connected to an Active Directory server for logging in to the scanner
- The scanner is connected to a file server for saving the scanned images in a network folder
- The scanner is connected to a print server for printing the scanned images

For details about the LAN Manager authentication level, refer to the manual of the related server.

ATTENTION

- Setting the LAN Manager authentication level according to the server side settings is recommended.
- Check the LAN Manager authentication level set on the server side with the server administrator before changing the level. If a level different from the level on the server side is set, logging in to the scanner, saving data in the network folder or printing data may be disabled.

1. Select [LAN Manager authentication level] under [Login Settings].

⇒ The [LAN Manager authentication level] window appears.

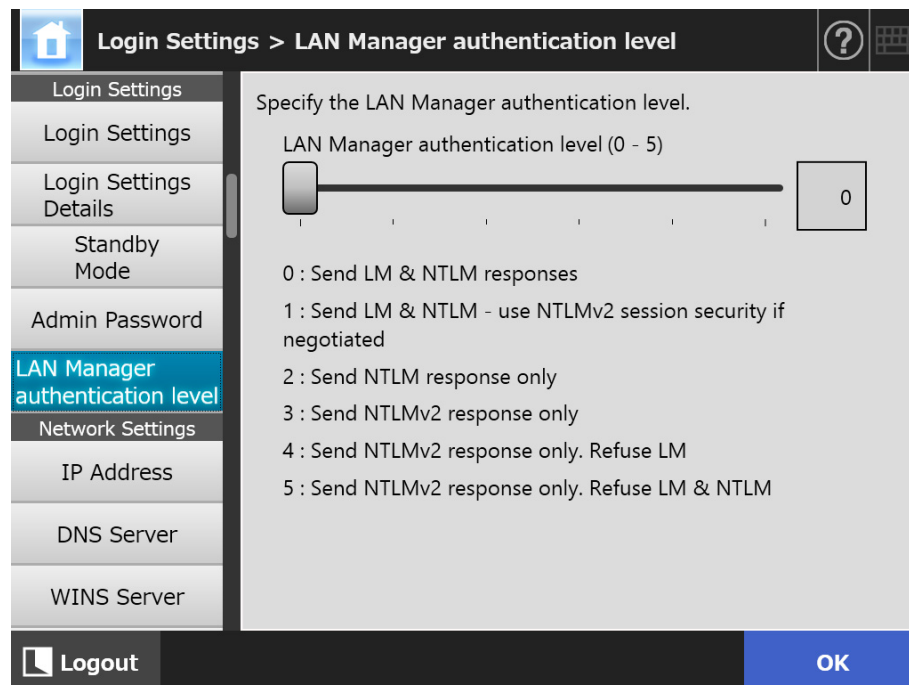

2. Set the LAN Manager authentication level.

3. Press the [OK] button.

⇒ The information entered is set.

4.7 Configuring the Network Settings

Configure the settings to connect the scanner to a network.

The procedure explained as an example in this section is the procedure for the IPv4 function.

Note that this scanner also supports the IPv6 function. By enabling the IPv6 function, you can configure an IPv6 environment for the scanner.

For details, refer to "[Appendix G IPv6 Settings](#)" (page 451).

4.7.1 Giving the Scanner an IP Address/DHCP Touch Panel AdminTool

An IP address/DHCP must be set in order to connect the scanner to a network.

1. Select [IP Address] under [Network Settings].

⇒ The [IP Address] window appears.

The screenshot displays the 'Network Settings > IP Address' configuration window. On the left is a vertical menu with the following items: IP Address (highlighted), DNS Server, WINS Server, NTP Server, Proxy Server, SNMP Settings, SMB 1.0/CIFS, Network Advanced Settings, Check Network Status, and Ping. The main content area is titled 'Enter IP addresses.' and includes a 'DHCP' dropdown menu currently set to 'On'. Below this are three input fields for 'IP Address', 'Subnet Mask', and 'Default Gateway', each containing three dots as placeholders. At the bottom of the window, there is a 'Logout' button on the left and an 'OK' button on the right.

2. Specify each item.

3. Press the [OK] button.

⇒ The information entered is set.

HINT

- If the IP address is the same as one already in use, network communication problems will occur. In this case, try the following steps:
 1. Disconnect the LAN cable.
 2. Press the [Shutdown] button on the touch panel to turn the scanner off.
 3. Press the power button to start the scanner with the LAN cable disconnected.
 4. Enter a non-duplicated IP address.
 5. Re-connect the LAN cable to the scanner.
- The connection with the scanner is lost if the IP address is changed via the Admin Tool. To continue with other settings, close the Admin Tool and then access the scanner via the Admin Tool again. If you access the scanner with an IP address, use the new IP address.

4.7.2 Setting the DNS Server Touch Panel AdminTool Central Admin Console

A primary DNS and secondary DNS can be set.

1. Select [DNS Server] under [Network Settings].

⇒ The [DNS Server] window appears.

The screenshot shows the 'DNS Server' configuration window. The title bar reads 'Network Settings > DNS Server'. On the left is a vertical menu with options: IP Address, DNS Server (highlighted), WINS Server, NTP Server, Proxy Server, SNMP Settings, SMB 1.0/CIFS, Network Advanced Settings, Check Network Status, and Ping. The main area is titled 'Enter the DNS server settings.' and contains the following fields:

- Primary DNS: 0 . 0 . 0 . 0
- Secondary DNS: 0 . 0 . 0 . 0
- DNS Dynamic Update: Off (toggle switch)
- DNS Suffix: [Empty text box]
- FQDN: [Pre-filled text box with 'FQDN']

At the bottom, there is a 'Logout' button on the left and an 'OK' button on the right.

2. Specify each item.

3. Press the [OK] button.

⇒ The information entered is set.

4.7.3 Setting the WINS Server Touch Panel AdminTool Central Admin Console

A primary WINS and secondary WINS can be set.

1. Select [WINS Server] under [Network Settings].

⇒ The [WINS Server] window appears.

The screenshot shows the 'WINS Server' configuration window. The title bar reads 'Network Settings > WINS Server'. On the left is a vertical menu with options: IP Address, DNS Server, WINS Server (highlighted in blue), NTP Server, Proxy Server, SNMP Settings, SMB 1.0/CIFS, Network Advanced Settings, Check Network Status, and Ping. The main area is titled 'Enter the WINS server settings.' and contains two input fields: 'Primary WINS' and 'Secondary WINS', both with the value '0 . 0 . 0 . 0'. At the bottom, there is a 'Logout' button on the left and an 'OK' button on the right.

2. Specify each item.

3. Press the [OK] button.

⇒ The information entered is set.

4.7.4 Setting the NTP Server Touch Panel Admin Tool Central Admin Console

Set the NTP server.

1. Select [NTP Server] under [Network Settings].

⇒ The [NTP Server] window appears.

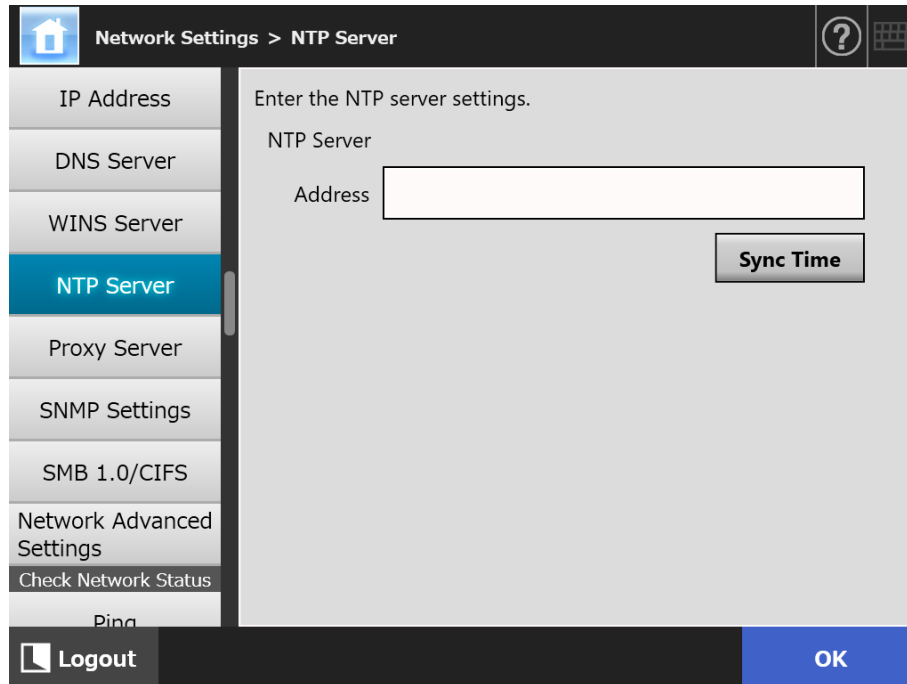

2. Enter the NTP server IP address, host name, or FQDN in the [Address] input field.

3. Press the [Sync Time] button.

⇒ The result of the time synchronization for the specified NTP server is shown.
Make sure that the time synchronization has been performed correctly.

4. Press the [OK] button on the confirmation window.

5. Press the [OK] button.

⇒ The information entered is set.

HINT

- The system time is automatically synchronized every 6 hours to the specified NTP server.
- After the setting is changed, the time synchronization is performed immediately.
- For the touch panel, if you do not perform any operations over the specified period set for the logout wait time, the scanner logs out. For the Admin Tool, if you do not perform any operations for 20 minutes or more, the session times out.

4.7.5 Setting the Proxy Server

Touch Panel

AdminTool

Central Admin Console

Set whether a proxy server is used when connecting to the FTP server or SharePoint server.

When a proxy server is used for update check, an HTTP proxy server should be set.

1. Select [Proxy Server] under [Network Settings].

⇒ The [Proxy Server] window appears.

The screenshot shows the 'Proxy Server' configuration window. The left sidebar contains a list of settings: IP Address, DNS Server, WINS Server, NTP Server, Proxy Server (highlighted), SNMP Settings, SMB 1.0/CIFS, Network Advanced Settings, Check Network Status, and Ping. The main area is titled 'Enter the proxy server settings.' and contains two sections: 'FTP Proxy Server' and 'HTTP Proxy Server'. Each section has a toggle switch set to 'Off', an 'Address' text box, and a 'Port Number' text box with '8080' entered. The FTP section has a note: '* Used by FTP Path Network Folders'. The HTTP section has a note: '* Use for update check.'. Below the HTTP section is an 'Exceptions' text box with a note: '*Do not use a proxy for addresses that start with:'. At the bottom right of the main area is a note: '*Use semi-colons (;) to separate entries'. The bottom of the window has a 'Logout' button on the left and an 'OK' button on the right.

2. Specify each item.

3. Press the [OK] button.

⇒ The information entered is set.

4.7.6 Configuring the SNMP Settings Touch Panel AdminTool Central Admin Console

Set whether or not to obtain the MIB information or enable the trap notification.
For details about configuring the SNMP settings, refer to ["SNMP Settings" \(page 423\)](#).

1. Select [SNMP Settings] under [Network Settings].

⇒ The [SNMP Settings] window appears.

2. Specify each item.

3. To check whether trap notification is properly sent, press the [Test] button.

⇒ Trap notification is performed.

4. Press the [OK] button.

4.7.7 Configuring the SMB 1.0/CIFS Settings Touch Panel AdminTool

1. Select [SMB 1.0/CIFS] under [Network Settings].

⇒ The [SMB 1.0/CIFS] window appears.

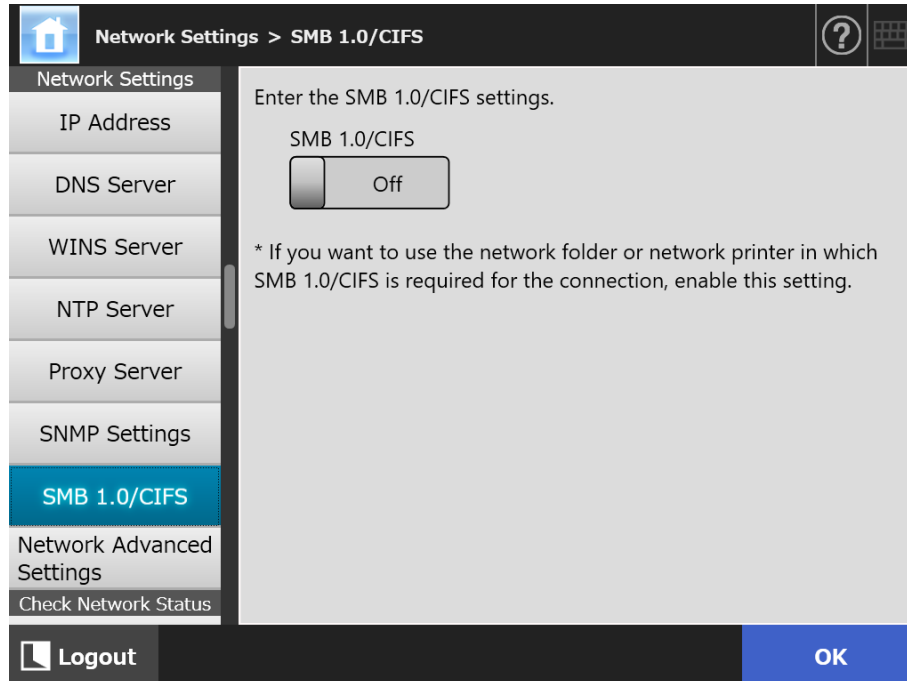

2. Specify whether to enable or disable SMB 1.0/CIFS.

3. Press the [OK] button.

⇒ The restart confirmation window appears.

4. Press the [OK] button.

⇒ The scanner is restarted.

HINT

- If you want to use the network folder or network printer in which SMB 1.0/CIFS is required for the connection, enable SMB 1.0/CIFS.
- If SMB 1.0/CIFS is disabled, the network tree may not be displayed when registering a network folder by selecting a folder in the network tree or when registering a network printer by selecting a printer in the network tree.
- The connection with the scanner is lost if the setting for SMB 1.0/CIFS is changed via the Admin Tool. To continue with other settings, wait a short time for the scanner to restart, then access the scanner via the Admin Tool again.

4.7.8 Configuring Network Advanced Settings Touch Panel AdminTool

Set the Link Speed/Duplex Mode and Wake On LAN.

Also set whether or not to use the IPv6 function. For details about the IPv6 function, refer to "[Appendix G IPv6 Settings](#)" (page 451).

1. Select [Network Advanced Settings] under [Network Settings].

⇒ The [Network Advanced Settings] window appears.

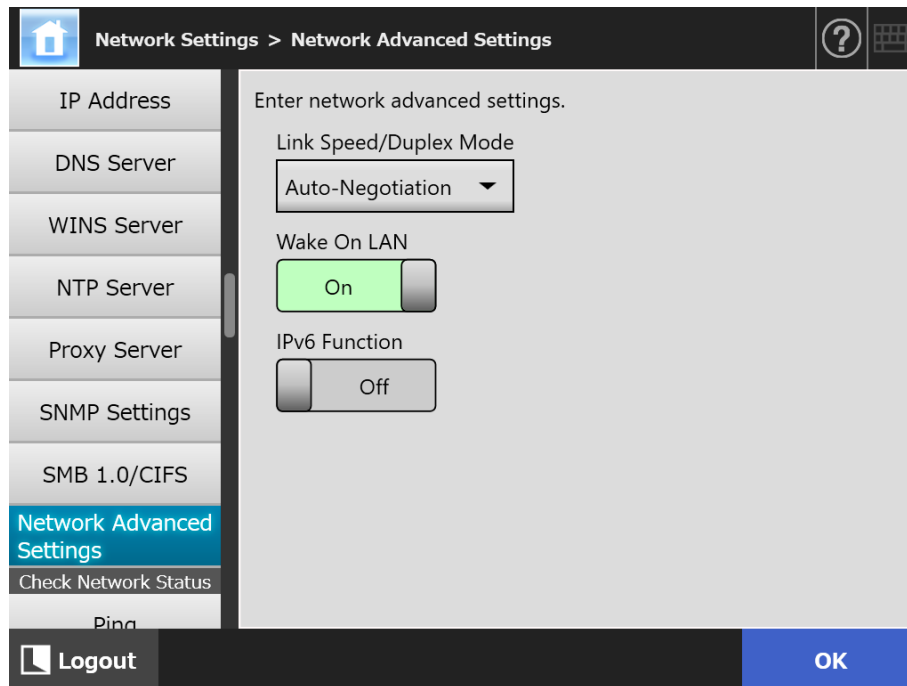

2. Specify each item.

3. Press the [OK] button.

⇒ The information entered is set.

HINT

The connection with the scanner is lost if the IPv6 function is changed via the Admin Tool. To continue with other settings, close the Admin Tool and then access the scanner via the Admin Tool again.

4.8 Checking the Network Status

4.8.1 Checking the Network Connection with a Ping Test Touch Panel AdminTool

Check the network connection using a ping test.

1. Select [Ping] under [Check Network Status].

⇒ The [Ping] window appears.

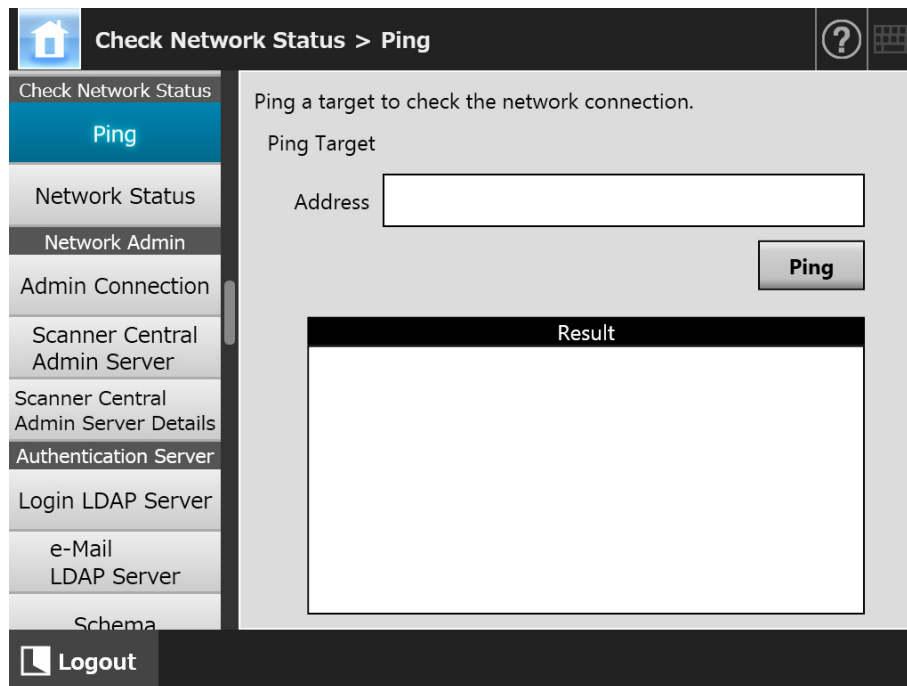

2. For [Address], enter the IP address, host name, or FQDN for the server to be used to check the network connection.

3. Press the [Ping] button.

⇒ A ping test is performed and the results are displayed.

For details about the result, refer to "[Checking Basic Network Operation with a Ping Test](#)" (page 364).

4.8.2 Checking the Network Operating Status Touch Panel AdminTool

The operating status of the network can be checked.

If the information is not shown, the network may not be operating normally. Refer to ["7.2 Network Connection Troubleshooting" \(page 364\)](#), and check the settings.

1. Select [Network Status] under [Check Network Status].

⇒ The [Network Status] window shows the status of the currently operating network connection.

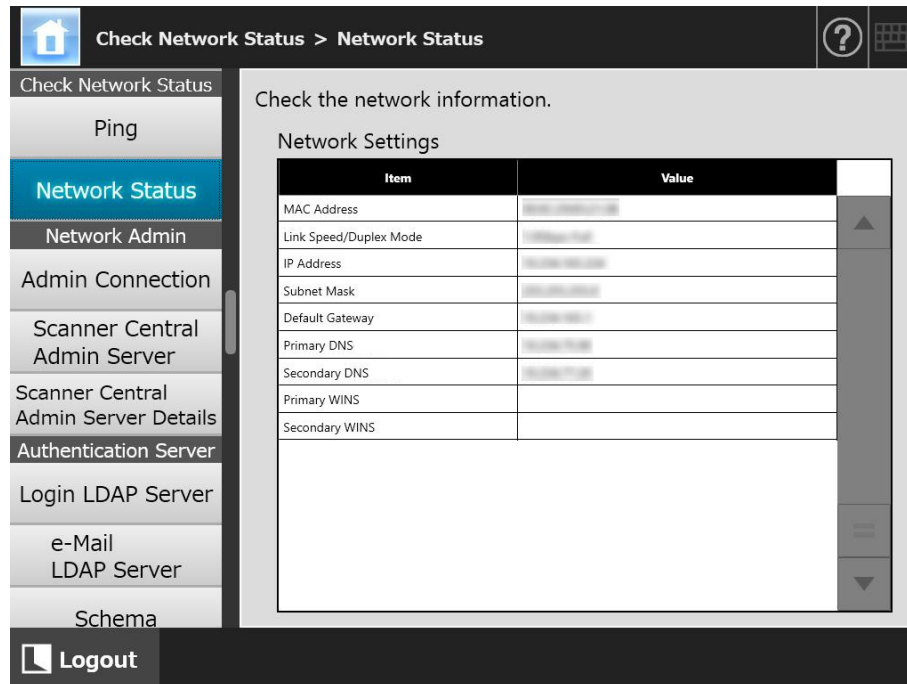

HINT

- If connection to LDAP server is not possible, try the following steps:
 1. Disconnect the LAN cable.
 2. Press the [Shutdown] button on the touch panel to turn the scanner off.
 3. Press the power button to start the scanner with the LAN cable disconnected.
 4. Enter a non-duplicated IP address.
 5. Re-connect the LAN cable to the scanner.
- If the DHCP server cannot be reached when DHCP is set to [On], "169.254.X.X" is displayed for the IP address (X can be any number from 0 to 255).

4.9 Configuring the Network Admin Settings

4.9.1 Setting the Admin Connection Touch Panel AdminTool Central Admin Console

To use the Admin Tool or Central Admin Server for the scanner, perform the connection settings.

1. Select [Admin Connection] under [Network Admin].

⇒ The [Admin Connection] window appears.

The screenshot shows the 'Admin Connection' configuration window. The title bar reads 'Network Admin > Admin Connection'. The left sidebar contains the following menu items: Network Admin, Admin Connection (selected), Scanner Central Admin Server, Scanner Central Admin Server Details, Authentication Server, Login LDAP Server, e-Mail LDAP Server, Schema, Customize LDAP Search, Status Details, and System Status. The main content area is titled 'Enter the settings for the remote administration connection.' and includes the following fields:

- SSL:** A toggle switch set to 'Off'.
- SSL Encryption:** A list of options with checkboxes: TLS 1.2 (checked), TLS 1.1 (checked), TLS 1.0 (checked), and SSL 3.0 (unchecked).
- Port Number:** A text input field containing '80', with a range '(1 - 65535)' below it.
- SSL Certificate:** A warning message: 'This certificate has expired or is not yet valid.' Below it, 'Issued by : -----' and 'Valid from --/--/---- to --/--/----' are displayed. A 'Regenerate' button is located to the right.

At the bottom of the window, there is a 'Logout' button on the left and an 'OK' button on the right.

2. Specify each item.

3. Press the [OK] button.

⇒ The information entered is set.

ATTENTION

The connection with the scanner is lost if the settings for the administration connection are changed via the Admin Tool. To continue with other settings, close the Admin Tool and then access the scanner via the Admin Tool again with the changed settings.

4.9.2 Setting a Central Admin Server Touch Panel AdminTool Central Admin Console

Set whether to manage the scanner under central administration.

When [Central Admin] is enabled, the scanner is registered in the Central Admin Server as a target for central administration.

1. Select [Scanner Central Admin Server] under [Network Admin].

⇒ The [Scanner Central Admin Server] window appears.

2. Specify each item.

Automatic updates are applied to the scanner system (including the security and installed options), system configuration, and Add-ins.

HINT

- If registration with the Central Admin Server is successful, the value for "This scanner's server-side status is:" changes from "Unregistered" to "Registered". Even when setting values are correct, if the network is disconnected or the Central Admin Server is in a suspended state, registration will fail. In either case, if [Central Admin] is [On], the process will be run again the next time the scanner is turned on or resumed from the standby mode.
- For details about the settings required to use SSL for communication between the Central Admin Server and scanner, refer to ["4.9.1 Setting the Admin Connection"](#) (page 110).
- When user roaming or job settings are enabled, if communication with the Central Admin Server is not possible, a confirmation message will appear at login. If the [OK] button is pressed, the settings saved in the scanner are used. Pressing the [Cancel] button returns to the login window.

- If "Update Scheduler" is enabled, the following operations occur:
 - Automatic updates start when the scanner is in a standby mode or when no user is logged in while it is turned on.
Updates are also performed on a specified date and time even with notifications from the Central Admin Server or in an environment in which Wake On LAN cannot be used.
 - When Wake On LAN is enabled, automatic updates start even if the power is off
 - When the setting for an automatic update from the Central Admin Server is distributed to the scanners, if the update is scheduled to start within ten minutes after the setting was distributed, the setting will not be applied.
To enable new system settings in an environment where update calls cannot be issued, scanners must be restarted or logged out. In order to prevent software updates from running at the same time, enable software update time-period restrictions. System settings can be updated even when software updates are restricted. For details, refer to the Scanner Central Admin User's Guide.
 - If the scheduled automatic update time is set in both the Central Admin Console and with the Admin Tool, the most recent settings will be enabled.

3. Press the [OK] button.

⇒ The information entered is set.

⇒ If [Central Admin] is enabled, the scanner information is sent to the Central Admin Server.

If the process is successful, [Scanner Central Admin Server Registration Status] changes to [Registered].

4.9.3 Setting a Central Admin Server (Details)



Set the scanner discovery to enable central administration.

1. Select [Scanner Central Admin Server Details] under [Network Admin].

⇒ The [Scanner Central Admin Server Details] window appears.

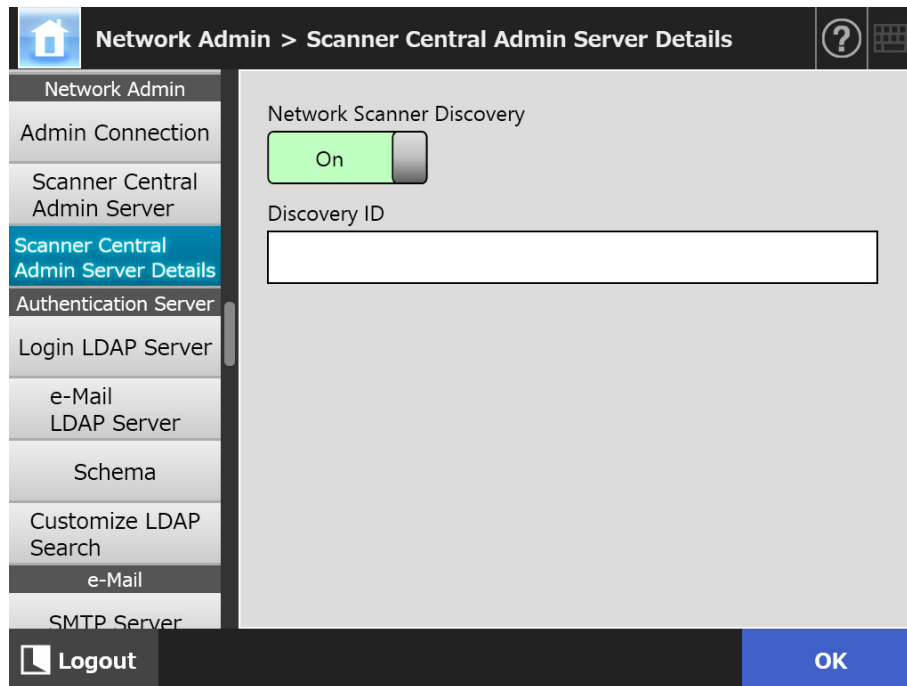

2. Specify each item.

3. Press the [OK] button.

⇒ The information entered is set.

4.10 Setting the Authentication Server

4.10.1 Setting the Login LDAP Server Touch Panel AdminTool Central Admin Console

If a login LDAP server is set, user authentication will be checked.

1. Select [Login LDAP Server] under [Authentication Server].

⇒ The [Login LDAP Server] window appears.

2. Specify each item.

- When [Off] is selected for [Server Type]:
The LDAP server is not used. Press the [OK] button to confirm the setting.
- When [Other LDAP Server] is selected for [Server Type]:
For [LDAP Server Access Authorization], enter an authorized user name and password when searching for users to be logged in to the LDAP server.
- When [Active Directory] or [Active Directory Global Catalog] is selected for [Server Type]:
For [LDAP Server Access Authorization], enter the authentication information for Active Directory.
- For details about the relation between character strings to be entered in [Search Base (DN)] and the target of the LDAP search, refer to "[LDAP Search Target](#)" (page 116).

3. To check the connection with the LDAP server, press the [Connect] button.

- ⇒ When the [Server Type] is [Active Directory] or [Active Directory Global Catalog], the [Authentication] window appears. Enter the authentication details for confirming access to the LDAP server, and press the [OK] button.

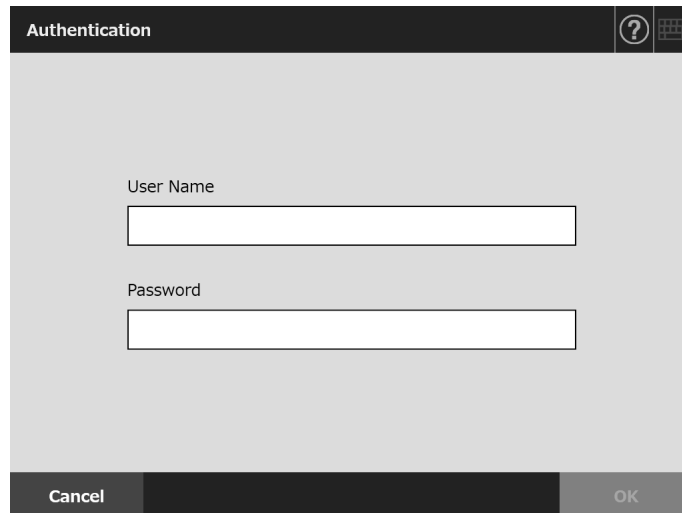

The image shows a screenshot of an 'Authentication' dialog box. The title bar at the top is dark and contains the text 'Authentication' on the left, a question mark icon in the center, and a keyboard icon on the right. The main area of the dialog is light gray and contains two text input fields. The first field is labeled 'User Name' and the second is labeled 'Password'. Both fields are empty. At the bottom of the dialog, there is a dark bar containing two buttons: 'Cancel' on the left and 'OK' on the right.

- ⇒ When the [Server Type] is [Other LDAP Server], authentication is performed with the information that is entered in [LDAP Server Access Authorization].
- ⇒ When the authentication is completed and the connection is successful, the [Login LDAP Server] window appears.

4. Press the [OK] button.

- ⇒ The information entered is set.

LDAP Search Target

The search range and method for LDAP server searches are different according to the LDAP server connection or the search base (DN) settings ([Step 2 of "4.10.1 Setting the Login LDAP Server" \(page 114\)](#)).

The LDAP search targets in each setting are as follows:

- For connecting with LDAP server (when [Active Directory] or [Other LDAP Server] is selected in [Step 2](#))
The following shows an example (where the domain name is *example.com*) for [Search Base (DN)]. The italic text represents variable character strings.

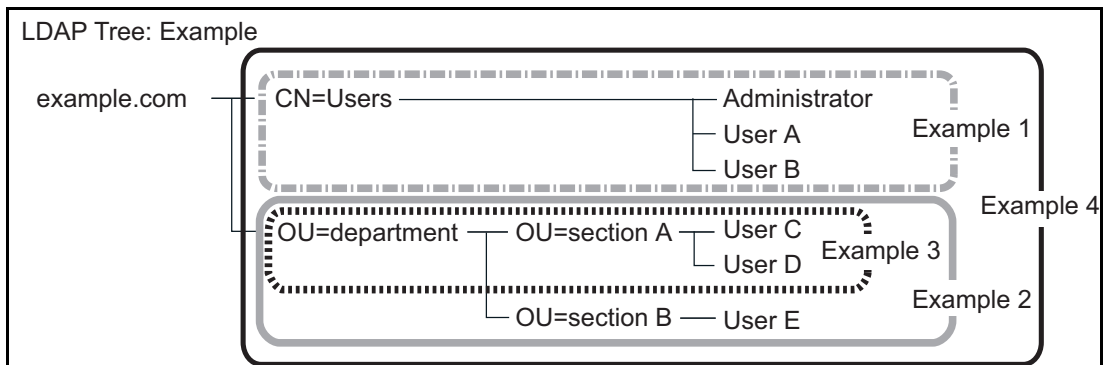

Hereinafter, Active Directory is used as an example to describe search targets.

Example 1: When searching for (administrator, user A, user B)

CN=Users, DC=example, DC=com

Active Directory configuration is as follows:

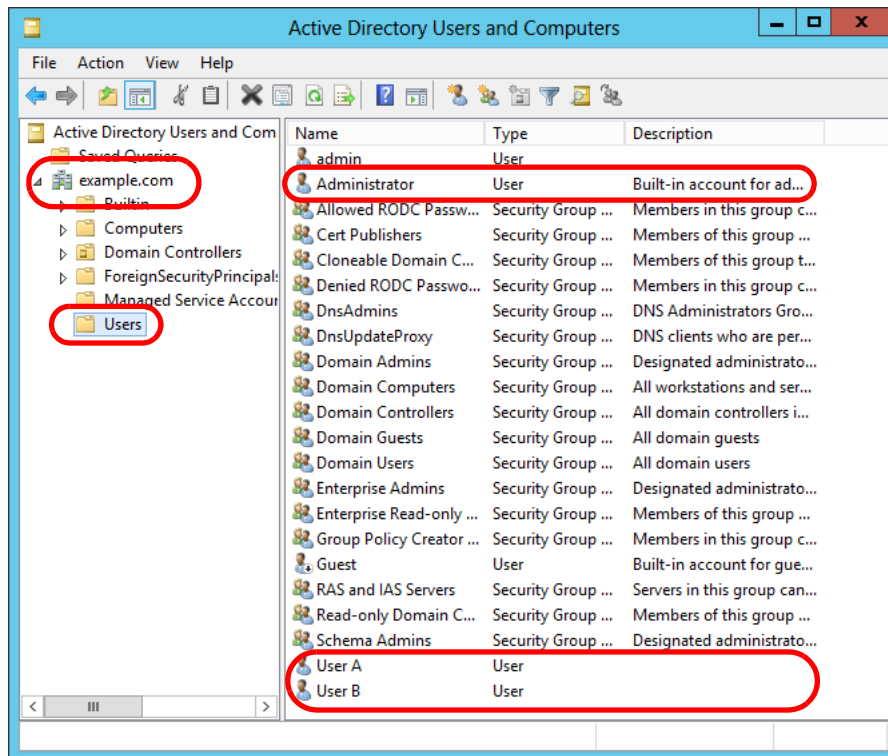

Example 2: When searching for (user C, user D, user E)
 OU=department, DC=example, DC=com
 Active Directory configuration is as follows:

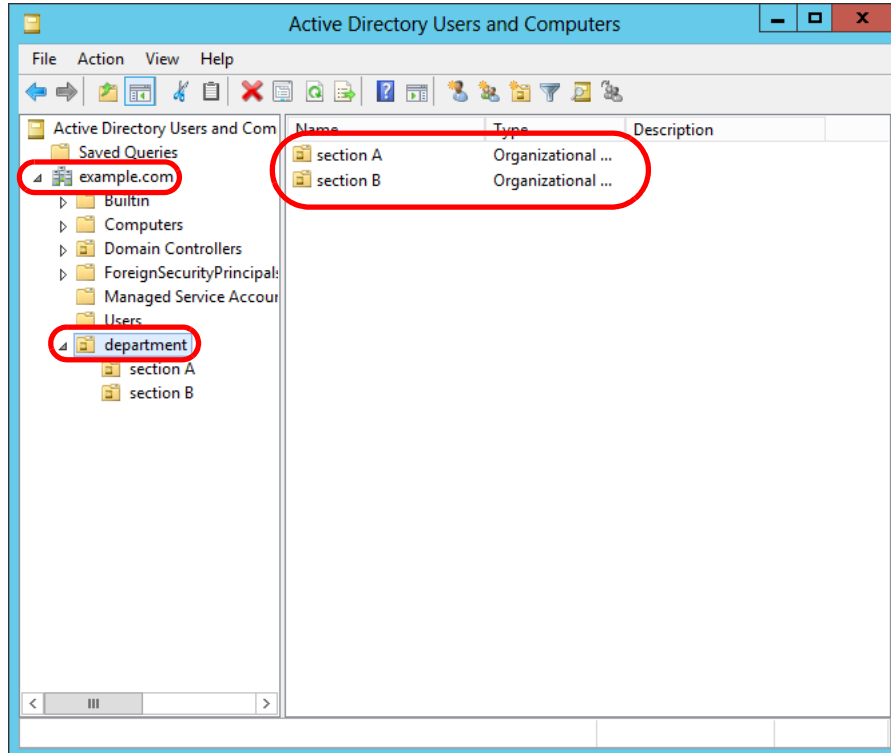

Example 3: When searching for (user C, user D)
 OU=section A, OU=department, DC=example, DC=com
 Active Directory configuration is as follows:

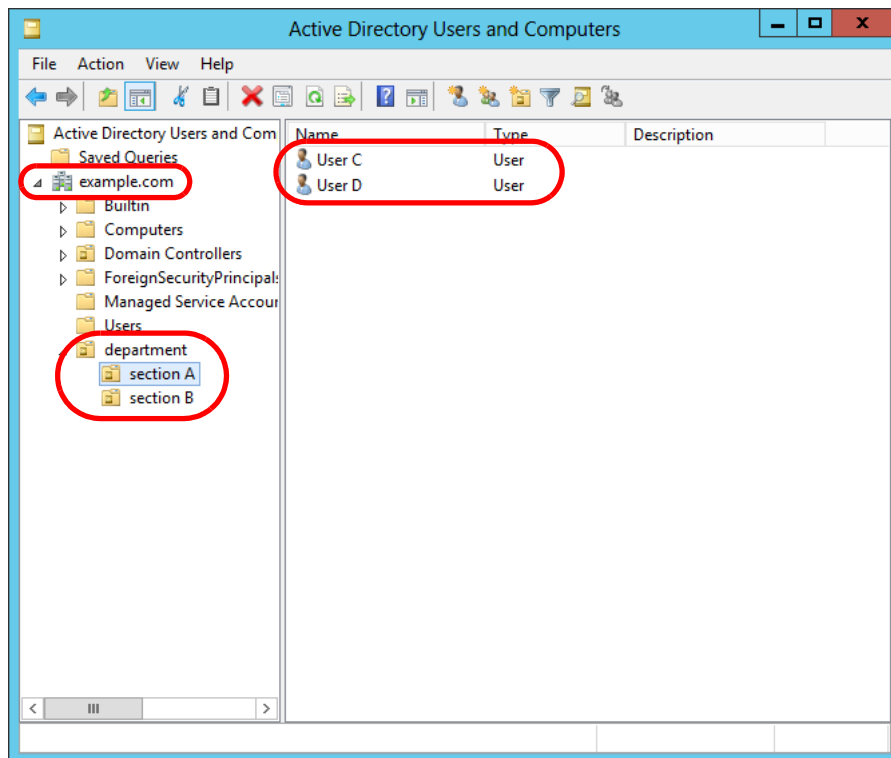

Example 4: When searching for all users
no [Search Base (DN)] setting, or DC=example, DC=com

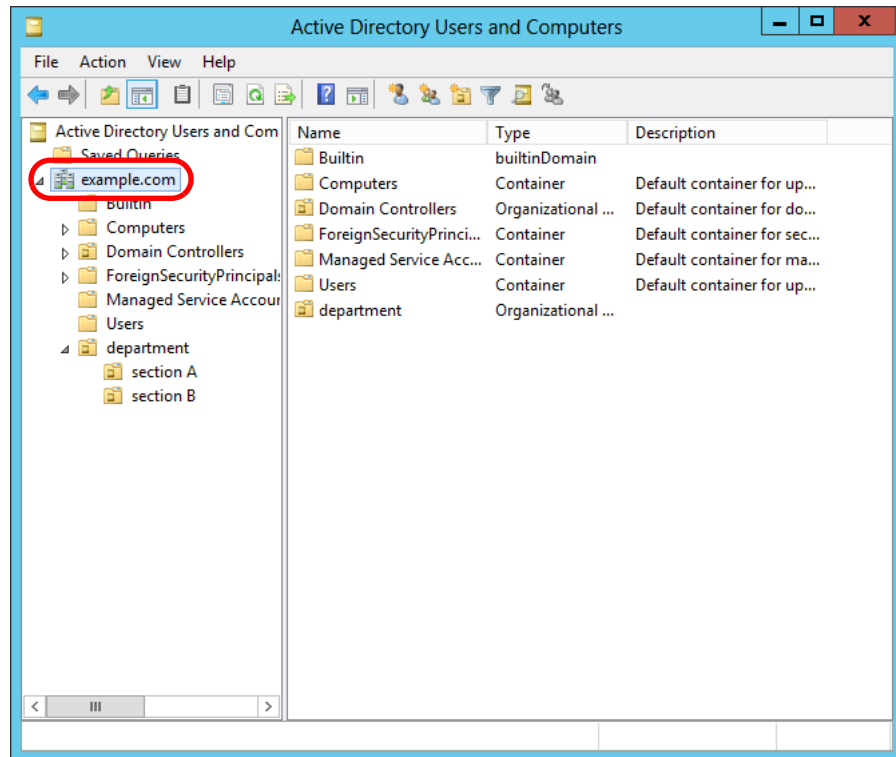

- For connecting with the Global Catalog server (when [Active Directory Global Catalog] is selected in [Step 2](#))
 The following shows an example (where the parent domain name is *example.com*, and subdomain name is *sub.example.com*) for [Search Base (DN)]. The italic text represents variable character strings.

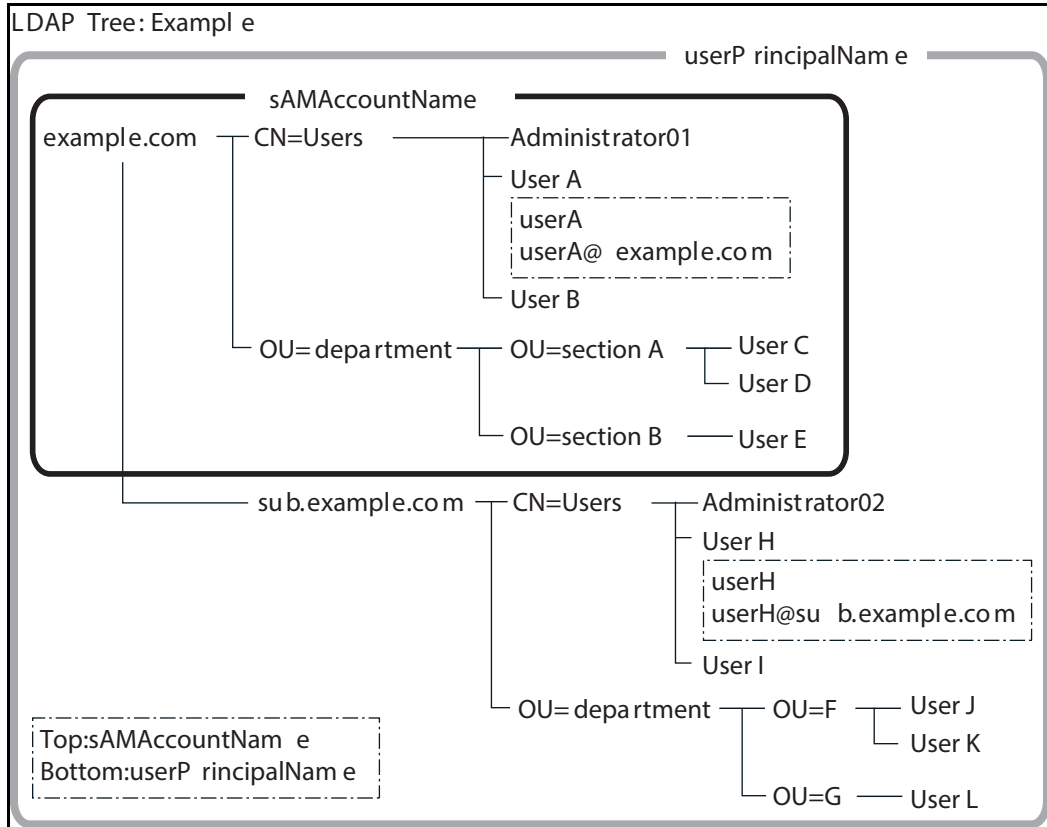

Example: When searching in whole domain
 no [Search Base (DN)] setting, or *DC=example, DC=com*
 Identical regular user login availability differs according to whether a *sAMAccountName* or *userPrincipalName* is used as the login name, as shown below.

| Regular User | Login Name | Login Possible |
|--------------|--|----------------|
| | Top: sAMAccountName Bottom: userPrincipalName | |
| User A | userA | Yes |
| | userA@example.com | Yes |
| User H | userH | — |
| | userH@sub.example.com | Yes |

Yes: Possible —: Not Possible

The SAM Account Name is the Active Directory user login name (sAMAccountName).

HINT

When specifying a SAM account name with a domain name, describe "*domain_name\SAM_account_name*".

The User Principal Name is the Active Directory user login name (userPrincipalName).

4.10.2 Setting the e-Mail LDAP Server Touch Panel Admin Tool Central Admin Console

If an e-mail LDAP server is set, the searches within the LDAP LIST on the [e-Mail Address Book] window can be performed.

1. Select [e-Mail LDAP Server] under [Authentication Server].

⇒ The [e-Mail LDAP Server] window appears.

The screenshot shows the configuration interface for the e-Mail LDAP Server. The title bar reads "Authentication Server > e-Mail LDAP Server". On the left, a vertical menu lists various settings, with "e-Mail LDAP Server" highlighted. The main content area is titled "This server is used to search for e-mail addresses." and contains several configuration options:

- Server Type:** A dropdown menu currently set to "Use Login LDAP", with a "Connect" button to its right.
- SSL:** A dropdown menu set to "Off".
- Address:** An empty text input field.
- Port Number:** A text input field containing "389" with a range indicator "(1 - 65535)".
- Search Base (DN):** A text input field with a small example "(eg: cn=Users, dc=example, dc=com)" below it.
- Search Timeout:** A dropdown menu set to "60sec".
- Maximum Results:** A dropdown menu set to "1000".

 At the bottom of the window, there is a "Logout" button on the left and an "OK" button on the right.

2. Specify each item.

- When [Off] is selected for [Server Type]:
The LDAP server is not used. Press the [OK] button to confirm the setting.
- When [Other LDAP Server] is selected for [Server Type]:
For [LDAP Server Access Authorization], enter an authorized user name and password when searching for users to be logged in to the LDAP server.
- When [Active Directory] or [Active Directory Global Catalog] is selected for [Server Type]:
For [LDAP Server Access Authorization], enter the authentication information for Active Directory.
- For details about the relation between character strings to be entered in [Search Base (DN)] and the target of the LDAP search, refer to "[LDAP Search Target](#)" (page 116).

3. Press the [OK] button.

⇒ The information entered is set.

4.10.3 Setting the Schema

Touch Panel

Admin Tool

Central Admin Console

Associate the search item with the LDAP server schema for LDAP search in an e-Mail address book.

1. Select [Schema] under [Authentication Server].

⇒ The [Schema] window appears.

2. Associate the search items and schema.

3. Press the [OK] button.

⇒ The information entered is set.

ATTENTION

To use the e-mail LDAP server, use a login user account. If the login LDAP server and e-mail LDAP server are different, according to the domain configuration or login name format, it may not be possible to use the e-mail LDAP server. For details, refer to "[LDAP Search Target](#)" (page 116).

4.10.4 Setting the LDAP Search Parameters Touch Panel AdminTool Central Admin Console

Set the LDAP search parameters.

LDAP search parameters are search conditions specified for the (left and middle) buttons displayed on the LDAP List in the [e-Mail Address Book] window.

The buttons are, for example, the [First Name] and [Last Name] buttons on the following window.



By pressing a search condition button, the display order of the e-mail addresses registered in the e-mail address book can be changed according to the search condition specified for the button.

For details about the [e-Mail Address Book] window - [LDAP List] tab, refer to ["5.4.1 Selecting an e-Mail Target from the e-Mail Address Book"](#) (page 232).

1. Select [Customize LDAP Search] under [Authentication Server].

⇒ The [Customize LDAP Search] window appears.

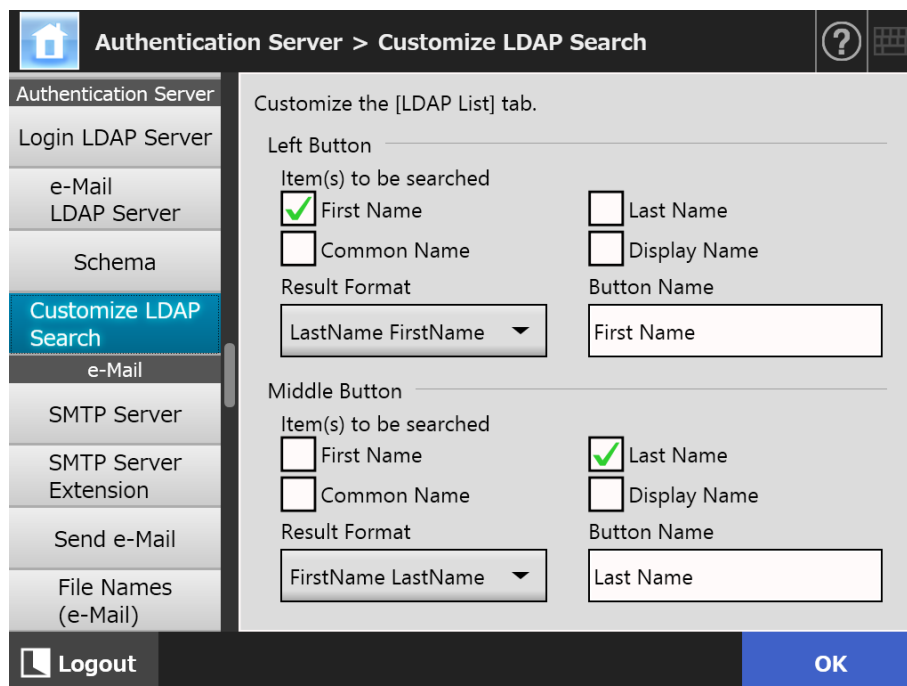

HINT

The following shows the correspondence between the [Customize LDAP Search] window settings and the search condition buttons on the [e-Mail Address Book] window - [LDAP List] tab.

- Left Button

Determines the setting of the left button on the [LDAP List] tab.

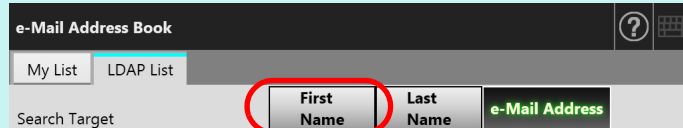

- Middle Button

Determines the setting of the middle button on the [LDAP List] tab.



2. **Specify each item.**

3. **Press the [OK] button.**

⇒ The information entered is set.

4.11 Configuring the e-Mail-Related Settings

4.11.1 Setting the SMTP Server Touch Panel AdminTool Central Admin Console

1. Select [SMTP Server] under [e-Mail].

⇒ The [SMTP Server] window appears.

The screenshot shows the 'SMTP Server' configuration window. The left sidebar contains a menu with the following items: e-Mail, SMTP Server (selected), SMTP Server Extension, Send e-Mail, File Names (e-Mail), Fax, Fax Server, Save, Network Folder, FTP Server Folder, and SharePoint Folder. The main area is titled 'Enter the SMTP server settings.' and contains the following fields:

- Address:** A text input field.
- SSL:** A dropdown menu set to 'Off'.
- Port Number:** A text input field with the value '25' and a range '(1 - 65535)' below it.
- Monitor Connection Timeout:** A toggle switch set to 'Off' and a text input field with the value '30' and the unit 'sec' and range '(1-300)'.
- Split Mails:** A toggle switch set to 'Off'.
- Segment Size:** A text input field with the value '256' and the unit 'KB' and range '(64-10240)'.
- Maximum Attachment Size:** A text input field with the value '10' and the unit 'MB' and range '(1-20)'.
- Address Warning Limit:** A text input field with the value '100' and the range '(2-1000)'.

At the bottom of the window, there is a 'Logout' button on the left and an 'OK' button on the right.

2. Specify each item.

3. Press the [OK] button.

⇒ The information entered is set.

4.11.2 Setting the SMTP Server (Extension)

Touch Panel

AdminTool

Central Admin Console

1. Select [SMTP Server Extension] under [e-Mail].

⇒ The [SMTP Server Extension] window appears.

The screenshot shows the 'SMTP Server Extension' configuration window. The left sidebar contains a menu with the following items: e-Mail, SMTP Server, SMTP Server Extension (highlighted), Send e-Mail, File Names (e-Mail), Fax, Fax Server, Save, Network Folder, FTP Server Folder, and SharePoint Folder. The main area is titled 'SMTP Server Extension' and contains the following settings:

- SMTP Authentication: Off (dropdown menu)
- Authentication Method: AUTH CRAM-MD5 AUTH LOGIN AUTH PLAIN
- Authorized User: Login User (dropdown menu)
- guest:
- e-Mail Address:
- User Name:
- Password:

At the bottom of the window, there is a 'Logout' button on the left and an 'OK' button on the right.

2. Specify each item.**3. Press the [OK] button.**

⇒ The information entered is set.

4.11.3 Configuring Settings for Sending e-Mail

Touch
Panel

AdminTool

Central Admin
Console

Configure the [Send e-Mail] window to send a scanned image by e-mail. Set the character encoding used when e-mails are sent.

1. Select [Send e-Mail] under [e-Mail].

⇒ The [Send e-Mail] window appears.

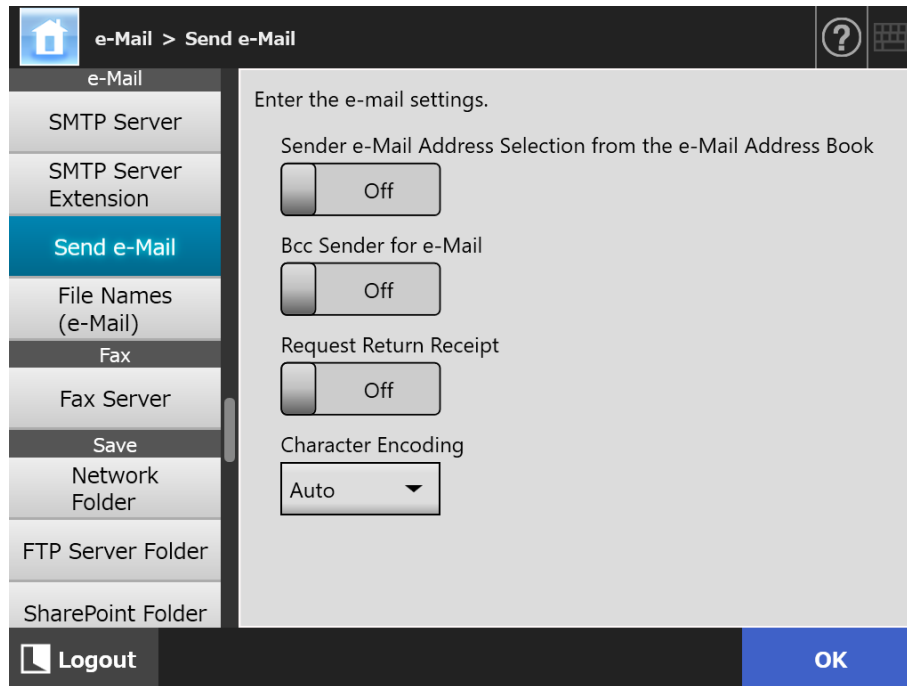

2. Specify each item.

3. Press the [OK] button.

⇒ The information entered is set.

4.11.4 Setting a File Name Format for When Attaching Scanned Data to

e-Mail Touch Panel Admin Tool Central Admin Console

Set a file name format for when attaching scanned data to an e-mail.

The file name specified here is displayed in the [File Name] input field on the [Send e-Mail] window as the default value.

1. Select [File Names (e-Mail)] under [e-Mail].

⇒ The [File Names (e-Mail)] window appears.

Specify the file name format used when attaching scan data to e-mails.

[Scanner Name]MMddyyyyhhmmss

File Name Format

1.Prefix Off

2.Scanner Name On

3.User Name Off

4.Date On

5.Time On

Date Format: MMddyyyy

Delimiter: None

Logout OK

2. Specify each item.

3. Check the file name format.

4. Press the [OK] button.

⇒ The information entered is set.

4.12 Setting the Fax Server Touch Panel AdminTool Central Admin Console

Set the fax server.

1. Select [Fax Server] under [Fax].

⇒ The [Fax Server] window appears.

2. Specify each item.

Enter the recipient e-mail address for [Recipient] and the sender e-mail address for [From].

For details about e-mail address settings values, refer to ["B.1 e-Mail Address Setting Values"](#) (page 402).

3. Press the [OK] button.

⇒ The information entered is set.

ATTENTION

To use Internet FAX, it may be required to enter information such as a password in the Body. To enhance the security, enable SSL in [SMTP Server] on the administrator window. Note that the FAX service needs to support SSL.

4.13 Setting Folders for Saving Scanned Data

The following folders can be set as the folders for saving scanned data:

- Network Folder
- FTP Server Folder
- SharePoint Folder

4.13.1 Setting the Network Folders Touch Panel AdminTool Central Admin Console

A list of network folders may be set as [Save] targets for scanned data.

Any accessible file server folder can be specified as a network folder.

Up to a combined total of 100 network folders, FTP server folders and SharePoint folders can be added.

For details about setting FTP server folders, refer to "[4.13.2 Setting the FTP Server Folders](#)" (page 136).

For details about setting SharePoint folders, refer to "[4.13.3 Setting the SharePoint Folders](#)" (page 140).

A network folder can be added in the following ways.

- Network Tree
 - Select a network folder from the network tree.
 - For details, refer to "[Registering a Network Folder \(Network Tree\)](#)" (page 131).
- Network Path
 - Set a network folder by directly entering the path alias for the file server folder.
 - For details, refer to "[Registering a Network Folder \(Network Path\)](#)" (page 133).

For details about setting a file name for scanned data to be saved in a network folder, refer to "[4.13.4 Setting a File Name Format for When Saving Scanned Data](#)" (page 144).

ATTENTION

Note the following when registering a network folder:

- The network folder is registered as a network path. If the network folder is shared and the length of the full path including the file name exceeds 259 characters, the saved data file cannot be viewed. Before registering a (Windows) network folder, check that the length of the full file path+name is not likely to exceed 259 characters.
- If the selected folder was created using a language foreign to that of the browsing operating system, the network folder may not register correctly.
 - The name of the network folder is not displayed correctly because it contains unrecognizable code.
- If the number of folders to be displayed is large, they may take a long time to appear.

■ Registering a Network Folder (Network Tree)

1. Select [Network Folder] under [Save].

⇒ The [Network Folder] window appears.

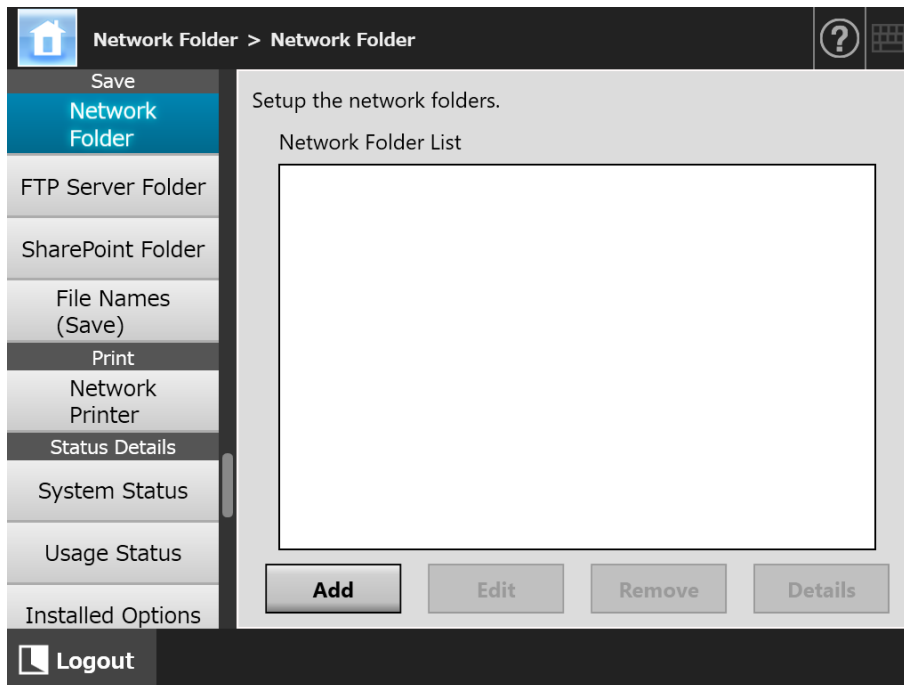

2. Press the [Add] button.

⇒ The window for selecting a network folder appears.

ATTENTION

Desired domains may not be shown in the domain list. In this case, directly enter the path alias for the file server, or wait for a few minutes and re-open the window for adding a network folder.

3. Select a domain

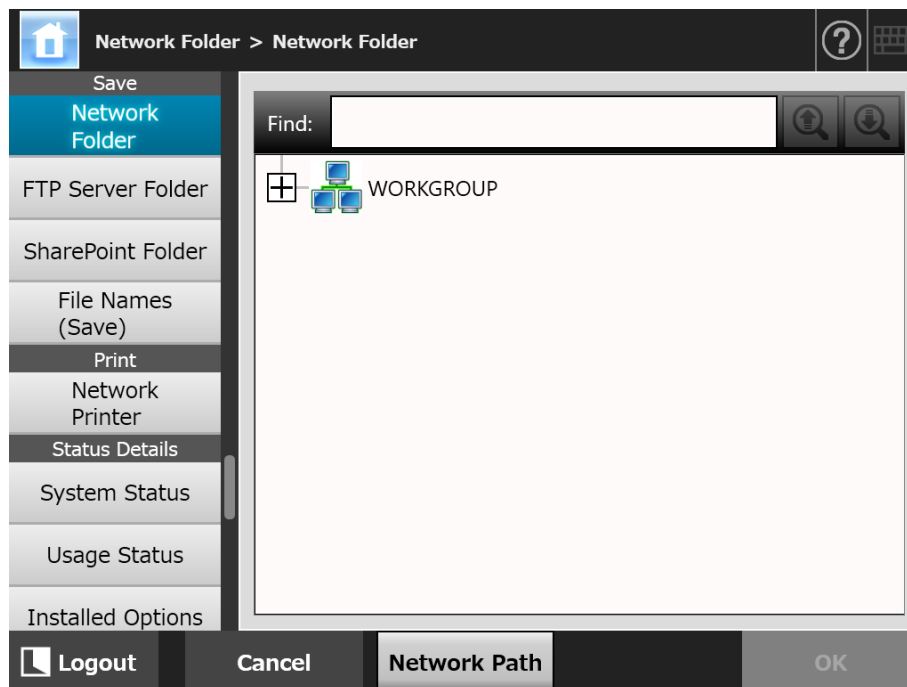

- ⇒ The network tree expands and the subordinate computer names are displayed. If an authentication window is displayed, enter a user name and password. If authentication is successful, the subordinate computer names are displayed.

4. Select a computer

- ⇒ The network tree expands and the subordinate network folder names are displayed. If an authentication window is displayed, enter a user name and password. If authentication is successful, the subordinate network folder names are displayed.

5. Select a network folder

The selected folder will be opened to show any sub-folders, which themselves may be selected in turn (up to seven levels deep, including the parent domain).

6. Press the [OK] button.

- ⇒ The selected network folder is added to the network folder list.

HINT

The default network folder alias will be the same as the alias selected from the network tree. For details on changing the network folder alias, refer to "[Renaming a Network Folder](#)" (page 134).

■ Registering a Network Folder (Network Path)

1. Select [Network Folder] under [Save].

⇒ The [Network Folder] window appears.

2. Press the [Add] button.

⇒ The window for selecting a network folder appears.

3. Press the [Network Path] button.

⇒ The window for adding a network folder appears.

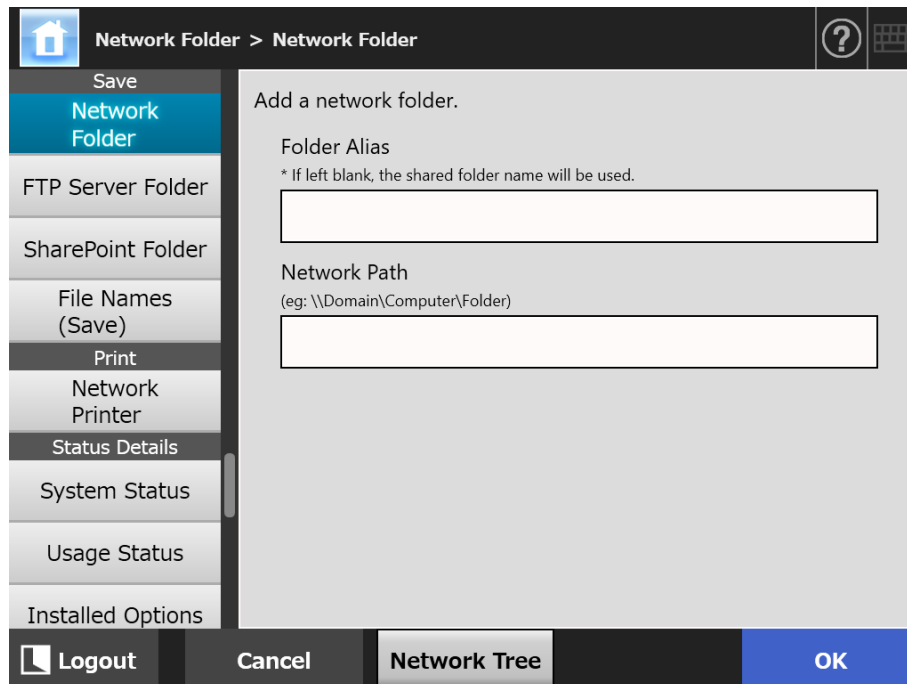

4. Specify each item.

5. Press the [OK] button.

⇒ The network folder is added to the network folder list.

ATTENTION

Make sure you specify the domain name at the start of the path name of the network folder.

HINT

- The network folder alias will be the same as the alias specified in this window. For details on changing the network folder alias, refer to ["Renaming a Network Folder" \(page 134\)](#).
- The authentication window may appear.

■ Renaming a Network Folder

1. **Select [Network Folder] under [Save].**
 - ⇒ The [Network Folder] window appears.
2. **Select the network folder that is to be renamed.**
3. **Press the [Edit] button.**
 - ⇒ The window for editing the network folder appears.
4. **Enter a folder alias.**
5. **Press the [OK] button.**
 - ⇒ The network folder is renamed.

■ Removing a Network Folder

1. **Select [Network Folder] under [Save].**
 - ⇒ The [Network Folder] window appears.
2. **Select the network folder that is to be removed from the folder list.**
3. **Press the [Remove] button.**
 - ⇒ The window for removing a network folder appears.
4. **Confirm the details of the network folder that is to be removed are correct, and press the [Yes] button.**
 - ⇒ The selected network folder is removed from the network folders list.

■ Viewing the Network Folder Details

1. Select [Network Folder] under [Save].

⇒ The [Network Folder] window appears.

2. Select the desired network folder from the folder list.

3. Press the [Details] button.

⇒ The information for the selected network folder is displayed.

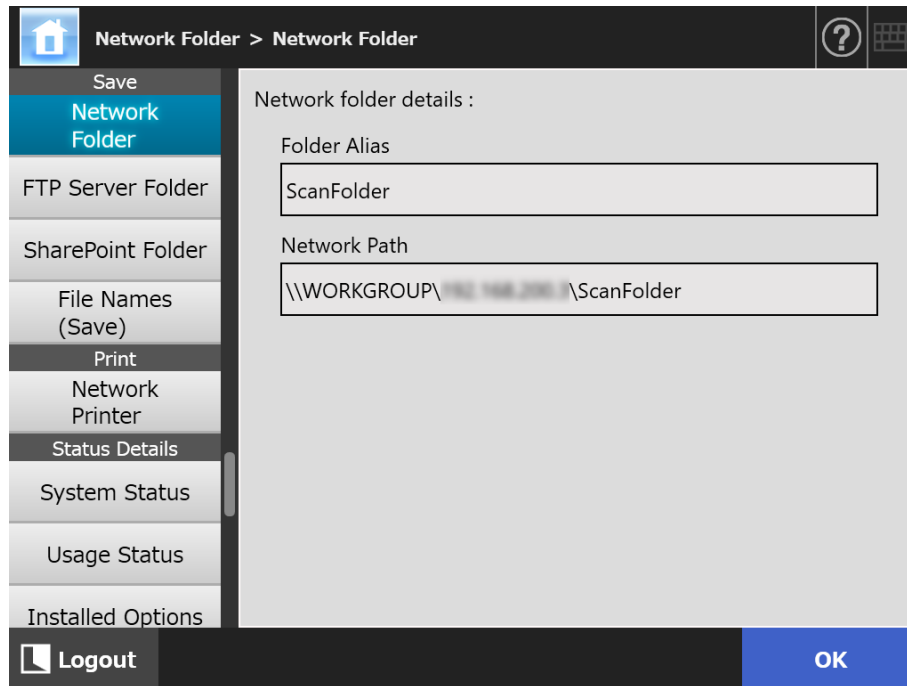

4.13.2 Setting the FTP Server Folders

Touch
Panel

AdminTool

Central Admin
Console

A list of FTP server folders may be set as [Save] targets for scanned data.

Up to a combined total of 100 FTP server folders, network folders and SharePoint folders can be added.

For details about setting network folders, refer to ["4.13.1 Setting the Network Folders"](#) (page 130).

For details about setting SharePoint folders, refer to ["4.13.3 Setting the SharePoint Folders"](#) (page 140).

For details about setting a file name for scanned data to be saved in an FTP server folder, refer to ["4.13.4 Setting a File Name Format for When Saving Scanned Data"](#) (page 144).

ATTENTION

Note the following when registering an FTP server folder:

- The FTP server folder is registered as a network path. If the FTP server folder is shared and the length of the full path including the file name exceeds 259 characters, the saved data file cannot be viewed. Before registering an FTP server folder, check that the length of the full file path+name is not likely to exceed 259 characters.
- If the selected folder was created using a language foreign to that of the browsing operating system, the FTP server folder may not register correctly.
The name of the FTP server folder is not displayed correctly because it contains unrecognizable code.
- For FTP path, user name, and password, alphanumeric characters and symbols with the exception of "\ / : ; * ? " < > | # & %" can be used.

■ **Registering an FTP Server Folder**

1. **Select [FTP Server Folder] under [Save].**

⇒ The [FTP Server Folder] window appears.

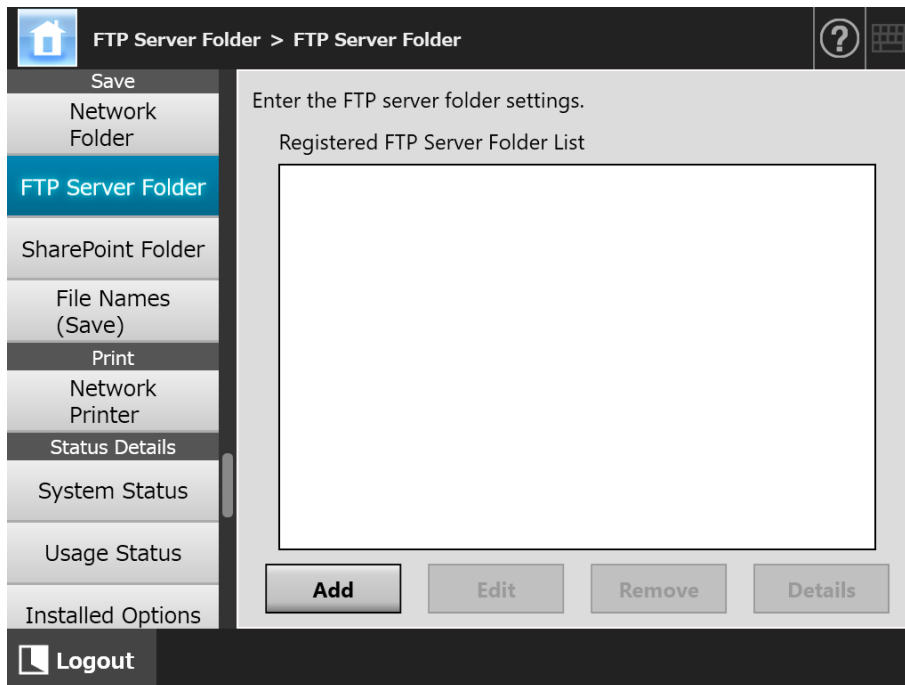

2. **Press the [Add] button.**

⇒ The window for setting an FTP server folder appears.

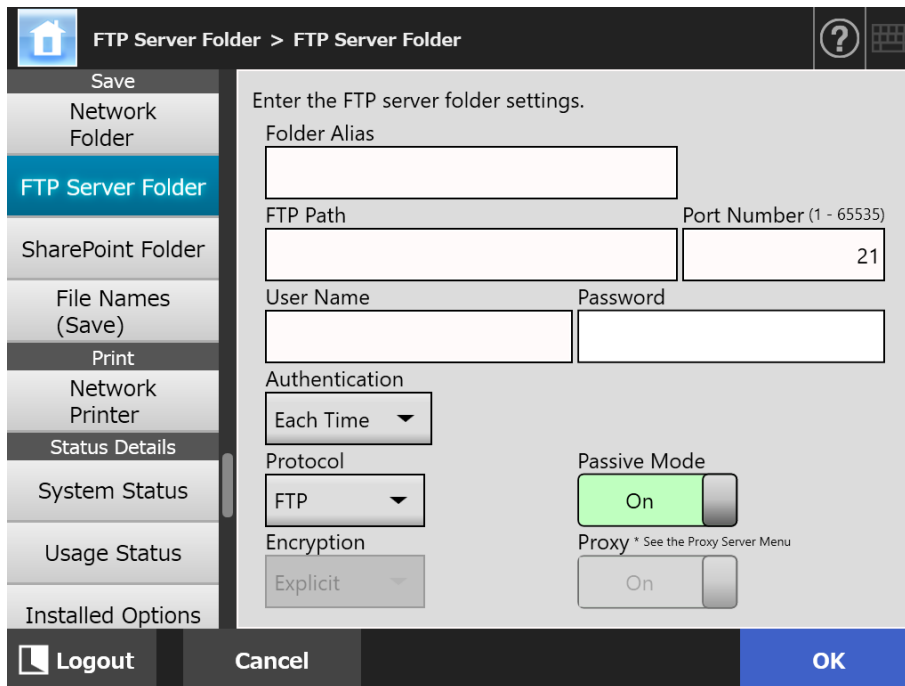

3. Specify each item.

The [Proxy] setting is only available when a proxy server has been set on the [Proxy Server] window. For details about proxy server settings, refer to "[4.7.5 Setting the Proxy Server](#)" (page 104).

4. Press the [OK] button.

⇒ User authentication may be required to access the FTP server. When the user name and password are valid, the [FTP Server Folder] window appears again and the FTP server folder is set.

■ Changing the FTP Server Folder Settings**1. Select [FTP Server Folder] under [Save].**

⇒ The [FTP Server Folder] window appears.

2. Select an FTP server folder to be changed.**3. Press the [Edit] button.**

⇒ The window for editing the FTP server folder appears.

4. Change the settings.**5. Press the [OK] button.**

⇒ The changed settings are applied.

■ Removing an FTP Server Folder**1. Select [FTP Server Folder] under [Save].**

⇒ The [FTP Server Folder] window appears.

2. Select an FTP server folder that is to be removed from the folder list.**3. Press the [Remove] button.**

⇒ The window for removing the FTP server folder appears.

4. Confirm the details of the FTP server folder that is to be removed are correct, and press the [Yes] button.

⇒ The selected FTP server folder is removed from the FTP server folder list.

■ Viewing the FTP Server Folder Details

1. **Select [FTP Server Folder] under [Save].**
⇒ The [FTP Server Folder] window appears.
2. **Select the desired FTP server folder from the folder list.**
3. **Press the [Details] button.**
⇒ The information for the selected FTP server folder is displayed.

The screenshot shows a configuration window titled "FTP Server Folder > FTP Server Folder". On the left is a vertical menu with options: Save, Network Folder, FTP Server Folder (highlighted), SharePoint Folder, File Names (Save), Print, Network Printer, Status Details, System Status, Usage Status, and Installed Options. At the bottom left of the menu is a "Logout" button. The main area is titled "FTP server folder details:" and contains the following fields and controls:

- Folder Alias: Text box containing "FTPFolder".
- FTP Path: Text box containing "192.168.200.1".
- Port Number (1 - 65535): Text box containing "21".
- User Name: Text box.
- Password: Text box.
- Authentication: Dropdown menu set to "Each Time".
- Protocol: Dropdown menu set to "FTP".
- Encryption: Dropdown menu set to "Explicit".
- Passive Mode: Toggle switch set to "On".
- Proxy * See the Proxy Server Menu: Toggle switch set to "Off".

At the bottom right of the window is a blue "OK" button.

4.13.3 Setting the SharePoint Folders

Touch Panel

AdminTool

Central Admin Console

A list of SharePoint folders may be set as [Scan to SharePoint] targets for scanned data. Up to a combine total of 100 SharePoint folders, network folders and FTP server folders can be added.

For details about setting network folders, refer to ["4.13.1 Setting the Network Folders"](#) (page 130).

For details about setting FTP server folders, refer to ["4.13.2 Setting the FTP Server Folders"](#) (page 136).

For details about setting a file name for scanned data to be saved in a SharePoint folder, refer to ["4.13.4 Setting a File Name Format for When Saving Scanned Data"](#) (page 144).

■ Registering a SharePoint Folder

ATTENTION

If you failed to add SharePoint Online when registering a SharePoint folder, import the certificate "Digicert Global Root CA" to the scanner.

1. Select [SharePoint Folder] under [Save].

⇒ The [SharePoint Folder] window appears.

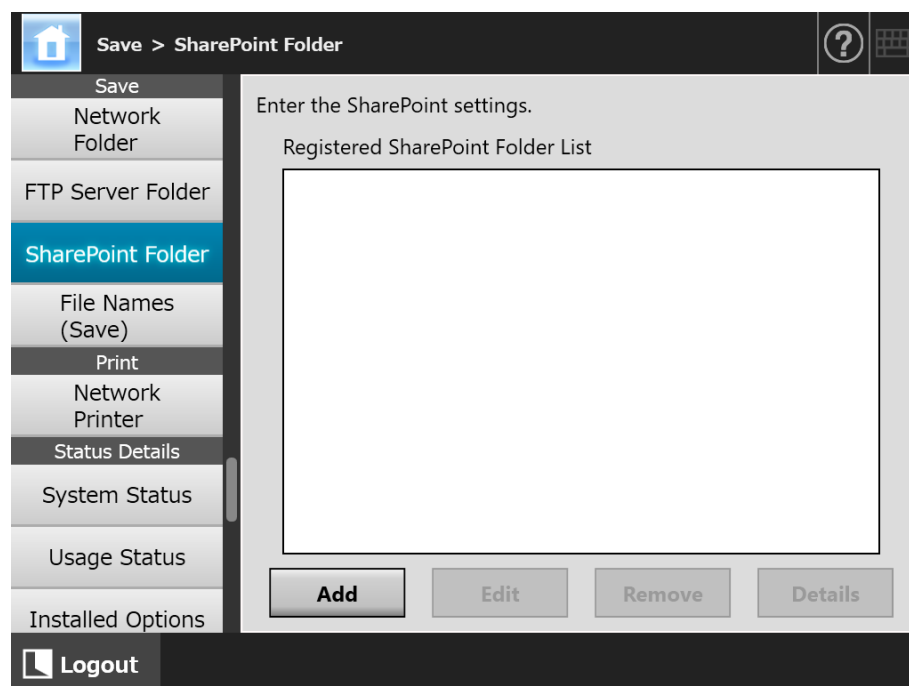

2. Press the [Add] button.

⇒ The window for adding a SharePoint folder appears.

3. Specify each item.

ATTENTION

[SharePoint Folder Name] is a folder alias that is used for configuration purposes only, not an actual folder name. Scanned data is saved in the root folder for the specified library.

4. Press the [OK] button.

⇒ The [Authentication] window appears.

Enter the user name and password for signing in the SharePoint server, and then press the [OK] button.

- User names may be up to 256 characters long.
- Passwords may be up to 256 characters long. [User Name] and [Password] are case sensitive.

⇒ The [SharePoint Folder] window appears again and the specified folder is added to [Registered SharePoint Folder List].

■ Changing the SharePoint Folder Settings

1. **Select [SharePoint Folder] under [Save].**
 - ⇒ The [SharePoint Folder] window appears.
2. **From [Registered SharePoint Folder List], select a SharePoint folder that is to be changed.**
3. **Press the [Edit] button.**
 - ⇒ The window for editing the SharePoint folder settings appears.
4. **Change the settings.**
5. **Press the [OK] button.**
 - ⇒ The changed settings are applied.

■ Removing a SharePoint Folder

1. **Select [SharePoint Folder] under [Save].**
 - ⇒ The [SharePoint Folder] window appears.
2. **From [Registered SharePoint Folder List], select the folder that is to be removed.**
3. **Press the [Remove] button.**
 - ⇒ A confirm removal window appears for the selected SharePoint folder.
4. **Confirm the details of the SharePoint folder that is to be removed are correct, and press the [Yes] button.**
 - ⇒ The SharePoint folder is removed.

■ Viewing the SharePoint Folder Details

1. Select [SharePoint Folder] under [Save].

⇒ The [SharePoint Folder] window appears.

2. Select the desired SharePoint folder from [Registered SharePoint Folder List].

3. Press the [Details] button.

⇒ The information for the selected SharePoint folder is displayed.

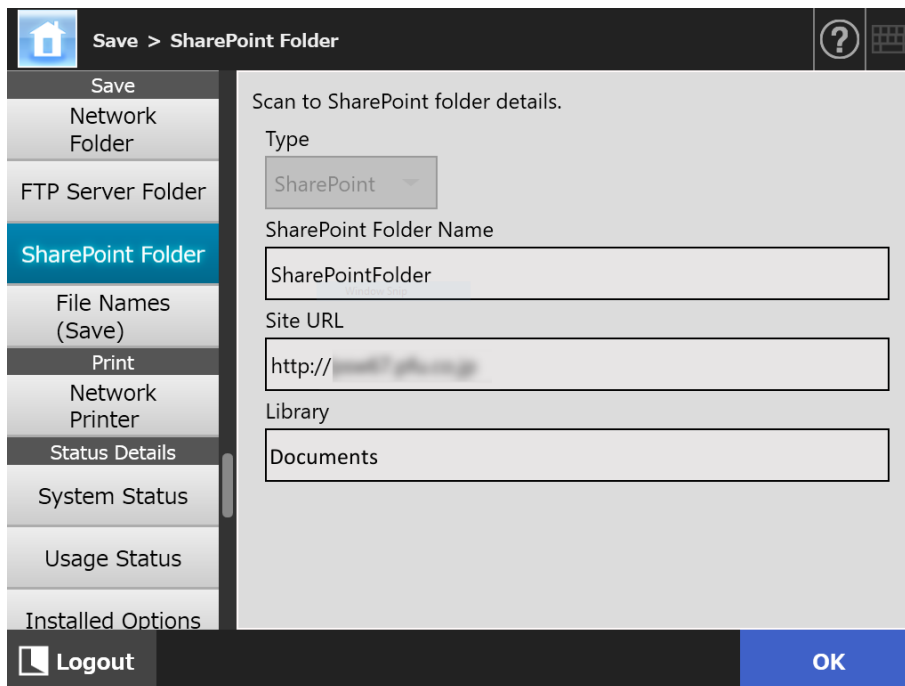

The screenshot shows a software interface for configuring a SharePoint folder. The title bar reads "Save > SharePoint Folder". On the left is a vertical menu with options: Save, Network Folder, FTP Server Folder, SharePoint Folder (highlighted in blue), File Names (Save), Print, Network Printer, Status Details, System Status, Usage Status, and Installed Options. At the bottom left is a "Logout" button. The main area is titled "Scan to SharePoint folder details." and contains the following fields:

- Type: A dropdown menu showing "SharePoint".
- SharePoint Folder Name: A text input field containing "SharePointFolder".
- Site URL: A text input field containing "http://".
- Library: A text input field containing "Documents".

At the bottom right of the dialog is a blue "OK" button.

4.13.4 Setting a File Name Format for When Saving Scanned

Data Touch Panel AdminTool Central Admin Console

A file name format can be set to be used when scanned data is saved in a network folder, FTP server folder, or SharePoint folder.

The specified file name format is used for the default value in the [File Name] input field on the [Save] window for regular users.

1. Select [File Names (Save)] under [Save].

⇒ The [File Names (Save)] window appears.

2. Specify each item.

HINT

The following explains the way in which sequence numbers are added.

- Sequence numbers start from 1. When there are files with file names containing sequence numbers, sequence numbers following the largest value will be used. For example, if the file name is "A", sequence numbers are set to be added in 3 digits, and "A001.pdf" and "A004.pdf" already exist, subsequent file names are assigned in the following order.
"A005.pdf", "A006.pdf", "A007.pdf", "A008.pdf"...
File names "A002.pdf" and "A003.pdf" are skipped.
- If the sequence number exceeds the setting in the [Seq. Number], subsequent file names are assigned using the next digit. For example, if the file name is "A", sequence numbers are set to be added in 3 digits, and "A001.pdf" to "A998.pdf" already exist, subsequent file names are assigned in the following order.
"A999.pdf", "A1000.pdf", "A1001.pdf", "A1002.pdf"...
- The maximum sequence number is "4294967295". If it is exceeded, the skipped minimum number is used for the sequence number. For example, if the file name is "A", sequence numbers are set to be added in 3 digits, and "A001.pdf", "A003.pdf", and "A4294967295.pdf" already exist, subsequent file names are assigned in the following order.
"A002.pdf", "A004.pdf", "A005.pdf", "A006.pdf"...
- When multiple sheets are scanned in one go, consecutive numbers may be added to the names of JPEG files, single page TIFF files, and single page PDF files. Numbers are added to the names of JPEG files, single page TIFF files, and single page PDF files (one image per file), but are not added to the names of multiple page PDF files or multiple page TIFF files (multiple images per file). For example, when multiple files are saved as a single page TIFF file, a single page PDF file, or a JPEG file, the numbers are added in consecutive order at the end of a file name as follows:
"abc-0001.tif" "abc-0001.pdf" "abc-0001.jpg"

3. Check the file name format.

4. Press the [OK] button.

⇒ The file name format is set.

4.14 Setting the Network Printers

Touch
Panel

AdminTool

Central Admin
Console

Set a printer connected to the network as a network printer.

You can set a network printer in one of the following ways:

- (a) Setting a network printer via a print server
- (b) Setting a network printer without a print server

(a) Setting a Network Printer via a Print Server

Set a network printer via print server. The setting procedure is as follows:

1. Check the printer driver.

For details, refer to ["Checking the Printer Drivers" \(page 149\)](#).

2. Set the printer properties.

For details, refer to ["Setting the Printer Properties \(via the Print Server\)" \(page 150\)](#).

3. Register the network printer.

Up to 100 network printers can be registered.

A network printer can be registered in the following ways.

- Network Tree
Select a network printer from the network tree.
For details, refer to ["Registering a Network Printer \(Network Tree\) \(via the Print Server\)" \(page 153\)](#).
- Network Path
Directly enter the network printer path name.
For details, refer to ["Registering a Network Printer \(Network Path\)" \(page 155\)](#).
For [Step 4](#), refer to (a).

ATTENTION

- Read the printer manual beforehand for information about setting a printer, adding a network printer, and other cautions.
- Make sure that there is enough space in the drive before printing.
- Do not set a virtual printer.
- If a printer connected to different print servers is to be registered as a network printer multiple times, the software version of the driver should be the same on each print server.
If the software version of the printer driver differs, printing errors may occur.
- If the shared name of the printer contains the vertical bar (|), it cannot be registered as a network printer.

(b) Setting a Network Printer without a Print Server

Set a network printer without a print server for direct printing.

ATTENTION

To install a printer driver on a scanner from a computer, you need to prepare a computer in advance, on which a network printer has been published.

You can set a network printer without a print server in one of the following ways:

- (b-1) Downloading a driver from a computer on which a network printer is published and using the driver
- (b-2) Registering a network printer and then selecting a driver for the network printer

The setting procedure is as follows:

(b-1) Downloading a Driver from a Computer on Which a Network Printer Is Published and Using the Driver

1. **Prepare a computer on which a printer is registered as a network printer.**
2. **Check the printer driver.**

For details, refer to ["Checking the Printer Drivers" \(page 149\)](#).

3. **Check the printer name or the IP address for the printer.**

For details, refer to ["Checking the Printer Name or the IP Address for the Printer \(for Direct Printing\)" \(page 152\)](#).

4. **Register a network printer without a print server.**

Directly enter each item of the settings for network printers.

Up to 100 network printers can be registered.

For details, refer to ["Registering a Network Printer \(Network Path\)" \(page 155\)](#). For [Step 4](#), refer to (b-1).

ATTENTION

- To register a network printer without a print server, the printer that you intend to register needs to be turned on.
- When you register a network printer without a print server, a driver is automatically installed in silent mode from a computer on which a printer is registered as a network printer.

(b-2) Registering a Network Printer and Then Selecting a Driver for the Network Printer

1. Register a network printer.

When you add a network printer without a print server by using the relevant driver for the network printer that is registered in [Printer List], you do not need to register a new network printer. Proceed to the next step.

HINT

To register a new network printer, refer to "[\(a\) Setting a Network Printer via a Print Server](#)" (page 146) or "[\(b-1\) Downloading a Driver from a Computer on Which a Network Printer Is Published and Using the Driver](#)" (page 147).

2. Check the printer name or the IP address for the printer.

For details, refer to "[Checking the Printer Name or the IP Address for the Printer \(for Direct Printing\)](#)" (page 152).

3. Check the driver name for the printer.

For details, refer to "[Checking the Driver Name for the Printer \(for Direct Printing\)](#)" (page 152).

4. Register a network printer without a print server.

Directly enter each item of the settings for network printers.

Up to 100 network printers can be registered.

For details, refer to "[Registering a Network Printer \(Network Path\)](#)" (page 155). For [Step 4](#), refer to (b-2).

ATTENTION

Do not delete the network printer settings that were used to set a network printer without a print server from the computer. If the settings are removed, the corresponding driver is also removed from the scanner, and it may cause an error in printing.

■ Checking the Printer Drivers

The driver installed on the print server must be compatible with Windows 10.

Use the following procedure to check whether the drivers installed on the print server are Windows 10 compatible drivers.

Note that a print server is a computer on which printers are registered as network printers.

1. Select [View Devices and Printers] on the control panel window on the print server.

⇒ The [Devices and Printers] window appears.

2. Right-click on a printer and select [Printer Properties].

⇒ Printer properties appear.

3. Press the [Additional Drivers] in the [Sharing] tab.

⇒ The [Additional Drivers] window appears.

4. Check that the installed status is [Yes] for processor [x64] with [Type 3 - User Mode] or [Type 4 - User Mode] selected as the type.

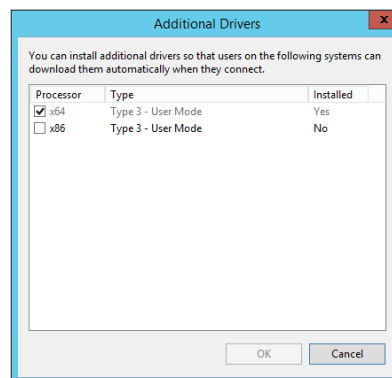

- When the [Installed] status is [Yes], the driver has been installed and the printer can be used as a network printer. Press the [Cancel] button.
- When the installed status is [No], select [x64] with [Type 3 - User Mode] or [Type 4 - User Mode] selected as the type and press the [OK] button.

⇒ The Windows 10 compatible driver is installed.

■ Setting the Printer Properties (via the Print Server)

Use the following procedures to set a printer.

1. **Select [View Devices and Printers] on the control panel window on the print server.**
 - ⇒ The [Devices and Printers] window appears.
2. **Right-click on a printer and select [Printer Properties].**
 - ⇒ Printer properties appear.
3. **Press the [Printing Defaults] button on the [Advanced] tab.**
 - ⇒ The printing defaults window is displayed.
4. **Change the settings for the printer.**

HINT

It is recommended that you add a printer to the print server for each configuration of the property settings. For example, when you use only one printer, you should add printers to the print server according to different purposes, such as color printing and black and white printing.

For a color printing example, the procedure for adding a printer is as follows.

1. Select [View Devices and Printers] on the control panel window on the print server.
 - ⇒ The [Devices and Printers] window appears.
2. Press the [Add Printer] button.
 - ⇒ The [Add Printer] wizard appears.
3. Follow the prompts on the window until [Use the driver that is currently installed] appears.
4. Select [Use the driver that is currently installed (recommended)] and press the [Next] button.

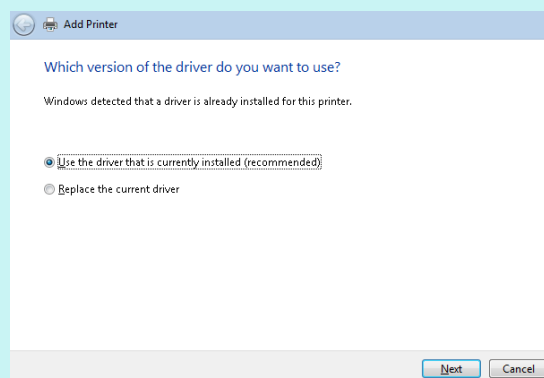

5. Follow the prompts on the window until [Printer Sharing] appears.

6. Specify the shared name.

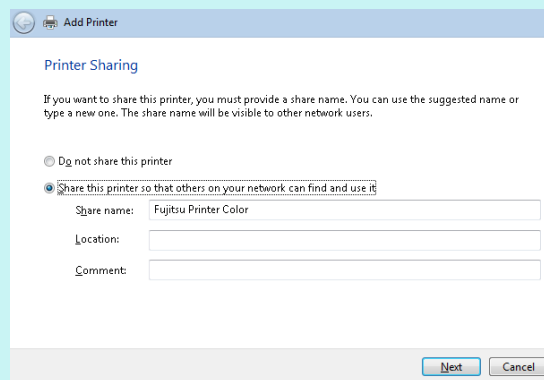

Since the shared name is displayed on the windows of the scanner, it is recommended to name the printer with an alias that indicates the contents of the properties settings as follows.

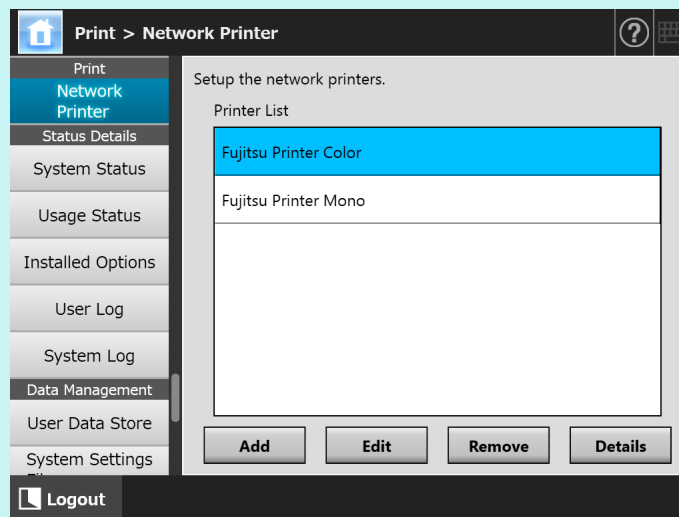

- ⇒ Follow the prompts on the window after this step.
- ⇒ After adding a printer is complete, the printer is added in the [Devices and Printers] window.
- 7. Right-click on the added printer and select [Printer properties].
 - ⇒ Printer properties appear.
- 8. Press the [Printing Defaults] button on the [Advanced] tab.
 - ⇒ The printing defaults window is displayed.
- 9. Select the color mode in the printer settings window.

After this, if the printer set for color printing on the print server is added to the scanner printer list, the user can specify to use this printer already set for color printing.

For details about adding the printer to the scanner printer list, refer to "[Registering a Network Printer \(Network Tree\) \(via the Print Server\)](#)" (page 153) or "[Registering a Network Printer \(Network Path\)](#)" (page 155).

■ **Checking the Printer Name or the IP Address for the Printer (for Direct Printing)**

To check the printer name or the IP address for a network printer, refer to the printer settings on the print server on which the network printer is registered.

- 1. Select [View Devices and Printers] on the control panel window on the print server.**
⇒The [Devices and Printers] window appears.
- 2. Right-click on a printer and select [Printer Properties].**
⇒Printer properties appear.
- 3. Select the port for the network printer in the [Ports] tab, and press the [Configure Port].**
⇒The [Configure Standard TCP/IP Port Monitor] window appears.
- 4. Check the [Printer Name or IP Address] contents.**

■ **Checking the Driver Name for the Printer (for Direct Printing)**

To check the driver name for a network printer, refer to the printer settings on the print server on which the network printer is registered.

- 1. Select [View Devices and Printers] on the control panel window on the print server.**
⇒The [Devices and Printers] window appears.
- 2. Right-click on a printer and select [Printer Properties].**
⇒Printer properties appear.
- 3. Select the [Advanced] tab.**
- 4. Check the [Driver] contents**

■ Registering a Network Printer (Network Tree) (via the Print Server)

1. Select [Network Printer] under [Print].

⇒ The [Network Printer] window appears.

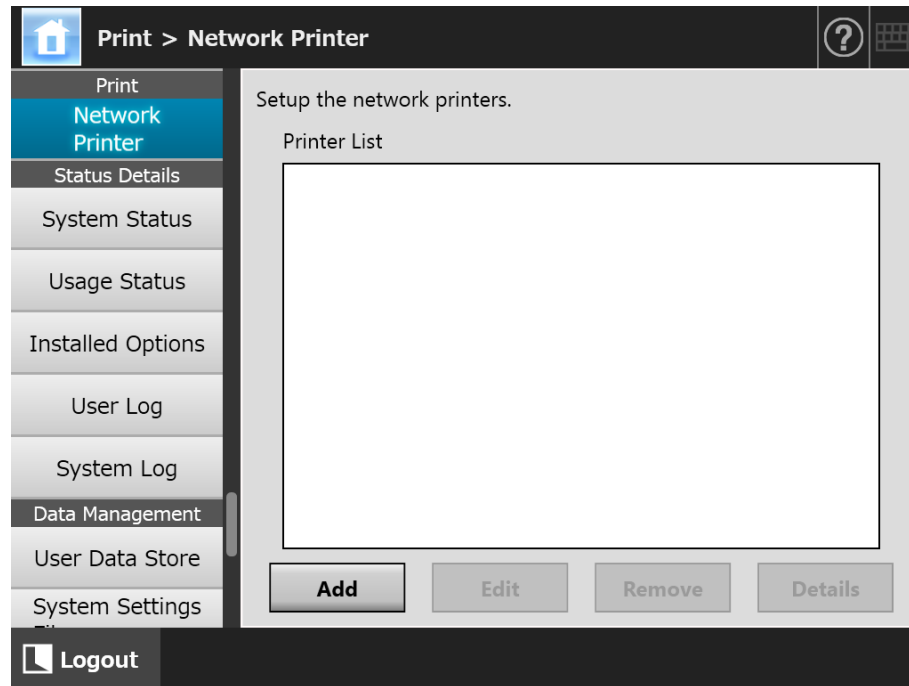

2. Press the [Add] button.

⇒ The window for selecting a network printer appears.

ATTENTION

Some domains may not be shown in the window for selecting a network printer. In this case, directly enter the network printer path name, or wait for a few minutes and re-open the window for selecting a network printer.

3. Select a domain

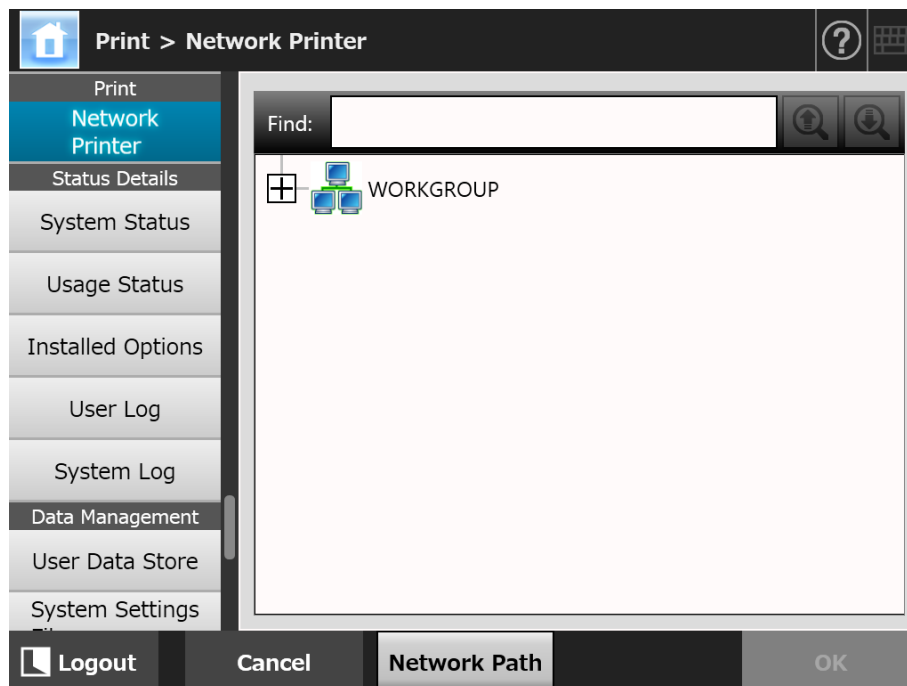

⇒ The network tree expands and the subordinate computer names are displayed. If an authentication window is displayed, enter a user name and password. If authentication is successful, the subordinate computer names are displayed.

4. Select a computer

⇒ The network tree expands and the subordinate network printer names are displayed.

If an authentication window is displayed, enter a user name and password. If authentication is successful, the subordinate network printer names are displayed.

5. Select a network printer

The selected folder will be opened to show any sub-folders, which themselves may be selected in turn (up to seven levels deep, including the parent domain).

6. Press the [OK] button.

⇒ The window returns to the [Network Printer] window, and the registered network printer is added to the network printer list.

HINT

The default network printer alias will be the same as the alias selected from the network tree. For details on changing the network printer alias, refer to "[Changing the Network Printer Settings](#)" (page 157).

■ Registering a Network Printer (Network Path)

1. **Select [Network Printer] under [Print].**
⇒ The [Network Printer] window appears.
2. **Press the [Add] button.**
⇒ The window for selecting a network printer appears.
3. **Press the [Network Path] button.**
⇒ The window for adding a network printer appears.

The screenshot shows a software window titled "Print > Network Printer". On the left is a sidebar menu with items: Print, Network Printer (highlighted), Status Details, System Status, Usage Status, Installed Options, User Log, System Log, Data Management, User Data Store, and System Settings. The main content area is titled "Add a network printer." and contains the following fields:

- Printer Alias:** A text input field. A note below it says: "* If left blank, the share name or 'IP_' + IP address will be used as a printer alias."
- Network Path:** A text input field. An example below it says: "(eg: \\Domain\Computer\Printer)".
- Printer name or IP address for the network printer without print server:** A text input field.
- Driver name for the network printer without print server:** A dropdown menu.

At the bottom of the window are four buttons: "Logout", "Cancel", "Network Tree", and "OK".

4. **Specify each item according to the setting procedure of a network printer.**
 - (a) When registering a shared printer that is connected to a print server as a network printer
Enter a name in [Printer Alias] and a path in [Network Path].
 - (b) When registering a network printer without a print server
 - (b-1) Using the driver for the computer on which a network printer is published
Enter a name in [Printer Alias], a path in [Network Path], and a name or an IP address in [Printer name or IP address for the network printer without print server].
For details about how to check the printer name or the IP address for a printer, refer to "[Checking the Printer Name or the IP Address for the Printer \(for Direct Printing\)](#)" (page 152).

(b-2) Registering a network printer and then selecting a driver for the network printer

Enter a name in [Printer Alias] and [Printer name or IP address for the network printer without print server], and select a driver name in [Driver name for the network printer without print server].

For details about how to check the printer name or the IP address for a printer, refer to ["Checking the Printer Name or the IP Address for the Printer \(for Direct Printing\)" \(page 152\)](#).

For details about how to check the driver name for the printer, refer to ["Checking the Driver Name for the Printer \(for Direct Printing\)" \(page 152\)](#).

HINT

On the touch panel and Admin Tool, you can select the driver name from a list box. On Central Admin Console, since you need to enter the driver name directly, note the driver name in advance.

5. Press the [OK] button.

⇒ The window returns to the [Network Printer] window, and the registered network printer is added to the network printer list.

HINT

- The default network printer alias will be the same as the alias selected from the network tree. For details on changing the network printer alias later, refer to ["Changing the Network Printer Settings" \(page 157\)](#).
- The authentication window may appear.

■ Changing the Network Printer Settings

1. **Select [Network Printer] under [Print].**
⇒ The [Network Printer] window appears.
2. **Select the network printer with the settings that are to be changed.**
3. **Press the [Edit] button.**
⇒ The window for editing the network printer settings appears.
4. **Change the settings.**
5. **Press the [OK] button.**
⇒ The changed settings are applied.

■ Removing a Network Printer

1. **Select [Network Printer] under [Print].**
⇒ The [Network Printer] window appears.
2. **Select the network printer that is to be removed from the printer list.**
3. **Press the [Remove] button.**
⇒ The window for removing a network printer appears.
4. **Confirm the details of the network printer that is to be removed are correct, and press the [Yes] button.**
⇒ The selected network printer is removed from the network printers list.

ATTENTION

- If removing a network printer is attempted while the network is not connected, the process may be stopped while "Deleting" is displayed on the window. Before removing a network printer, check that the network is operating normally.
- If you remove a network printer associated with the printer that is also set as a network printer without a print server, the corresponding driver is removed from the scanner, and as a result the network printer without a print server may not be used.

■ Viewing the Network Printer Details

1. Select [Network Printer] under [Print].

⇒ The [Network Printer] window appears.

2. Select the desired network printer from the printer list.

3. Press the [Details] button.

⇒ The information for the selected network printer is displayed.

The screenshot shows a mobile application interface for configuring network printers. The top navigation bar is dark grey with a home icon, the text 'Print > Network Printer', a help icon, and a keyboard icon. A left sidebar menu contains the following items: 'Print', 'Network Printer' (highlighted in blue), 'Status Details', 'System Status', 'Usage Status', 'Installed Options', 'User Log', 'System Log', 'Data Management', 'User Data Store', and 'System Settings'. At the bottom of the sidebar is a 'Logout' button. The main content area is titled 'Printer details:' and contains the following fields:

- Printer Alias:** A text input field containing 'Fujitsu Printer Color'.
- Network Path:** An empty text input field.
- Printer name or IP address for the network printer without print server:** A text input field containing '192.168.10.100'.
- Driver name for the network printer without print server:** A dropdown menu with 'Fujitsu Printer Driver' selected.

At the bottom right of the screen is a blue 'OK' button.

4.15 Viewing the Scanner Details

4.15.1 Viewing the System Status Touch Panel AdminTool Central Admin Console

1. Select [System Status] under [Status Details].

⇒ The system status information is displayed.

Check the scanner's system information.

| Item | Status |
|--------------------|----------------------------|
| System Version | 44001 01.01.01.0045 541 01 |
| Scanner Version | 0133 |
| Initial Use | 10/14/2014 |
| Cumulative On Time | 00000000 hours |

Logout

4.15.2 Viewing the Usage Status Touch Panel AdminTool

Information about the number of documents that have been scanned and the status of the scanner's consumable parts (roller set) can be viewed. For details about replacing consumable parts, refer to "6.5 Replacing Parts" (page 346).

■ Viewing the Status of Consumable Parts

1. Select [Usage Status] under [Status Details].

⇒ The [Usage Status] window appears.

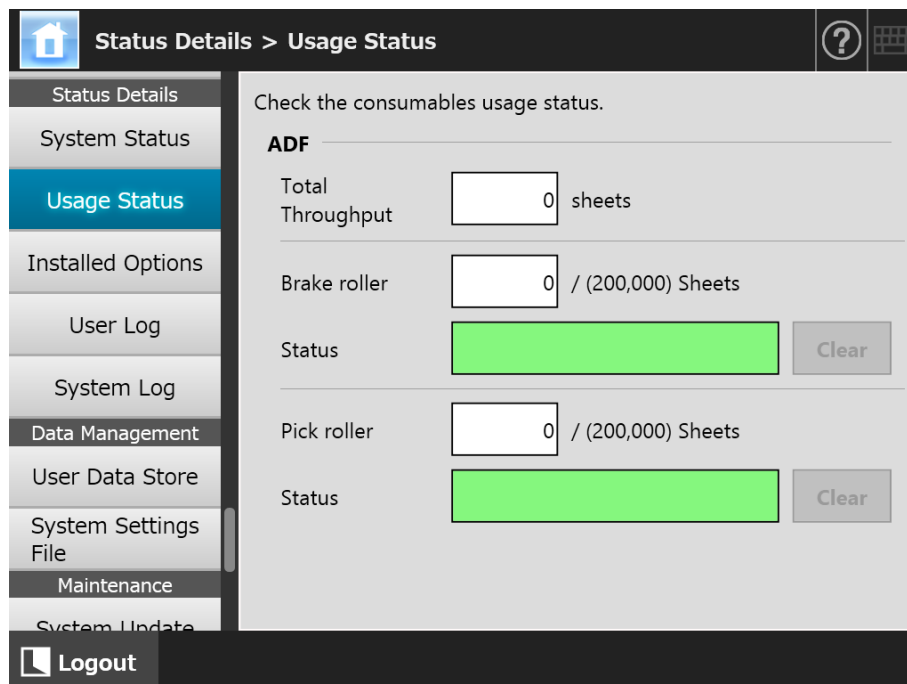

■ Resetting the Usage Counter

After part replacement, the usage counter can be reset to return the part status to normal.

1. Select [Usage Status] under [Status Details].

⇒ The [Usage Status] window appears.

2. Press the [Clear] button for the part replaced.

⇒ The counter reset confirmation window appears.

3. Press the [OK] button.

⇒ The counter value is reset to "0", and the [Status] field turns green again.

4.15.3 Viewing the Status of Installed Options Touch Panel Admin Tool Central Admin Console

1. Select [Installed Options] under [Status Details].

⇒ The [Installed Options] window appears.

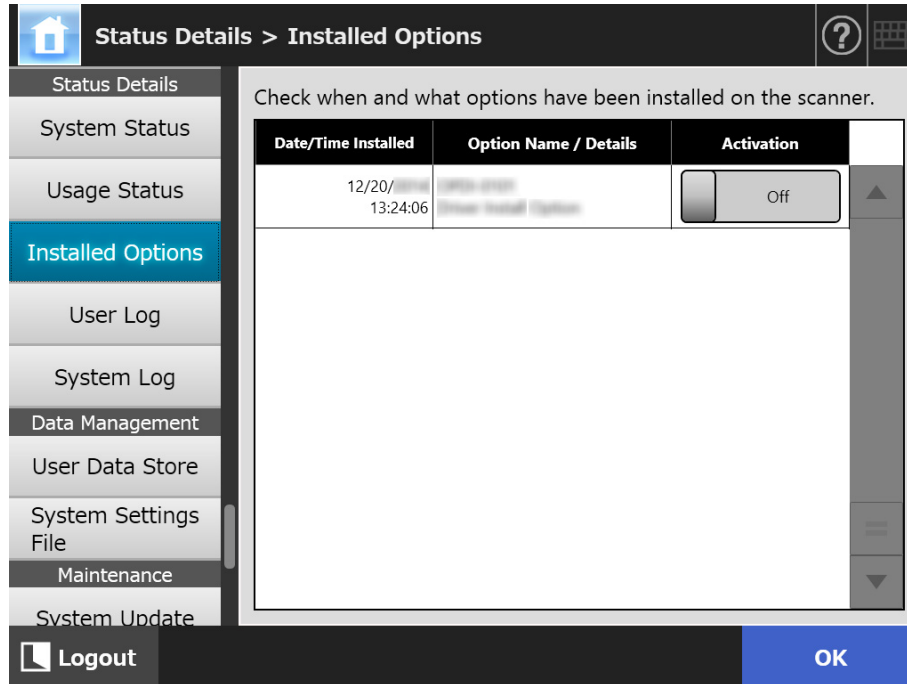

2. To switch the option to enable, select [On] under [Activation] and press the [OK] button.

⇒ Options set to [On] are enabled and can be used.

HINT

Depending on the option that has been installed, switching between enable and disable may not be possible for that option.

4.15.4 Managing the User Log

User log entries are saved in the scanner.

ATTENTION

- User logs may contain private information such as information on e-mail senders and fax numbers, so care should be taken when managing such data.
- If a log file error is detected during scanner operation, the log file will be cleared and the log entry "Error 81001004 Corrupted user log file was deleted." is recorded.

■ Viewing the User Log Details Touch Panel AdminTool

The user log summary is shown in date/time order. Even if the [Region / Timezone] or [Date / Time] settings are changed, the order of the log entries will not be changed.

1. Select [User Log] under [Status Details].

⇒ The [User Log] window appears.

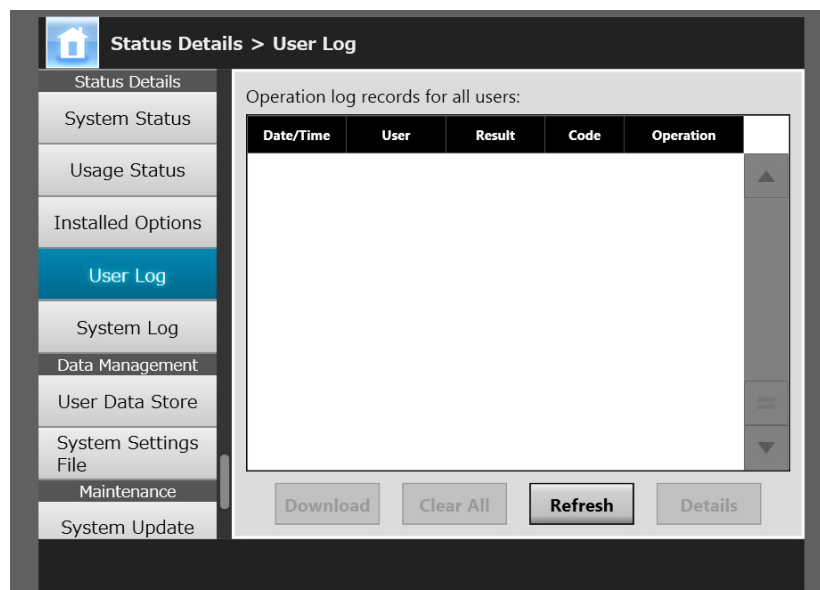

(Example of the Administrator Windows via the Admin Tool)

2. Select the user log you wish to view and press the [Details] button.

⇒ The details of the selected log are displayed.

Pressing the [OK] button returns to the [User Log] window.

HINT

The [Date] format specified on the [Date / Time] window is used. For details, refer to ["4.4.4 Setting the Date/Time" \(page 82\)](#).

■ Downloading the User Logs in CSV Format AdminTool

User logs can be downloaded to a computer in CSV format.

The file is saved in the following format:

"Date","Time","User","Result","Code","Operation","Pages","Description"

The default file name is "OperationLog.csv".

1. Select [User Log] under [Status Details].

⇒ The [User Log] window appears.

2. Press the [Download] button.

⇒ The [File Download] dialog box appears.

3. Press the [Save] button.

HINT

Make sure there is enough free space on the disk where it is to be saved and press the [Save] button. If there is not enough free disk space, an incomplete file may be saved.

⇒ The [Save As] dialog box appears.

4. Enter a file name, and specify a folder for saving the file.

The file will contain CSV format data.

5. Press the [Save] button.

⇒ A file containing CSV format data is saved.

■ Clearing the User Logs Touch Panel AdminTool

1. Select [User Log] under [Status Details].

⇒ The [User Log] window appears.

2. Press the [Clear All] button.

⇒ The confirmation window appears.

3. Press the [Yes] button.

⇒ All the user operation logs are cleared.

4.15.5 Managing the System Log

System information logs (such as for startup, shutdown, and system errors) are saved in the scanner.

ATTENTION

- System logs may contain private information such as information on e-mail senders and fax numbers, so care should be taken when managing such data.
- If a log file error is detected during scanner operation, the log file will be cleared and the log entry "Error 81001003 Corrupted system log file was deleted." is recorded.

■ Viewing the System Log Details Touch Panel AdminTool

The system log summary is shown in date/time order. Even if the [Region / Timezone] or [Date / Time] settings are changed, the order of the log entries will not be changed.

1. Select [System Log] under [Status Details].

⇒ The [System Log] window appears.

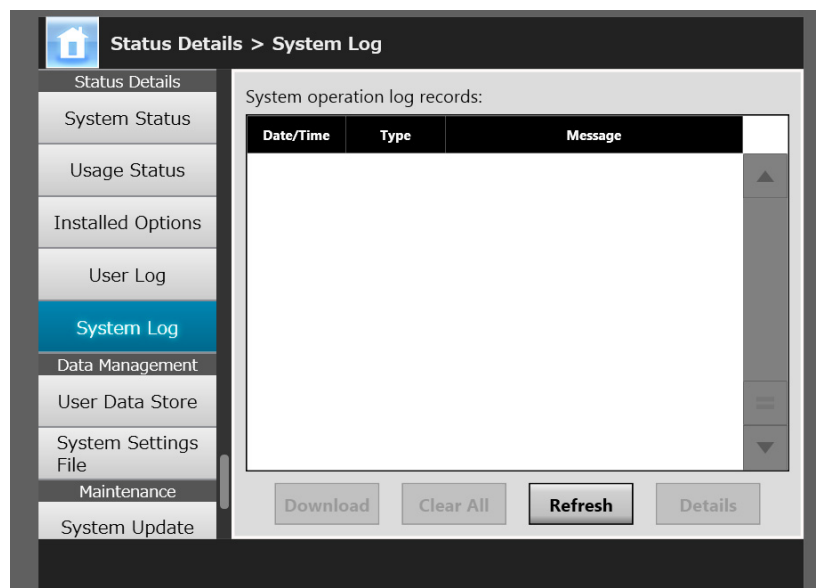

(Example of the Administrator Windows via the Admin Tool)

2. Select the log you wish to view and press the [Details] button.

⇒ The details of the selected log are displayed.

Pressing the [OK] button returns to the [System Log] window.

HINT

- The [Date] format specified on the [Date / Time] window is used. For details, refer to "[4.4.4 Setting the Date/Time](#)" (page 82).
- The information of "Error" and "Warning" in [Type] will be sent to the e-mail address set in "[4.17.6 Setting the Destination for Alert Notifications](#)" (page 183).

■ Downloading the System Log in CSV Format AdminTool

When downloaded to a computer, the file will contain CSV format data.

The file is saved in the following form:

"Date","Time","Type","Message"

The default file name is "SystemLog.csv".

1. Select **[System Log]** under **[Status Details]**.

⇒ The [System Log] window appears.

2. Press the **[Download]** button.

⇒ The [File Download] dialog box appears.

3. Press the **[Save]** button.

HINT

Make sure there is enough free space on the disk where it is to be saved and press the [Save] button. If there is not enough free disk space, an incomplete file may be saved.

⇒ The [Save As] dialog box appears.

4. Enter a file name, and specify a folder for saving the file.

The file will contain CSV format data.

5. Press the **[Save]** button.

⇒ A file containing CSV format data is saved.

■ Clearing the System Log Touch Panel AdminTool

1. Select **[System Log]** under **[Status Details]**.

⇒ The [System Log] window appears.

2. Press the **[Clear All]** button.

⇒ The confirmation window appears.

3. Press the **[Yes]** button.

⇒ The system log is cleared.

4.16 Managing the User Data Store and System Settings

4.16.1 Maintaining the User Data Store

The scanner's user data store can be backed up, restored, and deleted.

The user data store contains the following information:

- "My List" e-Mail Address Books
- Scan Settings
- User Logs
- Fax Number List
- Name of the last network printer used
- Name of the last network folder used
- Name of the last FTP server folder used
- Name of the last SharePoint folder used
- Local Accounts

When a user name registered with the LDAP server is used for login to the scanner, the data is automatically registered on the scanner as user data (data for the same user name is collected as a single user's data).

The user data store may contain up to 1,000 users.

ATTENTION

- Once 1,000 user names have been used to login, new user logins are no longer possible until the entire user data store is cleared.
It is recommended that the user data store be backed up before it is cleared. Refer to ["Backing up the User Data Store" \(page 168\)](#) and ["Clearing the User Data Store" \(page 169\)](#) for details.
- If a current user name existed when the user data store was backed up, the current user data is overwritten when being restored. Addition of new users cannot cause the 1,000 user limit to be exceeded, or the user data store restoration will fail. If this happens, delete all user data once and then restore from a user data store backup.
- When the user data store is restored from a backup, the Fax Number List and local accounts are also reverted to their old state.
- User logs cannot be backed up or restored.

The following example illustrates how the number of users could exceed 1,000:

1. 100 users (A001 to A100) login.
2. The user data store is backed up (with 100 users: A001 to A100).
3. The user data store (containing users A001 to A100) is cleared.
4. 960 "new" users (A001 to A050 and B001 to B910) login.
5. The user data store (containing users A001 to A100) backed up in Step 2 is restored.

4.16 Managing the User Data Store and System Settings

⇒ Users A001 to A100 are to be restored, of whom 50 are already in the current user data store (users A001 to A050) and so will be overwritten. Users A051 to A100 are considered "new" users and thus need to be added to the user data store. However, 960 existing users + 50 new users = 1,010 users. As the number of users would exceed the 1,000 user limit, the data of the 50 users from A051 to A100 is not restored, and therefore the user data from A001 to A100 is not overwritten or restored.

The user data store contents are organized as follows:

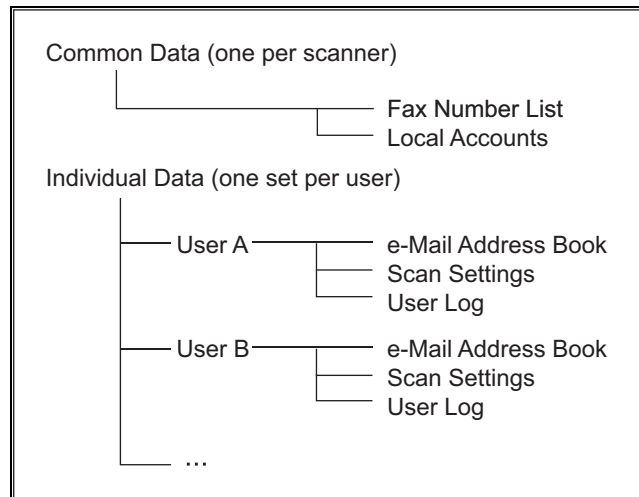

ATTENTION

User data may contain private information such as information on e-mail senders and fax numbers, so care should be taken when managing such data.

■ Backing up the User Data Store AdminTool

As a precaution, the user data store should be backed up regularly. The default file name is "restored_data".

1. Select [User Data Store] under [Data Management].

⇒ The [User Data Store] window appears.

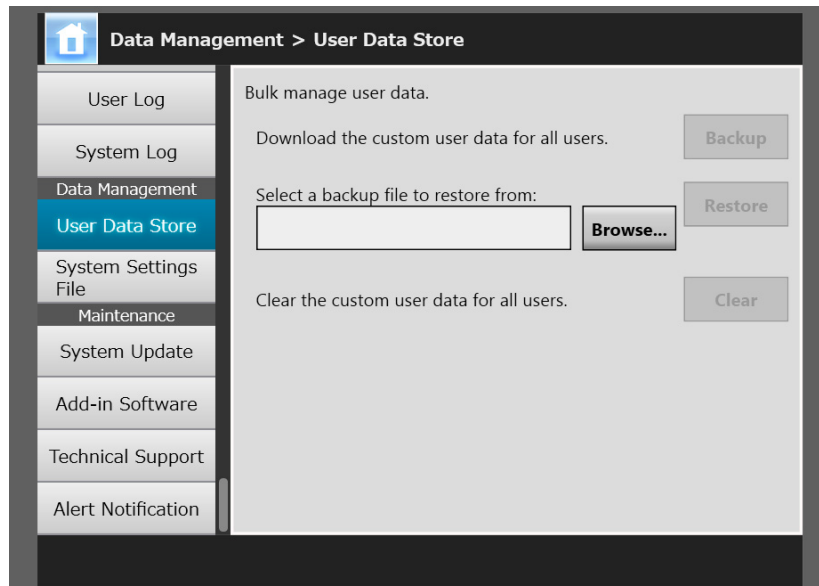

2. Press the [Backup] button.

⇒ The [File Download] dialog box appears.

3. Make sure there is enough free space on the disk where the file is to be saved and press the [Save] button.

HINT

If there is not enough free disk space, an incomplete file may be saved.

⇒ The [Save As] dialog box appears.

4. Enter a file name, and specify a folder for saving the file.

Use of a name that includes the scanner name and backup date is recommended.

5. Press the [Save] button.

⇒ A backup copy of the user data store is saved.

ATTENTION

Do not change the contents of data store backup files.

If changed, the file may be corrupted. Restoring from a corrupted file may cause the scanner to function abnormally.

■ Restoring the User Data Store AdminTool

The scanner's user data store can be restored from a backed-up user data store file.

ATTENTION

- Restoring user data overwrites all user information saved at the time of restoration, and returns all e-mail address books, fax number list, and scan settings to the time the backup was taken.
- During user data restoration, do not hold down the power button for 4 seconds or longer. It may cause the scanner to function abnormally.

1. Select [User Data Store] under [Data Management].

⇒ The [User Data Store] window appears.

2. Press the [Browse] button and select a user data store backup file.

3. Press the [Restore] button.

⇒ An "OK to overwrite?" confirmation message appears.

4. Press the [Yes] button.

⇒ After the user data store is restored, a restore completion message appears.

5. Press the [OK] button.

■ Clearing the User Data Store Touch Panel AdminTool

ATTENTION

- Clearing the user data store cannot be undone.
- Even if the user data store is cleared, the local accounts are not removed. To remove the local accounts, use the User Editor. For details about how to edit the local accounts, refer to ["F.7 Editing Local Accounts" \(page 444\)](#).

1. Select [User Data Store] under [Data Management].

⇒ The [User Data Store] window appears.

2. Press the [Clear] button.

⇒ The delete confirmation window appears.

3. Press the [Yes] button.

⇒ The user data store is cleared.

4.16.2 Maintaining the System Settings

The scanner's system settings set by the administrator can be saved in CSV format, backed up, restored, or returned to their factory default values.

The system settings refer to the information that is set by the administrator in each window. However, the system settings do not contain the information about the system updates, options and Add-ins that are installed by the administrator.

■ Downloading the System Settings in CSV Format AdminTool

System settings downloaded in CSV format may be viewed by using spreadsheet software.

CSV system settings files are of the following format:

"Function_name", "Option_name", "Value"

The default file name is "Configuration_download.csv".

1. Select [System Settings File] under [Data Management].

⇒ The [System Settings File] window appears.

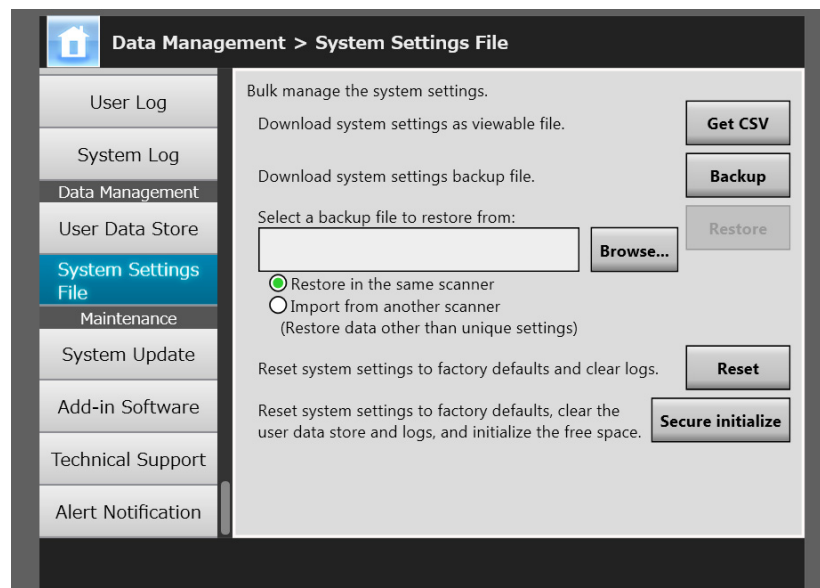

2. Press the [Get CSV] button.

⇒ The [File Download] dialog box appears.

3. Make sure there is enough free space on the disk where the file is to be saved and press the [Save] button.

HINT

If there is not enough free disk space, an incomplete file may be saved.

⇒ The [Save As] dialog box appears.

4. Name the file and specify where it should be saved.

The file will contain CSV format data.

5. Press the [Save] button.

⇒ The system settings for the scanner are downloaded.

■ Backing up System Settings AdminTool

The administrator can back up the scanner system settings.

Backup files can later be used to restore system settings. Make backups periodically just in case.

The default file name is "SystemSettingsFile".

HINT

The backed up data can be used in [Import Scanner Settings] in the scanner settings edit window of the Central Admin Console. For the operations, refer to the Scanner Central Admin User's Guide.

1. Select [System Settings File] under [Data Management].

⇒ The [System Settings File] window appears.

2. Press the [Backup] button.

⇒ The [File Download] dialog box appears.

3. Make sure there is enough free space on the disk where the file is to be saved and press the [Save] button.**HINT**

If there is not enough free disk space, an incomplete file may be saved.

⇒ The [Save As] dialog box appears.

4. Name the file and specify where it should be saved.

It is recommended that you specify the file name based on the backup date and the scanner name so that you can identify this information easily.

5. Press the [Save] button.

⇒ The system settings are backed up.

ATTENTION

Do not change the contents of system settings backup files. If changed, the file may no longer be used as a backup. Trying to restore from a changed user data store backup file may cause the scanner to function abnormally.

■ Restoring the System Settings AdminTool

The backed-up system settings can be restored.

The system settings can be restored in the following ways.

- Return the system settings backup file to the same scanner
- Import the system settings backed up from another scanner to the current scanner

1. Select **[System Settings File]** under **[Data Management]**.

⇒ The **[System Settings File]** window appears.

2. Press the **[Browse]** button and select the backup file of the system settings to be restored.

3. Perform either of following operations:

- To return the system settings backup file to the same scanner, select **[Restore in the same scanner]**.
- To import the system settings backed up from another scanner to the current scanner, select **[Import from another scanner]**.

4. Press the **[Restore]** button.

⇒ A confirmation message appears.

5. Press the **[Yes]** button.

⇒ The system settings are restored. After the system settings are restored, the scanner is restarted.

ATTENTION

During system settings restoration, do not hold down the power button for 4 seconds or longer.

It may cause the scanner to function abnormally.

HINT

The network interface connection will be lost when the scanner is restarted to complete the restoration of the system settings. To continue with other settings, wait a short time for the scanner to restart, then access the scanner via the Admin Tool again.

If the backed up IP address and scanner name are different from the IP address and scanner name before restoration, check the settings on the scanner, and try reconnecting with the Admin Tool.

■ Resetting to Factory Defaults Touch Panel Admin Tool

The system settings, which are set by the administrator in each window, and the system logs can be reset to factory defaults.

1. Select [System Settings File] under [Data Management].

⇒ The [System Settings File] window appears.

2. Perform either of following operations:

- To reset system settings to factory defaults, press the [Reset] button for [Reset system settings to factory defaults and clear logs.].
- To reset system settings to factory defaults, clear the user data store and logs, and initialize the free space, press the [Secure initialize] button for [Reset system settings to factory defaults, clear the user data store and logs, and initialize the free space.].

⇒ A confirmation message appears.

3. Press the [Yes] button.

⇒ If the [Reset] button is pressed, the system settings are reset to factory defaults, and Add-ins and logs are cleared.

If the [Secure initialize] button is pressed, the system settings, user data store, Add-ins, and logs are reset, and the free space is initialized.

⇒ After factory default settings have been restored, the scanner is restarted.

ATTENTION

- During factory defaults reset, do not hold down the power button for 4 seconds or longer. It may cause the scanner to function abnormally.
- The [Secure initialize] process takes about 40 minutes. Note that you cannot cancel the initialization during the process.

HINT

After the factory default settings are restored, the scanner name, IP address, and other settings will need to be set again, as described in ["4.4 Configuring the System" \(page 78\)](#) and after.

4.17 Maintaining the System

4.17.1 Updating the Scanner's System Software AdminTool

The scanner system, security system, and installed options can be updated as follows. Download the update file on a computer from the following web page:

<http://www.fujitsu.com/global/support/products/computing/peripheral/scanners/fi/software/>

1. Select [System Update] under [Maintenance].

⇒ The [System Update] window appears.

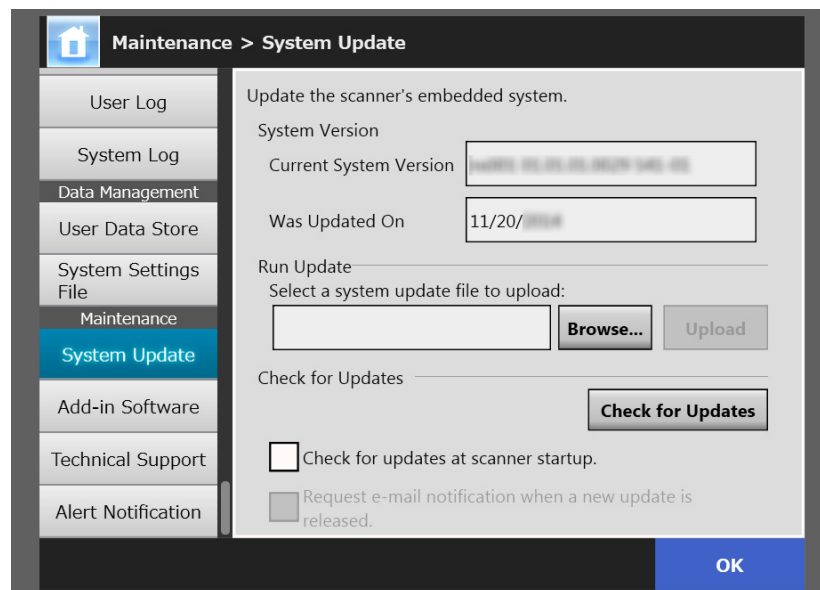

2. Press the [Browse] button and select a system update file.

3. Press the [Upload] button.

⇒ The [Current System Version] and [New System Version] values are displayed.

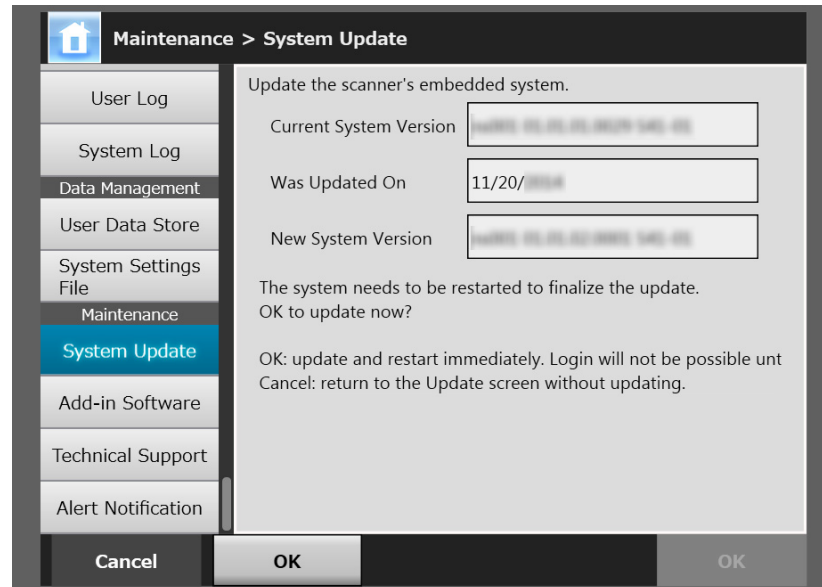
**HINT**

When you update installed options or the system including these options, the following window appears:

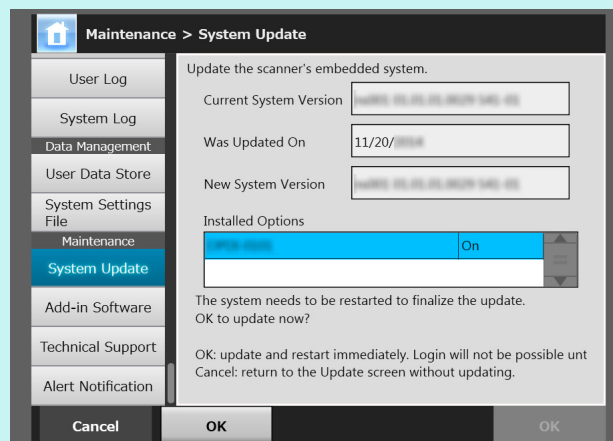
**4. Press the [OK] button.**

⇒ The system update process is started.

After the system has been updated, the scanner is restarted.

ATTENTION

- Wait for the system to restart.
- During system update, do not hold down the power button for 4 seconds or longer. It may cause the scanner to function abnormally.

HINT

The connection with the scanner is lost if the scanner's system software is updated via the Admin Tool. To continue with other settings, wait a short time for the scanner to restart, then access the scanner via the Admin Tool again.

4.17.2 Checking for New Updates Touch Panel AdminTool

You can check whether new updates are available from the published server for the scanner system, security system, and installed options. You can also set whether to receive an e-mail notification if a new update is released.

HINT
To use the proxy server to check for released updates, set the HTTP proxy server as necessary. For details, refer to "4.7.5 Setting the Proxy Server" (page 104).

■ Checking for New Updates Manually

1. Select [System Update] under [Maintenance].

⇒ The [System Update] window appears.

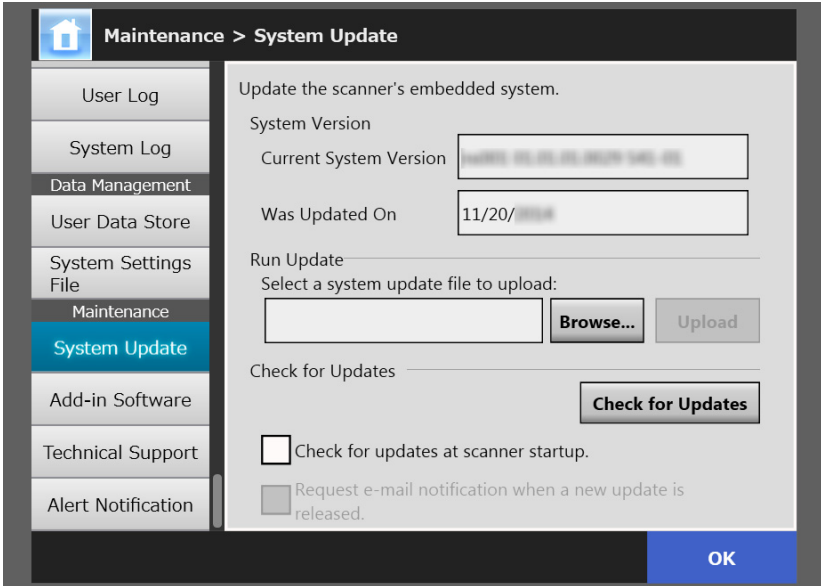

(Example of the Administrator Windows via the Admin Tool)

2. Press the [Check for Updates] button.

⇒ Checking for new updates is performed. When a necessary update is available, a message is displayed. Apply the update as necessary.

■ Checking for Updates at Scanner Startup

You can set the function for automatically checking for updates each time the scanner is started.

1. **Select [System Update] under [Maintenance].**

⇒ The [System Update] window appears.

2. **Select the [Check for updates at scanner startup.] check box.**

HINT

Checking for new updates is also performed when the scanner enters standby mode.

■ Requesting e-Mail Notification When a New Update is Available

The administrator can set to receive an e-mail notification if a new update is released.

1. **Select [System Update] under [Maintenance].**

⇒ The [System Update] window appears.

2. **Select the [Check for updates at scanner startup.] check box.**

3. **Select the [Request e-mail notification when a new update is released] check box.**

⇒ When a new update is released, an e-mail entitled "Event notification from Network Scanner *Scanner_Name*" is sent to the e-mail address that is set in the [Alert Notification] window. For details about the e-mail address settings for alert notification, refer to "[4.17.6 Setting the Destination for Alert Notifications](#)" (page 183).

4.17.3 Maintaining Add-in Modules

An "Add-in" is an application created by using the SDK (development kit). In the [Add-in Software] window, the following operations are available:

- Installing an Add-in module
- Uninstalling an Add-in module
- Viewing the Add-in status
- Uploading an Add-in settings file
- Setting whether to show the keyboard icon when running an Add-in

■ Installing an Add-in Module AdminTool

Up to six Add-in modules can be installed.

1. Select [Add-in Software] under [Maintenance].

⇒ The [Add-in Software] window appears.

2. Press the [Install] button.

⇒ The window for specifying an Add-in appears.

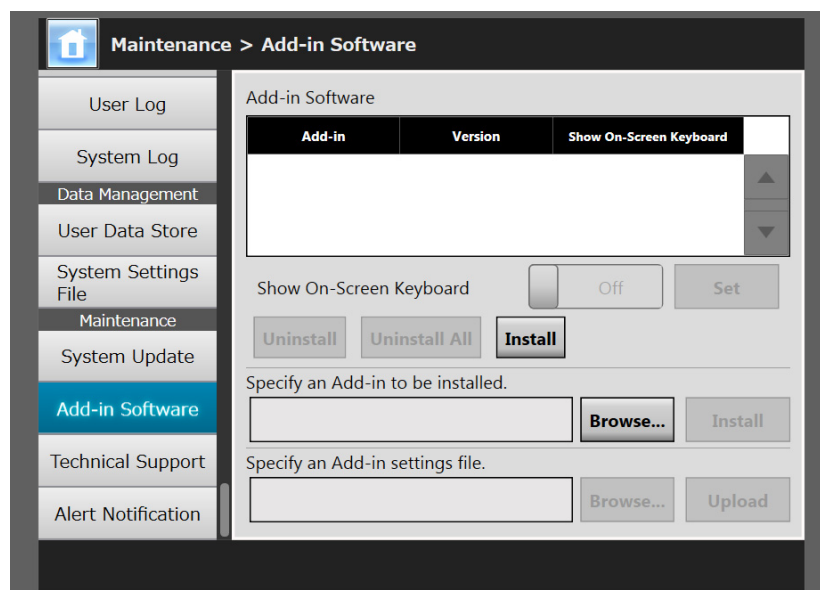

3. Press the [Browse] button for [Specify an Add-in to be installed.] and specify an Add-in installation file.

4. Press the [Install] button.

⇒ The Add-in module is installed, and the Add-in name is displayed in the list.

■ Uninstalling an Add-in Module AdminTool

1. Select [Add-in Software] under [Maintenance].

⇒ The [Add-in Software] window appears.

2. Perform either of following operations:

- To uninstall one Add-in module, select the Add-in module from the list and press the [Uninstall] button.
- To uninstall all Add-in modules listed, press the [Uninstall All] button.

⇒ A confirmation message appears.

3. Press the [Yes] button.

⇒ The Add-in module is uninstalled, and the Add-in name is removed from the list.

■ Viewing the Add-in Status Touch Panel AdminTool

If an Add-in module has been installed, its information can be viewed.

1. Select [Add-in Software] under [Maintenance].

⇒ The [Add-in Software] window appears.

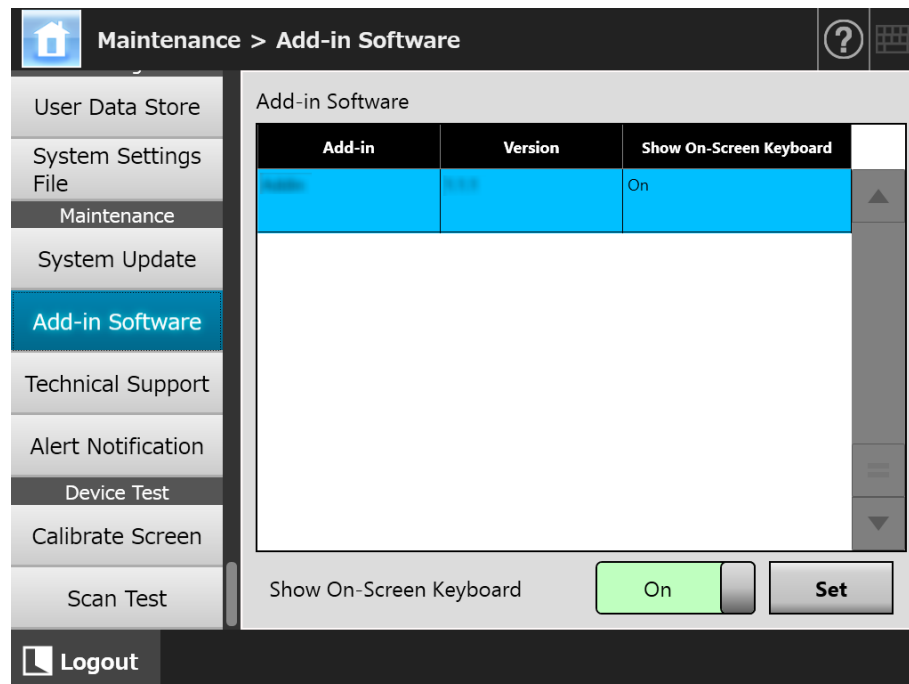

■ Uploading an Add-in Settings File

1. **Select [Add-in Software] under [Maintenance].**
 - ⇒ The [Add-in Software] window appears.
2. **Press the [Install] button.**
 - ⇒ The window for specifying an Add-in appears.
3. **Press the [Browse] button for [Specify an Add-in settings file.] and specify the Add-in settings file to be uploaded.**
4. **Press the [Upload] button.**
 - ⇒ The specified Add-in settings file is saved in the folder that is used for managing the scanner Add-in modules.

■ Setting Whether to Show the Keyboard Icon When Running an Add-in

The keyboard icon is shown in the top right corner of the touch panel. You can set whether to show these icons on the window when running an Add-in.

1. **Select [Add-in Software] under [Maintenance].**
 - ⇒ The [Add-in Software] window appears.
2. **When multiple Add-ins are installed, select the target Add-in from the list.**
3. **For [Show On-Screen Keyboard], select whether or not to show the on-screen keyboard when running an Add-in.**
4. **Press the [Set] button.**
 - ⇒ This setting is reflected in the Add-in list.

4.17.4 Setting the Information Output Level Touch Panel AdminTool

1. Select [Technical Support] under [Maintenance].

⇒ The [Technical Support] window appears.

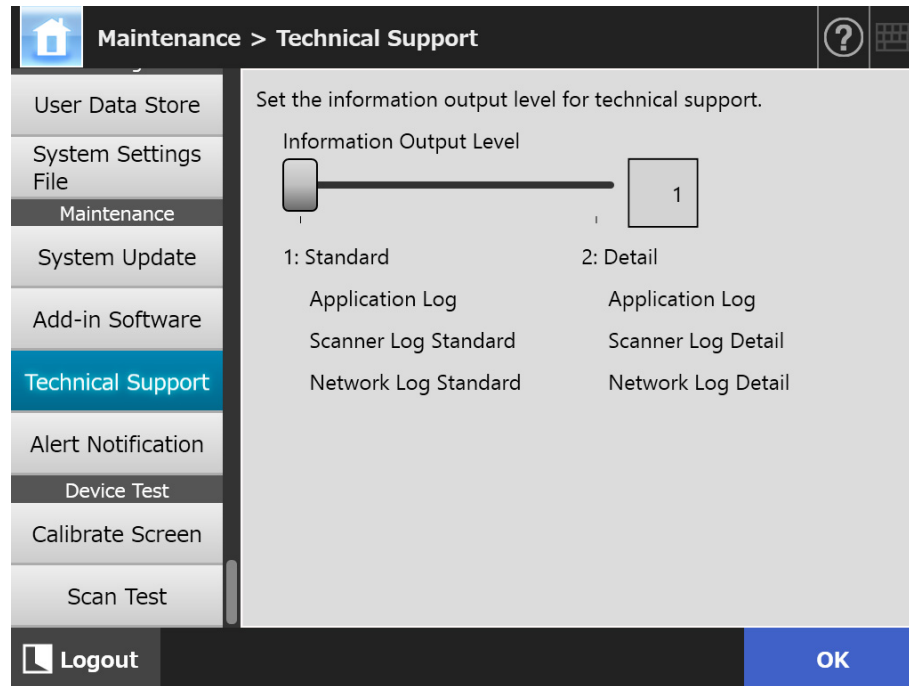

2. Set the desired information output level.

Set the level requested by your FUJITSU scanner dealer or an authorized FUJITSU scanner service provider.

3. Press the [OK] button.

⇒ The information entered is set.

ATTENTION

- Technical support information contains private user information such as e-mail addresses, so care should be taken when managing such data.
- Information that is appropriate for the selected level is applied to technical support information after [Information Output Level] is changed. Obtain technical support information after an error of which you want to find out the cause occurs. For details about how to obtain technical support information, refer to "[4.17.5 Obtaining Technical Support](#)" (page 182).

4.17.5 Obtaining Technical Support AdminTool

If any problems occur when setting up or using the scanner, technical support information can be collected to help determine the cause of the problem.

When the scanner is sent for repair, the information collected should also be sent to your FUJITSU scanner dealer.

1. Select [Technical Support] under [Maintenance].

⇒ The [Technical Support] window appears.

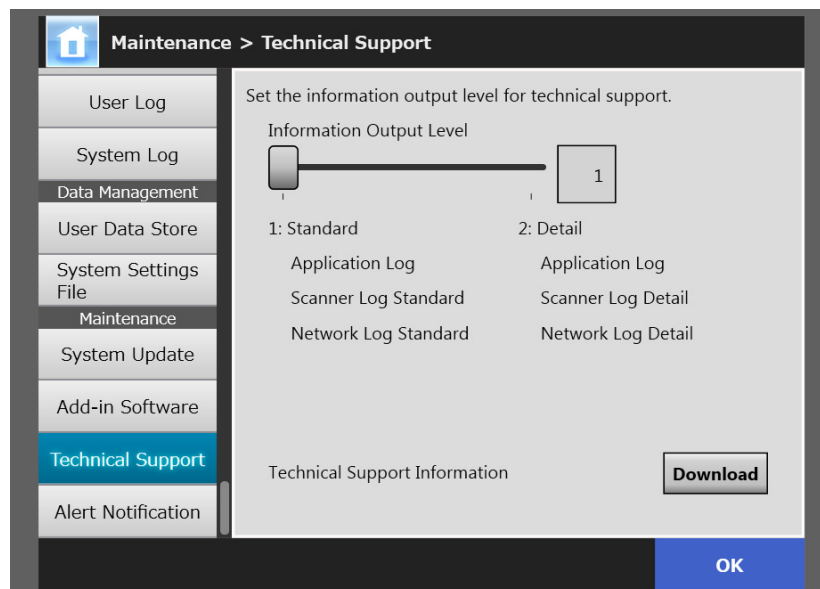

2. Press the [Download] button.

⇒ The [File Download] dialog box appears.

3. Press the [Save] button.

HINT

Make sure there is enough free space on the disk where it is to be saved and press the [Save] button. If there is not enough free disk space, an incomplete file may be saved.

⇒ The [Save As] dialog box appears.

4. Name the file and specify where it should be saved.

5. Press the [Save] button.

⇒ The technical information is downloaded.

4.17.6 Setting the Destination for Alert

Notifications Touch Panel Admin Tool Central Admin Console

An alert notification can be sent by e-mail whenever a scanner alert situation occurs. This section describes how to specify an e-mail address as the destination for alert notification. When the destination for alert notification is set, an alert notification message is sent to the registered e-mail address entitled "Network Scanner (XXXX) Error" if an error occurs on the scanner.

The SMTP server needs to be set in advance so that alert notification can be used. For details about how to specify SMTP server settings, refer to ["4.11.1 Setting the SMTP Server" \(page 125\)](#).

The e-mail address set in this section is also used as the destination for the new update release notification when update check is performed. For details about update check, refer to ["4.17.2 Checking for New Updates" \(page 176\)](#).

1. Select [Alert Notification] under [Maintenance].

⇒ The [Alert Notification] window appears.

2. Enter recipient and sender e-mail addresses.

For details about e-mail address settings values, refer to ["B.1 e-Mail Address Setting Values" \(page 402\)](#).

3. To confirm that the entered e-mail address is valid, press the [Test] button.

Check that the test mail successfully arrives at the expected e-mail address.

4. To perform SMTP authentication, for [SMTP Server Authentication], specify the user authentication information to be used for sending e-mail.

ATTENTION

To perform the SMTP authentication, enable SMTP authentication and configure the required settings for the authentication in the [SMTP Server] window. For details, refer to "[4.11.1 Setting the SMTP Server](#)" (page 125).

5. Press the [OK] button.

⇒ The information entered is set.

4.17.7 Getting a Screenshot on the Touch Panel

The image of the window displayed on the touch panel can be received via the network and saved in BMP or JPEG format.

1. **Access the scanner from Internet Explorer by specifying the scanner name in a URL to display the download window.**

For details about how to display the download window, refer to "[3.2 Showing the Software Download Window](#)" (page 60).

2. **Press the [Next] button for [Screenshot].**

⇒ A window is displayed for getting a screenshot of the current screen on the touch panel.

3. **Press the [Get Screenshot] button.**

⇒ A screenshot of the current window on the touch panel is acquired and displayed.

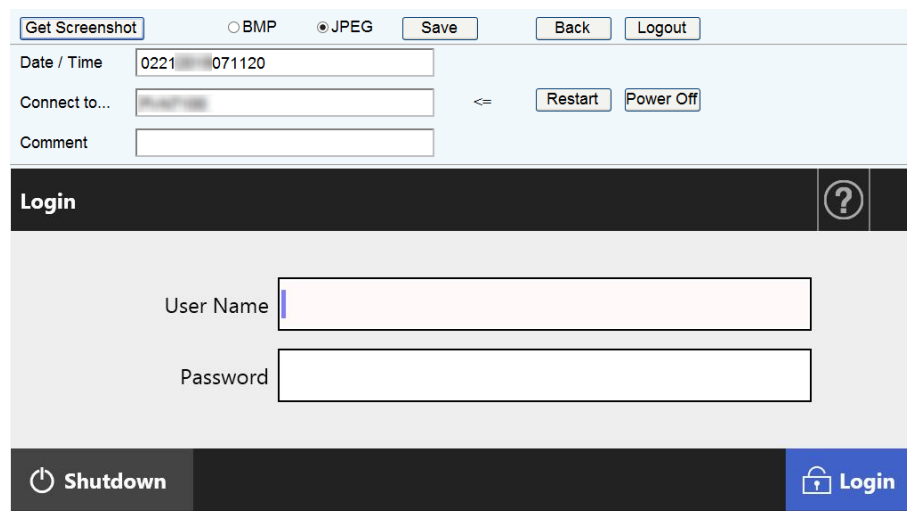

The screenshot shows a web interface for capturing a screenshot. At the top, there is a 'Get Screenshot' button, radio buttons for 'BMP' and 'JPEG' (with 'JPEG' selected), and buttons for 'Save', 'Back', and 'Logout'. Below this, there are input fields for 'Date / Time' (containing '0221 071120'), 'Connect to...' (containing a blurred IP address), and 'Comment'. To the right of the 'Connect to...' field are buttons for '<=>', 'Restart', and 'Power Off'. A dark 'Login' bar is present below the input fields, with a question mark icon on the right. Underneath the login bar are two input fields: 'User Name' and 'Password'. At the bottom, there is a dark bar with a 'Shutdown' button (power icon) on the left and a blue 'Login' button (lock icon) on the right.

4. **Select a file format (BMP or JPEG) of the image of the screenshot to be saved.**

5. When you refer to a date/time, the scanner as the connection destination, or a comment to define a file name for the file to be saved, enter a proper string for the file name in the relevant input field.

Alphanumeric characters, and symbols with the exception of "\ / : ; * ? " < > | # & %" can be used.

To use characters of a different language for a file name, enter them into the [Save As] dialog box.

HINT

If you enter [Date / Time], [Connect to], and [Comment], file names are created in the following order.

- Comment
- Connect to
- Date / Time

- The default values are as follows:
Date / Time: Date/time that the screenshot was taken
Connect to: Scanner name
Comment: (blank)
- The default file name when a screen is saved is one of the following:
 - *Comment_Connect to_Date/Time.bmp*
 - *Comment_Connect to_Date/Time.jpg*
 If nothing is entered for Comment, it becomes "NSScreenShot".
 - *NSScreenshot_Connect to_Date/Time.bmp*
 - *NSScreenshot_Connect to_Date/Time.jpg*

6. Press the [Save] button.

⇒ The [File Download] dialog box appears.

7. Press the [Save] button.

⇒ The [Save As] dialog box appears.

8. Enter a file name, and specify a folder for saving the file.

9. Press the [Save] button.

⇒ The screenshot is saved in a specified file format.

HINT

Press the [Power Off] button to turn the scanner off.

Press the [Restart] button to restart the scanner.

The scanner cannot be turned off or restarted when a regular user or administrator is logged into the connected scanner. If login was performed with automatic login, the scanner can be turned off or restarted while the [Main Menu] or [Job Menu] window is shown.

4.18 Setting a Job Sequence

After the job sequence, job menu, and job group settings are performed on the job settings menus, a regular user can use each assigned job menu at login, and process a job.

1. Setting a job sequence

A job sequence is a single operation that pulls together several user operations (e-Mail/Fax/Print/Save) according to the settings on the [Scan Settings] window. For example, the operation of sending scanned data by e-mail and then saving it in a folder can be set as a single job sequence.

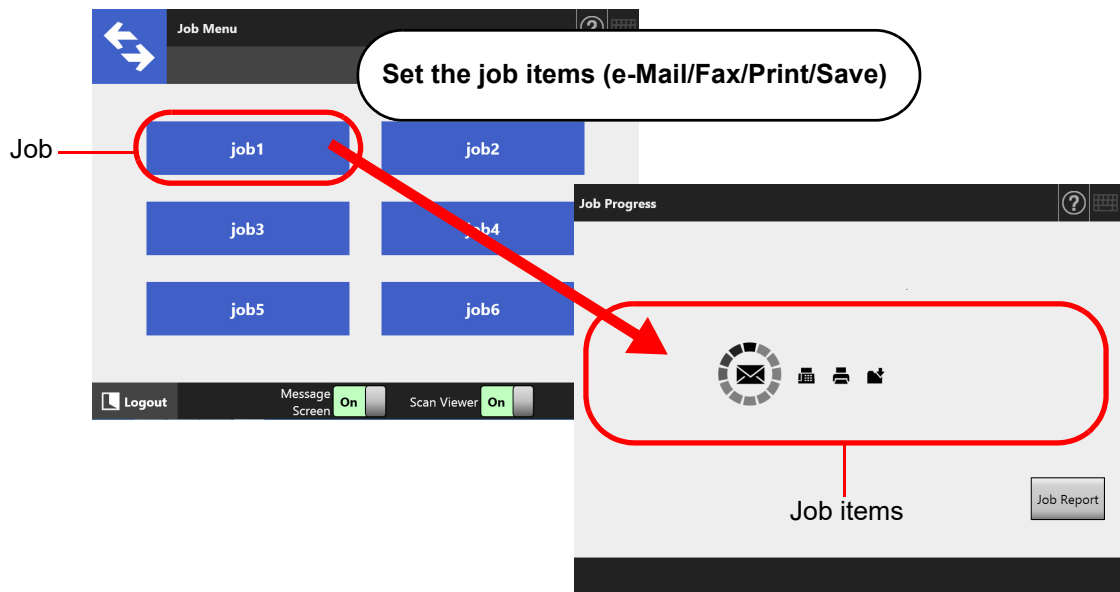

2. Job Menu Settings

A job menu is a menu arrangement of the job sequences set by the user. For example, you can assign a job sequence that sends scanned data by e-mail and then saves it in a folder as a button, and set it on a [Job Menu].

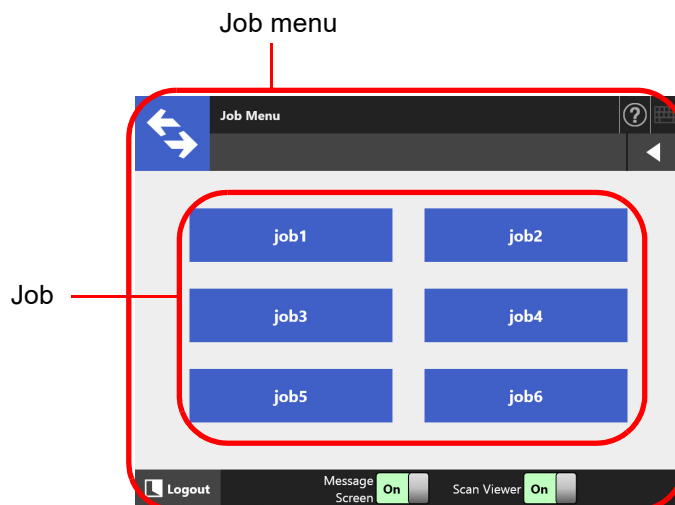

3. Job Group Settings

A job group is a group of users assigned with the same job menu.

You can set a job menu to be shared by users who belong to the same job group.

Set a job menu as a default job group to be used by users who do not belong to any job groups.

For example, job menu A is assigned to group A, and job menu D is assigned to the default group. User C is included in group A, therefore can use job menu A. Users not included in a job group are able to use job menu D.

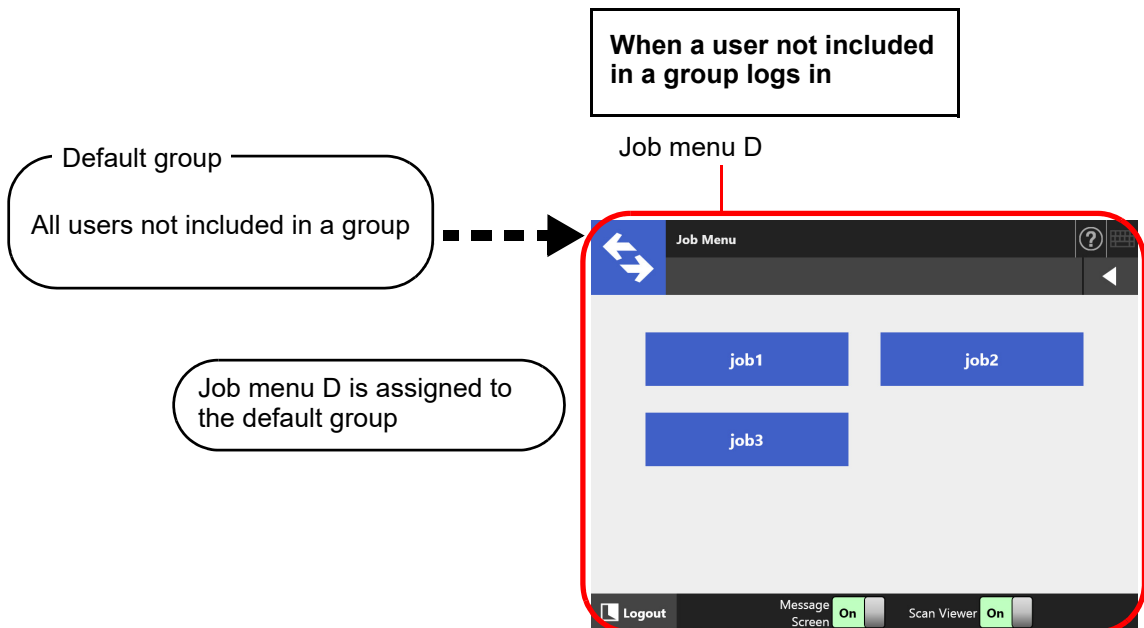
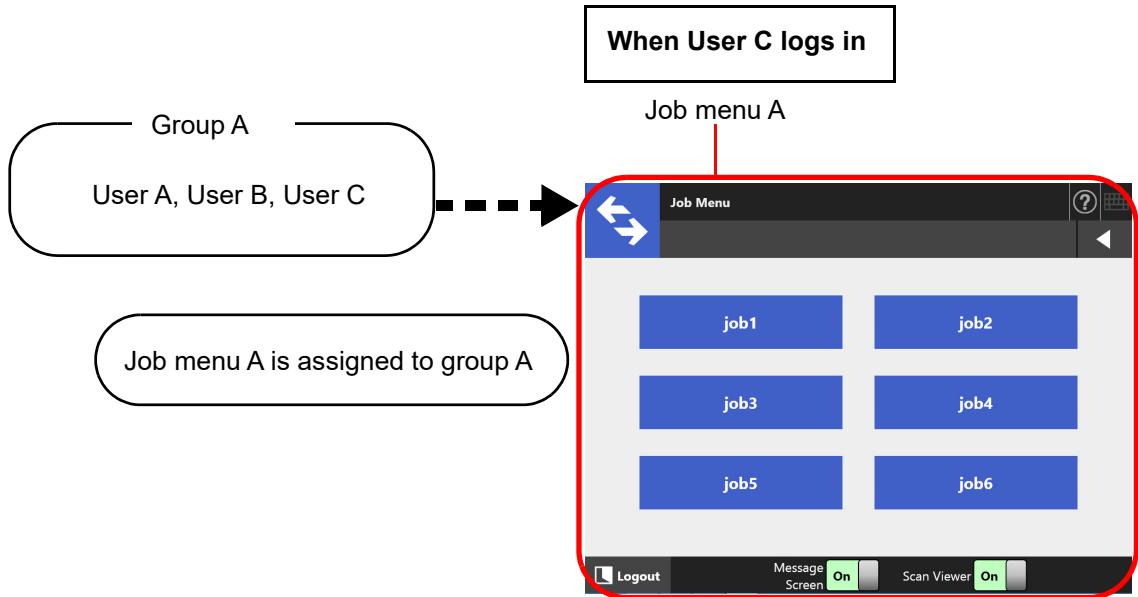

4.18.1 Job Setting Quick User Guide

The procedure for an administrator to set up job is shown below.

Setting a job sequence

Jobs List

View, add to, or edit the Jobs List.

Job Details

Set the scan options, message screen, and operations after scanning for a selected job.

For details, refer to ["4.18.2 Setting a Job Sequence"](#) (page 191).

Setting a job menu

Job Menus List

View, add to, or edit the Job Menus List.

Job Menu Layout

Set the job button for the selected job menu.

For details, refer to ["4.18.3 Setting a Job Menu"](#) (page 201).

Setting a job group

Job Groups List

View, add to, or edit the Job Groups List.

Settings For Selected Group(s)

Set the assigned job menus, initial post-login menu, and job group members for the selected job group.

For details, refer to ["4.18.4 Setting a Job Group"](#) (page 206).

Processing a job

- By setting [On] for [Job Mode] on the [Scanner Central Admin Server] window, which is displayed by selecting [Scanner Central Admin Server] under [Network Admin], and releasing job mode settings on the [Job Mode Settings] window of Central Admin Console, the job mode settings set on the job mode edit window, which is displayed by pressing the [Job Mode Settings] button, are executed.
- By setting [Off] for [Job Mode] on the [Scanner Central Admin Server] window, which is displayed by selecting [Scanner Central Admin Server] under [Network Admin], the jobs set on the job settings menus in the Admin Tool are executed.

For details, refer to ["5.13 Processing a Job" \(page 324\)](#).

4.18.2 Setting a Job Sequence Admin Tool Central Admin Console

Set the scan options and job item (e-Mail/Fax/Print/Save) to be processed together as a job sequence.

Up to 1,000 job sequences can be set.

HINT

For details about displaying the window for setting a job sequence via Central Admin Console, refer to the Scanner Central Admin User's Guide.

■ Adding a Job Sequence

This section describes how to add a job sequence.

1. Press the **[Job Menu Settings]** button on the **Tool Menu**.
2. Press the **[Job Sequences]** tab.
 - ⇒ The **[Jobs List]** window appears.

| Job Name | Comment | Last Modified |
|----------|---------|---------------|
|----------|---------|---------------|

3. Press the **[New]** button.
 - ⇒ The **[Job Details]** window appears.
4. Set **[Job Name]** and **[Comment]**.

5. Press  to the left of [Common Settings], and set the operations for when a job is processed.

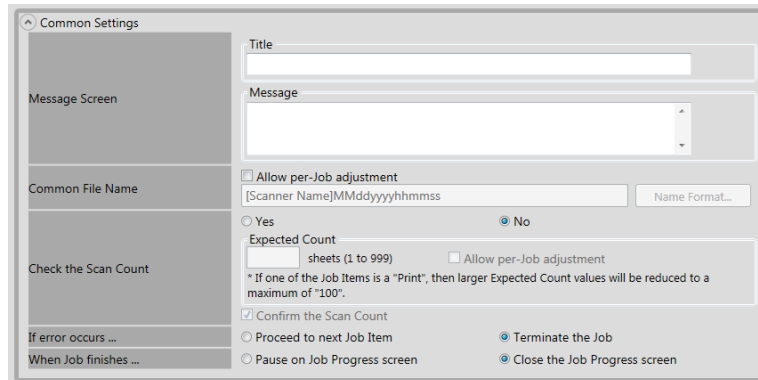
ATTENTION

The layout of the message displayed in the message screen settings, and the actual [Message Screen] layout on the scanner may differ. Check the message layout on the scanner, and set the message.

HINT

Press the [Name Format] button to specify a [Common File Name] on the [File Names (Common)] window.
[Sub-folder Name Format] is enabled only when scanned data is saved to a folder. For details about setting values, refer to ["4.13.4 Setting a File Name Format for When Saving Scanned Data"](#) (page 144).

6. Press  to the left of [Scan Settings].

For details about [Separation] in [Save], refer to "Splitting an Output File" (page 200). For other settings, refer to "5.8 Setting the Scan Options" (page 264).

The screenshot displays the 'Scan Settings' dialog box, organized into several sections:

- Save:**
 - File Format:** Radio buttons for PDF (selected), PDF/A, TIFF, and JPEG.
 - Separation:**
 - Radio buttons for Multiple pages (selected) and Single page.
 - Separation Mode: None (dropdown).
 - Number of pages: 1 Page (input field).
 - Patch code: (input field).
 - Remove separator: (checkbox).
 - File Name: Radio buttons for Separator (selected), Separator and Document Counter, and Document Counter.
 - Text Recognition:**
 - Searchable PDF: Radio buttons for No (selected) and Yes.
 - OCR Highlighted Text Recognition: No (dropdown).
 - Edit OCR Highlighted Text: Radio buttons for No (selected) and Yes.
 - Text Recognition Language: English (dropdown).
 - Text Recognition for Pages: First Page (dropdown), Pages... (input fields).
 - PDF Password:** Radio buttons for Off (selected) and On. Includes Password and Confirm Password input fields.
 - Compression:** Input field with value 4. Radio buttons for High Compression for Color PDF: No (selected) and Yes.
- Basic:**
 - Paper Source:** Radio buttons for Feeder (Single Side) and Feeder (Both Sides) (selected).
 - Paper Size:** Automatic (dropdown). Custom... (input field). Width: 2 inch (2.000 to 8.500) and 50.8 mm (50.8 to 215.9). Length: 2 inch (2.000 to 125.000) and 50.8 mm (50.8 to 3175.0).
 - Document Feed Direction:** Radio buttons for Face-down (selected) and Face-up.
 - Carrier Sheet:** Radio buttons for Off (selected), A3, B4 (JIS), and Double Letter.
 - Image Mode:** Radio buttons for Automatic (selected), Color, Grayscale, and Black & White. Sensitivity: 0 (-7 to 7).
 - Resolution:** 200dpi (dropdown). 200 dpi (50 to 600) (input field).
 - Thresholding:** Sensitivity: 0 (-50 to 50). Thresholding (background): 0 (-50 to 50).
 - Control Image Tone:** Automatic (dropdown). Brightness: 128 (1 to 255). Contrast: 128 (1 to 255). Shadow: 10 (0 to 254). Highlight: 230 (1 to 255). Gamma: 1.6 (0.1 to 10.0).
 - Cleanup:**
 - Sharpness: None (dropdown).
 - Level: 1 (input field).
 - Color Cleanup: None (dropdown).
 - Cleaness: 0 (-5 to 5) (input field).
 - Character Thickness: 0 (-5 to 5) (input field).
 - Character Augmentation: 0 (0 to 5) (input field).
 - Noise Removal: 0 (0 to 20) (input field).
 - Background Pattern Removal: On (Standard) (dropdown).
 - White Level Follower: Off (dropdown).
 - Vertical Streaks Reduction:** Radio buttons for Off (selected) and On.
 - Dropout Color:** Green (dropdown).
 - sRGB Output:** Radio buttons for Off (selected) and On.
- Image Correction:**
 - Blank Page Skip:** Radio buttons for Yes (selected) and No. Sensitivity: 0 (-5 to 5) (input field).
 - Rotation:** Auto (dropdown).
 - Edge Correction:**
 - Edge Filler: Radio buttons for No (selected) and Yes.
 - Fill Color: Radio buttons for White (selected) and Black.
 - Filled Area:
 - Top: 0.051 inch (0 to 0.394) and 1.3 mm (0 to 10.0)
 - Bottom: 0.051 inch (0 to 0.394) and 1.3 mm (0 to 10.0)
 - Left: 0.051 inch (0 to 0.394) and 1.3 mm (0 to 10.0)
 - Right: 0.051 inch (0 to 0.394) and 1.3 mm (0 to 10.0)
- Paper Feeding:**
 - Multifeed Setup:** Radio buttons for Do not detect, Length, and Ultrasonic (selected).
 - Both:** Radio buttons for Both (selected) and Yes.
- Batch:**
 - Index Output:** Radio buttons for No (selected) and Yes.
 - Barcode Detection:** Type:
 - EAN8, EAN13, Code 3 of 9, Code 128
 - ITF, UPC-A, Codabar

7. Set a job item.

The screenshot shows a window titled "Job Items" with a dropdown menu set to "1" and two buttons: "Delete This Item" and "Insert New Item".

HINT

Up to ten items can be set.

8. If [e-Mail] is selected for the job item in [Step 7](#), perform settings related to sending e-mail.

For details about setting values, refer to ["5.4 Sending the Scanned Data by e-Mail" \(page 229\)](#).

The screenshot shows the "e-Mail Settings" window. It includes fields for "To", "Cc", and "Bcc", each with a "Send a copy to user e-mail address" checkbox and a "Browse..." button. The "File Name" field contains "[Scanner Name]MMdyyyhhmss" and has a "Name Format..." button. The "From" field has radio buttons for "e-Mail address of user" (selected) and "Fixed e-mail address", with a "Browse..." button. Below "From" are "SMTP Authentication" fields for "User Name" and "Password". The "Request Return Receipt" field has radio buttons for "Yes" and "No" (selected). The "Subject" and "Body" fields are also visible. A note at the bottom states: "When the File Format is 'JPEG' or 'TIFF', a separate image file will be attached to the e-mail for each scanned page."

HINT

- Press the [Browse] button to set a different e-mail address from the [LDAP List] window. To filter the LDAP List, refer to ["Filtering the LDAP List" \(page 199\)](#) for more details.
- Press the [Name Format] button to specify a file name on the [File Names (e-Mail)] window. For details about setting values, refer to ["4.11.4 Setting a File Name Format for When Attaching Scanned Data to e-Mail" \(page 128\)](#).

9. If [Fax] is selected for the job item in [Step 7](#), perform settings related to sending a fax.

For details about setting values, refer to ["5.5 Sending the Scanned Data by Fax"](#) (page 243).

HINT

Press the [Browse] button to set a different e-mail address from the [LDAP List] window. To filter the LDAP List, refer to ["Filtering the LDAP List"](#) (page 199) for more details.

10. If [Print] is selected for the job item in [Step 7](#), perform settings related to printing.

For details about setting values, refer to ["5.6 Printing the Scanned Data"](#) (page 251).

HINT

Press the [Browse] button to set the network printer from the [Printer List] window.

11. If [Save] is selected for the job item in [Step 7](#), perform settings related to saving.

For details about setting values other than those for a [Save process results file], refer to ["5.7 Saving the Scanned Data to a Network Folder"](#) (page 261).

Process results files are formatted as follows:

- Process results files are in an XML format.

- Process results files use the UTF-8 character set.
- Process results files contain the following output:

| Item | Value |
|-------------------|---|
| ResultFileVersion | V1.0 |
| ScannerName | Scanner name |
| User | User |
| Date | Save completion date |
| Time | Save completion time |
| Result | Save process results |
| ResultCode | Result code |
| ResultDescription | Result details |
| Pages | Number of saved pages |
| SheetCount_Job | Number of sheets to be scanned, set by the job |
| SheetCount_User | Number of sheets to be scanned, set by the user |
| SheetCount_Scan | Actual number of scanned sheets |
| FileName | Saved file name(s) (Multiple files) |
| Path | Saved file path name |

HINT

- Press the [Browse] button to set the network folder from the [Folder List] window.
- Press the [Name Format] button to specify a file name from the [File Names (Save)] window. For details about setting values, refer to "[4.13.4 Setting a File Name Format for When Saving Scanned Data](#)" (page 144).

12. Press the [OK] button.

⇒ A job sequence is added to the [Jobs List] window.

■ Cloning a Job Sequence

This section describes how to clone a job sequence.

1. **Press the [Job Menu Settings] button on the Tool Menu.**
2. **Press the [Job Sequences] tab.**
 - ⇒ The [Jobs List] window appears.
3. **Select the job sequence to be cloned.**
4. **Press the [Clone] button.**
 - ⇒ The [Job Details] window appears.
5. **Clone the detailed job sequence settings.**
6. **Press the [OK] button.**
 - ⇒ A job sequence is added to the [Jobs List] window.

■ Editing a Job Sequence

This section describes how to edit a job sequence.

1. **Press the [Job Menu Settings] button on the Tool Menu.**
2. **Press the [Job Sequences] tab.**
 - ⇒ The [Jobs List] window appears.
3. **Select the job sequence to be edited.**
4. **Press the [Edit] button.**
 - ⇒ The [Job Details] window appears.
5. **Edit the detailed job sequence settings.**
6. **Press the [OK] button.**
 - ⇒ The settings of the job sequence are changed.

■ Deleting a Job Sequence

This section describes how to delete a job sequence.

1. **Press the [Job Menu Settings] button on the Tool Menu.**
2. **Press the [Job Sequences] tab.**
 - ⇒ The [Jobs List] window appears.
3. **Select the job sequence to be deleted.**
4. **Press the [Delete] button.**
 - ⇒ The confirmation window appears.
5. **Press the [OK] button.**
 - ⇒ The job sequence is deleted.

■ Filtering Job Sequences

This section describes how to filter job sequences.

1. **Press the [Job Menu Settings] button on the Tool Menu.**
2. **Press the [Job Sequences] tab.**
 - ⇒ The [Jobs List] window appears.
3. **Enter [Job Name] and [Comment].**
4. **Select the [Find] button.**
 - ⇒ The filtered results appear.

■ Filtering the LDAP List

This section describes how to filter the LDAP List on the [LDAP List] window.

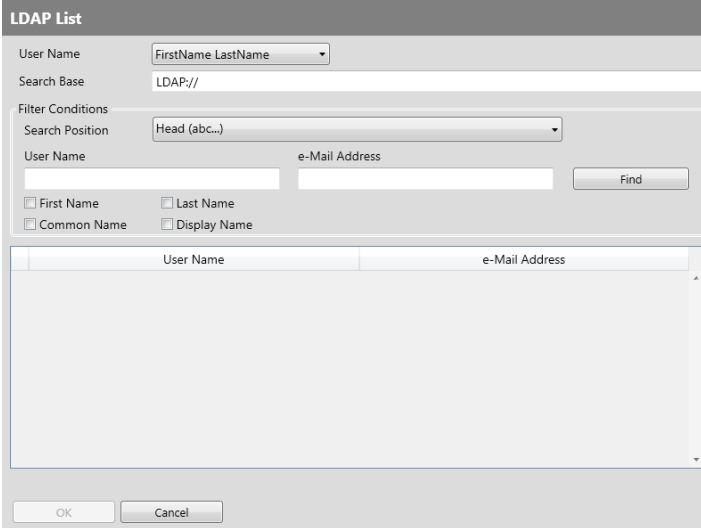

The screenshot shows the 'LDAP List' window. It has a title bar 'LDAP List'. Below the title bar, there are several fields and controls:

- 'User Name' dropdown menu with 'FirstName LastName' selected.
- 'Search Base' text field containing 'LDAP://'.
- 'Filter Conditions' section with a 'Search Position' dropdown menu showing 'Head (abc...)'.
- Two text input fields: 'User Name' and 'e-Mail Address'.
- A 'Find' button to the right of the 'e-Mail Address' field.
- Four checkboxes: First Name, Last Name, Common Name, and Display Name.
- A table with two columns: 'User Name' and 'e-Mail Address'. The table is currently empty.
- 'OK' and 'Cancel' buttons at the bottom.

1. Specify each item on the [LDAP List] window.
2. Select the [Find] button.

⇒ The filtered results appear.

HINT

If the [Find] button is selected, an authentication window appears.

Enter a [User Name] and [Password], and then press the [OK] button.

User names may be up to 129 characters long.

Passwords may be up to 256 characters long. [User Name] and [Password] are case sensitive.

■ Splitting an Output File

An output file can be split in the following ways for a job sequence:

- Specifying a number of pages
- Using a patch code sheet

This function allows you to split a file in a specified unit of pages without stopping a scan when scanning more than one document. A file is split in a specified unit of pages, and consequently the scanned images are separated into each scanned document (unit of pages that is split).

This function can only be set for a job sequence. To set this function, select [Separation] in [Save] in [Scan Settings].

- Specifying a number of pages

To specify a number of pages, select [Number of pages] for [Separation Mode].

Using this setting splits a file in pages determined by the number of pages you specify.

When the last split file is output, if the number of pages that is output is less than the number of pages you specify, the output file contains the last output pages.

Additional scanned pages are not recognized as an additional batch and instead of this, all pages including additional pages are recognized as a batch, then split.

- Using patch codes

To set patch codes, select [Patch Code] for [Separation Mode].

Using this setting, and scanning documents with patch code sheets inserted into the points where documents are to be separated, a file is split and output in the specified unit of pages.

You can configure the setting for naming split output files.

Separator string, document counter, and page counter (for a single page) with delimiters (hyphens "-") are appended to the existing file naming rule.

Examples of file names are as follows:

- Separator

Examples: File naming rule (user name with a sequence number), no separator string specified, PDF

Guest0001-SEPARATOR0001.pdf

Guest0001-SEPARATOR0002.pdf

- Document Counter

Examples: File naming rule (user name without a sequence number), JPG (Since the files are single-page files, a sequence number for the page counter is appended.)

Guest-0001-00001.jpg

Guest-0001-00002.jpg

Guest-0001-00003.jpg

Guest-0002-00001.jpg

Guest-0002-00002.jpg

- Separator and Document Counter

Examples: File naming rule (user name with a sequence number), separator string (scanner) specified, PDF

Guest0001-scanner-0001.pdf

Guest0001-scanner-0002.pdf

4.18.3 Setting a Job Menu Admin Tool Central Admin Console

Assign the job sequence set in "4.18.2 Setting a Job Sequence" (page 191) to a job button, and job buttons on a job menu.

Up to 100 job menus can be set.

HINT

For details about displaying the window for setting a job sequence via Central Admin Console, refer to the Scanner Central Admin User's Guide.

■ Adding a Job Menu

This section describes how to add a job menu.

1. Press the [Job Menu Settings] button on the Tool Menu.
2. Press the [Job Menus] tab.
 - ⇒ The [Job Menus List] window appears.

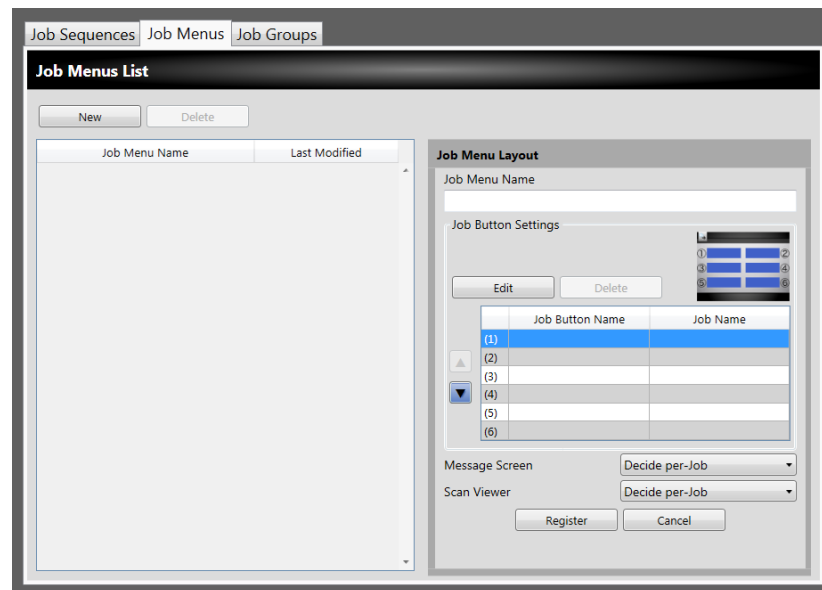

3. Press the [New] button.
4. Enter a job menu name in [Job Menu Name].

5. Select the line corresponding to the job button position (1) to (6), and select the [Edit] button.

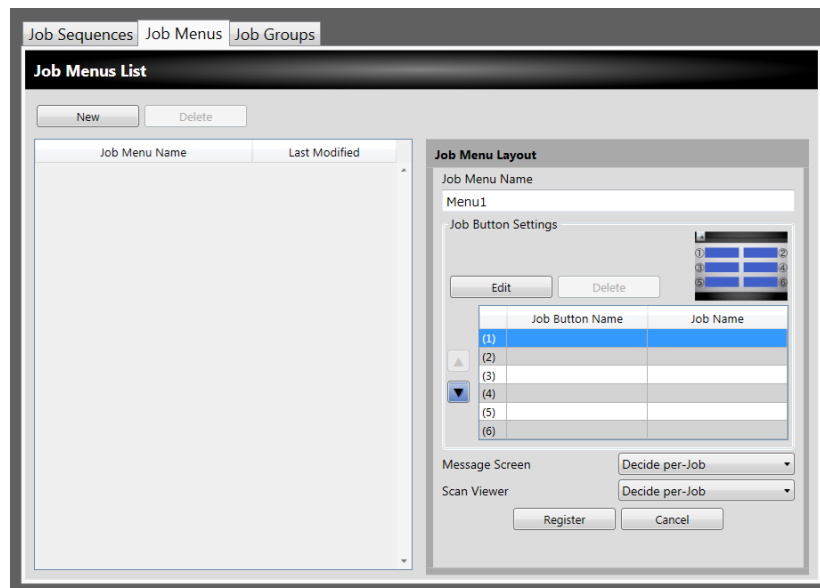

⇒ The [Job Button Settings] window appears.

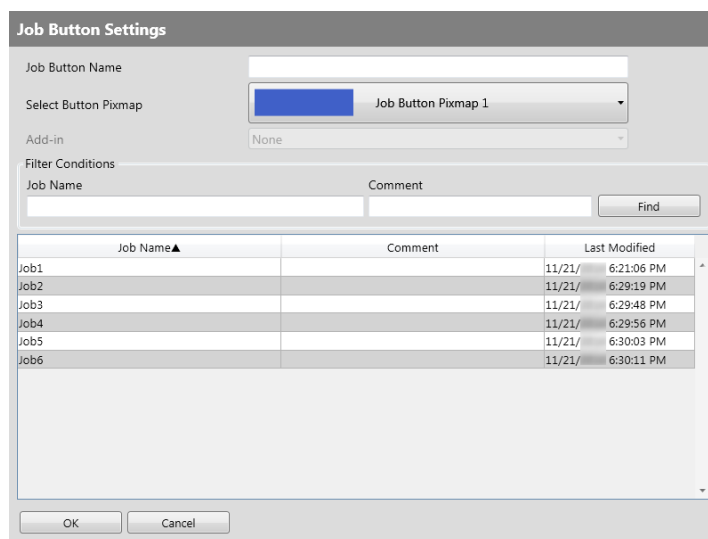



6. Specify each item.
7. Press the [OK] button.

⇒ A job button is set on the [Job Menu Layout] area.
8. Repeat **Step 5** through **Step 7** as required for the number of job buttons.

HINT

- Up to six job buttons can be set.
- To delete a job button, select the job button that you want to delete and press the [Delete] button.

9. Change the position of the job buttons assigned on the job menu as necessary.

Select the job button to move, and then select either  or  to move it. The relationship between the order of job buttons on the [Job Menu Layout] area and the arrangement of buttons on the [Job Menu] is shown below.

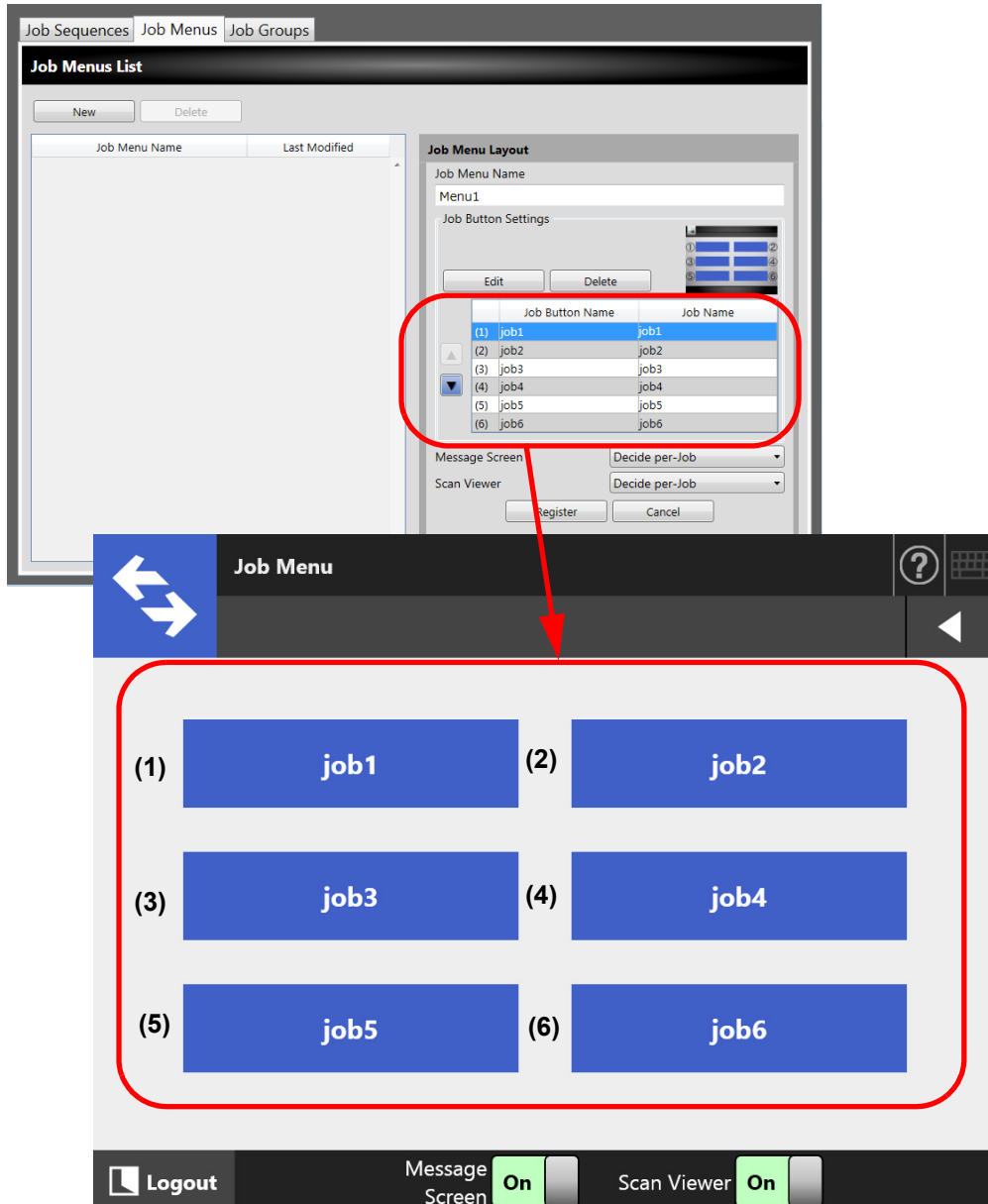

10. For [Message Screen], set whether to show [Message Screen] on the [Job Menu] window.

11. For [Scan Viewer], set whether to show [Scan Viewer] on the [Job Menu] window.

12. Press the [Register] button.

⇒ A job menu is added to the [Job Menus List] window.

■ Cloning a Job Menu

This section describes how to clone a job menu.

- 1. Press the [Job Menu Settings] button on the Tool Menu.**
- 2. Press the [Job Menus] tab.**
 - ⇒ The [Job Menus List] window appears.
- 3. Select the job menu to view.**
 - ⇒ The job menu settings are displayed on the [Job Menu Layout] area.
- 4. Change the job menu name shown in [Job Menu Name] to the job menu name to be added.**
- 5. Clone the detailed job menu settings.**
 - For the procedure, refer to [Step 5](#) through [Step 11](#) in "Adding a Job Menu" (page [201](#)).
- 6. Press the [Register] button.**
 - ⇒ A job menu is added to the [Job Menus List] window.

■ Editing a Job Menu

This section describes how to edit a job menu.

- 1. Press the [Job Menu Settings] button on the Tool Menu.**
- 2. Press the [Job Menus] tab.**
 - ⇒ The [Job Menus List] window appears.
- 3. Select the job menu to be edited.**
 - ⇒ The job menu settings are displayed on the [Job Menu Layout] area.
- 4. Edit the detailed job menu settings.**
 - For the procedure, refer to [Step 5](#) through [Step 11](#) in "Adding a Job Menu" (page [201](#)).
- 5. Press the [Register] button.**
 - ⇒ The details of the job menu are changed.

■ Deleting a Job Menu

This section describes how to delete a job menu.

- 1. Press the [Job Menu Settings] button on the Tool Menu.**
- 2. Press the [Job Menus] tab.**
 - ⇒ The [Job Menus List] window appears.
- 3. Select the job menu to be deleted.**
- 4. Press the [Delete] button.**
 - ⇒ The confirmation window appears.
- 5. Press the [Register] button.**
 - ⇒ The job menu is deleted.

■ Viewing the Detailed Settings for a Job Menu

This section describes how to view the detailed settings for a job menu.

- 1. Press the [Job Menu Settings] button on the Tool Menu.**
- 2. Press the [Job Menus] tab.**
 - ⇒ The [Job Menus List] window appears.
- 3. Select the job menu to view.**
 - ⇒ The details for the selected job menu appear in the [Job Menu Layout] area.

4.18.4 Setting a Job Group AdminTool Central Admin Console

Assign the job menu set in "4.18.3 Setting a Job Menu" (page 201) to a job group. Users included in a job group can use the job menus assigned to the group. Users included in multiple job groups can use the multiple job menus assigned to those groups. Up to 100 job groups can be set.

HINT

For details about displaying the window for setting a job sequence via Central Admin Console, refer to the Scanner Central Admin User's Guide.

■ Adding a Job Group

This section describes how to add a job group.

1. Press the [Job Menu Settings] button on the Tool Menu.
2. Press the [Job Groups] tab.
 - ⇒ The [Job Groups List] window appears.

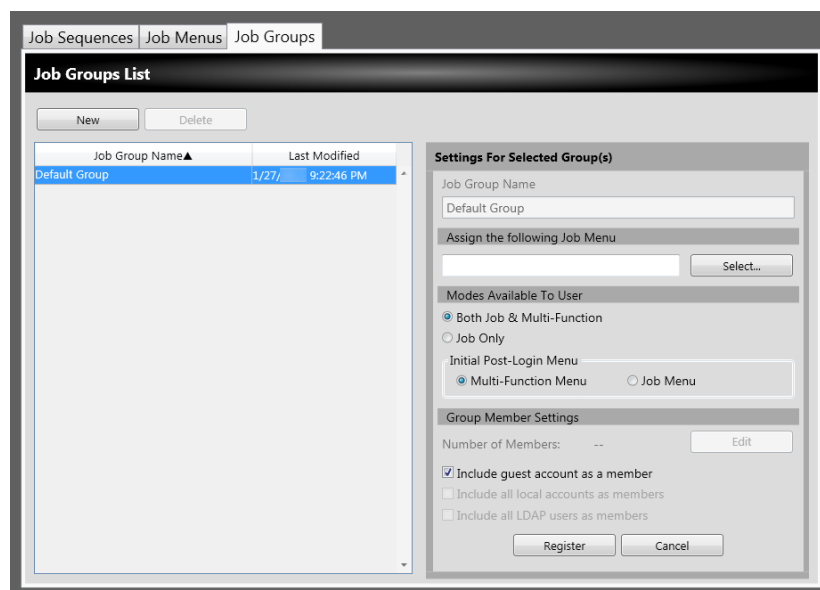

3. Press the [New] button.
4. Enter the job group name for [Job Group Name].

5. Press the [Select] button.

⇒ The [Select Job Menu] window appears.

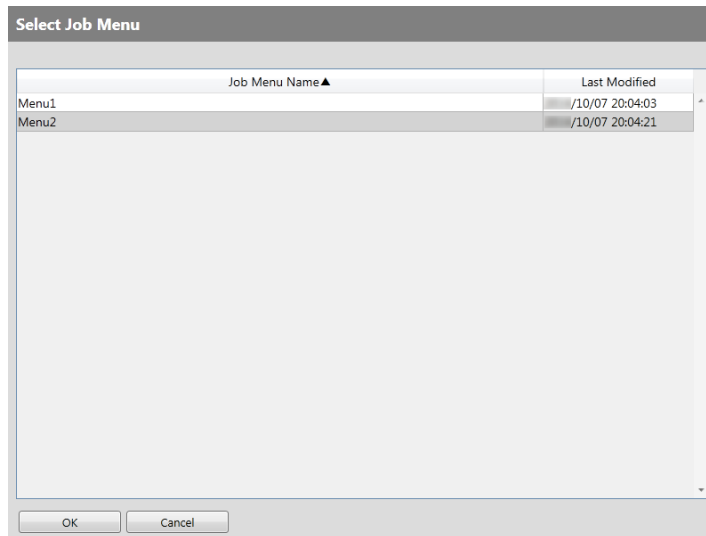

6. Select a job menu.

7. Press the [OK] button.

⇒ A job menu is set on the [Settings For Selected Group(s)] area.

8. For [Modes Available To User], set whether or not to display the Multi-Function Menu.

9. Press the [Edit] button.

⇒ The [Group Member Settings] window appears.

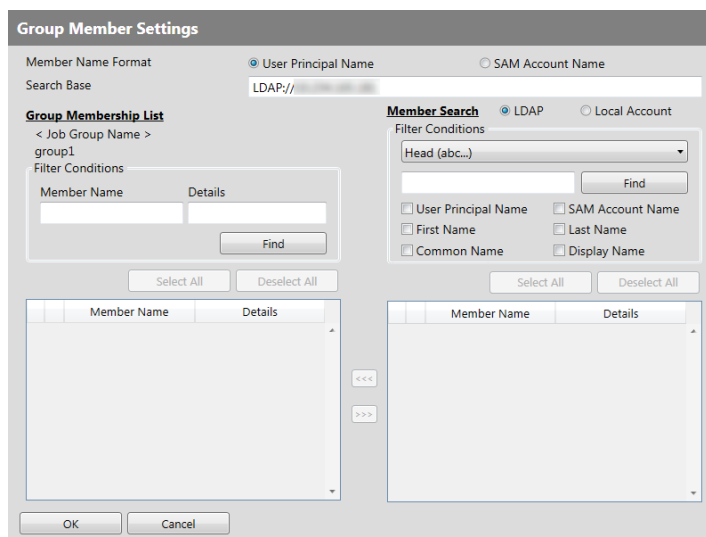

10. For [Member Name Format], select the member name format.

11. Enter the LDAP server and character string to be used for LDAP searches in the [Search Base] field.

- 12. In the [Member Name] list of [Member Search], select the check box of a user name, Active Directory group, or local account to be added to a job group.**

HINT

To filter the LDAP List, refer to "[Filtering the LDAP List](#)" (page 212) for more details.

- 13. Press the [<<<] button.**

⇒ The user, Active Directory group, or local account is added to the [Group Membership List].

HINT

- Up to 1,000 members can be added as job group members.
- To delete a member added to the [Group Membership List], select the check box in the [Member Name] list, and then press the [>>>] button.

- 14. Press the [OK] button.**

⇒ The number of members registered as job group members is shown in [Number of Members] on the [Settings For Selected Group(s)] window.

- 15. Specify the members to be included in the job group in [Group Member Settings].**

HINT

If the [Include all LDAP users as members] check box is selected, all LDAP users are included regardless of the selection of LDAP users in [Group Membership List].

- 16. Press the [Register] button.**

⇒ A job group is added to the [Job Groups List] window.

■ Cloning a Job Group

This section describes how to clone a job group.

- 1. Press the [Job Menu Settings] button on the Tool Menu.**
- 2. Press the [Job Groups] tab.**
 - ⇒ The [Job Groups List] window appears.
- 3. Select the job group to be cloned.**
 - ⇒ The job group settings are displayed on the [Settings For Selected Group(s)] area.
- 4. Change the job group name shown in [Job Group Name] to the job group name to be added.**
- 5. Clone the detailed job group settings.**
 - For the procedure, refer to [Step 5](#) through [Step 15](#) in "Adding a Job Group" (page [206](#)).
- 6. Press the [Register] button.**
 - ⇒ A job group is added to the [Job Groups List] window.

■ Editing a Job Group

This section describes how to edit a job group.

- 1. Press the [Job Menu Settings] button on the Tool Menu.**
- 2. Press the [Job Groups] tab.**
 - ⇒ The [Job Groups List] window appears.
- 3. Select the check box for the job group to be edited.**
 - ⇒ The job group settings are displayed on the [Settings For Selected Group(s)] area.
- 4. Change the detailed job group settings.**
 - For the procedure, refer to [Step 5](#) through [Step 15](#) in "Adding a Job Group" (page [206](#)).
- 5. Press the [Register] button.**
 - ⇒ The details of the job group are changed.

■ Deleting a Job Group

This section describes how to delete a job group.

- 1. Press the [Job Menu Settings] button on the Tool Menu.**
- 2. Press the [Job Groups] tab.**
 - ⇒ The [Job Groups List] window appears.
- 3. Select the job group to be deleted.**
- 4. Press the [Delete] button.**
 - ⇒ The confirmation window appears.
- 5. Press the [Register] button.**
 - ⇒ The job group is deleted.

■ Viewing the Detailed Settings for a Job Group

This section describes how to view the detailed settings for a job group.

- 1. Press the [Job Menu Settings] button on the Tool Menu.**
- 2. Press the [Job Groups] tab.**
 - ⇒ The [Job Groups List] window appears.
- 3. Select the job group to view.**
 - ⇒ The details for the selected job group appear in the [Settings For Selected Group(s)] area.

■ Assigning Job Menus to Users Not Included in a Job Group

Users who are not included in any job group automatically belong to a Default Group. This section describes how to assign job menus to those users.

1. Press the [Job Menu Settings] button on the Tool Menu.
2. Press the [Job Groups] tab.
 - ⇒ The [Job Groups List] window appears.

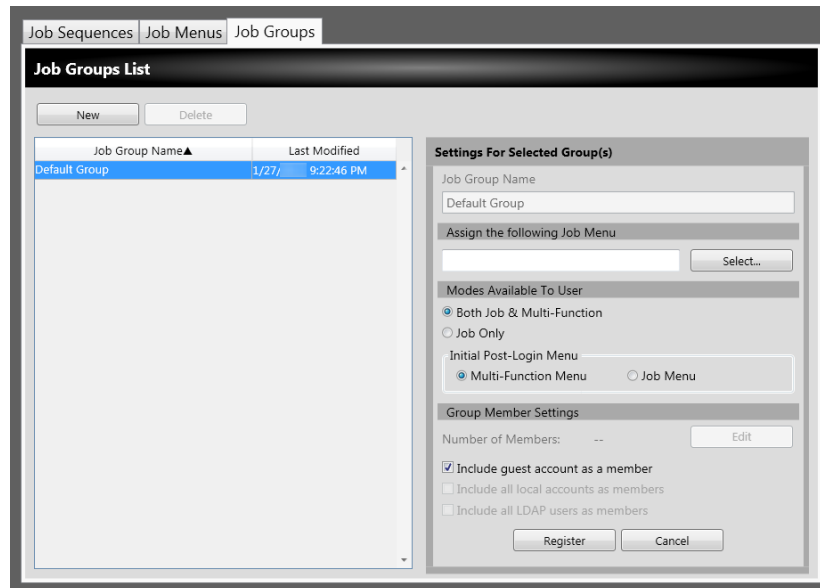

3. Select the default job group.
4. Press the [Select] button.
 - ⇒ The [Select Job Menu] window appears.
5. Select a job menu.
6. Press the [OK] button.
 - ⇒ A job menu is set on the [Settings For Selected Group(s)] area.
7. For [Modes Available To User], set whether or not to display the Multi-Function Menu.
8. Press the [Register] button.
 - ⇒ A job menu is assigned to users who are not included in a job group.

■ Filtering the LDAP List

This section describes how to filter the LDAP List on the [Group Member Settings] window.

1. For [Filter Conditions] of the LDAP List, specify each item.
2. Select the [Find] button.

⇒ The filtered results appear.

HINT



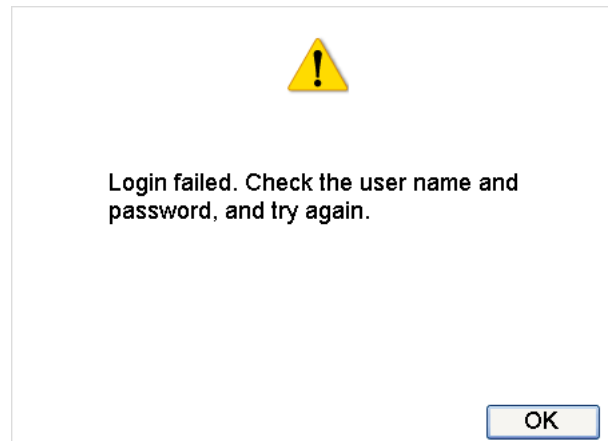

- If the login LDAP server type is [Active Directory] or [Active Directory Global Catalog], when the [Find] button is pressed, a confirmation window appears. Enter a [User Name] and [Password], and then press the [OK] button. User names may be up to 129 characters long. Passwords may be up to 256 characters long. [User Name] and [Password] are case sensitive.
- If the number of filtered results on the [LDAP List] window, or the number of registered job group members is large (1,000 at maximum), it may take tens of seconds until the [Group Member Settings] window appears. This can be resolved by performing the following:
 - Add filter conditions
 - Reduce the [Maximum Results] specified on the [e-Mail LDAP Server] window
 - Divide job groups
 - Specify an Active Directory group

4.19 Messages AdminTool

The following shows an example of the window that appears to display a message for the administrator.



The following lists the meanings of icons shown on message windows.

| Icon | Details |
|---|---|
|  | Indicates a warning message. This icon is displayed also for improper input values. Read the message and press the [OK] button. |
|  | Indicates an error message. Read the message and press the [OK] button. |
|  | Indicates an information message. No action required. <ul style="list-style-type: none"> ● When the [OK] button is shown on the window, check the message contents, and then press the [OK] button to close the message window. ● When the [OK] button is not shown on the window, the message window closes automatically. |
|  | Indicates an inquiry message. Confirm the message details, and press a relevant button. |

4.19.1 Administrator Window Messages

For details about messages and system logs, other than those shown in the table below, refer to Help.

| Window | Message | Action |
|------------|---|--|
| Admin Tool | Connection error | For details about the action to be taken, refer to " 7.2.3 Failure to Access the Scanner Using Internet Explorer, the Admin Tool, the Central Admin Server, or the User Editor " (page 376). |
| | You cannot connect to this device using the current version of Admin Tool. Install the latest version, and try again. | Install the latest version of Admin Tool from the scanner, and try again. |

Chapter 5

Regular User Operations

User

This scanner is used to scan documents which then can be sent by e-mail or fax, printed via a network scanner, or saved to a folder.

To perform the operations described in this chapter, the scanner must first be set up by the administrator.

For details about scanner setup, refer to "[Chapter 4 Administrator Operations \(Touch Panel and Admin Tool\)](#)" (page 66).

| | |
|---|------------|
| 5.1 Loading Documents..... | 216 |
| 5.2 Using Touch Panel Windows: Regular User | 223 |
| 5.3 Logging in: Regular User Mode..... | 226 |
| 5.4 Sending the Scanned Data by e-Mail | 229 |
| 5.5 Sending the Scanned Data by Fax | 243 |
| 5.6 Printing the Scanned Data | 251 |
| 5.7 Saving the Scanned Data to a Network Folder..... | 261 |
| 5.8 Setting the Scan Options | 264 |
| 5.9 Enabling/Disabling the Scan Viewer | 306 |
| 5.10 Editing the Scanned Data in the Scan Viewer | 309 |
| 5.11 Viewing the Send Status | 319 |
| 5.12 Maintenance | 322 |
| 5.13 Processing a Job | 324 |
| 5.14 Changing a User Password..... | 334 |

5.1 Loading Documents

This section describes how to load documents onto the scanner.

5.1.1 How to Load Documents

1. Check the number of document sheets.

For document sheet limits, refer to ["A.3 Maximum Document Loading Capacity" \(page 397\)](#).

2. When loading multiple document sheets, fan the document stack.

1. Lightly grip the ends of the document stack in both hands, and fan two or three times.

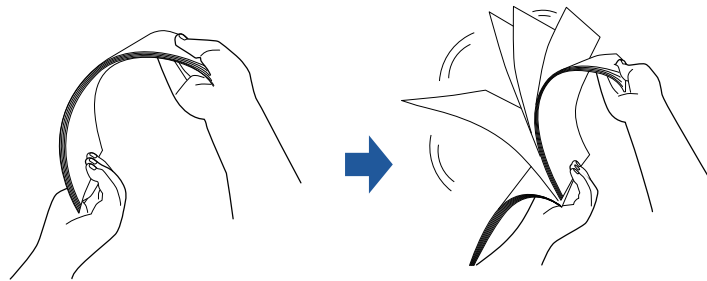

2. Rotate the documents 90 degrees, and fan again.

3. Align the edges of the document sheets to be loaded, and slightly skew the leading edge of the document.

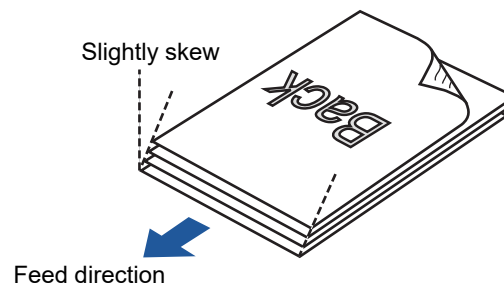

ATTENTION

Scanning the document sheets whose edges are not aligned might cause paper jams or damage to the document.

3. Pull up the extension to hold the documents, and pull out the stacker.

Pull out the stacker and lift up Stacker extension 1 and Stacker extension 2 towards you.

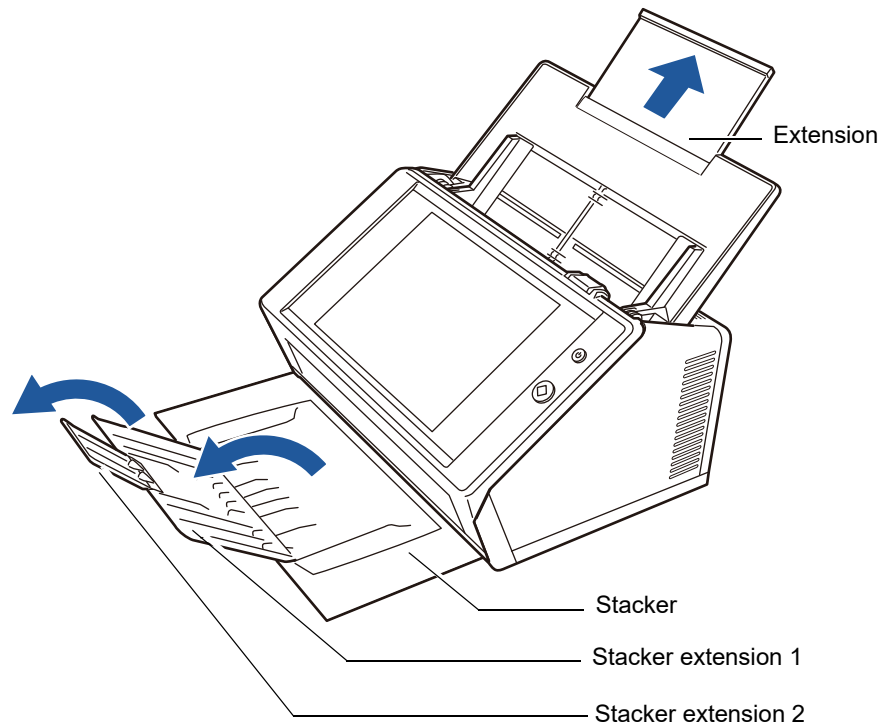

HINT

The stacker holds the document sheets after they have been scanned. It can be pulled out and adjusted to the size of the document being scanned.

4. Load the documents into the ADF paper chute.

Load the document front side down, with the top of the document entering the scanner first (when multiple document sheets are loaded, the last page is on the top).

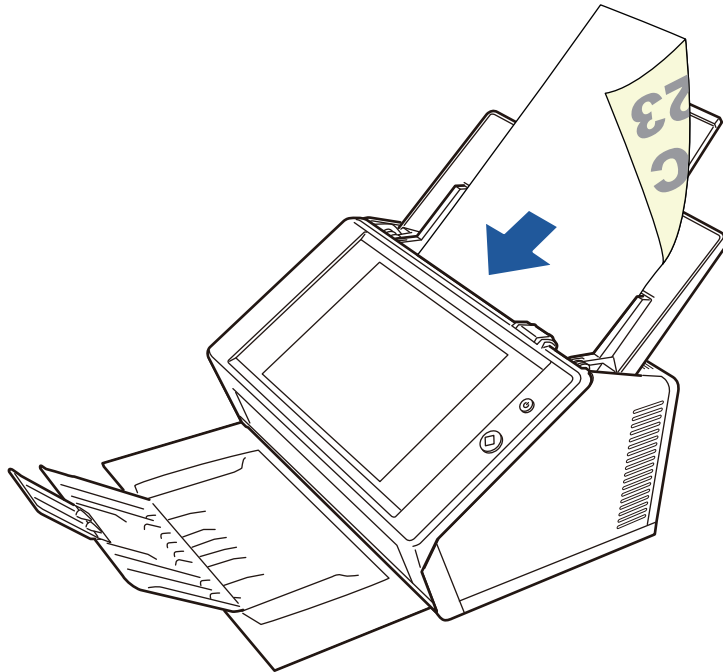

ATTENTION

The ADF paper chute needs to be put all the way back to be used. Documents cannot be fed if it is folded.

HINT

If [Face-up] is selected for [Document Feed Direction] on the [Paper] window, load the document front side up, with the bottom of the document entering the scanner first. When you run [Scan More], additional pages will follow on from the last page of the current scanned image.

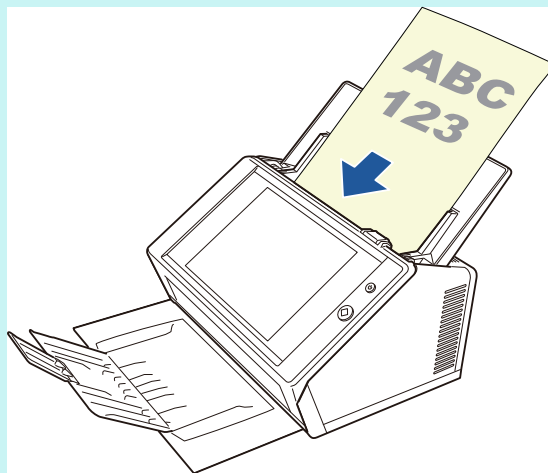

For details about how to load the document, refer to ["5.8.3 Setting Paper" \(page 277\)](#).

5. Adjust the side guides to the width of the documents.

Move the side guides so that they touch both sides of the documents.

If there is any space between the side guides and the edges of documents, the scanned data may be skewed.

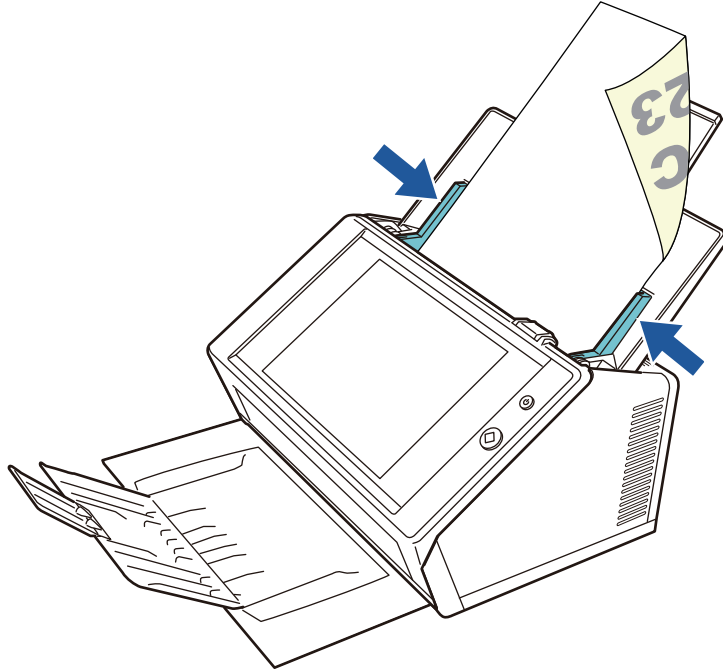

5.1.2 Loading Documents Using a Carrier Sheet

With an optional Carrier Sheet, you can scan documents larger than A4 size, such as A3, Double Letter, and B4. To do this, you fold the document in half and scan both sides continuously in duplex mode, one side at a time. The scanned images will be merged and saved as one image page.

When scanning a document larger than A4 size, change the settings as follows:

ATTENTION

When using a Carrier Sheet, set the output size for the scanned document. For details, refer to ["5.8.5 Configuring Settings for a Carrier Sheet"](#) (page 279).

HINT

- You can merge both front and back side images of a document smaller than A4 size to output a single double-page image.
- For details about purchasing a Carrier Sheet, refer to ["6.5.4 Purchasing a Carrier Sheet"](#) (page 355).

1. Fold the sheet to be scanned in half so that its front side faces outwards.

Fold the sheet tightly and smooth out the crease. Otherwise, the sheet may be skewed during scanning.

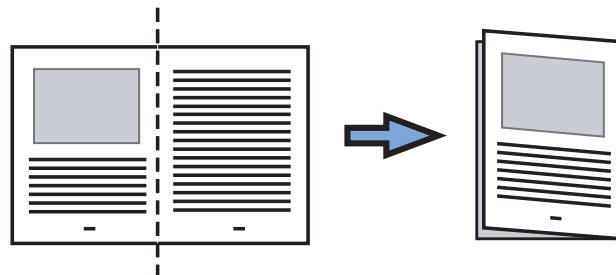

2. Open the Carrier Sheet and insert the document.

Align the fold with the right edge of the Carrier Sheet so that the document fits into the Carrier Sheet at the upper corner.

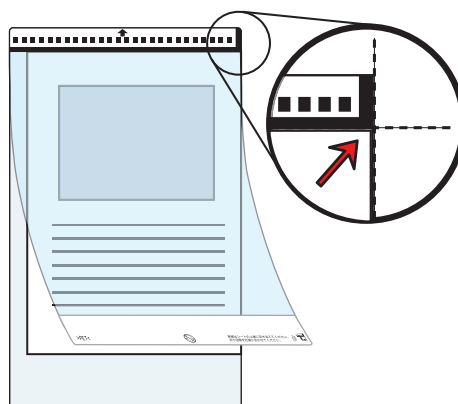

HINT

- When placing the Carrier Sheet with the printed black and white pattern to be at the top, the front of the Carrier Sheet has the thick vertical line at the right side.
- If [Face-up] is selected for [Document Feed Direction] on the [Paper] window, align the fold side with the right edge of the Carrier Sheet so that the document fits into the Carrier Sheet at the lower corner.

3. With the Carrier Sheet face-down, place the black and white pattern section downward, and load it in the ADF paper chute.

After loading the Carrier Sheet, align the side guides with the Carrier Sheet.

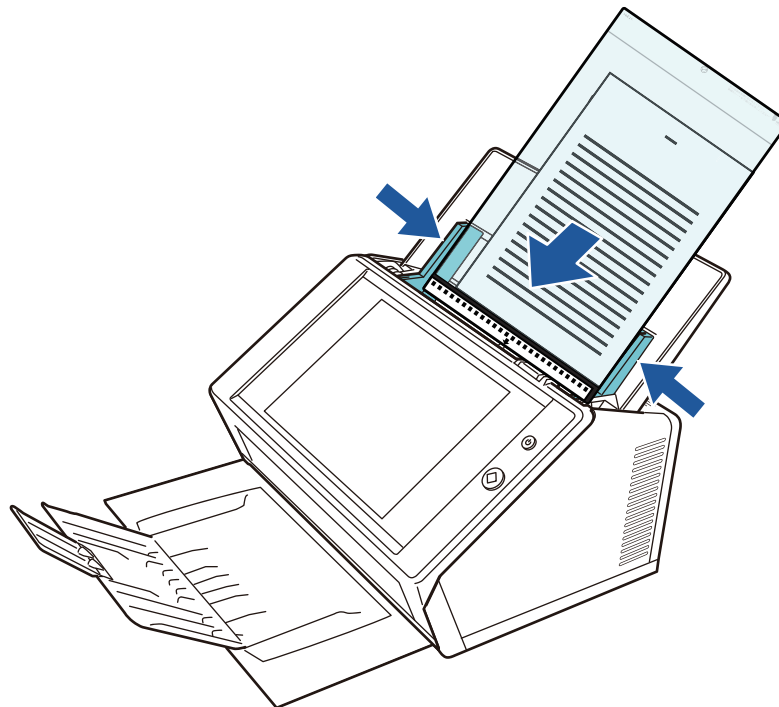

ATTENTION

The ADF paper chute needs to be put all the way back to be used. Documents cannot be fed if it is folded.

4. Start the scan.

⇒ The front and back side images are merged into a double-page spread image.

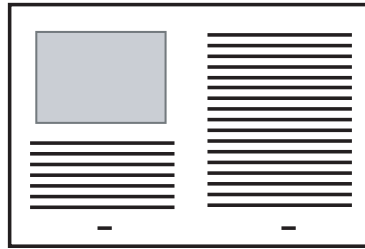
**ATTENTION**

- There may be a gap between the front and back side images, or a line may appear on the output scan image.
If a thick document is scanned with the Carrier Sheet, scanned images on the both right and left sides may be skewed to a trapezoidal shape.
These problems may be improved in the following ways.
 - Fold the document neatly
 - Align the edge of the document with the edge of the Carrier Sheet
 - Scan the Carrier Sheet with the front side facing the paper chute or vice versa
- The folded part of the document may be mis-detected, causing the seam of the facing pages be unintentionally trimmed on the scanned image. In this case, the folded edge of the document should be placed 1 mm away from the edge of the Carrier Sheet.

5.2 Using Touch Panel Windows: Regular User

5.2.1 [Main Menu] Window

The types of buttons displayed on the menu differ, for example, according to the settings of the linked server.

When e-Mail, Fax, Print, and Save are set, the following window is displayed.

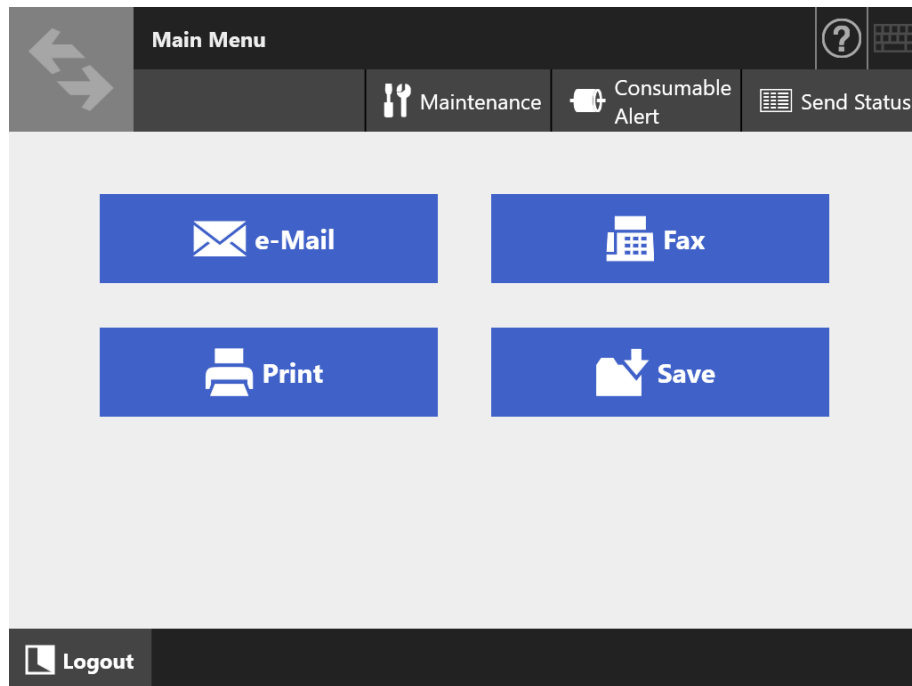

5.2.2 [Job Menu] Window

The types of buttons displayed on the menu differs according to the job settings. In the following example, six jobs are set.

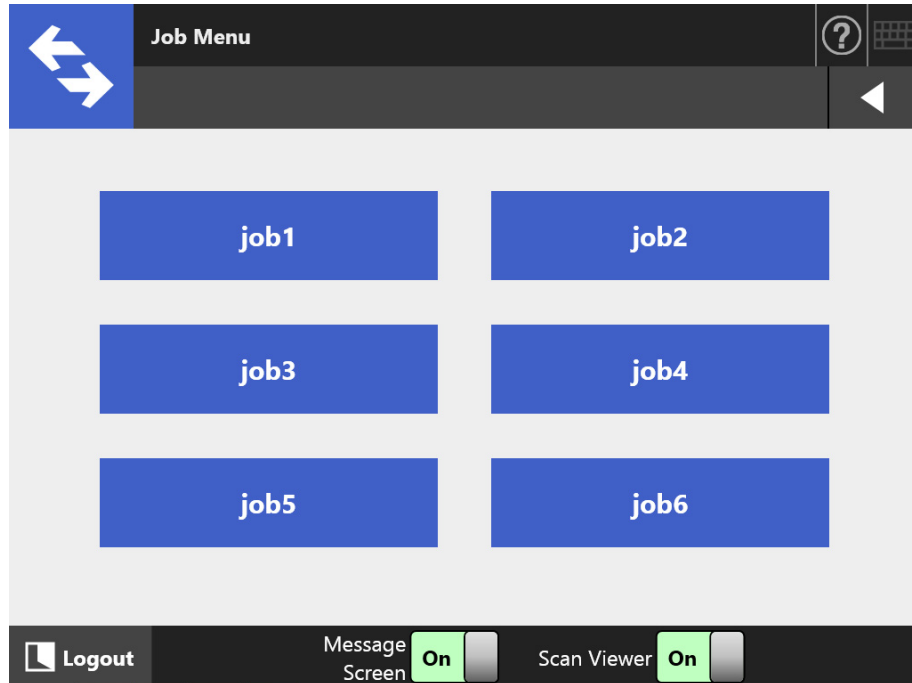

When a regular user belongs to multiple job groups, a menu and buttons to switch the [Job Menu] window appear as shown below.

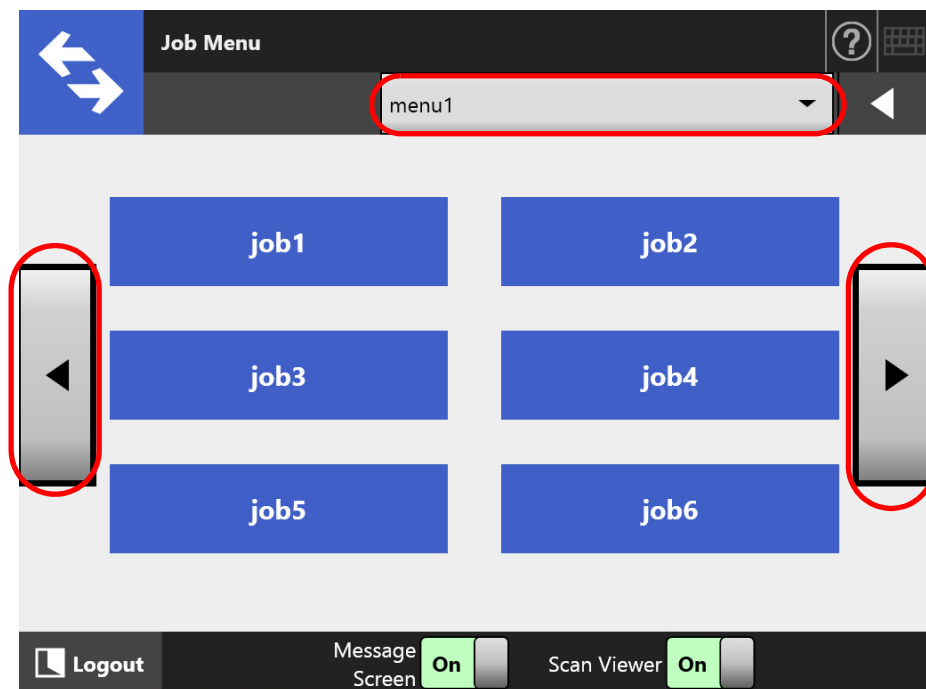

5.2.3 Regular User Settings Overview

Regular users can configure the following setting items as long as these items have been enabled by the administrator.

- **Login Setting**
Set the scanner to automatically login without displaying the [Login] window, when the scanner power is switched on or restarted.
Also, set whether or not to enable login with the guest account.
To change these settings, contact the administrator.
- **Initial Post-Login Menu**
Set whether to display the [Main Menu] or [Job Menu] window.
Switch between the [Main Menu] and [Job Menu] windows, or display only the [Job Menu] window.
- **User Roaming Data**
User settings can be shared between multiple scanners, by allowing user data to be managed on the Central Admin Server.
A regular user can login on different scanners while retaining their user data.
The following user data can be used in roaming mode.
 - "My List" e-mail address book
 - Scan settings
 - Printer name used for printing scanned data (*)
 - Destination for saving scanned data (*)

(*): If a specified printer name or a specified destination for saving scanned data is different for each scanner, selected items will be cleared.
- **Job Roaming Info**
User job settings can be shared between multiple scanners, by allowing job settings to be managed on the Central Admin Server.
A regular user can login on different scanners while retaining their preferred [Job Menu] window.

HINT

When Roaming Mode or Job Mode is [On] on the [Scanner Central Admin Server] window, which is displayed by selecting the [Scanner Central Admin Server] window in [Network Admin], if communication with the Central Admin Server is not possible at login, a confirmation message will appear.

If the [OK] button is pressed, the settings saved in the scanner are used. Pressing the [Cancel] button returns to the [Login] window.

For details about the [Scanner Central Admin Server] window, refer to ["4.9.2 Setting a Central Admin Server"](#) (page 111).

5.3 Logging in: Regular User Mode



Do not move or shake the scanner when it is turned on. This may damage components in the scanner and cause data to be lost.



HINT

- The default user name and password for a regular user (guest account) are set as follows:
User name: guest
Password: guest
However, these cannot be used if the login setting for a guest account is disabled.
- Only one administrator or regular user can log in to the scanner at a time. Multiple persons cannot log in at the same time.

Depending on the authentication mode and the specified user name, the following authentication process is performed for login authentication.

- For users registered in the LDAP server
Specify a user name from the user information registered with the LDAP server.
 - When the [Server Type] of the LDAP server is [Active Directory] or [Active Directory Global Catalog]

| User Name Format | Authentication Process |
|--|--|
| SAM Account Name Does not contain @ | Authenticate the user login name (sAMAccountName). Example: user |
| User Principal Name Contains @ | Authenticate the user login name (userPrincipalName). Example: user@example.com |

HINT

When specifying a SAM account name with a domain name, describe "*domain_name\SAM_account_name*".

- When the [Server Type] of the LDAP server is [Other LDAP Server]

| User Name Format | Authentication Process |
|------------------|--|
| uid | Authenticate the user login name (uid). Example: user |
| cn | Authenticate the user login name (cn). Example: user |

- For users registered in a local account
Specify a user name from the user information of the local account.
Authentication is performed with a specified user login name for a local account saved in a scanner.

Note that the authenticated user information is also used when saving scans to a network folder.

When the scanner is turned on or restarted, automatic login without displaying the [Login] window is possible.

Login is not possible if the Active Directory account option is "User must change password at next logon". Contact an administrator to change a password, and then try logging in.

HINT

- When using a scanner without using an LDAP server or registering a local account, login with the guest account.
- For details about the LDAP server, refer to ["LDAP Server" \(page 44\)](#).
- For details about automatic login or enabling login with the guest account, refer to ["4.6.1 Setting the Login Settings" \(page 90\)](#).
- When [Other LDAP Server] is selected for [Server Type], you cannot skip entering a password in the [Login] window. Always enter the password.

1. Press the power button.

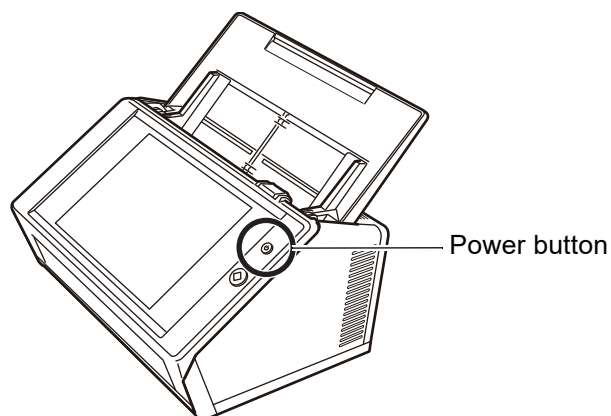

⇒ The [Login] window appears.

2. Enter a user name and password.

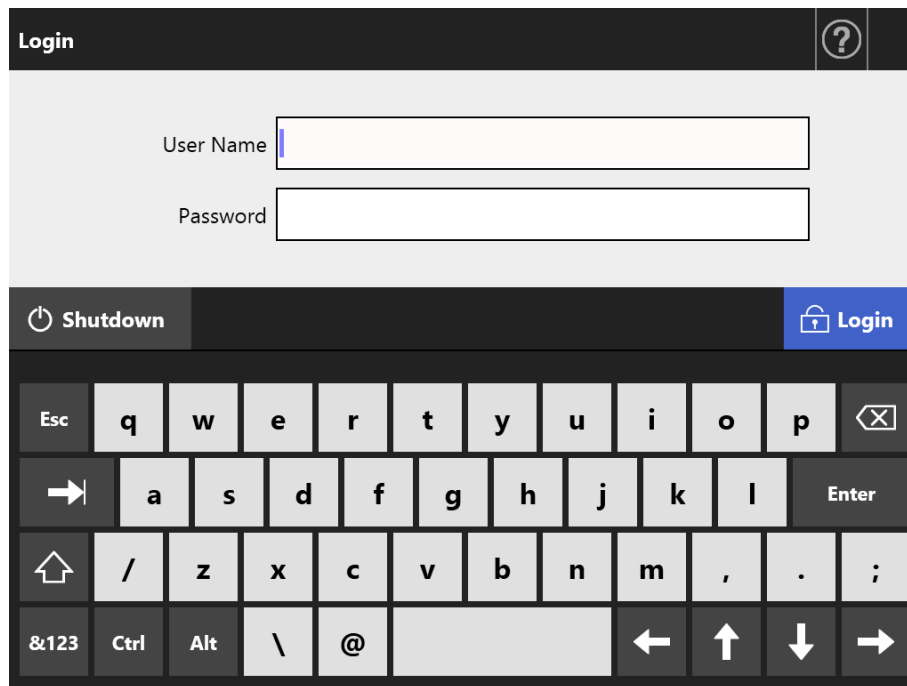

HINT

If [Active Directory Global Catalog] is selected for the login LDAP server, the [UPN Suffix] input field is displayed.

- User names including a UPN suffix may be up to 64 characters long. The entered UPN suffix is remembered and used again at the next login.
- If a UPN suffix is entered, "@" and the UPN suffix will be appended to the user name. For example, if the user name is "user" and the entered UPN suffix is "example.com", it is authenticated as "user@example.com". In this case, this is the "User Principal Name".
- Do not enter a UPN suffix when it is not required.
- A UPN suffix is not required when logging in with a guest account. Even if entered, it is ignored.

3. Press the [Login] button.

⇒ If the user name and password are valid, the [Main Menu] window appears.

5.4 Sending the Scanned Data by e-Mail

ATTENTION

If an LDAP server is set, register the user e-mail address with the LDAP server. If a local account is set, register the user e-mail address.
If the user e-mail address is not registered, e-mails cannot be sent.

1. On the [Main Menu] window, press the [e-Mail] button.

⇒ The [Send e-Mail] window appears.

HINT

The scan information can be changed by pressing  of [Scan Settings]. For details, refer to ["5.8 Setting the Scan Options" \(page 264\)](#).

2. Enter e-mail addresses, distribution list names, or groups in [To], [Cc], and [Bcc] fields.

For more details about distribution list settings, refer to ["5.4.2 Adding an e-Mail Target to the e-Mail Address Book" \(page 236\)](#).

HINT

- e-Mail addresses can be selected from the e-mail address book by pressing . For details, refer to ["5.4.1 Selecting an e-Mail Target from the e-Mail Address Book" \(page 232\)](#).
If the e-mail address book cannot be used, contact the administrator.
- Groups can be edited using User Editor. Distribution lists can also be edited. For details, refer to ["Appendix F Editing Using User Editor" \(page 428\)](#).

The screenshot shows the 'Send e-Mail' window. At the top, there is a title bar with a question mark icon and a keyboard icon. Below the title bar, there are several input fields: 'To', 'Bcc', 'Cc', 'Subject', and 'File Name'. The 'File Name' field contains the text 'FI-4C28D9P7Y705Q4H7Z62T644'. Below these fields is a large text area for the 'Body'. At the bottom of the window, there is a control bar with the following elements from left to right: a 'Cancel' button, 'Scan Settings' with a gear icon, a 'Default' button, 'Scan Viewer' with an 'On' toggle switch, and a blue 'Scan' button with a diamond icon.

3. Enter an e-mail address in the [From] field.

This field can be entered if logged in with the guest account, that has no set e-mail address.

For details about e-mail address settings values, refer to ["B.1 e-Mail Address Setting Values" \(page 402\)](#).

HINT

[From] e-mail addresses can be selected from the e-mail address book by pressing . For details, refer to ["5.4.1 Selecting an e-Mail Target from the e-Mail Address Book" \(page 232\)](#).

If the e-mail address book cannot be used, contact the administrator.

4. Specify the rest of the items.

HINT

- [Request Return Receipt] and [Send a copy to my e-mail address] are displayed when [Request Return Receipt] and [Bcc Sender for e-Mail] are [On] in [Send e-Mail] on the administrator window. For more details, refer to ["4.11.3 Configuring Settings for Sending e-Mail" \(page 127\)](#).

- The [Clear the authentication settings] button is displayed when [SMTP Authentication] is enabled in [SMTP Server Extension] on the administrator window. For more details, refer to ["4.11.2 Setting the SMTP Server \(Extension\)" \(page 126\)](#).

Pressing this button enables you to clear the authentication information that you have set.

5. Press the [Scan] button.

When [Scan Viewer] is [Off], this will be a [Scan & Send] button.

⇒ Scanning starts.

When [Off] is set for [Scan Viewer], the display for the scan settings and the scanning status (preview) can be switched during the scan.

The maximum number of pages that can be scanned is 999.

When the blank page skip function is enabled, the number of scanned pages excluding skipped blank pages is shown.

Additional pages can be scanned in place of skipped blank pages, until the maximum number of scanned pages is reached.

⇒ When the scanning has completed, the [Scan Viewer] window appears.

HINT

Scanned data can be checked on the [Scan Viewer] window. The scanned data can be edited on the scan viewer details window which is displayed after a scanned image is selected. For more details, refer to ["5.9 Enabling/Disabling the Scan Viewer" \(page 306\)](#).

6. Check and edit the scanned data.

Scanned data can be checked on the [Scan Viewer] window. The scanned data can be edited on the scan viewer details window which is displayed after a scanned image is selected. For more details, refer to ["5.10 Editing the Scanned Data in the Scan Viewer" \(page 309\)](#).

7. On the [Scan Viewer] window, press the [Send] button.

HINT

If the [SMTP Authentication] window appears, enter authentication information needed to access the SMTP server, and press the [OK] button.

⇒ The scanned data in the specified file format is sent as an e-mail attachment.

If [Split Mails] is set to [On], split e-mails will be sent.

If the number of e-mail recipients exceeds the specified maximum number, a warning message appears.

⇒ The [Main Menu] window is shown again.

HINT

- The following items are set by the administrator in advance.
 - The maximum number of e-mail addresses to be specified in the [To] field
 - Whether to split an e-mail to be sent, and the maximum size of a split e-mail
 - The maximum size of an attached file

To change these settings, contact the administrator. For more details, refer to ["4.11.1 Setting the SMTP Server" \(page 125\)](#).

- For photographs and graphics, their file sizes can be decreased by increasing the compression rate. For details, refer to ["5.8.10 Compression" \(page 288\)](#).
- If the file format is JPEG, single page TIFF, single page PDF, or single page PDF/A, the number of files that are attached to an e-mail will be the same number of pages that you scanned.
- If the e-mail fails to be sent, an error message e-mail with the following title is sent from the scanner to the [From] address.
Network Scanner (XXXX) Error

5.4.1 Selecting an e-Mail Target from the e-Mail Address Book

The following explains how to use an e-mail address book to specify destinations when sending an e-mail, instead of directly entering e-mail addresses with a keyboard.

The details to select e-mail addresses from an e-mail address book are described in [Step 2](#) and [Step 3](#) of "5.4 Sending the Scanned Data by e-Mail" (page 229).

● Type of the e-Mail Address Book

There are two types of e-mail address books, My List and LDAP List.

● My List

This is an e-mail address book that can be created by the user.

HINT

My List can also be edited using User Editor. For details, refer to ["Appendix F Editing Using User Editor"](#) (page 428).

● LDAP List



This is an e-mail address book which uses all the data saved on the LDAP server. The LDAP List cannot be edited.

The LDAP List cannot be used in the following cases, therefore the [LDAP List] tab is not shown on the window.

- If an LDAP server is not used
- If logged in with the guest account
- If logged in with a local account

● e-Mail Targets that Can Be Selected from the e-Mail Address Book

When sending an e-mail, the following e-mail targets can be selected and entered from the e-mail address book.

| e-Mail Target | Icon Shown in the e-Mail Address Book | My List | LDAP List |
|-------------------|---|---------|-----------|
| Group |  | Yes | — (*) |
| Distribution List |  | Yes | — (*) |
| e-Mail Address |  | Yes | Yes |

Yes: Available —: Unavailable

(*): Not shown in the LDAP List

The following explains how to select an e-mail address using the LDAP List.

1. On the [Send e-Mail] window, press  in the e-mail address field.
⇒ The [e-Mail Address Book] window appears.
2. Select the [LDAP List] tab.
⇒ The [e-Mail Address Book] window for the LDAP List appears.
3. Press a search parameter button (either the left, middle, or [e-Mail Address] button) to select a search item.

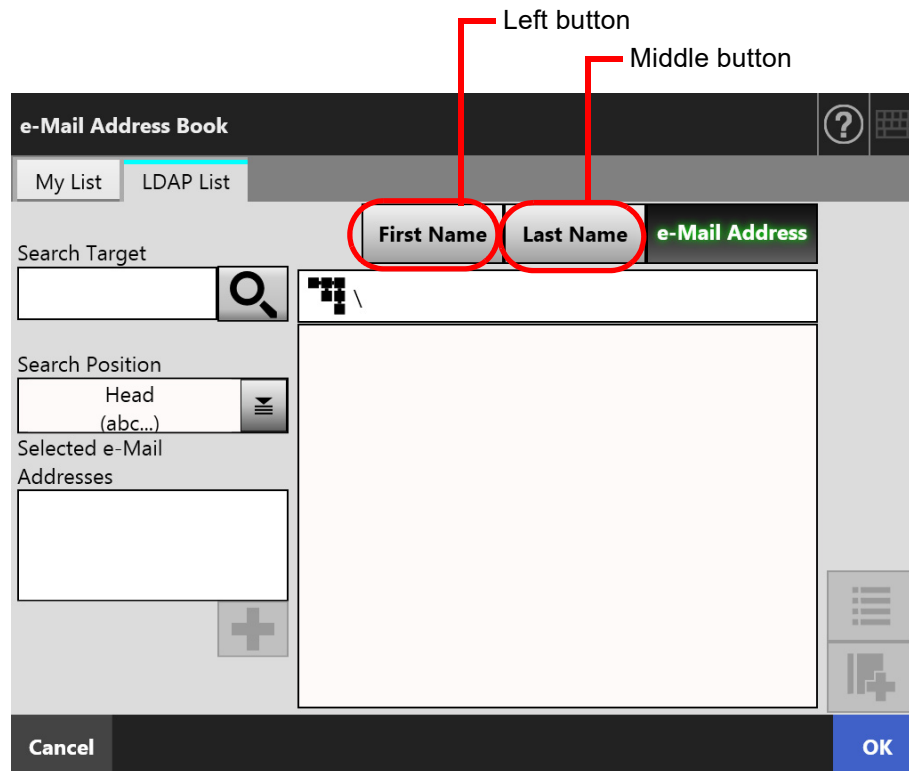
**HINT**

The administrator can customize and specify the search parameters and button names allocated to the left and middle buttons.

For details about customizing the search parameters and the button names, refer to "[4.10.4 Setting the LDAP Search Parameters](#)" (page 123).

4. In the [Search Target] field, enter a part of or entire e-mail address to be searched for.

HINT

For My List, the search string and the search results from the previous search can be

cleared by pressing  button.

5. Press  in [Search Position].
⇒ The [Search Position] window appears.

6. Select a search position setting.



⇒ The window returns to the [e-Mail Address Book] LDAP List. The selected position is displayed in [Search Position].

7. Press .

⇒ The search results are displayed on the right side. Five results are displayed at a time.

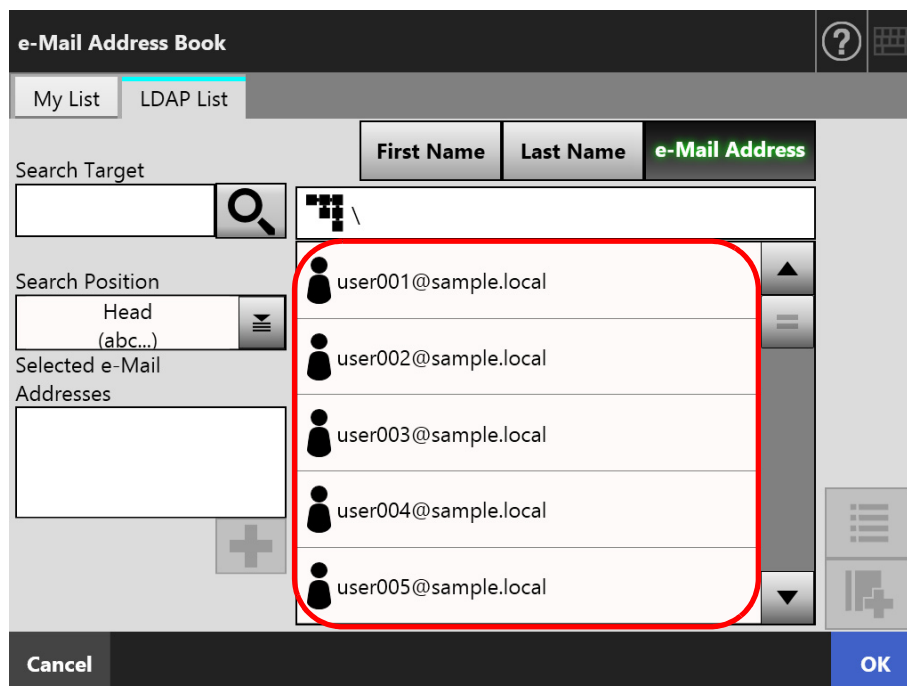

HINT

- The number of search results to be displayed can be set by the administrator. For details, refer to "4.10.2 Setting the e-Mail LDAP Server" (page 121).
- Therefore, search results differ according to the list selected.

| Search String | My List | LDAP List |
|--------------------------|-------------|-------------|
| Case | Insensitive | Insensitive |
| Diacritical/Accent marks | Sensitive | Insensitive |

For My List search, the following also applies.

- All currently displayed levels and their subordinates are searched.
- For groups that are shown in a search result, even if a group is selected,  is disabled and the contacts in the group cannot be viewed.

8. Select the desired e-mail target from the search results and press .

⇒ The selected e-mail address is added to [Selected e-Mail Addresses].

To add multiple e-mail addresses, repeat this step.

HINT

Selecting an e-mail address and pressing  can be used to add the e-mail address to My List.

9. Press the [OK] button.

⇒ The e-mail address is added to the field in the [Send e-Mail] window.

5.4.2 Adding an e-Mail Target to the e-Mail Address Book

The following explains how to add an e-mail address or a distribution list to your My List in the e-mail address book. e-Mail addresses or distribution lists cannot be added to the LDAP List.

The maximum number of e-mail targets that can be saved in the e-mail address book is as follows.

- Total of 5,000 e-mail targets which include groups, distribution lists and/or e-mail addresses
- Total of 10,000 e-mail addresses

1. Open the [e-Mail Address Book] window in either of the following ways.

- On the [Send e-Mail] window, press  in the e-mail address field.
- On the [Main Menu] or [Job Menu] window, press the [Maintenance] button, then on the [Maintenance] window, press the [Edit e-Mail Address] button.

2. Select the [My List] tab.

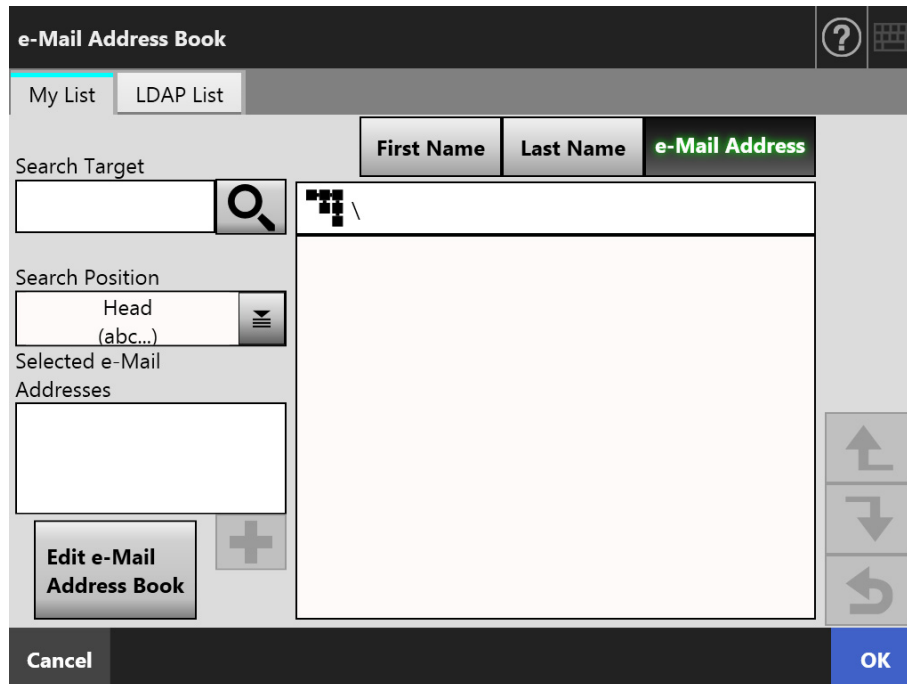

The screenshot shows the 'e-Mail Address Book' window with the 'My List' tab selected. The window contains a search bar labeled 'Search Target' with a magnifying glass icon. Below it is a 'Search Position' dropdown menu currently set to 'Head (abc...)'. A section titled 'Selected e-Mail Addresses' is empty. At the bottom left is an 'Edit e-Mail Address Book' button with a plus sign. The main area is a table with columns 'First Name', 'Last Name', and 'e-Mail Address' (highlighted in green). The table is currently empty. On the right side, there are three navigation buttons: a left arrow, a right arrow, and a refresh/circular arrow button. At the bottom, there are 'Cancel' and 'OK' buttons.

3. Press the [Edit e-Mail Address Book] button.

⇒ The [Edit e-Mail Address Book] window appears.

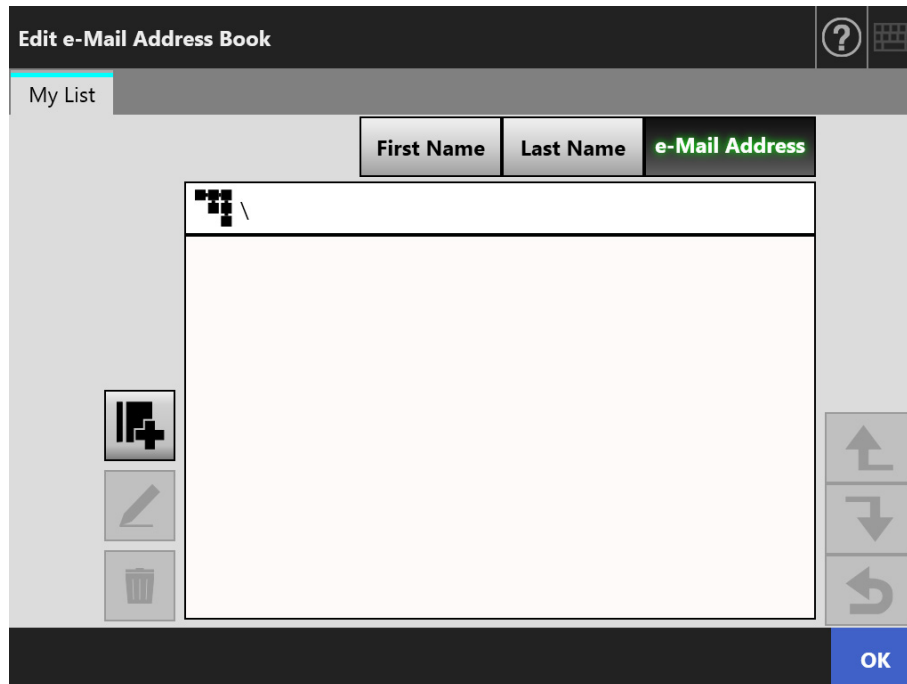
**4. Press .**

To add an e-mail address or distribution list to a group, display the target group and press the button.

⇒ The [Add e-Mail Address] window appears.

5. Enter the information of the e-mail address to be added.

- For e-mail addresses

On the [e-Mail Address] tab, enter the e-mail address, first name, and last name to be added.

For details about e-mail address settings values, refer to ["B.1 e-Mail Address Setting Values"](#) (page 402).

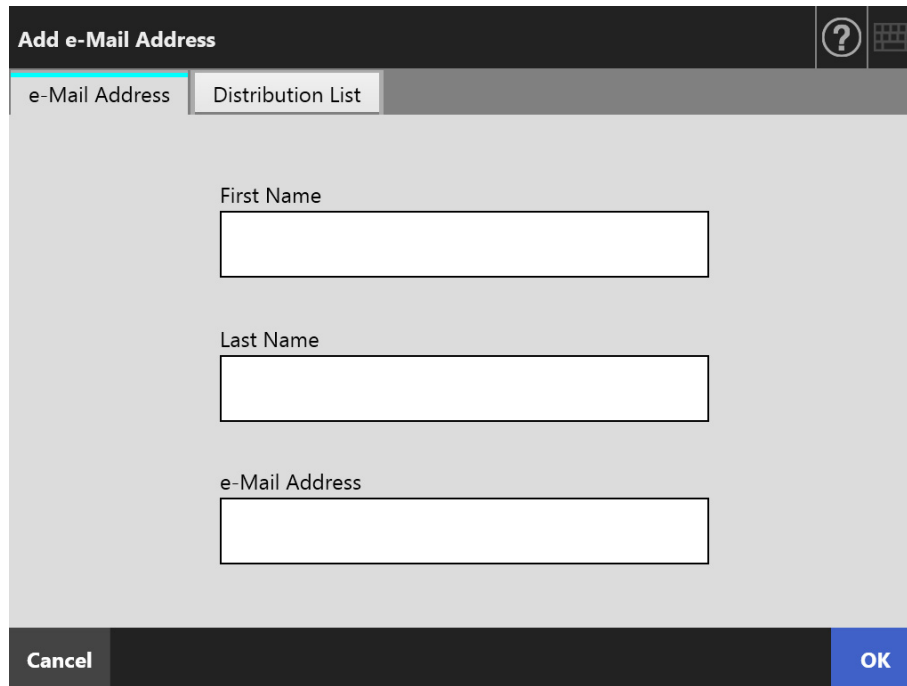

The screenshot shows a dialog box titled "Add e-Mail Address". It has two tabs: "e-Mail Address" (which is selected) and "Distribution List". The dialog contains three input fields: "First Name", "Last Name", and "e-Mail Address". At the bottom of the dialog, there are two buttons: "Cancel" and "OK".

- For distribution lists
On the [Distribution List] tab, enter the list name and e-mail addresses to be added to the distribution list.
For details about e-mail address settings values, refer to ["B.1 e-Mail Address Setting Values"](#) (page 402).

HINT

e-Mail addresses can be selected from the e-mail address book, which can be accessed



by pressing . For details, refer to ["5.4.1 Selecting an e-Mail Target from the e-Mail Address Book"](#) (page 232).

If the e-mail address book cannot be used, contact the administrator.

The screenshot shows a dialog box titled "Add e-Mail Address". It has two tabs: "e-Mail Address" and "Distribution List", with the latter being active. The "Distribution List" tab contains a "List Name" text input field and an "e-Mail Addresses" list input field. The "e-Mail Addresses" field has a small button with a downward arrow on its right side. At the bottom of the dialog, there are "Cancel" and "OK" buttons.

6. Press the [OK] button.

⇒ The e-mail addresses and distribution lists are added to your My List.

HINT

My List can also be edited using User Editor. For details, refer to ["Appendix F Editing Using User Editor"](#) (page 428).

5.4.3 Editing an e-Mail Target in the e-Mail Address Book

The following explains how to edit My List in the e-mail address book. LDAP List cannot be edited.

1. Perform the steps from **Step 1** to **Step 3** in "[5.4.2 Adding an e-Mail Target to the e-Mail Address Book](#)" (page 236) to show the [e-Mail Address Book] window.
2. Select the e-mail address or distribution list to be edited.
3. Press .
⇒ The [Edit e-Mail Address] window appears.
4. Edit the information.
 - For e-mail addresses
Enter the e-mail address, first name, and last name to be added.
For details about e-mail address settings values, refer to "[B.1 e-Mail Address Setting Values](#)" (page 402).

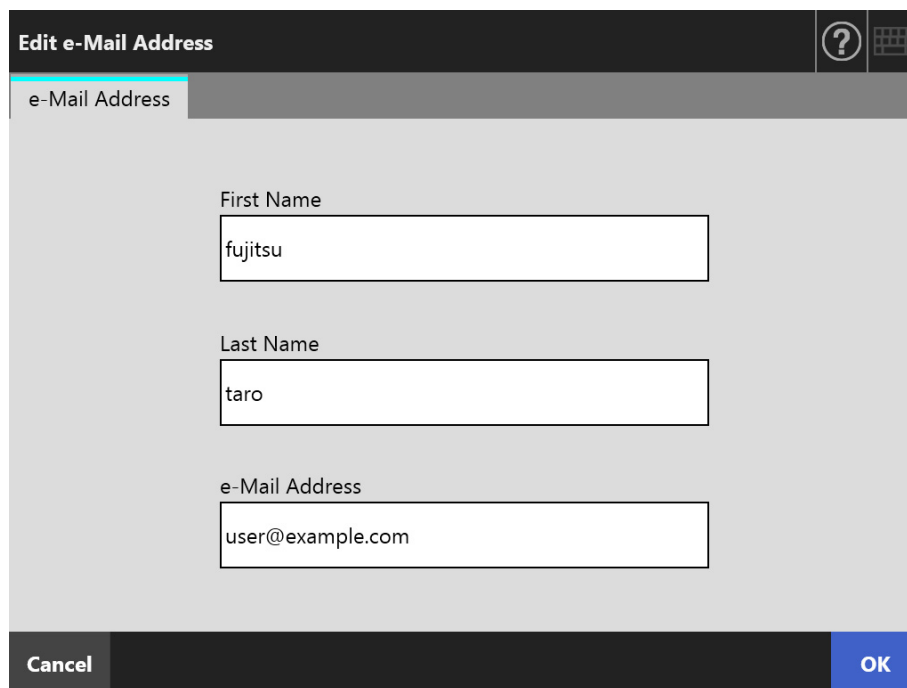

Edit e-Mail Address

e-Mail Address

First Name
fujitsu

Last Name
taro

e-Mail Address
user@example.com

Cancel OK

- For distribution lists
Enter the list name and e-mail addresses to be added to the distribution list.
For details about e-mail address settings values, refer to "[B.1 e-Mail Address Setting Values](#)" (page 402).

HINT

e-Mail addresses can be selected from the e-mail address book, which can be accessed



by pressing . For details, refer to "[5.4.1 Selecting an e-Mail Target from the e-Mail Address Book](#)" (page 232).

If the e-mail address book cannot be used, contact the administrator.

5. Press the [OK] button.

⇒ The edited e-mail address is saved in your My List address book.

HINT

My List can also be edited using User Editor. For details, refer to "[Appendix F Editing Using User Editor](#)" (page 428).

5.4.4 Deleting an e-Mail Target from the e-Mail Address Book

The following explains how to delete an e-mail address or a distribution list from your My List. e-Mail targets cannot be deleted from the LDAP List.

1. Perform the steps from **Step 1 to Step 3** in "[5.4.2 Adding an e-Mail Target to the e-Mail Address Book](#)" (page 236) to show the [e-Mail Address Book] window.
2. Select the e-mail address or distribution list to be deleted.
3. Press .
 - ⇒ The [Delete e-Mail Address] window appears.
 - The following is an example window which is shown when an e-mail address is selected to be deleted.
4. Check that the correct e-mail target has been set for deletion and press the [OK] button.

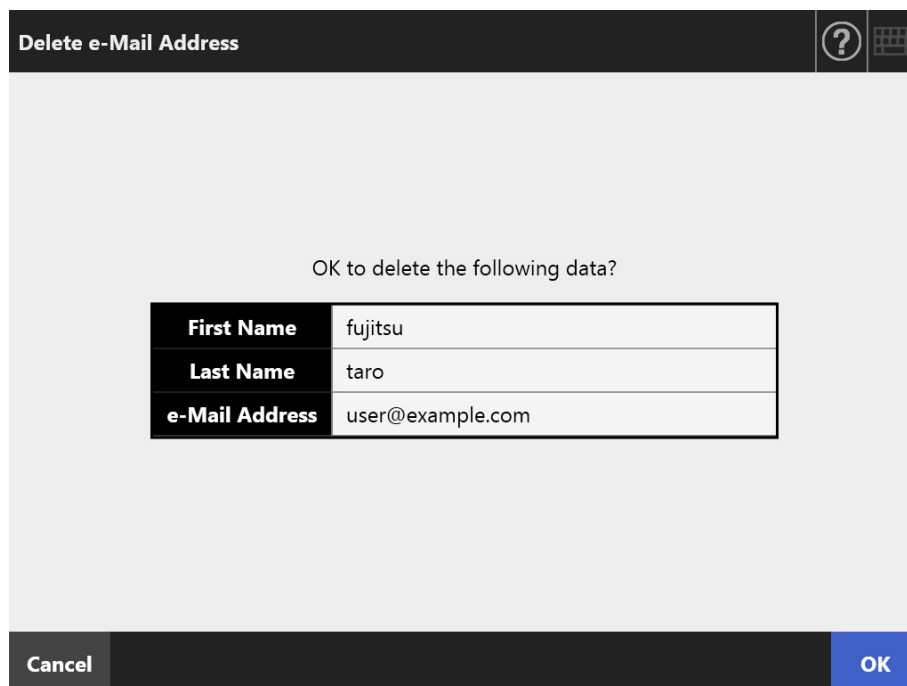

⇒ The e-mail target is deleted from the e-mail address book.

HINT

My List can also be edited using User Editor. For details, refer to "[Appendix F Editing Using User Editor](#)" (page 428).

5.5 Sending the Scanned Data by Fax

1. On the [Main Menu] window, press the [Fax] button.

⇒ The [Send Fax] window appears.

HINT

The scan information can be changed by pressing  of [Scan Settings]. For details, refer to ["5.8 Setting the Scan Options"](#) (page 264).

2. Enter a fax number into the [Recipient Fax No.] field.

HINT

Fax numbers can be selected from the fax number list by pressing . For details, refer to ["5.5.1 Selecting a Fax Number from the Fax Number List"](#) (page 245).

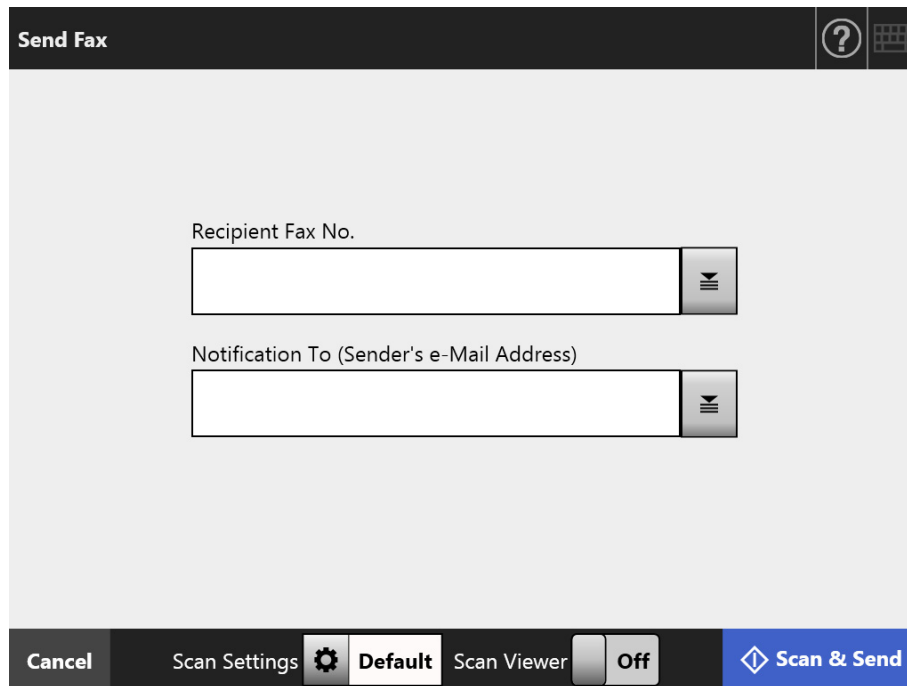

3. Enter the e-mail address that is used to notify the result of fax sent or the sender's e-mail address in [Notification To (Sender's e-Mail Address)].

If nothing is specified for [From] in the pane that is displayed when [Fax Server] is selected under [Fax] on the administrator window, enter an e-mail address.

For details about e-mail address settings values, refer to ["B.1 e-Mail Address Setting Values"](#) (page 402).

4. Specify the rest of the items.

HINT

The [Clear the authentication settings] button is displayed when [SMTP Authentication] is enabled in [SMTP Server Extension] on the administrator window. For more details, refer to "[4.11.2 Setting the SMTP Server \(Extension\)](#)" (page 126).

Pressing this button enables you to clear the authentication information that you have set.

5. Press the [Scan & Send] button.

When [Scan Viewer] is [On], this will be the [Scan] button.

⇒ Scanning starts.

⇒ The scanned data is sent by fax immediately after the scanning is completed, and the touch panel screen returns to the [Main Menu] window.

HINT

If the [SMTP Authentication] window appears, enter authentication information needed to access the SMTP server and press the [OK] button.

HINT

- When [Scan Viewer] is [On], the [Scan Viewer] window appears once scanning is complete. The maximum number of pages that can be scanned is 999. When the blank page skip function is enabled, the number of scanned pages excluding skipped blank pages is shown. Additional pages can be scanned in place of skipped blank pages, until the maximum number of scanned pages is reached. Scanned data can be checked on the [Scan Viewer] window. The scanned data can be edited on the scan viewer details window which is displayed after a scanned image is selected. For more details, refer to "[5.10 Editing the Scanned Data in the Scan Viewer](#)" (page 309). For more details about displaying the [Scan Viewer] window, refer to "[5.9 Enabling/Disabling the Scan Viewer](#)" (page 306).
- If data fails to be sent to the fax server, an error notification e-mail with the following title is sent from the scanner to the e-mail address of the user who has logged in.
Network Scanner (XXXX) Error

5.5.1 Selecting a Fax Number from the Fax Number List

When sending a fax, instead of directly entering a fax number with keyboard, fax numbers may be selected from a fax number list.

To enter a fax number using the fax number list, refer to [Step 2](#) of "5.5 Sending the Scanned Data by Fax" (page 243).

1. On the [Send Fax] window, press  on the right side of the recipient fax No. field.

⇒ The [Fax Number List] window appears.

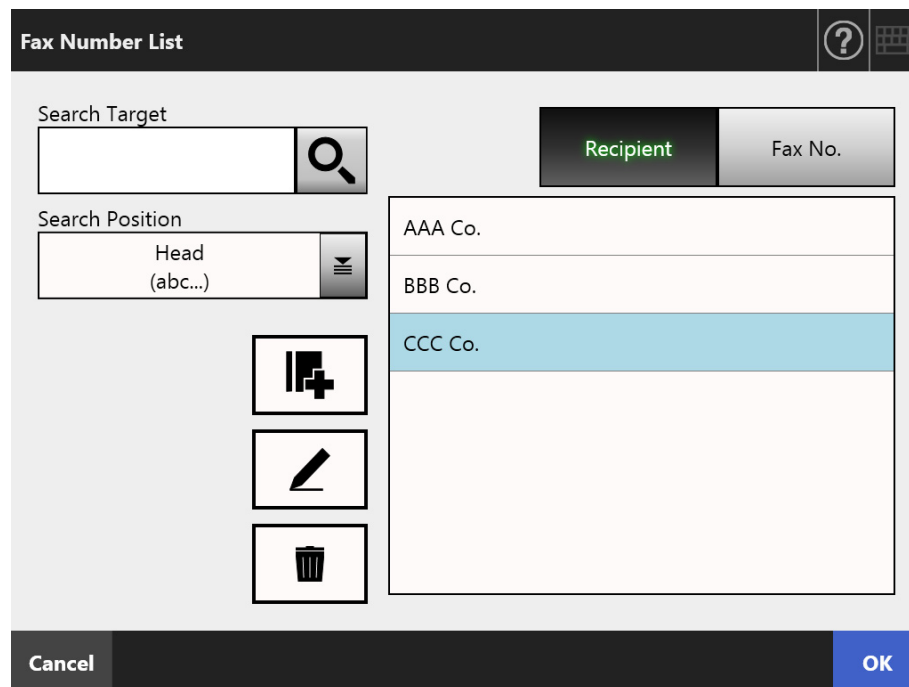

2. Press a search parameter button (either the [Recipient] or [Fax No.] button) to select a search item.
3. In [Search Target], enter a search string.

4. Press  in [Search Position].

⇒ The [Search Position] window appears.

5. Select a search position setting.



⇒ The window returns to the [Fax Number List]. The search method that you selected is set in [Search Position].

6. Press .

⇒ Five results are displayed at a time.

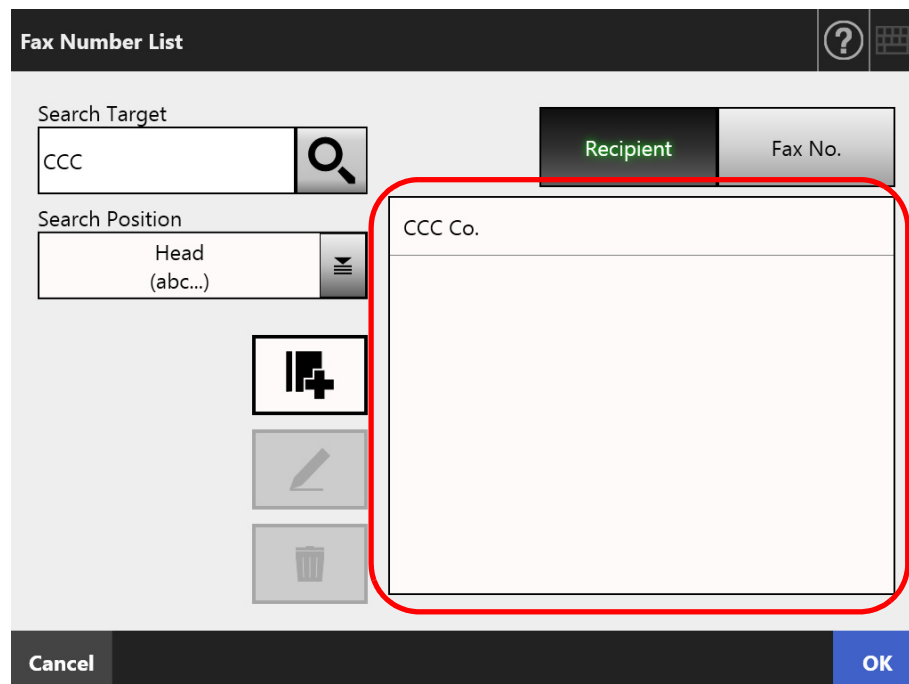

7. Select a destination for sending the fax from the search results.

8. Press the [OK] button.

⇒ The fax number is added to the field in the [Send Fax] window. Only one fax number can be entered at a time.

5.5.2 Adding a Contact to the Fax Number List

This section describes how to add a contact to the fax number list.

A maximum of 1,000 fax numbers can be saved in the fax number list. You cannot add any more fax numbers if the list already contains 1,000 fax numbers.

HINT

Fax contact numbers added to the list are accessible to all users.

1. Open the [Fax Number List] window in either of the following ways.

- On the [Send Fax] window, press  on the right side of the recipient fax No. field.
- On the [Main Menu] or [Job Menu] window, press the [Maintenance] button, then on the [Maintenance] window, press the [Edit Fax Numbers] button.

2. Press .

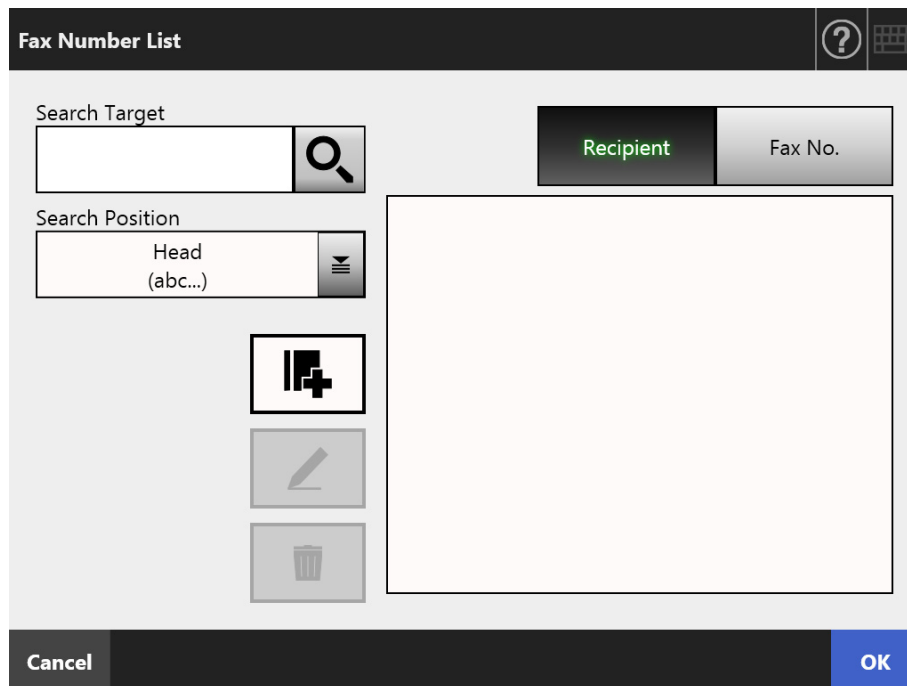

⇒ The [Add Fax Number] window appears.

3. Enter the fax contact details.

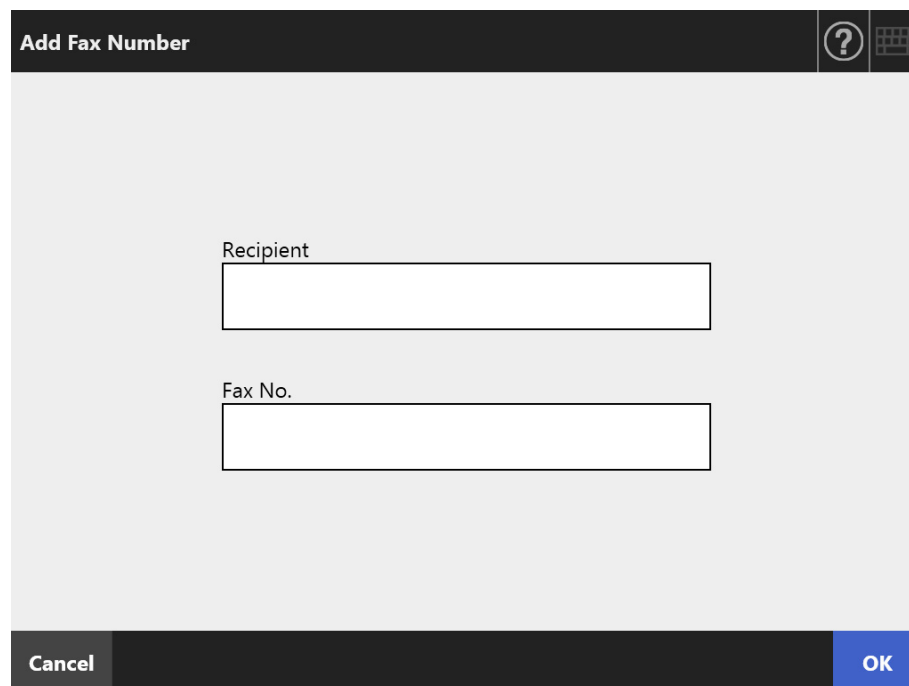

The screenshot shows a dialog box titled "Add Fax Number". The title bar is dark grey and contains the text "Add Fax Number" on the left, a question mark icon in a circle in the middle, and a keyboard icon on the right. The main area of the dialog is light grey and contains two text input fields. The first field is labeled "Recipient" and the second is labeled "Fax No.". At the bottom of the dialog, there is a dark grey bar with a "Cancel" button on the left and an "OK" button on the right.

4. Press the [OK] button.

⇒ The contact is added to the fax number list.

5.5.3 Editing the Fax Number List

Edited fax contact numbers are accessible to all users.

1. Open the [Fax Number List] window in either of the following ways.

- On the [Send Fax] window, press  on the right side of the recipient fax No. field.
- On the [Main Menu] or [Job Menu] window, press the [Maintenance] button, then on the [Maintenance] window, press the [Edit Fax Numbers] button.

2. Select a fax number to be edited.

3. Press .

⇒ The [Edit Fax Number] window appears.

4. Edit the information.

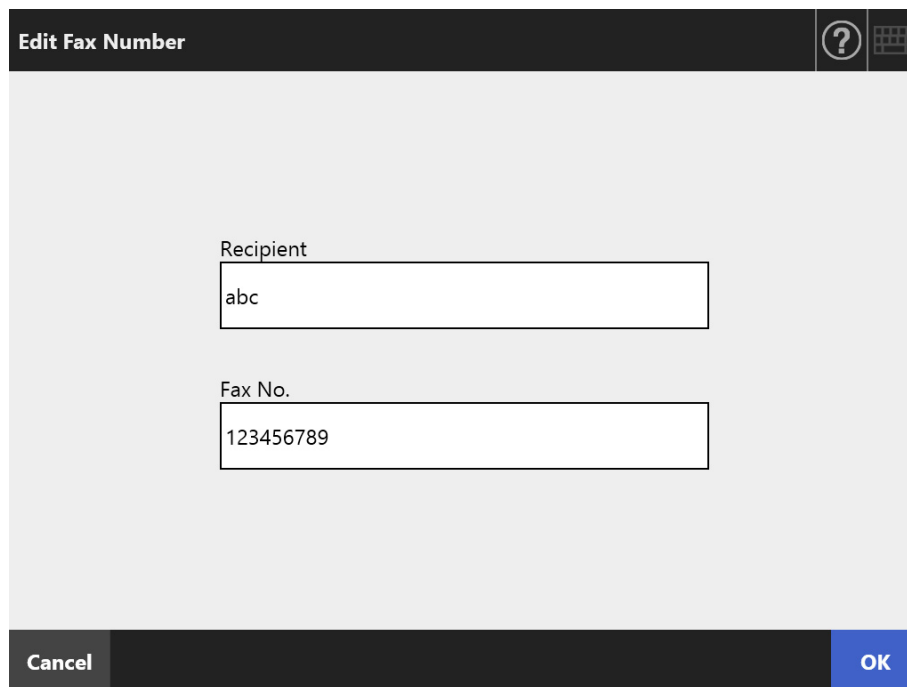

The screenshot shows a dialog box titled "Edit Fax Number". It has a dark header bar with a question mark icon and a keyboard icon. The main area is light gray and contains two text input fields. The first field is labeled "Recipient" and contains the text "abc". The second field is labeled "Fax No." and contains the text "123456789". At the bottom of the dialog, there are two buttons: "Cancel" on the left and "OK" on the right.

5. Press the [OK] button.

⇒ The edited fax number list contact is saved.

5.5.4 Deleting a Contact from the Fax Number List

Fax contact numbers deleted from the list are no longer accessible to any user.

1. Open the [Fax Number List] window in either of the following ways.

- On the [Send Fax] window, press  on the right side of the recipient fax No. field.
- On the [Main Menu] or [Job Menu] window, press the [Maintenance] button, then on the [Maintenance] window, press the [Edit Fax Numbers] button.

2. Select the fax contact that is to be deleted.

3. Press .

⇒ The [Delete Fax Number] confirmation window appears.

4. Check that the correct fax contact has been set for deletion and press the [OK] button.

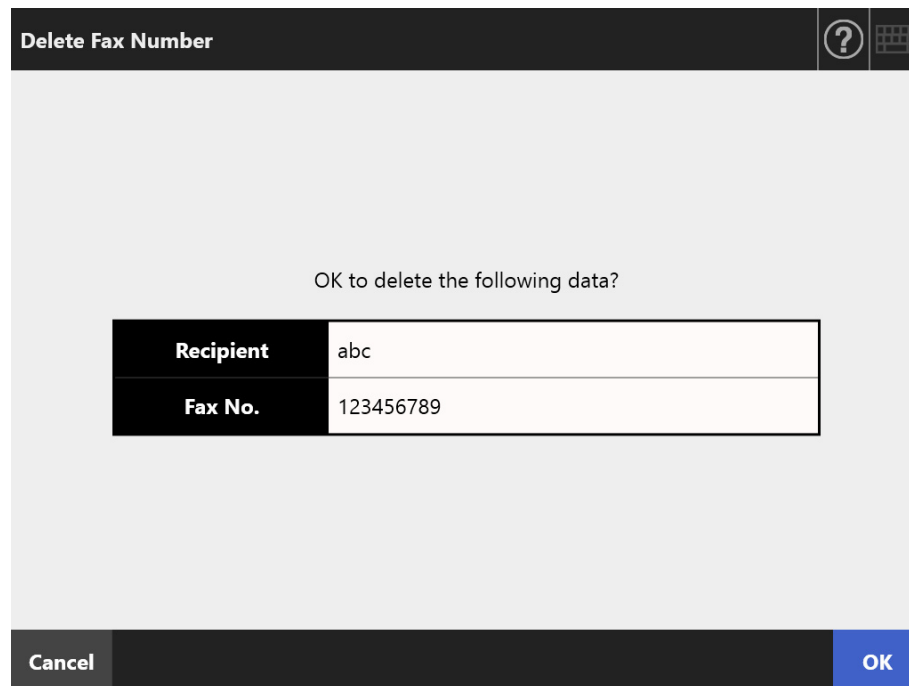

Delete Fax Number

OK to delete the following data?

| | |
|-----------|-----------|
| Recipient | abc |
| Fax No. | 123456789 |

Cancel OK

⇒ The contact is deleted from the fax number list.

5.6 Printing the Scanned Data

1. On the [Main Menu] window, press the [Print] button.

⇒ The [Print] window appears.

HINT

The scan information can be changed by pressing  of [Scan Settings]. For details, refer to "5.8 Setting the Scan Options" (page 264).

2. To change the printer, press .

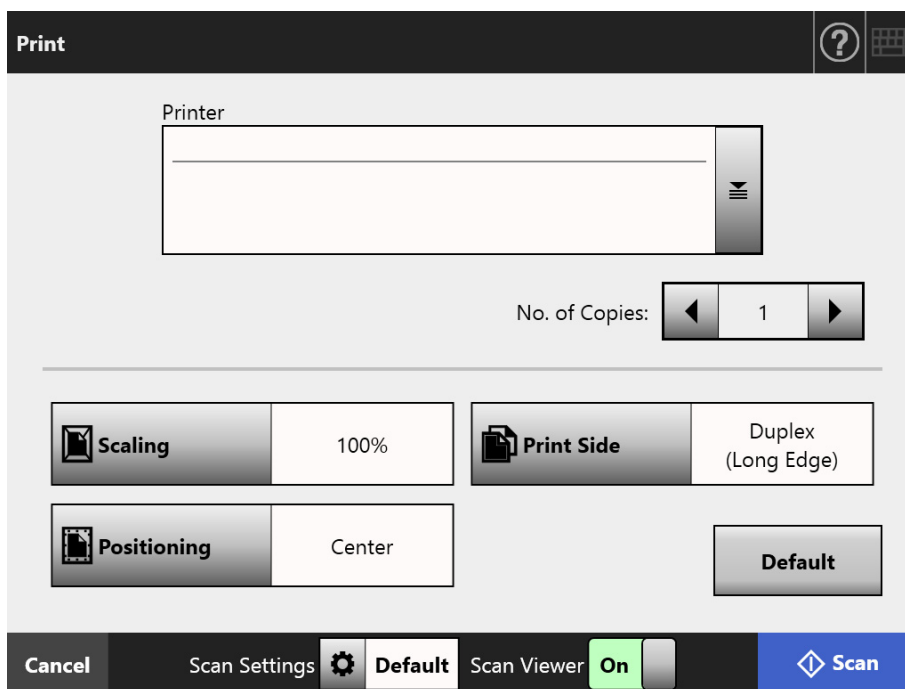

⇒ The [Printer List] window appears.

3. Select a target printer and press the [OK] button.

HINT

- Only printers which were added in the list by the administrator can be selected. To change the printers in the list, contact the administrator.
For more details about adding printers, refer to ["4.14 Setting the Network Printers" \(page 146\)](#).
- If the [Clear the authentication settings] button is enabled, you can clear the authentication information that you have set for the selected network printer.

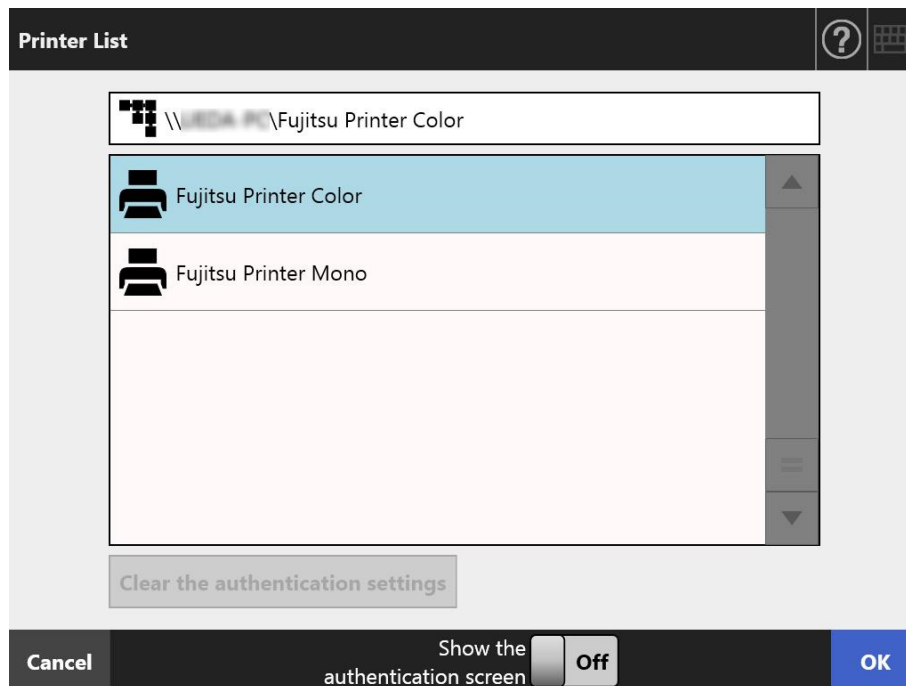

⇒ This returns you to the [Print] window.

HINT

- If the [Print Server Authentication] window appears, enter authentication information needed to access the network printer and press the [OK] button.
- If you select [On] for [Show the authentication screen] and then press the [OK] button, the authentication window for the selected network printer appears. You can change the authentication information on this window.
- On the scanner, printing rights for the printer server are checked before printing can be performed. When printing rights are being checked, data may be spooled temporarily.

4. Enter a number in [No. of Copies] field.

5. Make any required print setting changes.

The scaling, positioning, and print mode settings can be changed.
For details, refer to the following.

["5.6.1 Scaling" \(page 254\)](#)

["5.6.2 Positioning" \(page 258\)](#)

["5.6.3 Print Side" \(page 260\)](#)

To return the print settings to the factory settings, press the [Default] button.

6. Specify the rest of the items.**7. Press the [Scan] button.**

When [Scan Viewer] is [Off], this will be a [Scan & Print] button.

⇒ The scanning starts.

When [Scan Viewer] is [Off], the scan settings and scanning status (preview) can be switched and shown during a scan.

When [Scan Viewer] is [On], the [Scan Viewer] window appears.

The maximum number of pages that can be scanned is 100.

When the blank page skip function is enabled, the number of scanned pages excluding skipped blank pages is shown.

Additional pages can be scanned in place of skipped blank pages, until the maximum number of scanned pages is reached.

⇒ When the scanning has completed, the [Scan Viewer] window appears.

HINT

- If the [Scan & Send] button is pressed when [Scan Viewer] is [Off], the scanned data is printed immediately after the scanning is complete, and the touch panel screen returns to the [Main Menu]. For details, refer to "[5.9 Enabling/Disabling the Scan Viewer](#)" (page 306).
- On the scanner, printing rights for the printer server are checked before printing can be performed. When printing rights are being checked, data may be spooled temporarily.

8. Check and edit the scanned data.

Scanned data can be checked on the [Scan Viewer] window. The scanned data can be edited on the scan viewer details window which is displayed after a scanned image is selected.

For more details, refer to "[5.10 Editing the Scanned Data in the Scan Viewer](#)" (page 309).

9. On the [Scan Viewer] window, press the [Print] button.

⇒ The scanned data is sent to the print server and printed.

The document name for the scanned data to be printed is the name of the scanner.

ATTENTION

The user log shows the result of the process until the scanned data has been sent to the print server. The network printer printing result is not included. For more details about the user log, refer to "[5.11.1 Viewing Details on Send Operations That Were Completed \(User Log\)](#)" (page 319).

HINT

If the printing fails, an error notification e-mail with the following title is sent from the scanner to the e-mail address of the user that logged in with the LDAP server authentication.

Network Scanner (XXXX) Error

5.6.1 Scaling

Set whether to print the scanned data according to the printing paper size. The setting selected here will be used every time the user prints a document.

1. On the [Print] window, press the [Scaling] button.

⇒ The [Scaling] window appears.

2. Select the print scale of the scanned data.

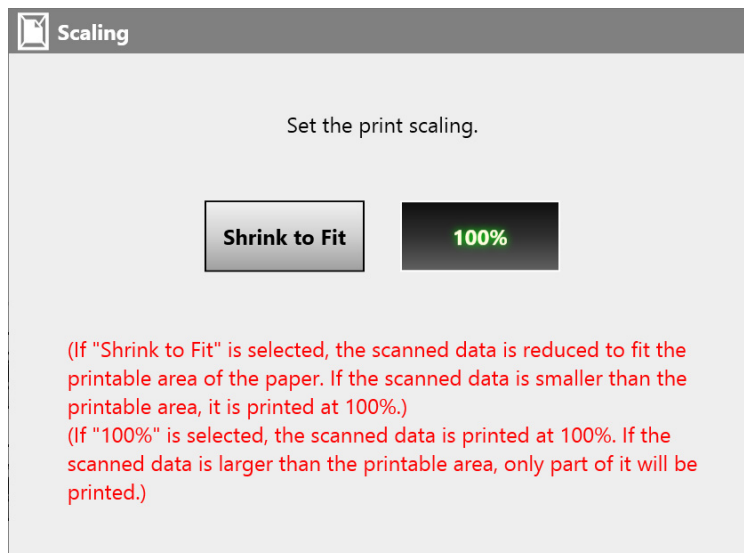









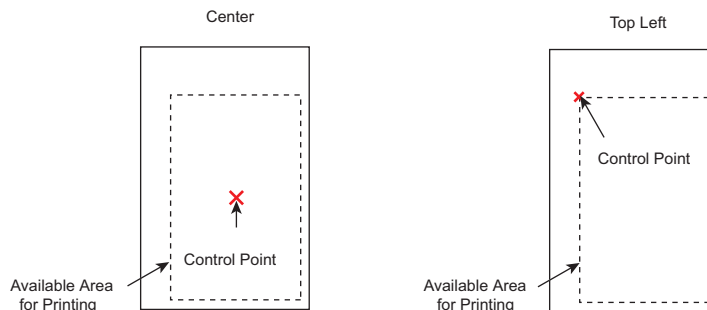

Printing results will vary as shown below, depending on the positioning setting. For more details on the positioning setting, refer to ["5.6.2 Positioning" \(page 258\)](#).

- Shrink to Fit

The image is reduced so that the entire image fits into the area available for printing (area inside the dotted line). Further enlargement is not possible.

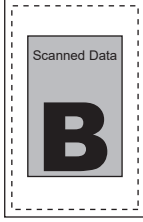





- If the positioning setting is [Center], the control point for printing is the center point of the area available for printing.
- If the positioning setting is [Top Left], the control point for printing is the top left corner of the area available for printing.

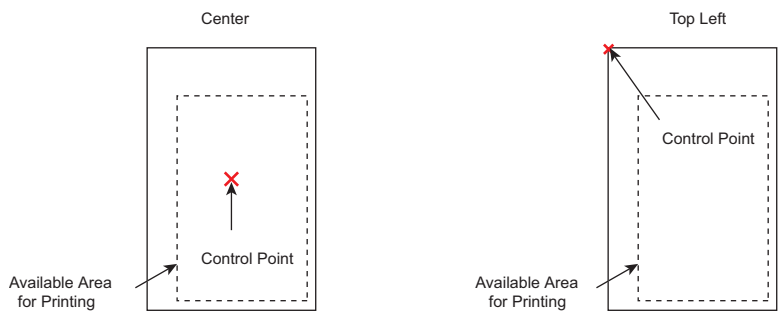



| Print Sheet | Scanned Data | Positioning | Result |
|---|---|-------------|---|
| <p>Small</p>  | <p>Large</p>  | Center |  |
| | | Top Left |  |
| <p>Large</p>  | <p>Small</p>  | Center |  |
| | | Top Left |  |
| <p>Same</p>  | <p>Same</p>  | Center |  |
| | | Top Left | |

- 100%
The image is printed at full scale, regardless of the paper size.
 - If the positioning setting is [Center], the control point for printing is the center point of the print sheet.
 - If the positioning setting is [Top Left], the control point for printing is the top left corner of the print sheet.

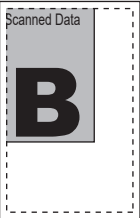

| Print Sheet | Scanned Data | Positioning | Result |
|--|--|-------------|---|
| Small  | Large  | Center |  |
| | | Top Left | |
| Large  | Small  | Center |  |
| | | Top Left |  |

| Print Sheet | Scanned Data | Positioning | Result |
|---|---|-------------|---|
| Same  | Same  | Center |  |
| | | Top Left | |

⇒ This returns you to the [Print] window. The selected scaling setting is displayed to the right of the [Scaling] button.

ATTENTION
 For more details about edge filling, refer to "[5.8.17 Filling the Edge of Scanned Image \(Edge Correction\)](#)" (page 298).

5.6.2 Positioning

Set the print position of the scanned data.

The setting selected here will be used every time the user prints a document.

1. On the [Print] window, press the [Positioning] button.

⇒ The [Positioning] window appears.

2. Select the print positioning of the data.

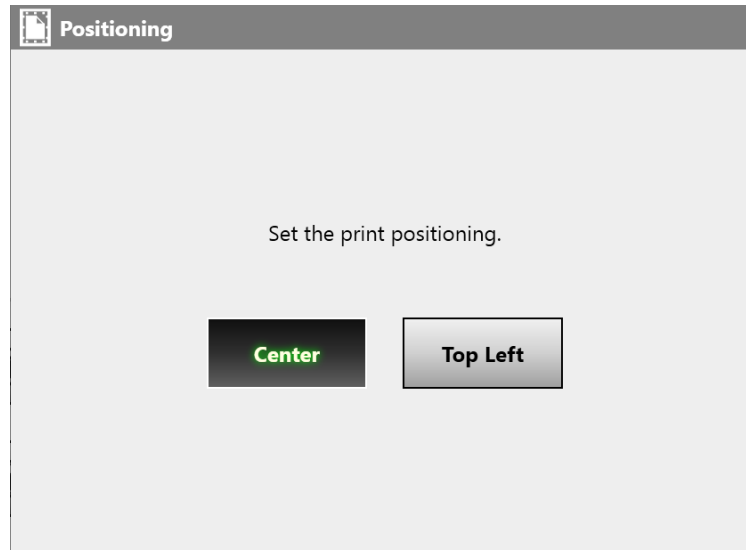

Printing results will vary as shown below, depending on the scaling setting. For more details on the scaling setting, refer to ["5.6.1 Scaling" \(page 254\)](#).

| Button | Scaling | Control Point |
|--------|---------------|---|
| Center | Shrink to Fit | <p>Uses the center point of the area available for printing as a control point.</p> |

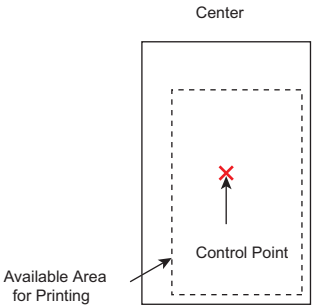
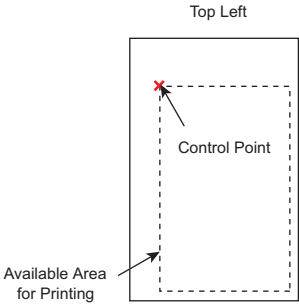
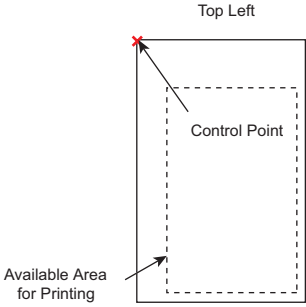
| Button | Scaling | Control Point |
|----------|---------------|--|
| Center | 100% | <p>Uses the center point of the sheet as a control point.</p>  |
| Top Left | Shrink to Fit | <p>Uses the top left corner of the area available for printing as a control point.</p>  |
| | 100% | <p>Uses the top left corner of the print sheet as a control point.</p>  |

⇒ This returns you to the [Print] window. The selected positioning setting is displayed to the right of the [Positioning] button.

5.6.3 Print Side

Set whether to print on one side (simplex mode) or both sides (duplex mode).

1. On the [Print] window, press the [Print Side] button.

⇒ The [Print Side] window appears.

2. Select a print mode.

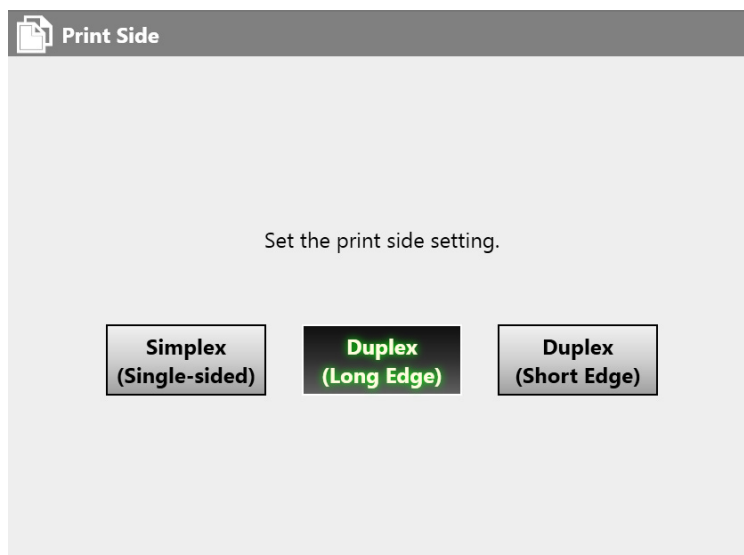

⇒ This returns you to the [Print] window. The selected mode is displayed to the right of the [Print Side] button.

5.7 Saving the Scanned Data to a Network Folder

Save the scanned data to a network folder, an FTP server folder, or a SharePoint folder.

1. On the [Main Menu] window, press the [Save] button.

⇒ The [Save] window appears.

HINT

The scan information can be changed by pressing  of [Scan Settings]. For details, refer to "5.8 Setting the Scan Options" (page 264).

2. Press .

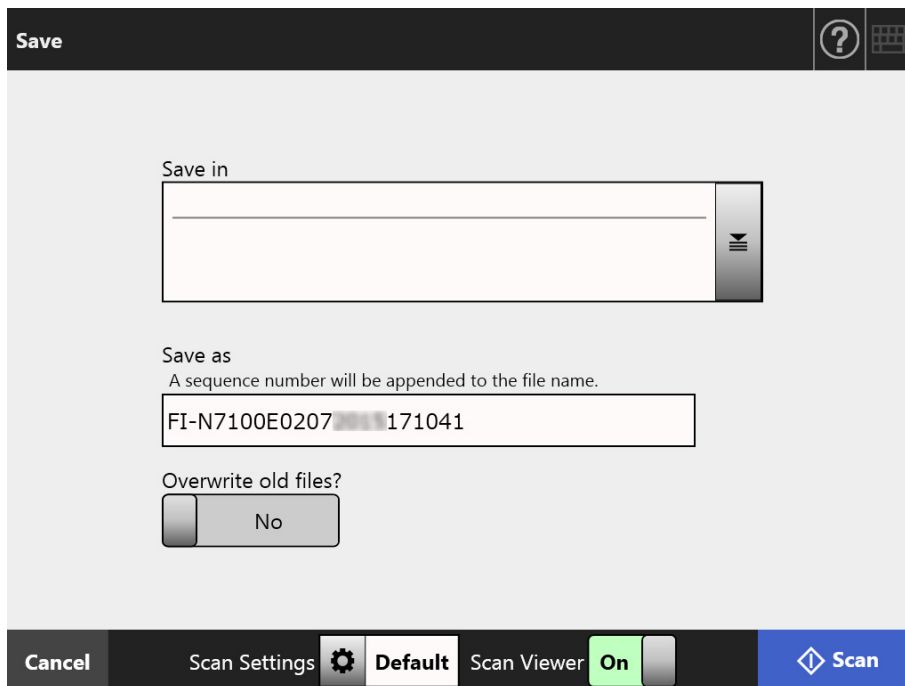

⇒ The [Folder List] window appears.

3. Select a folder for saving the scanned data.

HINT

- You can select a folder from the list of folders that are added by the administrator in advance. To change the folders in the list, contact the administrator.
For more details about adding network folders, refer to "4.13.1 Setting the Network Folders" (page 130).
For more details about adding FTP server folders, refer to "4.13.2 Setting the FTP Server Folders" (page 136).
For more details about adding SharePoint folders, refer to "4.13.3 Setting the SharePoint Folders" (page 140).
- If the [Clear the authentication settings] button is enabled, you can clear the authentication information that you have set for the selected network folder, the selected FTP server folder or the selected SharePoint folder.

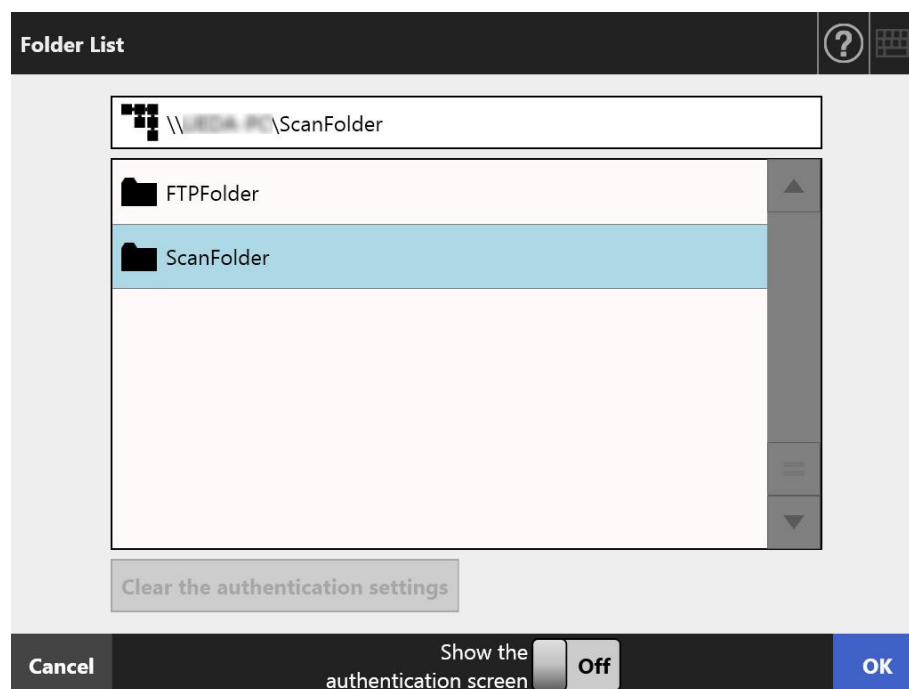

4. Press the [OK] button.

⇒ This returns you to the [Save] window.

HINT

- If the [File Server Authentication] window appears, enter authentication information needed to access the file server, FTP server or SharePoint server, and press the [OK] button.
- If you select [On] for [Show the authentication screen] and then press the [OK] button, the authentication window for the selected network folder, the selected FTP server folder or the selected SharePoint folder appears. You can change the authentication information on this window.

5. In the [Save as] field, enter a file name for the scanned data to be saved.

6. Select whether or not to overwrite an existing file with the same name.

Whether or not the file was successfully saved can be checked in the user log.

For more details about accessing the user log, refer to ["5.11.1 Viewing Details on Send Operations That Were Completed \(User Log\)"](#) (page 319).

7. Specify the rest of the items.

8. Press the [Scan] button.

When [Scan Viewer] is [Off], this will be a [Scan & Save] button.

⇒ Scanning starts.

When [Scan Viewer] is [Off], the scan settings and scanning status (preview) can be switched and shown during a scan.

When [Scan Viewer] is [On], the [Scan Viewer] window appears.

The maximum number of pages that can be scanned is 999.

When the blank page skip function is enabled, the number of scanned pages excluding skipped blank pages is shown.

Additional pages can be scanned in place of skipped blank pages, until the maximum number of scanned pages is reached.

⇒ When the scanning has completed, the [Scan Viewer] window appears.

HINT

If the [Scan & Save] button is pressed when [Scan Viewer] is [Off], the scanned data is saved immediately after the scanning is complete, and the touch panel screen returns to the [Main Menu]. For details, refer to ["5.9 Enabling/Disabling the Scan Viewer"](#) (page 306).

9. Check and edit the scanned data.

Scanned data can be checked on the [Scan Viewer] window. The scanned data can be edited on the scan viewer details window which is displayed after a scanned image is selected.

For more details, refer to ["5.10 Editing the Scanned Data in the Scan Viewer"](#) (page 309).

10. On the [Scan Viewer] window, press the [Save] button.

⇒ A file in the specified file format is saved in the selected folder.

⇒ The [Main Menu] window is shown again.

HINT

If saving to the folder fails, an error notification e-mail with the following title is sent from the scanner to the e-mail address of the user that logged in with the LDAP server authentication.

Network Scanner (XXXX) Error

5.8 Setting the Scan Options

The scan settings window appears by pressing the [Scan Settings]  in the following windows.

- [Send e-Mail] window
- [Send Fax] window
- [Print] window
- [Save] window

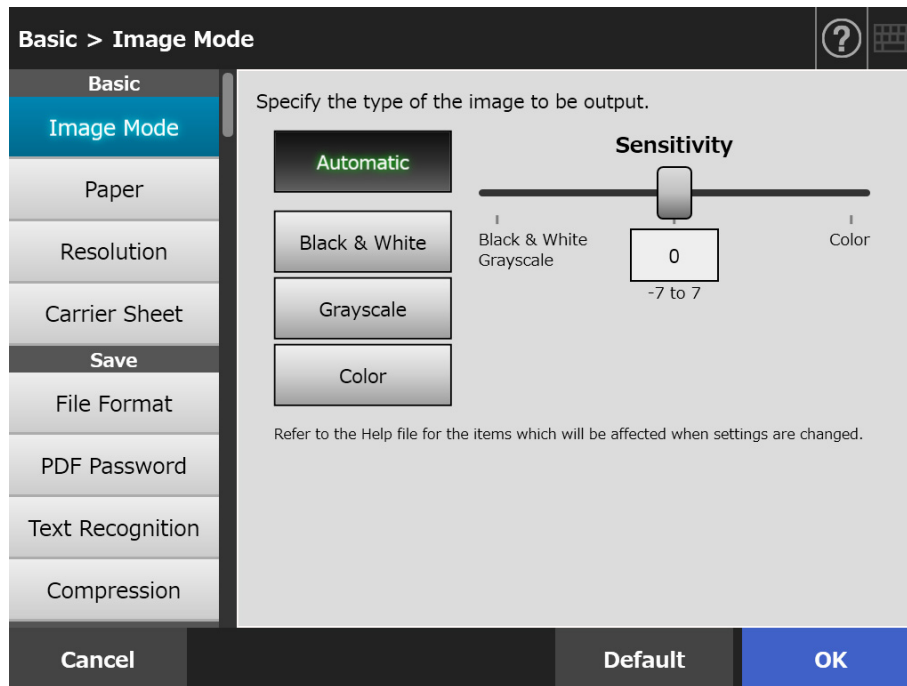

The following types of scan settings are available.

- **Default**
The recommended values are set automatically by applying the default.
- **Custom**
The user can change the default settings and customize any scanning preferences as needed.
From each menu, make individual settings.

Function settings (for e-Mail, Fax, Print, and Save) are saved for each user, and will be used each time that user logs in.

For details, refer to "[5.8.2 Setting Image Mode](#)" (page 276).

HINT

When the scan settings window is opened from the [Print] window, the [Save] menu is grayed out.

5.8.1 Relational Changes among Scan Setting Items

Changing one scan setting item affects other scan setting items.
The following table shows how the setting items are affected by each other.

■ Basic

| Item | Settings which become invalid when an item in the Item column is set | Conditions which make an item in the Item column invalid |
|-------------------|---|--|
| Image Mode | | |
| Automatic | <ul style="list-style-type: none"> ● Paper Size, [8.5 × 17 in.] ● Paper Size, [8.5 × 34 in.] ● Paper Size, [8.5 × 125 in.] ● Paper Size, [Custom] a value more than 14 in. ● File Format, [JPEG] | <ul style="list-style-type: none"> ● Processing type, [Fax], and Fax Service, [Type 1] or [Type 2] (for the scan settings on the [Send Fax] window) |
| Black & White | <ul style="list-style-type: none"> ● Image Mode, [Sensitivity] ● File Format, [JPEG] ● Text Recognition, [OCR Highlighted Text Recognition] ● Text Recognition, [Edit OCR Highlighted Text] ● Compression, Compression rate ● Compression, [High Compression for Color PDF] ● Control Image Tone ● Cleanup ● sRGB Output (when setting a job sequence) | — |

| Item | Settings which become invalid when an item in the Item column is set | Conditions which make an item in the Item column invalid |
|--------------------------------|--|---|
| Image Mode (continued) | | |
| Grayscale | <ul style="list-style-type: none"> ● Image Mode, [Sensitivity] ● Text Recognition, [OCR Highlighted Text Recognition] ● Text Recognition, [Edit OCR Highlighted Text] ● Compression, [High Compression for Color PDF] ● Thresholding Cleanup (Black & White) ● sRGB Output (when setting a job sequence) | <ul style="list-style-type: none"> ● Processing type, [Fax], and Fax Service, [Type 1] or [Type 2] (for the scan settings on the [Send Fax] window) |
| Color | <ul style="list-style-type: none"> ● Image Mode, [Sensitivity] ● Thresholding ● Cleanup (Black & White) ● Dropout Color | <ul style="list-style-type: none"> ● Processing type, [Fax], and Fax Service, [Type 1] or [Type 2] (for the scan settings on the [Send Fax] window) |
| Sensitivity | — | <ul style="list-style-type: none"> ● Image Mode, [Black & White] ● Image Mode, [Grayscale] ● Image Mode, [Color] |
| Paper | | |
| Paper Source | | |
| Feeder (Single Side) | ● Rotation, [Flip Type] | ● Carrier Sheet, [A3] |
| Feeder (Both Sides) | — | <ul style="list-style-type: none"> ● Carrier Sheet, [B4 (JIS)] ● Carrier Sheet, [Double Letter] |
| Document Feed Direction | | |
| Face-down | — | — |
| Face-up | ● Index Output, [Yes] | <ul style="list-style-type: none"> ● Separation Mode, [Number of pages] (when setting a job sequence) ● Separation Mode, [Patch code] (when setting a job sequence) |

| Item | Settings which become invalid when an item in the Item column is set | Conditions which make an item in the Item column invalid |
|---|---|---|
| Paper Size | | |
| Automatic | <ul style="list-style-type: none"> ● Resolution, [600dpi] ● Resolution, [Custom] 301 dpi or more | <ul style="list-style-type: none"> ● Carrier Sheet, [A3] ● Carrier Sheet, [B4 (JIS)] ● Carrier Sheet, [Double Letter] |
| Standard paper sizes (Length: 2 to 14 in.) A4, Letter, Legal, or other sizes | <ul style="list-style-type: none"> ● Vertical Streaks Reduction | |
| Long page (Length: more than 14 in.) <ul style="list-style-type: none"> ● 8.5 × 17 in. ● 8.5 × 34 in. ● 8.5 × 125 in. ● Custom (a value more than 14 in.) | <ul style="list-style-type: none"> ● Resolution, [Auto] ● Resolution, [300dpi] ● Resolution, [600dpi] ● Resolution, [Custom] 201 dpi or more ● Text Recognition ● Vertical Streaks Reduction ● Assisted Scan | <ul style="list-style-type: none"> ● Image Mode, [Automatic] ● Resolution, [Auto] ● Resolution, [300dpi] ● Resolution, [600dpi] ● Resolution, [Custom] 201 dpi or more ● Carrier Sheet, [A3] ● Carrier Sheet, [B4 (JIS)] ● Carrier Sheet, [Double Letter] |

| Item | Settings which become invalid when an item in the Item column is set | Conditions which make an item in the Item column invalid |
|--|--|--|
| Resolution | | |
| 150 dpi, Custom (199 dpi or less) | <ul style="list-style-type: none"> ● Index Output, Barcode | <ul style="list-style-type: none"> ● Index Output, Barcode |
| 200 dpi, Custom (200 dpi) | — | — |
| Auto, 300 dpi, Custom (201 to 300 dpi) | <ul style="list-style-type: none"> ● Paper Size, [8.5 × 17 in.] ● Paper Size, [8.5 × 34 in.] ● Paper Size, [8.5 × 125 in.] ● Paper Size, [Custom] a value more than 14 in. | <ul style="list-style-type: none"> ● Paper Size, [8.5 × 17 in.] ● Paper Size, [8.5 × 34 in.] ● Paper Size, [8.5 × 125 in.] ● Paper Size, [Custom] a value more than 14 in. |
| 600 dpi, Custom (301 dpi or more) | <ul style="list-style-type: none"> ● Paper Size, [8.5 × 17 in.] ● Paper Size, [8.5 × 34 in.] ● Paper Size, [8.5 × 125 in.] ● Paper Size, [Custom] a value more than 14 in. ● Text Recognition, [All Pages] ● Text Recognition, [Pages] ● Compression, [High Compression for Color PDF] ● Assisted Scan | |
| Carrier Sheet | | |
| Off | — | — |
| A3, B4 (JIS), Double Letter | <ul style="list-style-type: none"> ● Paper Source ● Paper Size ● Resolution, [600dpi] ● Resolution, [Custom] 301 dpi or more ● sRGB Output (when setting a job sequence) ● Rotation, [Flip Type] ● Assisted Scan | — |

■ Save

When the scan settings window is opened from the [Print] window, the [Save] menu is grayed out.

| Item | Settings which become invalid when an item in the Item column is set | Conditions which make an item in the Item column invalid |
|---|---|--|
| File Format | | |
| PDF (Single page) | <ul style="list-style-type: none"> ● Text Recognition, [OCR Highlighted Text Recognition] ● Text Recognition, [Edit OCR Highlighted Text] | <ul style="list-style-type: none"> ● Processing type, [Fax], and Fax Service, [Type 1] or [Type 2] (for the scan settings on the [Send Fax] window) |
| PDF (Multiple pages) | — | |
| PDF/A (Single page) | <ul style="list-style-type: none"> ● PDF Password ● Text Recognition, [OCR Highlighted Text Recognition] ● Text Recognition, [Edit OCR Highlighted Text] | |
| PDF/A (Multiple pages) | ● PDF Password | |
| JPEG | <ul style="list-style-type: none"> ● PDF Password ● Text Recognition ● Compression, [High Compression for Color PDF] | <ul style="list-style-type: none"> ● Processing type, [Fax], and Fax Service, [Type 1] or [Type 2] (for the scan settings on the [Send Fax] window) ● Image Mode, [Automatic] ● Image Mode, [Black & White] |
| TIFF (Single page, Multiple pages) | — | — |
| Separation (when setting a job sequence (configuring the scan settings)) | | |
| Separation Mode, [None] | — | — |
| Separation Mode, [Number of pages], [Patch code] | ● Document Feed Direction, [Face-up] | — |

| Item | Settings which become invalid when an item in the Item column is set | Conditions which make an item in the Item column invalid |
|--|--|---|
| PDF Password | | |
| Off | ● PDF Password, [Password] | ● Processing type, [Fax] (for the scan settings on the [Send Fax] window) |
| On | — | <ul style="list-style-type: none"> ● File Format, [PDF/A] ● File Format, [JPEG] ● File Format, [TIFF] |
| Password | — | <ul style="list-style-type: none"> ● Processing type, [Fax] (for the scan settings on the [Send Fax] window) ● PDF Password, [Off] |
| Text Recognition | | |
| Searchable PDF, [No] | <ul style="list-style-type: none"> ● Text Recognition, [Text Recognition for Pages] ● Text Recognition, [Text Recognition Language] | <ul style="list-style-type: none"> ● Processing type, [Fax] (for the scan settings on the [Send Fax] window) ● Paper Size, [8.5 × 17 in.] ● Paper Size, [8.5 × 34 in.] ● Paper Size, [8.5 × 125 in.] ● Paper Size, [Custom] a value more than 14 in. ● File Format, [JPEG] ● File Format, [TIFF] |
| Searchable PDF, [Yes] | — | <ul style="list-style-type: none"> ● Paper Size, [8.5 × 17 in.] ● Paper Size, [8.5 × 34 in.] ● Paper Size, [8.5 × 125 in.] ● Paper Size, [Custom] a value more than 14 in. ● File Format, [JPEG] ● File Format, [TIFF] |
| OCR Highlighted Text Recognition, [Off] | <ul style="list-style-type: none"> ● Text Recognition, [Edit OCR Highlighted Text] ● Text Recognition, [Text Recognition for Pages] ● Text Recognition, [Text Recognition Language] | <ul style="list-style-type: none"> ● Processing type, [Fax] (for the scan settings on the [Send Fax] window) ● Image Mode, [Black & White] ● Image Mode, [Grayscale] ● Paper Size, [8.5 × 17 in.] ● Paper Size, [8.5 × 34 in.] ● Paper Size, [8.5 × 125 in.] ● Paper Size, [Custom] a value more than 14 in. ● File Format, [PDF] (Single page) ● File Format, [PDF/A] (Single page) ● File Format, [JPEG] ● File Format, [TIFF] |
| OCR Highlighted Text Recognition, [[First marked section only], [All marked sections]] | — | <ul style="list-style-type: none"> ● Paper Size, [8.5 × 17 in.] ● Paper Size, [8.5 × 34 in.] ● Paper Size, [8.5 × 125 in.] ● Paper Size, [Custom] a value more than 14 in. ● File Format, [PDF] (Single page) ● File Format, [PDF/A] (Single page) ● File Format, [JPEG] ● File Format, [TIFF] |

| Item | Settings which become invalid when an item in the Item column is set | Conditions which make an item in the Item column invalid |
|--|---|---|
| Text Recognition (continued) | | |
| Edit OCR Highlighted Text | — | <ul style="list-style-type: none"> ● Processing type, [Fax] (for the scan settings on the [Send Fax] window) ● Image Mode, [Black & White] ● Image Mode, [Grayscale] ● Paper Size, [8.5 × 17 in.] ● Paper Size, [8.5 × 34 in.] ● Paper Size, [8.5 × 125 in.] ● Paper Size, [Custom] a value more than 14 in. ● File Format, [PDF] (Single page) ● File Format, [PDF/A] (Single page) ● File Format, [JPEG] ● File Format, [TIFF] ● Text Recognition, OCR Highlighted Text Recognition, [No] |
| Text Recognition Language | — | <ul style="list-style-type: none"> ● Processing type, [Fax] (for the scan settings on the [Send Fax] window) |
| Text Recognition for Pages, [First Page] | <ul style="list-style-type: none"> ● Text Recognition for Pages, [First Page] ● Text Recognition for Pages, [Last Page] | <ul style="list-style-type: none"> ● Text Recognition, Searchable PDF, [No], and Text Recognition, OCR Highlighted Text Recognition, [No] |
| Text Recognition for Pages, [All Pages] | | <ul style="list-style-type: none"> ● Processing type, [Fax] (for the scan settings on the [Send Fax] window) ● Resolution, [600dpi] ● Resolution, [Custom] 301 dpi or more ● Text Recognition, Searchable PDF, [No], and Text Recognition, OCR Highlighted Text Recognition, [No] |

| Item | Settings which become invalid when an item in the Item column is set | Conditions which make an item in the Item column invalid |
|--|--|--|
| Text Recognition (continued) | | |
| Text Recognition for Pages, [Target pages] <ul style="list-style-type: none"> ● [First Page] ● [Last Page] | — | <ul style="list-style-type: none"> ● Processing type, [Fax] (for the scan settings on the [Send Fax] window) ● Resolution, [600dpi] ● Resolution, [Custom] 301 dpi or more ● Text Recognition, Searchable PDF, [No], and Text Recognition, OCR Highlighted Text Recognition, [No] ● Text Recognition for Pages, [First Page] ● Text Recognition for Pages, [All Pages] |
| Compression | | |
| Compression rate | — | <ul style="list-style-type: none"> ● Processing type, [Fax], and Fax Service, [Type 1] or [Type 2] (for the scan settings on the [Send Fax] window) ● Image Mode, [Black & White] ● Compression, [High Compression for Color PDF] |
| High Compression for Color PDF, [No] | — | <ul style="list-style-type: none"> ● Processing type, [Fax], and Fax Service, [Type 1] or [Type 2] (for the scan settings on the [Send Fax] window) ● Image Mode, [Black & White] ● Image Mode, [Grayscale] ● File Format, [JPEG] ● File Format, [TIFF] ● Resolution, [600dpi] ● Resolution, [Custom] 301 dpi or more |
| High Compression for Color PDF, [Yes] | <ul style="list-style-type: none"> ● Compression rate | <ul style="list-style-type: none"> ● Processing type, [Fax], and Fax Service, [Type 1] or [Type 2] (for the scan settings on the [Send Fax] window) ● Image Mode, [Black & White] ● Image Mode, [Grayscale] ● File Format, [JPEG] ● File Format, [TIFF] ● Resolution, [600dpi] ● Resolution, [Custom] 301 dpi or more |

■ Image Correction

| Item | Settings which become invalid when an item in the Item column is set | Conditions which make an item in the Item column invalid |
|---|--|--|
| Thresholding | | |
| Sensitivity | — | <ul style="list-style-type: none"> ● Image Mode, [Grayscale] ● Image Mode, [Color] |
| Thresholding (background) | — | |
| Control Image Tone | — | <ul style="list-style-type: none"> ● Image Mode, [Black & White] |
| Cleanup | — | <ul style="list-style-type: none"> ● Image Mode, [Black & White] |
| Cleanup (Black & White) | — | <ul style="list-style-type: none"> ● Image Mode, [Grayscale] ● Image Mode, [Color] |
| Vertical Streaks Reduction | — | <ul style="list-style-type: none"> ● Paper Size, other than [Automatic], and Carrier Sheet, [Off] |
| Dropout Color | — | <ul style="list-style-type: none"> ● Image Mode, [Color] |
| sRGB Output (when setting a job sequence (configuring the scan settings)) | <ul style="list-style-type: none"> ● Assisted Scan | <ul style="list-style-type: none"> ● Image Mode, [Black & White] ● Image Mode, [Grayscale] |

■ Page

| Item | Settings which become invalid when an item in the Item column is set | Conditions which make an item in the Item column invalid |
|----------------------------------|--|--|
| Rotation | | |
| Auto | ● Rotation, [Flip Type] | ● Processing type, [Print] (Set to [0°], [Vertical]) (for the scan settings on the [Print] window) |
| 0°, 90°(CW), 90°(CCW), 180° | — | ● Processing type, [Print] (Set to [0°], [Vertical]) (for the scan settings on the [Print] window) |
| Flip Type (Vertical, Horizontal) | — | <ul style="list-style-type: none"> ● Processing type, [Print] (Set to [0°], [Vertical]) (for the scan settings on the [Print] window) ● Paper Source, [Feeder (Single Side)] ● Carrier Sheet, [A3] (Set to [Vertical]) ● Carrier Sheet, [B4 (JIS)] (Set to [Vertical]) ● Carrier Sheet, [Double Letter] (Set to [Vertical]) ● Rotation, [Auto] |
| Edge Correction | | |
| Edge Filler, [No] | — | — |
| Edge Filler, [Yes] | — | — |
| Fill Color | — | — |
| Filled Area | — | — |
| Unit | — | — |
| Blank Page Skip | | |
| Yes | — | — |
| No | — | — |
| Sensitivity | — | ● Blank Page Skip, [No] |

■ Paper Feeding

| Item | Settings which become invalid when an item in the Item column is set | Conditions which make an item in the Item column invalid |
|----------------------------|--|--|
| Multifeed Detection | | |
| Do not detect | — | — |
| Ultrasonic | — | — |
| Length | — | — |
| Both | — | — |

■ Batch

| Item | Settings which become invalid when an item in the Item column is set | Conditions which make an item in the Item column invalid |
|--|--|--|
| Index Output | | |
| Index Output, [No] | ● Index Output, Barcode | — |
| Index Output, [Yes] | — | <ul style="list-style-type: none"> ● Processing type, [e-Mail] (for the scan settings on the [Send e-Mail] window) ● Processing type, [Fax] (for the scan settings on the [Send Fax] window) ● Processing type, [Print] (for the scan settings on the [Print] window) ● Document Feed Direction, [Face-up] |
| Barcode Detection, [Yes] (for a job sequence, Barcode Detection, [Type]) | — | <ul style="list-style-type: none"> ● Resolution, [150dpi] ● Resolution, [Custom] 199 dpi or less ● Index Output, [No] |

5.8.2 Setting Image Mode

To set an image mode (type) for the scanned document, follow the steps below. You can set whether the document is scanned in "color", "grayscale" or "black & white".

1. Select [Image Mode] under [Basic] on the scan settings window.

⇒ The [Image Mode] window appears.

2. Select the type of image to be output.

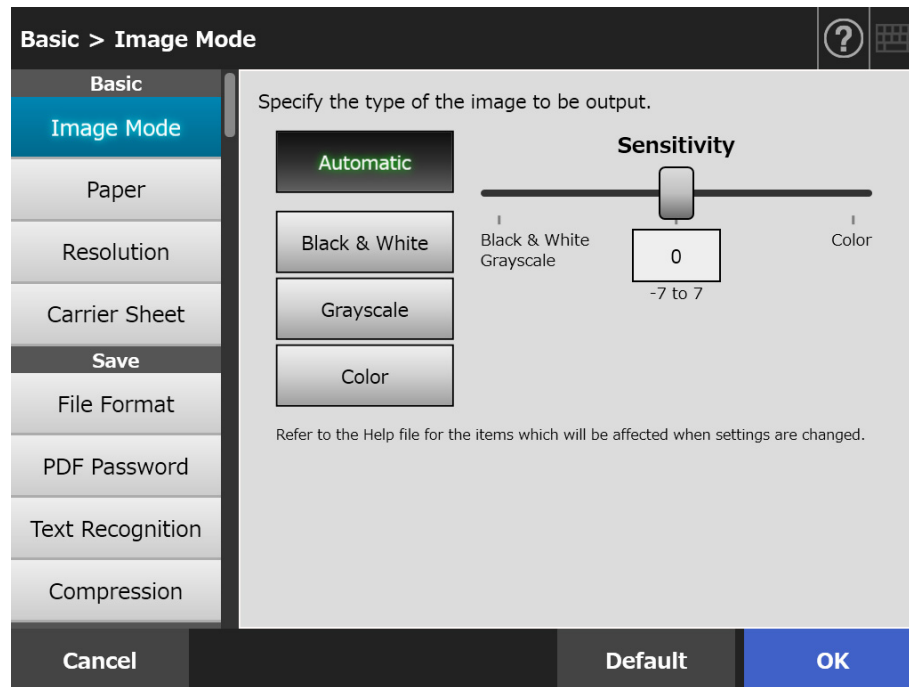

3. If [Automatic] is selected in Step 2, specify [Sensitivity].

4. Press the [OK] button.

⇒ The information entered is set.

5.8.3 Setting Paper

You can set the paper scanning side, the feed direction to load paper in the scanner, and the paper size.

1. **Select [Paper] under [Basic] on the scan settings window.**
⇒ The [Paper] window appears.
2. **Select the paper scanning side, the feed direction to load paper in the scanner and the paper size.**

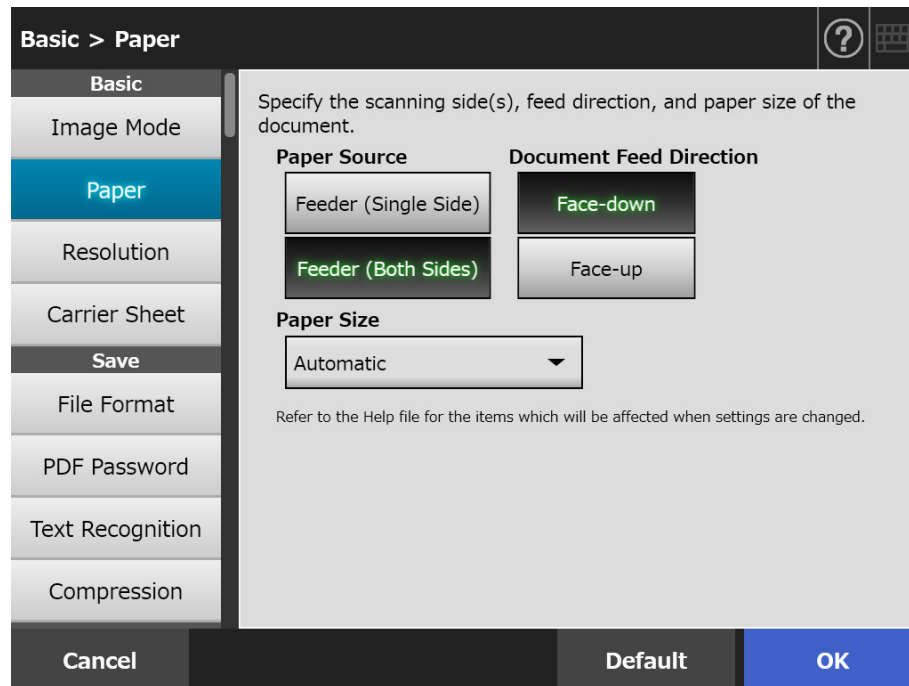

3. **When [Custom] is selected in Step 2, specify [Unit] and the paper size for the displayed setting items.**
4. **Press the [OK] button.**
⇒ The information entered is set.

HINT

When [Custom] is selected, any paper size can be specified for the scanned data.

5.8.4 Resolution

Changing the resolution level affects the scanned data in the following ways.

| Item | High resolution | Low resolution |
|--------------|-----------------|----------------|
| Scan speed | Slow | Fast |
| Scan quality | High | Low |
| File size | Large | Small |

1. **Select [Resolution] under [Basic] on the scan settings window.**
⇒ The [Resolution] window appears.
2. **Select a resolution level.**

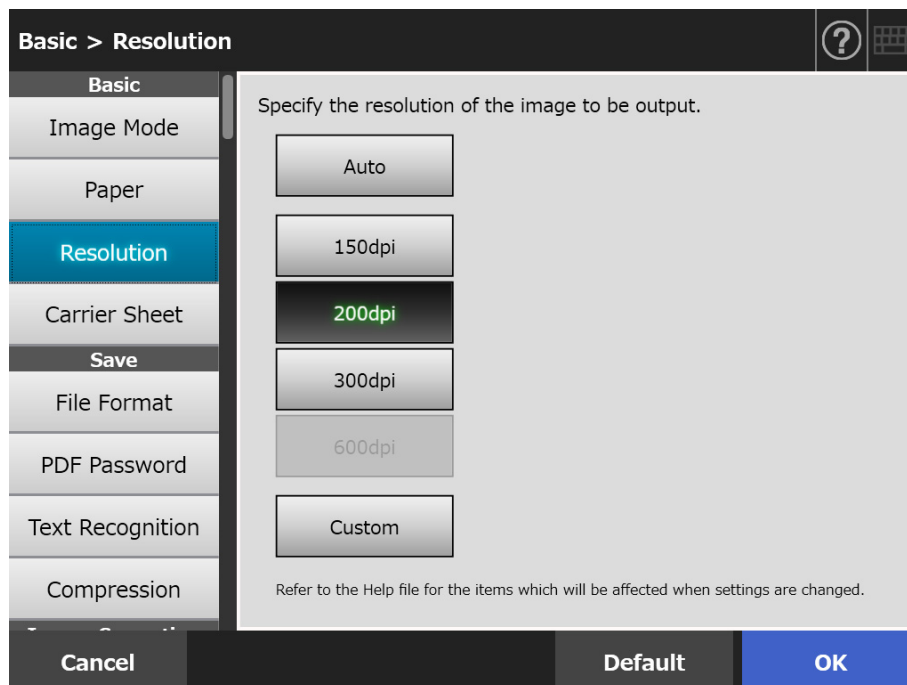

3. **Press the [OK] button.**
⇒ The information entered is set.

5.8.5 Configuring Settings for a Carrier Sheet

To set whether or not to use a Carrier Sheet, follow the steps below.
When using a Carrier Sheet, set the size of the scanned document to be output.

1. **Select [Carrier Sheet] under [Basic] on the scan settings window.**
⇒ The [Carrier Sheet] window appears.
2. **If a Carrier Sheet is to be used, select the output size for the scanned image.**

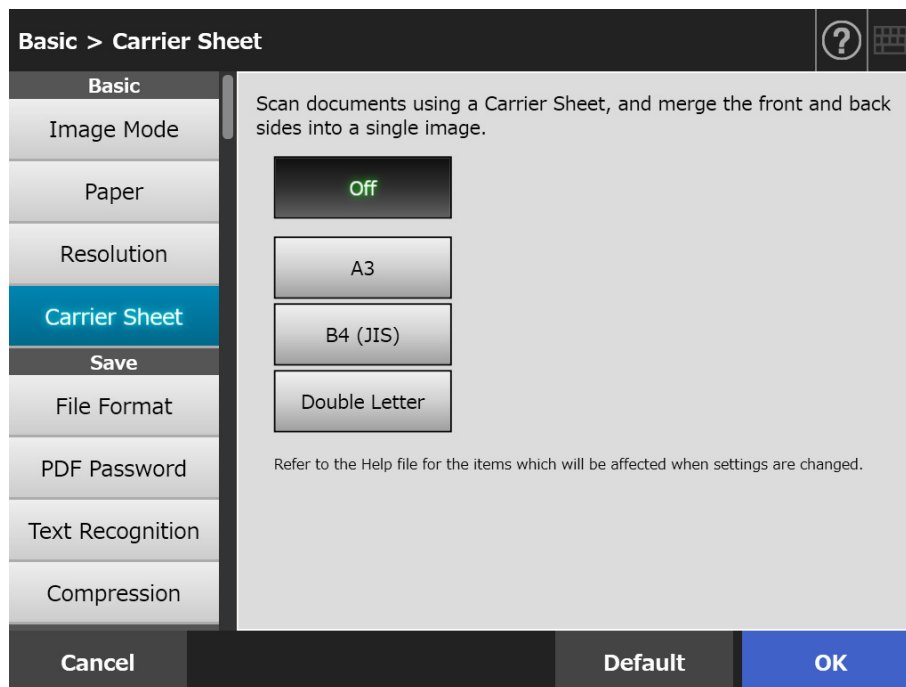

3. **Press the [OK] button.**
⇒ The information entered is set.

5.8.6 File Format

To set a file format for the scanned data, follow the steps below.
Some scan settings cannot be used for certain file formats.

| Option | PDF (*1) | PDF/A (*1) | JPEG | TIFF (*1) |
|------------------|----------|------------|------|-----------|
| Text Recognition | Yes | Yes | — | — |
| PDF Password | Yes | — | — | — |
| Compression | Yes (*2) | Yes (*2) | Yes | Yes (*2) |

Yes: Available —: Unavailable

(*1): Files can be output in single-page or multi-page format.

(*2): Available only when the [Color Mode] is [Auto], [Grayscale], or [Color].

Compression also differs for certain file formats as follows:

| Image Mode | Document | File Format | | |
|---------------|-------------------------------------|--|------|------|
| | | PDF, PDF/A | JPEG | TIFF |
| Automatic | Color | JPEG or high compression for color PDF | JPEG | JPEG |
| | Grayscale | JPEG | JPEG | JPEG |
| | Black & White | MMR | — | MMR |
| Color | Color Grayscale Black & White | JPEG or high compression for color PDF | JPEG | JPEG |
| Grayscale | Color Grayscale Black & White | JPEG | JPEG | JPEG |
| Black & White | Color Grayscale Black & White | MMR | — | MMR |

—: Unavailable

HINT

When PDF format is selected, select whether or not to use [High Compression for Color PDF] mode. When [High Compression for Color PDF] is selected, characters and backgrounds are separated and only backgrounds are compressed. Therefore, the file size of a character based document can be reduced without the quality of the characters being decreased.

However, note the following:

- Photographs or pictures are recognized as background and compressed at a high rate, causing degradation in the scanned image.
- Thus, this mode is not appropriate for scanning photographs or other graphical materials.
- The contrast of the image may become higher.

1. Select [File Format] under [Save] on the scan settings window.

⇒ The [File Format] window appears.

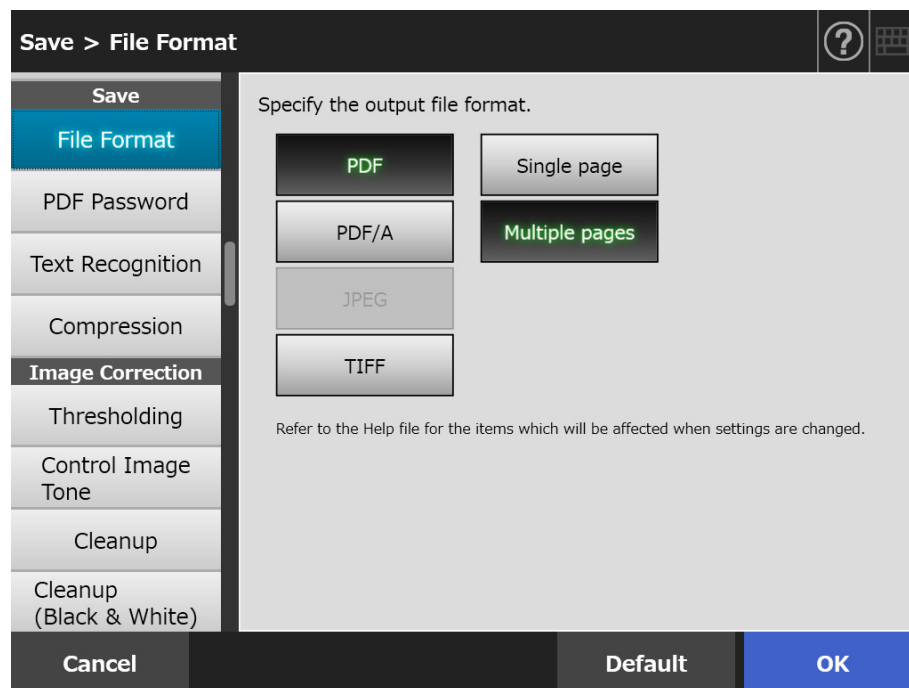
2. Select a file format.**3. Press the [OK] button.**

⇒ The information entered is set.

5.8.7 Setting a PDF Password

When the file format is [PDF], PDF files can be locked with a user-specified password.

ATTENTION

The password will need to be entered every time the password-protected PDF file is opened. Do not forget or lose this password.

1. **Select [PDF Password] under [Save] on the scan settings window.**
⇒ The [PDF Password] window appears.
2. **Select [PDF Password] under [Save] on the scan settings window.**

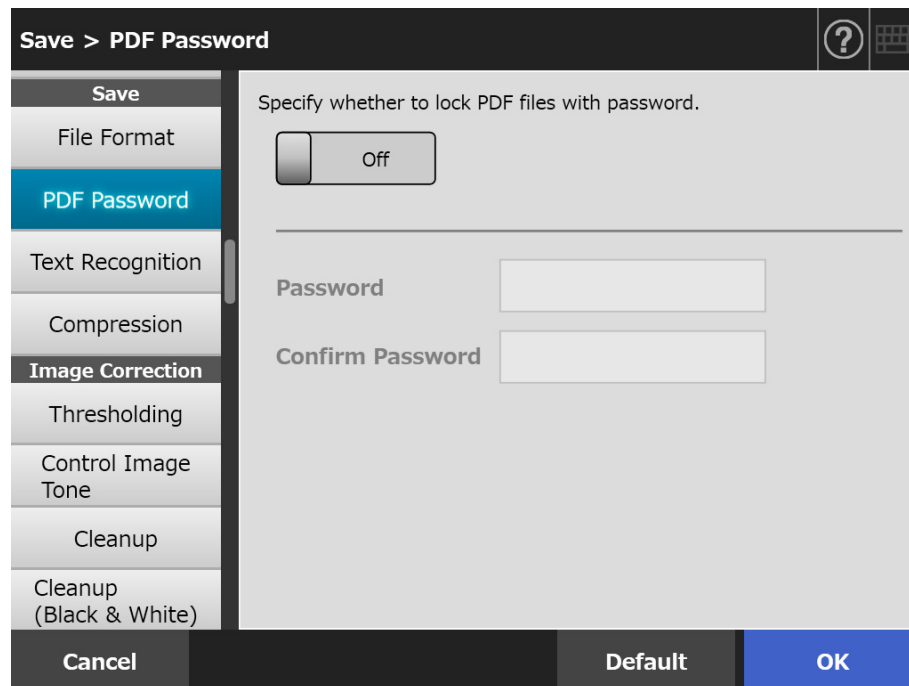

3. **Press the [OK] button.**
⇒ The information entered is set.

5.8.8 Searchable PDF

When the file format is [PDF] or [PDF/A], the scanned data can be converted to a searchable PDF by automatically recognizing character strings contained in the document to be scanned.

ATTENTION

Conversion to searchable PDF may take extra time.

1. Select [Text Recognition] under [Save] on the scan settings window.

⇒ The [Text Recognition] window appears.

2. For [Searchable PDF], select [Yes].

3. For [Text Recognition Language], select a language used when text is to be recognized in the document.

4. Under [Text Recognition for Pages], specify the pages to be output in searchable PDF.

5. Press the [OK] button.

⇒ The information entered is set.

5.8.9 Setting a Keyword for the PDF

When the file format is [PDF] or [PDF/A], a character string such as the title of a black and white document can be set as a PDF file keyword and can be used when searching the PDF file.

Mark a character string to be set as a keyword with a water-based highlight pen so that the character string is completely covered. When you perform a scan, the marked character strings are recognized and set as keywords for the PDF file.

Hereinafter, a line drawn with a water-based highlight pen is referred to as a "marked section", and a water-based highlight pen as a "highlight pen".

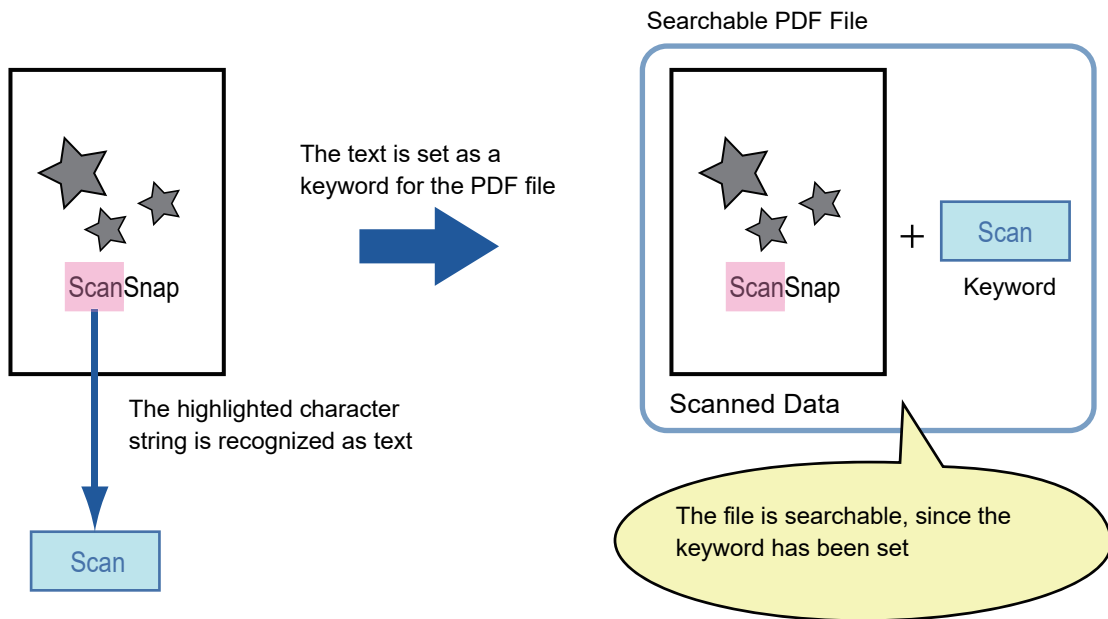



Marked sections should be highlighted on a black and white document in the following way.

- Any regular highlight pen can be used.
- The recommended colors and thickness of marked sections are as follows:

| Pink | Yellow | Blue | Green |
|----------|----------|----------|----------|
| ScanSnap | ScanSnap | ScanSnap | ScanSnap |

- Draw a straight line over a single line of characters.
- The supported size of a marked section is as follows:
Minimum size: Height 3 mm (0.1 in.), Width 10 mm (0.4 in.)
Maximum size: Height 20 mm (0.8 in.), Width 150 mm (5.9 in.)
- Sections marked by a pale color may not be recognized.
- Use only a single color within a page.
- Draw a marker line in a way that the desired character string is completely covered.

The color of an entire marked section should be even in thickness.

| Good Example | Bad Example 1 (The characters are not completely covered) | Bad Example 2 (The color is not even) |
|---|---|---|
|  |  |  |

- Up to 10 sections can be marked in a page.

ATTENTION

- In the following documents, highlighted character strings cannot be set as a keyword:
 - Catalogs, pamphlets, and other color documents
 - Documents including sections marked in two or more colors
 - Documents containing colors other than for marking (pens other than highlight pens are used or the document is stained)
 - Documents containing a large number of marked sections in a page
- When any of the following conditions apply, the highlighted character strings may not be able to be set as a keyword:
 - The size of a marked section is out of the supported range
 - Marking lines are not drawn in an ordinary way (such as when a line is slanted)
 - Multiple marked sections are located close to each other
 - The color of the highlight pen is too pale or the color has faded

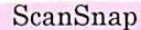

- When applying markings on two or more character strings, the marked sections must be separated from each other by at least 5 mm (0.2 in.). If marked sections are too close to each other, multiple sections may be recognized as a single section.
- In the following case, other characters close to marked sections may be set as a keyword:
 - When a marking is drawn over another line (upper or lower)
- In the following cases, characters not highlighted by a marked section may be set as a keyword:
 - Catalogs, pamphlets, and other color documents
 - Documents containing colored characters, figures, pictures, tables, lines, or other elements
 - Documents containing marked areas other than those containing character strings to be set as keywords
 - Tainted documents
 - Documents containing sections framed by a highlight pen

HINT

- If setting a keyword is not successful, improving image scanning quality may help.
- Keywords for PDF files can be checked from the Adobe Acrobat document properties menu.

To automatically set a keyword for a PDF file, change the settings as shown below.

ATTENTION

- Conversion to searchable PDF may take extra time.
- If the same character string is marked at multiple locations of a document, the same keyword is added to the PDF file multiple times.
- The total number of characters for keywords is limited up to 255 characters, including delimiters between keywords.
- When keywords are viewed in Adobe Acrobat and Adobe Reader, the appended quotation marks (") may be found at the beginning and end of keywords.

1. Select [Text Recognition] under [Save] on the scan settings window.

⇒ The [Text Recognition] window appears.

2. For [OCR Highlighted Text Recognition], select [First marked section only] or [All marked sections].

HINT

For details of automatic color mode selection, refer to ["5.8.2 Setting Image Mode"](#) (page 276).

3. Select whether or not to enable editing of character strings in marked sections at [Edit OCR Highlighted Text].

When sending a file asynchronously as an administrator, you cannot edit the character strings in marked sections.

HINT

When sending as an e-mail attachment, faxing, printing, or saving scanned data, the [Scan Viewer] window appears, and then a window for editing the character strings in marked sections appears, allowing the keyword strings to be edited.

4. For [Text Recognition Language], select a language used when text is to be recognized in the document.

5. For [Text Recognition for Pages], specify the range of pages for text recognition.

6. Press the [OK] button.

⇒ The information entered is set.

5.8.10 Compression

When [Automatic], [Grayscale], or [Color] is selected in "5.8.2 Setting Image Mode" (page 276), the compression rate for scanned data can be set.

For photographs and graphics, their file sizes can be decreased by increasing the compression rate.

Changing the compression rate affects the scanned data in the following ways.

| | High compression | Low compression |
|-----------|------------------|-----------------|
| Quality | Low | High |
| File size | Small | Large |

1. Select [Compression] under [Save] on the scan settings window.

⇒ The [Compression] window appears.

2. Select a compression rate.

Lowering the compression rate makes the file size larger, and increases the quality of the scanned data.

When PDF format is selected in "5.8.6 File Format" (page 280), [High Compression for Color PDF] can be used.

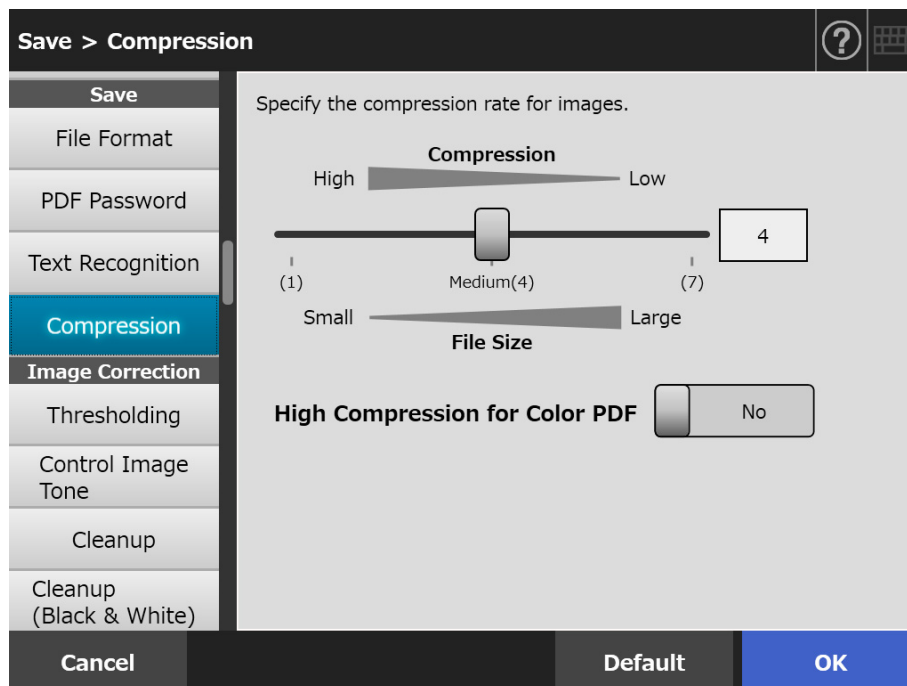

3. Press the [OK] button.

⇒ The information entered is set.

HINT

The following tables show the estimated file sizes for when the single side of one color page is scanned.

Actual paper size: A4 size (general catalog)

File format: PDF

Scanner paper size setting: A4

- Estimated file size (byte) for [RGB Color]

| Resolution | Compression Rate | | | | | | | |
|------------|------------------|-------|-------|-------|-------|-------|-------|--------------------------------|
| | 1 | 2 | 3 | 4 | 5 | 6 | 7 | High Compression for Color PDF |
| 50 dpi | 18.8K | 24.8K | 30.1K | 41.5K | 52.4K | 80K | 108K | 35.7K |
| 150 dpi | 101K | 114K | 139K | 190K | 253K | 389K | 538K | 84K |
| 200 dpi | 167K | 180K | 245K | 336K | 427K | 679K | 945K | 117K |
| 300 dpi | 339K | 416K | 580K | 805K | 1.04M | 1.69M | 2.36M | 138K |
| 600 dpi | 1.68M | 1.97M | 2.42M | 3.68M | 5.09M | 9.06M | 12.3M | 176K |

- Estimated file size (byte) for [Grayscale]

| Resolution | Compression Rate | | | | | | | |
|------------|------------------|-------|-------|-------|-------|-------|-------|--------------------------------|
| | 1 | 2 | 3 | 4 | 5 | 6 | 7 | High Compression for Color PDF |
| 50 dpi | 19.5K | 23K | 27.9K | 37.2K | 45.9K | 65.2K | 79.3K | — |
| 150 dpi | 85.3K | 100K | 122K | 164K | 206K | 297K | 368K | — |
| 200 dpi | 140K | 171K | 209K | 285K | 359K | 524K | 642K | — |
| 300 dpi | 305K | 418K | 513K | 717K | 899K | 1.28M | 1.55M | — |
| 600 dpi | 1.41M | 1.68M | 2.09M | 3.08M | 4.09M | 6.21M | 7.21M | — |

- Estimated file size (byte) for [Black & White]

| Resolution | Compression rate cannot be selected |
|------------|-------------------------------------|
| 50 dpi | 7.48K |
| 150 dpi | 16.3K |
| 200 dpi | 25.5K |
| 300 dpi | 57.1K |
| 600 dpi | 262K |

5.8.11 Thresholding

The sensitivity for outputting scanned data in black and white can be set. Clear scanned image output can be obtained from documents with dark background.

1. Select [Thresholding] under [Image Correction] on the scan settings window.

⇒ The [Thresholding] window appears.

2. Specify each item.

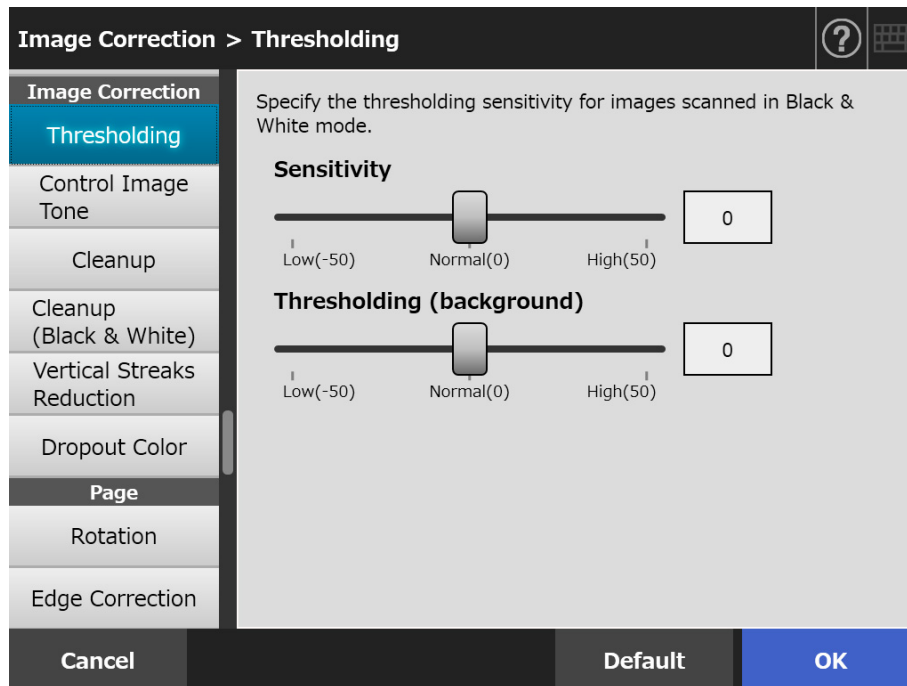

3. Press the [OK] button.

⇒ The information entered is set.

5.8.12 Controlling the image quality of scanned data (Control Image Tone)

To control the image quality of scanned images, follow the steps below.

Scanned data can be adjusted to be standard, soft (opaque), sharp (clear), or bright tone.

The following color tone items can be controlled manually when [Custom] is selected:

- **Brightness**
Controls the brightness of the entire tone range uniformly.
- **Contrast**
Sharpens or softens the image contrast.
- **Shadow**
Darkens light text in the document.
- **Highlight**
Controls the background brightness of white-background documents.
- **Gamma**
Controls the brightness of the medium-tone range.

1. Select [Control Image Tone] under [Image Correction] on the scan settings window.

⇒ The [Control Image Tone] window appears.

2. Control the color tone of scanned data.

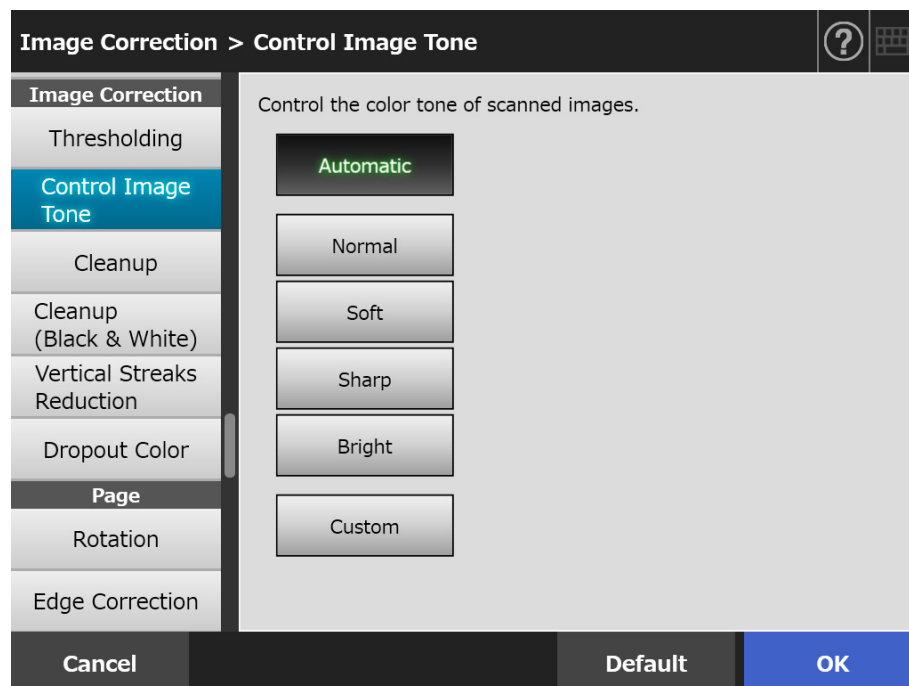

3. When [Custom] is selected in Step 2, specify [Brightness], [Contrast], [Shadow], [Highlight], and [Gamma] for the displayed setting items.

4. Press the [OK] button.

⇒ The information entered is set.

5.8.13 Optimizing Scanned Data (Cleanup)

Scanned data can be optimized by image processing.
Setting items differ depending on the image mode.

■ In [Color] or [Grayscale] mode

The following items can be set.

- Sharpness
Emphasize the outlines of text or lines, and reduce moire (recurrent patterns).
- Color Cleanup
Clean the background of image to suppress the color or density unevenness.
- White Level Follower
Control the threshold value so that the background will be recognized to be white.

1. Select [Cleanup] under [Image Correction] on the scan settings window.

⇒ The [Cleanup] window appears.

2. Specify each item.

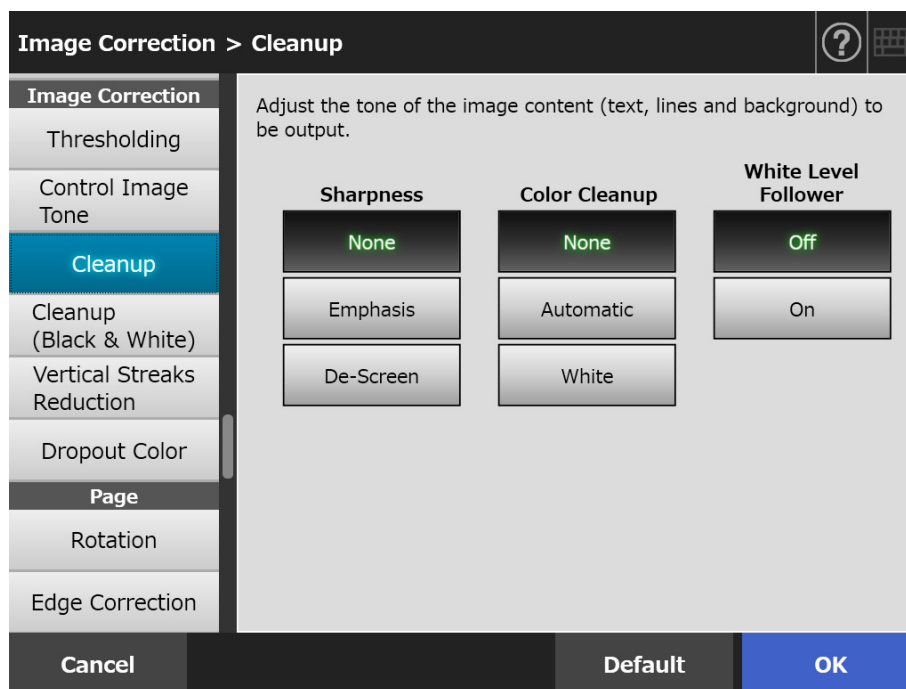

3. Press the [OK] button.

⇒ The information entered is set.

■ In [Black & White] mode

The following items can be set.

- Character Thickness
Modify the font or line weight.
- Character Augmentation
Perform character augmentation.
- Noise Removal
Remove noise (dot-shaped unwanted data in the background).
- Background Pattern Removal
Remove characters or patterns printed in the background.
- White Level Follower
Control the threshold value so that the background will be recognized to be white.

1. Select [Cleanup (Black & White)] under [Image Correction] on the scan settings window.

⇒ The [Cleanup (Black & White)] window appears.

2. Specify each item.

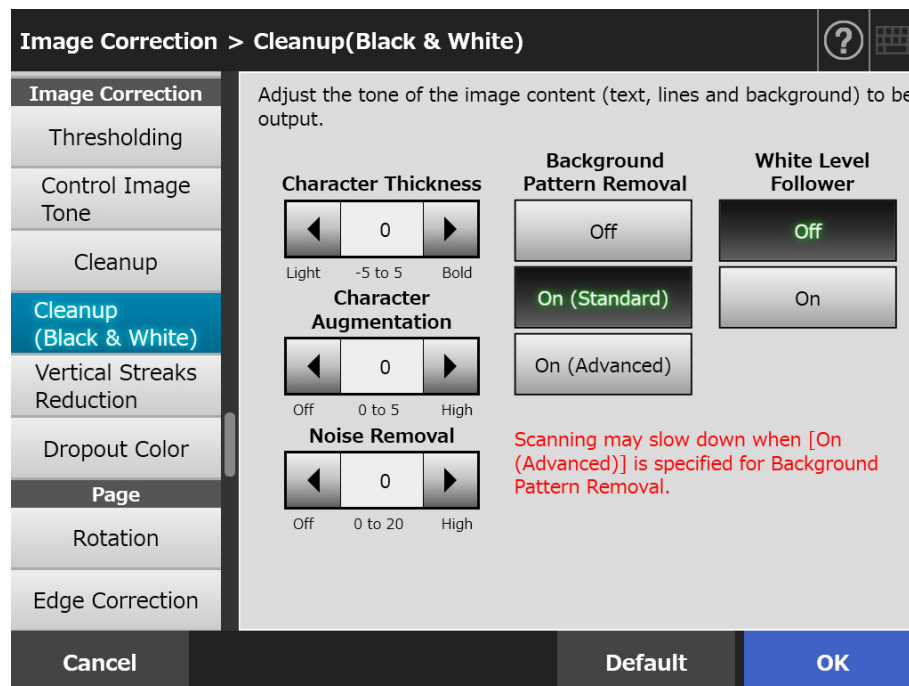

3. Press the [OK] button.

⇒ The information entered is set.

5.8.14 Reducing Vertical Streaks

This section describes how to specify whether or not to reduce vertical streaks on the scanned data, which were caused by dirt inside the scanner.

1. Select [Vertical Streaks Reduction] under [Image Correction] on the scan settings window.

⇒ The [Vertical Streaks Reduction] window appears.

2. Specify whether or not to reduce vertical streaks on the scanned data.

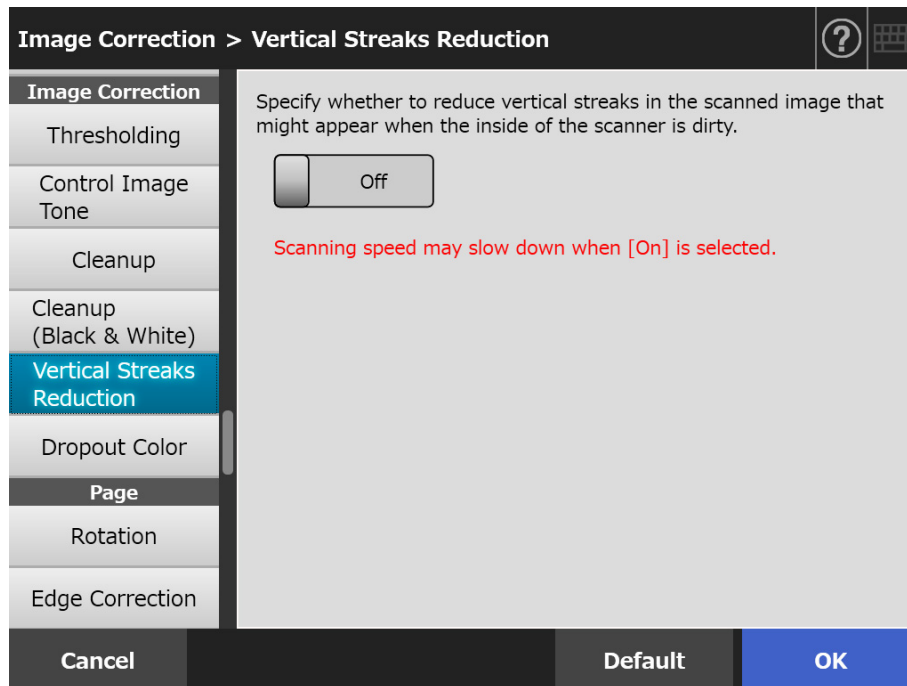

3. Press the [OK] button.

⇒ The information entered is set.

ATTENTION

If vertical streaks are still outstanding even after this option is enabled, open the LCD cover on the scanner, and wipe off the glasses inside. For details, refer to "6.3 Cleaning Inside the Scanner" (page 339).

5.8.15 Removing Colors from Scanned Images (Dropout Color)

The colors red, green and blue (primary colors) can be deleted during scanning. For example, if a document with black characters and a green border is scanned, only the black characters will appear on the scanned image.

When using the dropout color setting, you can set whether to remove color details and select color details to be removed.

ATTENTION

Dark colors (low brightness colors) may not be removed.

1. **Select [Dropout Color] under [Image Correction] on the scan settings window.**
 - ⇒ The [Dropout Color] window appears.
2. **If color details are to be removed, select a color to be used as the dropout color.**

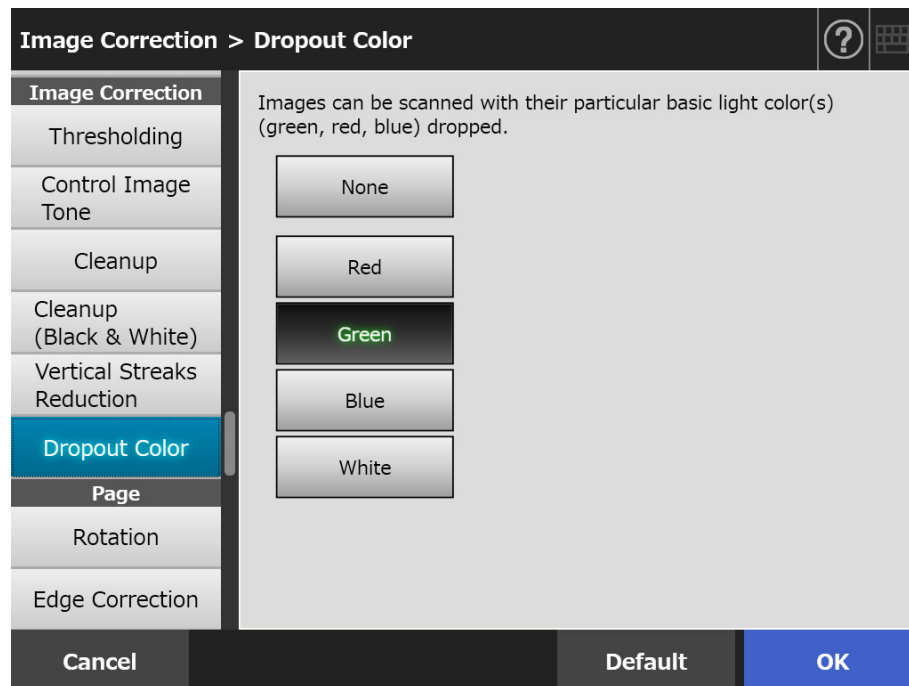

3. **Press the [OK] button.**
 - ⇒ The information entered is set.



5.8.16 Page Orientation

Scanned data is automatically rotated to the correct orientation.

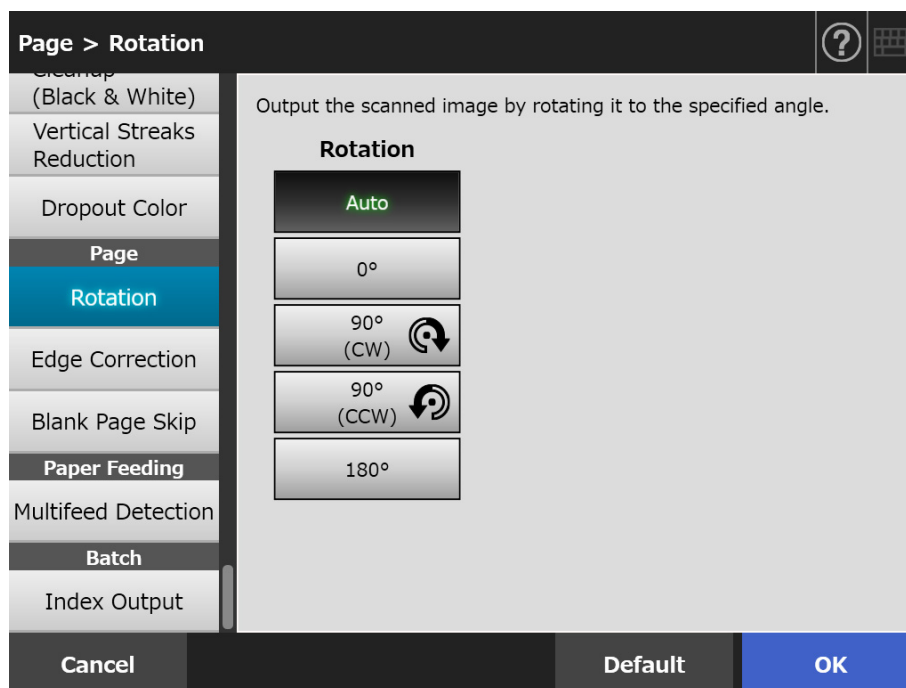
1. **Select [Rotation] under [Page] on the scan settings window.**
⇒ The [Rotation] window appears.
2. **Select the rotation angle and the flip type for the scanned data.**

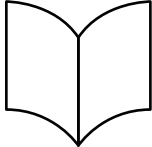

In duplex mode, the flip type can be selected when the page rotation angle is set. The following table shows the flip types and the resulting scanned data.

| Flip Type | Scanned Data |
|---|--|
| <p data-bbox="288 365 405 394">Vertical</p>  | <p data-bbox="493 365 1398 521">Select this setting when scanning a document with opposing left and right pages (facing pages with long side as the middle crease). The scanned data is output with the same orientation as the original document.</p> <div data-bbox="493 544 1406 925"> <p data-bbox="493 902 667 925">Feed direction</p> </div> |
| <p data-bbox="288 958 440 987">Horizontal</p>  | <p data-bbox="493 958 1398 1205">Select this setting when scanning a document with opposing top and bottom pages (facing pages with the short side as the middle crease). The front side of the document is output with the same orientation as the original data, whereas the data on the reverse side is rotated 180 degrees.</p> <div data-bbox="493 1227 1406 1664"> <p data-bbox="493 1585 667 1608">Feed direction</p> <p data-bbox="1265 1641 1406 1664">Rotated 180</p> </div> |

3. Press the [OK] button.

⇒ The information entered is set.

HINT
 If scanned data is incorrectly rotated, you can modify the orientation of the scanned data in the scan viewer details window.
 For details, refer to "5.10 Editing the Scanned Data in the Scan Viewer" (page 309).

5.8.17 Filling the Edge of Scanned Image (Edge Correction)

This section describes how to use the Edge Correction function to improve the appearance of the entire scanned image by filling the unwanted outside area with a specified color.

Specify whether to fill the edge of the scanned image, and specify the color and the area to be filled.

The following table shows the areas of documents to be scanned when the edge is filled or not filled.

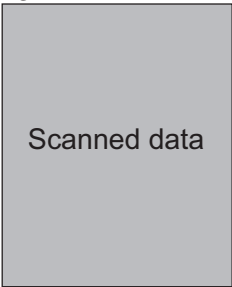
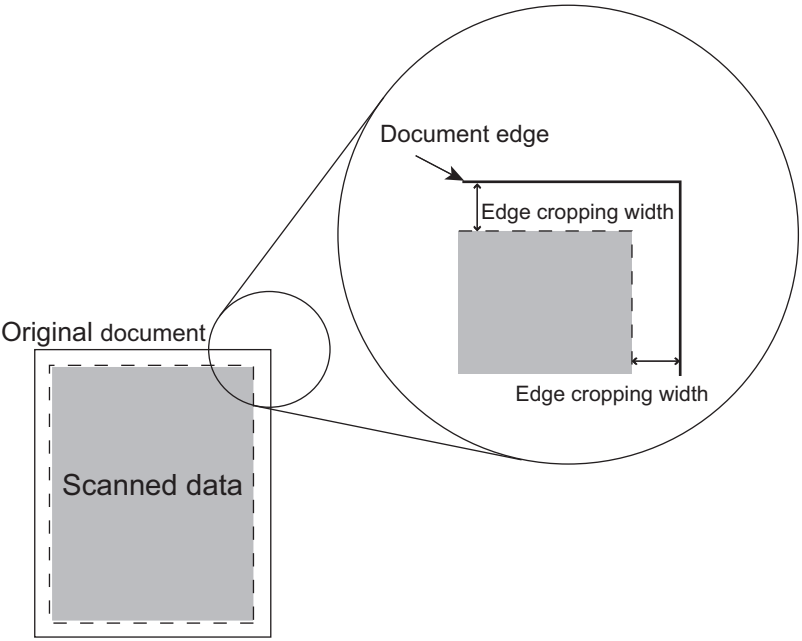
| Edge Filler | Scanned area of a document |
|-------------|--|
| Off | <p data-bbox="515 658 719 685">Original document</p>  |
| On |  |

1. Select [Edge Correction] under [Page] on the scan settings window.
 ⇒ The [Edge Correction] window appears.
2. Specify whether or not to use the edge filler function, and when it is used, specify the color and area to be filled in.

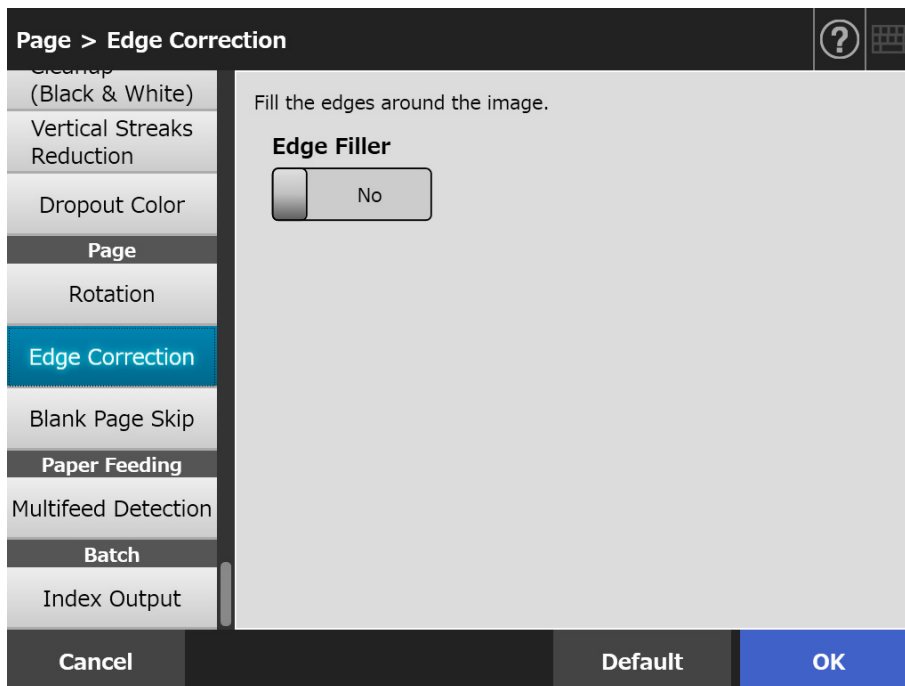

3. Press the [OK] button.
 ⇒ The information entered is set.

ATTENTION

When image rotation is enabled, the edge is filled with a color after the rotation. This section uses an example where [Auto] or [90°(CCW)] is selected on the [Rotation] window.

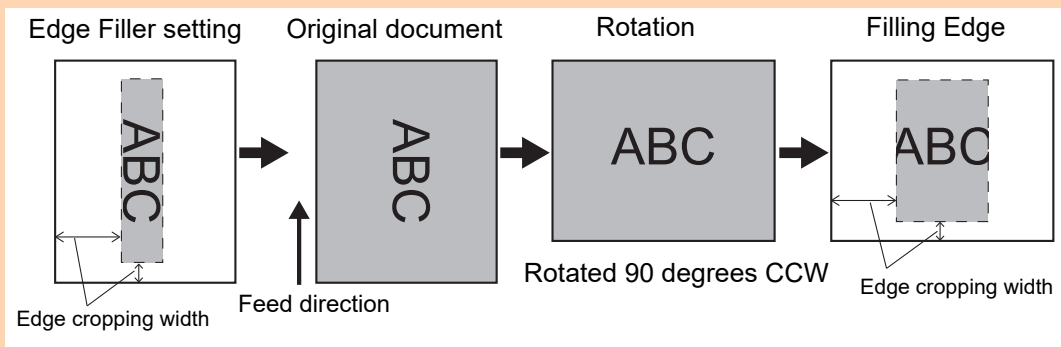

5.8.18 Skipping Blank Pages from the Scanned Data

The scan process can be set to skip any blank pages in the scanned data. For example, when a stack of documents containing both two-sided and one-sided documents is scanned in duplex scan mode, this feature removes only the reverse side (i.e. blank page) of one-sided documents from the scanned data.

1. **Select [Blank Page Skip] under [Page] on the scan settings window.**
⇒ The [Blank Page Skip] window appears.
2. **Specify whether to detect and delete blank pages, and specify [Sensitivity] for detecting blank pages.**

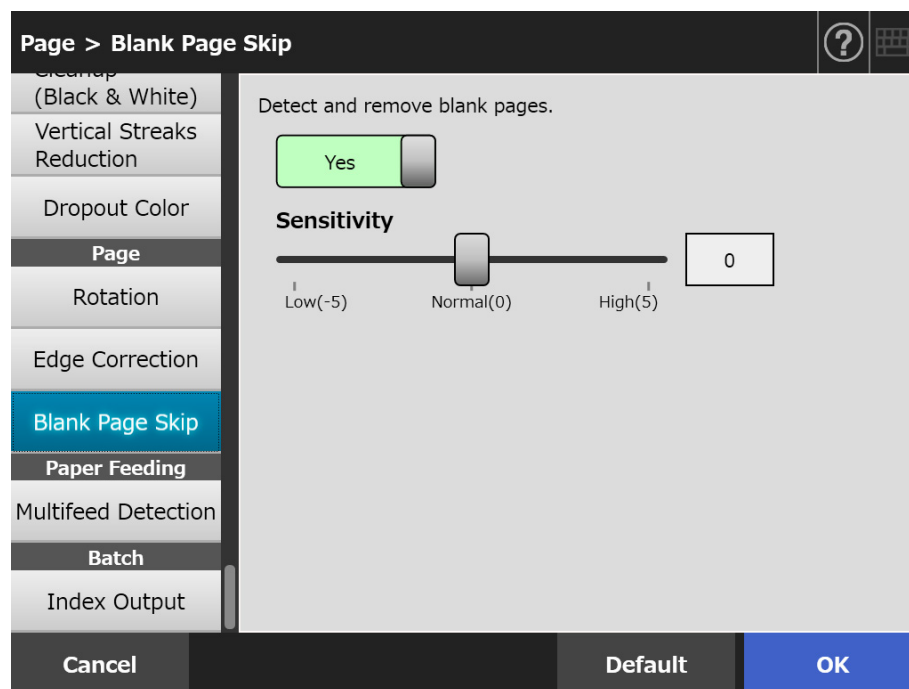

3. **Press the [OK] button.**
⇒ The information entered is set.

5.8.19 Detecting Multifeeds

The scanner can be set to detect multifeeds and stop the scan with an error message. Multifeeds are to be detected by layer and length.

The following explains how to set whether or not multifeeds are to be detected and set up multifeed detection method.

For multifeed requirements, refer to ["A.5 Multifeed Detection Conditions" \(page 399\)](#).

1. Select [Multifeed Detection] under [Paper Feeding] on the scan settings window.

⇒ The [Multifeed Detection] window appears.

2. Specify whether to delete multifeeds, and select which detection method is to be used.

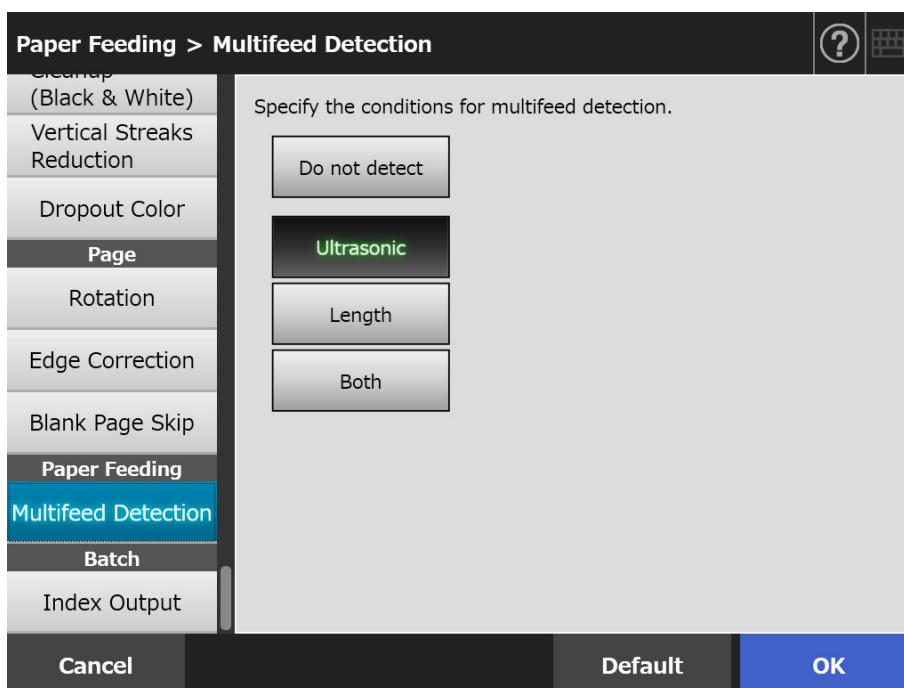

3. Press the [OK] button.

⇒ The information entered is set.

5.8.20 Outputting Index Information

Index information refers to a file in which the scanned results were output.

Specify whether to output the index information.

This option reads an on-document barcode and outputs the results to the index information file.

One barcode can be detected per page. To make multiple barcodes on one page to be detected at once, use SDK (developer tool) to create an add-in application.

For details about barcode types that can be used and detection conditions, refer to "[D.5 Barcode Types and Detection Conditions](#)" (page 421).

1. Select [Index Output] under [Batch] on the scan settings window.

⇒ The [Index Output] window appears.

2. Specify each item.

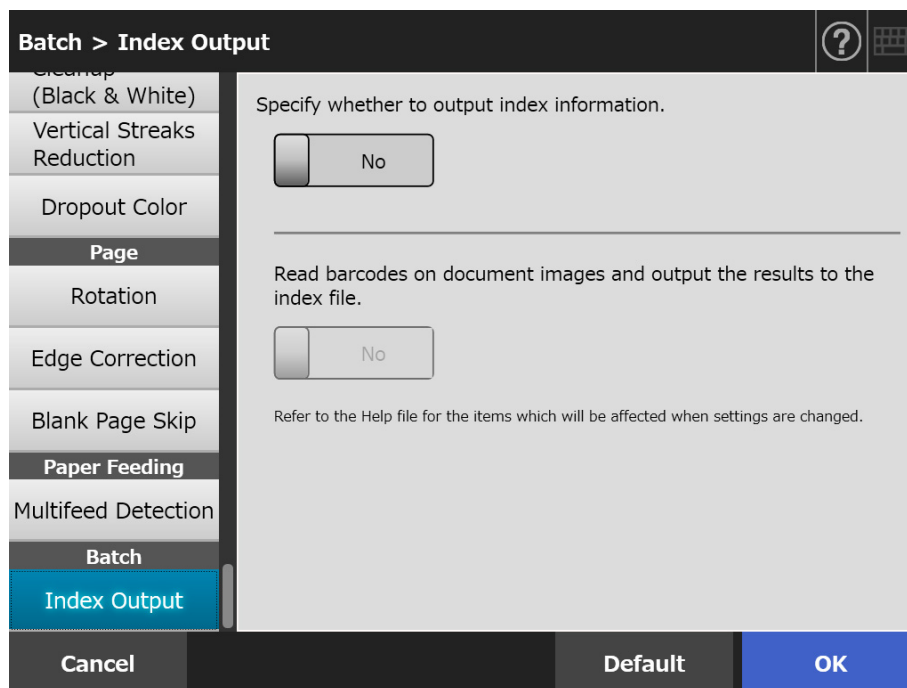

3. Press the [OK] button.

⇒ The information entered is set.

■ Index Information File Format

File Name

The name of an index information file is created as follows:

FileName.ImageModeExtension.index.xml

Example: When a scanned file name is "a.pdf"

a.pdf.index.xml

File Format

This section uses the default output items as an example.

```
<?xml version = "1.0" encoding = "utf-8"?>
<root>
<page>
<item name = "Stream No." value = "Stream No." />
<item name = "Document No." value = "Document No." />
<item name = "Total pages in current document" value = "Total number of pages in
the document" />
<item name = "Page Number in Document" value = "Page number in the document" />
<item name = "Page number" value = "Page number" />
<item name = "Actual page number" value = "Actual page number" />
<item name = "Date&Time" value = "Date and time" />
<item name = "Scanner name" value="Scanner name" />
<item name = "User name" value="User name" />
<item name = "Full Path" value = "File name (full path)" />
<item name = "File name" value = "File name" />
<item name = "Device name" value="Device name" />
<item name = "Barcode" value = "Barcode recognition result" />
<item name = "Barcode type" value = "Barcode type" />
</page>
.
.
</root>
```

- UTF-8 (8-bit UCS Transformation Format) is used for output.
- Page-based information is delimited by the "page" element. Each item information in the page is delimited by the "item" element. The "name" attribute of the "item" element contains the XML item name of the corresponding item. The "value" attribute stores the value of the corresponding item.

Output Items and Order

The following items are output in a predetermined order.

| Item Name | Description | XML Item Name |
|---------------------------------------|--|---------------------------------|
| Stream No. | Stream number Stream number that outputs an image is output. "1" is always output. | Stream No. |
| Document No. | Document number | Document No. |
| Total number of pages in the document | Total number of pages in the document is output. | Total pages in current document |
| Page number in the document | Page number in the document is output. However, "1" is always output for a single page type file. | Page Number in Document |
| Page number | Page number that is counted from the first page | Page number |
| Actual page number | The output page numbers include pages that are skipped due to the blank page skip. When you run [Scan More], page numbering starts from "1" rather than continues from the last page number of the previous file. The last page is not included in "Actual page number" when it is skipped because all blank pages are discarded and [Scan More] is pressed. | Actual page number |
| Date and time | The date and time when a scan was performed The output format is as follows: yyyy/mm/dd HH:mm:ss | Date&Time |
| Scanner name | Name of the scanner that was used for scanning (which is set in [Scanner Name] under [Local Settings]) | Scanner name |
| User name | Name of user that performed a scan | User name |
| File name (full path) | File name (full path) | Full Path |
| File name | File name | File name |

| Item Name | Description | XML Item Name |
|----------------------------|--|----------------------|
| Device name | Device name of the scanner that was used for scanning (N7100 is output as the device name) | Device name |
| Barcode recognition result | Text recognized from a barcode. The first 128 bytes for a one-dimensional barcode. | Barcode |
| Barcode type | Recognized barcode type | Barcode type |

5.9 Enabling/Disabling the Scan Viewer

The [Scan Viewer] window can be set to appear before the scanned data is processed. Scanned data can be checked on the [Scan Viewer] window. The scanned data can be edited on the scan viewer details window which is displayed after a scanned image is selected.

For details, refer to ["5.10 Editing the Scanned Data in the Scan Viewer" \(page 309\)](#). If desired, in the following windows, the [Scan Viewer] window can be set to appear before the scanned data is finally processed.

- [Send e-Mail] window
- [Send Fax] window
- [Print] window
- [Save] window
- [Job Menu] window

ATTENTION

When [Scan Viewer] is disabled on the [Job Menu] window, it is not possible to select whether or not to show the [Scan Viewer] window.

The following explains how to enable or disable the [Scan Viewer] window using the [Send e-Mail] window.

1. Press the toggle button for [Scan Viewer] in the [Send e-Mail] window.

⇒ Pressing this button displays or does not display the [Scan Viewer] window.

The screenshot shows the 'Send e-Mail' window with the following fields: To, Bcc, Cc, Subject, File Name (FI-ACD80PVT05Q8HETK32H4M), and Body. At the bottom, there is a 'Scan Settings' section with a gear icon, a 'Default' button, a 'Scan Viewer' toggle switch currently set to 'On' (green), and a 'Scan' button.

Operations vary according to whether [Scan Viewer] is set to [On] or [Off]. If sending an e-mail, scan operation proceeds as follows:

When sending an e-mail with [Scan Viewer] set to [On]

On the [Send e-Mail] window, press the [Scan] button.

When sending an e-mail with [Scan Viewer] set to [Off]

On the [Send e-Mail] window, press the [Scan & Send] button.

Scanning starts.

The scanned data is shown on the [Scan Viewer] window.

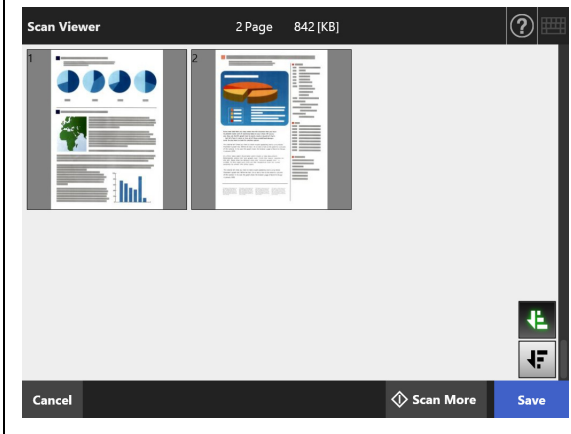

View and edit the scanned data on the scan viewer details window.



When sending an e-mail with [Scan Viewer] set to [On]

When sending an e-mail with [Scan Viewer] set to [Off]

When assisted scan starts, a document is scanned again and the previous image is replaced with the newly edited image.

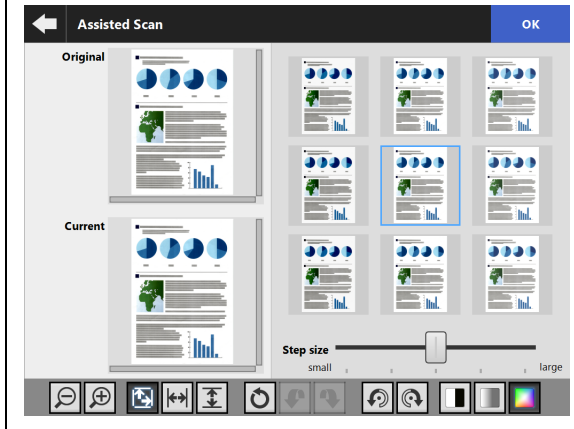

Press the [Send] button on the [Scan Viewer] window.

The scanned data is sent as an e-mail attachment.

ATTENTION

Even if [Scan Viewer] is set to [Off], the [Scan Viewer] window appears under the following circumstances.

- Scan operation did not properly finish.
- Scan operation was canceled by pressing the [Cancel] button in the [Scanning] window.

5.10 Editing the Scanned Data in the Scan Viewer

Scanned data can be checked on the [Scan Viewer] window. The scanned data can be edited on the scan viewer details window which is displayed after a scanned image is selected.

When a file is split, a separator is displayed at the split point in the Scan Viewer.

- When a file is not split

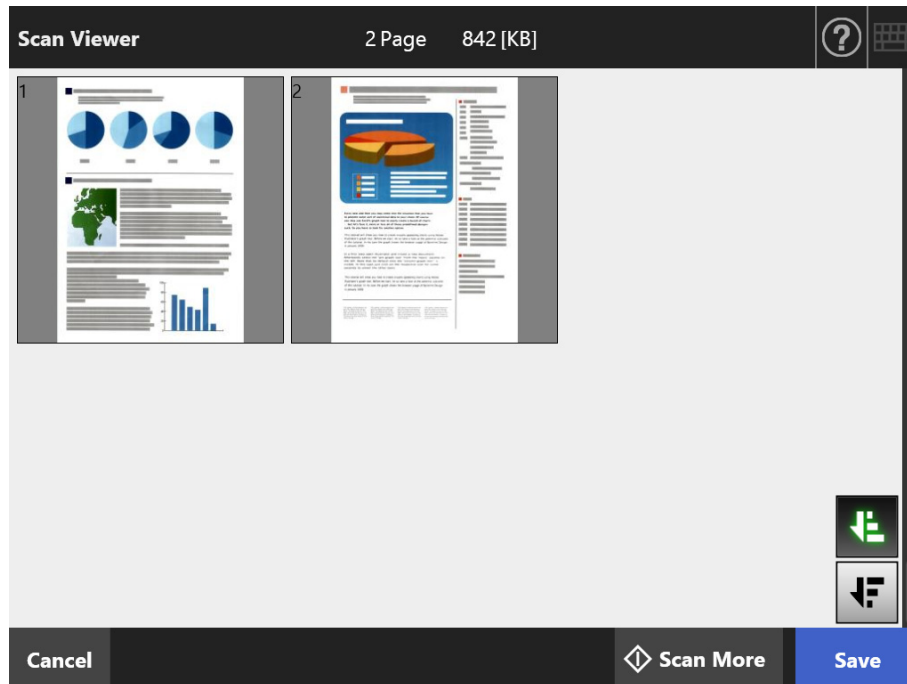

- When a file is split (when a separator is displayed)

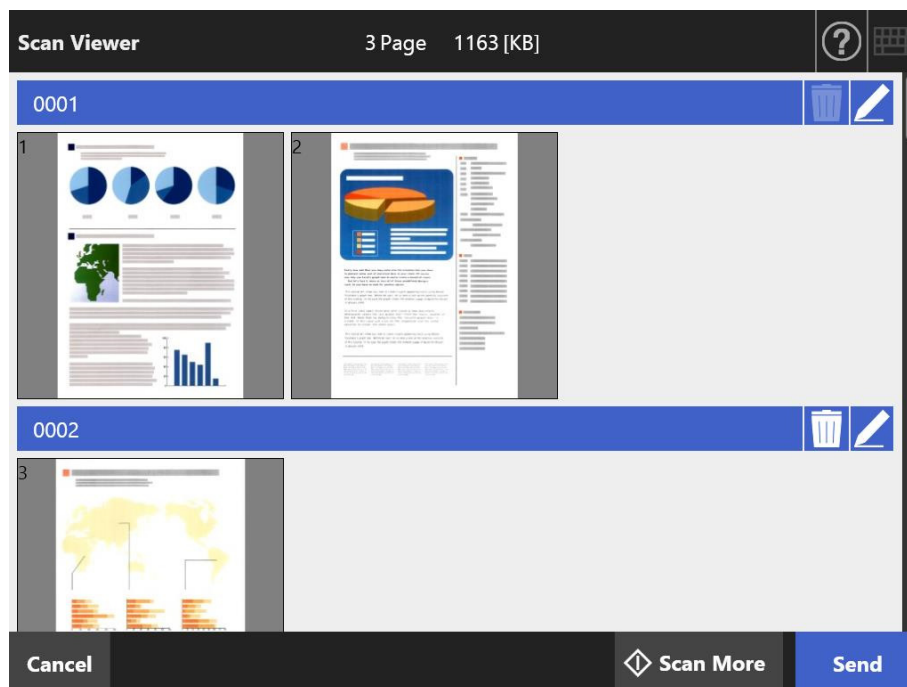



5.10.1 Switching the Page Order of the Scanned Data

When a document with two or more pages is scanned, the page order of the scanned data shown on the [Scan Viewer] window can be switched between descending and ascending orders.

HINT

When a scanned data file is split (when a separator is displayed), the page order of the scanned data cannot be switched.

1. Press  in the [Scan Viewer] window to switch the page order to a descending order.
2. Press  when the pages are in a descending order to put the pages back into the original (ascending) order.

5.10.2 Viewing the Scanned Data

The scanned data can be viewed one by one on the scan viewer details window.

1. Select scanned data on the [Scan Viewer] window.

⇒ The scan viewer details window appears.



2. Touch the scanned data again.

⇒ Buttons for viewing and editing are shown on the scan viewer details window.

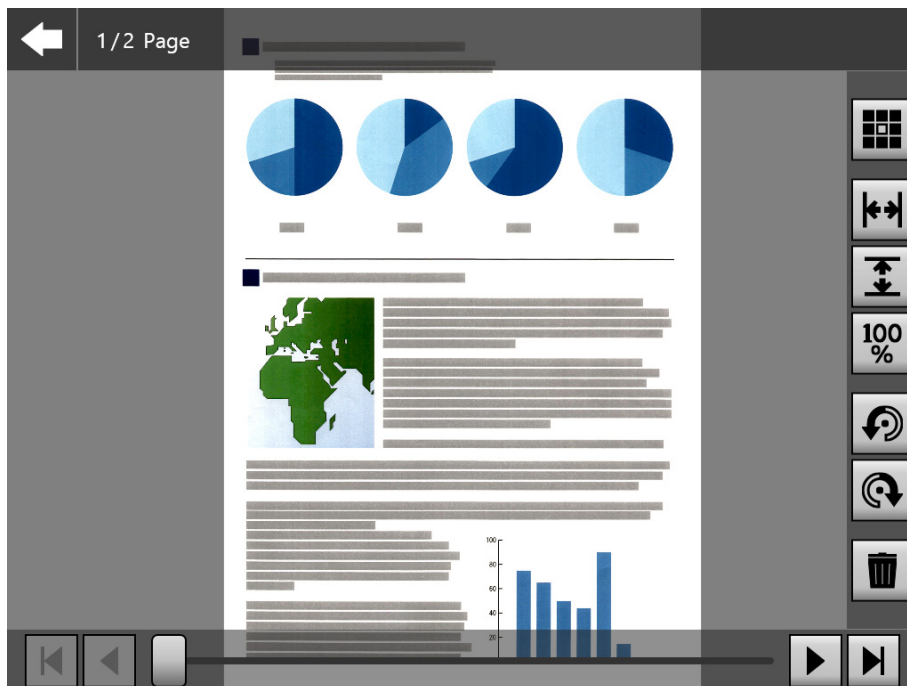



3. Press     to show the page you want to check.

■ Changing the Display Size of Scanned Data

The display size of the scanned data shown on the scan viewer details window can be changed to the same magnification or to fit the preview window.

HINT

Editing on the touch panel can also be done by using fingers. Place two fingers on the scanned data, and pinch out (zoom in) and pinch in (zoom out).

1. Display a page to be checked.
2. Press    to change the display.

5.10.3 Editing Scanned Data on the Scan Viewer Details Window

The scanned data can be edited one by one on the scan viewer details window.

■ Rotating Scanned Data

The scanned data displayed on the scan viewer details window can be rotated by 90 degrees.

The rotated scanned data is sent by e-mail or fax and is printed or saved to the network folder as it is.

HINT

- The scanned data is edited once a page is rotated.
- Editing on the touch panel can also be done by using fingers on the touch panel. Put two fingers on the scanned data and turn your fingers (clockwise/counterclockwise).

1. Display a page to be rotated.
2. Press   to rotate.

■ Deleting Scanned Data

A specific page can be deleted from the scanned data shown on the scan viewer details window.

The scanned data from which a specific page was deleted is sent by e-mail or fax and is printed or saved to the network folder as it is.

1. Display a page to be deleted.

2. Press .

⇒ A message that confirms the deletion appears.

3. Press the [OK] button.

⇒ The page is deleted.

5.10.4 Editing Scanned Data on the [Assisted Scan] Window

Assisted scan is a function that assists an adjustment of scanned data to get the best image.

Adjustments can be made by processing the new scanned data on the [Assisted Scan] window to get the best result.

When assisted scan is used, only one document at a time can be scanned even if more than one document is loaded in the ADF paper chute.

HINT

- The scanned data is edited once an adjustment is made on the [Assisted Scan] window.
- If the carrier sheet setting is set to any other setting besides [Off], assisted scan cannot start.
- When a file is split, assisted scan cannot be used for the image of a patch code sheet.
- When a patch code sheet is scanned with assisted scan, it is scanned as a normal document, not a separator.

1. Display a page to be edited on the scan viewer details window.

2. Press .

3. Load the documents with the images that you want to adjust into the ADF paper chute, and press the [OK] button.

⇒ Scanning starts.

⇒ After scanning is complete, the [Assisted Scan] window appears.

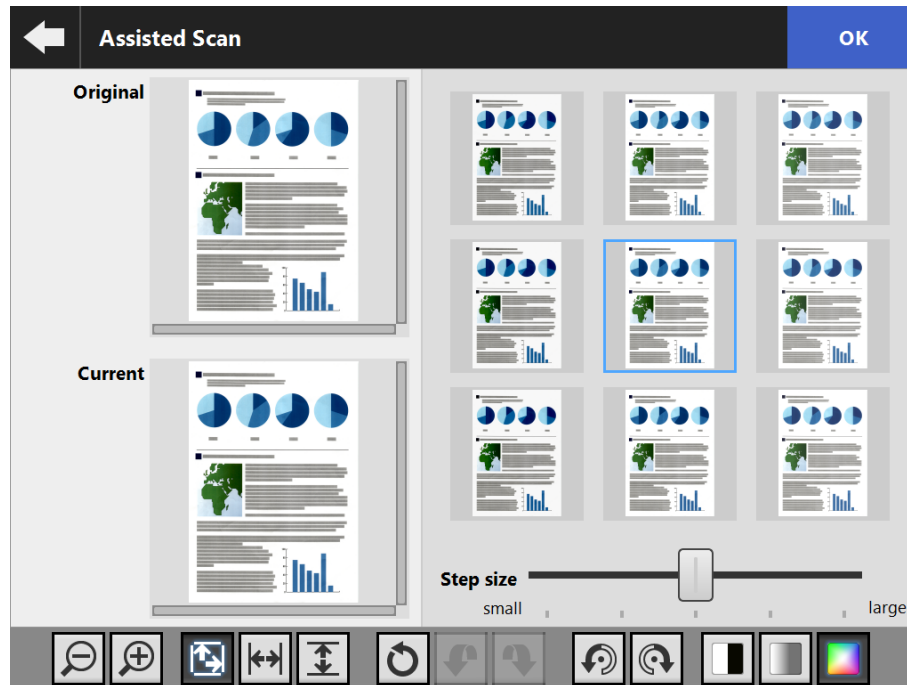

4. Select a sample that is closest to the best image from the sample images.

⇒ A selected sample image is displayed as [Current].

The sample images are updated based on the [Current] image.

The adjustment level of the sample images can be changed by adjusting [Step size].

When the blank page skip function is enabled, the label appears on image and you can check whether it is blank page or not.

The item which can be adjusted varies depending on the image mode. When the image mode is [Black & White], the [Foreground] tab and the [Background] appear.

⇒ Repeat until you get the best image.

5. Press the [OK] button when the most suitable image appears.

⇒ The image is replaced, and the window returns to the scan viewer details window.

■ Changing the Display Size of Scanned Data

The scanned data shown for [Original] and [Current] on the [Assisted Scan] window can be zoomed in and out or can be fitted in the preview window.

1. Press      to change the display size.



■ Resetting a Processed Image

The processed image shown on the [Assisted Scan] window can be re-set to the original image.

1. Press  to reset the processed image to the original image.

■ Undoing and Redoing a Process

An adjustment made to the scanned data shown on the [Assisted Scan] window can be undone or redone.

1. Press   to change the scanned data to the previous state or redo a process.

■ Rotating Scanned Data

The scanned data shown on the [Assisted Scan] window can be rotated by 90 degrees.

1. Press   to rotate the scanned data.

■ Changing the Image Mode of Scanned Data

When the image mode is [Automatic], the image mode of the scanned data shown on the [Assisted Scan] window can be changed.

If this process is performed, the image returns to the original scanned data.

1. Press    to change the image mode.

5.10.5 Editing a Separator

When a separator is displayed in the Scan Viewer, the name of the file that is to be split can be edited.

1. Press  to edit the separator that you want.

⇒ The [Edit Separator String] window appears.

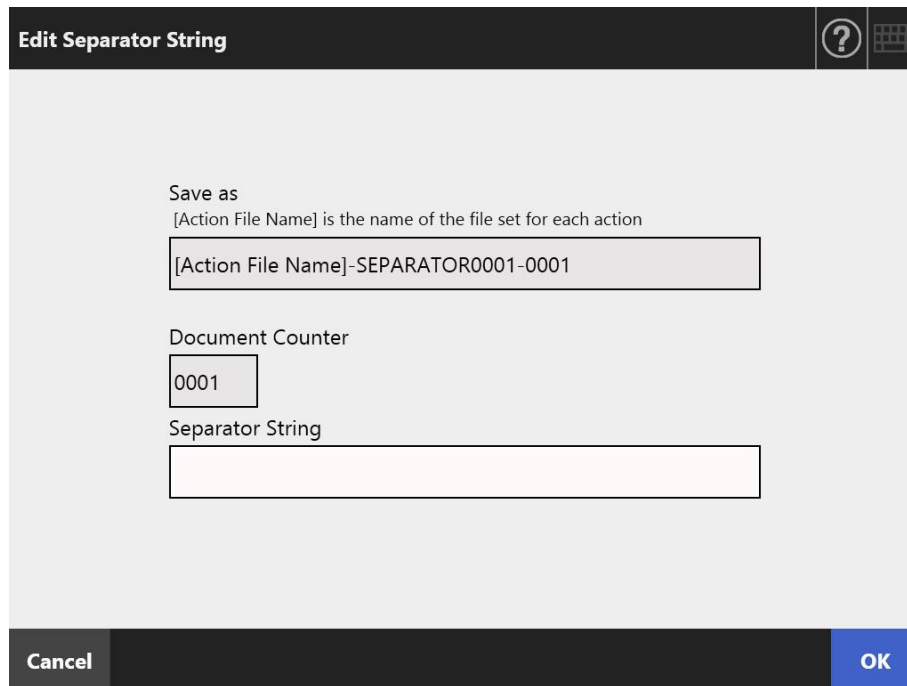

Edit Separator String

Save as
[Action File Name] is the name of the file set for each action
[Action File Name]-SEPARATOR0001-0001

Document Counter
0001

Separator String

Cancel OK

2. Change the string in the Separator String.
3. Press the [OK] button.

⇒ The separator string is changed.

5.10.6 Deleting a Separator

When a separator is displayed in the Scan Viewer window, the separator can be deleted.

1. Press  to delete the separator that you want.
 - ⇒ A window for confirming the deletion appears.
2. Press the [OK] button.
 - ⇒ The separator is deleted.

5.10.7 Scanning an Additional Page

On the [Scan Viewer] window, an additional page can be scanned.

1. Load the documents into the ADF paper chute.
2. On the [Scan Viewer] window, press the [Scan More] button.
 - ⇒ Scanning starts.
 - The scanning status (preview) and scan settings can be switched and shown during a scan.
 - The page numbers of additional pages will follow on from the last page of the current scanned data.
 - For [Print], up to 100 pages can be scanned. For other than [Print], up to 999 pages can be scanned.
 - When the blank page skip function is enabled, the number of scanned pages excluding skipped blank pages is shown.
 - Additional pages can be scanned in place of skipped blank pages, until the maximum number of scanned pages is reached.
 - ⇒ When the scan has completed, the [Scan Viewer] window opens and shows any additionally scanned pages.

HINT

When file splitting is set, additional scanned pages are not recognized as an additional batch and instead of this, all pages including additional pages are recognized as a batch, then split. Example: When file splitting is set to two pages each and additional three pages are scanned after three pages are scanned



5.10.8 Editing Marked Characters to Be Set as Keywords

When character strings in marked sections are scanned to be set as keywords for the PDF file, the recognized text from the marked sections can be edited.

HINT

For more details about setting whether or not to edit character strings in marked sections, refer to "[5.8.9 Setting a Keyword for the PDF](#)" (page 284).

- 1. On the [Scan Viewer] window, press the button appropriate for your desired operation, such as the [Send] and [Save] buttons.**
 - ⇒ The window where you can edit character strings in marked sections appears.
- 2. Edit the characters shown on the window.**
- 3. Press the [OK] button.**
 - ⇒ The edited characters are set as a keyword for the PDF file.

5.11 Viewing the Send Status

5.11.1 Viewing Details on Send Operations That Were Completed (User Log)

The send status is shown for the current user.

The send status is listed in the order of date/time.

Even if the [Region/Timezone] or [Date/Time] settings are changed, the order of the log entries will not be changed.

1. Press the [Send Status] button on the [Main Menu] window or the [Job Menu] window.

HINT

The [Send Status] button on the [Job Menu] window can be shown by pressing .

⇒ The [Send Status] window appears.

2. Press the [Completed] tab.

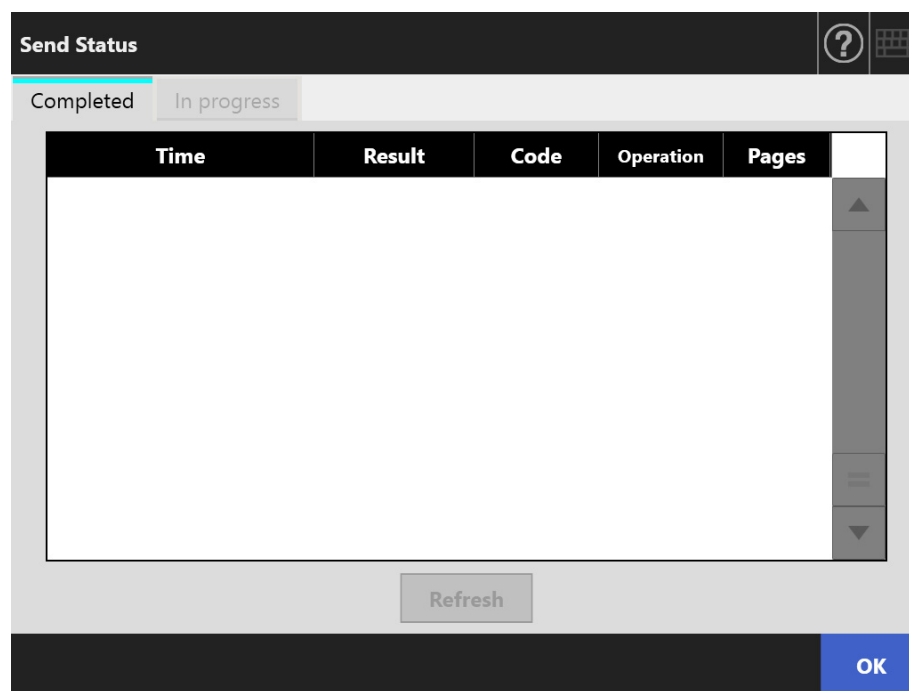

3. Select the send status you wish to view.

⇒ The details of the selected log are displayed.

Pressing the [OK] button returns to the original window.

5.11.2 Viewing Details on Send Operations That Are In Progress

When the send status (job action) is in a waiting state or being retried, the condition of the send status can be viewed.

The list of the send status is shown in order of priority.

The send status that is in a waiting state or being retried can also be cancelled, and if the send status is in an error state, you can retry the job action.

Even if the settings are changed on the [Region/ Timezone] window or the [Date/Time] window, the display order is not changed.

1. Press the [Send Status] button on the [Main Menu] window or the [Job Menu] window.

HINT

The [Send Status] button on the [Job Menu] window can be shown by pressing .

⇒ The [Send Status] window appears.

2. Press the [In progress] tab.

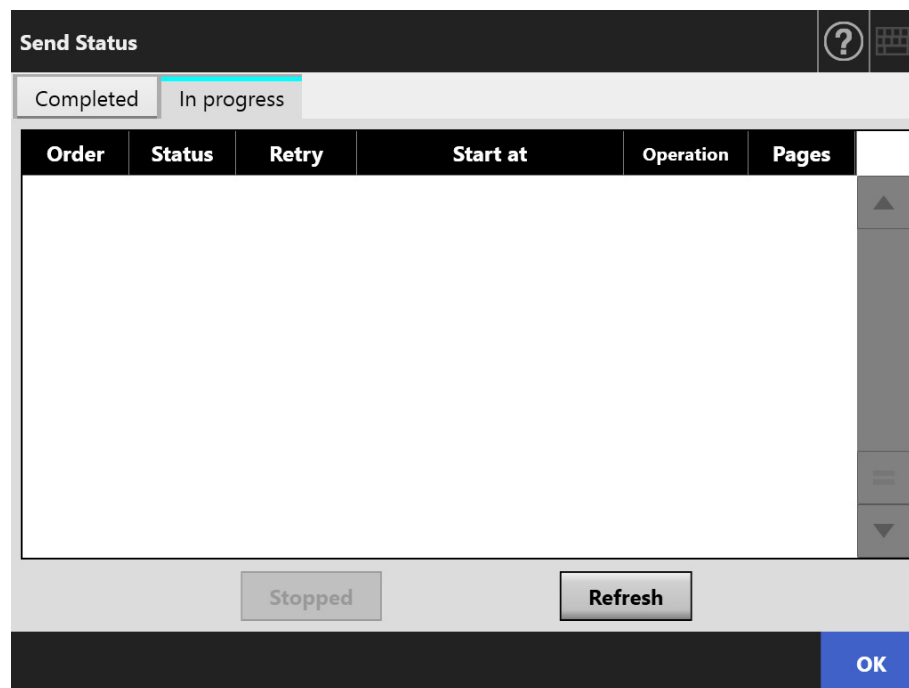

HINT

The [In progress] tab on the [Send Status] window is available if you select [No] for [Wait Job] in [Login Settings Details] on the administrator window.

3. When you want to cancel a send status that is in progress, select the send status which you want to cancel, and press the [Stopped] button.

⇒ The send status which you select is cancelled and the list is updated.

- 4. If the send status is in an error state, check the details of the error and deal with the error.
Select the job action to be retried, and press the [Resend] button.**

HINT

The [Resend] button is displayed when [Yes] is set for [Show [Resend]] in [Login Settings Details] on the administrator window. For more details, refer to "[4.6.2 Setting the Login Settings \(Details\)](#)" (page 93).

⇒ The job action which you selected is retried and the list is updated.

5.12 Maintenance

The following maintenance operations are possible:

- Editing the e-mail address book
- Editing the fax number list
- Roller cleaning
- Scan test
- Administrator login (when [Auto Login] is set to [On] on the [Login Settings] window)
- Changing password (when logged in with a local account)

1. On the [Main Menu] or [Job Menu] window, press the [Maintenance] button.

HINT

The [Maintenance] button on the [Job Menu] window can be shown by pressing .

⇒ The [Maintenance] window appears.

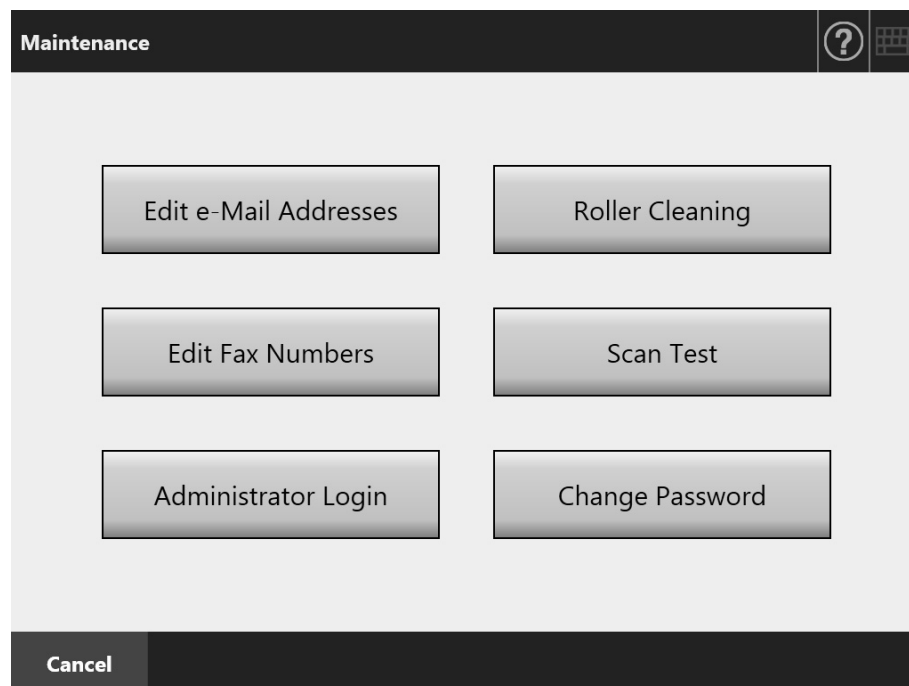

2. Perform maintenance operation by pressing the following buttons:

- [Edit e-Mail Addresses] button
The [e-Mail Address Book] window appears. e-Mail addresses can be added, edited, or deleted.
For details, refer to the following.
["5.4.2 Adding an e-Mail Target to the e-Mail Address Book" \(page 236\)](#)
["5.4.3 Editing an e-Mail Target in the e-Mail Address Book" \(page 240\)](#)
["5.4.4 Deleting an e-Mail Target from the e-Mail Address Book" \(page 242\)](#)

- [Roller Cleaning] button
The [Roller Cleaning] window appears. You can check the way the feed rollers and eject rollers should be rotated.
For details, refer to "[Feed roller \(×2\) and eject roller \(×2\)](#)" (page 342).
- [Edit Fax Numbers] button
The [Fax Number List] window appears. Fax numbers can be added, edited, or deleted.
For details, refer to the following.
["5.5.2 Adding a Contact to the Fax Number List"](#) (page 247)
["5.5.3 Editing the Fax Number List"](#) (page 249)
["5.5.4 Deleting a Contact from the Fax Number List"](#) (page 250)
- [Scan Test] button
A scan test is performed. Scanned data can be checked on the [Scan Viewer] window.
Perform a scan test to check that the scanner scans normally.
For details, refer to "[6.6 Performing a Scan Test](#)" (page 356).
- [Administrator Login] button
Shown when automatic login is enabled in the administrator settings.
Shows the [Administrator Login] window, on which administrator login can be performed.
For details, refer to "[4.2.1 Administrator Login: via the Touch Panel](#)" (page 70).
- [Change Password] button
Shown when logged in as a local account user.
Shows the [Change Password] window, on which the password of the currently logged in user can be changed.
For details, refer to "[5.14 Changing a User Password](#)" (page 334).

5.13 Processing a Job

This section uses an example where buttons from [Job1] to [Job6] have been set.

1. On the [Job Menu] window, press a Job button.

HINT

When the scanner account belongs to multiple job groups, the [Job Menu] windows can be switched by using the job menu switch buttons on the [Job Menu List] window, which appears when a list button is pressed.

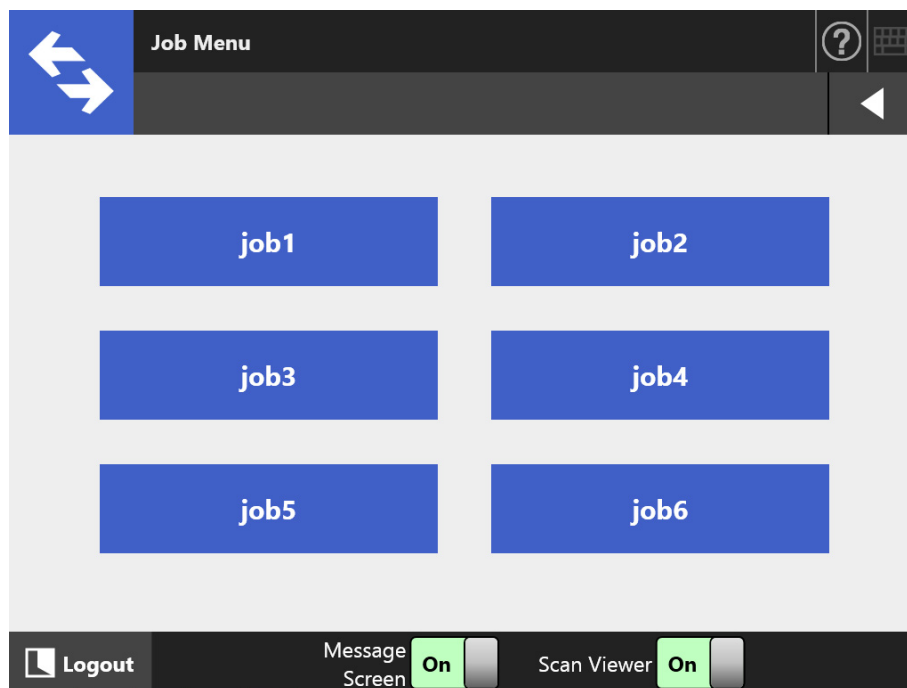
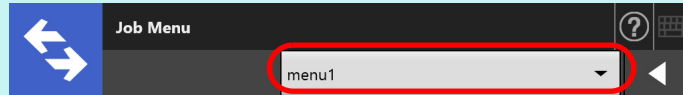

⇒ The Message Screen appears.

HINT

- If either the title or message is not set in [Message Screen] on the [Job Details] window, even when [Message Screen] is set to [On], the [Message Screen] will not be shown. For details, refer to [Step 5 in "4.18.2 Setting a Job Sequence" \(page 191\)](#).
- If [Off] is selected for [Message Screen], scanning is started without showing the [Message Screen], and the job is processed. For details, refer to ["5.13.1 Enabling/Disabling the Message Screen" \(page 326\)](#).
- When [Message Screen] is disabled, whether or not the [Message Screen] is shown depends on the settings configured by the administrator.

2. Press the [Scan] button on the [Message Screen].

⇒ Scanning starts.

When the scanning has completed, the [Scan Viewer] window appears.

HINT

- When [Off] is set, the [Scan Viewer] window is not shown.
- When a file name can be changed, the [File Name] window is shown before a scan. For details about the operation, refer to ["5.13.2 Changing a File Name \(for Save/e-Mail Attachment\)" \(page 328\)](#).
- When the scan count is enabled to be changed in the job sequence settings, the [Scan Count] window is shown before a scan. For details about the operation, refer to ["5.13.3 Checking the Number of Sheets to Be Scanned" \(page 329\)](#).

3. Check and edit the scanned data.

Scanned data can be checked on the [Scan Viewer] window. The scanned data can be edited on the scan viewer details window which is displayed after a scanned image is selected.

For more details, refer to ["5.10 Editing the Scanned Data in the Scan Viewer" \(page 309\)](#).

4. Press the [OK] button on the [Scan Viewer] window.

⇒ The data is processed according to the specified job.

While the job is being processed, the process is shown in real time on the [Job Progress] window.

HINT

- To view the job report, press the [Job Report] button on the [Job Progress] window. This will show the job report.
- To view detailed information on the job report, select a function name on the [Job

Report] window or press . This will show the job report details.

⇒ If the job sequence is processed successfully, the touch panel screen returns to the [Job Menu].

If an error occurs during the job process, the [OK] button appears on the [Job Progress] or [Job Report] window. Pressing the [OK] button returns to the [Job Menu].

5.13.1 Enabling/Disabling the Message Screen

You can select whether to show the [Message Screen] for checking the contents of a job.

ATTENTION

When [Message Screen] is disabled, it is not possible to select whether or not to show the [Message Screen].

This section uses an example where buttons from [Job1] to [Job6] have been set.

1. Press the toggle button for [Message Screen] in the [Job Menu] window.

⇒ Pressing this button displays or does not display the [Message Screen] window.

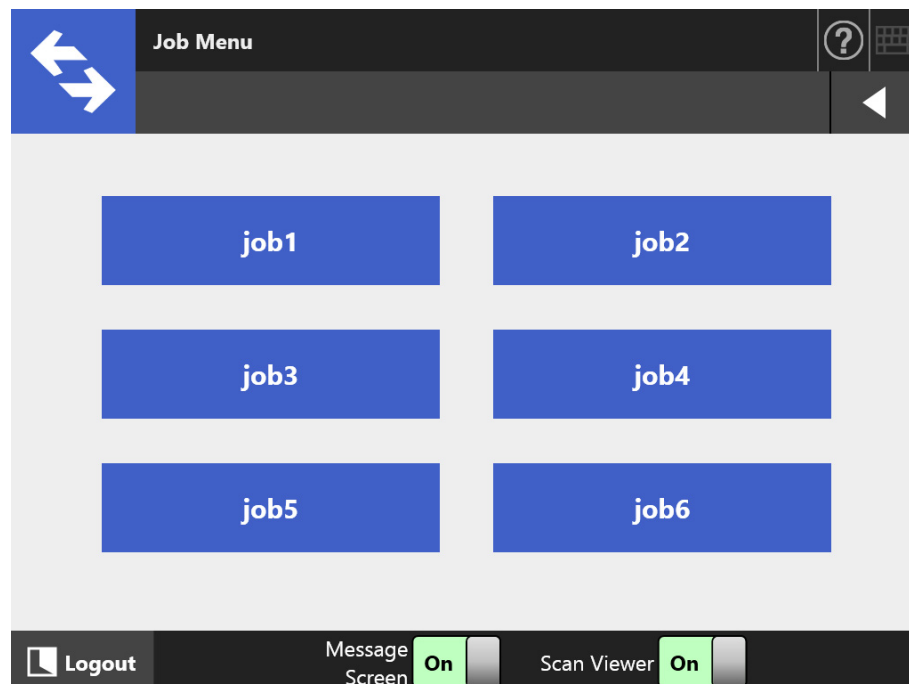

Operations vary according to whether the [Message Screen] is set to [On] or [Off].

- If a job sequence is processed when [Message Screen] is set to [On], the [Message Screen] will be shown.

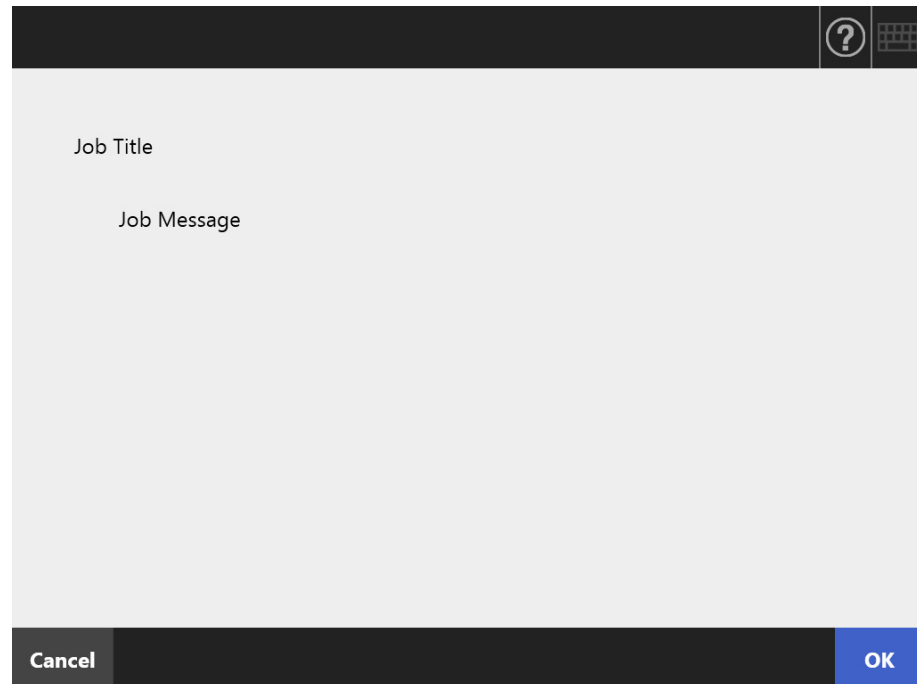
**HINT**

After checking the message, press the [Scan] button to start the scan. If any further job setup steps are required, press the [OK] button that appears instead.

- If a job sequence is processed when [Message Screen] is set to [Off], the job will be processed without showing the [Message Screen].

5.13.2 Changing a File Name (for Save/e-Mail Attachment)

When a job is processed, file names to be used when saving or attaching scanned data to an e-mail can be changed.

HINT

It is not possible to change a file name when the [File Name] window is set not to be shown.

1. On the [Job Menu] window, press a Job button.
2. On the [File Name] window, enter a file name for the scanned data to be saved or sent by e-mail.

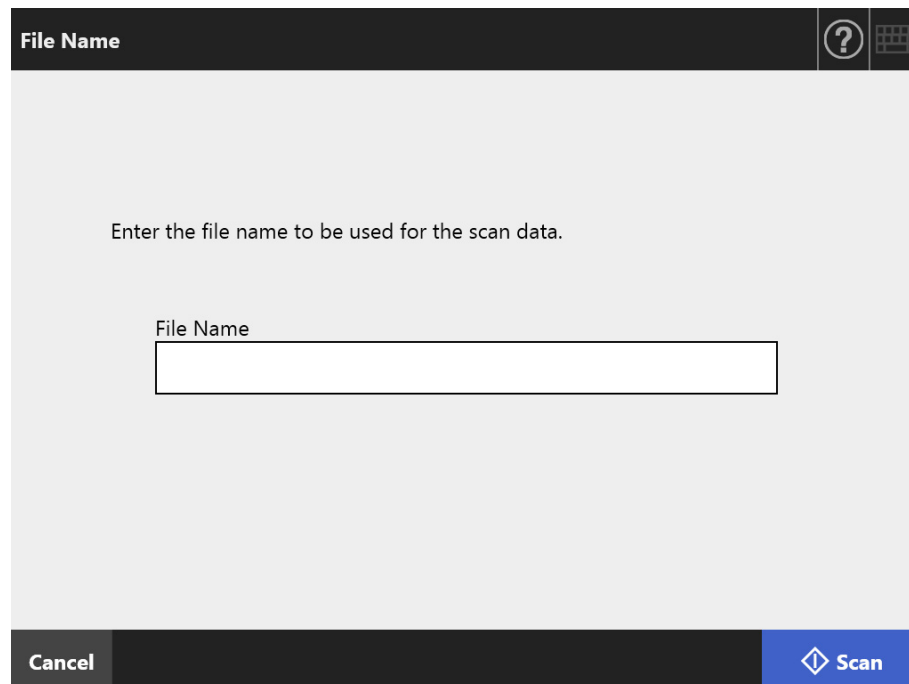

The screenshot shows a dialog box titled "File Name". At the top right, there are icons for help (a question mark) and a keyboard layout. The main area contains the instruction "Enter the file name to be used for the scan data." Below this is a text input field with the label "File Name" above it. At the bottom, there are two buttons: "Cancel" on the left and "Scan" on the right, which has a diamond icon next to it.

HINT

- When sequence numbers are set to be appended to file names or file splitting is enabled, a sequence number is appended to the end of the default file name. The guidance message, "Document counter/seperator string will be appended to the file name." or "A sequence number will be appended to the file name." is shown on the window.
- A sequence number will not be appended to a file name that has been edited.
- After entering the file name, press the [Scan] button to start the scan. If any further job setup steps are required, press the [OK] button that appears instead.

5.13.3 Checking the Number of Sheets to Be Scanned

When a job is processed, the expected number of sheets to be scanned can be specified, so that the actual number of scanned sheets can be checked after a scan.

HINT

If either of the following settings is selected for the job sequence setting, the [Scan Count] window is not shown.

- The [Scan Count] is not to be checked
- The [Scan Count] is to be checked, but the [Scan Count] window is set not to appear (The [Allow per-Job adjustment] check box in the [Check the Scan Count] on the [Job Details] window is not selected)

1. On the [Job Menu] window, press a Job button.
2. On the [Scan Count] window, enter the number of sheets that are to be scanned.

Scan Count

Enter the number of sheets that are to be scanned.

Expected Count: sheets (1-999)

Cancel Scan

3. Press the [Scan] button.

⇒ Scanning starts.

HINT

When the [Scan Viewer] window is shown after a scan, you can check whether the number of scanned sheets is the same as that set in the [Scan Count] window at the area shown below.

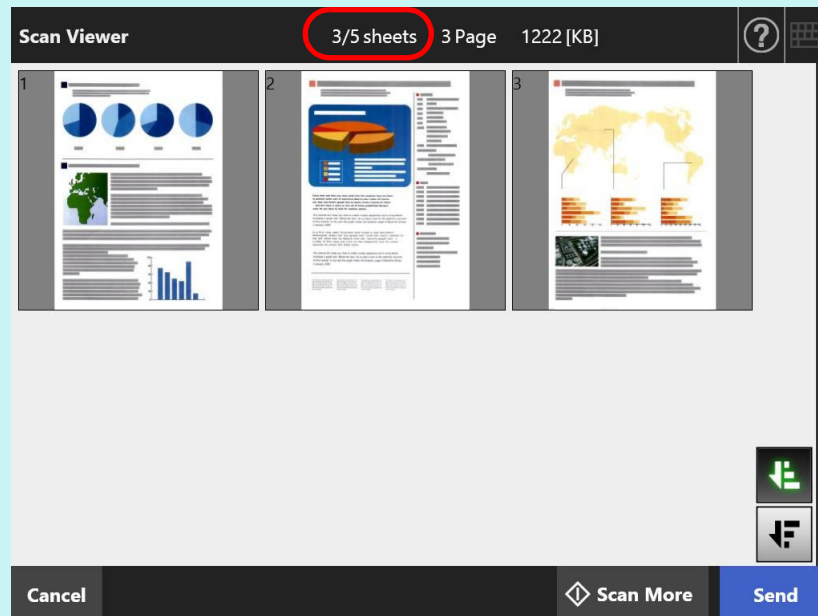

Even if pages are deleted on the scan viewer details window or blank pages are deleted, the number of scanned sheets is not changed.

After scanning has completed, the following confirmation window is shown if the number of scanned sheets is set to be checked. Contact the administrator to change the setting of whether or not to check the scan count. For details, refer to ["4.18.2 Setting a Job Sequence" \(page 191\)](#).

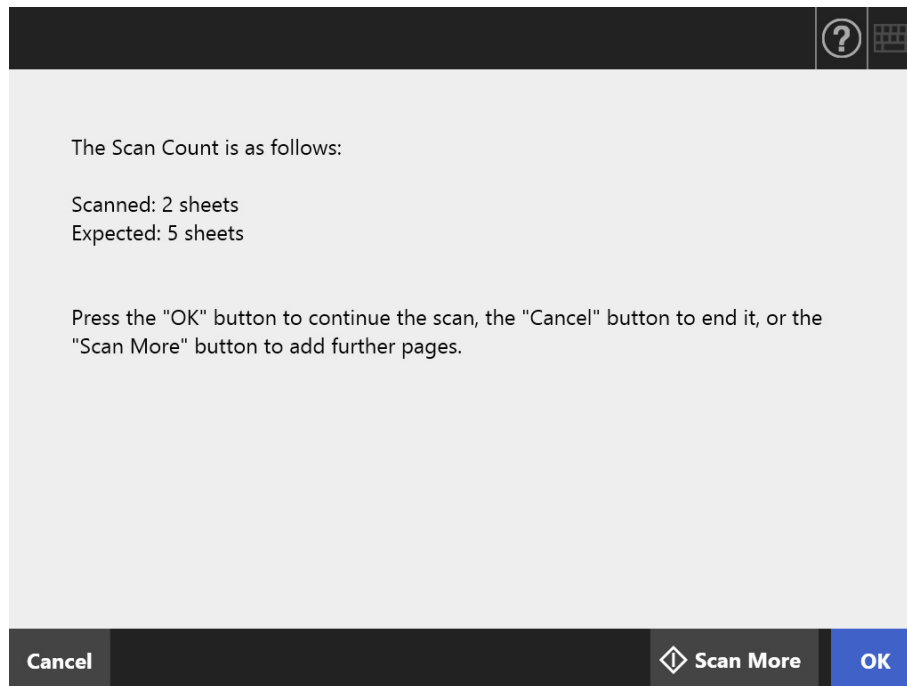
**HINT**

When the [Scan More] button is shown, press the button to add more pages.

To continue, press the [OK] button.

To cancel the process and delete the scanned data, press the [Cancel] button.

5.13.4 Splitting a File Using Patch Codes

The separation function with patch code sheets is supported for a job sequence. This function allows you to split a file in a specified unit of pages without stopping a scan when scanning more than one document. A file is split in a specified unit of pages, and consequently the scanned images are separated into each scanned document (unit of pages that is split).

Notes for using patch codes to split a file are as follows:

1. Prepare for scanning.

- Prepare patch code sheets.
Two types of PDF files, A4 size and Letter size, are available for patch code sheets.
Print as many PDF files as you need from the [Patch Code] folder within the [Network Scanner] folder that is created when Admin Tool is installed.
To view the where PDF files are stored on Windows 10:
Select [Start] menu → [Network Scanner] → [Patch Code] → [A4] or [Letter].
- Set a job sequence for splitting a file using patch codes.
Select [Patch Code] for [Separation Mode] under [Save] on the scan settings window for the job sequence.
If you do not save the image of the patch code sheet, select the [Remove separator] check box.

2. Scan documents.

Load documents with patch code sheets inserted into the points where documents are to be separated.

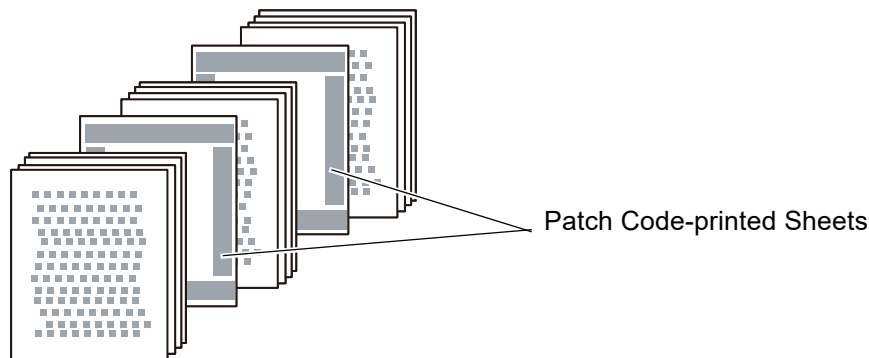

- #### 3. After the scan is complete, check whether the scanned data file is split at the correct points.

ATTENTION

- When printing a patch code sheet, pay attention to the following:
 - Use blank white paper.
 - Print it at 100%. If you print it in a reduced size, the printed sheet is not recognized correctly.
 - Do not use the toner saving function. When the printing is light, it is not recognized correctly.
 - Do not use thin paper. When bleed-through occurs, the printed sheet is recognized as a sheet that is printed on both sides.
- When you copy the printed patch code sheet with a copier, configure the copying setting so that the copied sheet has the same size and printing density.
- Using the same patch code sheet repeatedly may decrease the recognition accuracy due to accumulated dirt on the sheet. If the sheet is not recognized correctly or gets smudged, print a new patch code sheet and use it.

5.14 Changing a User Password

A user password can be changed when logged in as a user registered in a local account.

1. On the [Maintenance] window, press the [Change Password] button.

⇒ The [Change Password] window appears.

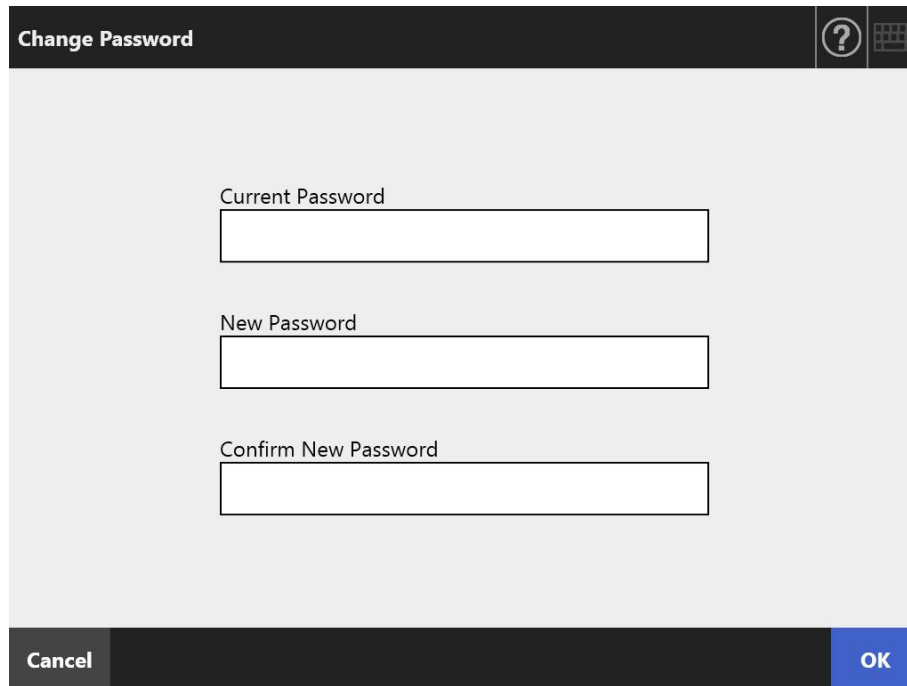

The screenshot shows a dialog box titled "Change Password". The dialog has a dark header bar with the title "Change Password" on the left, a question mark icon in a circle, and a keyboard icon on the right. The main area is light gray and contains three text input fields stacked vertically. The first field is labeled "Current Password", the second is labeled "New Password", and the third is labeled "Confirm New Password". At the bottom of the dialog, there is a dark bar with two buttons: "Cancel" on the left and "OK" on the right.

2. Enter the current password and a new password.

3. Press the [OK] button.

⇒ The user password is changed.

Chapter 6

Scanner Care

Admin

User

This chapter describes how to clean the scanner and replace parts in order to maintain the scanner in optimum scanning condition.



Do not use any aerosol sprays or alcohol-based sprays to clean the scanner. Dust blown up by strong air from the spray may enter the inside of the scanner. This may cause the scanner to fail or malfunction.



Sparks, caused by static electricity, generated when blowing off dust and dirt from the outside of the scanner may cause a fire.



The glass inside the ADF can become hot when the scanner is used. Before cleaning the inside of the scanner or replacing any parts, turn off the power, unplug the power cable from the AC outlet, and wait for at least 15 minutes.



Clean the feed rollers and eject rollers when the power is on.

Before replacing any parts, turn off the power, unplug the power cable from the AC outlet, and wait for at least 15 minutes.



| | |
|---|------------|
| 6.1 Cleaning Supplies and Parts to Clean | 336 |
| 6.2 Cleaning the Exterior of the Scanner | 338 |
| 6.3 Cleaning Inside the Scanner | 339 |
| 6.4 Cleaning a Carrier Sheet | 345 |
| 6.5 Replacing Parts | 346 |
| 6.6 Performing a Scan Test | 356 |
| 6.7 Calibrating the Touch Panel | 359 |

6.1 Cleaning Supplies and Parts to Clean

■ Cleaning Supplies

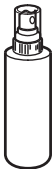
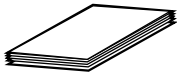
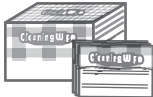
| Cleaning Supplies | Part No. | Remarks |
|--|--|--|
| Cleaner F1  | PA03950-0352 | 1 bottle (100 ml) Used to lightly moisten the cloths before wiping parts clean. When a large amount of the cleaner is used, it may take some time until it is dry. Use an appropriate amount to moisten the cloths. Also, wipe off Cleaner F1 well from the part with a dry cloth. |
| Cleaning Paper  | CA99501-0012 | 1 pack (10 sheets) Used with Cleaner F1. |
| Cleaning Wipe  | PA03950-0419 | 1 pack (24 sheets) Pre-moistened with Cleaner F1, Cleaning Wipes are used instead of moistened cloths. |
| Soft, dry cloth | Any commercially available lint-free product | |

Contact your FUJITSU scanner dealer or an authorized FUJITSU scanner service provider to obtain these products. For more details, refer to the following web page:
<https://www.fujitsu.com/global/about/resources/shop/computing/peripheral/scanners/index.html>

■ Which Parts and When

| Part to Clean | Cleaning Frequency |
|-------------------|---|
| Brake roller | Clean after every 1,000 sheets are scanned. |
| Feed roller | |
| Eject roller | |
| Pick roller | |
| Idler roller | |
| Glass | |
| Ultrasonic sensor | |

ATTENTION

Cleaning frequency may be increased depending on the condition of documents. When the following types of documents are scanned, the scanner parts need to be cleaned more frequently than indicated above.

- Coated paper
- Documents with large areas of printing
- Specially treated paper such as carbonless paper
- Paper containing large amounts of calcium carbonate filler
- Documents written in pencil
- Documents with insufficiently fused toner

6.2 Cleaning the Exterior of the Scanner

■ Cleaning the Scanner Body

The scanner exterior (other than the touch panel), the ADF paper chute, and the stacker must be cleaned using a dry cloth or a cloth slightly moistened with Cleaner F1 or a mild detergent. Cleaning Wipes can also be used.

ATTENTION

- Do not use paint thinner or other organic solvents. The shape or color may be changed.
- Make sure that water does not get inside the scanner when cleaning.
- When a large amount of Cleaner F1 or a mild detergent is used, it may take some time until it is dry. Use a small amount to moisten the cloths. Also, wipe off Cleaner F1 well from the part with a dry cloth.

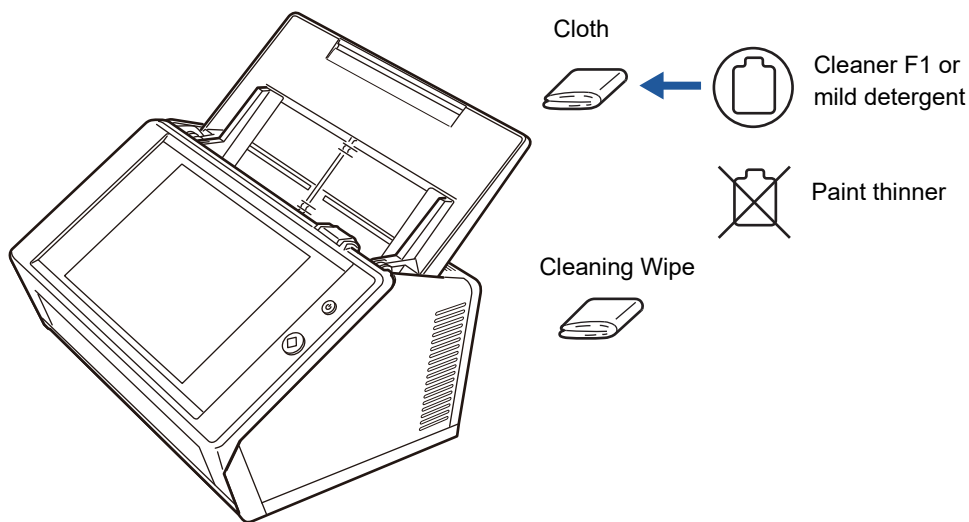

■ Cleaning the Touch Panel

To prevent the touch panel screen from becoming dirty, it should be regularly cleaned with a soft, dry cloth.

Take care when cleaning the touch panel. It can be easily damaged, and should never be scratched or banged with hard objects.

ATTENTION

Do not wipe the touch panel with a damp cloth.

Dust on the panel surface may become stuck between the panel and frame, causing the touch panel to malfunction.

6.3 Cleaning Inside the Scanner

Clean the interior of the scanner with a cloth slightly moistened with Cleaner F1 or the Cleaning Wipe.

Scanning repeatedly may cause dust and paper dust to accumulate inside the scanner resulting in a scanning error.

As a guideline, the inside of the scanner should be cleaned every 1,000 sheets scanned. However, this criteria varies according to the type of documents scanned. For example, it may be necessary to clean the scanner more frequently when documents with insufficiently fused toner are scanned.



The glass scanner windows inside the ADF can become hot when the scanner is used.

Turn off the scanner, unplug the power cable, and wait for at least 15 minutes before cleaning.

ATTENTION

- Do not use water or mild detergent to clean the inside of the scanner.
- When a large amount of the cleaner is used, it may take some time until it is dry. Use a small amount to moisten the cloths. Also, wipe off Cleaner F1 well from the part with a dry cloth.

1. Turn off the scanner power and wait for at least 15 minutes.

For details, refer to ["2.1 Turning the Power On/Off" \(page 49\)](#).

2. Unplug the power cable from the AC outlet.

3. Pull the cover release catch toward you and open the LCD cover.

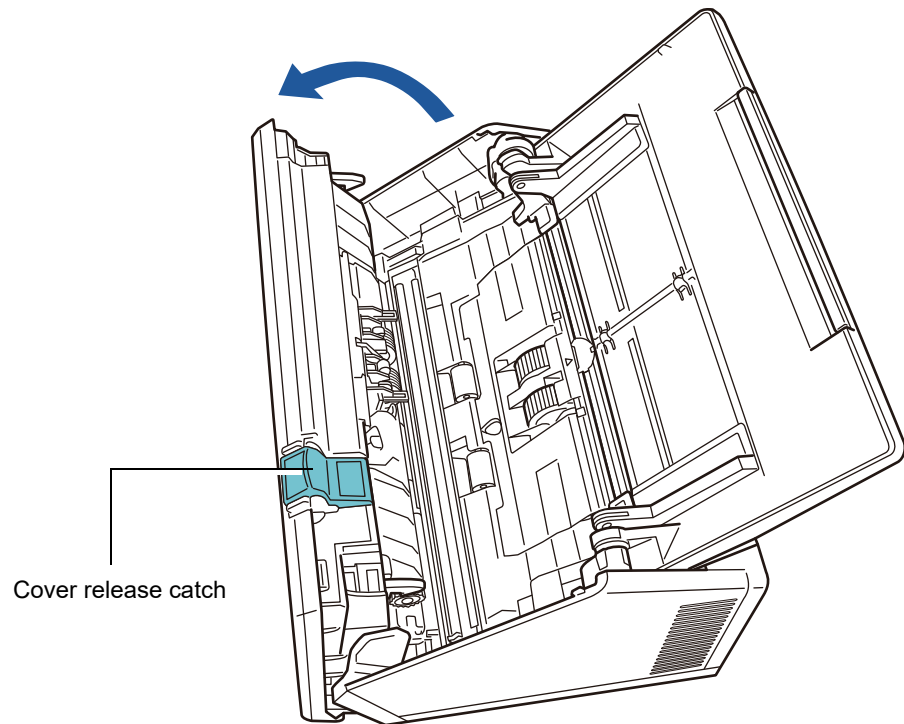

Be careful that the LCD cover does not shut on your fingers.

4. Clean the following parts with a soft cloth slightly moistened with Cleaner F1 or with the Cleaning Wipe.

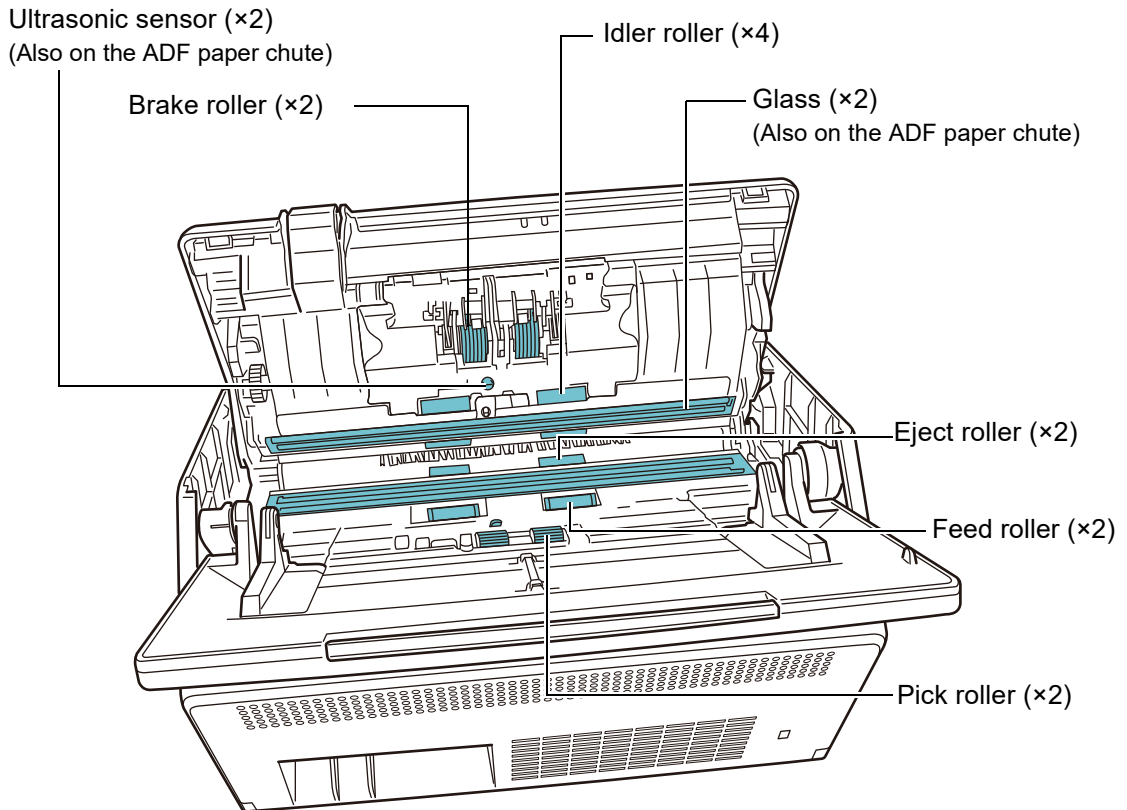

● Brake roller (×2)

Remove the brake rollers from the scanner to clean.

For details on how to remove the brake rollers, refer to "[6.5.3 Replacing the Roller Set](#)" (page 348).

Gently wipe the dirt and dust off from along the slots on the surface of the brake rollers. Take care not to damage the soft rubber.

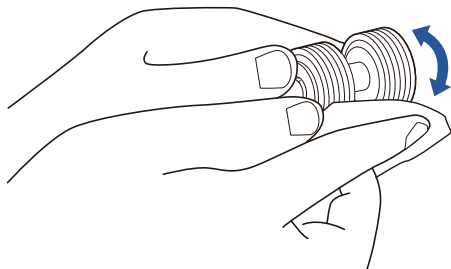

- Ultrasonic sensor (×2)
Clean lightly with a soft cloth to wipe their surfaces clean. If you have trouble wiping them with the cloth, use a cotton swab.

ATTENTION

Be careful when cleaning not to catch the cloth or the Cleaning Wipe in the document detection sensor.

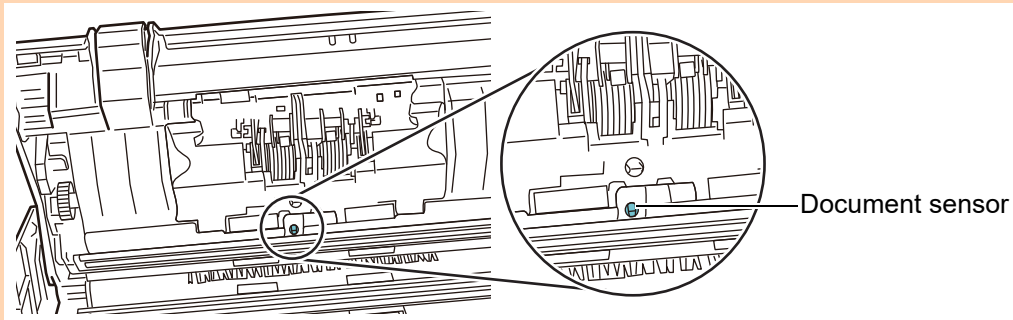

- Idler roller (×4)
Gently rotate the idler rollers by hand as you wipe them clean. Take care not to damage the soft rubber. The idler rollers should be cleaned carefully and thoroughly, as dirty idler rollers can adversely affect the paper pickup performance.
- Glass (×2)
Clean lightly with a soft cloth to wipe their surfaces clean.

HINT

If the glass is dirty, a vertical line may appear on the scanned image.

- Pick roller (×2)
Gently wipe the dirt and dust off from along the slots on the surface of the roller as you rotate it manually. Take care not to damage the soft rubber. The pick roller should be cleaned carefully and thoroughly, as a dirty pick roller can adversely affect the paper pickup performance.
- Feed roller (×2) and eject roller (×2)
When cleaning, turn on the power and let the feed rollers and eject rollers rotate.

- 1 Connect the power cable, and turn on the scanner.
For details, refer to ["2.1 Turning the Power On/Off" \(page 49\)](#).

ATTENTION

The scanner needs to be on only when cleaning the feed rollers and eject rollers.

- 2 On the [Main Menu] or [Job Menu] window, press the [Maintenance] button.

HINT

The [Maintenance] button on the [Job Menu] window can be shown by pressing .

⇒ The [Maintenance] window appears.

- 3 Press the [Roller Cleaning] button.

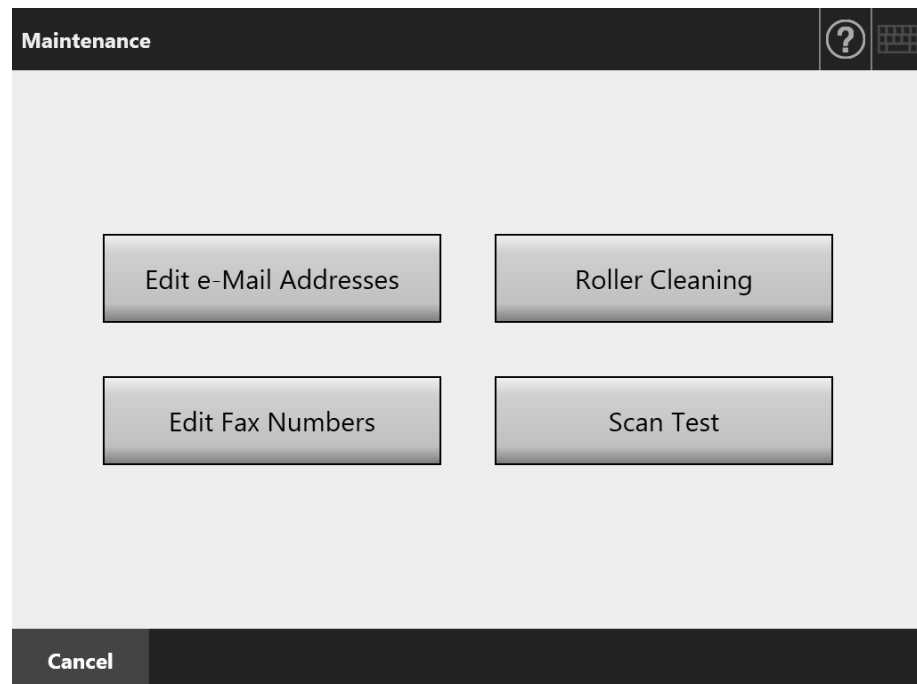

⇒ The [Roller Cleaning] window appears.

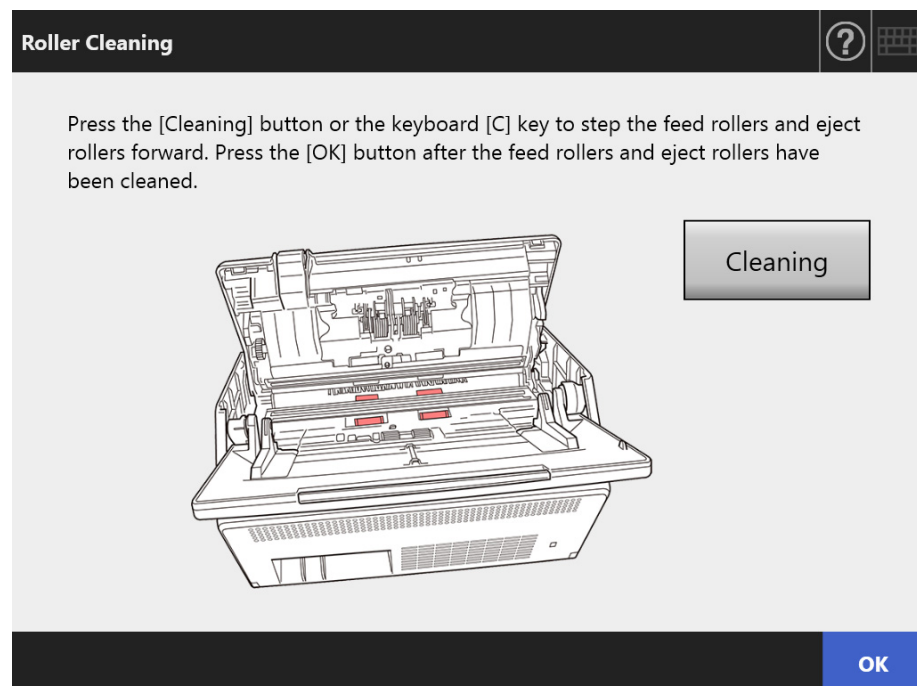

- 4 Open the LCD cover.
- 5 Lightly press a soft cloth slightly moistened with Cleaner F1 or the Cleaning Wipe against the surface of the rollers.

- 6 Press the [Cleaning] button on the [Roller Cleaning] window.
When the button is pressed, the feed rollers and eject rollers rotate slightly. Pressing the button continuously rotates the feed rollers and eject rollers for a fixed amount every few seconds.
Gently clean the rollers as you rotate them. Take care not to damage the soft rubber.
Stop pressing the button to stop the rollers rotating.
The pick rollers should be cleaned carefully and thoroughly, as black residue on the rollers can adversely affect the paper pickup performance.

HINT

- Pressing the [Cleaning] button seven times rotates the feed rollers and eject rollers approximately one complete revolution.
- When Help is shown, close it before pressing the [Cleaning] button.

- 7 When you have finished cleaning the rollers, press the [OK] button, and close the [Roller Cleaning] window.

ATTENTION

When cleaning the feed rollers or eject rollers, be careful not to touch the rollers with your fingers while they are rotating.

5. Close the LCD cover.

⇒ You should hear a click.

ATTENTION

- Be careful that the LCD cover does not shut on your fingers.
- Confirm that the LCD cover is completely closed. If the cover is not completely closed, document jams and feeding errors may occur.
- When closing the LCD cover, do not slam it shut by pushing the touch panel as this may damage it.

6.4 Cleaning a Carrier Sheet

Use a soft dry cloth, a cloth slightly moistened with Cleaner F1 or a mild detergent, or the Cleaning Wipe to clean a Carrier Sheet.

Lightly wipe off the dirt and dust from the surface and interior of a Carrier Sheet.

As the Carrier Sheet is repeatedly used, dirt and dust may collect on the surface of or inside the Carrier Sheet.

To prevent scanning malfunction, the carrier sheet should be regularly cleaned.

ATTENTION

- Be careful not to leave any crease on the Carrier Sheet.
- Do not use paint thinner or other organic solvents. The shape or color may be changed.
- Do not rub too hard, as the Carrier Sheet may become scratched or deformed.
- After cleaning the interior of the Carrier Sheet, wait until it has completely dried before closing it.
- As a guideline, it is recommended to replace the Carrier Sheet every 500 scans.

For details about purchasing a Carrier Sheet, refer to ["6.5.4 Purchasing a Carrier Sheet"](#) (page 355).

6.5 Replacing Parts

6.5.1 Part Numbers and Replacement Cycle

The following table specifies the replacement part numbers and the standard replacement cycles.

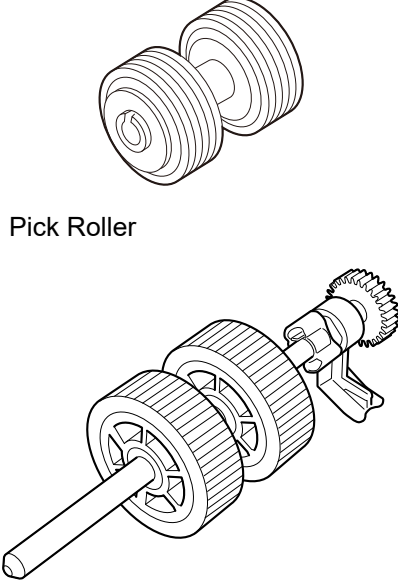
| Part Name | Part No. | Replacement Cycle |
|---|--------------|---|
| Roller Set ● Brake Roller  ● Pick Roller | PA03706-0001 | After every 200,000 sheets scanned or once a year |

These replacement cycles are rough guidelines for when using 80 g/m² (20 lb) A4/Letter woodfree or wood containing paper. They may vary according to the type of documents scanned, scanner usage, and cleaning frequency.

ATTENTION

- When the consumable alert status is orange or red, contact your scanner administrator to replace the necessary part.
- Use only the PFU parts specified. Do not use consumable parts made by other manufacturers.

For more details about how to check the consumable alert status, refer to "6.5.2 Checking the Consumable Alert Status" (page 347).

To obtain these parts, contact your FUJITSU dealer or an authorized FUJITSU scanner service provider. For more details, refer to the following web page:

<https://www.fujitsu.com/global/about/resources/shop/computing/peripheral/scanners/index.html>

6.5.2 Checking the Consumable Alert Status

1. On the [Main Menu] or [Job Menu] window, press the [Consumable Alert] button.

HINT

The [Consumables Alert] button on the [Job Menu] window can be shown by pressing



⇒ The [Consumable Alert] window appears.

2. Check which part needs to be replaced and press the [OK] button.

Parts whose [Usage Counter] value is bigger than the [Replace At] value should be replaced.

The value of [Usage Counter] is the exact number of scanned sheets.

For details on how to check the status of consumable parts on the administrator window, refer to ["4.15.2 Viewing the Usage Status" \(page 160\)](#).

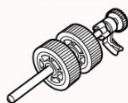
| Consumable Alert | | | |
|---|---------------|------------|----------------|
| Part | Usage Counter | Replace At | Current Status |
| Brake roller  | 0 | 200,000 | |
| Pick roller  | 0 | 200,000 | |

OK

3. Replace the part.

Refer to the following:

- Replacing the Roller Set.
["6.5.3 Replacing the Roller Set" \(page 348\)](#)

6.5.3 Replacing the Roller Set

The Roller Set is made up of the brake roller and the pick roller. The procedure for replacing each roller is as follows.

1. Turn off the scanner power and wait for at least 15 minutes.

For details, refer to ["2.1 Turning the Power On/Off" \(page 49\)](#).

2. Unplug the power cable from the AC outlet.

3. Remove any documents from the ADF paper chute.

4. Pull the cover release catch toward you, place your hands at both sides of the LCD cover, and open the LCD cover.



Be careful that the LCD cover does not shut on your fingers.

5. Replace the brake roller.

1. Open the cover of the brake roller.

Hold both ends of the cover of the brake roller, and open it in the direction of the arrow.

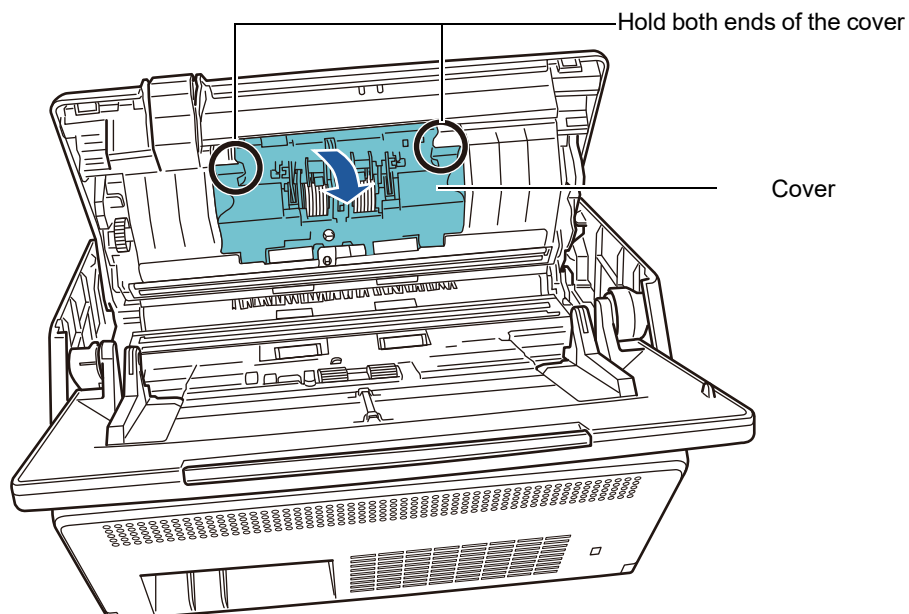

2. Remove the shaft.
Lift the right side of the roller first, then pull out the shaft from the slot on the left.

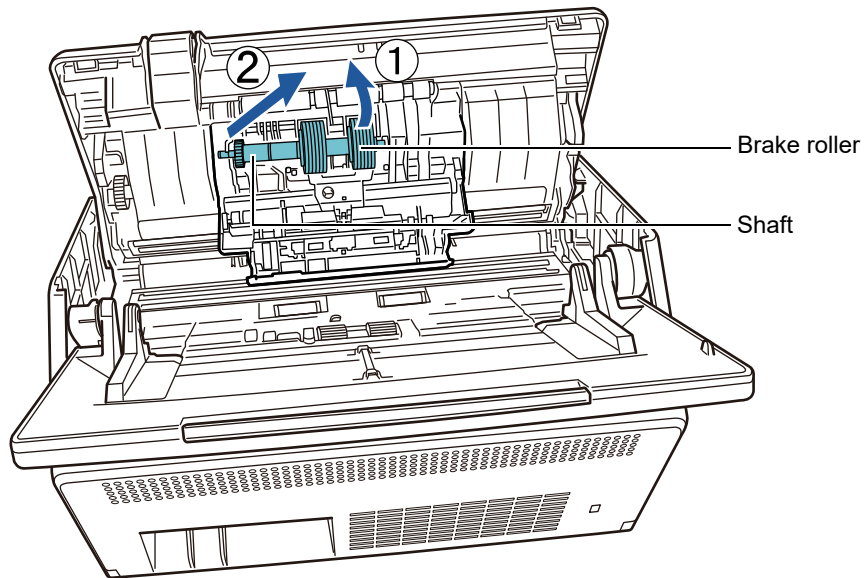

3. Remove the brake roller from its shaft.

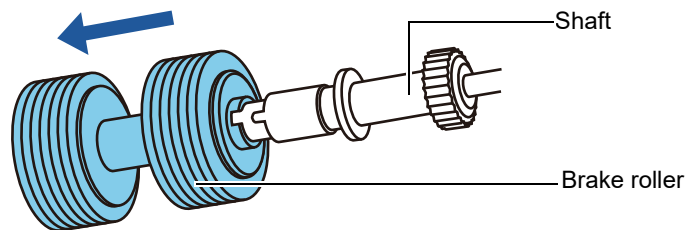

4. Attach a new brake roller on the shaft.
Insert the protrusion on the shaft into the slot.

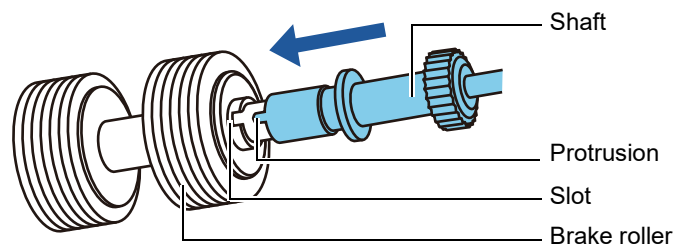

5. Install the brake roller with the shaft on the scanner.
Fit the left end of the shaft in the slot, then install the rest of the shaft in place.

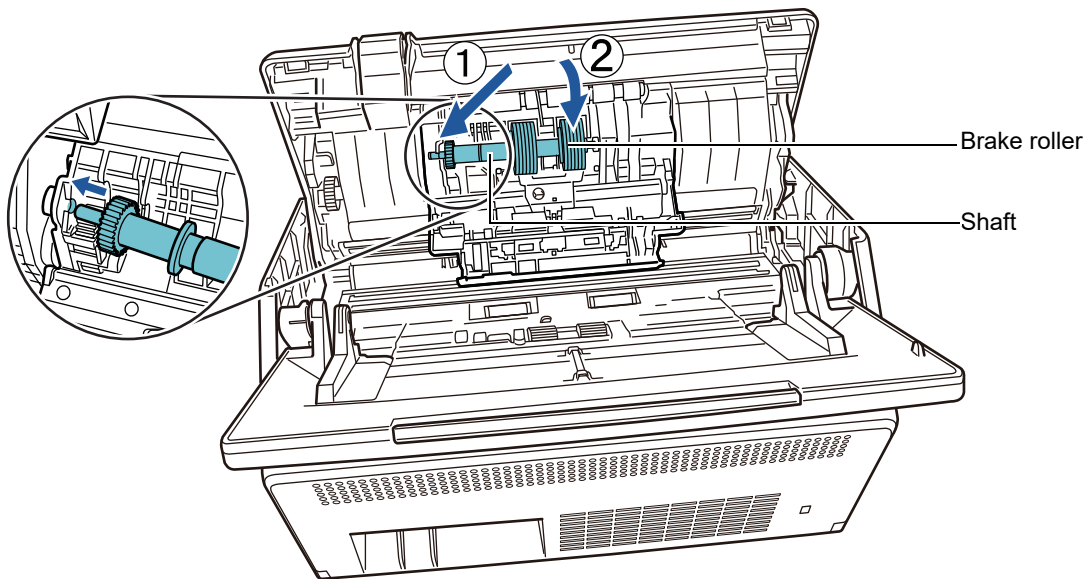

6. Close the cover of the brake roller.

ATTENTION

Make sure that the shaft is attached properly. If it is not correctly attached, document jams and other feeding errors may occur.

6. Replace the pick roller.

1. Open the sheet guide.
Slide the side guides all the way, and pull the sheet guide open from the dip.

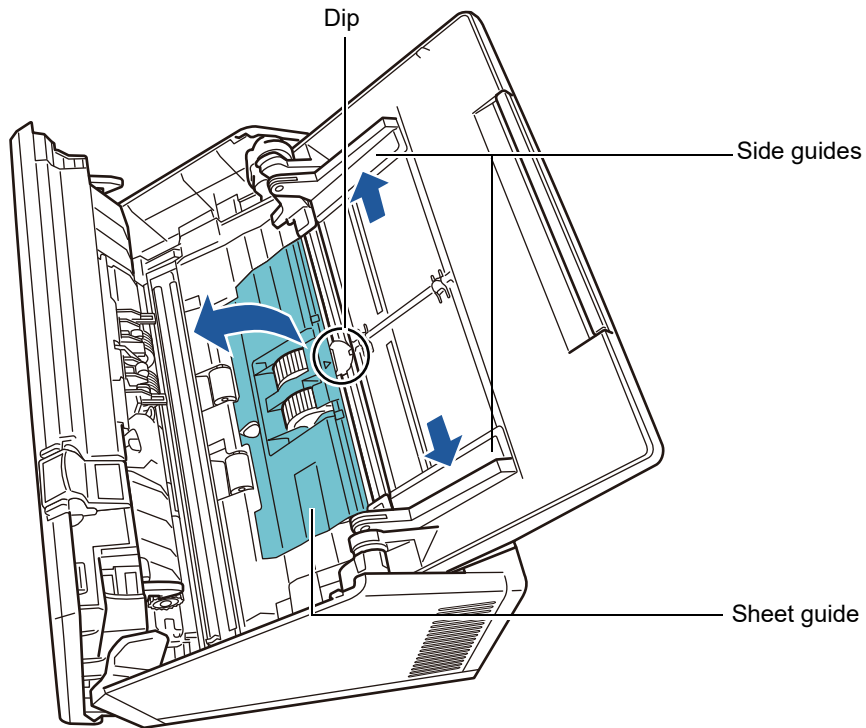

2. Rotate the lock release tab on the shaft in the direction of the arrow.

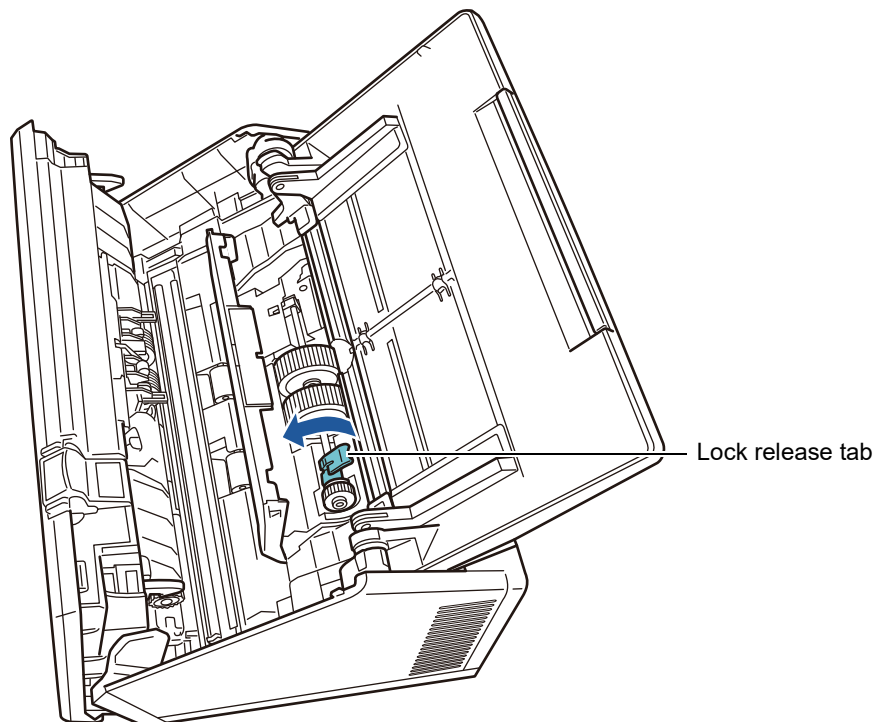

3. Remove the pick roller.

Slightly lift the Lock release tab of the shaft (by approximately 5 mm), slide the shaft to the direction of the arrow below, and lift it up all the way.

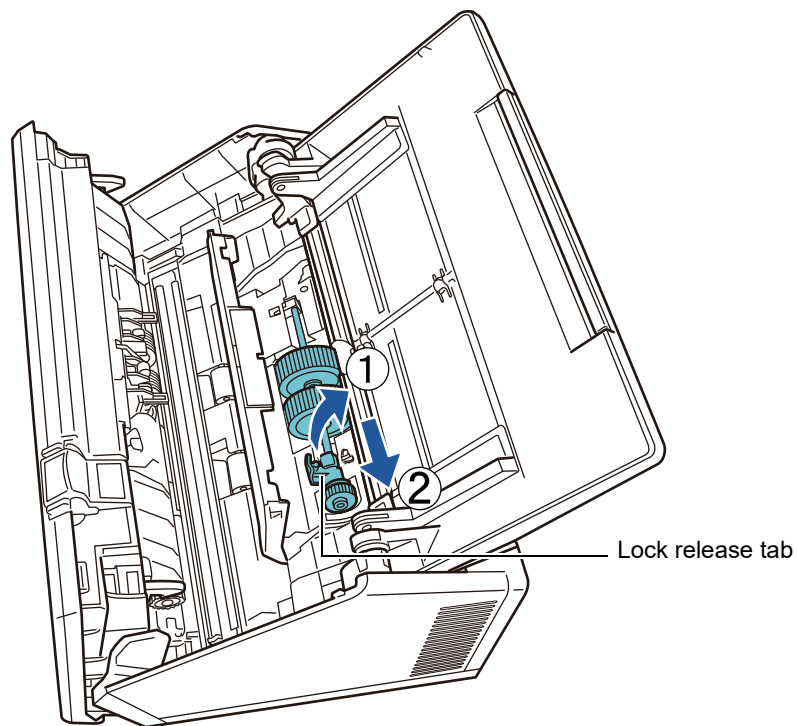

ATTENTION

Be careful not to touch the gear near the lock release tab on the shaft as it contains grease.

4. Install a new pick roller on the scanner.
Insert the left end of the shaft into the slot of the scanner, and lower the other end gradually.

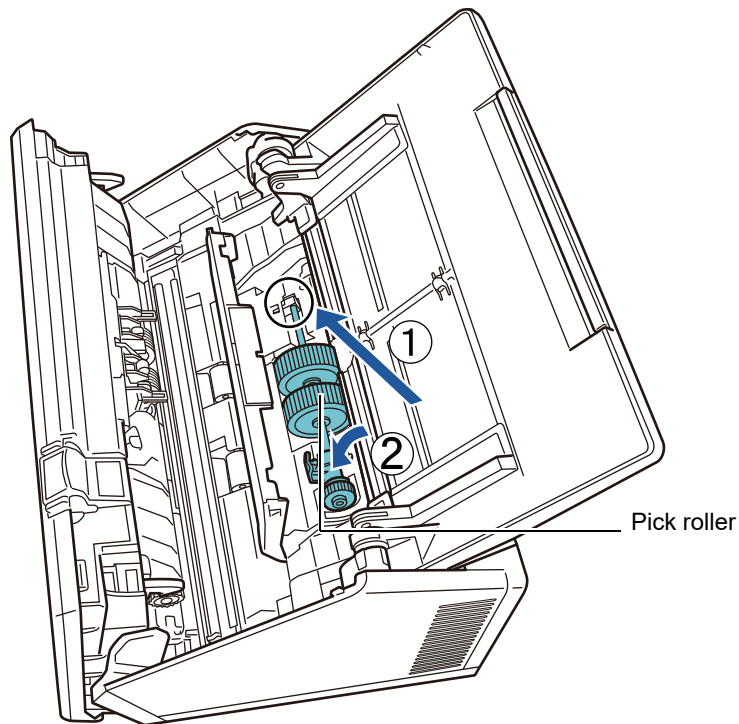

5. Rotate the lock release tab on the shaft in the direction of the arrow.

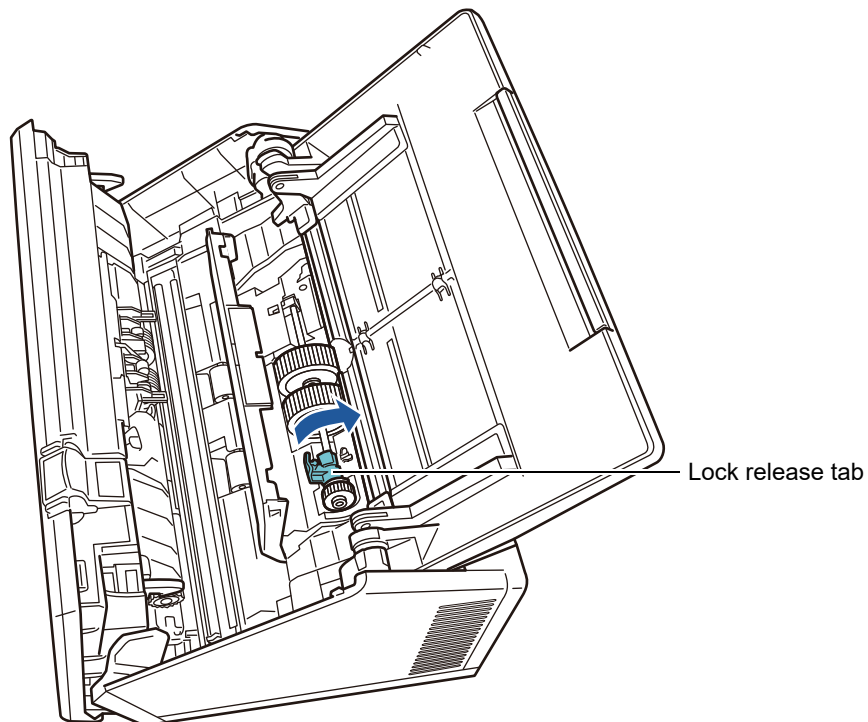

ATTENTION

Make sure that the pick roller is installed properly. Otherwise, paper jams or other feeding errors may occur.

6. Close the sheet guide.
Make sure that both ends of the sheet guide are locked firmly.

7. Close the LCD cover.

⇒ You should hear a click.



Be careful that the LCD cover does not shut on your fingers.

8. Connect the power cable, and turn on the scanner.

For details, refer to ["2.1 Turning the Power On/Off" \(page 49\)](#).

9. Reset the Roller Set usage counter.

The usage counter is reset by an administrator.

For details, refer to ["Resetting the Usage Counter" \(page 160\)](#).

6.5.4 Purchasing a Carrier Sheet

As a guideline, it is recommended to replace the Carrier Sheet every 500 scans. However, replace the carrier sheet when it becomes scratched or dirty.

The part name and the part number of a separately sold Carrier Sheet are as follows:

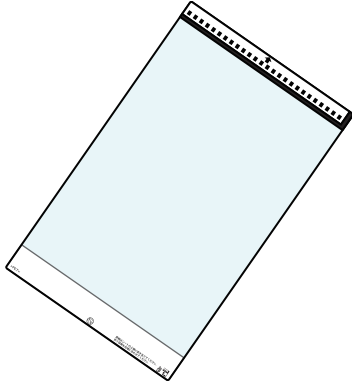
| Part Name | Part No. | No. of Items |
|---|--------------|--------------|
| Carrier Sheet  | PA03360-0013 | 5 |

To obtain a Carrier Sheet, contact your FUJITSU dealer or an authorized FUJITSU scanner service provider. For more details, refer to the following web page:
<https://www.fujitsu.com/global/about/resources/shop/computing/peripheral/scanners/index.html>

6.6 Performing a Scan Test Touch Panel

After scanner cleaning or replacement of consumable parts, perform a scan test.

■ Regular User

1. On the [Main Menu] or [Job Menu] window, press the [Maintenance] button.

HINT

The [Maintenance] button on the [Job Menu] window can be shown by pressing .

⇒ The [Maintenance] window appears.

2. Press the [Scan Test] button.

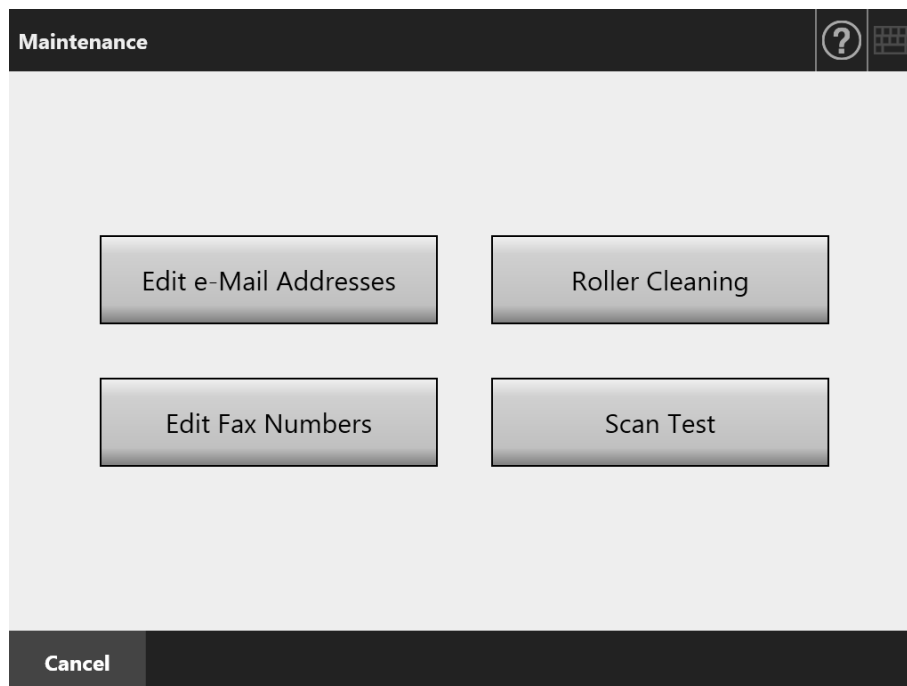

⇒ The [Scan Test] window appears.

3. Load the document into the ADF paper chute for the scan test.

4. Press the [Scan] button.

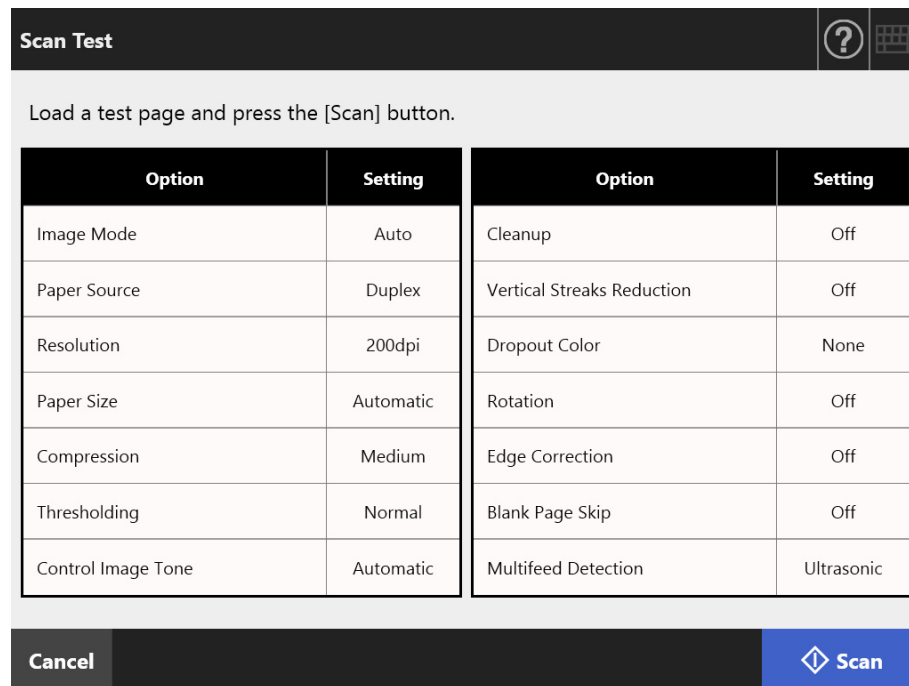

⇒ The scan test starts.

⇒ When the scan test has completed, the [Scan Viewer] window appears.

If the scanner fails to scan correctly, an error message is displayed. Deal with errors as required.

5. Check the scanned data.

For more details about [Scan Viewer], refer to the following:

["5.10 Editing the Scanned Data in the Scan Viewer" \(page 309\)](#)

6. Press the [OK] button.

⇒ The [Maintenance] window is shown again.

■ Administrator

1. On the administrator window, select **[Scan Test]** under **[Device Test]**.
⇒ The **[Scan Test]** window appears.
2. Press the **[Start]** button.
3. Load the document into the **ADF paper chute** for the scan test.
4. Press the **[Scan]** button.

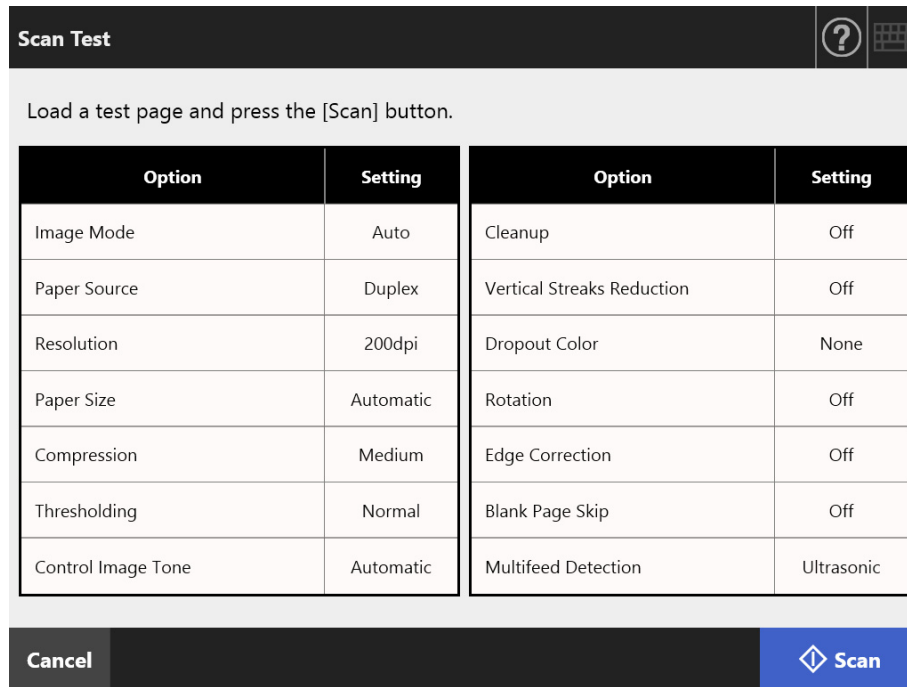

- ⇒ The scan test starts.
- ⇒ When the scan test has completed, the **[Scan Viewer]** window appears.
If the scanner fails to scan correctly, an error message is displayed. Deal with errors as required.
5. **Check the scanned data.**
For more details about **[Scan Viewer]**, refer to the following:
["5.10 Editing the Scanned Data in the Scan Viewer" \(page 309\)](#)
 6. **Press the [OK] button.**
⇒ This returns you to the **[Admin Menu]** window.

6.7 Calibrating the Touch Panel Touch Panel

This should be done when the touch panel responses seem out of alignment with the positions of objects on the screen.

1. On the administrator window, select [Calibrate Screen] under [Device Test].

⇒ The [Calibrate Screen] window appears.

2. Press the [Start] button.

⇒ A red "+" (adjustment mark) appears.

3. Touch the "+" with your fingertip.

After being touched, the "+" will move to the next



Please touch the point in the screen.
[Esc]:Cancel [Arrow Keys]:Move point

⇒ Follow the instructions in the displayed window.

ATTENTION

The [Calibrate Screen] process takes about 40 seconds.

Chapter 7

Troubleshooting

Admin

User

This chapter provides information on dealing with scanner operation problems such as paper jams, points to check before contacting your FUJITSU scanner dealer, and help on how to check scanner labels.

| | |
|---|------------|
| 7.1 Removing Jammed Documents..... | 361 |
| 7.2 Network Connection Troubleshooting..... | 364 |
| 7.3 Other Troubleshooting | 379 |
| 7.4 Points to Check before Contacting Your FUJITSU Scanner Dealer..... | 388 |
| 7.5 Checking the Scanner Labels..... | 391 |
| 7.6 Pre-Maintenance Preparations | 392 |

7.1 Removing Jammed Documents

If a document jam occurs, follow the procedure below to remove the jammed documents.



- Do not forcibly pull out jammed documents. Make sure to open the LCD cover before removing the documents.
- Take care not to snag sharp-edged parts when removing jammed documents. Such parts may cause injury.
- When removing jammed documents, take care with dangling objects such as neckties, necklaces and hair, as they may easily become entangled in the scanner.
- The surfaces of the glass can become hot when the scanner is used. Take care not burn your hands.

1. Remove all documents from the ADF paper chute.
2. Pull the cover release catch toward you, place your hands at both sides of the LCD cover, and open the LCD cover.

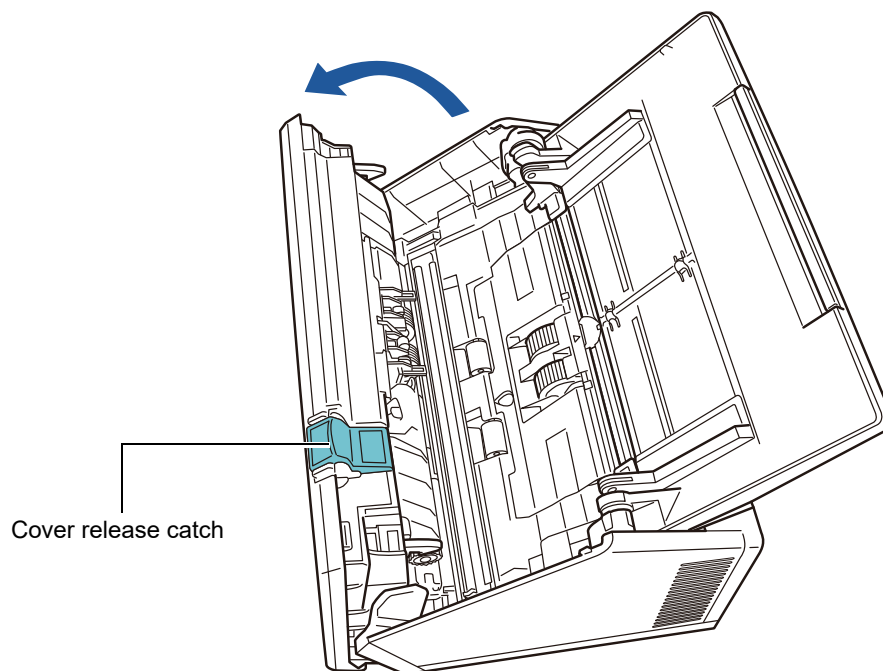

Be careful that the LCD cover does not shut on your fingers.

3. Remove the jammed document.

ATTENTION

- Objects such as staples and paper clips can cause document jams.
- Take care not to damage the glass or the sheet guides when removing stapled or paper-clipped documents.

4. Holding both sides of the LCD cover, close the LCD cover.

ATTENTION

- Be careful that the LCD cover does not shut on your fingers.
- Confirm that the LCD cover is completely closed. If not completely closed, document jams and feeding errors may occur.
- When closing the LCD cover, do not slam it shut by pushing the touch panel as this may damage it.
- To continue scanning, check which page you want to resume from, and load the document in the ADF paper chute again.

⇒ You should hear a click.

HINT

- Although no error message is displayed, document pages may remain in the ADF even after scanning is completed or canceled. Follow the procedure from [Step 1](#) to [Step 4](#) to remove any such pages from the ADF.
- If document pages become blocked while scanning, check the scanned data. Document pages which could not be scanned correctly may be shown in the [Scan Viewer] window. In this case, delete all pages not correctly scanned using  in the scan viewer details window. For more details about the scan viewer details window, refer to "[5.10.3 Editing Scanned Data on the Scan Viewer Details Window](#)" (page 312).

If document jams or multifeed errors occur frequently, try the following procedures.

1. Align the edges of the document sheets.

2. Fan the documents.

1. Lightly grip the ends of the document stack in both hands, and fan two or three times.

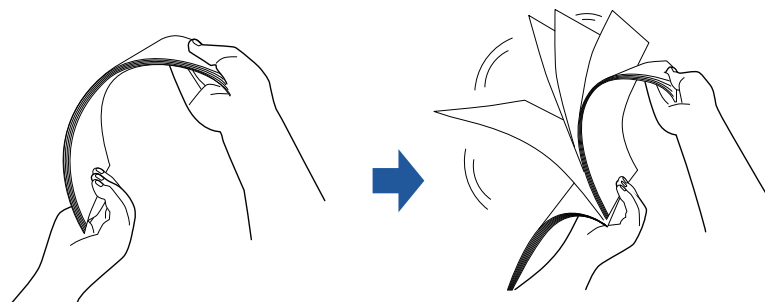

2. Rotate the documents 90 degrees, and fan again.

3. Align the edges of the document sheets to be loaded, and slightly skew the leading edge of the document.

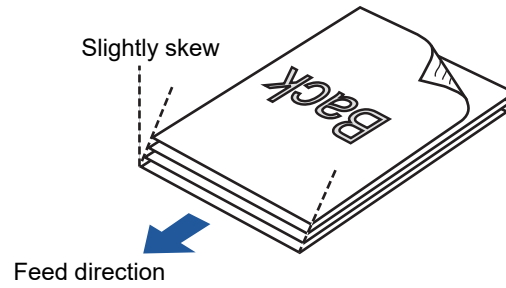

ATTENTION

Scanning the document sheets whose edges are not aligned might cause paper jams or damage to the document.

3. Load the documents into the ADF paper chute, as shown in the following diagram.

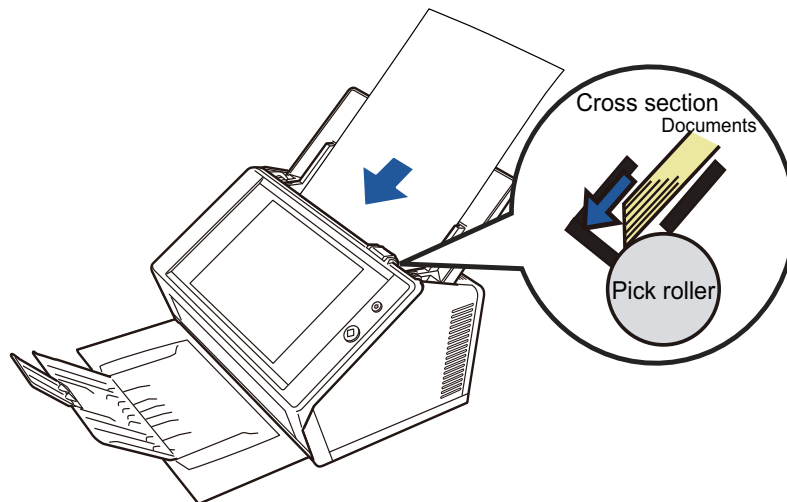

7.2 Network Connection Troubleshooting

If a network connection is not possible, first check the scanner status and system settings. The following section provides information about general troubles that may occur when connecting to a network.

If the cause of the problem is unknown or the problem persists, check the items in ["7.4 Points to Check before Contacting Your FUJITSU Scanner Dealer" \(page 388\)](#) and contact your FUJITSU scanner dealer or an authorized FUJITSU scanner service provider.

7.2.1 Basic Network Operation Tests

After the network has been setup, perform the following network operation tests on the administrator window.

- Checking basic network operation with a Ping test
- Checking the network operating status
- Checking the NTP server settings by synchronizing the system time (if using an NTP server)
- Checking the mail server by sending a test mail (if scanned data is to be sent as an e-mail, by fax, or when requesting alert notifications by e-mail)

■ Checking Basic Network Operation with a Ping Test

Check the network connection status of the following computers and servers associated with the network.

For details about the checking procedure, refer to ["4.8.1 Checking the Network Connection with a Ping Test" \(page 108\)](#).

- Computer with Admin Tool installed
- Computer with Central Admin Console installed
- Computer with Central Admin Server software installed
- Computer with User Editor installed
- DNS server
- WINS server
- NTP server
- LDAP server
- SMTP server
- File server
- FTP server
- Print server
- SharePoint server
- Domain controller
- Proxy server
- SNMP manager

ATTENTION

Depending on the server setting, there may be no response from a Ping test.

When checking the network connection status by a Ping test, the following results are possible.

Follow each action described below.

The four lines below are shown as a response from the ping test.

IPv4 address:

Reply from (destination IPv4 address): bytes=32 time<(time)ms

TTL=(TTL value)

IPv6 address:

Reply from (destination IPv6 address): time<(time)ms

■ Example of a response

IPv4 address:

Reply from XXX.XXX.XXX.XXX: bytes=32 time<1ms TTL=128

Reply from XXX.XXX.XXX.XXX: bytes=32 time<1ms TTL=128

Reply from XXX.XXX.XXX.XXX: bytes=32 time<1ms TTL=128

Reply from XXX.XXX.XXX.XXX: bytes=32 time<1ms TTL=128

IPv6 address:

Reply from XXXX:XXXX:XXXX:XXXX:XXXX:XXXX:XXXX:XXXX: time<1ms

Reply from XXXX:XXXX:XXXX:XXXX:XXXX:XXXX:XXXX:XXXX: time<1ms

Reply from XXXX:XXXX:XXXX:XXXX:XXXX:XXXX:XXXX:XXXX: time<1ms

Reply from XXXX:XXXX:XXXX:XXXX:XXXX:XXXX:XXXX:XXXX: time<1ms

■ Details

The response from the ping destination address is normal.

"Ping statistics" shows

"Lost = 4 (100% loss)".

■ Details

- There is no response from the Ping target.
- There may be problems in the hardware transmission path. For example, the LAN cable may have become disconnected during the ping test.

■ Action

- The specified Ping target might not be correct. Check that the Ping target IP address, host name or FQDN is correct.
If an IP address that does not exist is specified, the following applies:
 - For an IPv4 address:
If the IP address that you specified belongs to the same segment as the scanner, the value is shown as "Lost = 0 (0% loss)".
If the IP address that you specified belongs to a different segment from the scanner, the value is shown as "Lost = 4 (100% loss)".
 - For an IPv6 address:
The value is shown as "Lost = 4 (100% loss)".
- The network transmission mode may differ from the connection target. In ["4.7.8 Configuring Network Advanced Settings" \(P.107\)](#), change [Link Speed/Duplex Mode] from "Auto-Negotiation" to a fixed mode.
- If the Ping target is correct and the network transmission method is appropriate, refer to ["Failure to Connect to a Server Using Its IP Address" \(P.370\)](#) for further solutions.
- Check the status of the LAN cable or replace the LAN cable and try again.
- If a HUB device is used for connection, change the connection port of the LAN cable and try again.

"Ping statistics" shows "Lost = N (1 to 99% loss)".

■ Details

- Communication with the Ping target is not stable.
- There may be problems in the hardware transmission path. For example, the LAN cable may have become disconnected during the ping test.

■ Action

- Check the status of the LAN cable or replace the LAN cable and try again.
- When connected to a HUB, change the port to which the LAN cable is connected and try again.
- The network transmission mode may differ from the connection target. In ["4.7.8 Configuring Network Advanced Settings" \(P.107\)](#), change [Link Speed/Duplex Mode] from "Auto-Negotiation" to a fixed mode.

"Ping request could not find host xxxxxxxx. Please check the name and try again."

■ Details

The name-resolution or address-resolution for the device specified as the Ping target may have failed.

■ Action

- Check that the Ping target host name or FQDN is correct.
- Check that the DNS server or WINS server settings are correct.
- If the Ping target host name or FQDN is correct, refer to ["Failure to Connect to a Server Using Its Host Name or FQDN" \(P.372\)](#) for further solutions.

■ Checking the Network Operating Status

Check the network status on the [Network Status] window.

For details about the checking procedure, refer to ["4.8.2 Checking the Network Operating Status" \(page 109\)](#) or ["G.3.5 Checking the Network Operating Status" \(page 462\)](#).

Follow each action described below.

The information shown is all valid.

■ **Action**

None

Network connection is working properly.

■ **Action**

None

The information shown is valid, but the network connection does not work normally for the ping test.

■ **Action**

In ["4.7.8 Configuring Network Advanced Settings" \(P.107\)](#), change [Link Speed/Duplex Mode] from "Auto-Negotiation" to a fixed mode.

If the problem persists, refer to ["Failure to Connect to a Server Using Its IP Address" \(P.370\)](#) for further solutions.

■ Checking the NTP Server Settings by Synchronizing the System Time

On the [NTP Server] window, press the [Sync Time] button to check if the system time can be synchronized.

After pressing the [Sync Time] button, follow each action described below according to the message that is shown.

The messages and their corresponding actions are as follows.

System time has been successfully synchronized.

■ Action

None

System time synchronization failed.

■ Action

Try the following:

- Check the specified NTP server IP address, host name, or FQDN for mistakes, and correct them.
- Communication between the scanner and the NTP server is not possible due to a problem with the network route. Check the network settings.
- The NTP server may be busy. Wait a short time before trying again to synchronize the system time. If that does not work, the specified server may not be an NTP server, so try a different NTP server.
- It attempted to acquire the date and time from a higher level NTP server, but failed. Try a different NTP server or have the network administrator investigate.
- Check that the time is correct. If the time is incorrect, adjust the date/time, and try again.
- Refer to "[4.4.4 Setting the Date/Time](#)" (P.82), adjust the date/time, and try again.

■ Checking the Mail Server by Sending a Test Mail

On the [Alert Notification] window, press the [Test] button to check if an e-mail can be sent to the specified destination.

After pressing the [Test] button, follow each action described below according to the message that is shown.

The messages and their corresponding actions are as follows.

Sending...

■ Action

If no error message appears and the [Sending] indicator disappears, the test mail was sent successfully to the mail server.

Check that the alert notification e-mail has arrived at the specified destination. If the alert notification e-mail has not arrived at the expected destination, check that the part of the e-mail address before the "@" has been entered correctly.

Test e-mail could not be sent.

■ Action

- Check that the computer connected to the e-mail server is running properly.
- Check if an e-mail can be sent to the address from other computers in the network.
- Ping the SMTP server to check that it and its network connection are working properly.
- If the SMTP server does not respond to the ping test, check whether the system network is operating normally by pinging a computer other than the SMTP server.
 - If it is only the scanner's network connection that does not work, refer to ["Failure to Connect to a Server Using Its IP Address" \(P.370\)](#) for further solutions.
 - If the problem seems to be with the SMTP server's network connection, request the network administrator to check that the SMTP server and its network connection are functioning normally.
- Check that the same port number has been correctly set for the scanner to SMTP server connection in ["4.11.1 Setting the SMTP Server" \(page 125\)](#).

7.2.2 Other Network Connection Troubleshooting

There are many reasons why a network connection may not be possible.

The following section provides information about general troubles that may occur when connecting to a network.

If the cause of the problem is unknown or the problem persists, check the items in ["7.4 Points to Check before Contacting Your FUJITSU Scanner Dealer" \(page 388\)](#) and contact your FUJITSU scanner dealer or an authorized FUJITSU scanner service provider.

■ Failure to Connect to a Server Using Its IP Address

If a server cannot be connected to by using its IP address, and does not respond to a ping test, try the following steps:

Connection error between a server and the scanner, or problem with the LAN cable.

■ Action

Check that the LAN cable has been attached to both the scanner and server correctly.

If the server is connected using a LAN cable (straight type), Auto MDI/MDI-X (automatic selection) is not supported. A LAN cable (crossover type), switch, or router is required between the scanner and server.

If this is not the case, the LAN cable may be faulty. Find a LAN cable that functions normally and try again.

The settings you have configured on the [IP Address] window, or the [IPv4 Address] window/[IPv6 Address] window when the IPv6 function is enabled, are invalid.

■ Action

Refer to ["4.7.1 Giving the Scanner an IP Address/DHCP" \(P.99\)](#) or refer to ["G.3.1 Giving the Scanner an IPv4 Address" \(P.457\)](#)/["G.3.2 Giving the Scanner an IPv6 Address" \(P.458\)](#) if the IPv6 function is enabled and then check the settings that you have configured such as the IP address and the subnet mask (subnet prefix length for an IPv6 address) are configured correctly.

When DHCP is used, the DHCP server does not operate normally, or there is a problem with the DHCP server settings.

■ Action

If you use DHCP, refer to ["4.8.2 Checking the Network Operating Status" \(P.109\)](#) or ["G.3.5 Checking the Network Operating Status" \(P.462\)](#) and check that the IP address, subnet mask (subnet prefix length for an IPv6 address), and default gateway for the scanner are all set correctly.

If these settings are not correct, the DHCP server may not operate normally, or the DHCP server may not assign valid IP addresses because of restricted number of leases or MAC address validation.

Check the DHCP server connection status and the details of the server settings.

Another host or communication device is connected using the same IP address as the scanner.

■ Action

If the same IP address has already been used by another host or communication device, then even if the other device has been given a different IP address, the server may not recognize the scanner's "duplicate" IP address until it is rebooted. Restart the server.

If a duplicate IP address connection from another host or communication device exists on a LAN, it will be unusable.

If a duplicate IP address connection from another host or communication device exists, pull out its LAN cable and restart the server.

Access is denied due to the establishment of a firewall between the server and the scanner.

■ Action

If a firewall has been established between the server and the scanner, check that it has not been set to deny access to the network.

The network [Link Speed/Duplex Mode] for the scanner and server are different, or "Auto-Negotiation" is not supported by the server.

■ Action

In the Network Advanced Settings for the scanner (described in "[4.7.8 Configuring Network Advanced Settings](#)" (P.107)), [Link Speed/Duplex Mode] is set to the default "Auto-Negotiation". If "Auto-Negotiation" does not operate correctly, change [Link Speed/Duplex Mode] to a fixed mode on the scanner and server, and try again.

■ Failure to Connect to a Server Using Its Host Name or FQDN

If a server cannot be connected to by using its host name or FQDN, and does not respond to a ping test, try the following steps:

Same as in "Failure to Connect to a Server Using Its IP Address" (P.370).

■ Action

Check if a network connection is possible by trying the same solution for "Failure to Connect to a Server Using Its IP Address" (P.370).

The scanner's DNS server or WINS server settings are invalid.

■ Action

Check that the DNS and WINS server settings are correct.

The DNS server or WINS server is not functioning normally, or there is an error with the DNS or WINS server network connection.

■ Action

Ping the DNS and WINS servers to check they are functioning normally.
If the DNS or WINS server is not functioning, request the network administrator to check its status.

■ Failure to Add the Scanner as a Domain Member, or Failure to Login to a Domain

When the scanner is specified as a domain member, an authorization error occurs and the scanner cannot be added.

■ Action

- When specifying the scanner as a domain member, perform authentication as a user with domain administrator rights, or as a user with the rights to add a computer to the domain. If you do not know the user name or the password, contact the system administrator of the domain.
- Check that the LAN Manager authentication level is set to the same level as the server in the domain.

After a user with administrator rights registers a scanner to a domain, authentication is attempted by a domain user without administrator rights in order to change the scanner name, but login fails.

■ Action

When registering a scanner to a domain with administrator rights, be sure to perform authentication as a user with administrator rights again the next time.

■ Failure to Add a Network Printer

If adding a network printer to/from the scanner is not possible, try the following steps. Also, read the printer manual beforehand that provides information about how to set printer settings and how to add a network printer.

The Windows 10 printer driver has not been installed on the print server.

■ Action

Install the Windows 10 printer driver on the print server.

Check that the Windows 10 printer driver has been correctly installed on the print server. For more details, refer to ["4.14 Setting the Network Printers" \(page 146\)](#).

Network printer shared name has been changed.

■ Action

Check the shared name on the print server.

The specified network printer path is invalid.

■ Action

Check that the specified network printer path is correct.

The network printer shared name contains the vertical bar (|).

■ Action

Create a network printer on the print server with a shared name that does not contain the vertical bar (|), and register the network printer again.

The LAN Manager authentication level is not set to the same level as the server for the network printer.

■ Action

Set the LAN Manager authentication level to the same level as the server for the network printer.

■ Failure to Print on a Network Printer

If printing on a network printer which has been set in the scanner is not possible, try the following steps. Also, read the printer manual beforehand that provides information about how to set printer settings and how to add a network printer.

Same as in "[Failure to Connect to a Server Using Its IP Address](#)" (P.370).

■ Action

Check if a network connection is possible by trying the same solution for "[Failure to Connect to a Server Using Its IP Address](#)" (P.370).

Printer is not usable, due to an out of paper error, paper jam, or similar problem.

■ Action

Check whether or not the printer is ready for printing, deal with the cause of the error, and try again.

Not authorized to print on network printer.

■ Action

Contact the administrator to check if printing is allowed on the network printer.

Printing is impossible due to a printer or spooler error.

■ Action

Try the following:

- Check that printing is possible from the print server application.
- Check that the print server spooling is operating normally.

■ Failure to Add a Network Folder

If adding a network folder from the scanner is not possible, try the following steps.

Network folder shared name has been changed.

■ Action

Check the shared name on the server side.

The specified network folder path is invalid.

■ Action

Check that the specified network folder path is correct.

The LAN Manager authentication level is not set to the same level as the server for the network folder.

■ Action

Set the LAN Manager authentication level to the same level as the server for the network folder.

■ Failure to Save to a Network Folder

When scanned data is saved to an FTP server folder or a network folder, the [Network is busy. Try again later.] message appears and saving is not possible.

■ Action

The network folder may be temporarily unavailable. Wait for a while (approximately three minutes) and try again.

This error may also occur if an open port number of the FTP server is momentarily lost. Wait for a while (approximately three minutes) and try again, or change the FTP setting to passive mode.

When an FTP proxy is used for saving a large amount of data to an FTP server folder, an error occurs and saving is not possible.

■ Action

When DeleGate is used for the proxy server, if the data forwarding time takes longer than ten minutes, an error may occur in the saving process. In this case, saving may be made possible by adding "TIMEOUT io=0" to the DeleGate settings.

When saving data via FTP/FTPS is attempted repeatedly, the "Error: network folder access was refused." message may appear.

■ Action

This error may occur in the case of FTP server open port exhaustion. Wait a while (approximately three minutes) and try again.

7.2.3 Failure to Access the Scanner Using Internet Explorer, the Admin Tool, the Central Admin Server, or the User Editor

If access is not possible when attempting to connect to the scanner using Internet Explorer, the Admin Tool, or the Central Admin Server, or the User Editor, try the following steps:

Same as in "Failure to Connect to a Server Using Its IP Address" (P.370).

■ **Action**

Check if a network connection is possible by trying the same solution for "Failure to Connect to a Server Using Its IP Address" (P.370).

The DNS server or WINS server is not functioning normally, or the scanner name has not been registered in the DNS or WINS server.

■ **Action**

Check the connectivity of the specified IP address.

If it is possible to connect the scanner using the Admin Tool with a specified IP address, specify the scanner's IP address in the DNS or WINS server.

In the administrator settings of the scanner, check the DNS or WINS server settings for Internet Explorer and the Admin Tool.

A misconfigured firewall between the scanner and the computer with Internet Explorer, the Admin Tool, or User Editor installed is denying the computer access to the scanner via HTTP/HTTPS protocols.

■ **Action**

If there is a firewall between the computer installed with Internet Explorer, the Admin Tool, or the User Editor and the scanner, check that its settings are not preventing access.

The URL of the target scanner is not registered as a trusted site.

■ **Action**

Set the scanner URL as a trusted site for Internet Explorer.

1. In Internet Explorer, select the [Tools] menu → [Internet Options].
2. On the [Security] tab, select [Trusted sites] and click the [Sites] button.
3. Enter the URL of the scanner in the [Add this website to the zone] field, and click the [Add] button.

In Internet Explorer, the security level for the target zone is set to [High] on the [Security] tab in the [Tools] menu - [Internet Options]. For [Custom Level], [Prompt] or [Disable] is set for [Active scripting] under [Scripting] in the [Settings] area.

■ **Action**

When connecting using the scanner name, the connection will be an intranet connection. If the URL includes an IP address, the scanner will be connected using the Internet Zone.

Try the following settings for the corresponding zone.

1. In Internet Explorer, select the [Tools] menu → [Internet Options].
2. Enable active scripting in either of the following ways.
 - On the [Security] tab, click the [Default level] button to set [Security level for this zone] to [Medium].
 - On the [Security] tab, click the [Custom level] button to set to [Enable] for [Active scripting] under [Scripting] in the [Settings] area.
3. If connecting via the Internet zone, on the [Privacy] tab, set the level to below [Medium High].
4. Delete temporary internet files.
For details about setting values, refer to Help for Internet Explorer.

The scanner is in standby mode.

■ **Action**

Press the power button to start the scanner.

A proxy server is being used.

■ **Action**

Set the proxy server to not be used.

1. In Internet Explorer, select the [Tools] menu → [Internet Options].
2. Press the [LAN settings] button on the [Connections] tab.
3. Clear the [Use a proxy server for your LAN (These settings will not apply to dial-up or VPN connection).] check box.

There is an error with the connection protocol setting.

■ **Action (Scanner)**

Check if SSL is enabled on the [Admin Connection] window.

For details, refer to "[4.9.1 Setting the Admin Connection](#)" (page 110).

■ Action (Computer with Internet Explorer, the Admin Tool, or the User Editor installed)

1. In Internet Explorer, select the [Tools] menu → [Internet Options].
2. Press the [Advanced] tab.
3. Under [Security] in the [Settings] section, select the check boxes for the following items. The check boxes to be selected should be the same as the check boxes that you selected in step 2 in ["4.9.1 Setting the Admin Connection" \(page 110\)](#).
 - Use SSL 3.0
 - Use TLS 1.0
 - Use TLS 1.1
 - Use TLS 1.2

There is an error with the port number setting.

■ Action

- Check if SSL is enabled on the [Admin Connection] window.
For details, refer to ["4.9.1 Setting the Admin Connection" \(page 110\)](#).

7.3 Other Troubleshooting

This section describes problems that may occur during scanning and gives information on how to deal with them. Before requesting repair, check the following list of common problems.

If the problem still cannot be solved after consulting the troubleshooting suggestions, check the points in ["7.4 Points to Check before Contacting Your FUJITSU Scanner Dealer" \(page 388\)](#) and then contact your FUJITSU scanner dealer or an authorized FUJITSU scanner service provider.

The possible problems are as follows:

Problem List

- **Scanner cannot be turned on**
 - [" Scanner cannot be turned on." \(page 380\)](#)
- **Scanner does not start up**
 - [" The "The last attempt to restart ..." message is shown on the window and the scanner does not start up." \(page 380\)](#)
 - [" Scanner does not resume from standby mode." \(page 380\)](#)
 - [" A "Scanner initialization has failed." message appears and the scanner does not start up." \(page 381\)](#)
- **I want to reset the scanner to factory defaults**
 - [" I want to reset the scanner settings to their defaults." \(page 381\)](#)
 - [" I forgot the administrator login password." \(page 381\)](#)
- **Data cannot be scanned properly**
 - [" Scanning does not start." \(page 381\)](#)
 - [" Even after pressing the Scan button, scanning does not start." \(page 382\)](#)
 - [" Multifeed errors occur frequently." \(page 382\)](#)
 - [" Document is not fed into the scanner \(pick error occurs frequently or document feed stops halfway\)." \(page 383\)](#)
 - [" When scanning with a Carrier Sheet, the \[Paper jam has occurred. Remove the documents from the ADF and try again.\] message appears and an error occurs." \(page 384\)](#)
- **Scanned data is inappropriate**
 - [" Scanned data is elongated." \(page 384\)](#)
 - [" Shadow on the leading edge of the scanned data." \(page 384\)](#)
 - [" Vertical line on the scanned data." \(page 384\)](#)
 - [" Scanned data appears skewed or distorted." \(page 385\)](#)
 - [" Quality of scanned data is poor." \(page 385\)](#)
 - [" Scanned data is partially cut off." \(page 385\)](#)
 - [" Scanned data is skewed." \(page 385\)](#)
- **Cannot login**
 - [" Cannot login with administrator password." \(page 386\)](#)
 - [" The \[Login\] window is not displayed when connecting via the network." \(page 386\)](#)
- **Operation does not work**
 - [" Input field entry entered via the on-screen keyboard does not appear on the window." \(page 386\)](#)
 - [" Saving is not possible after pressing \[Save\] on the \[File Download\] dialog box." \(page 387\)](#)

- " The status window with the message "Printing scan data on xxx" remains or is slow." (page 387)
- " An error occurs when installing an Admin Tool." (page 387)
- " When a fax is sent, the screen freezes on the scanning window." (page 387)

■ Scanner Cannot Be Turned On

Scanner cannot be turned on.

■ Check item

Has the power button been pressed?

■ Action

Press the power button.

■ Check item

Are the AC cable and AC adapter properly connected to the scanner?

■ Action

- Connect the AC cable and the AC adapter.
- Disconnect the AC cable from the scanner to turn off the scanner, and connect the AC cable again. After turning the power off, wait for at least 10 seconds before turning the power back on again.

If the problem persists even after taking the above mentioned actions, contact your FUJITSU scanner dealer or an authorized FUJITSU scanner service provider.

■ Scanner Does Not Start Up

The "The last attempt to restart ..." message is shown on the window and the scanner does not start up.

■ Check item

After turning the scanner on, was the power turned off immediately?

■ Action

- Press the power button.
- Disconnect the AC cable from the scanner to turn off the scanner, and connect the AC cable again. After turning the power off, wait for at least 10 seconds before turning the power back on again.

If the problem persists even after taking the above mentioned actions, contact your FUJITSU scanner dealer or an authorized FUJITSU scanner service provider.

Scanner does not resume from standby mode.

■ Check item

After turning the scanner off, was the power turned back on again immediately?

■ Action

Press the power button.

A "Scanner initialization has failed." message appears and the scanner does not start up.

■ **Check item**

Is the status the same after the scanner is turned off and then turned back on again?

■ **Action**

Disconnect the AC cable from the scanner to turn off the scanner, and connect the AC cable again. After turning the power off, wait for at least 10 seconds before turning the power back on again.

If the problem persists even after taking the above mentioned actions, contact your FUJITSU scanner dealer or an authorized FUJITSU scanner service provider.

■ **I Want to Reset the Scanner to Factory Defaults**

I want to reset the scanner settings to their defaults.

■ **Action**

Refer to "[Resetting to Factory Defaults](#)" (page 173), and reset the scanner.

I forgot the administrator login password.

■ **Action**

Contact your FUJITSU scanner dealer or an authorized FUJITSU scanner service provider.

■ **Data Cannot Be Scanned Properly**

Scanning does not start.

■ **Check item**

Has the document been loaded correctly into the ADF paper chute?

■ **Action**

Reload the documents into the ADF paper chute.

■ **Check item**

Is the LCD cover completely closed?

■ **Action**

Close the LCD cover completely.

■ Check item

Does the same problem occur after turning the scanner power off and back on again, and re-logging in?

■ Action

Disconnect the AC cable from the scanner to turn off the scanner, and connect the AC cable again. After turning the power off, wait for at least 10 seconds before turning the power back on again.

If the problem persists even after taking the above mentioned actions, contact your FUJITSU scanner dealer or an authorized FUJITSU scanner service provider.

Even after pressing the Scan button, scanning does not start.
■ Check item

Is the  button displayed on the touch panel?

■ Action

The Scan button can only be used on the following windows:

- [Send e-Mail] window
- [Send Fax] window
- [Print] window
- [Save] window
- [Scan Viewer] window
- [Scan Test] window
- [Message Screen]
- [Scan Count] window
- Confirmation window showing the number of scanned sheets
- [File Name] window

Multifeed errors occur frequently.
■ Check item

Do the documents satisfy the conditions given in "A.2 Paper Quality" (P.395)?

■ Action

Use documents which satisfy the conditions described in "A.2 Paper Quality" (P.395).

■ Check item

Has the document been loaded correctly into the ADF paper chute?

■ Action

Riffle and realign the document stack, then load it back into the ADF paper chute.

■ Check item

Is the document stack more than 5 mm thick?

■ Action

Remove sheets from the stack to reduce it to a thickness of 5 mm or less.

■ Check item**Is the brake roller or the pick roller dirty?****■ Action**

Clean the brake roller and the pick roller.

For more details, refer to "[6.3 Cleaning Inside the Scanner](#)" (P.339).

■ Check item**Is the brake roller or the pick roller worn out?****■ Action**

Replace the brake roller or the pick roller.

For more details, refer to "[6.5 Replacing Parts](#)" (P.346).

■ Check item**Is the scanner used at 2,000 m or higher altitudes?****■ Action**

Enable the [High Altitude Mode] in the [Multifeed Settings] window in the administrator settings.

For more details, refer to "[4.5.1 Setting the Multifeed Detection Method](#)" (page 86).

Document is not fed into the scanner (pick error occurs frequently or document feed stops halfway).

■ Check item**Do the documents satisfy the conditions given in "[A.2 Paper Quality](#)" (P.395)?****■ Action**Use documents which satisfy the conditions described in "[A.2 Paper Quality](#)" (P.395).

■ Check item**Is the brake roller or the pick roller dirty?****■ Action**

Clean the brake roller and the pick roller.

For more details, refer to "[6.3 Cleaning Inside the Scanner](#)" (P.339).

■ Check item**Is the brake roller or the pick roller worn out?****■ Action**

Replace the brake roller or the pick roller.

For more details, refer to "[6.5 Replacing Parts](#)" (P.346).

■ Check item**Is there any foreign matter in the document feed path?****■ Action**

Clean the document feed path.

When scanning with a Carrier Sheet, the [Paper jam has occurred. Remove the documents from the ADF and try again.] message appears and an error occurs.

■ **Check item**

When an error occurs while scanning with a Carrier Sheet, after the [Scanning with the carrier sheet failed. Make sure the document is fully inserted into the top of the carrier sheet and the folded edge is on the side marked with the thick line, then try again.] message appears, the [Paper jam has occurred. Remove the documents from the ADF and try again.] message appears, and scanning fails.

■ **Action**

Follow the instructions in the messages, and try again.

■ **Scanned Data Is Inappropriate**

Scanned data is elongated.

■ **Check item**

Are the feed rollers dirty?

■ **Action**

Clean the feed rollers.

For more details, refer to "[6.3 Cleaning Inside the Scanner](#)" (P.339).

Shadow on the leading edge of the scanned data.

■ **Check item**

Are the feed rollers dirty?

■ **Action**

Clean the feed rollers.

For more details, refer to "[6.3 Cleaning Inside the Scanner](#)" (P.339).

Vertical line on the scanned data.

■ **Check item**

Is the glass dirty?

■ **Action**

Follow the steps in "[Chapter 6 Scanner Care](#)" (P.335) to clean the glass.

Scanned data appears skewed or distorted.

- **Check item**
Has the document been loaded correctly?
- **Action**
Load the document correctly.

Quality of scanned data is poor.

- **Check item**
Is the glass dirty?
- **Action**
Clean the glass.

Scanned data is partially cut off.

- **Check item**
Depending on the paper color of the document, scanned data may be partially cut off because the paper boundary is not recognized correctly.
- **Action**
Before scanning, set the paper size to a standard one.

-
- **Check item**
Is the document loaded correctly?
 - **Action**
Load the document correctly.

Scanned data is skewed.

- **Check item**
Are the side guides aligned with the document width?
- **Action**
Align the side guides with the document width.
The brake roller or pick roller may also cause this problem. Refer to "Check item" and "Action" for "[Document is not fed into the scanner \(pick error occurs frequently or document feed stops halfway\).](#)" (page 383).

■ Cannot Login

Cannot login with administrator password.

■ Check item

Was the Caps Lock on when the password was entered?

■ Action

Turn off the Caps Lock and try logging in again.

■ Check item

Has the password been changed?

■ Action

The default password is "password".

After the password is changed, if the new password is lost or forgotten, login is not possible. If this happens, the same action that is taken when repairing the scanner is needed.

Contact your FUJITSU scanner dealer or an authorized FUJITSU scanner service provider.

The [Login] window is not displayed when connecting via the network.

■ Check item

Are the SSL settings correct?

■ Action

Close the window, correct the settings, and try connecting again.

■ Check item

Was the [Yes] button selected on the [Security Warning] dialog box when connecting with HTTPS?

■ Action

Close the window and try connecting again. Select the [Yes] button on the [Security Warning] dialog box when connecting.

■ Operation Does Not Work

Input field entry entered via the on-screen keyboard does not appear on the window.

■ Check item

Has the input field been selected?

■ Action

- Select the input field and try again.
- Press the [Cancel] button and try again.
- To use the touch panel, touch the input field directly and try again.

Saving is not possible after pressing [Save] on the [File Download] dialog box.**■ Check item**

Does the length of the [Save As] folder path (folder path plus file name) exceed 259 characters?

■ Action

Change the [Save As] folder to shorten the path length.

The status window with the message "Printing scan data on xxx" remains or is slow.**■ Check item**

Is there enough free space in the drive on which the spool folder for the print server exists?

■ Action

Make sure that there is enough space in the drive.

An error occurs when installing an Admin Tool.**■ Check item**

Is the language of the Admin Tool already installed different from that of the operating system?

■ Action

Uninstall the existing Admin Tool. Then, install the Admin Tool of the same language as that of the operating system.

When a fax is sent, the screen freezes on the scanning window.**■ Check item**

Was the Scan button pressed repeatedly during scanning?

Do not press the Scan button before scanning is completed.

■ Action

Disconnect the AC cable from the scanner to turn off the scanner, and connect the AC cable again. After turning the power off, wait for at least 10 seconds before turning the power back on again.

If the problem persists even after taking the above mentioned actions, contact your FUJITSU scanner dealer or an authorized FUJITSU scanner service provider.

7.4 Points to Check before Contacting Your FUJITSU Scanner Dealer

Before contacting your FUJITSU scanner dealer or an authorized FUJITSU scanner service provider, check the following points.

7.4.1 General Details

| Info | Findings |
|----------------------|--|
| Model | FUJITSU Image Scanner N7100E |
| Serial No. | Example: ***** For details, refer to "7.5 Checking the Scanner Labels" (page 391). |
| Production date | Year Month Example: 20xx-01 (January, 20xx) For details, refer to "7.5 Checking the Scanner Labels" (page 391). |
| Date of purchase | Year Month Day |
| System version | |
| Symptoms | |
| Frequency of trouble | |
| Total throughput | |

7.4.2 Error Status

■ Problem When Connecting to the Scanner via Computer

| Info | Findings |
|---------------------------|----------|
| OS (Windows) | |
| Internet Explorer version | |
| Admin Tool version | |
| Displayed error message | |

■ Document Feed Trouble

| Info | Findings |
|------------------------------|--------------------|
| Paper type | |
| Main purpose of use | |
| Last cleaned on | Year Month Day |
| Consumables last replaced on | Year Month Day |
| Error message details | |

■ **Sending an Original Document and Scanned Data**

| Info | Findings |
|---|---|
| Can both the original document and scanned data be sent by fax or e-mail? | Circle one: Available Unavailable |

7.5 Checking the Scanner Labels

The following diagrams show where the labels are located on the scanner. The labels are on the back of the scanner.

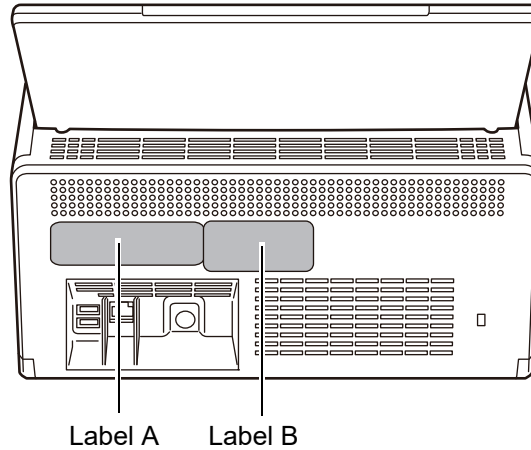

The following are the label examples.

- Label A
Example: Contains various scanner information.

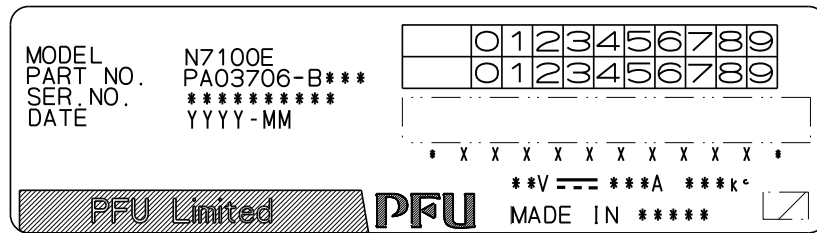

- Label B
Example: Indicates the various standards that the scanner conforms to.

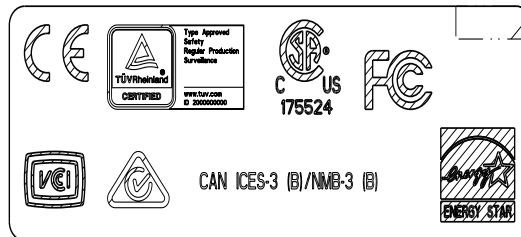

7.6 Pre-Maintenance Preparations

Before sending the scanner for maintenance, the user data store and system settings should be backed up.

- ["Backing up the User Data Store" \(page 168\) in "4.16.1 Maintaining the User Data Store" \(page 166\)](#)
- ["4.16.2 Maintaining the System Settings" \(page 170\)](#)

After backing them up, refer to the following and delete the user data store and system settings.

If the hard disk (SSD) is replaced, all settings will revert to their factory default values.

- ["Clearing the User Data Store" \(page 169\) in "4.16.1 Maintaining the User Data Store" \(page 166\)](#)
- ["Resetting to Factory Defaults" \(page 173\) in "4.16.2 Maintaining the System Settings" \(page 170\)](#)

ATTENTION

User data may contain private information such as information on e-mail senders and fax numbers, so care should be taken when managing such data.

Appendix A

Paper Specifications

Admin

User

This appendix describes the paper size and quality requirements for ensuring that the ADF operates correctly when scanning documents.

| | |
|---|------------|
| A.1 Paper Size | 394 |
| A.2 Paper Quality | 395 |
| A.3 Maximum Document Loading Capacity | 397 |
| A.4 Area not to be Perforated or Affixed with Other Papers | 398 |
| A.5 Multifeed Detection Conditions..... | 399 |
| A.6 Conditions for Using a Carrier Sheet | 400 |

A.1 Paper Size

The following paper sizes can be scanned with this scanner:

Width: 50.8 to 216 mm (2 to 8.5 in.)

Length: 50.8 to 355.6 mm (2 to 14 in.)(*)

(*): The maximum length of a document that can be scanned is 3,048 mm (120 in.).

When you scan a document longer than 863 mm (34 in.), set the resolution to 200 dpi or less.

A.2 Paper Quality

Paper Type

The following paper types are recommended for use with the ADF:

- Woodfree paper
- Wood containing paper
- PPC paper (recycled paper)
- Plastic card

When documents of a paper type other than those listed above are scanned, perform the test-scan with a same paper type first to check if the document can be scanned without problem.

Paper Weight

The following paper weights can be used with the ADF:

- 40 to 209 g/m² (11 to 56 lb)
- For A8 size, 127 to 209 g/m² (34 to 56 lb)
- For plastic cards (long edge feed only), 0.76 mm (0.029 in.) or less (including embossed cards)

Precautions

The following documents may not be scanned successfully:

- Documents of non-uniform thickness (such as, envelopes and documents with attachments)
- Wrinkled or curled documents (See the following hint)
- Folded or torn documents
- Tracing paper
- Coated paper
- Carbon paper
- Photosensitive paper
- Perforated or punched documents
- Documents that are not square or rectangular
- Exceptionally thin documents (less than 40 g/m²)
- Photographs (photographic paper)

Do not attempt to scan the following types of documents:

- Paper-clipped or stapled documents
- Documents on which the ink is still wet
- Documents smaller than A8 size
- Documents wider than 216 mm (8.5 in.)
- Documents other than paper documents and plastic card documents: such as fabric, foil, and OHP film made documents.
- Valuable documents that must not be damaged or dirty

ATTENTION

- Carbonless paper contains chemical substances that may damage the brake rollers or other rollers (such as the pick roller) when documents are fed. Pay attention to the following:
 - Cleaning
 - If paper jams occur frequently, clean the brake rollers and pick roller. For details about cleaning, refer to ["Chapter 6 Scanner Care" \(page 335\)](#).
 - Replacing parts
 - The service life of the brake rollers and pick roller may be shortened when compared to scanning only wood containing paper documents.
- When wood containing paper documents are scanned, the life of the brake rollers and pick roller may be shortened compared with the case where woodfree paper documents are scanned.
- When glossy paper documents, such as photographs, are scanned, the surface of the documents may be damaged.
- When scanning plastic cards, be aware of the following:
 - Use plastic cards that meet the specifications below.
 - Plastic cards that comply with the ISO7810 ID-1 type
 - Size: 85.6 × 53.98 mm
 - Thickness: 0.76 mm or less
 - Material: polyvinyl chloride (PVC) or polyvinyl chloride acetate (PVCA)
 - Before scanning, check that the plastic cards can be fed through the scanner.
 - Plastic cards that are hard and not easy to bend may not be fed smoothly.
 - If the surface of the card is dirty with grease, such as fingerprints, wipe off before scanning.
 - When you scan shiny plastic cards, the image may be partially lighter or darker than the original. Example: a gold credit card
 - When you scan embossed cards, face the embossed side down and load them in a landscape orientation.
 - Scanning thick documents such as a plastic card incorrectly detects it as a multifeed error. To avoid this, disable the intelligent multifeed detection mode or the multifeed detection.

HINT

- When scanning semi-transparent documents, set the scan [Brightness] to a lighter level to avoid image bleed through.
- Clean the rollers as frequently as possible when you scan documents written in pencil, because pencil traces may smudge other documents. Unclean rollers may also cause a paper feed error.
 - For details about cleaning, refer to ["Chapter 6 Scanner Care" \(page 335\)](#).
- When scanning documents with the ADF, the leading edges of all the documents must be aligned. The curling of the leading edge must be within the following tolerances:

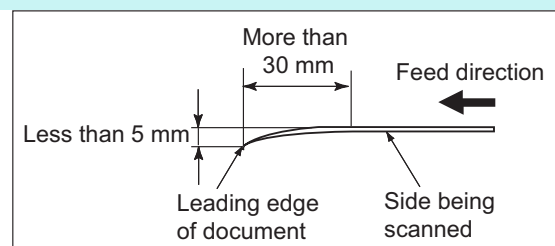
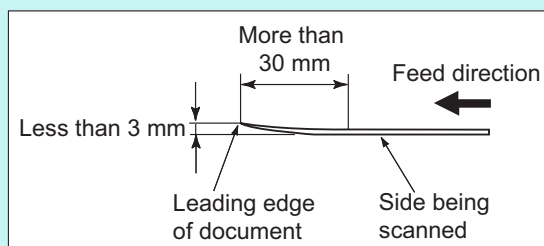

A.3 Maximum Document Loading Capacity

The maximum number of sheets that can be loaded into the ADF paper chute is determined by the size and weight of document papers.

The following graph shows the maximum document loading capacity of ADF according to paper size and weight.

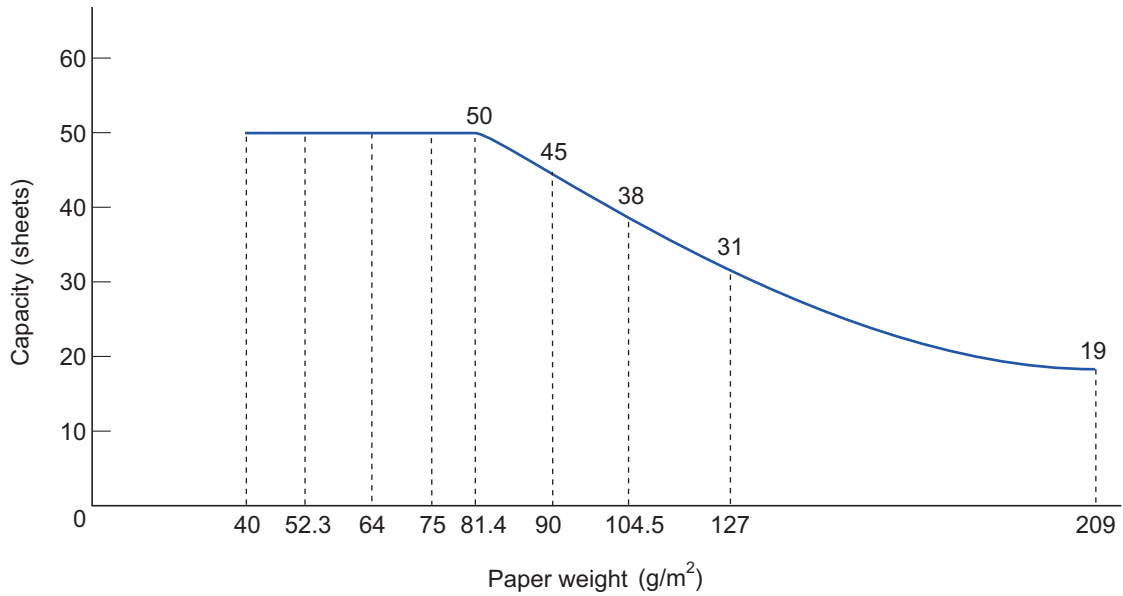

| Unit | Standard paper weights | | | | | | | | |
|------------------|------------------------|------|----|----|------|----|-------|-----|-----|
| lb | 11 | 14 | 17 | 20 | 22 | 24 | 28 | 34 | 56 |
| g/m ² | 40 | 52.3 | 64 | 75 | 81.4 | 90 | 104.5 | 127 | 209 |

A.4 Area not to be Perforated or Affixed with Other Papers

ADF feeding errors may occur while scanning if the document has any (punched) holes, or if any other papers are attached in the area shown in the following figure.

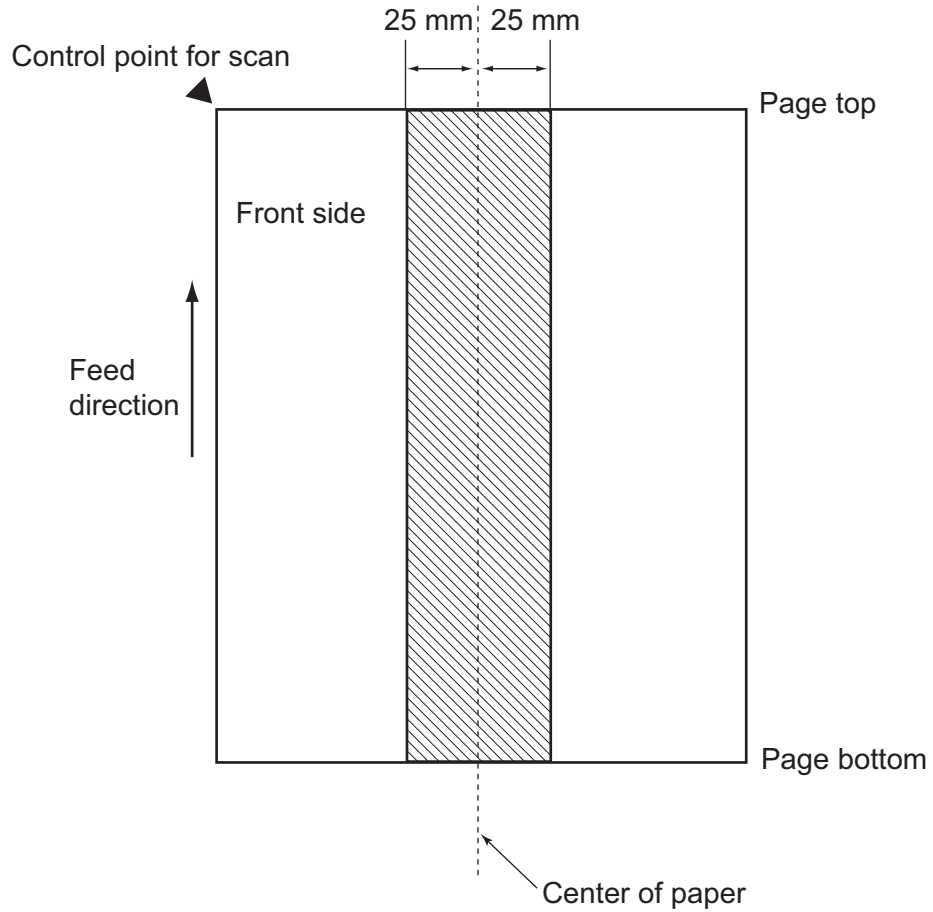

A.5 Multifeed Detection Conditions

There are three multifeed detection modes: document layer, document length, and both document layer and length.

The following conditions must be satisfied in each of these detection modes.

Detection by Layer

- Set sheets of the same weight in the ADF paper chute for a series of scans.
- Paper weight: 40 to 209 g/m² (11 to 56 lb)
- Punched holes are not allowed anywhere in the shaded column located in the middle of the document with a width of 25 mm (0.98 in.) on either side within the column. (*)
- Do not glue any other paper anywhere in the shaded column located in the middle of the document with a width of 25 mm (0.98 in.) on either side within the column. (*)

(*): Refer to ["A.4 Area not to be Perforated or Affixed with Other Papers"](#) (page 398).

Detection by Length

- Set sheets of the same length in the ADF paper chute for a series of scans.
- Document length deviation: 1% or less
- Punched holes are not allowed anywhere in the shaded column located in the middle of the document with a width of 25 mm (0.98 in.) on either side within the column. (*)

(*): Refer to ["A.4 Area not to be Perforated or Affixed with Other Papers"](#) (page 398).

Detection by both Layer and Length

- Set sheets of the same weight and length in the ADF paper chute for a series of scans.
- Paper weight: 40 to 209 g/m² (11 to 56 lb)
- Document length deviation: 1% or less
- Punched holes are not allowed anywhere in the shaded column located in the middle of the document with a width of 25 mm (0.98 in.) on either side within the column. (*)
- Do not glue any other paper anywhere in the shaded column located in the middle of the document with a width of 25 mm (0.98 in.) on either side within the column. (*)

(*): Refer to ["A.4 Area not to be Perforated or Affixed with Other Papers"](#) (page 398).

ATTENTION

- Multifeed detection by layer will always mis-detect thick paper as a multifeed error. To avoid this, disable the intelligent multifeed detection mode or the multifeed detection.
- Multifeed detection rate may decrease depending on the document condition.
- Multifeed may not be detected for the top and bottom 30 mm of a document.

A.6 Conditions for Using a Carrier Sheet

A.6.1 Paper Size

The following paper sizes can be scanned with this scanner:

- A3 (297 × 420 mm)(*)
- B4 (JIS) (257 × 364 mm)(*)
- Double Letter (279.4 × 431.8 mm/11 × 17 in.)(*)

(*): The above paper sizes must be folded in half to be scanned.

A.6.2 Paper Quality

Paper Type

The following paper types are recommended for use with the ADF:
Standard office paper

Paper Weight

The following paper weights can be used with the ADF:

- Up to 209 g/m² (56 lb)
- Up to 104.5g/m² (28 lb) when folded in half

Precautions

Take note of the following:

- Up to ten carrier sheets can be loaded at once.
- Do not write on, color, stain, or cut the end with a black and white pattern because the carrier sheet will not be recognized properly.
- Do not place the carrier sheet upside down. Otherwise, a paper jam may occur and damage the carrier sheet and the document inside.
- Do not leave your document inside the carrier sheet for a long time. Otherwise, the ink on the document may be transferred onto the carrier sheet.
- To avoid deformation, do not use or leave the carrier sheet in high temperature places such as under direct sunlight or near a heating apparatus for a long time.
- Do not fold or pull the carrier sheet by force.
- Do not use a damaged carrier sheet because it may damage or cause the scanner to malfunction.
- To avoid deformation, keep the carrier sheet on a flat surface without any weight on it.
- Be careful not to cut your finger on the edge of the carrier sheet.
- If paper jams occur frequently, feed about 50 sheets of PPC paper (recycled paper) before scanning with the carrier sheet.
The PPC paper (recycled paper) can either be blank or printed.
- Paper jams may occur when multiple small size documents, such as photographs and postcards, are placed inside the carrier sheet to be scanned at once. It is recommended that you scan such documents one at a time.

Appendix B

Management Settings and Limits

This appendix describes e-mail address setting values and the limits for the setting items.

| | |
|--|------------|
| B.1 e-Mail Address Setting Values | 402 |
| B.2 Limits for Setting Items..... | 403 |

B.1 e-Mail Address Setting Values

e-Mail addresses may be up to 256 characters long.

One of the following e-mail address formats must be used:

- *XXXXXXXX@IP_address*
- *XXXXXXXX@Host_name*
- *XXXXXXXX@Domain_name*

| | |
|--------------------|--|
| <i>XXXXXXXX</i> | <p>Comprised of alphanumerics and the following symbols: ! # \$ % & ' * + - / = ? ^ _ ` { } ~ .</p> <p>However, periods (.) cannot be used in the following cases:</p> <ul style="list-style-type: none"> ● Using periods (.) as an initial character ● Using periods (.) as a last element ● Using periods (.) consecutively |
| <i>IP_address</i> | <p>Comprised of numbers separated by periods (.).</p> <p>IP addresses within the following ranges may be used: 1.0.0.1 to 126.255.255.254 128.0.0.1 to 191.255.255.254 192.0.0.1 to 223.255.255.254</p> <p>Note that an IPv6 address cannot be specified.</p> |
| <i>Host_name</i> | <p>Comprised of alphanumerics and hyphens (-) only. The initial character may not be a hyphen.</p> |
| <i>Domain_name</i> | <p>Comprised of alphanumerics and hyphens (-) only, and separated by periods (.).</p> <p>Each name element may be up to 63 characters long, and only alphabetic characters may be used for the last element.</p> |

B.2 Limits for Setting Items

| Item | | Limit |
|--------|---|--|
| e-Mail | Destination e-mail addresses | 30 (For each: To, Cc, Bcc) |
| | Segment size | 64 to 10,240 KB (Up to the size of one split e-mail) |
| | Maximum attachment size | 1 to 20 MB |
| | Address warning limit | 2 to 1,000 |
| | e-Mail addresses registered to an e-mail address book | <ul style="list-style-type: none"> ● e-Mail addresses only 10,000 ● e-Mail addresses, groups and distribution lists Total of 5,000 |
| | e-Mail addresses registered to a distribution List | 100 |
| Fax | Fax numbers registered to a fax number list | 1,000 |
| | Fax destinations | One per transmission |
| Save | Registered folders | 100 (Total of network folders, FTP folders and SharePoint folders) |
| | Viewable folders and tree items | 10,000 (Total of domains, computers and network folders) |
| Print | Registered printers | 100 |
| | Viewable printers and tree items | 10,000 (Total of domains, computers and network printers) |

| | Item | Limit |
|--------------------|---|---|
| Job Management | Registered jobs | 1,000 (Up to 10 actions can be registered per job) |
| | Registered job menus | 100 |
| | Registered job groups | 100 |
| | Registered job group members | 1,000 (Total of users and LDAP groups) |
| | LDAP group availability range | Users within the 5th level |
| User Management | Registered user profiles | 1,000 |
| | Local users | 100 |
| Central Management | Managed scanners | 1,000 |
| Log Management | User logs | 1,000 |
| | System logs | 1,000 |
| Device Maintenance | Error Notification destination e-mail addresses | 5 |
| | Registered Add-ins | 6 (Total of six items, including Add-ins and other function items, can be displayed on the [Main Menu] window) |
| | Imported licenses | 100 |
| | Destination of trap notifications for SNMP settings | Maximum 5 |

Appendix C

Compatibility and Connectivity

Admin User

This appendix describes the compatibility and connectivity of the resources/programs for the scanner.

| | |
|--------------------------------|------------|
| C.1 Compatibility | 406 |
| C.2 Connectivity | 411 |

C.1 Compatibility

C.1.1 Add-in Performance

Add-in performance compatibility is as follows.

In the chart below, ".NET Framework" is described as ".NET".

For details about each Add-in, refer to the SDK reference guide.

| Add-in Performance Compatibility | | Location for Installing | | |
|---|------------------------------|---|--|---|
| | | N7100/N7100E SDK 7.0.0 or later .NET 4.5 | N1800 SDK 6.0.0 to 6.1.0 .NET 3.5 | fi-6010N SDK 4.0.0 to 6.1.0 .NET 2.x |
| N7100/ N7100E SDK 7.0.0 or later | SDK Add-in (WPF) | Yes | — | — |
| | Web-SDK Add-in | Yes | Yes | — |
| | SDK Add-in (Windows Form) | Yes | Yes | Yes |
| N1800 SDK 6.0.0 to 6.1.0 | SDK Add-in (WPF) | — | — | — |
| | Web-SDK Add-in | Yes | Yes | — |
| | SDK Add-in (Windows Form) | Yes | Yes | Yes |
| fi-6010N SDK 4.0.0 to 6.1.0 | SDK Add-in (WPF) | — | — | — |
| | Web-SDK Add-in | — | — | — |
| | SDK Add-in (Windows Form) | Yes | Yes | Yes |

Yes: Compatible —: Incompatible

C.1.2 Using System Settings in Other Scanners

The following table shows whether the backed-up system settings can be restored to other scanners or not.

| Backing Up & Restoring the Data (Model, System Version) | | | Restore to | | | | |
|--|----------|--|------------------------|------------------------|-------------------|--|------------------------|
| | | | N7100E | N7100 | N1800 | | fi-6010N |
| | | | First version or later | First version or later | 01.02.01 or later | First version or any other version earlier than 01.02.01 | First version or later |
| Back up from | N7100E | First version or later | Yes | — | — | — | — |
| | N7100 | First version or later | Yes | Yes | — | — | — |
| | N1800 | 01.02.01 or later | Yes (*) | Yes (*) | Yes | — | — |
| | | First version or any other version earlier than 01.02.01 | Yes (*) | Yes (*) | Yes | Yes | — |
| | fi-6010N | First version or later | Yes (*) | Yes (*) | Yes | Yes | Yes |

Yes: Restorable —: Not Restorable

(*): The default values are used for [Scan Settings] in the job menu settings.

C.1.3 Using User Data in Other Scanners

The following table shows whether backed-up user data can be restored to other scanners or not.

| Backing Up & Restoring the Data (Model) | | Restore to | | | |
|--|----------|------------|-------|-------|----------|
| | | N7100E | N7100 | N1800 | fi-6010N |
| Back up from | N7100E | Yes | Yes | — | — |
| | N7100 | Yes | Yes | — | — |
| | N1800 | Yes | Yes | Yes | — |
| | fi-6010N | Yes | Yes | Yes | Yes |

Yes: Restorable —: Not Restorable

C.1.4 Sharing User Data

The following table shows whether user data is sharable or not when sharing user data is enabled on the Central Admin Server.

| Sharing (Model) | | Share with | | | |
|--------------------|----------|------------|----------|-------|----------|
| | | N7100E | N7100 | N1800 | fi-6010N |
| Sources | N7100E | Yes | Yes (*1) | — | — |
| | N7100 | Yes (*2) | Yes | — | — |
| | N1800 | Yes (*3) | Yes (*3) | Yes | — |
| | fi-6010N | Yes (*3) | Yes (*3) | Yes | Yes |

Yes: Sharable —: Not Sharable

(*1): The SharePoint folder specified for [SharePoint Folder] under [Save] on the N7100E touch panel cannot be used for N7100.

(*2): The SharePoint Option for N7100 cannot be used for N7100E.

(*3): The default values for each scanner are used in [Scan Settings]. Information other than [Scan Settings] can be shared.

C.1.5 Sharing Job Settings

The following table shows whether the job menu settings are sharable or not when sharing job settings are enabled on the Central Admin Server.

| Sharing (Model) | | Share with | | |
|--------------------|--------------|------------------|-------|----------|
| | | N7100/ N7100E | N1800 | fi-6010N |
| Sources | N7100/N7100E | Yes | — | — |
| | N1800 | Yes (*) | Yes | — |
| | fi-6010N | Yes (*) | Yes | Yes |

Yes: Sharable —: Not Sharable

(*): The default values for each scanner are used in [Scan Settings]. Information other than [Scan Settings] can be shared.

C.1.6 Distribution from the Central Admin Console Server

The following table shows whether the items below can be distributed from the Central Admin Console Server.

| Distribution from the Central Admin Console Server | | | Connect to | | | |
|--|------------------|-----------------|------------|-------|-------|----------|
| | | | N7100E | N7100 | N1800 | fi-6010N |
| Sources | 5.2 or later (*) | System Update | Yes | Yes | Yes | Yes |
| | | Add-in | Yes | Yes | Yes | Yes |
| | | System Settings | Yes | Yes | Yes | Yes |
| | | Job Settings | Yes | Yes | Yes | Yes |
| | 4.6 to 5.0 (*) | System Update | — | Yes | Yes | Yes |
| | | Add-in | — | Yes | Yes | Yes |
| | | System Settings | — | Yes | Yes | Yes |
| | | Job Settings | — | Yes | Yes | Yes |
| | 3.0 to 4.5 (*) | System Update | — | — | Yes | Yes |
| | | Add-in | — | — | Yes | Yes |
| | | System Settings | — | — | Yes | Yes |
| | | Job Settings | — | — | Yes | Yes |
| | 2.0 to 2.6 (*) | System Update | — | — | — | Yes |
| | | Add-in | — | — | — | Yes |
| | | System Settings | — | — | — | Yes |
| | | Job Settings | — | — | — | Yes |

Yes: Can be distributed —: Cannot be distributed

(*): Version of the Central Admin Server

C.2 Connectivity

C.2.1 Connectivity with the Admin Tool

Connectivity with the Admin Tool is as follows.

| Connectivity (Model, Version) | | | Connect to | | |
|----------------------------------|------------------|----------------|------------------|-------|----------|
| | | | N7100/ N7100E | N1800 | fi-6010N |
| Sources | N7100/ N7100E | 03.01 to 04.01 | Yes | Yes | Yes |
| | N1800 | 02.02 to 02.04 | — | Yes | Yes |
| | fi-6010N | 02.01 to 02.02 | — | — | Yes |

Yes: Connectable —: Not Connectable

C.2.2 Connectivity with the User Editor (AddressBookEditor)

Connectivity with the User Editor (AddressBookEditor) is as follows.

| Connectivity (Model, Version) | | | Connect to | | |
|----------------------------------|------------------|----------------|------------------|-------|----------|
| | | | N7100/ N7100E | N1800 | fi-6010N |
| Sources | N7100/ N7100E | 03.01 to 04.01 | Yes | Yes | Yes |
| | N1800 | 01.01 to 02.01 | — | Yes | Yes |
| | fi-6010N(*) | 01.01 to 02.02 | — | — | Yes |

Yes: Connectable —: Not Connectable

(*): AddressBookEditor

C.2.3 Connectivity with the Central Admin Server

Connectivity with the Central Admin Server is as follows.

| Connectivity with the Central Admin Server | | Connect to | | | |
|--|------------------|------------|-------|-------|----------|
| | | N7100E | N7100 | N1800 | fi-6010N |
| Sources | 5.2 or later (*) | Yes | Yes | Yes | Yes |
| | 4.6 to 5.0 (*) | — | Yes | Yes | Yes |
| | 3.0 to 4.5 (*) | — | — | Yes | Yes |
| | 2.0 to 2.6 (*) | — | — | — | Yes |

Yes: Connectable —: Not Connectable

(*): Version of the Central Admin Server

C.2.4 Root Certification Authority List

SSL (Secure Socket Layer) encrypted communication may be used by the scanner for user authentication and save operations to the FTP server or a SharePoint folder. With SSL, trust certificates are exchanged to authenticate the communication opponents. The following root certificate authorities are pre-registered in the scanner. Also, root certificates may be imported. For details about importing certificates, refer to ["4.4.6 Managing Certificates" \(page 84\)](#).

| Issuer | Valid until... (YYYY/MM/DD) |
|---|-----------------------------|
| AddTrust External CA Root | 2020/05/30 |
| Baltimore CyberTrust Root | 2025/05/13 |
| Class 3 Public Primary Certification Authority | 2028/08/02 |
| GeoTrust Global CA | 2022/05/21 |
| Hotspot 2.0 Trust Root CA - 03 | 2043/12/08 |
| Microsoft ECC Product Root Certificate Authority 2018 | 2043/02/28 |
| Microsoft ECC TS Root Certificate Authority 2018 | 2043/02/28 |
| Microsoft Root Authority | 2020/12/31 |
| Microsoft Root Certificate Authority | 2021/05/10 |
| Microsoft Root Certificate Authority 2010 | 2035/06/24 |
| Microsoft Root Certificate Authority 2011 | 2036/03/23 |
| QuoVadis Root Certification Authority | 2021/03/18 |

| Issuer | Valid until... (YYYY/MM/DD) |
|--|--------------------------------|
| Starfield Services Root Certificate Authority | 2030/01/01 |
| Symantec Enterprise Mobile Root for Microsoft | 2032/03/15 |
| Thawte Timestamping CA | 2021/01/01 |
| VeriSign Class 3 Public Primary Certification Authority - G5 | 2036/07/17 |
| VeriSign Universal Root Certification Authority | 2037/12/02 |

ATTENTION

- If the root certificate authority validation period expires, SSL connection is not possible. Update the root certificate with a validation period that has expired, if necessary.
- Certificates will not be installed automatically.
If you want to use a certificate that is not in the list, import the certificate.
- If you failed to add SharePoint Online when registering a SharePoint folder, import the certificate "Digicert Global Root CA" to the scanner.

C.2.5 SMTP Server Settings for Using Webmail

When using Webmail to send e-mail, specify the SMTP settings according to the Webmail as follows.

| Webmail | Server Address(*) | Port Number | SSL | SMTP Authentication | Authentication Mode |
|-------------|---------------------|-------------|-------------|---------------------|------------------------|
| Gmail | smtp.gmail.com | 587 | STARTTLS on | Select | AUTH LOGIN, AUTH PLAIN |
| Yahoo! Mail | smtp.mail.yahoo.com | 465 | SSL on | Auto | AUTH LOGIN, AUTH PLAIN |
| AOL Mail | smtp.aol.com | 587 | STARTTLS on | Auto | AUTH LOGIN, AUTH PLAIN |
| Outlook.com | smtp.live.com | 587 | STARTTLS on | Select | AUTH LOGIN, AUTH PLAIN |

(*): Change ".com" according to your country's domain.

For details about how to specify SMTP server settings, refer to ["4.11.1 Setting the SMTP Server" \(page 125\)](#).

Appendix D

Scanner Specifications

Admin

User

This appendix gives specifications for the scanner.

| | |
|--|------------|
| D.1 Installation Specifications | 415 |
| D.2 Basic Scanner Specifications | 416 |
| D.3 Software Function List..... | 417 |
| D.4 Changing the Functions on the On-Screen Keyboard..... | 419 |
| D.5 Barcode Types and Detection Conditions | 421 |

D.1 Installation Specifications

| Item | | Specification |
|------------------------|--------------------|---|
| Dimensions (W × D × H) | | 300 × 232 × 172 mm (11.81 × 9.14 × 6.77 in.) (This does not include the ADF paper chute or other parts that stick out) |
| Weight | | 6.0 kg |
| LCD | | 8.4-in. XGA TFT LCD monitor |
| Touch panel | | Analog resistive touch panel |
| Keyboard | | On-screen keyboard |
| Interface | Network | LAN (1000BASE-T/100BASE-TX/10BASE-T) ×1 |
| | USB | USB 2.0 ×2 (For keyboard and mouse) |
| Input power | Voltage | 100 to 240 V ±10% |
| | Frequency | 50/60 Hz |
| Power consumption (AC) | Operating | 38 W or less |
| | Energy-saving mode | Power consumption value is different depending on the "PART NO." that is printed on the label (*). PA03706-Bxx1/Bxx3: 2.0 W or less PA03706-Bxx5: 8.8 W or less |
| | Power off | 0.3 W or less |
| Operating environment | Temperature | Operating: 5 to 35 °C, Non-operating: -20 to 60 °C |
| | Humidity | Operating: 20 to 80%, Non-operating: 8 to 95% |
| Heating value | Operating | 33 Kcal/Hr or less |
| | Energy-saving mode | Heating value is different depending on the "PART NO." that is printed on the label (*). PA03706-Bxx1/Bxx3: 1.72 Kcal/Hr or less PA03706-Bxx5: 7.57 Kcal/Hr or less |
| | Power off | 0.26 Kcal/Hr or less |

(*): For details about the labels, refer to ["7.5 Checking the Scanner Labels"](#) (page 391).

HINT

The scanner is equipped with a LAN card that supports Wake On LAN. The power is not turned on automatically by the Wake On LAN function after the power goes off abnormally, such as in the event of a blackout.

D.2 Basic Scanner Specifications

| Item | | Specification | Remarks |
|---------------------------------------|--------------------|--|---|
| Scanner type | | ADF (Automatic Document Feeder) | |
| Image sensor | | Color CIS × 2 | One for the front side, and the other for the back side |
| Light source | | RGB 3-color LED | |
| Scannable document size | Minimum | 50.8 × 50.8 mm (2 × 2 in.) | (*1) |
| | Maximum | 216 × 355.6 mm (8.5 × 14 in.) | |
| Paper weight | | 0.049 to 0.257 mm (40 to 209 g/m ² , 11 to 56 lb, 34.4 to 180 kg/ream) For A8 size, 0.157 to 0.257 mm (127 to 209 g/m ² , 34 to 56 lb, 110 to 180 kg/ream) | For plastic cards (long edge feed only), 0.76 mm (0.029 in.) or less (including embossed cards) |
| Scan speed (A4/Letter, Portrait) (*2) | Black & white | Simplex: 25 sheets/min., Duplex: 50 pages/min. | 200/300 dpi |
| | Grayscale | | |
| | Color | | |
| ADF paper chute capacity | | 50 sheets (Letter/A4, 80 g/m ² (20 lb)) | Total document thickness of 5 mm or less |
| Optical resolution | | 600 dpi | |
| Output resolution | | 150 dpi, 200 dpi, 300 dpi, 600 dpi | |
| Image processing | Automatic function | Paper size auto detection (crop), deskew (edge/contents), blank page skip, black & white/grayscale/color auto detection, dropout color, control image tone, cleanup, text emphasis, de-screen, background pattern removal, background leveling, crop with tab, multi image, auto binarization, image direction correction, OCR, marker OCR | |

(*1): a page length of up to 3,175 mm (125 in.) is allowed for document scanning. When you scan a document longer than 863mm (34 in.), set the resolution to 200 dpi or less.

(*2): The maximum hardware limitation. Actual scanning time includes software processing time such as data transfer time.

D.3 Software Function List

| Item | | | Specification |
|----------------------|--------------------------------|------------------------|---|
| System | Authentication | User type | Available |
| | | Server | Active Directory, OpenLDAP |
| | | Serverless | Available |
| | | Authentication mode | LAN Manager, Kerberos (Local account is also available) |
| Network | Protocol | | IPv4, TCP, UDP, ICMP, DNS, DHCP, WINS, NTP, SNMP |
| | | | IPv6, ICMPv6, DNSv6, DHCPv6, WSD, LLMNR, Neighbor Discovery, Router Discovery/Advertisement |
| | | | LDAP, HTTP, SMTP, FTP, NetBIOS |
| | | | SSL (LDAPS, HTTPS, FTPS) |
| Office function | e-Mail | e-Mail server | Windows IIS, Exchange server |
| | | File splitting | Available |
| | | Split file designation | Available |
| | | e-Mail broadcasting | Available |
| | | Delivery confirmation | Available |
| | | Address book | For each user |
| | Save | Saved to | Shared folder, FTP server folder, SharePoint folder |
| | | Shared folder | CIFS |
| | | FTP server folder | FTP, FTPS |
| | | SharePoint folder | HTTP, HTTPS |
| | Fax | Fax server | RightFax, Kofax Communication Server, Internet FAX |
| Print | Print server | Available | |
| Operational function | Job (simplified customization) | | Available |
| | SDK Add-in (WPF) | | Available |
| | WEB-SDK Add-in | | Available |
| | SDK Add-in (Windows Form) | | Available |

| Item | | Specification |
|----------------------|---|-----------------------------------|
| Operability | Preview ([Scan Viewer] window) | Thumbnail/page view switching |
| | Finger operations (only for the scan viewer details window) | Tap, zoom-in, zoom-out, rotation |
| Operation management | Setting method | Touch panel, remote |
| | Remote management | Available (Central Admin Console) |
| | Integrated management | Available (Central Admin Console) |

D.4 Changing the Functions on the On-Screen Keyboard









The scanner supports the on-screen keyboard that enables entering characters on the touch panel.



For details on how to show/hide the on-screen keyboard, refer to ["2.4 Using the On-Screen Keyboard"](#) (page 55).

D.4.1 Switching the Keyboard Layout

There are two types of keyboard layouts on the on-screen keyboard: alphabetic layout and numeric and symbols layout.

The keyboard layout can be switched in the following ways.

| Keyboard Layout | Operation |
|--------------------------------|--|
| Numeric and symbols layout | Press  . ⇒ Becomes  . |
| Alphabetic layout | Press  . ⇒ Becomes  . |
| Switching the upper/lower case | <ul style="list-style-type: none"> ● Switching upper/lower cases after entering a character Press . ⇒ Becomes . ● Entering characters continuously without switching upper/lower cases Press  twice (tap it twice). ⇒ Becomes  (with alphabetic layout). |

| Keyboard Layout | Operation |
|--|---|
| Switching the symbols that are displayed | <ul style="list-style-type: none">Each time you press  / , the symbols that are displayed are switched. |

D.5 Barcode Types and Detection Conditions

This section describes the barcode types that can be used and the detection conditions. Barcodes that do not meet the detection conditions may not be recognized correctly.

■ One-dimensional Barcodes

| Code | Character Set | Number of Digits |
|----------------------|---|--|
| UPC | Numbers | 12 (UPC-A only. Includes check digits) |
| EAN/JAN | Numbers | 8 or 13 (Includes check digits) |
| CODE39 Full ASCII | Full ASCII | 1 to 32 (Excludes start/stop codes) |
| CODE128/ EAN128 | Full ASCII | 1 to 32 (Excludes check characters) |
| Codabar (NW7) | 4 types of start/stop characters, numbers, 6 types of symbols | 1 to 32 (Excludes start/stop codes) |
| ITF | Numbers | 2 to 32 (Always an even number) |

■ Detection Conditions for One-dimensional Barcodes

| Item | Conditions |
|--------------------------|---|
| Barcode height | 10 to 30 mm/0.39 to 1.18 in. |
| Barcode width (length) | 300 mm/11.18 in. or less |
| Barcode margin | 5 mm/0.20 in. or more of the barcode margin (The ITF left and right edges should be 5 mm/0.20 in. or more, or at least 6 times of the narrow element width, whichever wider.) |
| Barcode color | Black |
| Barcode background color | White |
| Resolution | 200 to 600 dpi |
| Barcode angle | Horizontal, vertical |

| Item | Conditions |
|-----------------------------------|---|
| Narrow element width/module width | <ul style="list-style-type: none"> ● UPC-A/EAN/JAN 300 dpi or more: 0.264 mm/0.010 in. or wider Less than 300 dpi: 0.30 mm/0.012 in. or wider ● CODE39/CODE128/EAN128/Codabar (NW7) 300 dpi or more: 0.20 mm/0.008 in. or wider Less than 300 dpi: 0.30 mm/0.012 in. or wider ● ITF 300 dpi or more: 0.254 mm/0.010 in. or wider Less than 300 dpi: 0.30 mm/0.012 in. or wider |
| Wide element width | <p>14 mm/0.55 in. or less (For UPC-A/EAN/JAN/CODE128/EAN128, this is the widest element width (corresponds to 4 modules).)</p> |
| Inter-character gap | <ul style="list-style-type: none"> ● UPC-A/EAN/JAN/CODE128/EAN128/ITF No inter-character gap exists. ● CODE39/Codabar (NW7) (Equal to or wider than the narrow element width, and equal to or less than 1.52 mm/0.06 in. or 3 times of the narrow element width, whichever wider) |

ATTENTION

- Skewed barcodes may not be recognized correctly.
- Using the same sheet repeatedly may decrease the recognition accuracy due to accumulated dirt on the sheets. If the sheet is not recognized correctly or gets smudged, replace it with a new sheet.
- If recognition of control codes fails, it may cause the following results:
 - Control codes are recognized as numerical characters.
 - Not only the control codes but part of other characters are not recognized and ignored.
- When control code [NUL] is included in a barcode, it is replaced with " " (space).
- When documents to be scanned are skewed or printed barcodes are not in a good condition, barcodes on the document may not be recognized correctly.
- If more than one barcode exists in the recognition area, it becomes unknown which one will be effective.
- If more than one barcode exists in the recognition area, it becomes unknown that which one will be recognized first.
- Barcodes may be recognized even when the barcode is not black or its background color is not white. To make color barcodes recognizable, you first need to configure the settings for scanning colored documents and check that recognition works properly.

HINT

- The recommended image resolution is 200 to 600 dpi.
- When barcodes are used and the scan speed slows down, reducing the number of barcode types to be selected may improve the scan speed.

Appendix E

SNMP Settings

Admin

User

This appendix describes the SNMP settings.

The SNMP settings are used to acquire SNMP information from the SNMP manager and to send SNMP trap notification to the SNMP manager.

| | |
|--|------------|
| E.1 Corresponding MIB | 424 |
| E.2 MIB Information | 425 |
| E.3 SNMP Trap Notification..... | 427 |

E.1 Corresponding MIB

The corresponding MIB is as follows:

- PC MIB
 - .iso.org.internet.mgmt.mib-2
 - system(1)
 - interfaces(2)
 - ip(4)
 - icmp(5)
 - tcp(6)
 - udp(7)
- PFU net scanner MIB
 - PFU-unique

E.2 MIB Information

This section describes MIB information obtained from the MIB notification.

■ ScannerInfo

| Key Name | Key Value Description | Corresponding MIB/OID |
|--------------------|--|---|
| ModelName | Scanner model N7100 (fixed) | modelName 1.3.6.1.4.1.18886.1.2.2.1 |
| SerialNo | Scanner serial No. Example: A6RCA12345 | serialNo 1.3.6.1.4.1.18886.1.2.2.2 |
| OperatingStatus | Scanner power status 1: Power Off 2: Power On | operatingStatus 1.3.6.1.4.1.18886.1.2.2.4 |
| AdfTotalThroughput | ADF total throughput | adfTotalThroughput 1.3.6.1.4.1.18886.1.2.2.6 |
| FirmwareVersion | Scanner firmware version Example: 0B08 | firmwareVersion 1.3.6.1.4.1.18886.1.2.2.8 |
| ErrorStatus | Scanner error status 0: No error has occurred 1: An error has occurred | errorStatus 1.3.6.1.4.1.18886.1.2.2.5 |
| Vendor | Vendor name fujitsu (fixed) | Vendor 1.3.6.1.4.1.18886.1.2.2.9 |

■ BrakeRoller

| Key Name | Key Value Description | Corresponding MIB/OID |
|----------|---|--|
| Status | Brake roller status 1: No replacement required 2: To be replaced soon 3: Replacement time has passed | componentInfoStatus 1.3.6.1.4.1.18886.1.2.2.3.1.1.4.1 |
| Descr | Status description 1: BRAKE ROLLER Normal 2: BRAKE ROLLER Replace soon 3: BRAKE ROLLER Replace now | componentInfoDescr 1.3.6.1.4.1.18886.1.2.2.3.1.1.7.1 |

■ PickRoller

| Key Name | Key Value Description | Corresponding MIB/OID |
|----------|--|--|
| Status | Pick roller status 1: No replacement required 2: To be replaced soon 3: Replacement time has passed | componentInfoStatus 1.3.6.1.4.1.18886.1.2.2.3.1.1.4.2 |
| Descr | Status description 1: PICK ROLLER Normal 2: PICK ROLLER Replace soon 3: PICK ROLLER Replace now | componentInfoDescr 1.3.6.1.4.1.18886.1.2.2.3.1.1.7.2 |

■ TrapEvent

When no error has occurred, the TrapEvent section does not exist.

| Key Name | Key Value Description | Corresponding MIB/OID |
|------------|--|---|
| Status | Hardware error status 3: Error | componentInfoStatus 1.3.6.1.4.1.18886.1.2.2.3.1.1.4.3 |
| Datetime | Date/time of occurrence of a hardware error Example: 20xx/04/10 12:45:29 | componentInfoDatetime 1.3.6.1.4.1.18886.1.2.2.3.1.1.5.3 |
| DetailCode | Hardware error detail code Example: 8F060001 | componentInfoDetailCode 1.3.6.1.4.1.18886.1.2.2.3.1.1.6.3 |
| Descr | A character string indicating hardware error information (containing up to 91 characters) Example: Scanner parts replacement notification was detected. [044400, 00:EEPROM error] | componentInfoDetailDescr 1.3.6.1.4.1.18886.1.2.2.3.1.1.7.3 |

E.3 SNMP Trap Notification

The SNMP trap OID is as follows:

| |
|-------------------------|
| 1.3.6.1.4.1.18886.1.2.1 |
|-------------------------|

The SNMP trap format is as follows:

| |
|---|
| Occurrence_date/ time,Source,IP_address,Model,Serial_No.,Event_type,Message_code,Message |
|---|

| | |
|-----------------------|--|
| Occurrence_date/time: | Date/time of message notification (Format: MM.DD.YYYY hh:mm:ss AM or PM) |
| Source: | Name of the computer that sent the message |
| IP_address: | IP address of the computer that sent the message |
| Model: | Model name of the scanner where message notification occurred |
| Serial_No.: | Serial No. of the scanner where message notification occurred (10 digits) |
| Event_type: | Message type(*1) |
| Message_code: | Message code(*2)(*3) |
| Message: | Message description(*2)(*4) |

(*1): The event types are as follows:

Information: For information

Error: For error

Warning: For warning

Test: For test

(*2): For details about the message code and messages, refer to the Scanner Central Admin User's Guide.

(*3): For test send, "0F090000" is shown.

(*4): For test send, "This is a test message from Network Scanner" is shown.

Appendix F

Editing Using User Editor

Admin

User

This appendix describes how to edit e-mail address books and local accounts using User Editor.

A regular user can contact the administrator for details about the settings of User Editor.

| | |
|--|------------|
| F.1 What is User Editor? | 429 |
| F.2 Pre-settings | 430 |
| F.3 Windows of User Editor | 432 |
| F.4 Starting/Exiting User Editor | 434 |
| F.5 Viewing the e-Mail Address Book/Local Accounts | 435 |
| F.6 Editing an e-Mail Target in the e-Mail Address Book | 438 |
| F.7 Editing Local Accounts | 444 |
| F.8 Discarding the Edited e-Mail Address Book or Local Accounts | 446 |
| F.9 Saving the e-Mail Address Book/Local Account | 447 |
| F.10 User Editor Information Shown in User Log | 449 |
| F.11 User Editor Information Shown in System Log | 450 |

F.1 What is User Editor?

User Editor is an application that is used for editing a scanner e-mail address book (My List) or local accounts.

A scanner e-mail address book or local accounts can be edited from a computer by connecting the computer with User Editor installed to a scanner via the network interface. User Editor facilitates operations such as outputting an e-mail address book or local accounts in a file (CSV format), and importing and saving a number of e-mail addresses in a file to a scanner.

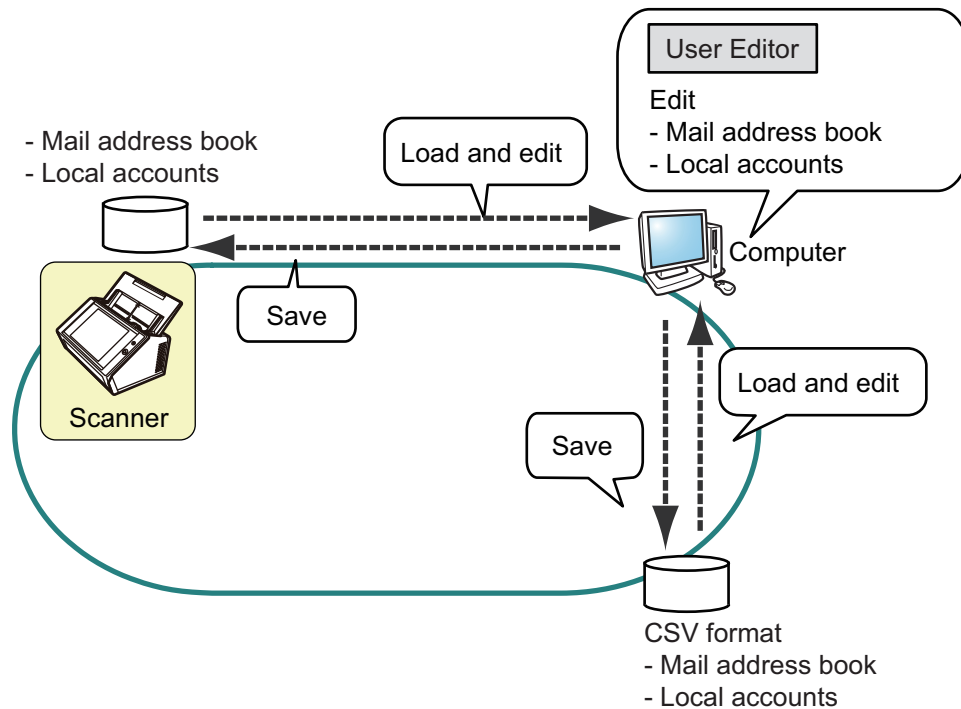

- **Editing an e-mail address book**
A regular user can edit an e-mail address book (My List) and create a group in the e-mail address book by using User Editor, so that the e-mail addresses can be grouped by purpose and managed in a group.
- **Editing local accounts**
An administrator can create local accounts and save them in the scanner by using User Editor. Local accounts can be used for authenticating to the scanner.

F.2 Pre-settings

For the system requirements for using User Editor, refer to "[1.5.1 Requirements for Admin Tool and User Editor](#)" (page 40).

For the port numbers, refer to "[1.5.3 Port Number List](#)" (page 46).

F.2.1 Installing User Editor

To edit an e-mail address book or a local account of a scanner via the network interface, install User Editor in a computer.

1. Display the download window according to "[3.2 Showing the Software Download Window](#)" (page 60).

⇒ The download window appears.

2. Press the [Next] button for the [Network Scanner User Editor].

⇒ The [Download Network Scanner User Editor.] window appears.

3. Press the [Download] button.

ATTENTION

- Downloading is not possible while a scanner operation is in process.
- Installation fails if the length of any installation path (folder path plus installation file name) exceeds 258 characters. Select an installation folder that respects this limit.

HINT

If .NET Framework is not installed, a confirmation window for .NET Framework installation appears.

Press the [Yes] button to install .NET Framework, and then try again from [Step 1](#).

⇒ From here on after, follow the instructions on the window to proceed the operation.

When "Installation complete" is displayed, the installation is complete. Press the [Close] button.

⇒ After installation, User Editor can be started.

For details about how to start User Editor, refer to "[F.4 Starting/Exiting User Editor](#)" (page 434).

F.2.2 Uninstalling User Editor

Uninstall User Editor from [Control Panel] → [Programs] → [Programs and Features] in the computer in which it is installed.

ATTENTION

Close the User Editor before uninstalling.

If User Editor is uninstalled while still open, normal operation of the open User Editor is not guaranteed.

F.3 Windows of User Editor

The User Editor window contains the [Address Book] tab and [Local Account] tab. The following shows the details of each tab.

- [Address Book] tab
This tab page is used for editing the e-mail targets in the e-mail address book.

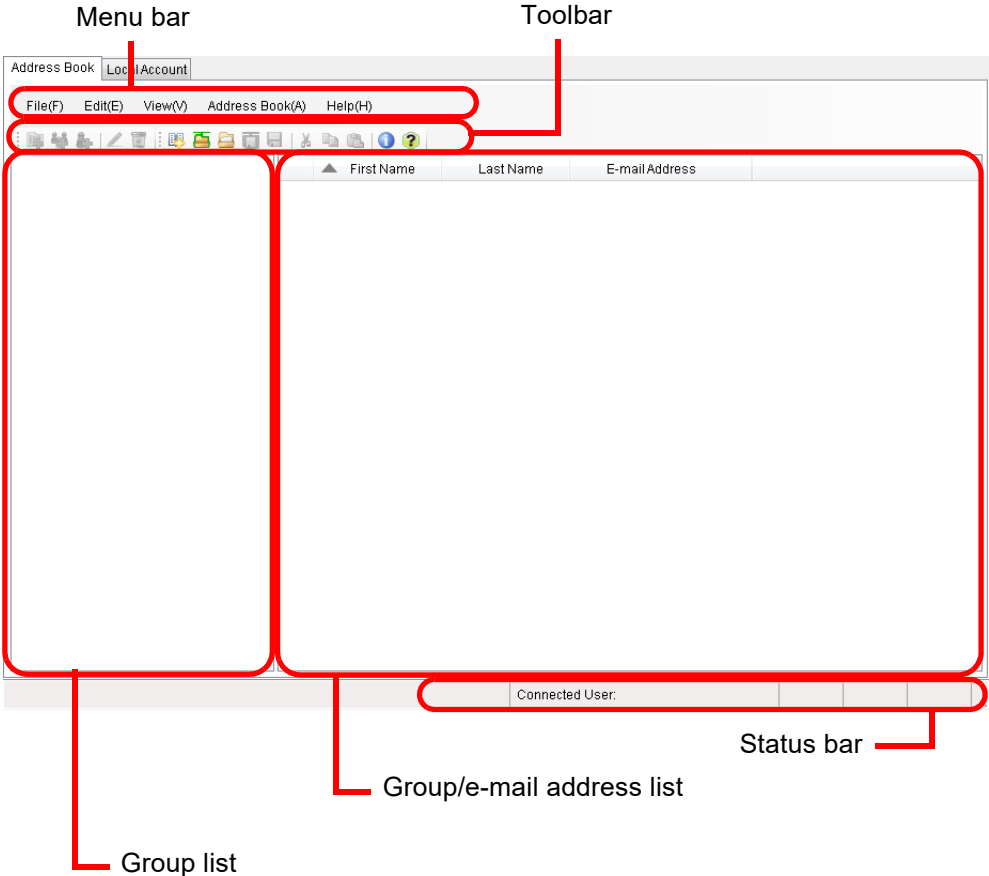

- [Local Account] tab
This tab page is used for editing the local accounts saved in the scanner.



F.4 Starting/Exiting User Editor

■ Starting User Editor

1. Start User Editor.

- Windows Server 2012
Right-click on the Start screen, and select [All apps] → [Network Scanner] → [Network Scanner User Editor].
 - Windows 8.1/Windows Server 2012 R2
Select [i] at the lower left of the Start screen → [Network Scanner] → [Network Scanner User Editor].
To display [i], move the mouse cursor.
 - Windows 10/Windows Server 2016/Windows Server 2019
Select [Start] menu → [Network Scanner] → [Network Scanner User Editor].
- ⇒ The [Network Scanner User Editor] window appears.

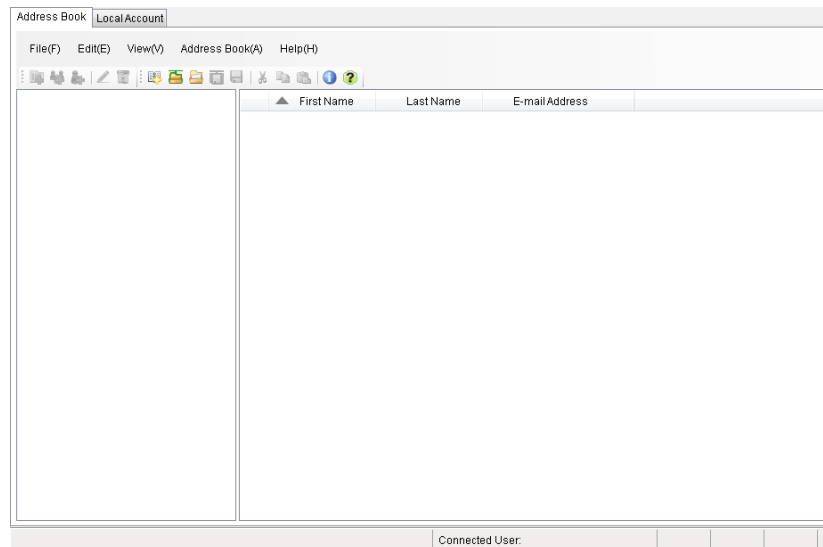

■ Exiting User Editor

1. Select the [File] menu → [Exit].

⇒ The exit confirmation window appears.

2. Press the [OK] button.

⇒ User Editor closes.

F.5 Viewing the e-Mail Address Book/Local Accounts

Load and view e-mail address books or local accounts.

■ Loading from a Scanner

Load e-mail address books or local accounts from a scanner in the following ways.

1. **Select the [Address Book] tab to load e-mail address books.
Select the [Local Account] tab to load local accounts.**

2. **Perform either of following operations:**

- Select the [File] menu → [Load from Scanner].
 - Press the [Load from Scanner] button on the toolbar.
- ⇒ The [Load from Scanner] dialog box appears.

3. **Enter the information to connect to the scanner.**

- Enter the scanner IP address, host name, or FQDN for [Connect to].
 - To enter an IP address, use the "xxx.xxx.xxx.xxx" format, where xxx is a value from 0 to 255.
 - For a host name or FQDN, up to 255 characters can be entered.
- For [Port Number], enter the number of the port to be used for communication with the scanner, within the range of 1 to 65535. The default value is "80".
Select the [Use HTTPS] check box to use HTTPS for communication from the scanner.
- For [User Name], enter the name of the user to login to the scanner.
- For [Password], enter the password for the user to login to the scanner.

HINT

Connect to the scanner as a user who can log in to it.

- To edit an e-mail address book, login as a regular user.
- To edit local accounts, login as an administrator (admin) or an administrator of a local account created with User Editor. For a new local account, login as an administrator (admin).

4. **Select the [Open] button.**

⇒ e-Mail address books or local accounts appear.

■ Loading from a File

Load e-mail address books or local accounts from a file in the following ways.

1. **Select the [Address Book] tab to load e-mail address books.
Select the [Local Account] tab to load local accounts.**

2. **Perform either of following operations:**

- Select the [File] menu → [Load from File].
 - Press the [Load from File] button on the toolbar.
- ⇒ The dialog box for opening a file appears.

3. **Select the file and press the [Load] button.**

⇒ e-Mail address books or local accounts appear.

■ File Format of e-Mail Address Book Loaded from a File

This section describes the file format available for an e-mail address book that can be loaded from a file.

With User Editor, an e-mail address book in CSV format can be edited.

- UNICODE (UTF-8) is used for the file character set.
- Describe in CSV format as follows:
"User Name","Group Name","Distribution List Name","First Name","Last Name","E-mail Address"

The values for each item are as follows.

| Item | Value and Format |
|------------------------|--|
| User Name | Specify the name of the user. |
| Group Name | Specify the name of the group. (*) Prepend "\" at the beginning of the group name. (Example: \group01) To set the levels of the groups, delimit them with "\". (Example: \group01\group02) ";" and "@" are replaced with "_". |
| Distribution List Name | Specify the name of the distribution list. (*) Multiple e-mail addresses must be separated using semi-colons (";"). ";" and "@" are replaced with "_". |
| First Name | Specify the first name. (*) |
| Last Name | Specify the last name. (*) |
| E-mail Address | For details about e-mail address settings values, refer to " B.1 e-Mail Address Setting Values " (page 402). A distribution list can contain up to 100 e-mail addresses. |

- (*): Up to 64 characters can be specified.
Spaces at the start and end of a name are omitted if specified.

■ File Format of Local Accounts Loaded from a File

This section describes the file format available for local accounts that can be loaded from a file.

With User Editor, local accounts in CSV format can be edited.

- UNICODE (UTF-8) is used for the file character set.
- Describe in CSV format as follows:
"User Name","Password","E-mail Address","Comment","Enabled/
Disabled","Account Type"

The values for each item are as follows.

| Item | Value and Format |
|------------------|---|
| User Name | Specify the name of the user. |
| Password | Specify the password. |
| Comment | Specify the comment on the account. |
| E-mail Address | For details about e-mail address settings values, refer to "B.1 e-Mail Address Setting Values" (page 402). |
| Enabled/Disabled | Specify whether the local account is enabled or disabled. "0": Indicates that the local account is disabled. "1": Indicates that the local account is enabled. |
| Account Type | Specify whether or not the local account has administrator right. "0": Indicates a regular user who do not have administrator right. "1": Indicates a user who has administrator right. |

F.6 Editing an e-Mail Target in the e-Mail Address Book

This section describes how to edit e-mail targets in the e-mail address book. An e-mail address book can contain up to 5,000 groups, distribution lists, and e-mail addresses.

F.6.1 Setting a Group

Set groups in the e-mail address book.

A group can contain multiple distribution lists and e-mail addresses, which allows e-mail destinations to be sorted according to the respective purposes. Sub-groups can be created under a group.

By specifying a group as an e-mail destination, an e-mail can be sent to all distribution lists and e-mail addresses registered in the group at the same time.

Up to five levels can be set for groups.

■ Adding a Group

1. Select the **[Address Book]** tab.
2. In the group list, select a group to which the new group is to be added.
3. Open the **[Add Group]** dialog box in either of the following ways.
 - Select the **[Address Book]** menu → **[Add Group]**.
 - Press the **[Add Group]** button.

4. Enter a **[Group Name]**.

This can be up to 64 characters long. The following symbols cannot be used:

\ ; @

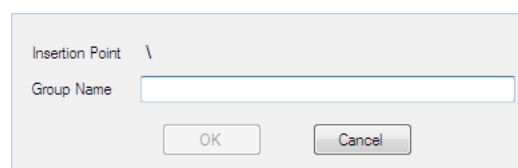

The image shows a dialog box with a light gray background. At the top left, there is a label 'Insertion Point' followed by a backslash symbol '\'. Below this, there is a label 'Group Name' followed by a white text input field. At the bottom of the dialog box, there are two buttons: 'OK' on the left and 'Cancel' on the right.

5. Press the **[OK]** button.
 - ⇒ The new group is added.

■ Changing the Group Name

1. Select the [Address Book] tab.
2. In the group list, select the group name to be changed.
3. Open the [Edit Group] dialog box in either of the following ways.
 - Select the [Address Book] menu → [Properties].
 - Press the [Properties] button on the toolbar.
4. Enter a [Group Name].
5. Press the [OK] button.
 - ⇒ The group name is changed.

■ Deleting a Group

ATTENTION

Note that deleting a group also deletes the sub-groups and e-mail addresses belonging to the group.

1. Select the [Address Book] tab.
2. In the group list, select a group to be deleted.
3. Perform either of following operations:
 - Select the [Address Book] menu → [Delete].
 - Press the [Delete] button on the toolbar.
 - ⇒ The delete confirmation window appears.
4. Press the [OK] button.
 - ⇒ The group is deleted.

F.6.2 Setting a Distribution List

Set distribution lists in the e-mail address book.

Multiple e-mail addresses can be registered in a distribution list.

By specifying a distribution list as an e-mail destination, an e-mail can be sent to all the e-mail addresses registered in the list at the same time.

■ Adding a Distribution List

1. Select the [Address Book] tab.
2. Select a group to which the new distribution list is to be added.
3. Open the [Add Distribution List] dialog box in either of the following ways.

- Select the [Address Book] menu → [Add Distribution List].
- Press the [Add Distribution List] button on the toolbar.

4. Enter the information of the distribution list to be added.

Enter the [Distribution List Name] and [Mail Addresses] to be contained in the distribution list.

Up to 64 characters can be specified for [Distribution List Name]. The following symbols cannot be used:

; @

For details about e-mail address settings values, refer to "[B.1 e-Mail Address Setting Values](#)" (page 402).

A distribution list can contain up to 100 e-mail addresses. Multiple e-mail addresses must be separated using semi-colons (";").

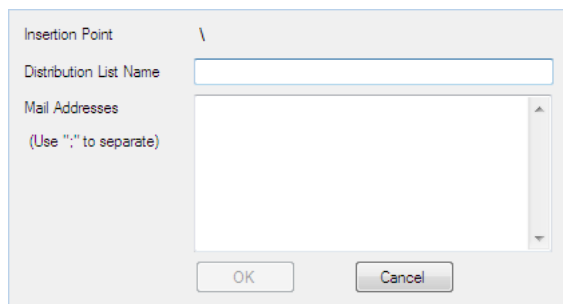

5. Press the [OK] button.
⇒ The distribution list is added.

■ Editing a Distribution List

1. Select the [Address Book] tab.
2. Select the distribution list to be edited.
3. Open the [Edit Address] dialog box in either of the following ways.
 - Select the [Address Book] menu → [Properties].
 - Press the [Properties] button on the toolbar.
4. Edit the information.
5. Press the [OK] button.
 - ⇒ The details of the distribution list are changed.

■ Deleting a Distribution Book List

1. Select the [Address Book] tab.
2. Select the distribution list to be deleted.
3. Perform either of following operations:
 - Select the [Address Book] menu → [Delete].
 - Press the [Delete] button on the toolbar.
 - ⇒ The delete confirmation window appears.
4. Press the [OK] button.
 - ⇒ The distribution list is deleted.

F.6.3 Setting an e-Mail Address

Set an e-mail address in the e-mail address book.

■ Adding an e-Mail Address

1. Select the [Address Book] tab.
2. Select a group to which the new address is to be added.
3. Open the [Add Address] dialog box in either of the following ways.
 - Select the [Address Book] menu → [Add Address].
 - Press the [Add Address] button on the toolbar.

4. Enter the information of the e-mail address to be added.

Up to 64 characters can be specified for [First Name] and [Last Name]. [First Name] and [Last Name] can be skipped.

For details about e-mail address settings values, refer to "[B.1 e-Mail Address Setting Values](#)" (page 402).

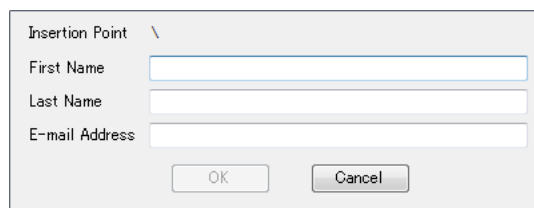

The image shows a dialog box titled "Insertion Point \". It contains three text input fields: "First Name", "Last Name", and "E-mail Address". Below the fields are two buttons: "OK" and "Cancel".

5. Press the [OK] button.

⇒ The e-mail address is added.

■ Editing an e-Mail Address

1. Select the **[Address Book]** tab.
2. Select the e-mail address to be edited.
3. Open the **[Edit Address]** dialog box in either of the following ways.
 - Select the **[Address Book]** menu → **[Properties]**.
 - Press the **[Properties]** button on the toolbar.
4. Edit the information.
5. Press the **[OK]** button.
 - ⇒ The information of the e-mail address is changed.

■ Deleting an e-Mail Address

1. Select the **[Address Book]** tab.
2. Select the e-mail address to be deleted.
3. Perform either of following operations:
 - Select the **[Address Book]** menu → **[Delete]**.
 - Press the **[Delete]** button on the toolbar.
 - ⇒ The delete confirmation window appears.
4. Press the **[OK]** button.
 - ⇒ The e-mail target is deleted from the e-mail address book.

F.7 Editing Local Accounts

This section describes how to edit the local accounts saved in the scanner. Up to 100 local accounts can be added.

F.7.1 Adding a Local Account

1. Select the **[Local Account]** tab.
2. Open the **[Add Account]** dialog box in either of the following ways.
 - Select the **[Local Account]** menu → **[Add Account]**.
 - Press the **[Add Account]** button on the toolbar.
3. Enter the information of the local account to be added.

- Up to 64 characters can be specified for **[User Name]**, **[Password]**, and **[Confirm Password]**. Passwords are case sensitive.
- For details about e-mail address settings values, refer to ["B.1 e-Mail Address Setting Values"](#) (page 402).
- For **[Comment]**, enter a comment on the account. Up to 256 characters can be entered. **[Comment]** is case sensitive.
- For **[Enabled/Disabled]**, select whether or not to enable the account. When **[Disabled]** is selected, the user cannot login.
- For **[Account Type]**, select **[Regular User]** for a regular user or select **[Administrator]** for the administrator.

ATTENTION

- The following user names cannot be used:
guest, admin, fi-maintenance, fi-maintenance-ad
- Spaces at the start and end of a user name are omitted if specified.
- White space characters can be used in a password and comment.

4. Press the **[OK]** button.
 - ⇒ The local account is added.

F.7.2 Editing a Local Account

1. **Select the [Local Account] tab.**
2. **Select a local account to be edited.**
3. **Open the [Edit Account] dialog box in either of the following ways.**
 - Select the [Local Account] menu → [Properties].
 - Press the [Properties] button on the toolbar.
4. **Edit the information.**
5. **Press the [OK] button.**
 - ⇒ The information of the local account is changed.

F.7.3 Deleting a Local Account

1. **Select the [Local Account] tab.**
2. **Select a local account to be deleted.**
3. **Perform either of following operations:**
 - Select the [Local Account] menu → [Delete].
 - Press the [Delete] button on the toolbar.
 - ⇒ The delete confirmation window appears.
4. **Press the [OK] button.**
 - ⇒ The local account is deleted.

F.8 Discarding the Edited e-Mail Address Book or Local Accounts

Discard the edited information of the e-mail address book or local accounts and restore it to its original state.

- 1. Select the [Address Book] tab to discard the edited information of the e-mail address book.
Select the [Local Account] tab to discard the edited information of the local account.**
- 2. Select the [File] menu → [Discard].**
⇒ A discard confirmation dialog box appears.
- 3. Press the [OK] button.**
⇒ The edited information is discarded and the e-mail address book or local account is restored to its original state.

F.9 Saving the e-Mail Address Book/Local Account

Save the edited e-mail address book or local account to the scanner.

■ Saving the Edited Information to the Scanner

Save the edited e-mail address book or local account to the scanner.

By saving the e-mail address book to the scanner, My List is updated with the changes.

1. **Select the [Address Book] tab to save e-mail address books.
Select the [Local Account] tab to save local accounts.**
2. **Perform either of following operations:**
 - Select the [File] menu → [Save to Scanner].
 - Press the [Save to Scanner] button on the toolbar.

⇒ The [Save to Scanner] dialog box appears.
3. **Enter the information to connect to the scanner.**

- Enter the scanner IP address, host name, or FQDN for [Connect to].
 - To enter an IP address, use the "xxx.xxx.xxx.xxx" format, where xxx is a value from 0 to 255.
 - For a host name or FQDN, up to 255 characters can be entered.
- For [Port Number], enter the number of the port to be used for communication with the scanner, within the range of 1 to 65535. The default value is "80".
Select the [Use HTTPS] check box to use HTTPS for communication from the scanner.
- For [User Name], enter the name of the user to login to the scanner.
- For [Password], enter the password for the user to login to the scanner.

HINT

Connect to the scanner as a user who can log in to it.

- To edit an e-mail address book, login as a regular user.
- To edit local accounts, login as an administrator.

4. **Press the [Save] button.**

⇒ e-Mail address books or local accounts are saved in the scanner.

■ Saving the Edited Information to a File

Save the edited e-mail address book or local accounts to a file in CSV format.

- 1. Select the [Address Book] tab to save e-mail address books.
Select the [Local Account] tab to save local accounts.**
- 2. Perform either of following operations:**
 - Select the [File] menu → [Save to File].
 - Press the [Save to File] button on the toolbar.

⇒ The dialog box for saving a file appears.
- 3. Specify the directory and name of the file, and press the [Save] button.**

⇒ e-Mail address books or local accounts are saved in CSV format.

F.10 User Editor Information Shown in User Log

In the administrator or regular user [User Log] window, user logs of User Editor can be viewed.

The user log items for User Editor are shown as follows:

| Log Item | Info Options | Description |
|-----------|--------------|--|
| Operation | Remote | The User Editor loaded an e-mail address book. Or, the User Editor updated an e-mail address book. |
| Pages | 0 | This item is always shown as 0. |

For checking other items and detailed information on user logs, refer to the following:

- When the administrator checks the information on the [User Log] window ["Viewing the User Log Details" \(page 162\)](#)
- When a regular user checks the information on the [User Log] window ["5.11.1 Viewing Details on Send Operations That Were Completed \(User Log\)" \(page 319\)](#)

F.11 User Editor Information Shown in System Log

In the administrator [System Log] window, system logs of User Editor can be viewed. The system log items for User Editor are shown as follows:

| Log Item | Info Options | Description |
|----------|--------------|--|
| Type | Information | The User Editor loaded local account information. Or, the User Editor updated local account information. |

For checking other items and detailed information on system logs, refer to ["Viewing the System Log Details"](#) (page 164).

Appendix G

IPv6 Settings

Admin

User

This appendix refers to the specifications for the IPv6 settings.

| | |
|--|------------|
| G.1 About IPv6 Support for the Scanner | 452 |
| G.2 Configuring IPv6 Settings for the Scanner | 453 |
| G.3 Configuring IPv6 Communication Environment | 457 |
| G.4 Using the Settings of the IPv6 Function for the Scanner in Other Scanners | 463 |

G.1 About IPv6 Support for the Scanner

For details about the IPv6 support for setting items, refer to "[G.2.2 Linked Server](#)" (page 454).

■ Software That Is Not Updated to Support IPv6

- User Editor

An IPv6 address is not supported.

Connect the computer to the scanner with an IPv4 address on the IPv4 network environment or IPv4/IPv6 dual-stack network environment.

- Central Admin Server/Central Admin Console

An IPv6 address is not supported.

Connect the computer to the scanner with an IPv4 address on an IPv4 network environment or an IPv4/IPv6 dual-stack network environment.

G.2 Configuring IPv6 Settings for the Scanner

G.2.1 Installing the IPv6 Function

Install the IPv6 function in the following procedure:

■ Enabling the IPv6 Function

1. **An administrator logs in to the scanner via the Admin Tool or the touch panel.**

For details, refer to ["4.2 Administrator Login" \(page 70\)](#).

2. **When using the touch panel, select [Advanced] for the setting mode on the [Admin Menu] window.**

For details, refer to ["4.3.1 Configuring the Setting Mode" \(page 75\)](#).

3. **On the [Network Advanced Settings] window under [Network Settings], set the IPv6 function to [On].**

For details, refer to ["4.7.8 Configuring Network Advanced Settings" \(page 107\)](#).

■ Configuring an IPv6 Communication Environment

1. **An administrator logs in to the scanner via the Admin Tool or the touch panel.**

For details, refer to ["4.2 Administrator Login" \(page 70\)](#).

2. **Configure the network settings.**

3. **After you have configured all items, press the [Logout] button.**

■ Using the Office Functions via IPv6

1. A regular user logs in to the scanner via the touch panel.

For details, refer to ["5.3 Logging in: Regular User Mode" \(page 226\)](#).

2. Specify a server that is configured for the IPv6 communication environment and perform a scan.

G.2.2 Linked Server

The following table shows whether or not the IPv6 address can be used for setting linked servers and for accessing the scanner when the IPv6 function is enabled.

| Item | | IPv4 Address | IPv6 Address | Remarks |
|------------------------|------------------------------|---------------|---------------|--|
| Administrator settings | IPv4 Address | Yes | Not supported | The [IP Address] window is switched to the [IPv4 Address] window. |
| | IPv6 Address | Not supported | Yes | The [IPv6 Address] window is added. |
| | DNS Server (IPv4) | Yes | Not supported | The [DNS Server] window is switched to the [DNS Server (IPv4)] window. |
| | DNS Server (IPv6) | Not supported | Yes | The [DNS Server (IPv6)] window is added. |
| | NTP Server | Yes | — | |
| | Proxy Server | Yes | Yes | |
| | SNMP Settings | Yes | — | |
| | Ping | Yes | Yes | |
| | Network Status | Yes | Yes | The information related to IPv6 is added. |
| | Scanner Central Admin Server | Yes | — | |
| | Login LDAP Server | Yes | Yes | |
| | e-Mail LDAP Server | Yes | Yes | |
| SMTP Server | Yes | Yes | | |

| Item | | IPv4 Address | IPv6 Address | Remarks |
|------------------------|---|--------------|--------------|--|
| Administrator settings | FAX Server | Yes | Yes | The full domain name that corresponds to IPv6 can be specified subsequent to @ in the e-mail address for the FAX server. Note that an IPv6 address cannot be specified subsequent to @ in the e-mail address. |
| | Network Folder | Yes | Yes | An IPv6 address can be specified if it is entered directly. |
| | FTP Server Folder | Yes | Yes | An IPv6 address can be specified in the path of the FTP server folder. |
| | SharePoint Folder | Yes | Yes | An IPv6 address can be specified in the URL. |
| | Network Printer | Yes | Yes | An IPv6 address can be specified if it is entered directly. |
| | Alert Notification | Yes | Yes | The full domain name that corresponds to IPv6 can be specified subsequent to @ in the e-mail address. Note that an IPv6 address cannot be specified subsequent to @ in the e-mail address. |
| Admin Tool | Login window | Yes | Yes | |
| User Editor | Login window | Yes | — | |
| Internet Explorer | Login window that is used to connect the computer to N7100E | Yes | Yes | |

Yes: Can be used. —: Cannot be used.

G.2.3 Port Number List

| Function | From/To | Port Number | Protocol Number |
|--------------------------------------|--------------------------------------|--------------|-----------------|
| DHCP (Address Auto-configuration) | Scanner ⇌ DHCP server | 546 (DHCPv6) | 17 (UDP) |
| Ping | Scanner ⇌ Another computer or server | None | 58 (IPv6-ICMP) |

G.3 Configuring IPv6 Communication Environment

If you set [IPv6 Function] to [On] on the window that is displayed when [Network Advanced Settings] under [Network Settings] is selected, the menu that is displayed on the window is switched to the menu that supports the enabled IPv6 function so that the settings related to IPv6 can be specified.

This section describes the windows with the setting items that are changed when the IPv6 function is enabled.

- ["G.3.1 Giving the Scanner an IPv4 Address" \(page 457\)](#)
- ["G.3.2 Giving the Scanner an IPv6 Address" \(page 458\)](#)
- ["G.3.3 Setting the DNS Server \(IPv4\)" \(page 460\)](#)
- ["G.3.4 Setting the DNS Server \(IPv6\)" \(page 461\)](#)
- ["G.3.5 Checking the Network Operating Status" \(page 462\)](#)

G.3.1 Giving the Scanner an IPv4 Address Touch Panel Admin Tool

An IPv4 address must be set in order to connect the scanner to a network.

1. Select [IPv4 Address] under [Network Settings].

⇒ The [IPv4 Address] window appears.

2. Specify each item.

3. Press the [OK] button.

⇒ The information entered is set.

HINT

- If the IP address is the same as one already in use, network communication problems will occur. In this case, try the following steps:
 1. Disconnect the LAN cable.
 2. Press the [Shutdown] button on the touch panel to turn the scanner off.
 3. Press the power button to start the scanner with the LAN cable disconnected.
 4. Enter a non-duplicated IP address.
 5. Re-connect the LAN cable to the scanner.
- The connection with the scanner is lost if the IP address is changed via the Admin Tool. To continue with other settings, close the Admin Tool and then access the scanner via the Admin Tool again. If you access the scanner with an IP address, use the new IP address.

G.3.2 Giving the Scanner an IPv6 Address Touch Panel Admin Tool

An IPv6 address must be set in order to connect the scanner to a network.

1. Select [IPv6 Address] under [Network Settings].

⇒ The [IPv6 Address] window appears.

The screenshot shows the 'Network Settings > IPv6 Address' configuration window. The sidebar on the left lists various network settings, with 'IPv6 Address' highlighted. The main content area is titled 'Enter the IPv6 addresses.' and contains the following fields:

- Configuration Method:** A dropdown menu set to 'Auto'.
- RA reception:** A dropdown menu set to 'On'.
- IP Address:** An empty text input field.
- Subnet prefix length:** A text input field containing the value '64'.
- Default Gateway:** An empty text input field.

At the bottom of the window, there is a 'Logout' button on the left and an 'OK' button on the right.

2. Specify each item.

3. Press the [OK] button.

⇒ The information entered is set.

HINT

- If the IP address is the same as one already in use, network communication problems will occur. In this case, try the following steps:
 1. Disconnect the LAN cable.
 2. Press the [Shutdown] button on the touch panel to turn the scanner off.
 3. Press the power button to start the scanner with the LAN cable disconnected.
 4. Enter a non-duplicated IP address.
 5. Re-connect the LAN cable to the scanner.
- The connection with the scanner is lost if the IP address is changed via the Admin Tool. To continue with other settings, close the Admin Tool and then access the scanner via the Admin Tool again. If you access the scanner with an IP address, use the new IP address.
- The information that is distributed when [Auto] is selected for the IPv6 address configuration method, or when [Manual] is selected for the IPv6 configuration method and [On] is selected for the RA reception is as follows:
 - DHCP
 - IP Address
 - DNS
 - DNS Suffix
 - RA
 - Subnet prefix length
 - Default Gateway

G.3.3 Setting the DNS Server (IPv4) Touch Panel AdminTool

A primary DNS and secondary DNS can be set.

1. Select [DNS Server (IPv4)] under [Network Settings].

⇒ The [DNS Server (IPv4)] window appears.

The screenshot shows the 'DNS Server (IPv4)' configuration window. The title bar reads 'Network Settings > DNS Server (IPv4)'. On the left is a sidebar menu with options: Network Settings, IPv4 Address, IPv6 Address, DNS Server (IPv4) (highlighted), DNS Server (IPv6), WINS Server, NTP Server, Proxy Server, SNMP Settings, and SMB 1.0/CIFS. The main area contains the following settings:

- Primary DNS: 0 . 0 . 0 . 0
- Secondary DNS: 0 . 0 . 0 . 0
- DNS Dynamic Update: Off
- DNS Suffix: (empty text box)
- FQDN: (empty text box)
- Priority Setting: IPv4 (dropdown menu)

At the bottom right, there is a blue 'OK' button. At the bottom left, there is a 'Logout' button.

2. Specify each item.

3. Press the [OK] button.

⇒ The information entered is set.

G.3.4 Setting the DNS Server (IPv6) Touch Panel AdminTool

A primary DNS and secondary DNS can be set.

1. Select [DNS Server (IPv6)] under [Network Settings].

⇒ The [DNS Server (IPv6)] window appears.

The screenshot displays the 'DNS Server (IPv6)' configuration window. On the left is a sidebar menu with 'DNS Server (IPv6)' selected. The main area contains the following fields and controls:

- Primary DNS:** An empty text input field.
- Secondary DNS:** An empty text input field.
- DNS Dynamic Update:** A toggle switch currently set to 'Off'.
- DNS Suffix:** An empty text input field.
- FQDN:** A text input field containing the placeholder text 'EXAMPLE.COMPT'.
- Priority Setting:** A dropdown menu currently set to 'IPv4'.

At the bottom of the window, there is a 'Logout' button on the left and an 'OK' button on the right.

2. Specify each item.

3. Press the [OK] button.

⇒ The information entered is set.

G.3.5 Checking the Network Operating Status Touch Panel AdminTool

The operating status of the network can be checked.

If the information is not shown, the network may not be operating normally. Refer to "7.2 Network Connection Troubleshooting" (page 364), and check the settings.

1. Select [Network Status] under [Check Network Status].

⇒ The [Network Status] window shows the status of the currently operating network connection.

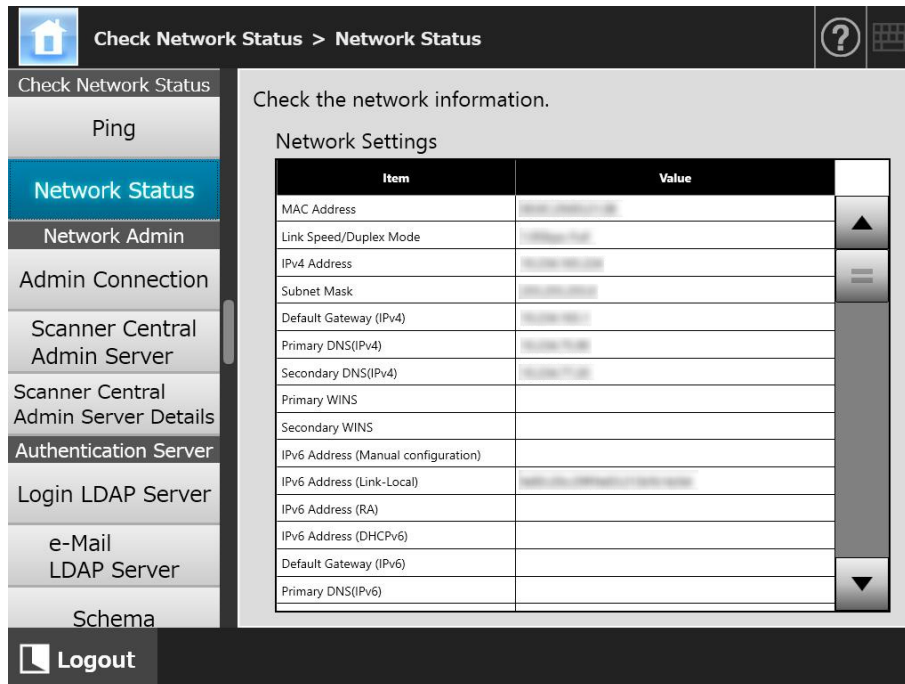

HINT

- If connection to LDAP server is not possible, try the following steps:
 1. Disconnect the LAN cable.
 2. Press the [Shutdown] button on the touch panel to turn the scanner off.
 3. Press the power button to start the scanner with the LAN cable disconnected.
 4. Enter a non-duplicated IP address.
 5. Re-connect the LAN cable to the scanner.
- Depending on the IP address configuration method, the network settings that are displayed when connection to the DHCP server is not possible vary as follows:
 - When [DHCP] is selected for the IPv4 address configuration method, "169.254.X.X" is displayed for the IPv4 address (X can be any number from 0 to 255).
 - When [Auto] is selected for the IPv6 address configuration method, or when [Manual] is selected for the IPv6 configuration method and [On] is selected for the RA reception, nothing is displayed in [Value] for the IPv6 address (DHCPv6). When there is no RA, nothing is displayed in [Value] for the IPv6 address (RA).

G.4 Using the Settings of the IPv6 Function for the Scanner in Other Scanners

G.4.1 Distributing System Settings from the Central Admin Server

The following table shows the status of each setting item when system settings are distributed from the Central Admin Server to N7100E.

| | N7100E |
|---------------------|---------------|
| IPv6 Function | — |
| DNS Server (IPv4) | Yes |
| DNS Server (IPv6) | — |
| Other Setting Items | Yes(*) |

Yes: Applied —: Not applied

(*): An IPv6 address can not be specified directly. Configure the settings with a host name or FQDN.

G.4.2 Backing-up and Restoring System Settings

The following tables show whether or not the backed-up system settings of a scanner that is not updated to support IPv6 (N7100 (lower than 01.07.01), N1800, or fi-6010N) are restored to N7100E.

| Backed-up Data | N7100/N1800/fi-6010N Not Updated to Support IPv6 | |
|---------------------|--|------------------------|
| | N7100E | |
| Restored to | IPv6 Function Enabled | IPv6 Function Disabled |
| IPv6 Function | Disabled | Disabled |
| IP Address (IPv4) | Yes | Yes |
| IP Address (IPv6) | — | — |
| DNS Server (IPv4) | Yes | Yes |
| DNS Server (IPv6) | — | — |
| Other Setting Items | Yes | Yes |

Yes: Restorable —: Not Restorable

ATTENTION

The backed-up system settings of N7100E cannot be restored to N7100, N1800, or fi-6010N.

Glossary

ADF (Automatic Document Feeder)

A unit that allows the user to scan a number of pages consecutively. Documents are transported from the ADF paper chute past the scanning area to the stacker. Actual scanning is performed by the CCD sensors inside of this unit.

Brake roller

A roller that separates each sheet of documents loaded in the ADF paper chute.

Brightness

The brightness level of a scanned image.

Carrier Sheet

A Carrier Sheet is a plastic sheet specifically used for loading non-standard documents onto the scanner.

Document Sensor

Paper feeding errors such as multifeed and paper jam are detected by monitoring the passing of documents.

Duplex scan mode

A scan mode where both sides of each document sheet are scanned. See also "Simplex scan mode".

Eject roller

Rollers that feed documents in the ADF to the stacker.

Feed roller

Rollers that feed documents through the ADF.

Gamma

A unit which indicates the changes in the brightness of an image. It is expressed as a function of the electric input power to devices (e.g. scanner, display) and the brightness of the image. If the gamma rate is larger than 1, the brightness of an image increases and vice versa. Normally, the gamma rate is set to 1 when reproducing the same brightness as the original.

Idler roller

Rollers that feed documents through the ADF.

Interface

The connection that allows communication from the computer to the scanner.

Landscape orientation

A document with its long side horizontal and its short side vertical.

MMR

ITU-T (CCITT) T.6 compression.

A compression method used when the image mode is set to [Black & White] on the scan settings window.

Moire

Recurrent patterns on scanned images that can occur when documents that have regular alternation in shading such as a document with a lattice pattern are scanned.

Multifeed detection

A scanner function which detects accidental feeding of multiple sheets into the ADF.

Noise

Isolated white (black) dots appearing on black (white) areas of an image.

Paper jam

A warning that appears when a document sheet is jammed in the document feed path, or document feeding is interrupted by a slipping sheet.

Pick roller

A set of rollers which guide documents from the ADF paper chute to the stacker.

Portrait orientation

A document with its long side vertical and its short side horizontal.

Simplex scan mode

A scan mode where only one side of each document sheet is scanned. See also "Duplex scan mode".

Threshold

The value which is used to determine whether a certain color is black or white. Threshold value must be configured in order to scan images with grayscale gradation. Each pixel is converted into black or white according to the specified value.

Ultrasonic sensor

A type of sensor that uses ultrasonic sound waves, in this case to detect document multifeeds by recognizing differences in how the sound penetrates single versus multiple sheets.

About Maintenance

Contact your FUJITSU scanner dealer or an authorized FUJITSU scanner service provider for repairs to this product.

For more details, refer to the following web page:

<https://www.fujitsu.com/global/about/resources/shop/computing/peripheral/scanners/index.html>

ATTENTION

For safety reasons, never attempt repairs by yourself.

Copyright

WinPcap

Copyright© 1999 - 2005 NetGroup, Politecnico di Torino (Italy).
Copyright© 2005 - 2010 CACE Technologies, Davis (California).
Copyright© 2010 - 2013 Riverbed Technology, San Francisco (California).
All rights reserved.

Redistribution and use in source and binary forms, with or without modification, are permitted provided that the following conditions are met:

- 1) Redistributions of source code must retain the above copyright notice, this list of conditions and the following disclaimer.
- 2) Redistributions in binary form must reproduce the above copyright notice, this list of conditions and the following disclaimer in the documentation and/or other materials provided with the distribution.
- 3) Neither the name of the Politecnico di Torino, CACE Technologies, Riverbed Technology nor the names of their contributors may be used to endorse or promote products derived from this software without specific prior written permission.

THIS SOFTWARE IS PROVIDED BY THE COPYRIGHT HOLDERS AND CONTRIBUTORS "AS IS" AND ANY EXPRESS OR IMPLIED WARRANTIES, INCLUDING, BUT NOT LIMITED TO, THE IMPLIED WARRANTIES OF MERCHANTABILITY AND FITNESS FOR A PARTICULAR PURPOSE ARE DISCLAIMED. IN NO EVENT SHALL THE COPYRIGHT OWNER OR CONTRIBUTORS BE LIABLE FOR ANY DIRECT, INDIRECT, INCIDENTAL, SPECIAL, EXEMPLARY, OR CONSEQUENTIAL DAMAGES (INCLUDING, BUT NOT LIMITED TO, PROCUREMENT OF SUBSTITUTE GOODS OR SERVICES; LOSS OF USE, DATA, OR PROFITS; OR BUSINESS INTERRUPTION) HOWEVER CAUSED AND ON ANY THEORY OF LIABILITY, WHETHER IN CONTRACT, STRICT LIABILITY, OR TORT (INCLUDING NEGLIGENCE OR OTHERWISE) ARISING IN ANY WAY OUT OF THE USE OF THIS SOFTWARE, EVEN IF ADVISED OF THE POSSIBILITY OF SUCH DAMAGE.

This product includes software developed by the University of California, Lawrence Berkeley Laboratory and its contributors.

This product includes software developed by the Kungliga Tekniska Högskolan and its contributors.

This product includes software developed by Yen Yen Lim and North Dakota State University.

Portions Copyright© 1990, 1991, 1992, 1993, 1994, 1995, 1996, 1997 The Regents of the University of California.

All rights reserved.

Redistribution and use in source and binary forms, with or without modification, are permitted provided that the following conditions are met:

- 1) Redistributions of source code must retain the above copyright notice, this list of conditions and the following disclaimer.

- 2) Redistributions in binary form must reproduce the above copyright notice, this list of conditions and the following disclaimer in the documentation and/or other materials provided with the distribution.
- 3) All advertising materials mentioning features or use of this software must display the following acknowledgement: "This product includes software developed by the University of California, Berkeley and its contributors."
- 4) Neither the name of the University nor the names of its contributors may be used to endorse or promote products derived from this software without specific prior written permission.

THIS SOFTWARE IS PROVIDED BY THE INSTITUTE AND CONTRIBUTORS "AS IS" AND ANY EXPRESS OR IMPLIED WARRANTIES, INCLUDING, BUT NOT LIMITED TO, THE IMPLIED WARRANTIES OF MERCHANTABILITY AND FITNESS FOR A PARTICULAR PURPOSE ARE DISCLAIMED. IN NO EVENT SHALL THE REGENTS OR CONTRIBUTORS BE LIABLE FOR ANY DIRECT, INDIRECT, INCIDENTAL, SPECIAL, EXEMPLARY, OR CONSEQUENTIAL DAMAGES (INCLUDING, BUT NOT LIMITED TO, PROCUREMENT OF SUBSTITUTE GOODS OR SERVICES; LOSS OF USE, DATA, OR PROFITS; OR BUSINESS INTERRUPTION) HOWEVER CAUSED AND ON ANY THEORY OF LIABILITY, WHETHER IN CONTRACT, STRICT LIABILITY, OR TORT (INCLUDING NEGLIGENCE OR OTHERWISE) ARISING IN ANY WAY OUT OF THE USE OF THIS SOFTWARE, EVEN IF ADVISED OF THE POSSIBILITY OF SUCH DAMAGE.

Portions Copyright© 1983 Regents of the University of California.
All rights reserved.

Redistribution and use in source and binary forms are permitted provided that the above copyright notice and this paragraph are duplicated in all such forms and that any documentation, advertising materials, and other materials related to such distribution and use acknowledge that the software was developed by the University of California, Berkeley. The name of the University may not be used to endorse or promote products derived from this software without specific prior written permission.

THIS SOFTWARE IS PROVIDED "AS IS" AND WITHOUT ANY EXPRESS OR IMPLIED WARRANTIES, INCLUDING, WITHOUT LIMITATION, THE IMPLIED WARRANTIES OF MERCHANTABILITY AND FITNESS FOR A PARTICULAR PURPOSE.

Portions Copyright© 1995, 1996, 1997 Kungliga Tekniska Högskolan (Royal Institute of Technology, Stockholm, Sweden).
All rights reserved.

Redistribution and use in source and binary forms, with or without modification, are permitted provided that the following conditions are met:

- 1) Redistributions of source code must retain the above copyright notice, this list of conditions and the following disclaimer.
- 2) Redistributions in binary form must reproduce the above copyright notice, this list of conditions and the following disclaimer in the documentation and/or other materials provided with the distribution.

- 3) All advertising materials mentioning features or use of this software must display the following acknowledgement: "This product includes software developed by the Kungliga Tekniska Högskolan and its contributors."
- 4) Neither the name of the University nor the names of its contributors may be used to endorse or promote products derived from this software without specific prior written permission.

THIS SOFTWARE IS PROVIDED BY THE INSTITUTE AND CONTRIBUTORS "AS IS" AND ANY EXPRESS OR IMPLIED WARRANTIES, INCLUDING, BUT NOT LIMITED TO, THE IMPLIED WARRANTIES OF MERCHANTABILITY AND FITNESS FOR A PARTICULAR PURPOSE ARE DISCLAIMED. IN NO EVENT SHALL THE INSTITUTE OR CONTRIBUTORS BE LIABLE FOR ANY DIRECT, INDIRECT, INCIDENTAL, SPECIAL, EXEMPLARY, OR CONSEQUENTIAL DAMAGES (INCLUDING, BUT NOT LIMITED TO, PROCUREMENT OF SUBSTITUTE GOODS OR SERVICES; LOSS OF USE, DATA, OR PROFITS; OR BUSINESS INTERRUPTION) HOWEVER CAUSED AND ON ANY THEORY OF LIABILITY, WHETHER IN CONTRACT, STRICT LIABILITY, OR TORT (INCLUDING NEGLIGENCE OR OTHERWISE) ARISING IN ANY WAY OUT OF THE USE OF THIS SOFTWARE, EVEN IF ADVISED OF THE POSSIBILITY OF SUCH DAMAGE.

Portions Copyright© 1997 Yen Yen Lim and North Dakota State University.
All rights reserved.

Redistribution and use in source and binary forms, with or without modification, are permitted provided that the following conditions are met:

- 1) Redistributions of source code must retain the above copyright notice, this list of conditions and the following disclaimer.
- 2) Redistributions in binary form must reproduce the above copyright notice, this list of conditions and the following disclaimer in the documentation and/or other materials provided with the distribution.
- 3) All advertising materials mentioning features or use of this software must display the following acknowledgement: "This product includes software developed by Yen Yen Lim and North Dakota State University"
- 4) The name of the author may not be used to endorse or promote products derived from this software without specific prior written permission.

THIS SOFTWARE IS PROVIDED BY THE AUTHOR "AS IS" AND ANY EXPRESS OR IMPLIED WARRANTIES, INCLUDING, BUT NOT LIMITED TO, THE IMPLIED WARRANTIES OF MERCHANTABILITY AND FITNESS FOR A PARTICULAR PURPOSE ARE DISCLAIMED. IN NO EVENT SHALL THE AUTHOR BE LIABLE FOR ANY DIRECT, INDIRECT, INCIDENTAL, SPECIAL, EXEMPLARY, OR CONSEQUENTIAL DAMAGES (INCLUDING, BUT NOT LIMITED TO, PROCUREMENT OF SUBSTITUTE GOODS OR SERVICES; LOSS OF USE, DATA, OR PROFITS; OR BUSINESS INTERRUPTION) HOWEVER CAUSED AND ON ANY THEORY OF LIABILITY, WHETHER IN CONTRACT, STRICT LIABILITY, OR TORT (INCLUDING NEGLIGENCE OR OTHERWISE) ARISING IN ANY WAY OUT OF THE USE OF THIS SOFTWARE, EVEN IF ADVISED OF THE POSSIBILITY OF SUCH DAMAGE.

Portions Copyright© 1993 by Digital Equipment Corporation.

Permission to use, copy, modify, and distribute this software for any purpose with or without fee is hereby granted, provided that the above copyright notice and this permission notice appear in all copies, and that the name of Digital Equipment Corporation not be used in advertising or publicity pertaining to distribution of the document or software without specific, written prior permission.

THE SOFTWARE IS PROVIDED "AS IS" AND DIGITAL EQUIPMENT CORP. DISCLAIMS ALL WARRANTIES WITH REGARD TO THIS SOFTWARE, INCLUDING ALL IMPLIED WARRANTIES OF MERCHANTABILITY AND FITNESS. IN NO EVENT SHALL DIGITAL EQUIPMENT CORPORATION BE LIABLE FOR ANY SPECIAL, DIRECT, INDIRECT, OR CONSEQUENTIAL DAMAGES OR ANY DAMAGES WHATSOEVER RESULTING FROM LOSS OF USE, DATA OR PROFITS, WHETHER IN AN ACTION OF CONTRACT, NEGLIGENCE OR OTHER TORTIOUS ACTION, ARISING OUT OF OR IN CONNECTION WITH THE USE OR PERFORMANCE OF THIS SOFTWARE.

Portions Copyright© 1995, 1996, 1997, 1998, and 1999 WIDE Project.
All rights reserved.

Redistribution and use in source and binary forms, with or without modification, are permitted provided that the following conditions are met:

- 1) Redistributions of source code must retain the above copyright notice, this list of conditions and the following disclaimer.
- 2) Redistributions in binary form must reproduce the above copyright notice, this list of conditions and the following disclaimer in the documentation and/or other materials provided with the distribution.
- 3) Neither the name of the project nor the names of its contributors may be used to endorse or promote products derived from this software without specific prior written permission.

THIS SOFTWARE IS PROVIDED BY THE PROJECT AND CONTRIBUTORS "AS IS" AND ANY EXPRESS OR IMPLIED WARRANTIES, INCLUDING, BUT NOT LIMITED TO, THE IMPLIED WARRANTIES OF MERCHANTABILITY AND FITNESS FOR A PARTICULAR PURPOSE ARE DISCLAIMED. IN NO EVENT SHALL THE PROJECT OR CONTRIBUTORS BE LIABLE FOR ANY DIRECT, INDIRECT, INCIDENTAL, SPECIAL, EXEMPLARY, OR CONSEQUENTIAL DAMAGES (INCLUDING, BUT NOT LIMITED TO, PROCUREMENT OF SUBSTITUTE GOODS OR SERVICES; LOSS OF USE, DATA, OR PROFITS; OR BUSINESS INTERRUPTION) HOWEVER CAUSED AND ON ANY THEORY OF LIABILITY, WHETHER IN CONTRACT, STRICT LIABILITY, OR TORT (INCLUDING NEGLIGENCE OR OTHERWISE) ARISING IN ANY WAY OUT OF THE USE OF THIS SOFTWARE, EVEN IF ADVISED OF THE POSSIBILITY OF SUCH DAMAGE.

Portions Copyright© 1996 Juniper Networks, Inc. All rights reserved.

Redistribution and use in source and binary forms, with or without modification, are permitted provided that: (1) source code distributions retain the above copyright notice and this paragraph in its entirety, (2) distributions including binary code include the above copyright notice and this paragraph in its entirety in the documentation or other materials provided with the distribution.

The name of Juniper Networks may not be used to endorse or promote products derived from this software without specific prior written permission.

THIS SOFTWARE IS PROVIDED "AS IS" AND WITHOUT ANY EXPRESS OR IMPLIED WARRANTIES, INCLUDING, WITHOUT LIMITATION, THE IMPLIED WARRANTIES OF MERCHANTABILITY AND FITNESS FOR A PARTICULAR PURPOSE.

Portions Copyright© 2001 Daniel Hartmeier
All rights reserved.

Redistribution and use in source and binary forms, with or without modification, are permitted provided that the following conditions are met:

- Redistributions of source code must retain the above copyright notice, this list of conditions and the following disclaimer.
- Redistributions in binary form must reproduce the above copyright notice, this list of conditions and the following disclaimer in the documentation and/or other materials provided with the distribution.

THIS SOFTWARE IS PROVIDED BY THE COPYRIGHT HOLDERS AND CONTRIBUTOR "AS IS" AND ANY EXPRESS OR IMPLIED WARRANTIES, INCLUDING, BUT NOT LIMITED TO, THE IMPLIED WARRANTIES OF MERCHANTABILITY AND FITNESS FOR A PARTICULAR PURPOSE ARE DISCLAIMED. IN NO EVENT SHALL THE COPYRIGHT HOLDERS OR CONTRIBUTORS BE LIABLE FOR ANY DIRECT, INDIRECT, INCIDENTAL, SPECIAL, EXEMPLARY, OR CONSEQUENTIAL DAMAGES (INCLUDING, BUT NOT LIMITED TO, PROCUREMENT OF SUBSTITUTE GOODS OR SERVICES; LOSS OF USE, DATA, OR PROFITS; OR BUSINESS INTERRUPTION) HOWEVER CAUSED AND ON ANY THEORY OF LIABILITY, WHETHER IN CONTRACT, STRICT LIABILITY, OR TORT (INCLUDING NEGLIGENCE OR OTHERWISE) ARISING IN ANY WAY OUT OF THE USE OF THIS SOFTWARE, EVEN IF ADVISED OF THE POSSIBILITY OF SUCH DAMAGE.

Portions Copyright 1989 by Carnegie Mellon.

Permission to use, copy, modify, and distribute this program for any purpose and without fee is hereby granted, provided that this copyright and permission notice appear on all copies and supporting documentation, the name of Carnegie Mellon not be used in advertising or publicity pertaining to distribution of the program without specific prior permission, and notice be given in supporting documentation that copying and distribution is by permission of Carnegie Mellon and Stanford University. Carnegie Mellon makes no representations about the suitability of this software for any purpose. It is provided "as is" without express or implied warranty.

WinDump

Copyright© 1999 - 2005 NetGroup, Politecnico di Torino (Italy).
Copyright© 2005 - 2006 CACE Technologies, Davis (California).
All rights reserved.

Redistribution and use in source and binary forms, with or without modification, are permitted provided that the following conditions are met:

- 1) Redistributions of source code must retain the above copyright notice, this list of conditions and the following disclaimer.
- 2) Redistributions in binary form must reproduce the above copyright notice, this list of conditions and the following disclaimer in the documentation and/or other materials provided with the distribution.
- 3) Neither the name of the Politecnico di Torino, CACE Technologies nor the names of its contributors may be used to endorse or promote products derived from this software without specific prior written permission.

THIS SOFTWARE IS PROVIDED BY THE COPYRIGHT HOLDERS AND CONTRIBUTORS "AS IS" AND ANY EXPRESS OR IMPLIED WARRANTIES, INCLUDING, BUT NOT LIMITED TO, THE IMPLIED WARRANTIES OF MERCHANTABILITY AND FITNESS FOR A PARTICULAR PURPOSE ARE DISCLAIMED. IN NO EVENT SHALL THE COPYRIGHT OWNER OR CONTRIBUTORS BE LIABLE FOR ANY DIRECT, INDIRECT, INCIDENTAL, SPECIAL, EXEMPLARY, OR CONSEQUENTIAL DAMAGES (INCLUDING, BUT NOT LIMITED TO, PROCUREMENT OF SUBSTITUTE GOODS OR SERVICES; LOSS OF USE, DATA, OR PROFITS; OR BUSINESS INTERRUPTION) HOWEVER CAUSED AND ON ANY THEORY OF LIABILITY, WHETHER IN CONTRACT, STRICT LIABILITY, OR TORT (INCLUDING NEGLIGENCE OR OTHERWISE) ARISING IN ANY WAY OUT OF THE USE OF THIS SOFTWARE, EVEN IF ADVISED OF THE POSSIBILITY OF SUCH DAMAGE.

This product includes software developed by the University of California, Lawrence Berkeley Laboratory and its contributors.

Secure iNetSuite

Copyright© 2008-2013 Dart Communications

OpenCV/OpenCvSharp

Copyright (c) 2017, shimat
All rights reserved.

Redistribution and use in source and binary forms, with or without modification, are permitted provided that the following conditions are met:

- 1) Redistributions of source code must retain the above copyright notice, this list of conditions and the following disclaimer.
- 2) Redistributions in binary form must reproduce the above copyright notice, this list of conditions and the following disclaimer in the documentation and/or other materials provided with the distribution.

- 3) Neither the name of the copyright holder nor the names of its contributors may be used to endorse or promote products derived from this software without specific prior written permission.

THIS SOFTWARE IS PROVIDED BY THE COPYRIGHT HOLDERS AND CONTRIBUTORS "AS IS" AND ANY EXPRESS OR IMPLIED WARRANTIES, INCLUDING, BUT NOT LIMITED TO, THE IMPLIED WARRANTIES OF MERCHANTABILITY AND FITNESS FOR A PARTICULAR PURPOSE ARE DISCLAIMED. IN NO EVENT SHALL THE COPYRIGHT HOLDER OR CONTRIBUTORS BE LIABLE FOR ANY DIRECT, INDIRECT, INCIDENTAL, SPECIAL, EXEMPLARY, OR CONSEQUENTIAL DAMAGES (INCLUDING, BUT NOT LIMITED TO, PROCUREMENT OF SUBSTITUTE GOODS OR SERVICES; LOSS OF USE, DATA, OR PROFITS; OR BUSINESS INTERRUPTION) HOWEVER CAUSED AND ON ANY THEORY OF LIABILITY, WHETHER IN CONTRACT, STRICT LIABILITY, OR TORT (INCLUDING NEGLIGENCE OR OTHERWISE) ARISING IN ANY WAY OUT OF THE USE OF THIS SOFTWARE, EVEN IF ADVISED OF THE POSSIBILITY OF SUCH DAMAGE.

Index

A

| | |
|--|-----|
| Add-in | 178 |
| adding e-mail address | 236 |
| adding fax number | 247 |
| adding job group | 206 |
| adding job menu | 201 |
| adding job sequence | 191 |
| adding scanned data | 317 |
| ADF paper chute | 26 |
| admin connection | 110 |
| Admin Tool | 24 |
| administrator | 29 |
| administrator right | 29 |
| advanced mode | 23 |
| area not to be affixed with other papers | 398 |
| area not to be perforated | 398 |
| assigning job menu to users not included in job group | 211 |
| assisted scan | 313 |
| automatic logout | 95 |

B

| | |
|----------------------------------|--------------|
| backing up system settings | 171 |
| backing up the user data | 168 |
| barcode | 421 |
| basic mode | 23 |
| basic specification | 416 |
| brake roller | 28, 341, 346 |

C

| | |
|--|---------|
| calibrate screen | 359 |
| carbonless paper | 396 |
| care | 335 |
| carrier sheet settings | 279 |
| Central Admin Console | 24 |
| certificate management | 84 |
| changing FTP server folder settings | 138 |
| changing network printer settings | 157 |
| changing password | 97, 334 |
| changing SharePoint folder settings | 142 |
| changing the image mode of scanned data | 315 |
| checking new updates | 176 |
| checking number of sheets to be scanned | 329 |
| checking the network status (IPv4) | 109 |
| checking the network status (IPv6) | 462 |
| cleaning | 336 |
| cleaning frequency | 337 |
| cleaning supply | 336 |
| cleaning (Carrier Sheet) | 345 |
| cleaning (exterior of scanner) | 338 |
| cleaning (inside of scanner) | 339 |
| cleaning (touch panel) | 338 |
| clearing system log | 165 |
| clearing user data | 169 |
| clearing user logs | 163 |
| cloning job group | 209 |
| cloning job menu | 204 |

| | |
|---|-----|
| cloning job sequence | 197 |
| compatibility | 406 |
| compression | 280 |
| compression setting | 288 |
| configuring network advanced settings ... | 107 |
| configuring setting mode | 75 |
| configuring settings for sending e-mail ... | 127 |
| configuring SMB 1.0/CIFS settings | 106 |
| configuring SNMP settings | 105 |
| configuring the settings using the Installation Wizard | 76 |
| connectivity | 411 |
| consumable alert status | 347 |
| Control Image Tone | 291 |
| corresponding MIB | 424 |
| cover release catch | 26 |
| custom | 264 |

D

| | |
|--|----------|
| default settings | 264 |
| deleting a separator | 317 |
| deleting fax number | 250 |
| deleting job group | 210 |
| deleting job menu | 205 |
| deleting job sequence | 198 |
| deleting scanned data | 313 |
| detecting multifeeds | 301 |
| DHCP server | 45 |
| discarding the edited e-mail address book | 446 |
| display size of scanned data | 312, 315 |
| DNS server | 45 |
| document loading capacity | 397 |
| downloading system log | 165 |

| | |
|--|-----|
| downloading system settings in CSV format | 170 |
| downloading user log | 163 |
| Dropout Color | 295 |

E

| | |
|-------------------------------------|--------------------|
| Edge Correction | 298 |
| editing a separator | 316 |
| editing e-mail address book | 240 |
| editing fax number list | 249 |
| editing job group | 209 |
| editing job menu | 204 |
| editing job sequence | 197 |
| editing marked characters | 318 |
| eject roller | 342 |
| e-mail address book | 232, 236, 240, 242 |
| e-mail address setting values | 402 |
| exiting User Editor | 434 |
| extension | 26 |

F

| | |
|--|---------------|
| fax number list | 245, 247, 250 |
| fax server | 45 |
| features | 22 |
| feed roller | 342 |
| file format setting | 280 |
| file name (for save/e-mail attachment) ... | 328 |
| file server | 44 |
| filtering job sequence | 198 |
| filtering the LDAP List | 199, 212 |
| folder list | 261 |
| FTP server | 44 |
| FTPS server | 44 |
| function list | 417 |

| | |
|---|---------|
| G | |
| general scanner settings | 89 |
| getting screenshot on touch panel | 185 |
| giving the scanner an IPv4 address | 99, 457 |
| giving the scanner an IPv6 address | 458 |
| glass | 342 |
| glossary | 465 |

| | |
|--|-----|
| I | |
| idler roller | 342 |
| index information output | 302 |
| installation specification | 415 |
| installing the IPv6 function | 453 |
| installing (Add-in) | 178 |
| installing (Admin Tool) | 62 |
| installing (Central Admin Console) | 65 |
| installing (Central Admin Server) | 65 |
| installing (User Editor) | 430 |

| | |
|------------------------------------|-----|
| J | |
| job menu | 224 |
| job sequence | 187 |
| job setting quick user guide | 189 |
| job settings menus | 69 |

| | |
|---|---------|
| L | |
| LAN connector | 27 |
| LCD cover | 26 |
| LDAP List | 232 |
| LDAP server | 44, 226 |
| LDAPS server | 44 |
| limit for setting items | 403 |
| loading documents | 216 |
| loading documents (carrier sheet) | 220 |

| | |
|--------------------------------|-----|
| login settings | 90 |
| login settings (details) | 93 |
| login (administrator) | 70 |
| login (regular user) | 226 |

| | |
|-------------------------------------|--------|
| M | |
| magnification | 88 |
| main menu | 223 |
| maintaining system settings | 170 |
| maintenance | 322 |
| managing system log | 164 |
| managing user log | 162 |
| menu | 67, 68 |
| message screen | 326 |
| multifeed | 86 |
| multifeed detection condition | 399 |
| My List | 232 |

| | |
|---------------------------------|-----|
| N | |
| network advanced settings | 107 |
| network settings | 99 |
| NTP server | 45 |

| | |
|-----------------------------------|-----|
| O | |
| obtaining technical support | 182 |
| offset | 88 |
| on-screen keyboard | 55 |
| operations | 29 |

| | |
|--------------------------|-----|
| P | |
| paper size | 394 |
| paper size setting | 279 |
| paper type | 395 |
| paper weight | 395 |
| part name | 26 |

| | |
|----------------------------------|--------------|
| part to clean | 337 |
| PDF password | 280 |
| PDF password settings | 282 |
| pick roller | 28, 342, 346 |
| ping | 108 |
| port number list | 46 |
| positioning | 258 |
| power button | 26, 51 |
| power connector | 27 |
| power-off time | 95 |
| pre-settings (Admin Tool) | 72 |
| pre-settings (User Editor) | 430 |
| print | 251 |
| print mode setting | 260 |
| print server | 44 |
| printer list | 251 |
| processing a job | 324 |
| purchasing a Carrier Sheet | 355 |

R

| | |
|---|-----|
| registering FTP server folder | 137 |
| registering network folder (network path) | 133 |
| registering network folder (network tree) | 131 |
| registering network printer (network path) | 155 |
| registering network printer (network tree) | 153 |
| registering SharePoint folder | 140 |
| regular user | 29 |
| regular user right | 29 |
| regular user settings overview | 225 |
| removing FTP server folder | 138 |
| removing network folder | 134 |

| | |
|--|----------|
| removing network printer | 157 |
| removing SharePoint folder | 142 |
| renaming network folder | 134 |
| renaming SharePoint folder | 142 |
| replacement cycle | 346 |
| replacing consumable parts | 346 |
| replacing roller set | 348 |
| required scanner function settings | 35 |
| resetting a processed image | 315 |
| resetting to factory defaults | 173 |
| resetting usage counter | 160 |
| resolution setting | 278 |
| restoring system settings | 172 |
| restoring user data | 169 |
| roller set | 346 |
| root certification authority list | 412 |
| rotating scanned data | 312, 315 |

S

| | |
|--------------------------------------|----------|
| SAM account | 120 |
| save | 261 |
| saving the e-mail address book | 447 |
| saving to a folder | 261 |
| saving to a network folder | 261 |
| saving to a SharePoint folder | 261 |
| saving to an FTP server folder | 261 |
| scaling | 254 |
| Scan button | 53 |
| scan button | 26 |
| scan settings | 264 |
| scan test | 356 |
| scan viewer | 309, 311 |
| scan viewer details | 312 |
| scanner adjustment | 88 |
| scanner settings | 66 |

| | | | |
|---|-----|--|----------|
| searchable PDF | 283 | setting proxy server | 104 |
| security cable slot | 27 | setting region/timezone | 81 |
| selecting e-mail address | 232 | setting scanner name | 78 |
| selecting fax number | 245 | setting schema | 122 |
| Semi-transparent documents | 396 | setting SharePoint folder | 140 |
| sending e-mail | 229 | setting SMTP server | 125 |
| sending fax | 243 | setting SMTP server (extension) | 126 |
| setting a distribution list | 440 | setting standby mode | 95 |
| setting a group in the e-mail address book | 438 | setting the DNS server (IPv4) | 101, 460 |
| setting an e-mail address | 442 | setting the DNS server (IPv6) | 461 |
| setting automatic logout | 95 | setting the keyboard | 83 |
| setting Central Admin Server | 111 | setting Wake On LAN | 107 |
| setting Central Admin Server (details) | 113 | setting WINS server | 102 |
| setting date/time | 82 | SharePoint server | 44 |
| setting destination for alert notification | 183 | showing download window | 60 |
| setting e-mail LDAP server | 121 | side guide | 26 |
| setting fax server | 129 | skipping blank pages | 300 |
| setting file name format for when attaching scanned data to e-mail | 128 | SMTP Server | 44 |
| setting file name format for when saving scanned data | 144 | SNMP manager | 45 |
| setting image mode | 276 | SNMP settings | 423 |
| setting information output level | 181 | SNMP trap | 427 |
| setting job group | 206 | splitting a file using patch codes | 332 |
| setting job sequence | 191 | splitting an output file | 200 |
| setting LAN Manager authentication level | 98 | stacker | 27 |
| setting LDAP search parameters | 123 | stacker extension 1 | 27 |
| setting link speed/duplex mode | 107 | stacker extension 2 | 27 |
| setting login LDAP server | 114 | standby mode | 95 |
| setting mode | 23 | starting User Editor | 434 |
| setting multifeed detection | 86 | status of consumable parts | 160 |
| setting NTP server | 103 | status of installed options | 161 |
| setting paper | 277 | switching keyboard layout | 419 |
| | | system requirements (Admin Tool) | 40 |
| | | system requirements (related server) | 42 |
| | | system requirements (User Editor) | 40 |
| | | system settings | 78 |

T

text recognition 280

thresholding 290

touch panel 23, 26, 54

troubleshooting 360

turning power off 50

turning power on 49

U

ultrasonic sensor 342

uninstalling (Add-in) 179

uninstalling (Admin Tool) 64

uninstalling (User Editor) 431

update 174

uploading (Add-in settings file) 180

USB connector 27

user data 166

User Editor 429

user log summary 162

user principal 120

V

ventilation ports 27

vertical streaks reduction 294

viewing Add-in status 179

viewing detailed settings for job group 210

viewing detailed settings for job menu 205

viewing details on send operations that
are in progress 320

viewing details on send operations that were
completed 319

viewing e-mail address book 435

viewing FTP server folder details 139

viewing network folder details 135

viewing network printer details 158

viewing SharePoint folder details 143

viewing system log details 164

viewing system status 159

viewing the scanned data 311

viewing user log details 162, 319

W

windows (Admin Tool) 68

windows (administrator) 67

windows (regular user) 223

windows (User Editor) 432

WINS server 45

wood containing paper 396

N7100E Operator's Guide

P3PC-6702-02ENZ0

Issue date August 2021

Issued by PFU Limited

-
- The contents of this manual are subject to change without notice.
 - PFU Limited assumes no liability for incidental or consequential damages arising from the use of this product, and any claims by a third party.
 - Copying of the contents of this manual, in whole or in part, as well as the scanner applications is prohibited under the copyright law.