

ScanSnap

Basic Operation Guide **(Windows)**

Contents

About This Manual	8
Safety Information.....	9
Manuals	10
Trademarks.....	13
Manufacturer.....	14
Symbols Used in This Manual.....	15
Arrow Symbols in This Manual.....	16
Screen Examples in This Manual	17
Abbreviations Used in This Manual	18
Setting Up the ScanSnap.....	20
System Requirements	21
Setting Up iX1600 / iX1500 / iX1400.....	23
Package List for iX1600 / iX1500 / iX1400.....	28
Setting Up iX1300.....	29
Package List for iX1300.....	33
Setting Up iX500.....	34
Setting Up iX100.....	37
Package List for iX100.....	41
Setting Up SV600	42
Package List for SV600	46
Setting Up S1300i.....	47
Package List for S1300i.....	50
Setting Up S1100i.....	51
Package List for S1100i.....	54
Connecting the ScanSnap to a Mobile Device or the ScanSnap Cloud Server (iX1600 / iX1500 / iX1300 / iX500 / iX100)	55
ScanSnap Overview.....	57
What You Can Do with the ScanSnap.....	58
What You Can Do with iX1600 / iX1500 / iX1400.....	59
What You Can Do with iX1300.....	62
What You Can Do with iX500	66
What You Can Do with iX100	68
What You Can Do with SV600.....	71
What You Can Do with S1300i.....	74
What You Can Do with S1100i.....	75
Parts and Functions	78
Parts and Functions of iX1600 / iX1500 / iX1400.....	79
Parts and Functions of iX1300.....	81
Parts and Functions of iX500.....	84
Parts and Functions of iX100.....	86
Parts and Functions of SV600	89
Parts and Functions of S1300i.....	92
Parts and Functions of S1100i.....	94
Charging the Battery (iX100)	96
Overview of the Software Related to the ScanSnap.....	98
ScanSnap Manager Icon.....	99
Right-Click Menu	100

ScanSnap Setup Window	102
Turning the ScanSnap On or Off	104
Turning the ScanSnap On	105
Turning the ScanSnap Off	110
Startup Mode (iX1600 / iX1500 / iX1300)	113
Sleep Mode	115
Automatic Power OFF (iX1600 / iX1500 / iX1400 / iX1300 / iX500 / iX100 / SV600 / S1300i)	116
Checking the Remaining Battery Power (iX100)	119
Screens and Operations on the Touch Panel (iX1600 / iX1500)	120
Screens on the Touch Panel (iX1600 / iX1500)	121
Entering Characters on the Touch Panel (iX1600 / iX1500)	126
Checking the Notification Displayed on the Touch Panel (iX1600 / iX1500)	127
Attaching the Receipt Guide (iX1600 / iX1500 / iX1400)	128
Connecting the ScanSnap via Wireless LAN (iX1600 / iX1500)	132
Preparations for Connecting the ScanSnap via Wireless LAN (iX1600 / iX1500)	133
Connecting the ScanSnap to a Wireless LAN (iX1600 / iX1500)	134
Connecting the ScanSnap to a Wireless Access Point by Using the ScanSnap Wireless Setup Tool (iX1600 / iX1500)	135
Connecting the ScanSnap to a Wireless Access Point from the Touch Panel (iX1600 / iX1500)	136
Connecting the ScanSnap to a computer or mobile device via Wireless LAN (iX1600 / iX1500)	139
Connecting the ScanSnap to a Computer in Access Point Connect Mode (iX1600 / iX1500)	140
Connecting the ScanSnap to a Mobile Device in Access Point Connect Mode (iX1600 / iX1500)	142
Connecting the ScanSnap to a Computer Directly in Direct Connect Mode (iX1600 / iX1500)	143
Connecting the ScanSnap to a Mobile Device in Direct Connect Mode (iX1600 / iX1500)	145
Connecting the ScanSnap via Wireless LAN (iX1300 / iX500 / iX100)	146
Preparations for Connecting the ScanSnap via Wireless LAN (iX1300 / iX500 / iX100)	147
Connecting the ScanSnap to a Wireless LAN (iX1300 / iX500 / iX100)	148
Connecting the ScanSnap to a computer or mobile device via Wireless LAN (iX1300 / iX100)	149
Connecting the ScanSnap to a Computer in Access Point Connect Mode (iX1300 / iX100)	150
Connecting the ScanSnap to a Mobile Device in Access Point Connect Mode (iX1300 / iX100)	152
Connecting the ScanSnap to a Computer Directly in Direct Connect Mode (iX1300 / iX100)	153
Connecting the ScanSnap to a Mobile Device in Direct Connect Mode (iX1300 / iX100)	155
Connecting the ScanSnap to a Computer or Mobile Device via Wireless LAN (iX500)	156
Connecting the ScanSnap and a Computer (iX500)	157
Connecting the ScanSnap and a Mobile Device (iX500)	159
Reconnecting to a Wireless Access Point Using the ScanSnap WPS Button (iX1300 / iX500 / iX100)	160
Wireless Settings for the ScanSnap (iX1600 / iX1500)	163
Registering a Certificate/ Checking the Wireless LAN Settings (iX1600 / iX1500)	164
Registering a Client Certificate or CA Certificate (iX1600 / iX1500)	165
Checking the Wireless LAN Settings (iX1600 / iX1500)	166
Checking the IP address of the ScanSnap (iX1600 / iX1500)	167
Checking the DNS Server of the ScanSnap (iX1600 / iX1500)	168
Checking the MAC address of the ScanSnap (iX1600 / iX1500)	169
Changing the Wireless LAN Connection Method (iX1600 / iX1500)	170
Reconnecting the ScanSnap to Another Wireless Access Point (iX1600 / iX1500)	171
Changing the Connection Method from Access Point Connection to Direct Connection (iX1600 / iX1500)	173
Changing the Connection Method from Direct Connection to Access Point Connection (iX1600 / iX1500)	174
Changing the Frequency for Connecting the ScanSnap (iX1600 / iX1500)	176
Turning Off the Wireless LAN Connection (iX1600 / iX1500)	177
Resetting the Wireless LAN Settings (iX1600 / iX1500)	178

Access Point Connect Settings (iX1600 / iX1500).....	179
Authenticating a Wireless Access Point with a Client Certificate (iX1600 / iX1500).....	180
Authenticating a Wireless Access Point with a User ID and Password (iX1600 / iX1500)	181
Authenticating a Wireless Access Point with an External ID (iX1600 / iX1500)	182
Setting an IP Address for the ScanSnap (iX1600 / iX1500).....	183
Using a DNS Server for the Internet Connection (iX1600 / iX1500).....	184
Using a Proxy Server for the Internet Connection (iX1600 / iX1500).....	185
Changing a Connected Computer to a Computer that You Want to Connect to the ScanSnap (iX1600 / iX1500).....	186
Setting a User Name Displayed on the Touch Panel (iX1600 / iX1500)	187
Changing a Connected Computer to a Computer That You Want to Connect to the ScanSnap from the Touch Panel (iX1600 / iX1500).....	189
Troubleshooting When You Cannot Connect to the ScanSnap (iX1600 / iX1500)	192
Checking Whether Another Computer Is Connected to the ScanSnap (iX1600 / iX1500)	193
Checking Whether a Setting for the ScanSnap Has Been Changed or Not (iX1600 / iX1500).....	194
Scanning Documents	196
Scanning Documents with iX1600 / iX1500 / iX1400	197
Documents to Scan (iX1600 / iX1500 / iX1400).....	198
Scanning Documents (iX1600 / iX1500 / iX1400)	202
Scanning Long Pages (iX1600 / iX1500 / iX1400)	207
Scanning Documents of Different Widths or Lengths in One Batch (iX1600 / iX1500 / iX1400)	211
Scanning Small Size Documents such as Receipts in One Go (iX1600 / iX1500 / iX1400).....	216
Scanning Documents Larger Than A4 or Letter Size (iX1600 / iX1500 / iX1400).....	220
Scanning Documents Such as Photographs and Clippings (iX1600 / iX1500 / iX1400).....	224
Scanning Documents with iX1300	228
Two Scanning Methods for iX1300	229
Documents to Scan (iX1300).....	231
Scanning Documents (iX1300)	235
Scanning Documents in Multiple Batches to Create a Single Scanned Image (iX1300)	242
Scanning Long Pages (iX1300).....	250
Scanning Documents of Different Widths or Lengths in One Batch (iX1300)	256
Scanning Documents Larger Than A4 or Letter Size by Directly Inserting Them in the ScanSnap (iX1300).....	263
Scanning Documents Larger than A4 or Letter Size with the Carrier Sheet (iX1300)	268
Scanning Documents Such as Photographs and Clippings (iX1300)	274
Scanning Booklets or Documents with Overlapped Areas such as Envelopes (iX1300)	279
How to Remove a Jammed Document from iX1300	283
Scanning Documents with iX500.....	286
Documents to Scan (iX500).....	287
Scanning Documents (iX500)	291
Scanning Long Pages (iX500)	297
Scanning Documents of Different Widths or Lengths in One Batch (iX500)	301
Scanning Documents Larger Than A4 or Letter Size (iX500)	307
Scanning Documents Such as Photographs and Clippings (iX500).....	311
Scanning Documents with iX100.....	315
Documents to Scan (iX100).....	316
Scanning Documents (iX100)	320
Scanning Documents by Inserting Two Documents at a Time or by Inserting the Next Document While the Current Document Is Being Scanned (iX100).....	325
Scanning Documents Larger Than A4 or Letter Size by Directly Inserting Them in the ScanSnap (iX100).....	332
Scanning Documents Larger than A4 or Letter Size with the Carrier Sheet (iX100)	336
Scanning Documents Such as Photographs and Clippings (iX100).....	341
Scanning Documents with SV600	345
Documents to Scan (SV600)	346

How to Place Documents (SV600)	347
Scanning Documents (SV600).....	350
Scanning Books (SV600).....	355
Scanning Multiple Documents at Once (SV600).....	360
Scanning Books Using Page Turning Detection (SV600).....	365
Scanning Documents Using Timed Mode (SV600)	369
Scanning Documents with Two ScanSnaps Connected to a Computer (SV600).....	372
Scanning Documents with S1300i.....	373
Documents to Scan (S1300i).....	374
Scanning Documents (S1300i)	376
Scanning Long Pages (S1300i).....	381
Scanning Documents of Different Widths or Lengths in One Batch (S1300i)	385
Scanning Documents with S1100i.....	390
Documents to Scan (S1100i).....	391
Scanning Documents (S1100i)	395
Scanning Documents by Inserting Two Documents at a Time or by Inserting the Next Document While the Current Document Is Being Scanned (S1100i).....	400
Scanning Documents Larger Than A4 or Letter Size by Directly Inserting It in the ScanSnap (S1100i) ...	407
Scanning Documents Larger than A4 or Letter Size with the Carrier Sheet (S1100i)	411
Scanning Documents Such as Photographs and Clippings (S1100i)	416
What You Can Do with Related Software	420
What You Can Do with ScanSnap Home	421
What You Can Do with the ScanSnap Organizer.....	423
Basic Operation Procedure of ScanSnap Organizer	424
Managing Files.....	426
Editing Files	428
Using Files.....	429
What You Can Do with CardMinder.....	430
Basic Operation Procedure of CardMinder	432
Linking Card Data with Other Applications.....	435
Searching Card Data with the Basic Search Toolbar.....	436
Searching Card Data with CardMinder Viewer	437
Attaching a File to Card Data.....	438
Useful Usages.....	439
Managing Paper Documents by Folder on a Computer with ScanSnap Home.....	440
Managing Paper Documents by Folder on a Computer with ScanSnap Organizer	443
Saving Business Card Data to a Computer with ScanSnap Home	446
Saving Business Cards to a Computer with CardMinder.....	449
Saving Receipt Data to a Computer.....	452
Creating a Photo Album and Saving it to a Computer.....	455
Correcting Scanned Images (SV600)	458
When a Document Is Scanned (SV600).....	459
Filling in Fingers Captured in a Scanned Image (When a Document Is Scanned)(SV600).....	460
When a Book Is Scanned (SV600)	464
Correcting Distorted Book Images (SV600)	465
Splitting a Double-Page Spread Image into Two Page Images (SV600)	470
Filling in Fingers Captured in a Scanned Image (When a Book Is Scanned)(SV600).....	473
When Multiple Documents Are Scanned at Once (SV600).....	476
Correcting the Scanned Image Orientation (SV600)	477
Modifying the Crop Area (SV600).....	480
Adding the Necessary Scanned Images (SV600)	482
Deleting Unnecessary Scanned Images (SV600)	484

Uninstalling Software/Troubleshooting during Uninstallation	487
How to Find Your Solution.....	488
If Your First Attempt to Install Failed	489
If You Have Installed the Software Before	490
Uninstalling the Software	491
Removing the Installation Information	492
Reinstalling the Software	493
Cannot Connect to the ScanSnap even after the Installation Has Been Complete (iX1600 / iX1500)	494
When the ScanSnap Manager Icon Does Not Appear	495
Displaying the ScanSnap Manager Icon.....	496
When ScanSnap Manager Does Not Operate Normally	497
Removing Unnecessary Icons from the Notification Area.....	498
Checking the Connection between the ScanSnap and the Computer	499
Checking If ScanSnap Manager Is Operating Normally	500
Removing the ScanSnap's Connection Information	503
When You Cannot Uninstall the Software.....	505
Cleaning the ScanSnap	506
Cleaning Materials	507
Cleaning iX1600 / iX1500 / iX1400	508
Cleaning the Outside of iX1600 / iX1500 / iX1400	509
Cleaning the Inside of iX1600 / iX1500 / iX1400	510
Cleaning iX1300	517
Cleaning the Outside of iX1300.....	518
Cleaning the Inside of iX1300	519
Cleaning iX500	524
Cleaning the Outside of iX500	525
Cleaning the Inside of iX500.....	526
Cleaning iX100	530
Cleaning the Outside of iX100	531
Cleaning the Inside of iX100.....	532
Cleaning SV600.....	535
Cleaning S1300i	536
Cleaning the Outside of S1300i.....	537
Cleaning the Inside of S1300i	538
Cleaning S1100i	542
Cleaning the Outside of S1100i.....	543
Cleaning the Inside of S1100i	544
Cleaning the Carrier Sheet (iX1600 / iX1500 / iX1400 / iX1300 / iX500/ iX100 / S1100i)	547
Cleaning the Background Pad (SV600).....	548
Consumables for the ScanSnap (iX1600 / iX1500 / iX1400 / iX1300 / iX500 / S1300i).....	549
Part Numbers and Replacement Cycle of Consumables (iX1600 / iX1500 / iX1400 / iX1300 / iX500 / S1300i)	550
Checking the Status of Consumables (iX1400 / iX1300 / iX500 / S1300i).....	552
Replacing Consumables for iX1600 / iX1500 / iX1400.....	553
Replacing Consumables for iX1300.....	560
Replacing the Pad Unit (iX1300)	561
Replacing the Pick Roller (iX1300)	564
Replacing Consumables for iX500	568
Replacing Consumables for S1300i.....	575
Replacing the Pad Assy (S1300i).....	576

Replacing the Pick Roller Assembly (S1300i).....	579
Appendix	584
Updating the Software	585
Updating the Firmware (iX1600 / iX1500).....	586
Uninstalling the Software	587
Part Number of the Background Pad (SV600).....	589
Part Number of the Carrier Sheet (iX1600 / iX1500 / iX1400 / iX1300 / iX500 / iX100 / S1100i)	590
Specifications of the ScanSnap.....	591
Specifications for iX1600 / iX1500 / iX1400	592
Specifications for iX1300.....	594
Specifications for iX500	596
Specifications of iX100	598
Specifications of SV600	600
Specifications of S1300i.....	602
Specifications for S1100i.....	604
About Customer Support and Maintenance	606

About This Manual

- "Safety Information" (page 9)
- "Manuals" (page 10)
- "Trademarks" (page 13)
- "Manufacturer" (page 14)
- "Symbols Used in This Manual" (page 15)
- "Arrow Symbols in This Manual" (page 16)
- "Screen Examples in This Manual" (page 17)
- "Abbreviations Used in This Manual" (page 18)

Safety Information

The attached "Safety Precautions" manual contains important information about the safe and correct use of the ScanSnap. Make sure that you read and understand it before using the ScanSnap.

Manuals

Read the following manuals according to your needs when using the ScanSnap.



Before Using the ScanSnap

Manual	Description and Location
Safety Precautions	<p>This manual contains important information about the safe use of the ScanSnap. Make sure you read this manual before using the ScanSnap.</p> <p>This manual is included in the package.</p> <p>In addition, after installing the software you can refer to this manual in the following procedure:</p> <ul style="list-style-type: none"> ● Windows 10 Select [Start] menu → [ScanSnap Manuals] → [Safety Precautions]. ● Windows 8.1 Click  on the lower left side of the Start screen, and select [Safety Precautions] under [ScanSnap Manuals] on the All apps screen. ● Windows 7 Select [Start] menu → [All Programs] → [ScanSnap Manuals] → [Safety Precautions].
Getting Started (*1)	<p>This manual explains the steps from opening the package of iX1300 to checking operations.</p> <p>This manual is included in the package.</p>
Welcome Guide (*2)	<p>This manual explains about the flow of the setup procedure for the ScanSnap.</p> <p>This manual is included in the package.</p>

*1: This is supplied with iX1300.



*2: This is supplied with iX1600/iX1500/iX1400/iX100/SV600/S1300i/S1100i.

When Operating the ScanSnap

Manual	Description and Location
ScanSnap Basic Operation Guide (this manual)	<p>This manual explains the setup procedure, basic operations, and the cleaning procedure for the ScanSnap.</p>
ScanSnap Advanced Operation Guide	<p>This manual describes operations including various scanning methods and useful usages of the ScanSnap.</p> <p>You can refer to this manual at the following website.</p> <p>https://www.pfu.fujitsu.com/imaging/downloads/manual/advanced/win/en/topics/index.html</p>
ScanSnap Manager Help	<p>This Help file describes the windows, operational troubles and the solutions, as well as messages of the ScanSnap Manager.</p> <p>This Help file can be accessed by one of the following methods:</p> <ul style="list-style-type: none"> ● Right-click the ScanSnap Manager icon  in the notification area located at the far right of the taskbar, and select [Help] → [Help] from the "Right-Click Menu" (page 100). ● Click the Help button  for ScanSnap Manager. ● Press the [F1] key on the keyboard while a window is displayed. ● Click the [Help] button in any window.

Manual	Description and Location
ScanSnap Wireless Setup Tool Help	<p>This Help file explains about operations, operational troubles and their solutions, windows, and messages of the ScanSnap Wireless Setup Tool.</p> <p>This Help file can be accessed by one of the following methods:</p> <ul style="list-style-type: none"> ● Press the [F1] key on the keyboard while a window is displayed. ● Click [About this screen] or [About this message] on each screen.



When Saving Scanned Images to a Mobile Device

Manual	Description and Location
ScanSnap Basic Operation Guide (Mobile Connection for iOS)	<p>This manual describes operations to be performed on an iOS-based mobile device when you save scanned images to the mobile device.</p> <p>This manual can be accessed by the following method:</p> <ol style="list-style-type: none"> 1. Start up ScanSnap Connect Application on the mobile device. <ul style="list-style-type: none"> ⇒ The [File List] screen appears. 2. Tap . <ul style="list-style-type: none"> ⇒ The [Information] screen appears. 3. Tap the [Help] button.
ScanSnap Basic Operation Guide (Mobile Connection for Android)	<p>This manual describes operations to be performed on an Android-based mobile device when you save scanned images to the mobile device.</p> <p>This manual can be accessed by the following method:</p> <ol style="list-style-type: none"> 1. Start up ScanSnap Connect Application on the mobile device. <ul style="list-style-type: none"> ⇒ The [File List] screen appears. 2. Tap . <ul style="list-style-type: none"> ⇒ The menu appears. 3. Tap [Help].
Scan to Mobile Help	<p>This Help file describes the operations, windows, and messages of Scan to Mobile.</p> <p>This Help file can be accessed by one of the following methods:</p> <ul style="list-style-type: none"> ● The [Scan to Mobile] icon is displayed in the menu that appears when you click  in the notification area located at the far right of the taskbar. Right-click the [Scan to Mobile] icon, and select [Help] from the menu that appears. ● Press the [F1] key on the keyboard while a window is displayed. ● Click the [Help] button in any window.

When Updating the Software

Manual	Description and Location
ScanSnap Online Update Help	<p>This Help file describes the operations, windows, and messages of ScanSnap Online Update.</p> <p>This Help file can be accessed by one of the following methods:</p> <ul style="list-style-type: none"> ● Press the [F1] key on the keyboard while a window is displayed. ● Click the Help button in any window.

When Using Related Applications

Manual	Description and Location
ScanSnap Home Help	<p>This Help file explains about operations, troubles that occur during operations, and the solutions to the troubles for ScanSnap Home when it is used in conjunction with ScanSnap Manager.</p> <p>You can refer to this manual at the following website.</p> <p>https://www.pfu.fujitsu.com/imaging/downloads/manual/ss_webhelpmgr/en/top/index.html</p>
ScanSnap Organizer Help	<p>This Help file describes the operations, windows, and messages of ScanSnap Organizer.</p> <p>This Help file can be accessed by one of the following methods:</p> <ul style="list-style-type: none"> ● Click the Help button () for ScanSnap Organizer. ● Press the [F1] key on the keyboard while a window is displayed. ● Click the [Help] button in any window.
CardMinder Help	<p>This Help file describes the operations, windows, and messages of CardMinder.</p> <p>This Help file can be accessed by one of the following methods:</p> <ul style="list-style-type: none"> ● Click the Help button () next to the Basic Search Toolbar. ● Press the [F1] key on the keyboard while a window is displayed. ● Click the [Help] button in any window.
ABBYY FineReader for ScanSnap User's Guide	<p>This manual describes the overview and operations of ABBYY FineReader for ScanSnap.</p> <p>This manual can be accessed by one of the following methods:</p> <ul style="list-style-type: none"> ● Press the [F1] key on the keyboard while a window is displayed. ● Click the [Help] button in any window.
How to Install PDF Editing Software	<p>This manual describes how to install the following applications for creating, editing, managing, and utilizing electronic documents in a PDF format.</p> <ul style="list-style-type: none"> ● Kofax Power PDF Standard ● Nuance Power PDF Standard <p>You can refer to this manual at the following.</p> <p>https://www.pfu.fujitsu.com/imaging/downloads/manual/install/en</p>

Trademarks

Apple, App Store, the Apple logo, Mac, Mac OS, OS X, macOS, iPad, iPadOS, iPhoto, iPod touch, and iTunes are trademarks of Apple Inc.

Kofax is a registered trademark or trademark of Kofax Limited.

Adobe, Acrobat, and Reader are either registered trademarks or trademarks of Adobe in the United States and/or other countries.

Intel and Intel Core are trademarks of Intel Corporation or its subsidiaries in the U.S. and/or other countries.

ABBYY™ FineReader™ Engine © ABBYY. OCR by ABBYY

ABBYY and FineReader are trademarks of ABBYY Software, Ltd. which may be registered in some jurisdictions.

Evernote is a trademark of Evernote Corporation.

Google, Android, Google Play, Google Drive, and Google Chrome are trademarks or registered trademarks of Google LLC. Use of these registered trademarks or trademarks is subject to Google Permissions.

Salesforce, the Salesforce logo, and Salesforce CRM are registered trademarks or trademarks of salesforce.com, inc. in the United States and other countries.

Wi-Fi, Wi-Fi Protected Setup, and the Wi-Fi Protected Setup logo are trademarks of Wi-Fi Alliance.

Amazon is a trademark of Amazon.com, Inc. or its affiliates.

For iX1600/iX1500 Users

Besides the software authored by the product developer (PFU Limited), the ScanSnap contains other free software, such as software copyrighted under the GNU General Public License (GPL) or the GNU Lesser General Public License (LGPL). For details concerning the conditions of the licenses for Open Source Software (OSS), refer to the screen that appears when you press the settings icon in the upper right of the home screen on the ScanSnap touch panel and then press [Scanner settings] and [License].

For iX1300/iX500 Users

Besides the software authored by the product developer (PFU Limited), the ScanSnap contains other free software, such as software copyrighted under the GNU General Public License (GPL) or the GNU Lesser General Public License (LGPL). For details concerning the conditions of the licenses, refer to "Terms and Conditions for End User License" (file name: OSS_License.pdf) contained in the installation folder of ScanSnap Home or ScanSnap Manager.

For iX100 Users

Besides the software authored by the product developer (PFU Limited), the ScanSnap contains other free software created by third parties. For details concerning the conditions of the licenses, refer to "Terms and Conditions for End User License" (file name: OSS_License.pdf) contained in the installation folder of ScanSnap Home or ScanSnap Manager.

ScanSnap, the ScanSnap logo, ScanSnap Home, ScanSnap Manager, ScanSnap Organizer, CardMinder, Rack2-Filer, and Magic Desktop are registered trademarks or trademarks of PFU Limited in Japan.

Other company names and product names are the registered trademarks or trademarks of the respective companies.

Manufacturer

PFU Limited



YOKOHAMA i-MARK PLACE, 4-4-5 Minatomirai, Nishi-ku, Yokohama, Kanagawa, 220-8567, Japan

© PFU Limited 2020-2021

Regulatory Model: P3770A/P3820A/P3805A

Symbols Used in This Manual

The following indications are used in this manual to obviate any chance of accident or damage to you and people near you, and your property. Warning labels indicate the warning level and statements. The symbols indicating warning levels and their meanings are as follows.

Indication	Description
 WARNING	This indication alerts operators of an operation that, if not strictly observed, may result in severe injury or death.
 CAUTION	This indication alerts operators of an operation that, if not strictly observed, may result in safety hazards to personnel or damage to the product.

Arrow Symbols in This Manual

Right-arrow symbols (→) are used to connect icons or menu options you should select in succession.

Example: Select [Start] menu → [Computer].

Screen Examples in This Manual



The screenshots used in this manual are the ones that are displayed when iX1600 is connected.



Microsoft product screenshots are reprinted with permission from Microsoft Corporation.

The screenshots used in this manual are of Windows 10 or Windows 7.

The actual windows and operations may differ depending on the operating system.

Icon in the Notification Area

The ScanSnap Manager icon  is displayed in the menu which appears when you click  in the notification area.

To have the ScanSnap Manager icon  always displayed in the notification area, drag the icon  and drop it onto the notification area.

The notification area is located at the far right of the taskbar.

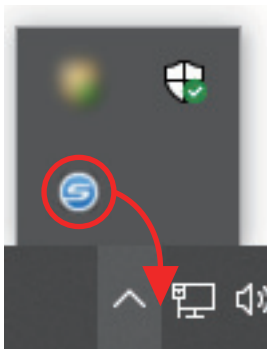

The explanations in this manual use the case in which the ScanSnap Manager icon  is always displayed in the notification area.

HINT

If the ScanSnap Manager icon  is not displayed in the notification area, start ScanSnap Manager. Start ScanSnap Manager in the following procedure.

- Windows 10
Select [Start] menu → [ScanSnap Manager] → [ScanSnap Manager].
- Windows 8.1
Click  on the lower left side of the Start screen, and select [ScanSnap Manager] under [ScanSnap Manager] on the All apps screen.
- Windows 7
Select [Start] menu → [All Programs] → [ScanSnap Manager] → [ScanSnap Manager].

Abbreviations Used in This Manual

When a ScanSnap model is referred to in this manual, "Color Image Scanner ScanSnap" is omitted. Also, the following abbreviations are used in this manual.

Abbreviation Used	Designation
Windows 10	Windows® 10 Home operating system, English Version Windows® 10 Pro operating system, English Version Windows® 10 Enterprise operating system, English Version Windows® 10 Enterprise LTSC 2019 operating system, English Version Windows® 10 Enterprise 2016 LTSC operating system, English Version Windows® 10 Education operating system, English Version
Windows 8.1	Windows® 8.1 operating system, English Version Windows® 8.1 Pro operating system, English Version Windows® 8.1 Enterprise operating system, English Version
Windows 7	Windows® 7 Professional operating system, English Version Windows® 7 Enterprise operating system, English Version
Windows	Windows 10, Windows 8.1, or Windows 7
Microsoft Office	Microsoft® Office
Word	Microsoft® Word
Excel	Microsoft® Excel®
PowerPoint	Microsoft® PowerPoint®
SharePoint	Microsoft® SharePoint® Server Microsoft® SharePoint® Foundation Microsoft® SharePoint® Online
Internet Explorer	Internet Explorer®
Outlook	Microsoft® Outlook®
.NET Framework	Microsoft® .NET Framework
Kofax	Kofax®
Adobe Acrobat	Adobe® Acrobat® Adobe® Acrobat® DC
ABBYY FineReader for ScanSnap	ABBYY FineReader for ScanSnap™ All the descriptions in this manual assume the usage of ABBYY FineReader for ScanSnap bundled with the ScanSnap. Unless otherwise specified, the term ABBYY FineReader for ScanSnap refers to the ABBYY FineReader for ScanSnap bundled with the ScanSnap. Note that ABBYY FineReader for ScanSnap may be upgraded without notice. If the descriptions in this manual differ from the actual displayed screens, refer to the ABBYY FineReader for ScanSnap User's Guide.
Google Drive	Google Drive™
Android	Android™
WPS	Wi-Fi Protected Setup™
Wireless access point	Wireless access point Wireless router

Abbreviation Used	Designation
ScanSnap	Color Image Scanner ScanSnap series (*1)

*1: The ScanSnap N1800 series is not included.

Setting Up the ScanSnap

- "System Requirements" (page 21)
- "Setting Up iX1600 / iX1500 / iX1400" (page 23)
- "Setting Up iX1300" (page 29)
- "Setting Up iX500" (page 34)
- "Setting Up iX100" (page 37)
- "Setting Up SV600" (page 42)
- "Setting Up S1300i" (page 47)
- "Setting Up S1100i" (page 51)
- "Connecting the ScanSnap to a Mobile Device or the ScanSnap Cloud Server (iX1600 / iX1500 / iX1300 / iX500 / iX100)" (page 55)

System Requirements

The ScanSnap has the following system requirements.

For the latest information on requirements, please visit the ScanSnap Support Site at:

<https://scansnap.fujitsu.com/g-support/en/>

Operating system	Windows 10 (32-bit/64-bit) (*1)(*2) Windows 8.1 (32-bit/64-bit) (*3) Windows 7 (32-bit/64-bit)(*4)
CPU	Intel® Celeron™ 1.8 GHz (2 cores) or higher (Recommended: Intel® Core™ i5 2.5 GHz or higher)
Memory	2 GB or more (Recommended: 4 GB or more)
Display resolution (*5)	1024 × 768 pixels or higher
Disk space	Free space required to install the software related to the ScanSnap is as follows: (*6)(*7) <ul style="list-style-type: none"> ● ScanSnap Manager: 930 MB ● ScanSnap Home: 950 MB (*8) ● ScanSnap Organizer: 340 MB ● CardMinder: 730 MB ● ABBYY FineReader for ScanSnap: 710 MB ● ScanSnap Online Update: 50 MB ● OCR Pack (*9)
USB port	<p>iX1600/iX1500/iX1400 USB 3.2 Gen1 (*10)/USB 3.1 Gen1 (*10)/USB 3.0 (*10)/USB 2.0/USB 1.1</p> <p>iX1300 USB 3.2 Gen1x1 (*11)/USB 3.1 Gen1 (*11)/USB 3.0 (*11)/USB 2.0/USB 1.1</p> <p>iX500/iX100/SV600/S1300i/S1100i USB 3.0 (*12)/USB 2.0/USB 1.1</p>

*1: The software bundled with the ScanSnap operates in desktop mode.

*2: ScanSnap Home cannot be used on Windows 10 Enterprise 2015 LTSC.

*3: The software bundled with the ScanSnap operates as a desktop application.

*4: Service Pack 1 or later is required.

*5: When the font size is large, some screens may not be displayed correctly. In such a case, use a smaller font size.

*6: To save scanned images, more free space is required. For details about estimated image data size, refer to the ScanSnap Manager Help.

*7: For the system requirements of the PDF editing software that is supplied with iX1600/iX1500/iX500/SV600, refer to the following:

How to Install PDF Editing Software

<https://www.pfu.fujitsu.com/imaging/downloads/manual/install/en>

*8: .NET Framework 4.8 or later must be installed. If .NET Framework 4.8 or later is not installed, a notification to install the software will appear when installing ScanSnap Home. Up to 4.5 GB of additional disk space is required for the installation.

- *9: By installing the OCR Pack, you can add extra languages to recognize text. For the amount of free space required to install the OCR Pack, refer to the following:
- <https://www.fujitsu.com/global/support/products/computing/peripheral/scanners/scansnap/software/ocrpack-setup.html>
- *10: When the ScanSnap is connected to a USB 3.2 Gen1 port, a USB 3.1 Gen1 port, or a USB 3.0 port, the ScanSnap may not be recognized by some computers. In this case, connect the ScanSnap to a USB 2.0 port.
- *11: When the ScanSnap is connected to a USB 3.2 Gen1x1 port, a USB 3.1 Gen1 port, or a USB 3.0 port, the ScanSnap may not be recognized by some computers. In this case, connect the ScanSnap to a USB 2.0 port.
- *12: When the ScanSnap is connected to a USB 3.0 port, the ScanSnap may not be recognized by some computers. In this case, connect the ScanSnap to a USB 2.0 port.

ATTENTION

- If the system requirements above are not satisfied, the ScanSnap may not operate.
- If a USB port on the keyboard or on the monitor is in use, the ScanSnap may not operate.
- When using a commercially available USB hub, use a type that is powered from an electrical power supply (and that comes with an adapter).
- Scanning speed decreases when you use the ScanSnap in the following environments:
 - The CPU or the memory does not meet the recommended specifications.
 - The version of the USB port or the USB hub is USB 1.1.
- The actual disk space used for the installation of the software and the disk space required for the installation may be different because of the disk management in your Windows system.
- To scan a document, a disk space that is approximately three times larger than the size of the file to be saved is required.
- If characters are not correctly displayed when you use the following functions, install the universal font (Arial Unicode MS) from the setup disk of Microsoft Office 2007 or later:
 - CardMinder
 - Scan to Mobile
 - Scan to Salesforce Chatter
 - Scan to Dropbox

HINT

- For Windows 7, when the following software programs are installed, .NET Framework 4 or an in-place update for .NET Framework 4 (which requires 2 GB of free disk space at most) may be installed:
 - ScanSnap Manager
 - ScanSnap OrganizerAfter installing .NET Framework, apply the updates in Windows Update.
- For Windows 10 or Windows 8.1, when the following software programs are installed, .NET Framework 3.5 SP1 (which requires 500 MB of free disk space at most) may be installed at the same time:
 - ScanSnap Manager
 - ScanSnap Organizer
 - CardMinder

Setting Up iX1600 / iX1500 / iX1400

Set up the ScanSnap so that it is ready to scan with ScanSnap Manager.

The following preparations are required before you set up the ScanSnap.

- Check that all items are included in the package
For details, refer to "[Package List for iX1600 / iX1500 / iX1400](#)" (page 28).
- Remove the protective inner cover and tape (1) and the cardboard sheet (2) from the ScanSnap
The following is an example of iX1600.

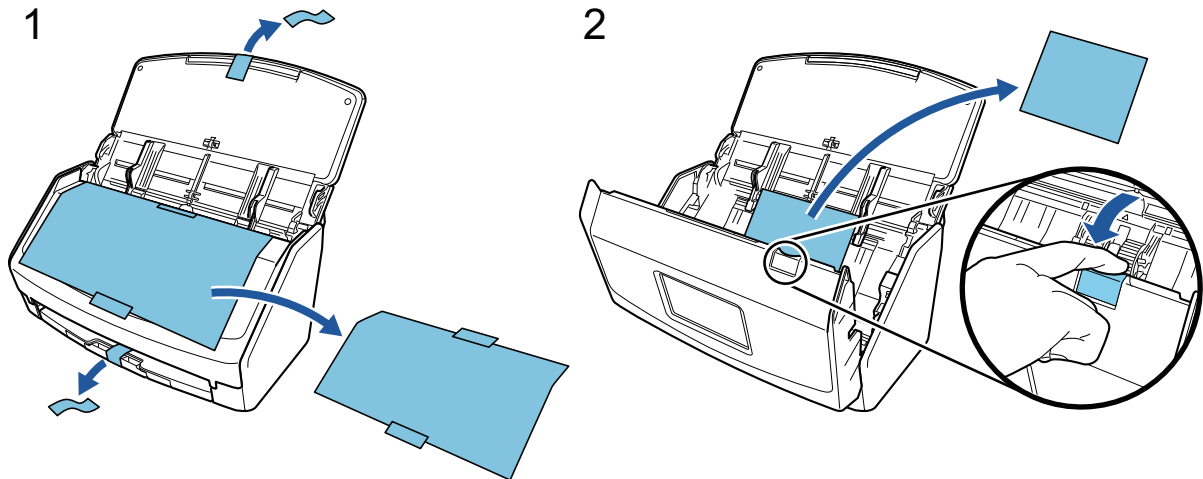

The procedure to set up the ScanSnap is as follows:

- 1 Configuring the Settings of the ScanSnap
- 2 Downloading the Software
- 3 Installing the Software/Connecting the ScanSnap
- 4 Checking the Scanning Operation

1

Configuring the Settings of the ScanSnap

1. Connect the power cable to the power connector on the ScanSnap and the AC outlet.

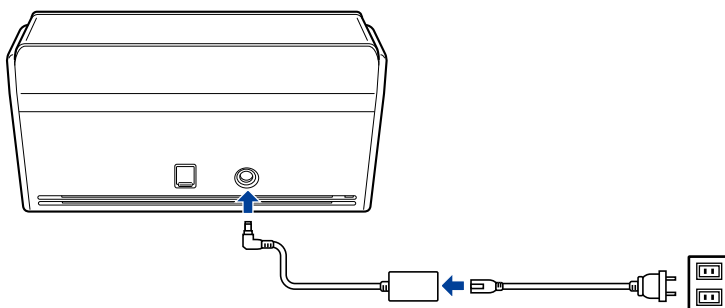

Use only the AC adapter and cables that are bundled with the ScanSnap. Using other adapters and cables may cause a scanner failure.

2. Open the ADF paper chute (cover) to turn the power on.

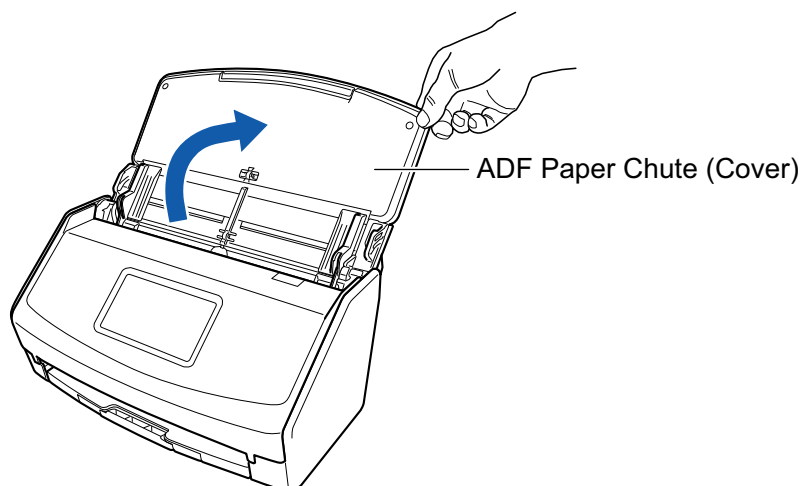

Example: iX1600

- Configure the settings of the ScanSnap by following the instructions on the touch panel. When you are using iX1400, proceed to [2 Downloading the Software](#).



Set the display language of the touch panel, the startup mode, and a device that is used with the ScanSnap.

When the [USB Connection] screen is displayed on the touch panel, the setting procedure for the ScanSnap is complete.

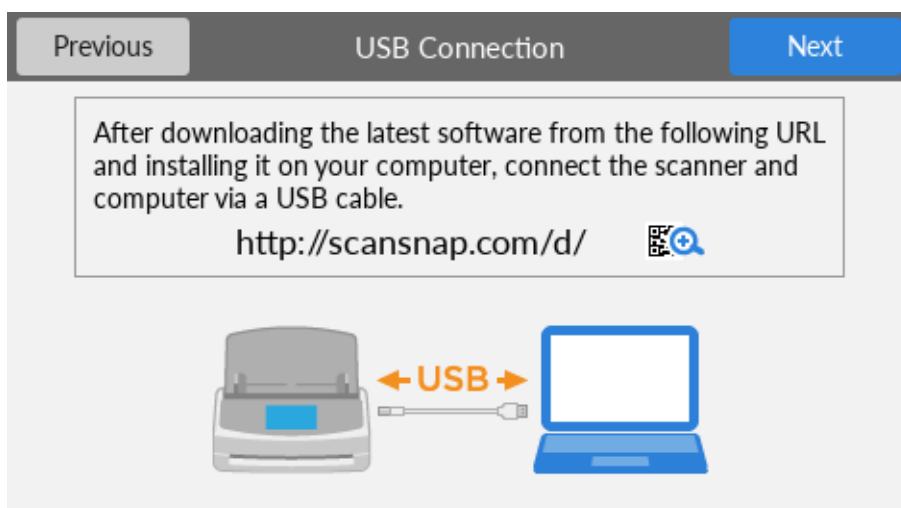

2

Downloading the Software

1. Turn on the computer and log on as a user with Administrator privileges.
2. Access the website "ScanSnap Installer".
 - [ScanSnap Installer](#) for iX1600
 - [ScanSnap Installer](#) for iX1500
 - [ScanSnap Installer](#) for iX1400

3. Download [ScanSnap Installer] and save it on your computer.

By using the installer that you downloaded, you can install the following software programs.

- ScanSnap Manager
- ScanSnap Online Update
- ScanSnap manual

Install software applications other than the above if needed.

For the overview for each software program, refer to "[Overview of the Software Related to the ScanSnap](#)" (page 98).

3

Installing the Software/Connecting the ScanSnap

1. Run the installer that you saved on your computer.
2. Follow the instructions on the [ScanSnap Installer] window that appears.

When you are asked whether you accept the license agreement terms, read the confirmation message and select [I agree to all terms and conditions].
3. When [Installation complete] appears, click the [Complete] button.
4. When the [About ScanSnap's Auto Power OFF function] window appears, read the message and click the [Next] button.
5. Follow the instructions on the [ScanSnap - Connecting the ScanSnap] window to connect the ScanSnap to a computer.
6. When you are using iX1600/iX1500, on the [ScanSnap wireless network setup] window, select whether to configure the wireless settings in order for the ScanSnap to be connected to a wireless LAN.

If you want to configure the wireless settings, click [Setup now] and follow the instructions on the window that appears.

If you do not want to configure the wireless settings, click the [Later] button. When you connect the ScanSnap to a wireless LAN later, refer to "[Connecting the ScanSnap via Wireless LAN \(iX1600 / iX1500\)](#)" (page 132).

HINT

- If there are available updates for ScanSnap Online Update on the server, you will be asked whether you accept the license agreement terms for ScanSnap Online Update.

For details about ScanSnap Online Update, refer to the ScanSnap Online Update Help.

- To save images created from documents that you scanned with the ScanSnap to a mobile device or a cloud service directly, you need to connect the ScanSnap to the mobile device or the ScanSnap Cloud server.

For details, refer to "[Connecting the ScanSnap to a Mobile Device or the ScanSnap Cloud Server \(iX1600 / iX1500 / iX1300 / iX500 / iX100\)](#)" (page 55).

4

Checking the Scanning Operation

1. Load a document in the ScanSnap.

Load a document face-down and head-first with the back facing you (when loading multiple documents, the last page is on the top).

For details about how to scan a document, refer to "[Scanning Documents with iX1600 / iX1500 / iX1400](#)" (page 197).

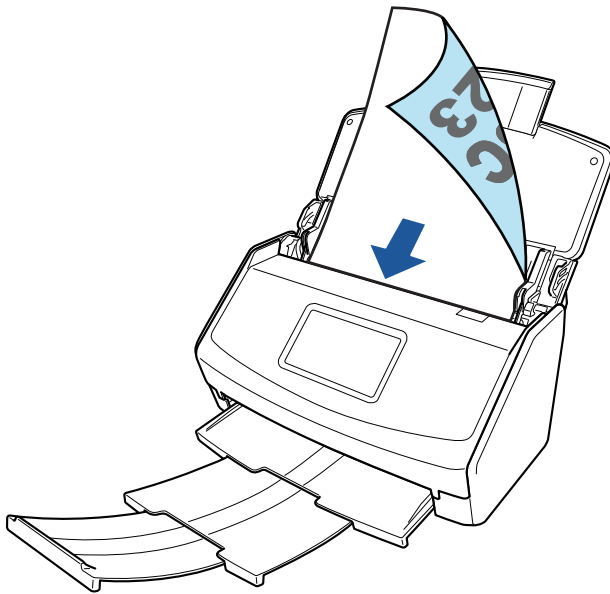

Example: iX1600

2. Start scanning.

iX1600/iX1500

Press the [Scan] button in the home screen on the touch panel.

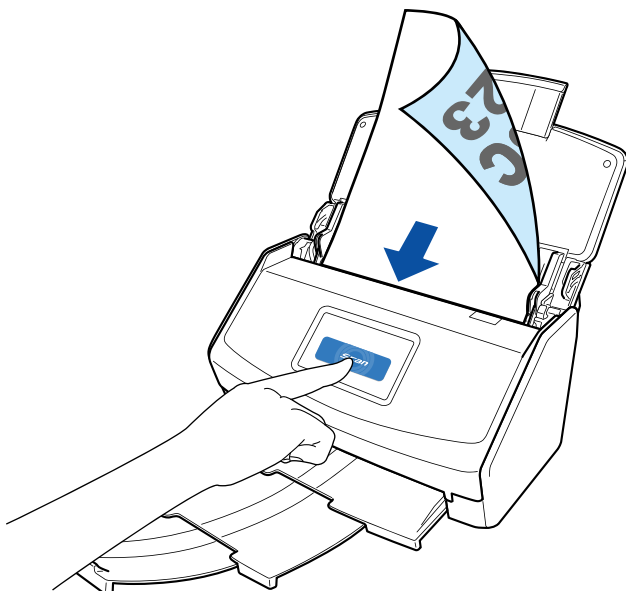

iX1400

Press the [Scan] button on the ScanSnap.

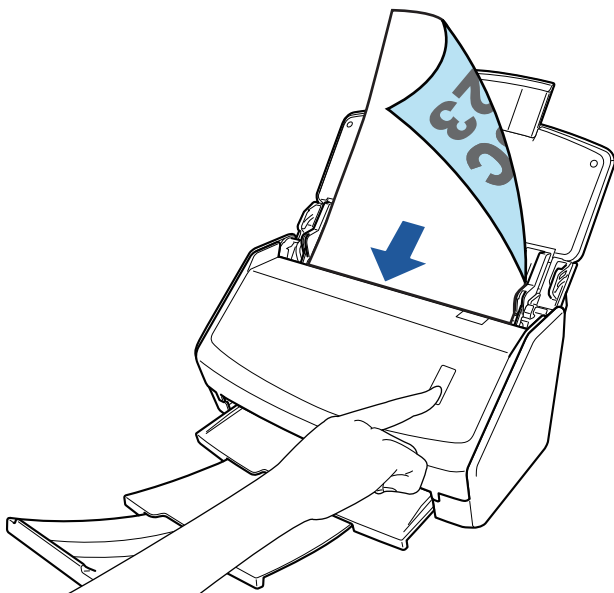

Once the Quick Menu for selecting an application to perform a particular action appears, the check process for the scanning operation is complete.

Clicking an icon on the Quick Menu allows you to save images created from documents that you scanned with the ScanSnap to your desired folder, or attach them to an e-mail.

Package List for iX1600 / iX1500 / iX1400

Make sure that all items are included in the package before you set up the ScanSnap.

Items that come with the ScanSnap are as follows:

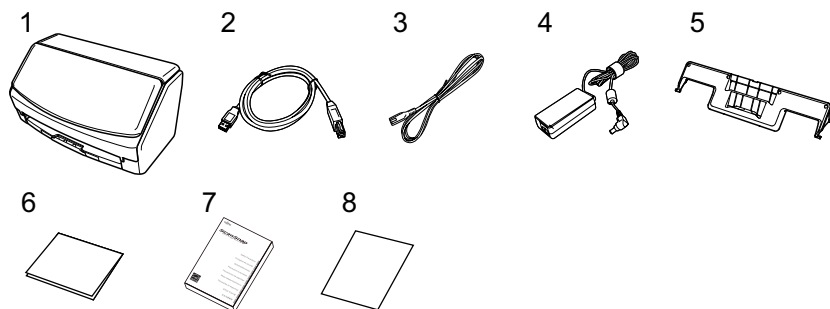

1. ScanSnap
2. USB cable
3. AC cable (*1)
4. AC adapter (*1)
5. Receipt Guide
6. Welcome Guide
7. Safety Precautions (*2)
8. License certificate of PDF Editing Software (*3)
 - iX1600
License certificate of Kofax Power PDF Standard/Kofax Power PDF Standard for Mac
 - iX1500
License certificate of Kofax Power PDF Standard/Kofax Power PDF Standard for Mac,
License certificate of Nuance Power PDF Standard/Nuance Power PDF Standard for Mac, or
License certificate of Nuance Power PDF Standard/Nuance PDF Converter for Mac

*1: An AC cable which is connected to the AC adapter is called a power cable.

*2: The format varies depending on the ScanSnap model or the country where the ScanSnap is purchased.

*3: PDF Editing Software is not bundled with iX1400.

Setting Up iX1300

Set up the ScanSnap so that it is ready to scan with ScanSnap Manager.

The following preparations are required before you set up the ScanSnap.

ATTENTION

Do not connect the ScanSnap to the computer before installing the software.

- Check that all items are included in the package
For details, refer to ["Package List for iX1300" \(page 33\)](#).
- Remove the materials used for protection from the ScanSnap
For details, refer to Getting Started that is supplied with the scanner.

The procedure to set up the ScanSnap is as follows:

1 [Downloading the Software](#)

2 [Installing the Software/Connecting the ScanSnap](#)

3 [Checking the Scanning Operation](#)

1

Downloading the Software

1. Turn on the computer and log on as a user with Administrator privileges.
2. Access the website ["ScanSnap Installer"](#).
3. Download [ScanSnap Installer] and save it on your computer.
By using the installer that you downloaded, you can install the following software programs.
 - ScanSnap Manager
 - ScanSnap Online Update
 - ScanSnap manual

Install software applications other than the above if needed.

For the overview for each software program, refer to ["Overview of the Software Related to the ScanSnap" \(page 98\)](#).

2

Installing the Software/Connecting the ScanSnap

1. Run the installer that you saved on your computer.
2. Follow the instructions on the [ScanSnap Installer] window that appears.
When you are asked whether you accept the license agreement terms, read the confirmation message and select [I agree to all terms and conditions].
3. When [Installation complete] appears, click the [Complete] button.

4. When the [About ScanSnap's Auto Power OFF function] window appears, read the message and click the [Next] button.
5. Follow the instructions on the [ScanSnap - Connecting the ScanSnap] window to connect the ScanSnap to a computer.
6. On the [ScanSnap wireless network setup] window, select whether to configure the wireless settings in order for the ScanSnap to be connected to a wireless LAN.

If you want to configure the wireless settings, click [Setup now] and follow the instructions on the window that appears.

If you do not want to configure the wireless settings, click the [Later] button. When you connect the ScanSnap to a wireless LAN later, refer to "[Connecting the ScanSnap via Wireless LAN \(iX1300 / iX500 / iX100\)](#)" (page 146).

HINT

- If there are available updates for ScanSnap Online Update on the server, you will be asked whether you accept the license agreement terms for ScanSnap Online Update.
For details about ScanSnap Online Update, refer to the ScanSnap Online Update Help.
- To save images created from documents that you scanned with the ScanSnap to a mobile device or a cloud service directly, you need to connect the ScanSnap to the mobile device or the ScanSnap Cloud server.
For details, refer to "[Connecting the ScanSnap to a Mobile Device or the ScanSnap Cloud Server \(iX1600 / iX1500 / iX1300 / iX500 / iX100\)](#)" (page 55).

3

Checking the Scanning Operation

For details about how to scan a document, refer to "[Scanning Documents with iX1300](#)" (page 228).

When scanning documents all at once (**U-turn Scan**)

1. Load documents in the ADF paper chute (cover).

Load the document face-up and head-first with the front facing you (when loading multiple documents, the first page is on the top).

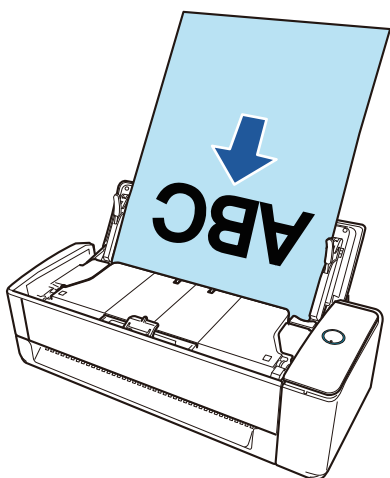

2. Press the [Scan] button to start scanning.

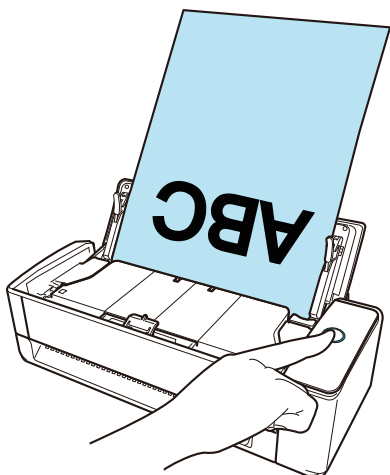

Once the Quick Menu for selecting an application to perform a particular action appears, the check process for the scanning operation is complete.

Clicking an icon on the Quick Menu allows you to save images created from documents that you scanned with the ScanSnap to your desired folder, or attach them to an e-mail.

When scanning documents one by one (**Return Scan**)

1. Insert a document into the manual feeder.

Face the front side of a document upwards and insert the top end of the document straight into the middle of the manual feeder.

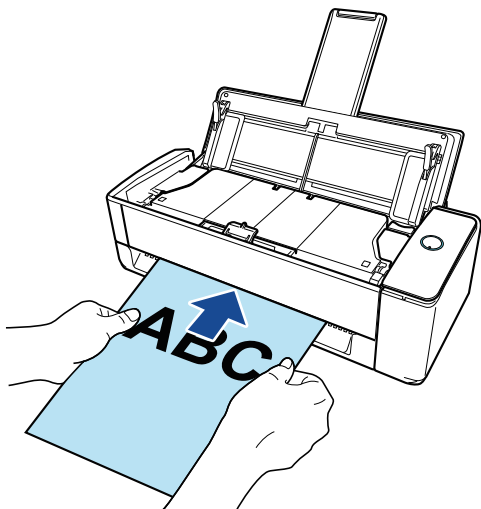

2. Press the [Scan] button to start scanning.

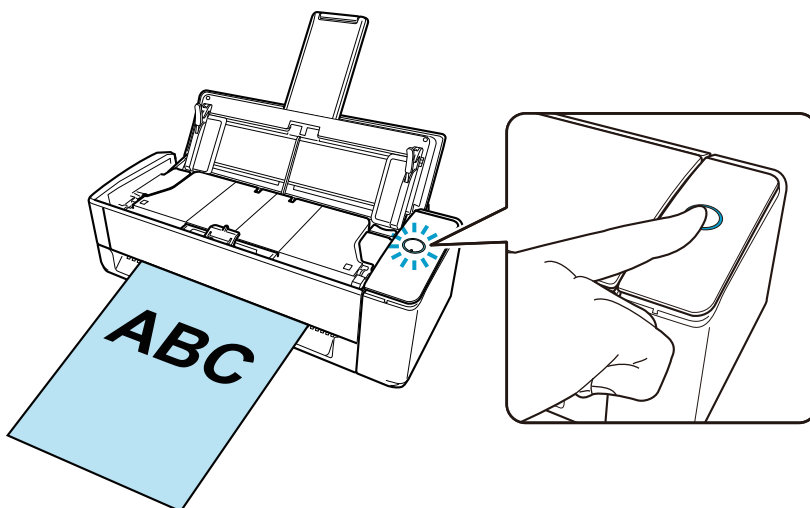

3. Press the [Scan] button on the ScanSnap to finish scanning.

Once the Quick Menu for selecting an application to perform a particular action appears, the check process for the scanning operation is complete.

Clicking an icon on the Quick Menu allows you to save images created from documents that you scanned with the ScanSnap to your desired folder, or attach them to an e-mail.

Package List for iX1300

Make sure that all items are included in the package before you set up the ScanSnap.

Items that come with the ScanSnap are as follows:

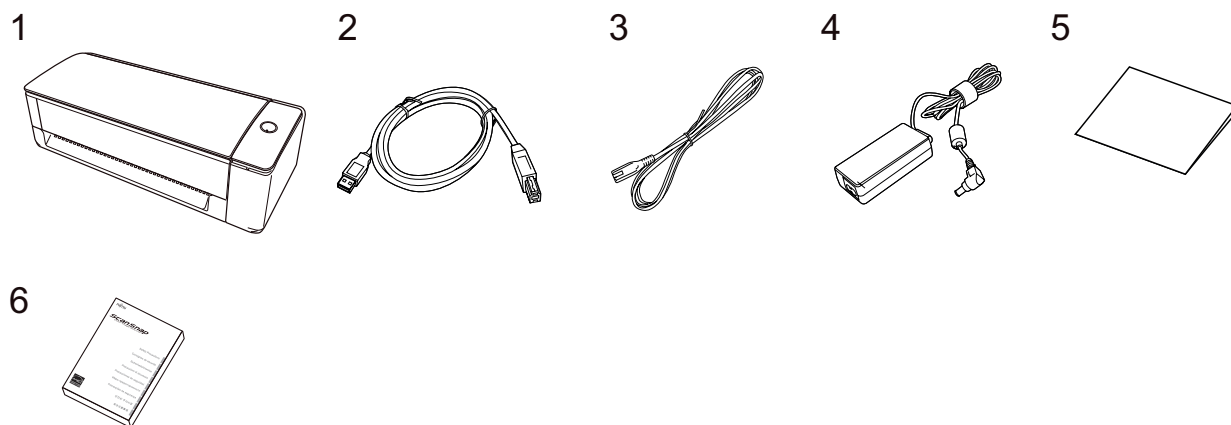

1. ScanSnap
2. USB cable
3. AC cable (*1)
4. AC adapter (*1)
5. Getting Started
6. Safety Precautions (*2)

*1: An AC cable which is connected to the AC adapter is called a power cable.

*2: The format varies depending on the ScanSnap model or the country where the ScanSnap is purchased.

Setting Up iX500

Set up the ScanSnap so that it is ready to scan with ScanSnap Manager.

The following preparations are required before you set up the ScanSnap.

ATTENTION

Do not connect the ScanSnap to the computer before installing the software.

- Check that all items are included in the package
For details, refer to Getting Started that is supplied with the ScanSnap.
- Remove the protective inner cover and tape (1) and the cardboard sheet (2) from the ScanSnap

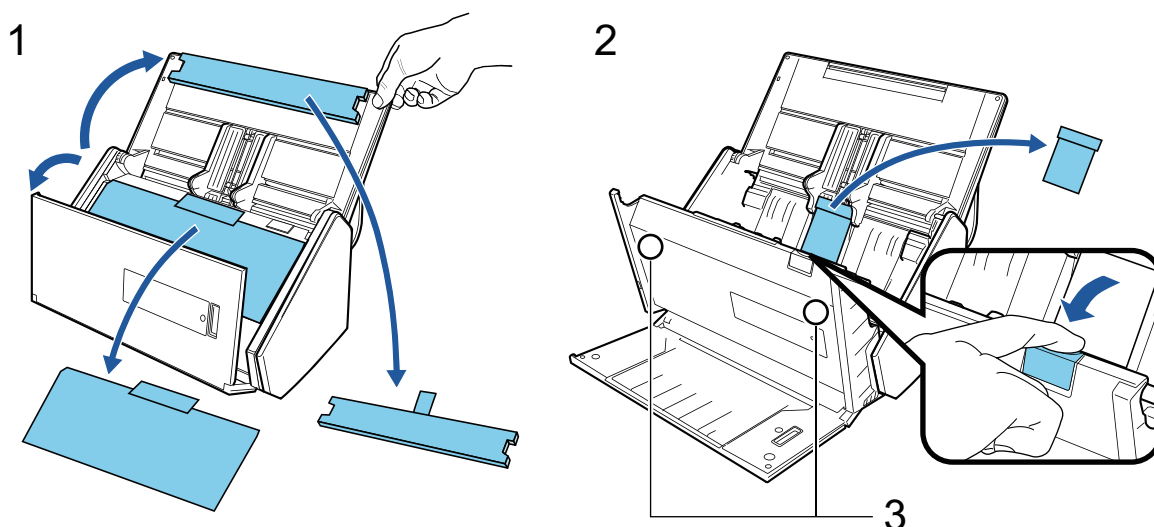

The data on the card may be lost if the black magnetic part of a magnetic card or IC card is in contact with the magnetic part (3).

The procedure to set up the ScanSnap is as follows:

- 1 Downloading the Software
- 2 Installing the Software/Connecting the ScanSnap
- 3 Checking the Scanning Operation

1

Downloading the Software

1. Turn on the computer and log on as a user with Administrator privileges.
2. Access the website "[ScanSnap Installer](#)".
3. Download [ScanSnap Installer] and save it on your computer.
By using the installer that you downloaded, you can install the following software programs.
 - ScanSnap Manager
 - ScanSnap Online Update
 - ScanSnap manual

Install software applications other than the above if needed.

For the overview for each software program, refer to ["Overview of the Software Related to the ScanSnap" \(page 98\)](#).

2

Installing the Software/Connecting the ScanSnap

1. Run the installer that you saved on your computer.
2. Follow the instructions on the [ScanSnap Installer] window that appears.
When you are asked whether you accept the license agreement terms, read the confirmation message and select [I agree to all terms and conditions].
3. When [Installation complete] appears, click the [Complete] button.
4. When the [About ScanSnap's Auto Power OFF function] window appears, read the message and click the [Next] button.
5. Follow the instructions on the [ScanSnap - Connecting the ScanSnap] window to connect the ScanSnap to a computer.
6. On the [ScanSnap wireless network setup] window, select whether to configure the wireless settings in order for the ScanSnap to be connected to a wireless LAN.
If you want to configure the wireless settings, click [Setup now] and follow the instructions on the window that appears.
If you do not want to configure the wireless settings, click the [Later] button. When you connect the ScanSnap to a wireless LAN later, refer to ["Connecting the ScanSnap via Wireless LAN \(iX1300 / iX500 / iX100\)" \(page 146\)](#).

HINT

- If there are available updates for ScanSnap Online Update on the server, you will be asked whether you accept the license agreement terms for ScanSnap Online Update.
For details about ScanSnap Online Update, refer to the ScanSnap Online Update Help.
- To save images created from documents that you scanned with the ScanSnap to a mobile device or a cloud service directly, you need to connect the ScanSnap to the mobile device or the ScanSnap Cloud server.
For details, refer to ["Connecting the ScanSnap to a Mobile Device or the ScanSnap Cloud Server \(iX1600 / iX1500 / iX1300 / iX500 / iX100\)" \(page 55\)](#).

3

Checking the Scanning Operation

1. Load a document in the ScanSnap.
Load a document face-down and head-first with the back facing you (when loading multiple documents, the last page is on the top).
For details about how to scan a document, refer to ["Scanning Documents with iX500" \(page 286\)](#).

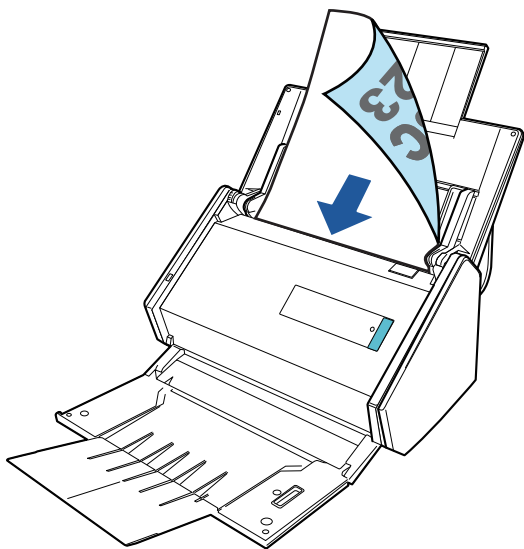

2. Press the [Scan] button to start scanning.

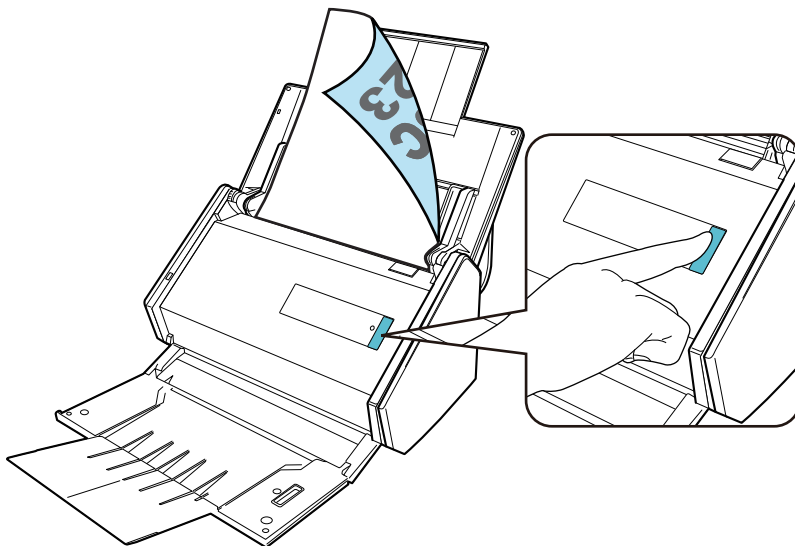

Once the Quick Menu for selecting an application to perform a particular action appears, the check process for the scanning operation is complete.

Clicking an icon on the Quick Menu allows you to save images created from documents that you scanned with the ScanSnap to your desired folder, or attach them to an e-mail.

Setting Up iX100

Set up the ScanSnap so that it is ready to scan with ScanSnap Manager.

The following preparations are required before you set up the ScanSnap.

- Check that all items are included in the package
For details, refer to "[Package List for iX100](#)" (page 41).

HINT

When Getting Started is included in the package, refer to "Package List" in Getting Started.

- Remove the tape seal (1) and tape (2) from the ScanSnap

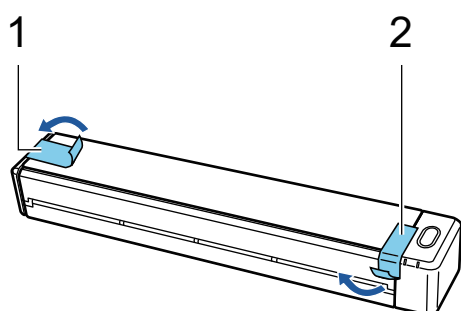

- Connect the ScanSnap and the computer with a USB cable, and charge the battery until the battery indicator light turns off

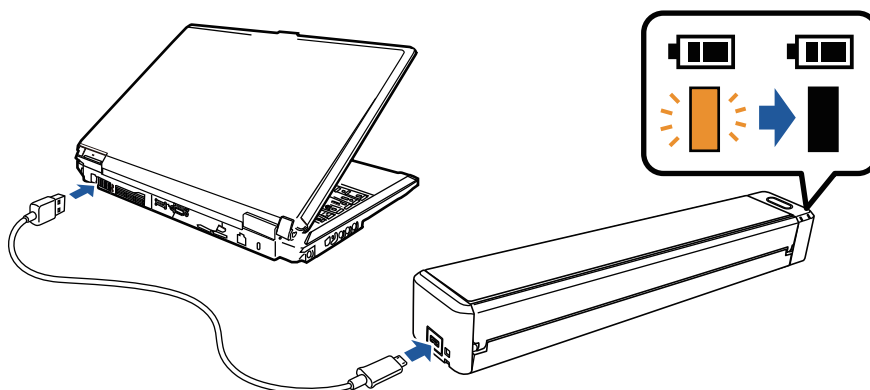

ATTENTION

- Do not open the feed guide until the instructions are displayed on the window for installing software.
- The ScanSnap can be charged with the supplied USB cable or optional USB power adapter. For details about purchasing the USB power adapter, refer to "Suppliers of Consumables/Optional Parts" in "[About Customer Support and Maintenance](#)" (page 606).

The procedure to set up the ScanSnap is as follows:

- 1 [Downloading the Software](#)
- 2 [Installing the Software/Connecting the ScanSnap](#)
- 3 [Checking the Scanning Operation](#)

1

Downloading the Software

1. Turn on the computer and log on as a user with Administrator privileges.
2. Access the website "[ScanSnap Installer](#)".
3. Download [ScanSnap Installer] and save it on your computer.

By using the installer that you downloaded, you can install the following software programs.

- ScanSnap Manager
- ScanSnap Online Update
- ScanSnap manual

Install software applications other than the above if needed.

For the overview for each software program, refer to "[Overview of the Software Related to the ScanSnap](#)" (page 98).

2

Installing the Software/Connecting the ScanSnap

1. Run the installer that you saved on your computer.
2. Follow the instructions on the [ScanSnap Installer] window that appears.
When you are asked whether you accept the license agreement terms, read the confirmation message and select [I agree to all terms and conditions].
3. When [Installation complete] appears, click the [Complete] button.
4. When the [About ScanSnap's Auto Power OFF function] window appears, read the message and click the [Next] button.
5. Follow the instructions on the [ScanSnap - Connecting the ScanSnap] window to connect the ScanSnap to a computer.
6. On the [ScanSnap wireless network setup] window, select whether to configure the wireless settings in order for the ScanSnap to be connected to a wireless LAN.

If you want to configure the wireless settings, click [Setup now] and follow the instructions on the window that appears.

If you do not want to configure the wireless settings, click the [Later] button. When you connect the ScanSnap to a wireless LAN later, refer to "[Connecting the ScanSnap via Wireless LAN \(iX1300 / iX500 / iX100\)](#)" (page 146).

HINT

- If there are available updates for ScanSnap Online Update on the server, you will be asked whether you accept the license agreement terms for ScanSnap Online Update.
For details about ScanSnap Online Update, refer to the ScanSnap Online Update Help.

- To save images created from documents that you scanned with the ScanSnap to a mobile device or a cloud service directly, you need to connect the ScanSnap to the mobile device or the ScanSnap Cloud server.

For details, refer to "[Connecting the ScanSnap to a Mobile Device or the ScanSnap Cloud Server \(iX1600 / iX1500 / iX1300 / iX500 / iX100\)](#)" (page 55).

3

Checking the Scanning Operation

1. Insert a document in the ScanSnap.

Insert a document straight into the feeding section of the ScanSnap, with the scanning side facing up.

For details about how to scan a document, refer to "[Scanning Documents with iX100](#)" (page 315).

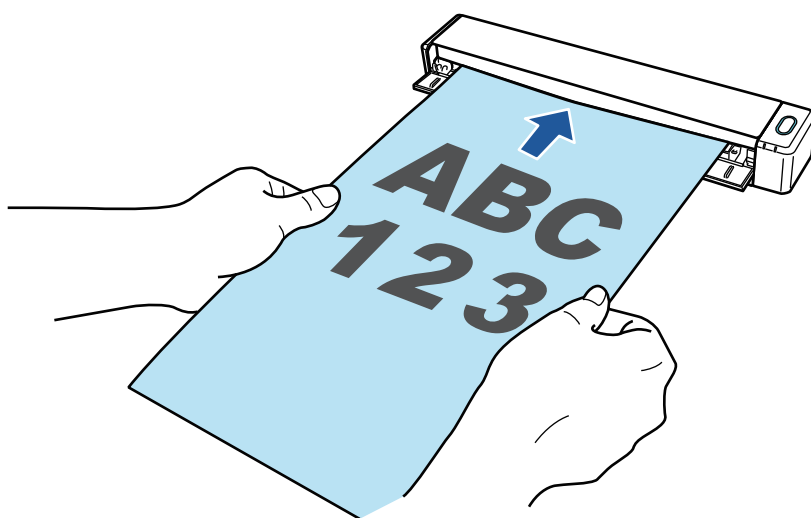

2. Press the [Scan/Stop] button to start scanning.

To continue scanning, insert the next document to be scanned. When the document is inserted, scanning starts automatically.

When the scanning of documents is complete, press the [Scan/Stop] button to finish scanning documents.

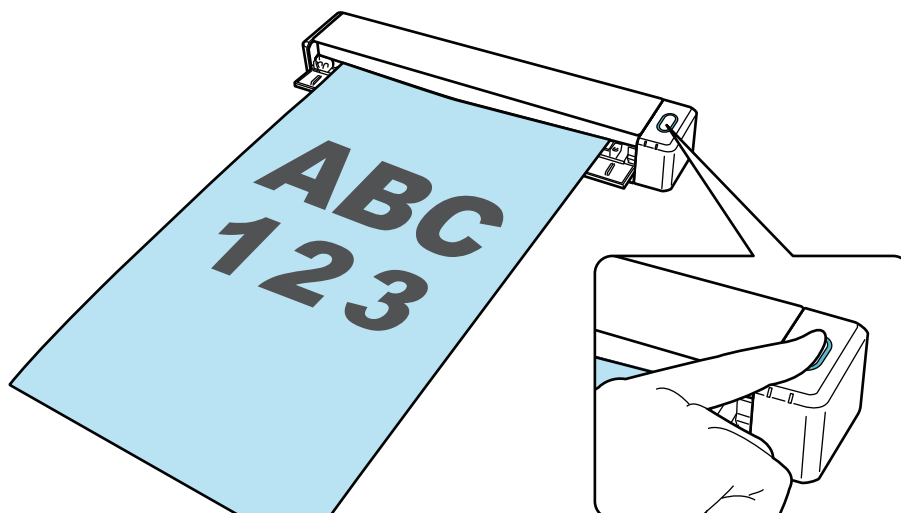

Once the Quick Menu for selecting an application to perform a particular action appears, the check process for the scanning operation is complete.

Clicking an icon on the Quick Menu allows you to save images created from documents that you scanned with the ScanSnap to your desired folder, or attach them to an e-mail.

Package List for iX100

Make sure that all items are included in the package before you set up the ScanSnap.

Items that come with the ScanSnap are as follows:

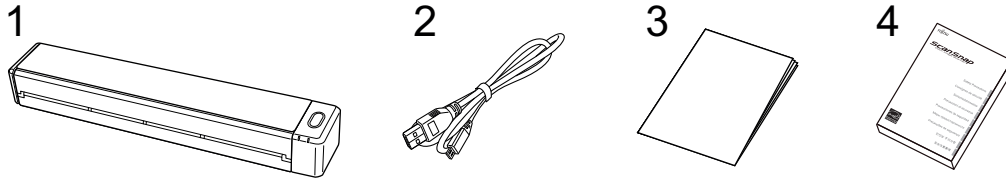

1. ScanSnap
2. USB cable
3. Welcome Guide
4. Safety Precautions

Setting Up SV600

Set up the ScanSnap so that it is ready to scan with ScanSnap Manager.

The following preparations are required before you set up the ScanSnap.

ATTENTION

Do not connect the ScanSnap to the computer before installing the software.

- Check that all items are included in the package
For details, refer to "Package List for SV600" (page 46).

HINT

When Getting Started is included in the package, refer to "Package List" in Getting Started.

- Remove the tape (1) and tape seal (2) from the ScanSnap

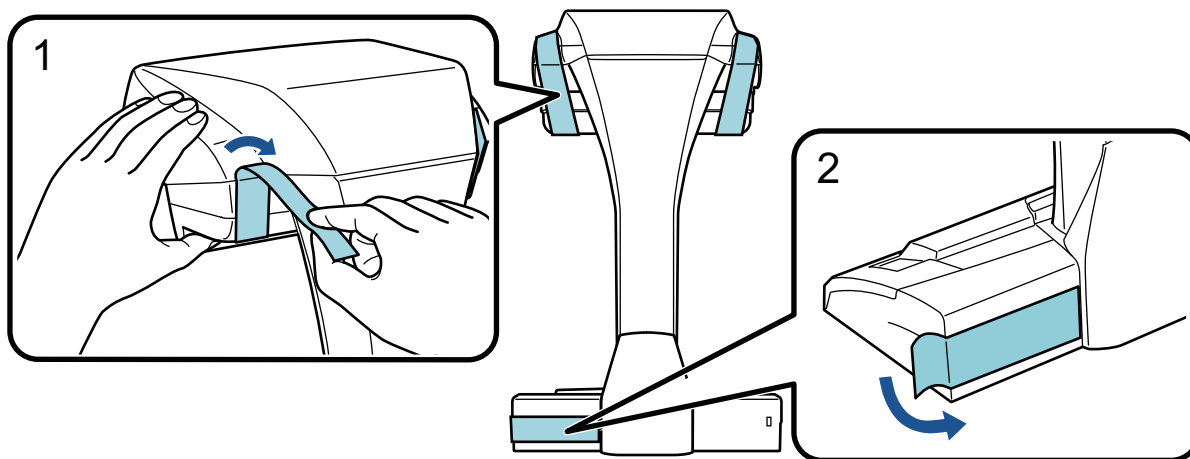

- Attach the extenders to the ScanSnap

ATTENTION

The following preparations are required before you attach the extenders.

- Wipe off dust and dirt such as oily dirt on the place where the extenders will be attached
- Peel the protective tape off the bottom of the extenders

Leaving about 3 to 5 mm of space between the extenders and the back and side of the ScanSnap, push the extenders down until they lock in place. If the extenders are placed against the side of the ScanSnap base or the protrusion of the extenders are placed on the ScanSnap base, the bottom of the extenders may not stay in place firmly.

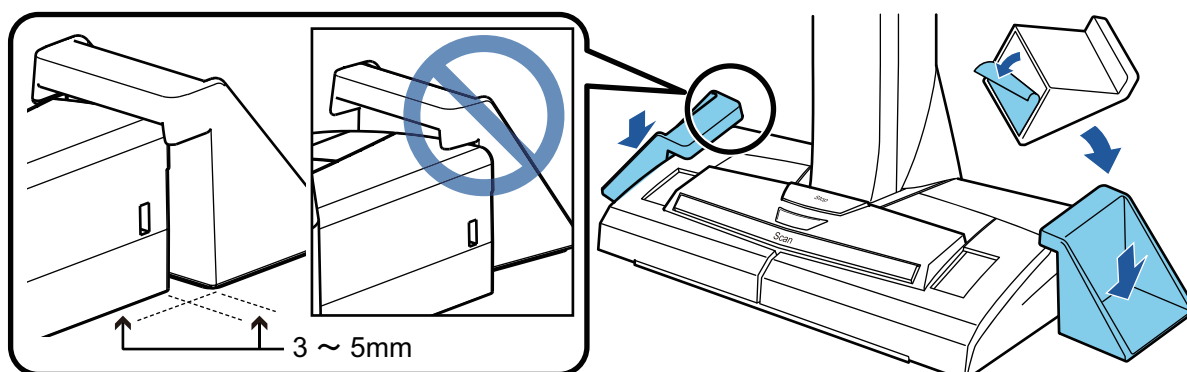

The procedure to set up the ScanSnap is as follows:

- 1 Downloading the Software
- 2 Installing the Software/Connecting the ScanSnap
- 3 Checking the Scanning Operation

1

Downloading the Software

1. Turn on the computer and log on as a user with Administrator privileges.
2. Access the website "[ScanSnap Installer](#)".
3. Download [ScanSnap Installer] and save it on your computer.
By using the installer that you downloaded, you can install the following software programs.
 - ScanSnap Manager
 - ScanSnap Online Update
 - ScanSnap manual

Install software applications other than the above if needed.

For the overview for each software program, refer to "[Overview of the Software Related to the ScanSnap](#)" (page 98).

2

Installing the Software/Connecting the ScanSnap

1. Run the installer that you saved on your computer.
2. Follow the instructions on the [ScanSnap Installer] window that appears.
When you are asked whether you accept the license agreement terms, read the confirmation message and select [I agree to all terms and conditions].
3. When [Installation complete] appears, click the [Complete] button.
4. When the [About ScanSnap's Auto Power OFF function] window appears, read the message and click the [Next] button.
5. Follow the instructions on the [ScanSnap - Connecting the ScanSnap] window to connect the ScanSnap to a computer.

HINT

If there are available updates for ScanSnap Online Update on the server, you will be asked whether you accept the license agreement terms for ScanSnap Online Update.

For details about ScanSnap Online Update, refer to the ScanSnap Online Update Help.

3

Checking the Scanning Operation

1. Place the Background Pad with a document towards the ScanSnap so that they are in contact with the ScanSnap (1) and then press the [Scan] button (2) to start a scan.

Place a document with the scanning side facing up on the Background Pad.

For details about how to scan a document, refer to "Scanning Documents with SV600" (page 345).

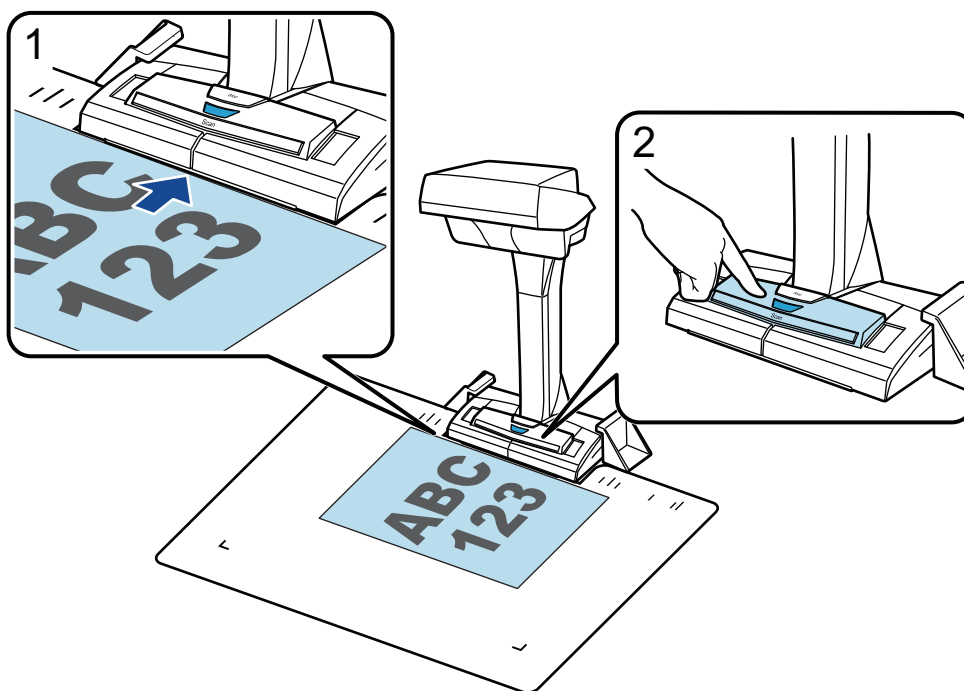

2. Click the [Finish Scanning] button in the [ScanSnap Manager - Image scanning and file saving] window.

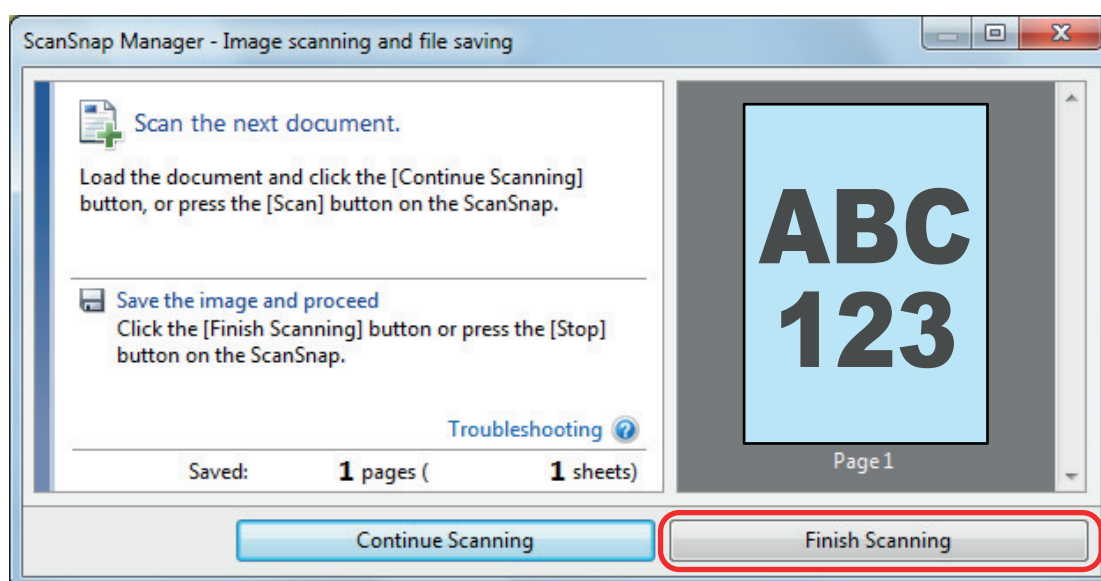

3. Select [Crop and save flat document images as-is] and then click the [Save this image] button.

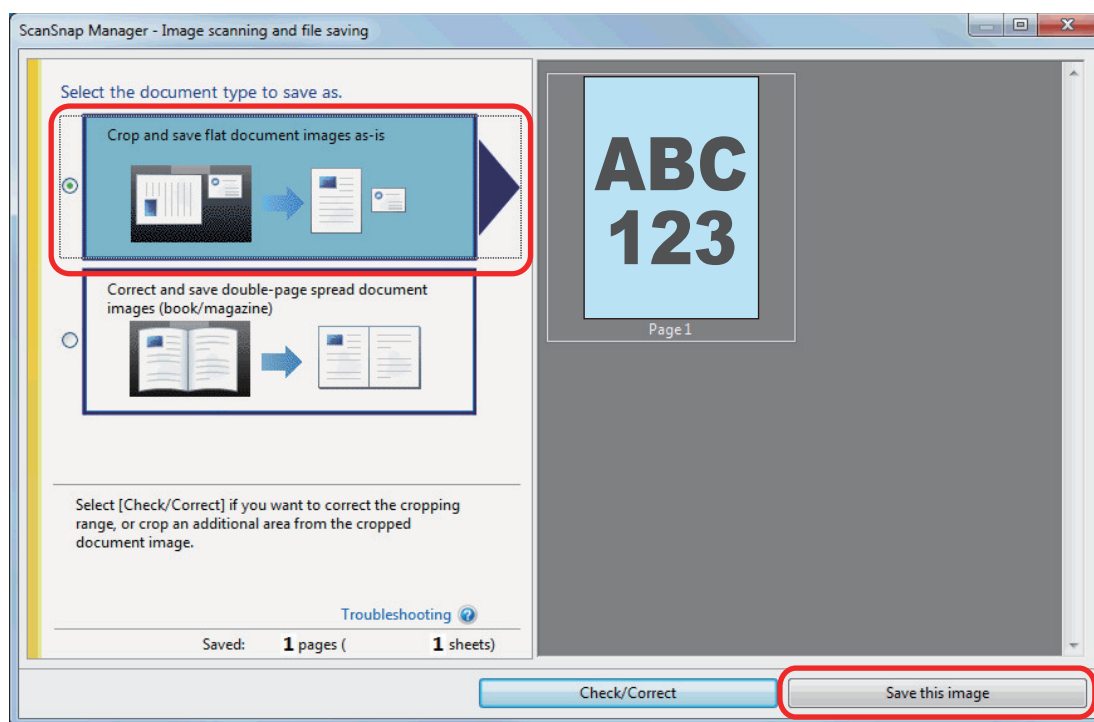

Once the Quick Menu for selecting an application to perform a particular action appears, the check process for the scanning operation is complete.

Clicking an icon on the Quick Menu allows you to save images created from documents that you scanned with the ScanSnap to your desired folder, or attach them to an e-mail.

Package List for SV600

Make sure that all items are included in the package before you set up the ScanSnap.

Items that come with the ScanSnap are as follows:

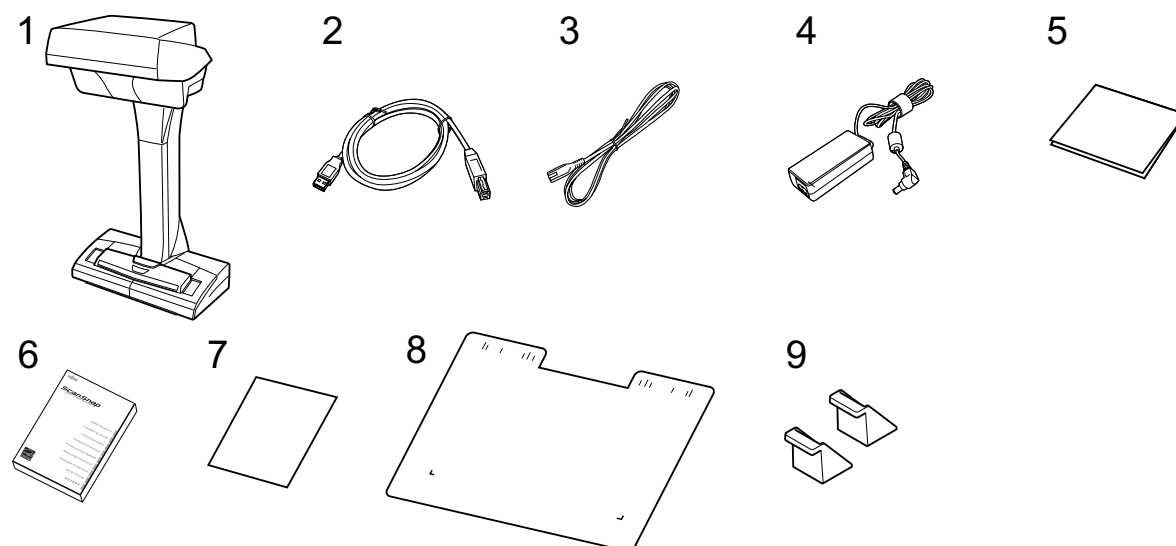

1. ScanSnap
2. USB cable
3. AC cable (*1)
4. AC adapter (*1)
5. Welcome Guide
6. Safety Precautions (*2)
7. License certificate of Kofax Power PDF Standard/Kofax Power PDF Standard for Mac, License certificate of Nuance Power PDF Standard/Nuance Power PDF Standard for Mac, or License certificate of Nuance Power PDF Standard/Nuance PDF Converter for Mac
8. Background Pad
9. Extenders

*1: An AC cable which is connected to the AC adapter is called a power cable.

*2: The format varies depending on the ScanSnap model or the country where the ScanSnap is purchased.

Setting Up S1300i

Set up the ScanSnap so that it is ready to scan with ScanSnap Manager.

The following preparations are required before you set up the ScanSnap.

ATTENTION

Do not connect the ScanSnap to the computer before installing the software.

- Check that all items are included in the package
For details, refer to "[Package List for S1300i](#)" (page 50).

HINT

When Getting Started is included in the package, refer to "Package List" in Getting Started.

- Remove the tape seal (1) from the ScanSnap

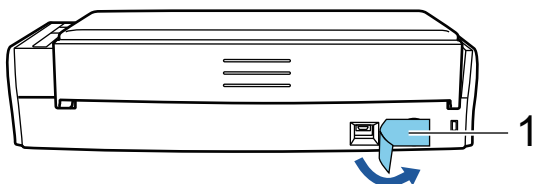

The procedure to set up the ScanSnap is as follows:

- 1 [Downloading the Software](#)
- 2 [Installing the Software/Connecting the ScanSnap](#)
- 3 [Checking the Scanning Operation](#)

1

Downloading the Software

1. Turn on the computer and log on as a user with Administrator privileges.
2. Access the website "[ScanSnap Installer](#)".
3. Download [ScanSnap Installer] and save it on your computer.
By using the installer that you downloaded, you can install the following software programs.
 - ScanSnap Manager
 - ScanSnap Online Update
 - ScanSnap manual

Install software applications other than the above if needed.

For the overview for each software program, refer to "[Overview of the Software Related to the ScanSnap](#)" (page 98).

2

Installing the Software/Connecting the ScanSnap

1. Run the installer that you saved on your computer.
2. Follow the instructions on the [ScanSnap Installer] window that appears.
When you are asked whether you accept the license agreement terms, read the confirmation message and select [I agree to all terms and conditions].
3. When [Installation complete] appears, click the [Complete] button.
4. When the [About ScanSnap's Auto Power OFF function] window appears, read the message and click the [Next] button.
5. Follow the instructions on the [ScanSnap - Connecting the ScanSnap] window to connect the ScanSnap to a computer.

HINT

If there are available updates for ScanSnap Online Update on the server, you will be asked whether you accept the license agreement terms for ScanSnap Online Update.

For details about ScanSnap Online Update, refer to the ScanSnap Online Update Help.

3

Checking the Scanning Operation

1. Load a document in the ScanSnap.
Load a document face-down and head-first with the back facing you (when loading multiple documents, the last page is on the top).
For details about how to scan a document, refer to "[Scanning Documents with S1300i](#)" (page 373).

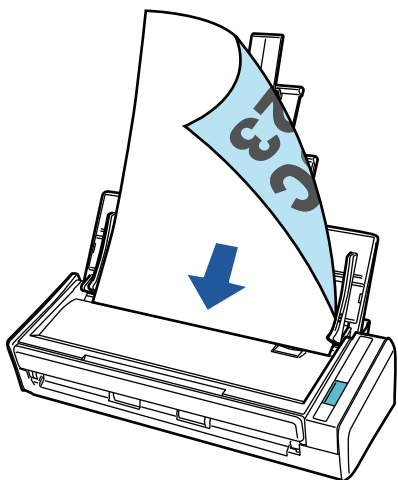

2. Press the [Scan] button to start scanning.

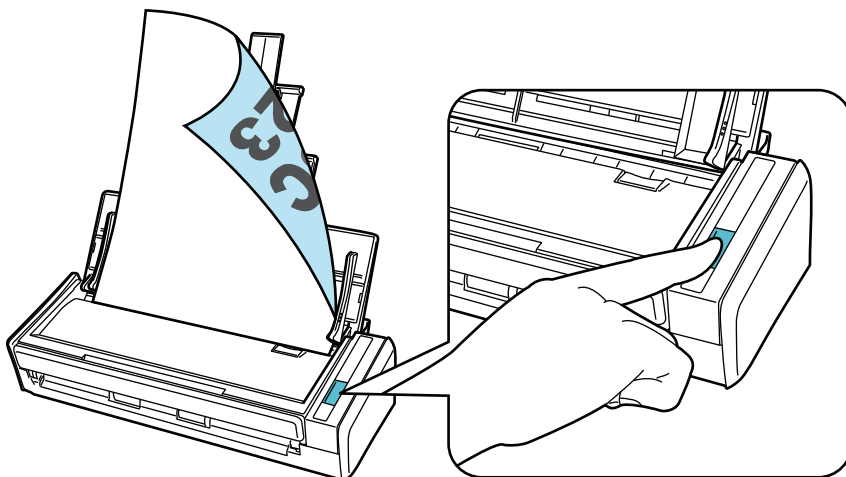

Once the Quick Menu for selecting an application to perform a particular action appears, the check process for the scanning operation is complete.

Clicking an icon on the Quick Menu allows you to save images created from documents that you scanned with the ScanSnap to your desired folder, or attach them to an e-mail.

Package List for S1300i

Make sure that all items are included in the package before you set up the ScanSnap.

Items that come with the ScanSnap are as follows:

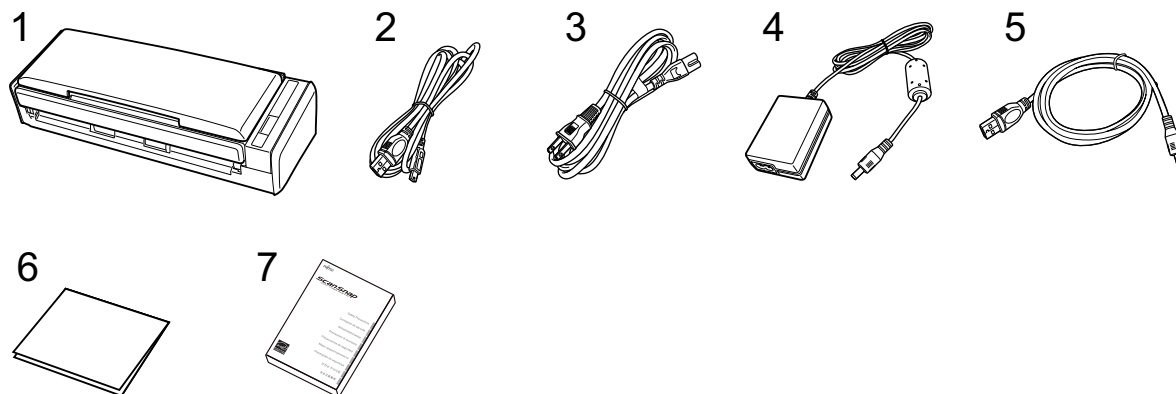

1. ScanSnap
2. USB cable
3. AC cable (*1)
4. AC adapter (*1)
5. USB bus power cable
6. Welcome Guide
7. Safety Precautions (*2)

*1: An AC cable which is connected to the AC adapter is called a power cable.

*2: The format varies depending on the ScanSnap model or the country where the ScanSnap is purchased.

Setting Up S1100i

Set up the ScanSnap so that it is ready to scan with ScanSnap Manager.

The following preparations are required before you set up the ScanSnap.

- Check that all items are included in the package

For details, refer to "[Package List for S1100i](#)" (page 54).

HINT

When Getting Started is included in the package, refer to "Package List" in Getting Started.

- Remove the tape seal (1) and tape (2) from the ScanSnap

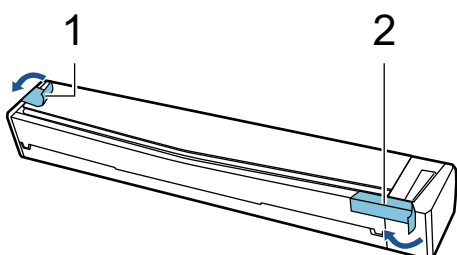

The procedure to set up the ScanSnap is as follows:

1 [Downloading the Software](#)

2 [Installing the Software/Connecting the ScanSnap](#)

3 [Checking the Scanning Operation](#)

1

Downloading the Software

1. Turn on the computer and log on as a user with Administrator privileges.
2. Access the website "[ScanSnap Installer](#)".
3. Download [[ScanSnap Installer](#)] and save it on your computer.

By using the installer that you downloaded, you can install the following software programs.

- ScanSnap Manager
- ScanSnap Online Update
- ScanSnap manual

Install software applications other than the above if needed.

For the overview for each software program, refer to "[Overview of the Software Related to the ScanSnap](#)" (page 98).

2

Installing the Software/Connecting the ScanSnap

1. Run the installer that you saved on your computer.

2. Follow the instructions on the [ScanSnap Installer] window that appears.
When you are asked whether you accept the license agreement terms, read the confirmation message and select [I agree to all terms and conditions].
3. When [Installation complete] appears, click the [Complete] button.
4. Follow the instructions on the [ScanSnap - Connecting the ScanSnap] window to connect the ScanSnap to a computer.

HINT

If there are available updates for ScanSnap Online Update on the server, you will be asked whether you accept the license agreement terms for ScanSnap Online Update.

For details about ScanSnap Online Update, refer to the ScanSnap Online Update Help.

3

Checking the Scanning Operation

1. Insert a document in the ScanSnap.

Insert a document straight into the feeding section of the ScanSnap, with the scanning side facing up.

For details about how to scan a document, refer to "[Scanning Documents with S1100i](#)" (page 390).

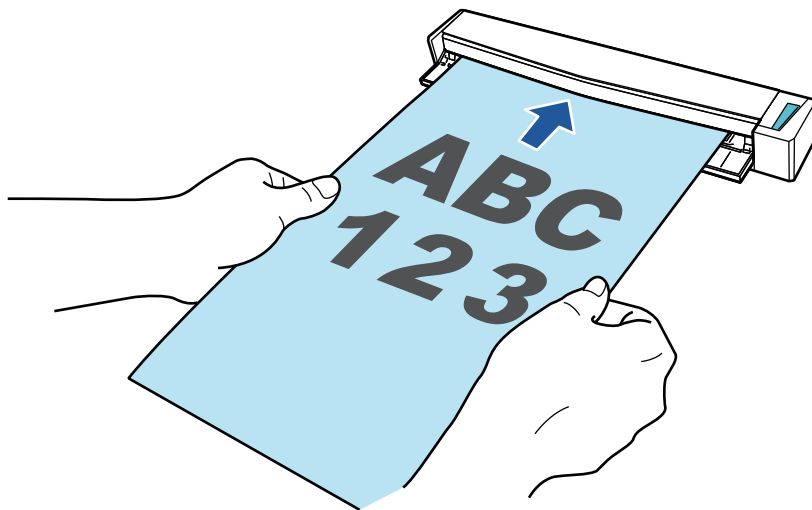

2. Press the [Scan/Stop] button to start scanning.
To continue scanning, insert the next document to be scanned. When the document is inserted, scanning starts automatically.
When the scanning of documents is complete, press the [Scan/Stop] button to finish scanning documents.

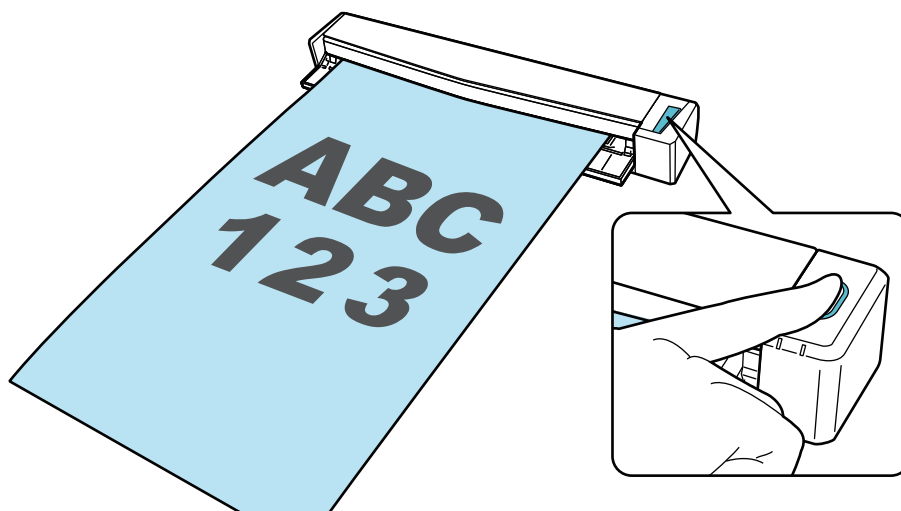

Once the Quick Menu for selecting an application to perform a particular action appears, the check process for the scanning operation is complete.

Clicking an icon on the Quick Menu allows you to save images created from documents that you scanned with the ScanSnap to your desired folder, or attach them to an e-mail.

Package List for S1100i

Make sure that all items are included in the package before you set up the ScanSnap.

Items that come with the ScanSnap are as follows:

1

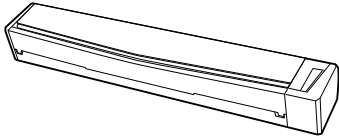

2



3

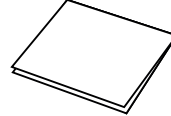

4



1. ScanSnap
2. USB cable
3. Welcome Guide
4. Safety Precautions (*1)

*1: The format varies depending on the ScanSnap model or the country where the ScanSnap is purchased.

Connecting the ScanSnap to a Mobile Device or the ScanSnap Cloud Server (iX1600 / iX1500 / iX1300 / iX500 / iX100)

Connecting the ScanSnap to a mobile device or the ScanSnap Cloud server allows you to save scanned images to the mobile device or a cloud server directly.

The ScanSnap Cloud server is a cloud server used exclusively with the ScanSnap.

Preparation for Connecting the ScanSnap to a Mobile Device

Use ScanSnap Connect Application in order to connect the ScanSnap to a mobile device and save images created from documents that you scanned with the ScanSnap to a mobile device directly.

Prepare according to the following procedures:

ATTENTION

To connect iX1600/iX1500/iX500/iX100 and a mobile device, you need to connect the ScanSnap and the mobile device to the same wireless access point.

For details about how to connect the ScanSnap to a wireless access point, refer to the following:

- iX1600/iX1500
"Connecting the ScanSnap via Wireless LAN (iX1600 / iX1500)" (page 132)
- iX500/iX100
"Connecting the ScanSnap via Wireless LAN (iX1300 / iX500 / iX100)" (page 146)

HINT

To connect iX1300 and a mobile device, you can establish a connection to a wireless access point by following the instructions in the wizard that appears after installing ScanSnap Connect Application.

1. Install ScanSnap Connect Application on the mobile device.



Obtain ScanSnap Connect Application from one of the following application stores in accordance with your mobile device:

- App Store
- Google Play
- Amazon Appstore

2. Start up ScanSnap Connect Application.

Perform operations while following the instructions.

For details about how to operate ScanSnap Connect Application, refer to the Basic Operation Guide (Mobile Connection).

To display the Basic Operation Guide (Mobile Connection), start up ScanSnap Connect Application on your mobile device, tap the  button (iOS)/  (Android) → the [Help] button in the [File List] screen.

Preparation for Connecting the ScanSnap to the ScanSnap Cloud Server

Use the ScanSnap Cloud application in order to connect the ScanSnap to the ScanSnap Cloud server and save images created from documents that you scanned with the ScanSnap to a cloud service directly.

For details about how to set up and operate ScanSnap Cloud, refer to the [ScanSnap Cloud Help](#).

For regions where ScanSnap Cloud can be used, refer to [here](#).

ScanSnap Overview

This section provides an overview that you should be aware of before operating ScanSnap.

- ["What You Can Do with the ScanSnap" \(page 58\)](#)
- ["Parts and Functions" \(page 78\)](#)
- ["Charging the Battery \(iX100\)" \(page 96\)](#)
- ["Overview of the Software Related to the ScanSnap" \(page 98\)](#)
- ["ScanSnap Manager Icon" \(page 99\)](#)
- ["Right-Click Menu" \(page 100\)](#)
- ["ScanSnap Setup Window" \(page 102\)](#)
- ["Turning the ScanSnap On or Off" \(page 104\)](#)
- ["Screens and Operations on the Touch Panel \(iX1600 / iX1500\)" \(page 120\)](#)
- ["Attaching the Receipt Guide \(iX1600 / iX1500 / iX1400\)" \(page 128\)](#)

What You Can Do with the ScanSnap

- ["What You Can Do with iX1600 / iX1500 / iX1400" \(page 59\)](#)
- ["What You Can Do with iX1300" \(page 62\)](#)
- ["What You Can Do with iX500" \(page 66\)](#)
- ["What You Can Do with iX100" \(page 68\)](#)
- ["What You Can Do with SV600" \(page 71\)](#)
- ["What You Can Do with S1300i" \(page 74\)](#)
- ["What You Can Do with S1100i" \(page 75\)](#)

What You Can Do with iX1600 / iX1500 / iX1400

Scanning Multiple Documents

A document stack with a thickness of 5 mm (0.2 in.) or less (for A4 or smaller sizes: up to 50 sheets with 80 g/m² [20 lb] paper weight) can be loaded into the ScanSnap for scanning.

For details, refer to "[Scanning Documents \(iX1600 / iX1500 / iX1400\)](#)" (page 202).

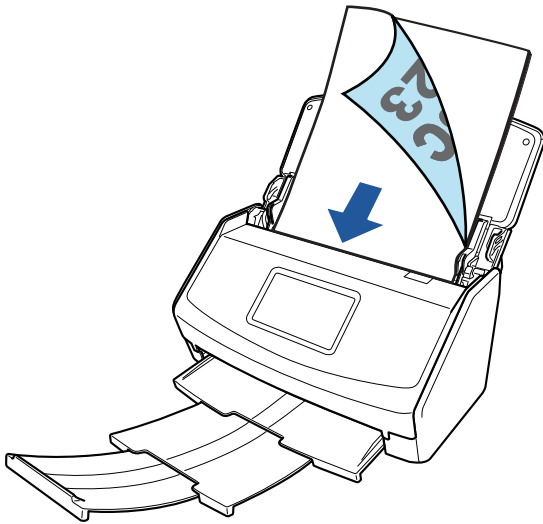

Example: iX1600

Scanning Small Size Documents such as Receipts in One Go

If the Receipt Guide is attached to the ScanSnap, a batch of small size documents such as receipts can be loaded and scanned in the ScanSnap at the same.

For details, refer to "[Scanning Small Size Documents such as Receipts in One Go \(iX1600 / iX1500 / iX1400\)](#)" (page 216).

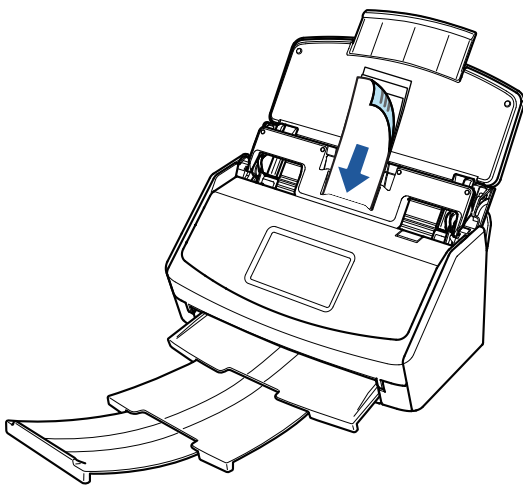

Example: iX1600

Scanning Documents That Cannot Be Loaded Directly in the ScanSnap

You can use the optional Carrier Sheet to scan the following documents.

- Documents that are larger than A4/Letter size and not larger than A3 size

For details, refer to "[Scanning Documents Larger Than A4 or Letter Size \(iX1600 / iX1500 / iX1400\)](#)" (page 220).

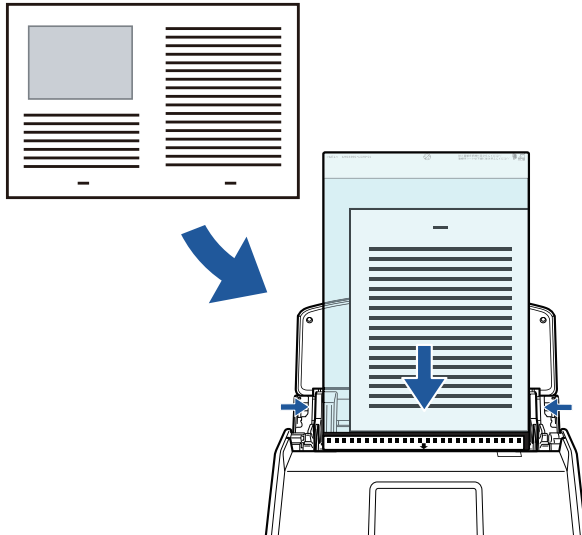

Example: iX1600

- Documents that can be damaged quite easily such as photographs, or non-standard size documents such as clippings

For details, refer to "[Scanning Documents Such as Photographs and Clippings \(iX1600 / iX1500 / iX1400\)](#)" (page 224).

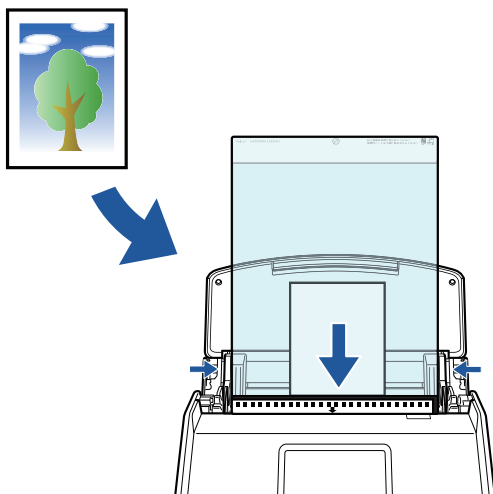

Example: iX1600

Connecting the ScanSnap via Wireless LAN

For iX1600/iX1500, you can connect the ScanSnap and a computer or mobile device via wireless LAN.

To configure the wireless settings for the ScanSnap, use the ScanSnap Wireless Setup Tool, which is installed together with ScanSnap Manager, or use the touch panel of the ScanSnap.

For details, refer to "Connecting the ScanSnap via Wireless LAN (iX1600 / iX1500)" (page 132).

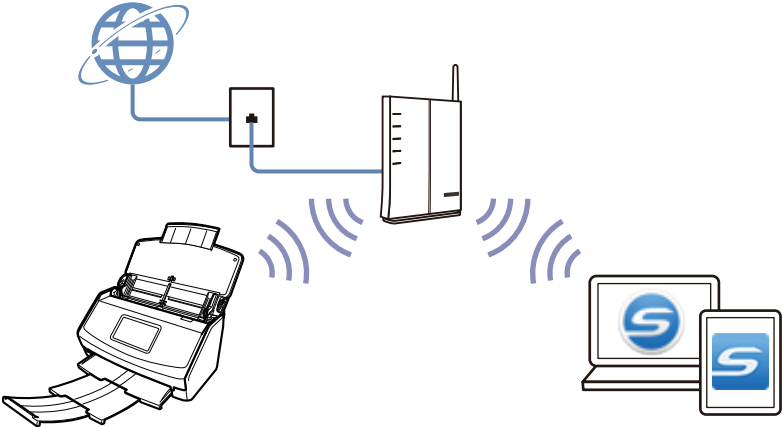

What You Can Do with iX1300

Scanning Multiple Documents (U-turn Scan)

A document stack with a thickness of 2 mm (0.08 in.) or less (for A4 or smaller sizes: up to 20 sheets with 80 g/m² [20 lb] paper weight) can be loaded into the ScanSnap for scanning.

For details, refer to "[Scanning Documents \(iX1300\)](#)" (page 235).

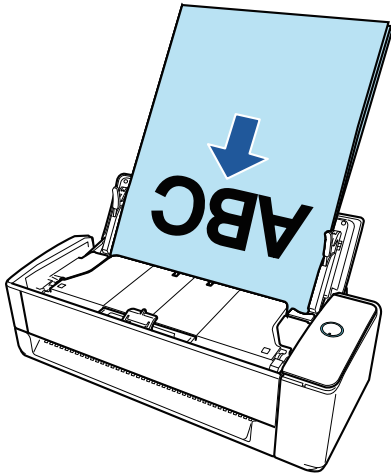

Scanning One Document at a Time (Return Scan)

Documents such as business cards, post cards, and thick documents (e.g. plastic cards and booklets) can be inserted one by one for scanning.

After scanning a document is completed, when you insert the next document in the ScanSnap, the next scan is started automatically, which enables you to scan continuously.

For details, refer to "[Scanning Documents \(iX1300\)](#)" (page 235).

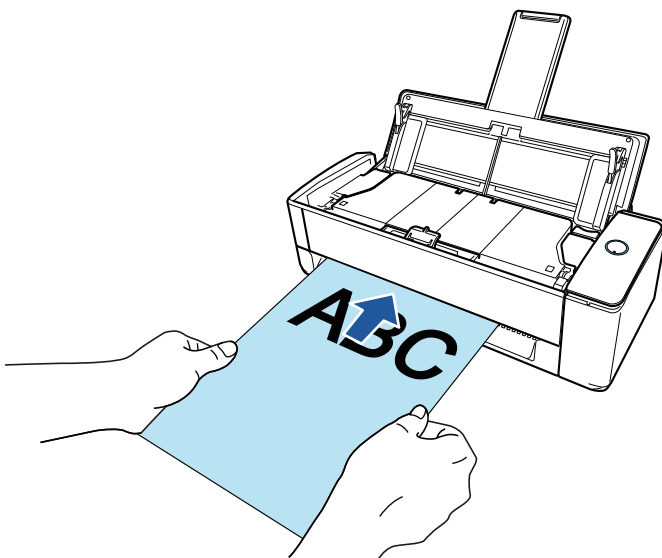

Scanning Documents Larger Than A4 or Letter Size by Directly Inserting Them in the ScanSnap

By folding an A3, B4, or Double Letter size document in half and scanning it, the scanned images of both sides can be merged as a single image automatically.

Scanned images can be merged only when there is text, diagram, or a table on the fold line of the folded document.

For details, refer to "Scanning Documents Larger Than A4 or Letter Size by Directly Inserting Them in the ScanSnap (iX1300)" (page 263).

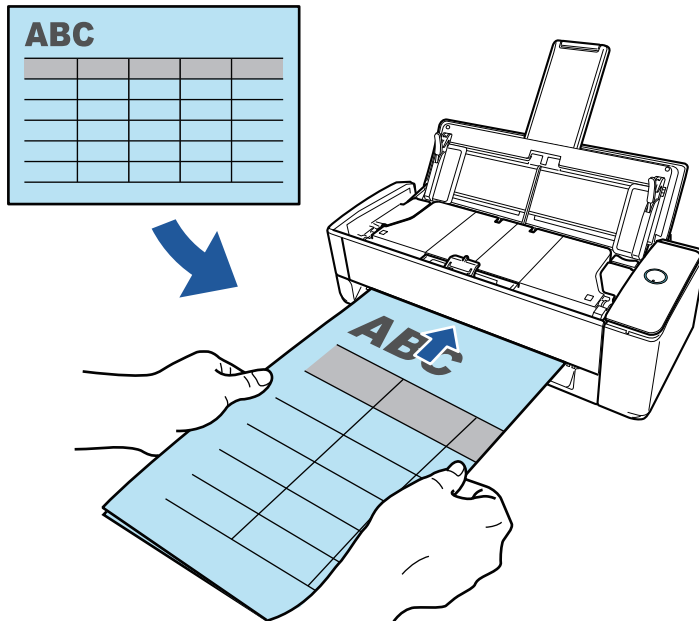

Scanning Documents That Cannot Be Loaded Directly in the ScanSnap

You can use the optional Carrier Sheet to scan the following documents.

- Documents that are larger than A4/Letter size and not larger than A3 size

For details, refer to "Scanning Documents Larger than A4 or Letter Size with the Carrier Sheet (iX1300)" (page 268).

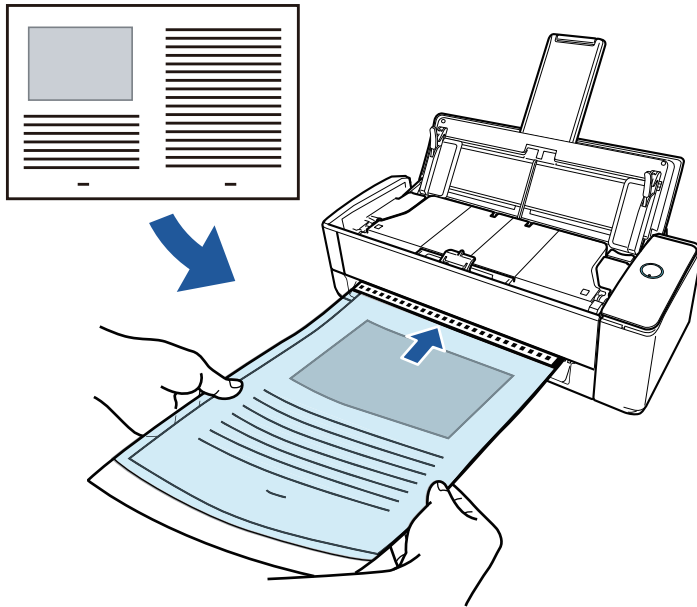

- Documents that can be damaged quite easily such as photographs, or non-standard size documents such as clippings

For details, refer to "[Scanning Documents Such as Photographs and Clippings \(iX1300\)](#)" (page 274).

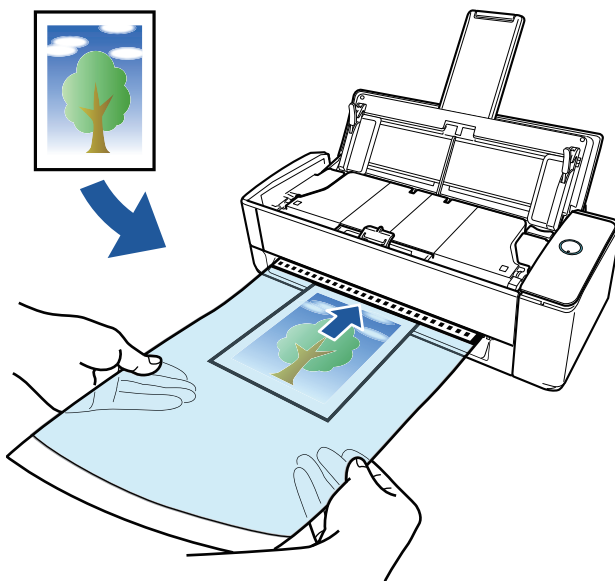

Connecting the ScanSnap via Wireless LAN

You can connect the ScanSnap and a computer or mobile device via wireless LAN.

To configure the wireless settings for the ScanSnap, use the ScanSnap Wireless Setup Tool, which is installed together with ScanSnap Manager, or use the touch panel of the ScanSnap.

For details, refer to "[Connecting the ScanSnap via Wireless LAN \(iX1300 / iX500 / iX100\)](#)" (page 146).

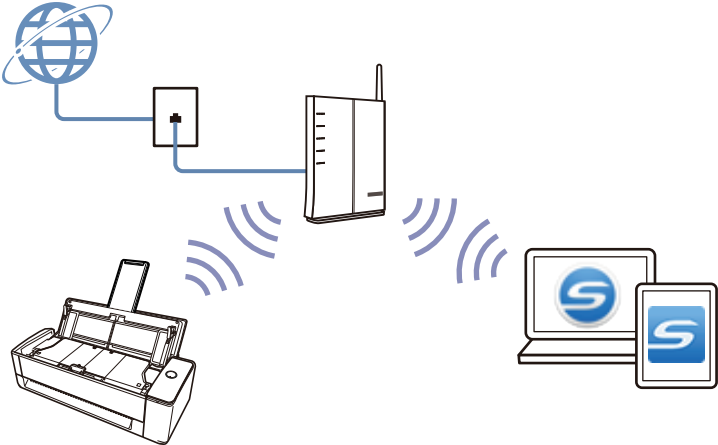

What You Can Do with iX500

Scanning Multiple Documents

A document stack with a thickness of 5 mm (0.2 in.) or less (for A4 or smaller sizes: up to 50 sheets with 80 g/m² [20 lb] paper weight) can be loaded into the ScanSnap for scanning.

For details, refer to "[Scanning Documents \(iX500\)](#)" (page 291).

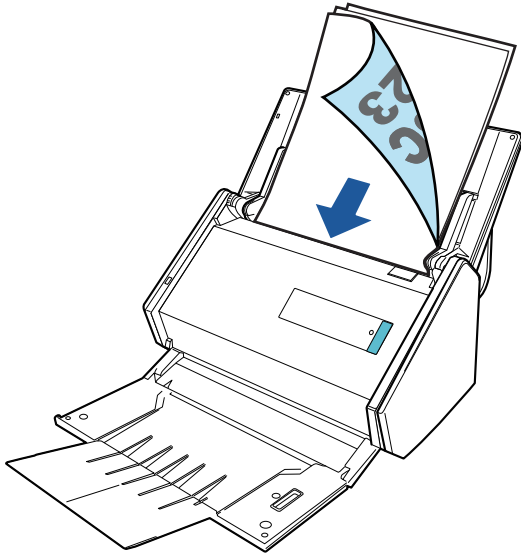

Scanning Documents That Cannot Be Loaded Directly in the ScanSnap

You can use the optional Carrier Sheet to scan the following documents.

- Documents that are larger than A4/Letter size and not larger than A3 size

For details, refer to "[Scanning Documents Larger Than A4 or Letter Size \(iX500\)](#)" (page 307).

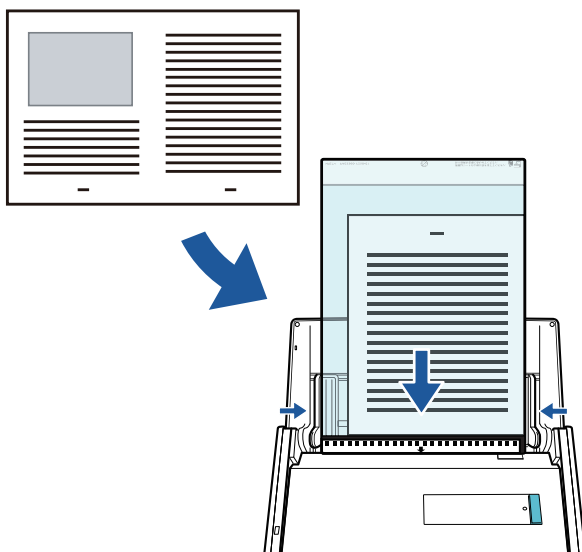

- Documents that can be damaged quite easily such as photographs, or non-standard size documents such as clippings

For details, refer to "Scanning Documents Such as Photographs and Clippings (iX500)" (page 311).

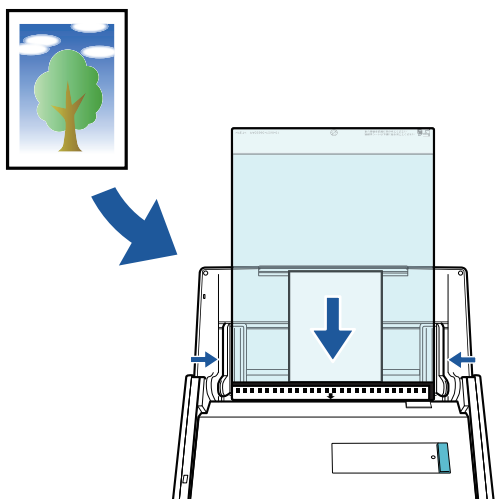

Connecting the ScanSnap via Wireless LAN

You can connect the ScanSnap and a computer or mobile device via wireless LAN.

To configure the wireless settings for the ScanSnap, use the ScanSnap Wireless Setup Tool, which is installed together with ScanSnap Manager.

For details, refer to "Connecting the ScanSnap via Wireless LAN (iX1300 / iX500 / iX100)" (page 146).

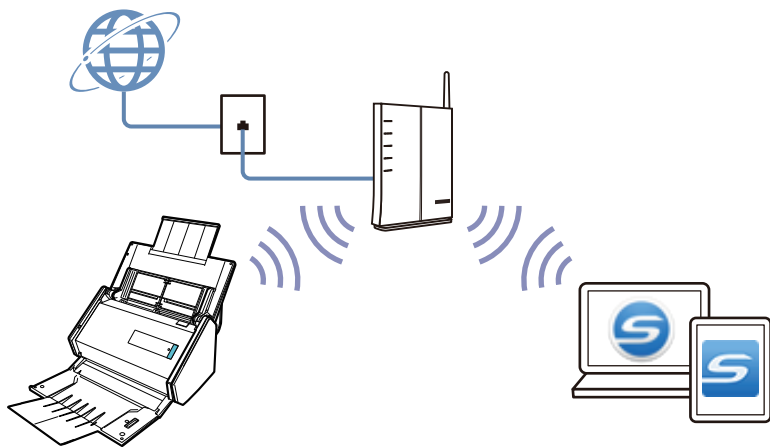

What You Can Do with iX100

Scanning Multiple Documents Continuously

When you scan multiple documents with the ScanSnap, you can scan one or two documents at a time. To scan two documents at a time, you can insert two documents at a time or you can insert the next document while another document is being scanned.

- Scanning one document at a time

After scanning a document is completed, when you insert the next document in the ScanSnap, the next scan is started automatically.

For details, refer to ["Scanning Documents \(iX100\)"](#) (page 320).

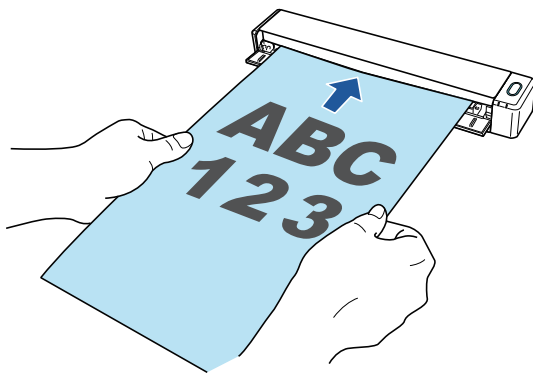

- Scanning documents by inserting two documents at a time or by inserting the next document while the current document is being scanned (dual scan)

When scanning small size documents such as business cards and postcards, you can insert two documents at a time in the ScanSnap. Alternatively, you can insert the next document while another document is being scanned. In either method, you can scan up to 20 documents continuously in a single scanning operation.

These scanning methods are referred to as dual scans.

For details, refer to ["Scanning Documents by Inserting Two Documents at a Time or by Inserting the Next Document While the Current Document Is Being Scanned \(iX100\)"](#) (page 325).

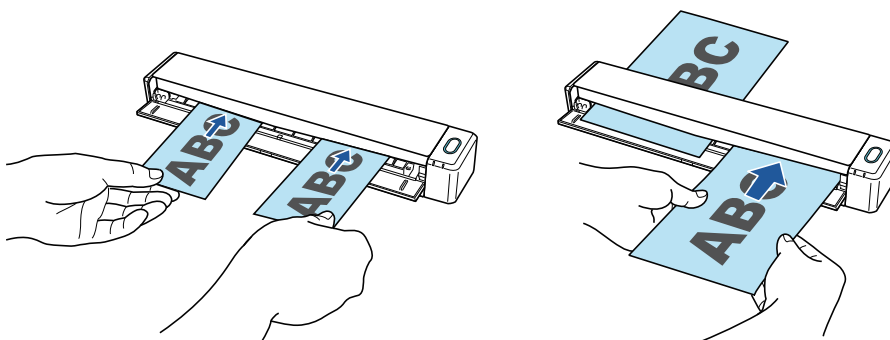

Scanning Documents Larger Than A4 or Letter Size by Directly Inserting Them in the ScanSnap

By folding an A3, B4, or Double Letter size document in half and scanning each side continuously, the scanned images of both sides can be automatically merged into a single image.

Scanned images can be merged only when there is text, diagram, or a table on the fold line of the folded document.

For details, refer to ["Scanning Documents Larger Than A4 or Letter Size by Directly Inserting Them in the ScanSnap \(iX100\)"](#) (page 332).

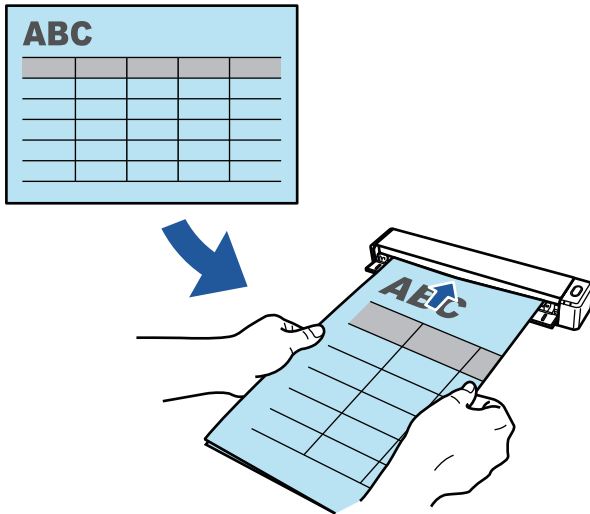

Scanning Documents That Cannot Be Loaded Directly in the ScanSnap

You can use the optional Carrier Sheet to scan the following documents.

- Documents that are larger than A4/Letter size and not larger than A3 size

For details, refer to ["Scanning Documents Larger than A4 or Letter Size with the Carrier Sheet \(iX100\)"](#) (page 336).

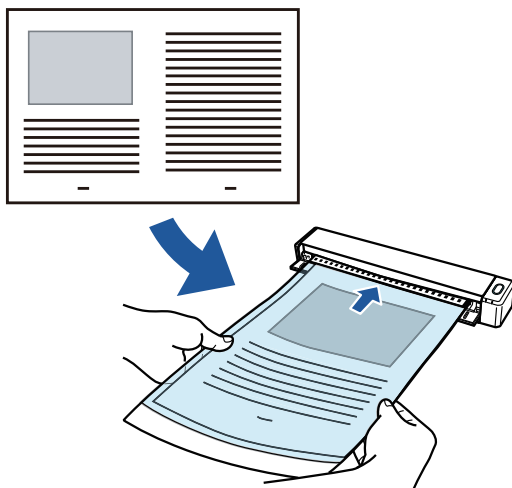

- Documents that can be damaged quite easily such as photographs, or non-standard size documents such as clippings

For details, refer to ["Scanning Documents Such as Photographs and Clippings \(iX100\)"](#) (page 341).

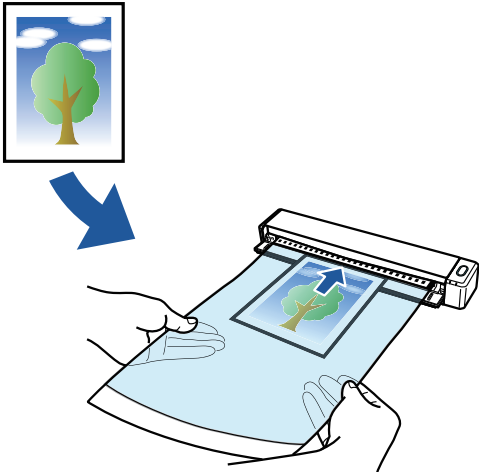

Connecting the ScanSnap via Wireless LAN

You can connect the ScanSnap and a computer or mobile device via wireless LAN.

To connect them, you can use either the Access Point Connect mode in which a wireless access point is used for connection or the Direct Connect mode in which a computer or mobile device is directly connected to the ScanSnap. Select a suitable connection mode depending on whether there is wireless LAN in a place where you use the ScanSnap or not.

To configure the wireless settings for the ScanSnap, use the ScanSnap Wireless Setup Tool, which is installed together with ScanSnap Manager.

For details, refer to "[Connecting the ScanSnap via Wireless LAN \(iX1300 / iX500 / iX100\)](#)" (page 146).

- Access Point Connect mode

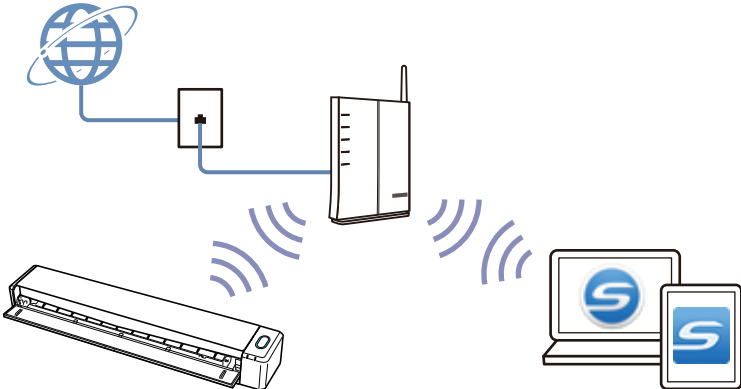

- Direct Connect mode

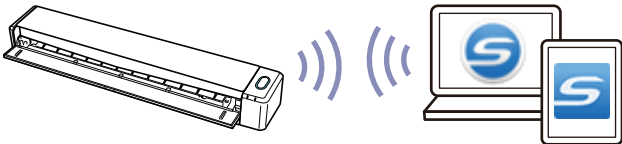

What You Can Do with SV600

The ScanSnap model that performs overhead scanning has a scanning unit that does not touch documents. The following scanning operations can be performed with this model:

- A book or booklet that is up to A3 in size can be scanned without cutting pages out.
- Multiple documents such as business cards or other types of cards can be scanned at once.

The scanned images created by scanning documents are corrected automatically.

- When a booklet-like document is scanned
The page distortion is corrected automatically.
- When multiple documents are scanned at once
The scanned images are cropped into separate images for respective documents.

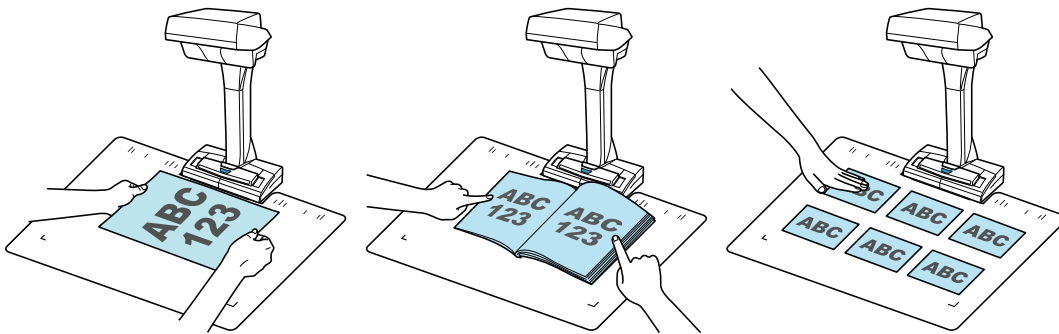

In addition, continuous scanning can be started automatically and scanned images can be corrected after documents are scanned.

Page Turning Detection

When a page is turned, the ScanSnap automatically starts continuous scanning.

This is useful for scanning multiple pages of a book or booklet-like document.

For details, refer to "[Scanning Books Using Page Turning Detection \(SV600\)](#)" (page 365).

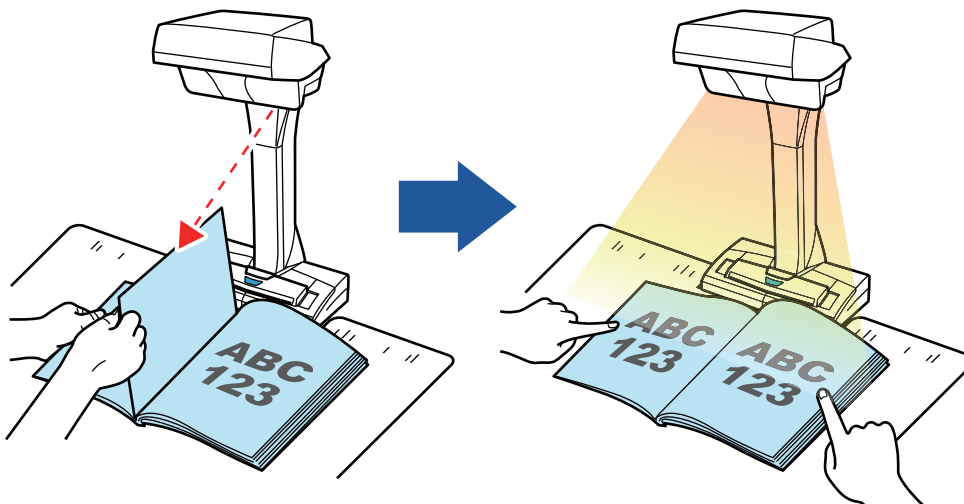

Timed Mode

The ScanSnap automatically starts scanning after the specified time period passes.

This is useful also for scanning multiple documents (of any type) consecutively.

There are two types of settings for timed mode:

- Setting the time period before the ScanSnap starts scanning a document after the [Scan] button is pressed
- Setting the time period for the ScanSnap to start the next scan when a document is scanned continuously

For details, refer to "Scanning Documents Using Timed Mode (SV600)" (page 369).

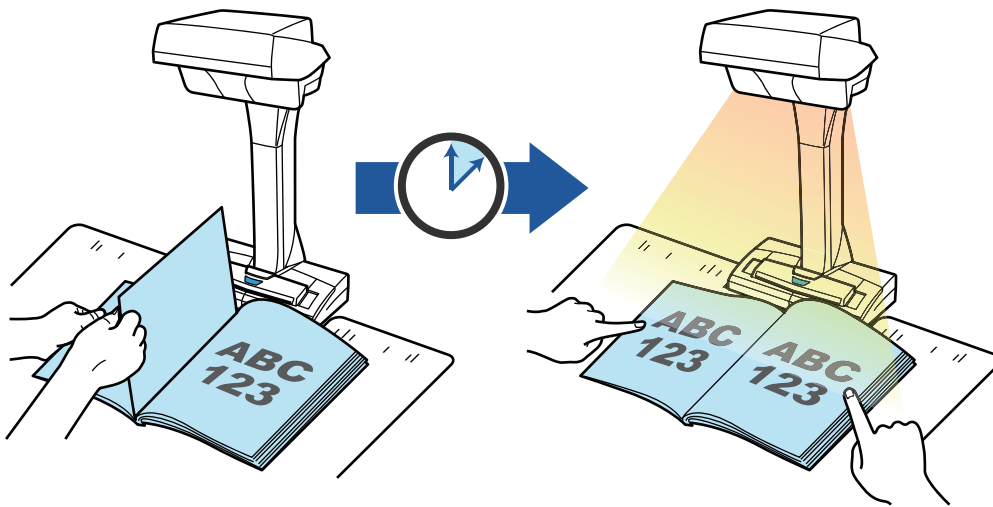

Correcting Scanned Images

After the documents are scanned with the ScanSnap, the scanned images can be corrected.

The following functions are available:

When a document is scanned

- "Filling in Fingers Captured in a Scanned Image (When a Document Is Scanned)(SV600)" (page 460)



When a book is scanned

- "Correcting Distorted Book Images (SV600)" (page 465)

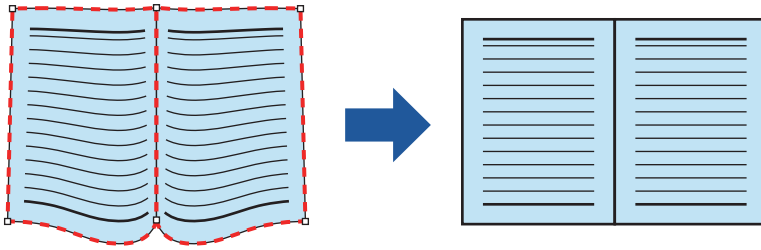

- "Splitting a Double-Page Spread Image into Two Page Images (SV600)" (page 470)

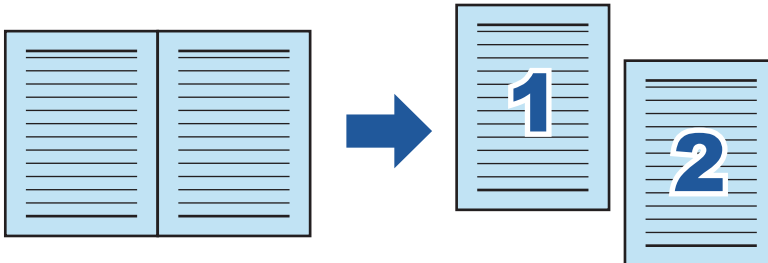

- "Filling in Fingers Captured in a Scanned Image (When a Book Is Scanned)(SV600)" (page 473)

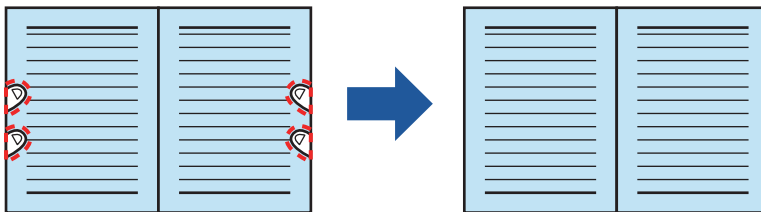

When multiple documents are scanned at once

- "Correcting the Scanned Image Orientation (SV600)" (page 477)
- "Modifying the Crop Area (SV600)" (page 480)
- "Adding the Necessary Scanned Images (SV600)" (page 482)
- "Deleting Unnecessary Scanned Images (SV600)" (page 484)

Scanning Documents with Two ScanSnaps Connected to a Computer

You can use SV600 and another ScanSnap connected to a computer.

For details, refer to "Scanning Documents with Two ScanSnaps Connected to a Computer (SV600)" (page 372).

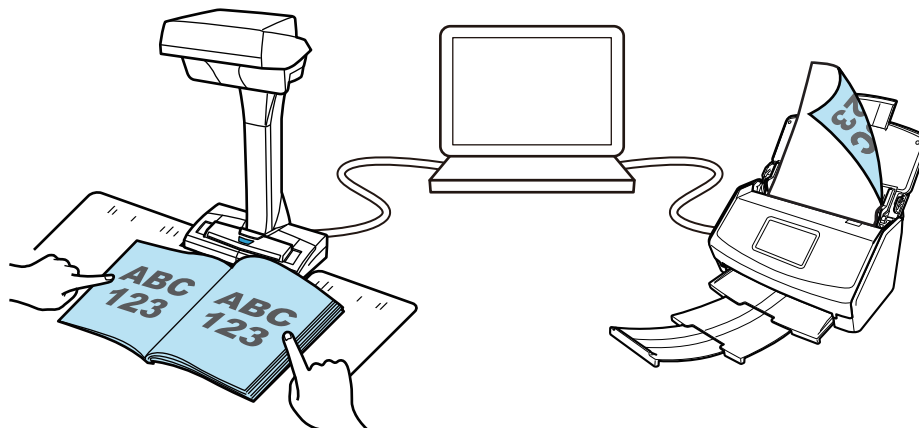

What You Can Do with S1300i

Scanning Multiple Documents

A document stack with a thickness of 1 mm (0.04 in.) or less (for A4 or smaller sizes: up to 10 sheets with 80 g/m² [20 lb] paper weight) can be loaded into the ScanSnap for scanning.

For details, refer to "[Scanning Documents \(S1300i\)](#)" (page 376).

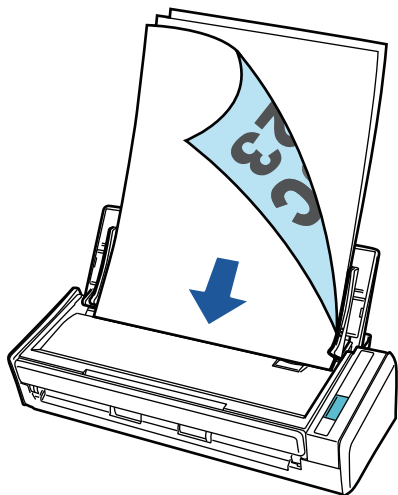

Using the USB Bus-Powered Drive that Does Not Require Any Power Supply

You can use the ScanSnap in an environment where no power supply is available, such as outside or on a business trip, by connecting the ScanSnap to a USB port on a computer.

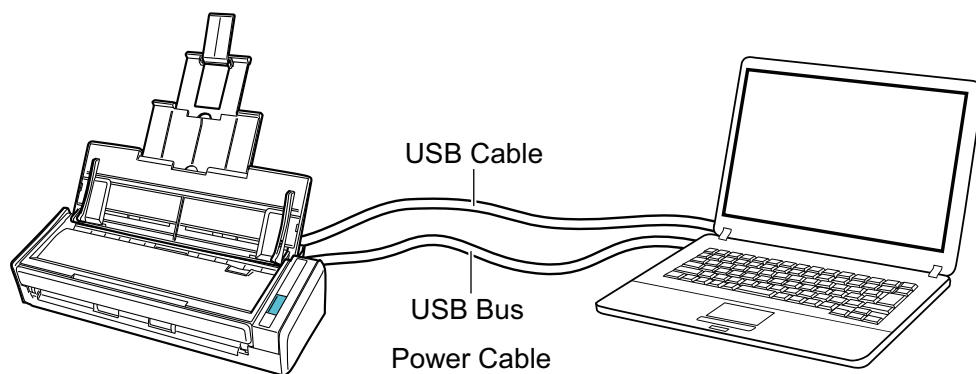

What You Can Do with S1100i

Scanning Multiple Documents Continuously

When you scan multiple documents with the ScanSnap, you can scan one or two documents at a time. To scan two documents at a time, you can insert two documents at a time or you can insert the next document while another document is being scanned.

- Scanning one document at a time

After scanning a document is completed, when you insert the next document in the ScanSnap, the next scan is started automatically.

For details, refer to ["Scanning Documents \(S1100i\)" \(page 395\)](#).

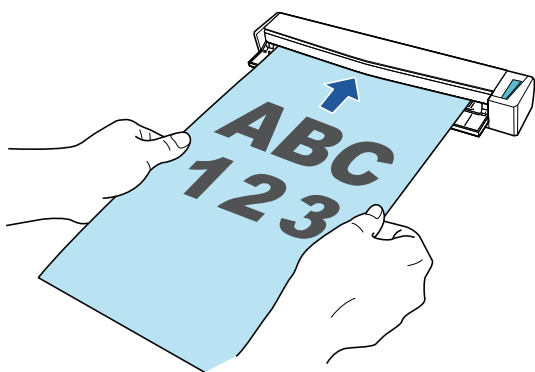

- Scanning documents by inserting two documents at a time or by inserting the next document while the current document is being scanned (dual scan)

When scanning small size documents such as business cards and postcards, you can insert two documents at a time in the ScanSnap. Alternatively, you can insert the next document while another document is being scanned. In either method, you can scan up to 20 documents continuously in a single scanning operation.

These scanning methods are referred to as dual scans.

For details, refer to ["Scanning Documents by Inserting Two Documents at a Time or by Inserting the Next Document While the Current Document Is Being Scanned \(S1100i\)" \(page 400\)](#).

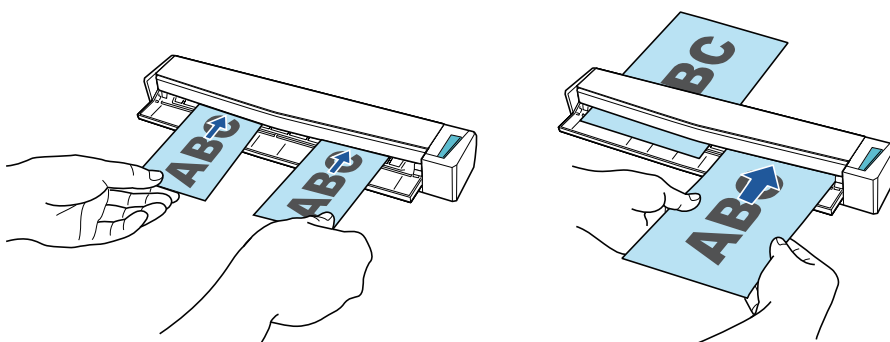

Scanning Documents Larger Than A4 or Letter Size by Directly Inserting Them in the ScanSnap

By folding an A3, B4, or Double Letter size document in half and scanning each side continuously, the scanned images of both sides can be automatically merged into a single image.

Scanned images can be merged only when there is text, diagram, or a table on the fold line of the folded document.

For details, refer to "Scanning Documents Larger Than A4 or Letter Size by Directly Inserting It in the ScanSnap (S1100i)" (page 407).

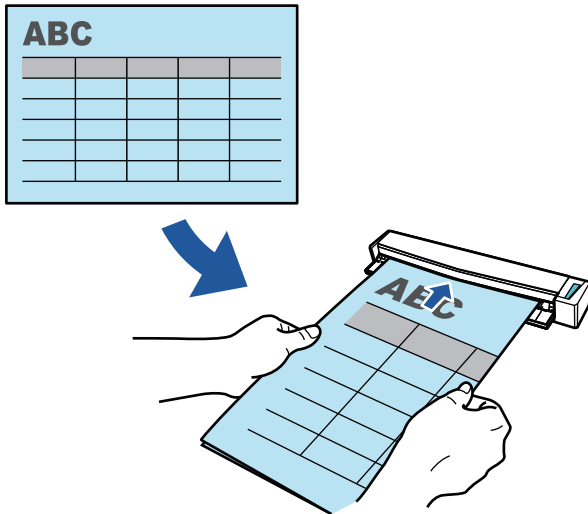

Scanning Documents That Cannot Be Loaded Directly in the ScanSnap

You can use the optional Carrier Sheet to scan the following documents.

- Documents that are larger than A4/Letter size and not larger than A3 size

For details, refer to "Scanning Documents Larger than A4 or Letter Size with the Carrier Sheet (S1100i)" (page 411).

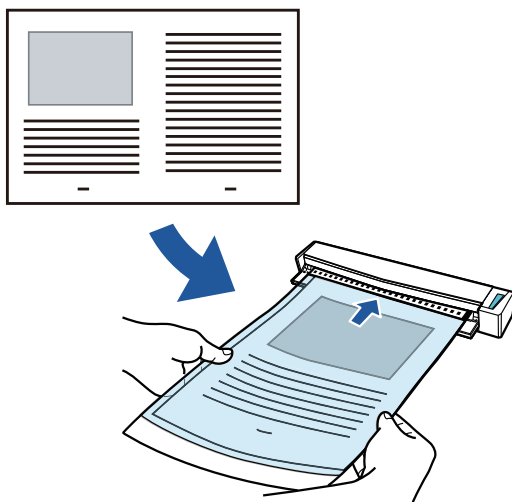

- Documents that can be damaged quite easily such as photographs, or non-standard size documents such as clippings

For details, refer to "Scanning Documents Such as Photographs and Clippings (S1100i)" (page 416).

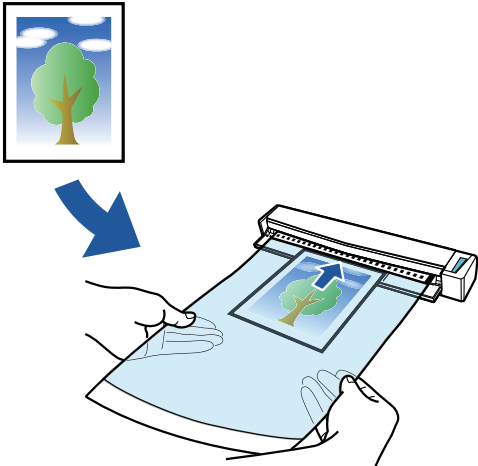

Parts and Functions

- ["Parts and Functions of iX1600 / iX1500 / iX1400" \(page 79\)](#)
- ["Parts and Functions of iX1300" \(page 81\)](#)
- ["Parts and Functions of iX500" \(page 84\)](#)
- ["Parts and Functions of iX100" \(page 86\)](#)
- ["Parts and Functions of SV600" \(page 89\)](#)
- ["Parts and Functions of S1300i" \(page 92\)](#)
- ["Parts and Functions of S1100i" \(page 94\)](#)

Parts and Functions of iX1600 / iX1500 / iX1400

This section explains the names and functions of the ScanSnap parts.

Front

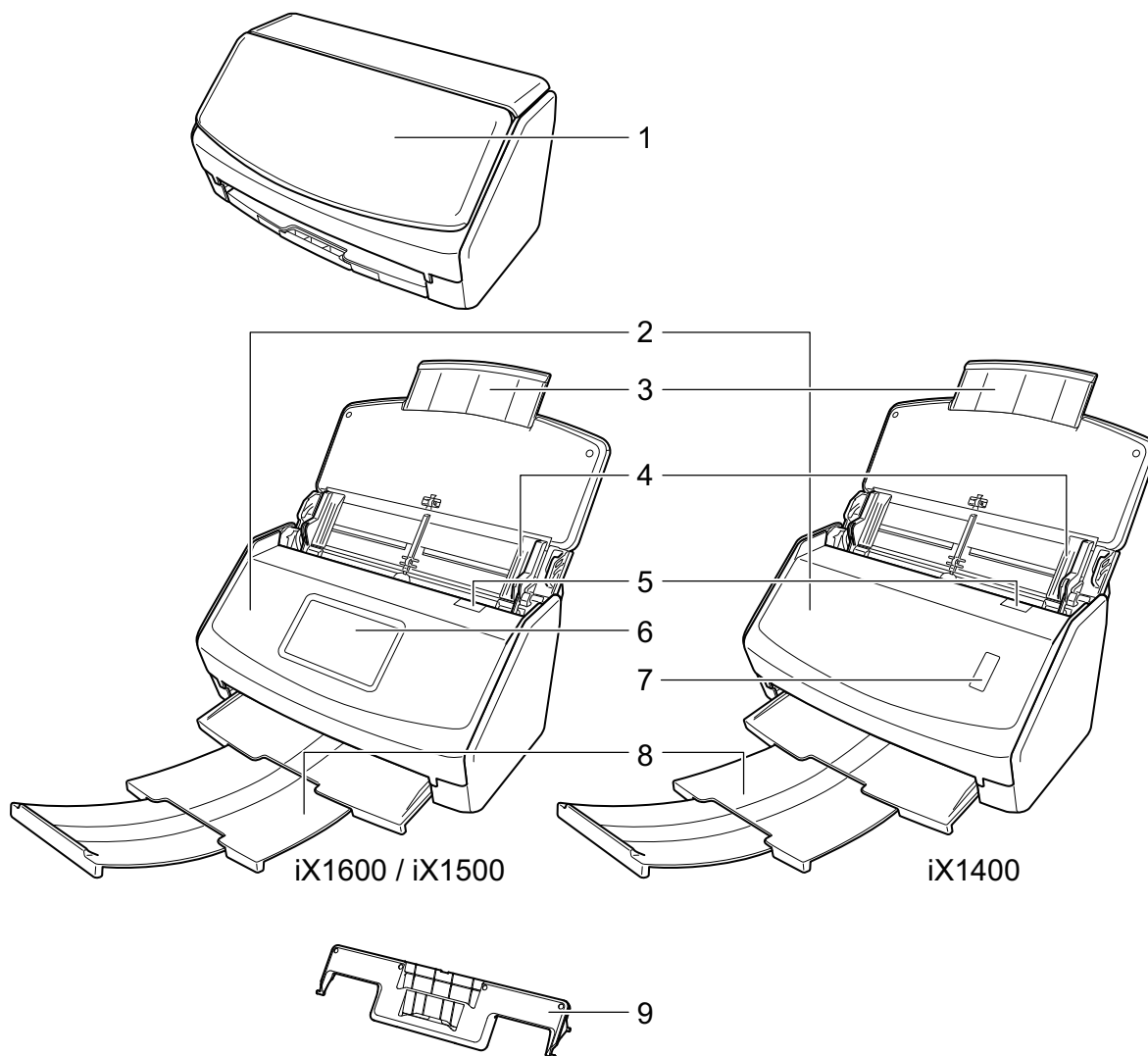

No.	Name	Description
1	ADF paper chute (cover) (*1)	Open it to use the ScanSnap. Opening it turns on the ScanSnap. Then, you can load a document on it.
2	ADF top section	Open it to remove jammed documents, replace the Roller Set, or clean the inside of the ScanSnap.
3	Extension	Pull out when scanning long documents.
4	Side guide	Adjust to the width of documents to prevent them from getting skewed.
5	ADF release tab	Pull this tab to open the ADF top section.
6	Touch panel (*1)	Used to display the connection status of the ScanSnap, start scanning documents, or change the settings of the ScanSnap.

No.	Name	Description
7	[Scan] button (*1)	Starts scanning. Can be pressed even when the stacker is closed. Indicates the status of the ScanSnap as follows: Blue (lit): Ready Blue (flashing): Scanning Orange (flashing): Error
8	Stacker	Pull it out to use it. Stacks up the ejected documents.
9	Receipt Guide	Attach it to the ADF paper chute (cover) for it to be used. If you use the Receipt Guide, you can place documents with different widths such as receipts in it to scan them at the same time.

*1: When the ScanSnap has turned off automatically because of the automatic power off function, perform the following to turn the ScanSnap back on.

- iX1600/iX1500
Press the touch panel, or close the ADF paper chute (cover) and open it again
- iX1400
Press the [Scan] button (this will not start scanning), or close the ADF paper chute (cover) and open it again

For details, refer to "[Automatic Power OFF \(iX1600 / iX1500 / iX1400 / iX1300 / iX500 / iX100 / SV600 / S1300i\)](#)" (page 116).

Back

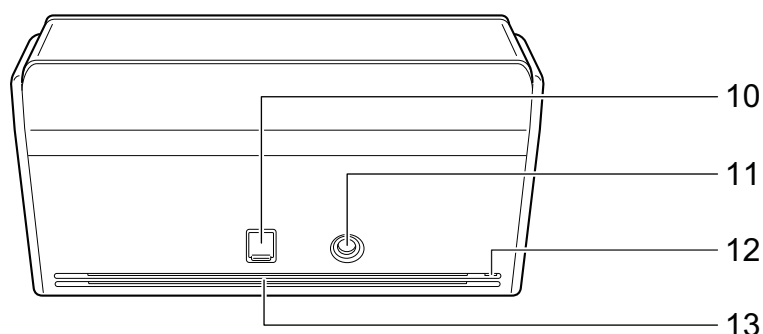

No.	Name	Description
10	USB connector	Slide the cover of the USB connector up to open it and then connect the USB cable to the USB connector. The cover of the USB connector slides up either one or two levels. Open the cover according to the type of the USB cable you have. <ul style="list-style-type: none"> ● First level: USB 2.0 cable ● Second level: USB 3.0 cable
11	Power connector	Used to connect a power cable.
12	Security cable slot	Used to connect an anti-theft security cable (commercially available).
13	Ventilation port	Holes for ventilating hot air from inside the ScanSnap.

Parts and Functions of iX1300

This section explains the names and functions of the ScanSnap parts.

Front

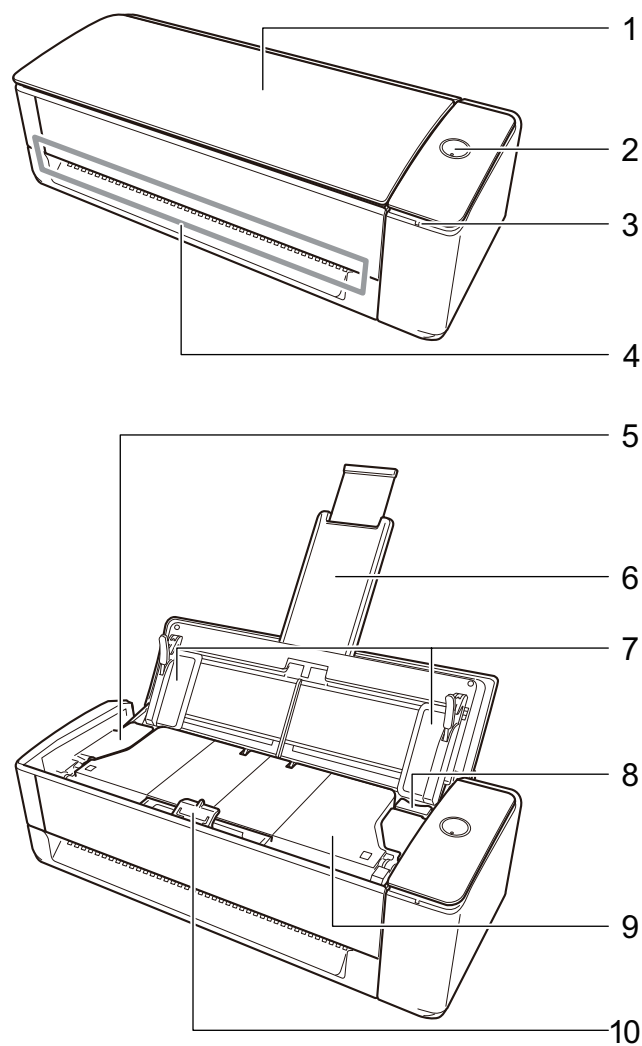

No.	Name	Description
1	ADF paper chute (cover)	Open it to use the ScanSnap. Opening it turns on the ScanSnap. Then, you can load a document on it. When the ScanSnap is turned off automatically, close the ADF paper chute (cover) and open it up again to turn it back on.
2	[Scan] button	Turn on the ScanSnap. Starts scanning. Indicates the status of the ScanSnap as follows: Blue (lit): Ready Blue (flashing): Scanning Orange (flashing): Error Purple (lit): Using ScanSnap Cloud

No.	Name	Description
3	Wi-Fi indicator	Indicates the status of the ScanSnap connected via wireless LAN as follows: Blue (lit): Connected (Access Point Connect mode) Blue (flashing): Standby Green (lit): Connected (Direct Connect mode) Orange (lit): Not Connectable or waiting for connection in Direct Connect mode Orange (flashing): Not Connectable (WPS error) Purple (lit): Using ScanSnap Cloud
4	Manual feeder	Insert a document into the manual feeder when you scan it with Return Scan.
5	ADF top section	Open it to remove jammed documents, replace the consumable (pick roller or pad unit), or clean the inside of the ScanSnap.
6	Extension	When the ADF paper chute (cover) is opened, it will rise automatically. It holds documents loaded in the ADF paper chute (cover) when you scan documents with U-turn Scan. If the documents go outside the range of the extension, pull out the top end of the extension manually.
7	Side guide	Adjust to the width of documents to prevent them from getting skewed.
8	ADF release tab	Pull this tab to open the ADF top section.
9	Stacker	When you scan documents with U-turn Scan, the ejected documents stack up on the stacker. It opens and closes automatically when documents are scanned.
10	Document support tab	When you scan documents with U-turn Scan, the support tab holds down the documents that are ejected on the stacker.

Side

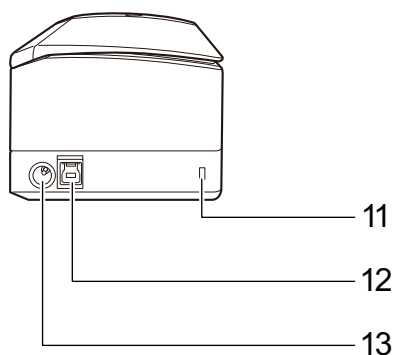

No.	Name	Description
11	Security cable slot	Used to connect an anti-theft security cable (commercially available).
12	USB connector	Used to connect a USB cable.
13	Power connector	Used to connect a power cable that is an AC cable which is connected to the AC adapter.

Back

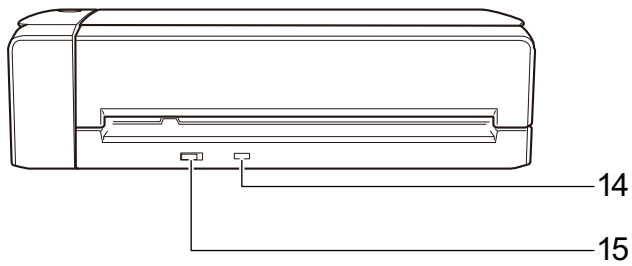

No.	Name	Description
14	WPS button	Press this button to connect to a WPS compatible wireless access point by using the push button method.
15	Wi-Fi switch	Turn this switch on to connect the ScanSnap to a wireless LAN.

Parts and Functions of iX500

This section explains the names and functions of the ScanSnap parts.

Front

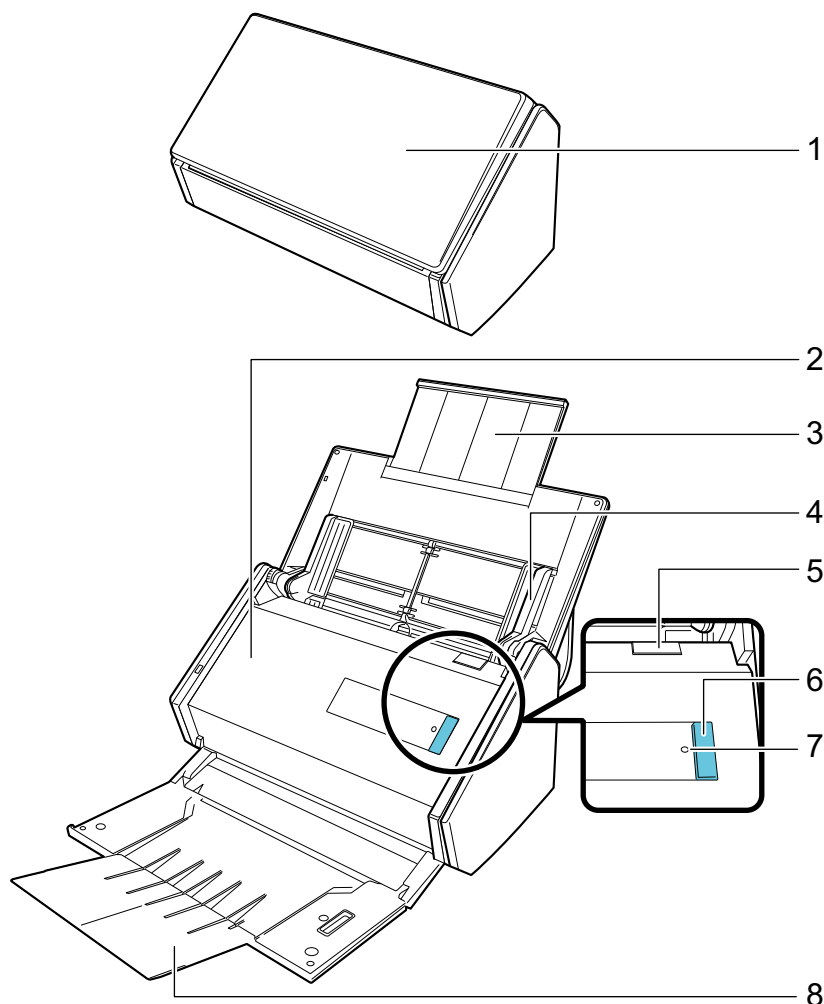

No.	Name	Description
1	ADF paper chute (cover) (*1)	Open it to use the ScanSnap. Opening it turns on the ScanSnap. Then, you can load a document on it.
2	ADF top section	Open it to remove jammed documents, replace the Roller Set, or clean the inside of the ScanSnap.
3	Extension	Pull out when scanning long documents.
4	Side guide	Adjust to the width of documents to prevent them from getting skewed.
5	ADF release tab	Pull this tab to open the ADF top section.

No.	Name	Description
6	[Scan] button (*1)	Starts scanning. Can be pressed even when the stacker is closed. Indicates the status of the ScanSnap as follows: Blue (lit): Ready Blue (flashing): Scanning Orange (flashing): Error
7	Wi-Fi indicator	Indicates the connection status between the ScanSnap and your wireless access point as follows: Blue (lit): Ready Blue (flashing): Standby Orange (lit): Not Connectable Orange (flashing): Not Connectable (WPS error)
8	Stacker	Open to use the stacker. Stacks up the ejected documents.

*1: When the ScanSnap has turned off automatically because of the automatic power off function, either press the [Scan] button (this will not start scanning), or close the ADF paper chute (cover), then open it again to turn the ScanSnap back on.

For details, refer to "[Automatic Power OFF \(iX1600 / iX1500 / iX1400 / iX1300 / iX500 / iX100 / SV600 / S1300i\)](#)" (page 116).

Back

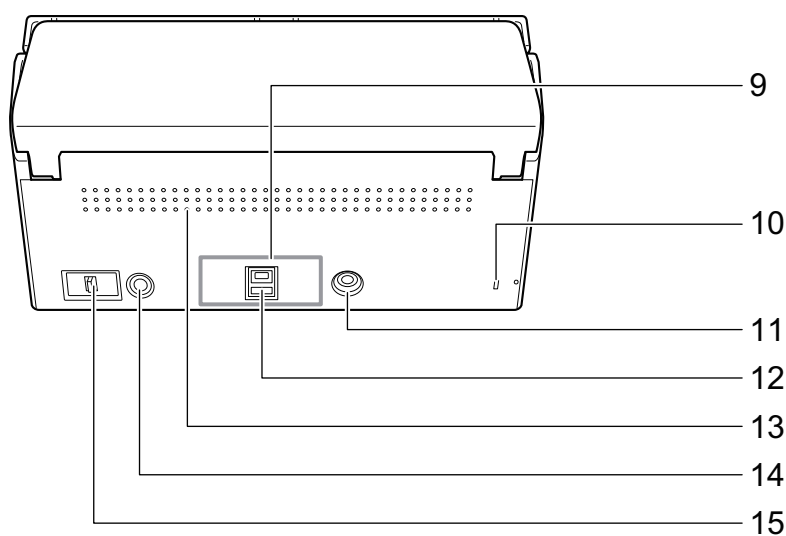

No.	Name	Description
9	Tape seal	Remove this tape seal after installing the software.
10	Security cable slot	Used to connect an anti-theft security cable (commercially available).
11	Power connector	Used to connect a power cable.
12	USB connector	Used to connect a USB cable.
13	Ventilation port	Holes for ventilating hot air from inside the ScanSnap.
14	WPS button	Press this button to connect to a WPS compatible wireless access point by using the push button method.
15	Wi-Fi switch	Turn this switch on to connect the ScanSnap to a wireless LAN.

Parts and Functions of iX100

This section explains the names and functions of the ScanSnap parts.

Front

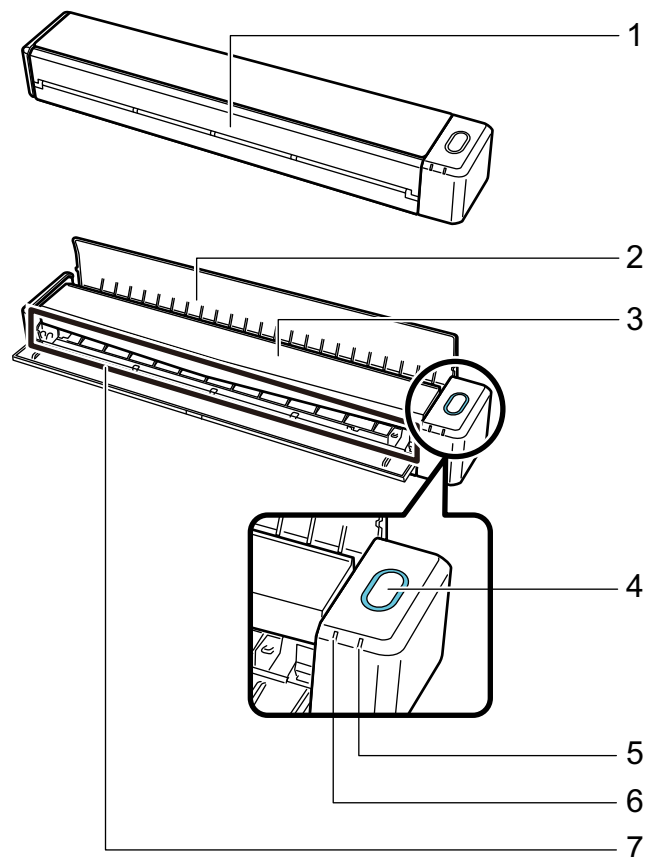

No.	Name	Description
1	Feed guide (*1)	Open it to use the ScanSnap. Opening it turns on the ScanSnap. Then, you can place a document on it to insert the document.

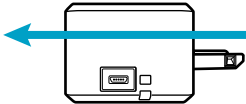
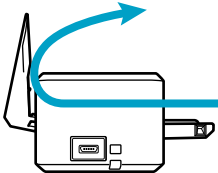
No.	Name	Description
2	Output guide	<p>Open it to eject documents from the front of the ScanSnap.</p> <p>Select an ejection method depending on the document type you are scanning.</p> <p>For details about documents that can be scanned with the ScanSnap, refer to "Documents to Scan (iX100)" (page 316).</p> <ul style="list-style-type: none"> ● When the output guide is closed  <ul style="list-style-type: none"> ● When the output guide is open 
3	Top cover	<p>Open it to remove jammed documents or clean the inside of the ScanSnap.</p> <p>For details about how to clean the inside of the ScanSnap, refer to "Cleaning the Inside of iX100" (page 532).</p>
4	[Scan/Stop] button (*1)	<p>Press this button to start or finish scanning.</p> <p>Indicates the status of the ScanSnap as follows:</p> <p>Blue (lit): Ready</p> <p>Blue (flashing): Scanning</p> <p>Orange (flashing): Error</p>
5	Battery indicator	<p>Indicates the remaining battery power and battery charging status.</p> <p>When the ScanSnap is turned on</p> <p>Blue (lit): Fully charged</p> <p>Orange (lit): Charging</p> <p>Orange (flashing): Low battery</p> <p>When the ScanSnap is turned off</p> <p>Orange (lit): Charging</p>
6	Wi-Fi indicator	<p>Indicates the status of the ScanSnap connected via wireless LAN as follows:</p> <p>Blue (lit): Connected (Access Point Connect mode)</p> <p>Blue (flashing): Standby</p> <p>Green (lit): Connected (Direct Connect mode)</p> <p>Orange (lit): Not Connectable or waiting for connection in Direct Connect mode</p> <p>Orange (flashing): Not Connectable (WPS error)</p>
7	Feeding section	Insert the document here to load.

*1: When the ScanSnap has turned off automatically because of the automatic power off function, either press the [Scan/Stop] button (this will not start scanning), or close the feed guide, then open it again to turn the ScanSnap back on.

For details, refer to "[Automatic Power OFF \(iX1600 / iX1500 / iX1400 / iX1300 / iX500 / iX100 / SV600 / S1300i\)](#)" (page 116).

Side

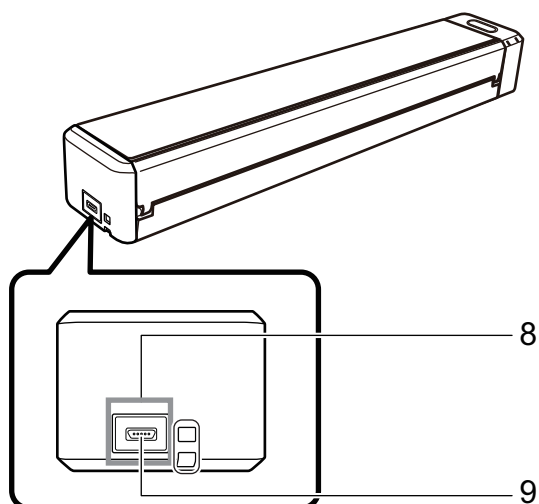

No.	Name	Description
8	Tape seal	Remove this tape seal after installing the software.
9	USB connector	Used to connect a USB cable.

Back

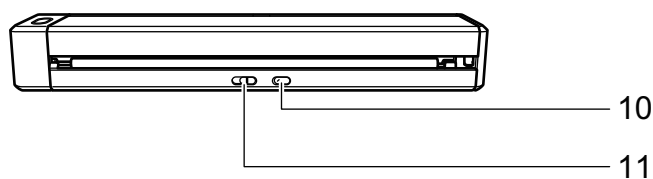

No.	Name	Description
10	WPS button	Press this button to connect to a WPS compatible device by using the push button method.
11	Wi-Fi switch	Turn this switch on to connect the ScanSnap via wireless LAN.

Parts and Functions of SV600

This section explains the names and functions of the ScanSnap parts.

Front

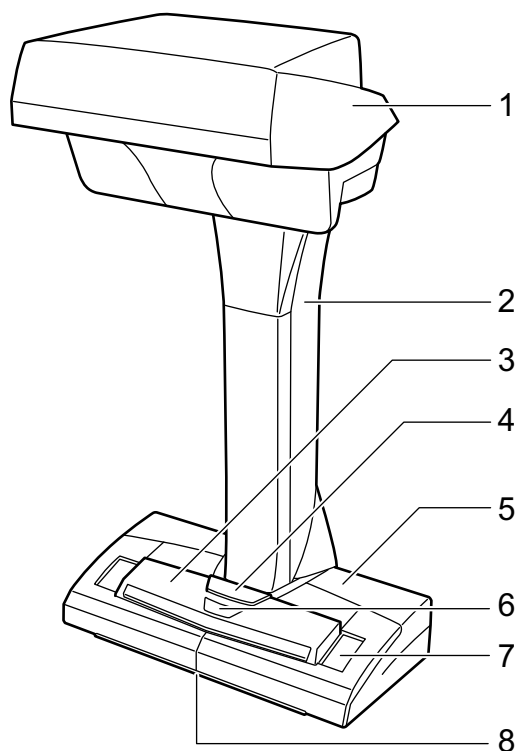

No.	Name	Description
1	Head	-
2	Neck	-
3	[Scan] button (*1)	<ul style="list-style-type: none"> ● Turns on the ScanSnap. ● Starts scanning.
4	[Stop] button (*1)	<ul style="list-style-type: none"> ● Turns the ScanSnap on or off. ● Stops scanning.
5	Base	-
6	Power LED	Indicates the status of the ScanSnap as follows: Blue (lit): Ready Blue (flashing): Scanning Orange (flashing): Error
7	White sheet	Used to determine the starting position for scanning documents and is also the standard color reference for the color of documents when documents are scanned.
8	Centering mark	When placing a book or standard size document, align the center of the document with the centering mark.

*1: If the ScanSnap has turned off automatically because of the automatic power off function, press the [Scan] or [Stop] button to turn the ScanSnap back on. (Pressing the [Scan] button does not start scanning.)

For details, refer to "Automatic Power OFF (iX1600 / iX1500 / iX1400 / iX1300 / iX500 / iX100 / SV600 / S1300i)" (page 116).

ATTENTION

When carrying the ScanSnap, hold its base and neck. Do not carry the scanner by the head.

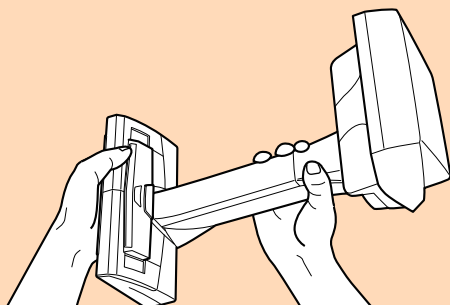

Back

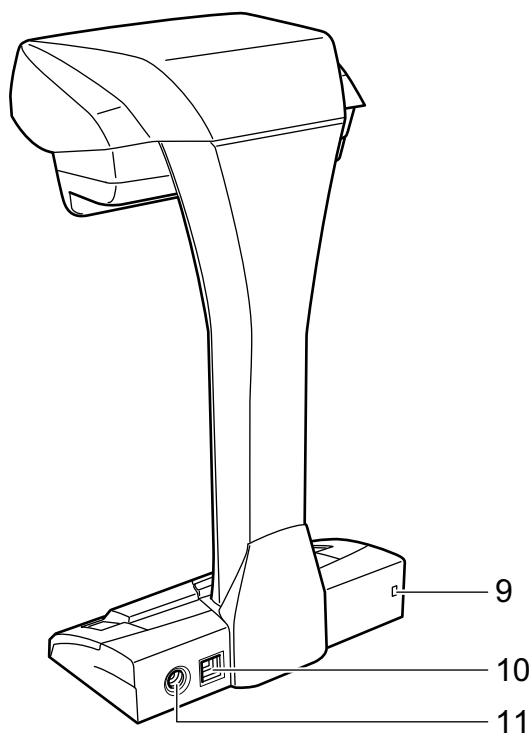

No.	Name	Description
9	Security cable slot	Used to connect an anti-theft security cable (commercially available).
10	USB connector	Used to connect a USB cable.
11	Power connector	Used to connect the AC cable.

Scanning Unit

Operates when documents are scanned.

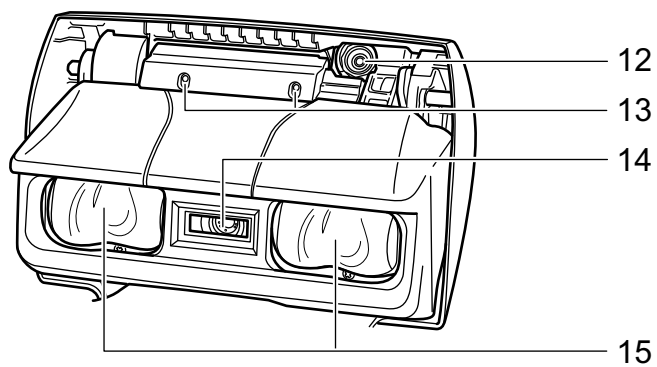

No.	Name	Description
12	Camera	Detects page turning and glossy papers.
13	Infrared LED	Irradiates the scan area with infrared to detect page turning and glossy papers.
14	Glass	Protects the lens used to scan a document.
15	Lamp	Illuminates the document to be scanned.

Parts and Functions of S1300i

This section explains the names and functions of the ScanSnap parts.

Front

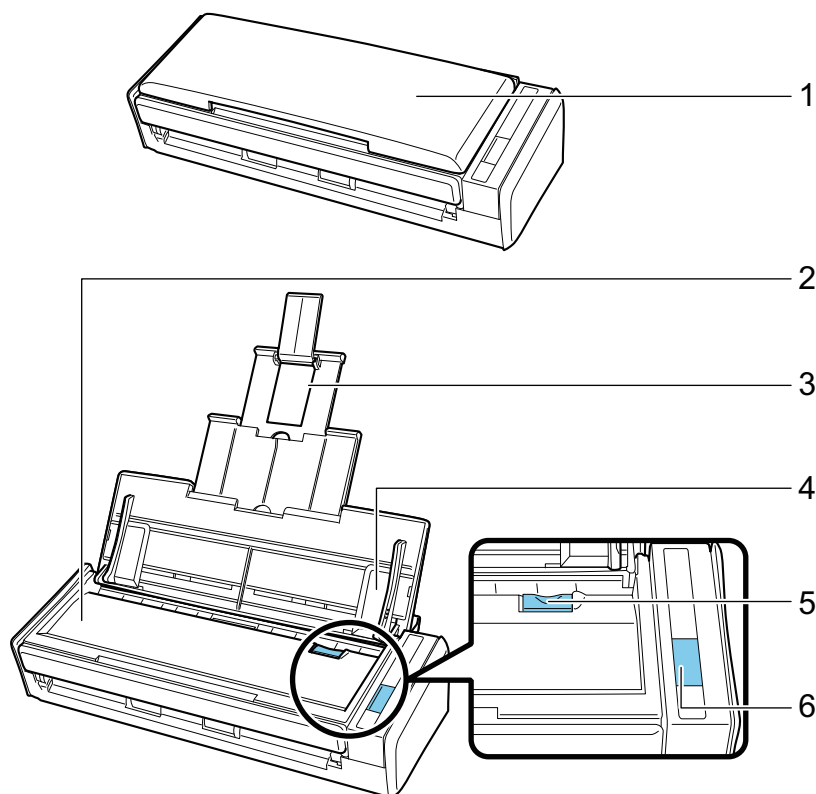

No.	Name	Description
1	ADF paper chute (cover) (*1)	Open it to use the ScanSnap. Opening it turns on the ScanSnap. Then, you can load a document on it.
2	ADF top section	Open it to remove jammed documents, replace the Roller Set, or clean the inside of the ScanSnap.
3	Extension	Pull out when scanning long documents.
4	Side guide	Adjust to the width of documents to prevent them from getting skewed.
5	ADF release tab	Pull this tab to open the ADF top section.
6	[Scan] button (*1)	Starts scanning. Indicates the status of the ScanSnap as follows: Blue (lit): Ready Blue (flashing): Scanning Orange (flashing): Error

*1: When the ScanSnap has turned off automatically because of the automatic power off function, either press the [Scan] button (this will not start scanning), or close the ADF paper chute (cover), then open it again to turn the ScanSnap back on.

For details, refer to "Automatic Power OFF (iX1600 / iX1500 / iX1400 / iX1300 / iX500 / iX100 / SV600 / S1300i)" (page 116).

Back

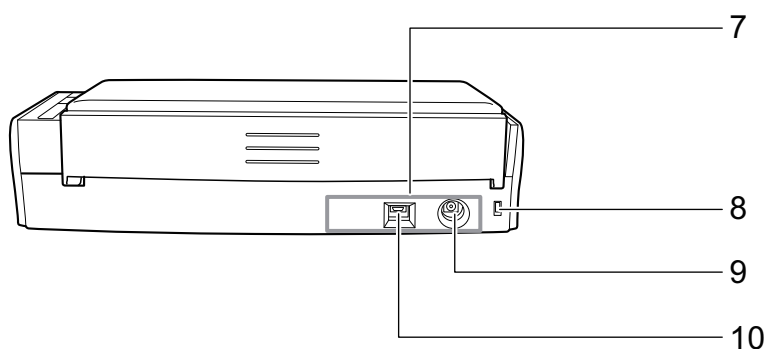

No.	Name	Description
7	Tape seal	Remove this tape seal after installing the software.
8	Security cable slot	Used to connect an anti-theft security cable (commercially available).
9	Power connector	Used to connect a power cable.
10	USB connector	Used to connect a USB cable.

Parts and Functions of S1100i

This section explains the names and functions of the ScanSnap parts.

Front

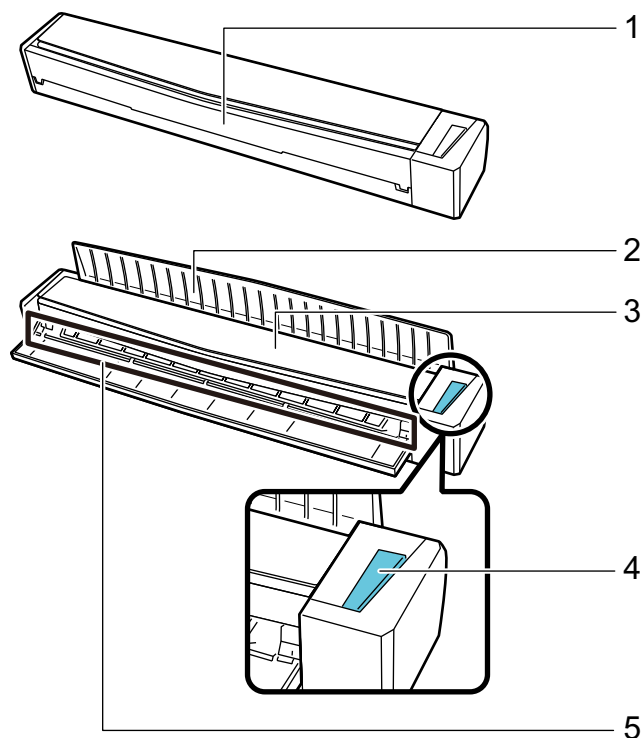

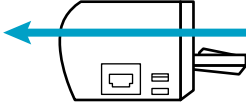
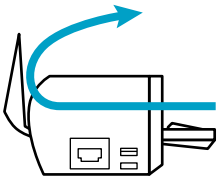
No.	Name	Description
1	Feed guide	Open it to use the ScanSnap. Opening it turns on the ScanSnap. Then, you can place a document on it to insert the document.
2	Output guide	Open it to eject documents from the front of the ScanSnap. Select an ejection method depending on the document type you are scanning. For details about documents that can be scanned with the ScanSnap, refer to " Documents to Scan (S1100i) " (page 391). <ul style="list-style-type: none"> When the output guide is closed  When the output guide is open 

No.	Name	Description
3	Top cover	Open it to remove jammed documents or clean the inside of the ScanSnap. For details about how to clean the inside of the ScanSnap, refer to "Cleaning the Inside of S1100i" (page 544) .
4	[Scan/Stop] button	Press this button to start or finish scanning. Indicates the status of the ScanSnap as follows: Blue (lit): Ready Blue (flashing): Scanning Orange (flashing): Error
5	Feeding section	Insert the document here to load.

Side

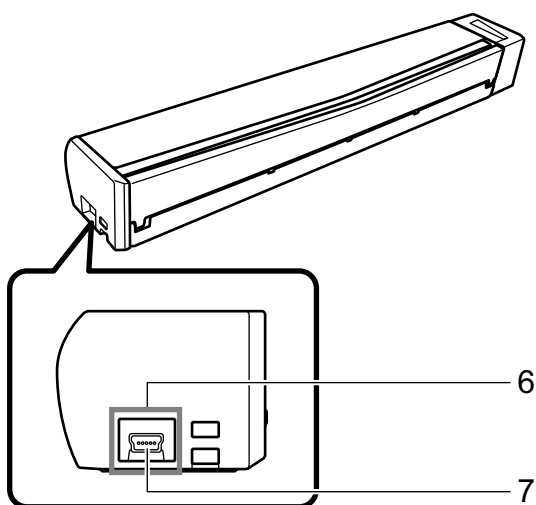

No.	Name	Description
6	Tape seal	Remove this tape seal after installing the software.
7	USB connector	Used to connect a USB cable.

Charging the Battery (iX100)

The battery of the ScanSnap can be charged by connecting the ScanSnap and the computer with the supplied USB cable.

Charge the ScanSnap's battery in the following procedure.

ATTENTION

- The ScanSnap is powered and charged through a USB port on a computer. Use the USB port that provides a power supply of 500 mA to charge the battery.
- Use the supplied USB cable or the optional USB power adapter to charge the battery.
- Charge the battery in proper air temperature conditions (5 to 35 degrees C/41 to 95 degrees F).
- Do not charge the battery in the following cases:
 - The shape of the USB cable plug was once deformed.
 - The USB cable is damaged.
 - Foreign objects get on the plugs of the USB cable and the USB connector which is on the ScanSnap.
- Do not charge the battery in the following environments:
 - Places which are subject to high humidity, dust, or vibration
 - Places near conventional phones, televisions, or radios
- Check that the ScanSnap does not get wet before charging.
- The battery can be charged while the ScanSnap is being used. Although the following symptoms may occur during a charge, it does not affect the ScanSnap in any way.
 - It takes time until charging completes.
 - The remaining battery power is reduced and charging is not completed.
 - The ScanSnap is automatically turned off during a scan.
- The battery reaches the end of its life after 300 to 500 times of charges and discharges. The battery life varies depending on the conditions that the ScanSnap is used in
- The battery naturally discharges over time even if it is not used.
- When you use the ScanSnap in low temperatures, the charged battery may run out quickly.

- 1. Connect the USB cable to the USB connector on the ScanSnap and the USB port on the computer.**

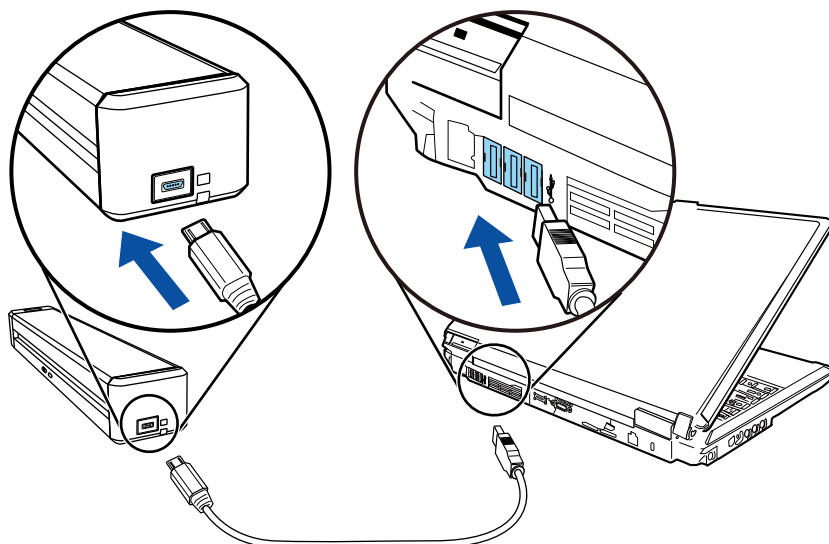

⇒ The battery indicator lights up in orange.

When charging completes, the battery indicator turns off.

HINT

You can use the optional USB power adapter to charge the battery in a shorter time.

Overview of the Software Related to the ScanSnap

This section gives an overview of each bundled software and their functions. You can edit, manage, and arrange the scanned image by using the following software:

ScanSnap Manager

This scanner driver is required to scan documents with the ScanSnap. Scanned images can be saved as PDF or JPEG files to a computer.

You need to have ScanSnap Connect Application installed on your mobile device to save PDF or JPEG files to your mobile device.

You can download ScanSnap Connect Application for your mobile device from its application market.

ScanSnap Home

You can manage a scanned image together with meta information (such as character strings that are recognized by the text recognition function and the date when you scan a document) as a content data record by selecting this application from ScanSnap Manager after scanning documents with the ScanSnap.

Also, files other than the images created by scanning documents with the ScanSnap can be imported into ScanSnap Home as the content data records.

Download ScanSnap Home from [here](#), and then install it.

ScanSnap Organizer

You can use this application to display image data (PDF or JPEG files) without opening them, create folders and arrange files as you like.

CardMinder

You can use this application to efficiently digitalize a large number of business cards.

Text recognition can be performed on business cards and you can create a database to facilitate card data management and searches. Data in the database can be printed and linked with various applications.

ABBYY FineReader for ScanSnap

This application can perform text recognition on the scanned images using OCR (Optical Character Recognition) to convert the image data to Word, Excel, or PowerPoint files that can be edited.

ScanSnap Online Update

This application checks whether the latest updates or software programs are available on the download server. When the latest updates or software programs are available, you can automatically apply updates or download and install the software programs manually.

Kofax Power PDF Standard or Nuance Power PDF Standard

This is a application for creating, editing, managing, and utilizing PDF format electronic documents. Available for iX1600/iX1500/iX500/SV600.

For details about the installation and activation methods of Kofax Power PDF Standard or Nuance Power PDF Standard, refer to the following:

How to Install PDF Editing Software





<https://www.pfu.fujitsu.com/imaging/downloads/manual/install/en>

ScanSnap Manager Icon

When ScanSnap Manager is running, the ScanSnap Manager icon is displayed in the notification area. The notification area is located at the far right of the taskbar.

The ScanSnap Manager icon indicates whether or not ScanSnap Manager is successfully communicating with the ScanSnap. The appearance of the icon changes according to the communication status as shown below.

In regard to iX1600, iX1500, iX1300, iX500, or iX100, for convenience purposes, the icons that mostly appear in this manual are the ones when the ScanSnap is connected to a computer with a USB cable.

Communication Status	ScanSnap Manager Icon
Communicating	 <p>iX1600/iX1500/iX1300/iX500/iX100 When the ScanSnap is connected to a computer via wireless LAN, the following icon is displayed.</p> 
Not communicating	 <p>iX1600/iX1500 When the touch panel is being used or ScanSnap is used from another application, the following icon is displayed.</p>  <p>iX1300/iX500/iX100 When the ScanSnap is connected to a mobile device via wireless LAN, the following icon is displayed.</p> 

HINT

Turn the ScanSnap on to begin communication between ScanSnap Manager and the ScanSnap. For details about how to turn on the ScanSnap, refer to "[Turning the ScanSnap On](#)" (page 105).

You can display the menu for scanning documents and ScanSnap Manager settings from the ScanSnap Manager icon.

- Right-clicking
Displays the "[Right-Click Menu](#)" (page 100).
- Left-clicking
Displays the Left-Click Menu.
For details, refer to the Advanced Operation Guide.

Right-Click Menu

This menu appears when you right-click the ScanSnap Manager icon  in the notification area located at the far right of the taskbar.

By using the Right-Click Menu, you can start scanning documents and can display a window in order to change the scan settings or preferences for ScanSnap and ScanSnap Manager.

For details, refer to the ScanSnap Manager Help.

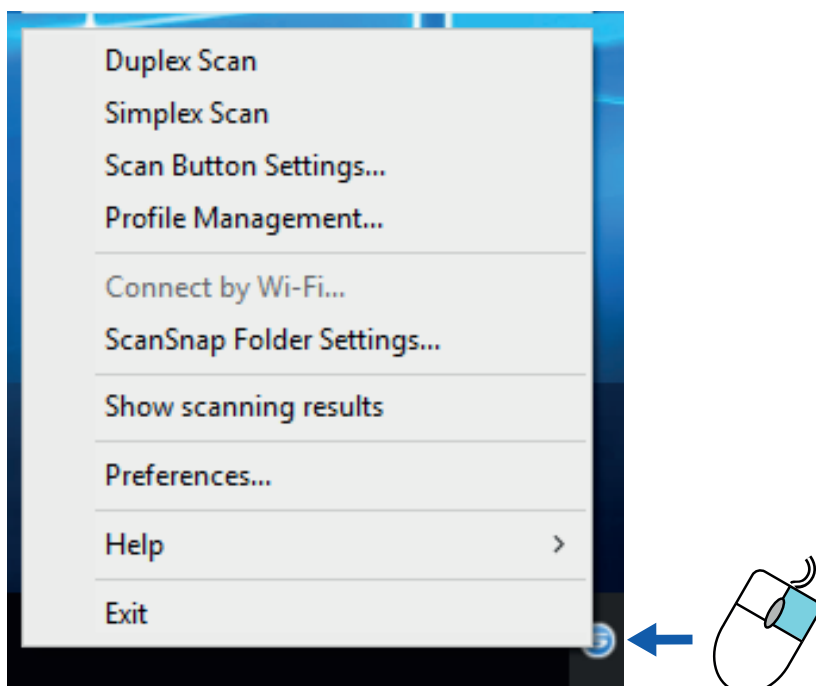

Example: Right-Click Menu for iX1600

HINT

When SV600 and either iX1600, iX1500, iX1400, iX1300, iX500, iX100, S1300i, or S1100i are connected to a computer, the Right-Click Menu displays items relevant to each of the connected ScanSnap models.

For details, refer to the ScanSnap Manager Help.

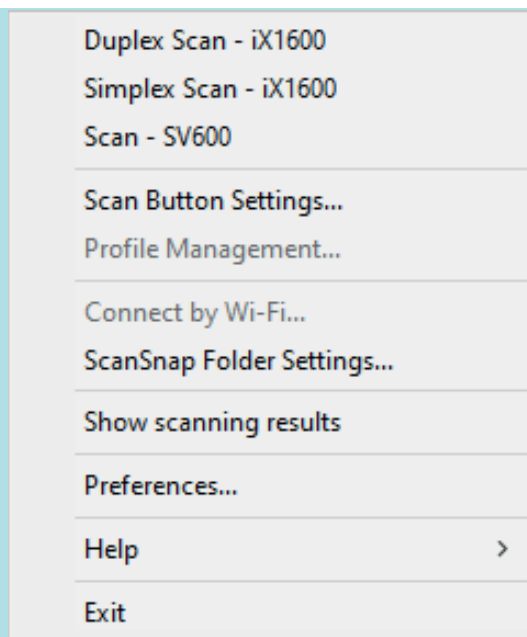

Example: When SV600 and iX1600 are connected to a computer

ScanSnap Setup Window

When you right-click the ScanSnap Manager icon  in the notification area located at the far right of the taskbar, and select [Scan Button Settings] from the "Right-Click Menu" (page 100), the following ScanSnap setup window appears.

In the ScanSnap setup window, you can use the [Use Quick Menu] checkbox to specify whether or not to use the Quick Menu. You can also use the profile buttons and detail setting tabs to specify scan settings according to your scanning needs.

For details, refer to the ScanSnap Manager Help.

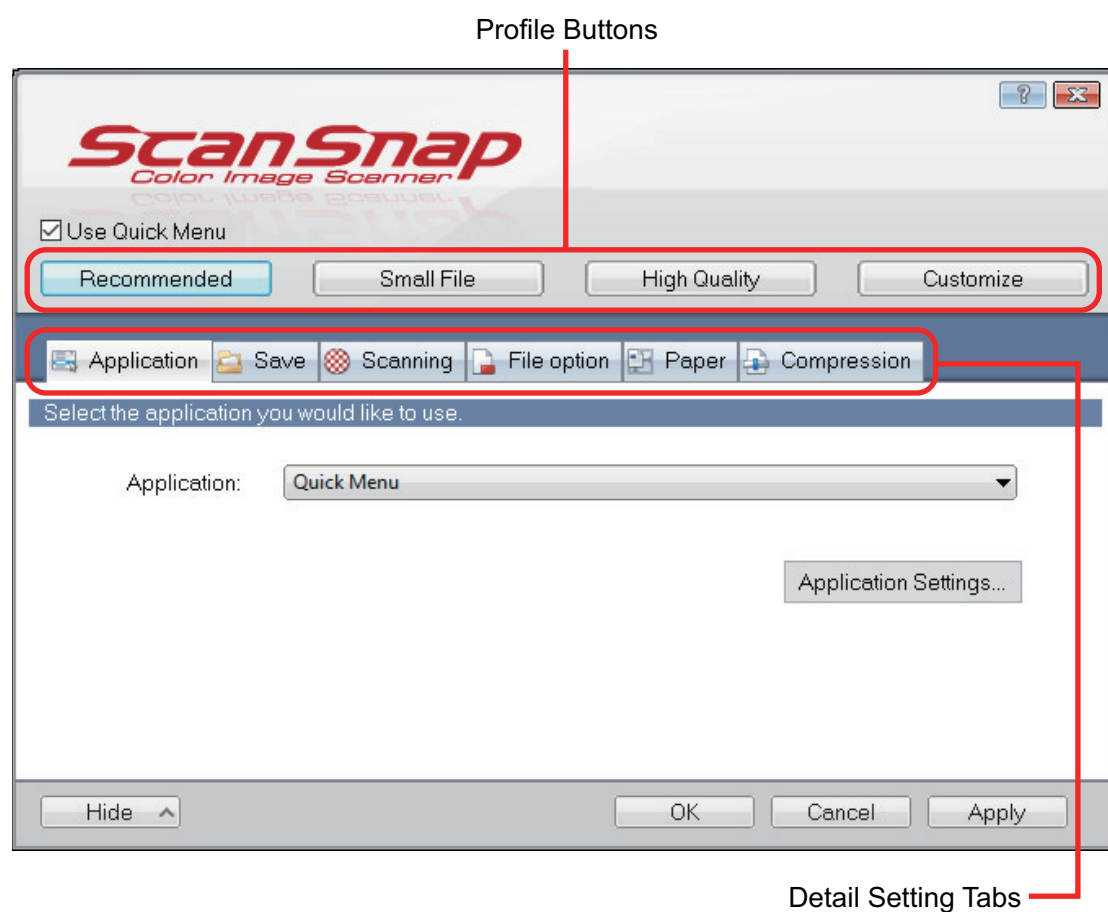

Example: ScanSnap setup window for iX1600

HINT

For SV600, when SV600 and either iX1600, iX1500, iX1400, iX1300, iX500, iX100, S1300i, or S1100i are connected to a computer, you can change the scan settings for each of the ScanSnap models that are connected by selecting the model name from [Scanner] on the ScanSnap setup window.

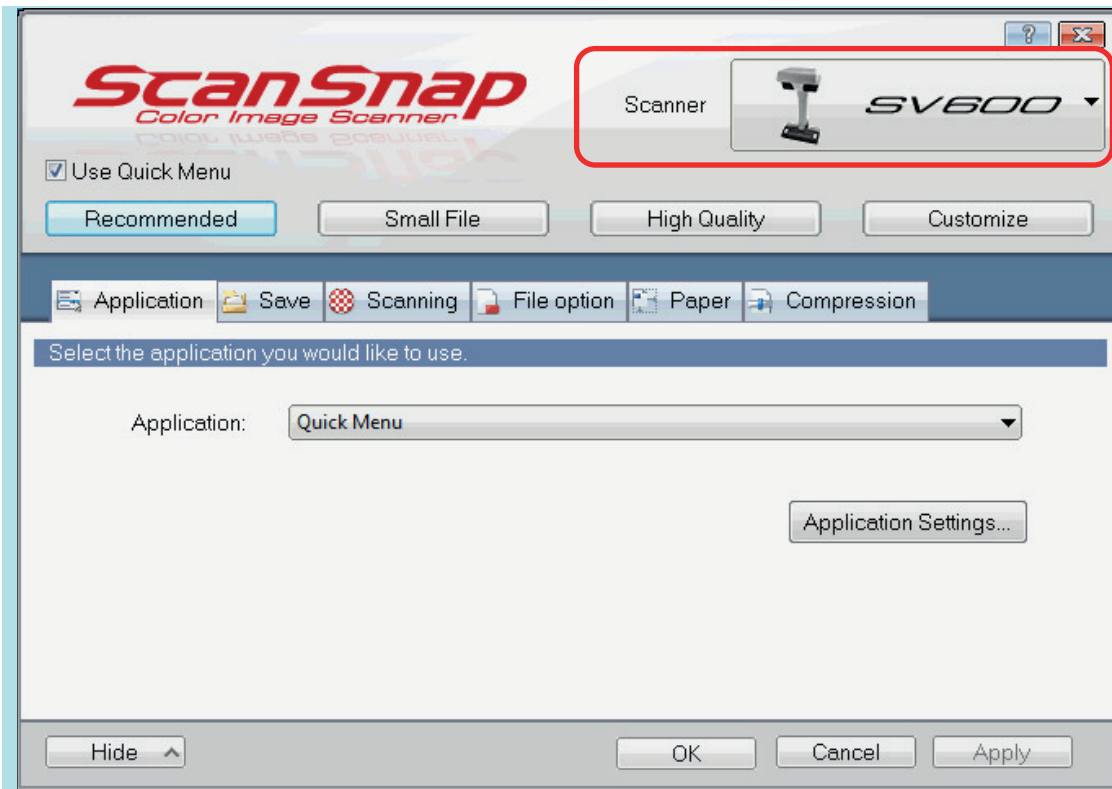

Turning the ScanSnap On or Off

This section explains how to turn the ScanSnap on or off.

- ["Turning the ScanSnap On" \(page 105\)](#)
- ["Turning the ScanSnap Off" \(page 110\)](#)
- ["Startup Mode \(iX1600 / iX1500 / iX1300\)" \(page 113\)](#)
- ["Sleep Mode" \(page 115\)](#)
- ["Automatic Power OFF \(iX1600 / iX1500 / iX1400 / iX1300 / iX500 / iX100 / SV600 / S1300i\)" \(page 116\)](#)
- ["Checking the Remaining Battery Power \(iX100\)" \(page 119\)](#)

Turning the ScanSnap On

1. Turn on the computer.



HINT

For iX1600/iX1500/iX1300/iX500/iX100, if you connect the ScanSnap and a mobile device via a wireless LAN and then scan a document, you do not have to turn on the computer.

⇒ The computer starts up and the ScanSnap Manager icon  appears in the notification area located at the far right of the taskbar.



HINT

- If the ScanSnap Manager icon  is not displayed in the notification area, start ScanSnap Manager. Start ScanSnap Manager in the following procedure.
 - Windows 10
Select [Start] menu → [ScanSnap Manager] → [ScanSnap Manager].
 - Windows 8.1
Click  on the lower left side of the Start screen, and select [ScanSnap Manager] under [ScanSnap Manager] on the All apps screen.
 - Windows 7
Select [Start] menu → [All Programs] → [ScanSnap Manager] → [ScanSnap Manager].
- If ScanSnap Manager does not automatically start when you log on to your computer, change the setting in the following procedure:
 1. Right-click the ScanSnap Manager icon  in the notification area and select [Preferences] from the "Right-Click Menu" (page 100).
⇒ The [ScanSnap Manager - Preferences] window appears.
 2. In the [Auto Startup] list, select the [Start up ScanSnap Manager when you log on] checkbox.

2. Turn on the ScanSnap.

iX1600/iX1500

Open the ADF paper chute (cover) of the ScanSnap.

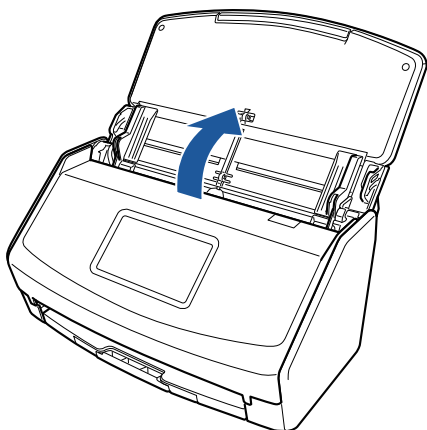

⇒ The touch panel is activated.

iX1400

Open the ADF paper chute (cover) of the ScanSnap.

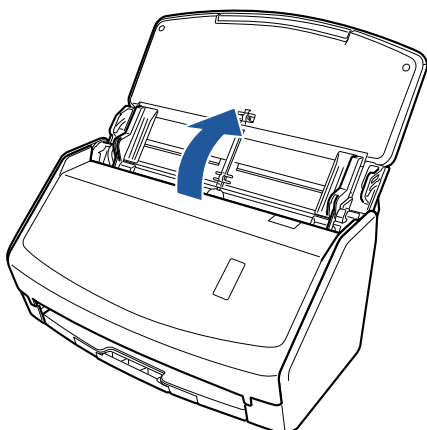

⇒ The [Scan] button flashes in blue. The button returns to being lit normally when document scanning is enabled.

iX1300

The ScanSnap is turned on by performing one of the following operations.

- Holding the right side of the ADF paper chute (cover) then opening it
Open the ADF paper chute (cover) fully so that the [Scan] button lights up in blue.
When the ADF paper chute (cover) is opened, the extension will rise automatically.

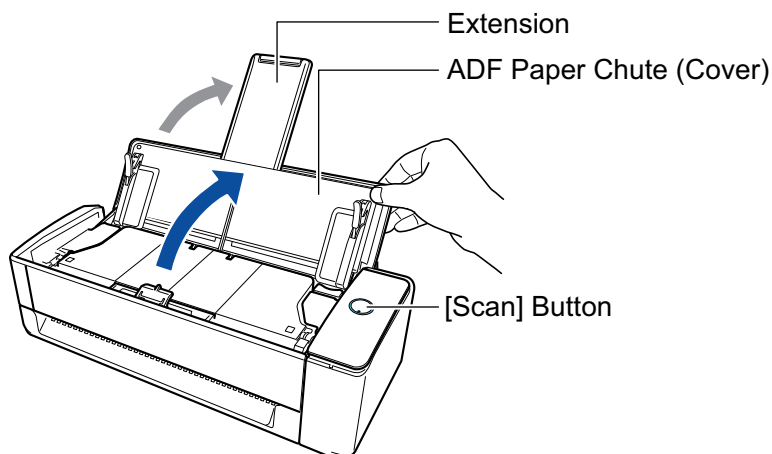

- Pressing the [Scan] button

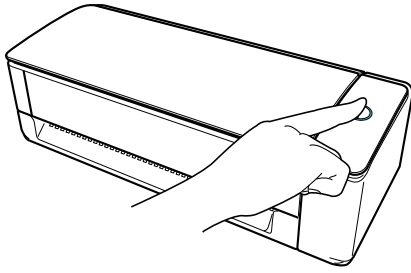

- Inserting a document into the manual feeder

When a document is inserted into the manual feeder, the document is fed into the ScanSnap and is held firmly.

If you press the [Scan] button with the document held firmly in the ScanSnap, it starts scanning.

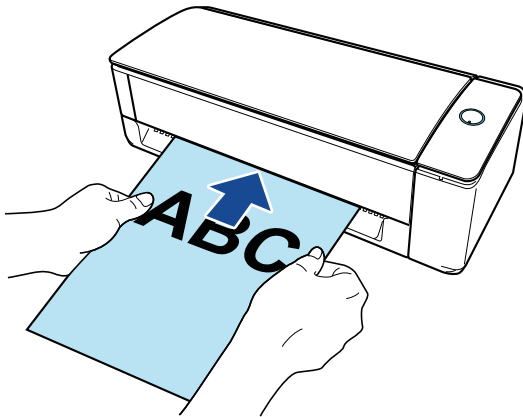

HINT

If the ScanSnap has been set to turn on by inserting a document into the manual feeder, inserting a document such as a semi-transparent document (e.g. tracing paper), thin document, or transparent sheet may not turn on the ScanSnap.

If the ScanSnap is not turned on, perform one of the following to turn it on.

- Opening the ADF paper chute (cover)
- Pressing the [Scan] button

iX500/S1300i

Open the ADF paper chute (cover) of the ScanSnap.

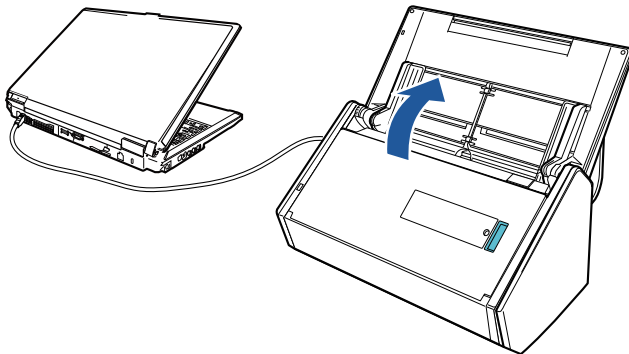

Example: iX500

- ⇒ The [Scan] button flashes in blue. The button returns to being lit normally when document scanning is enabled.

iX100/S1100i

Open the feed guide of the ScanSnap.

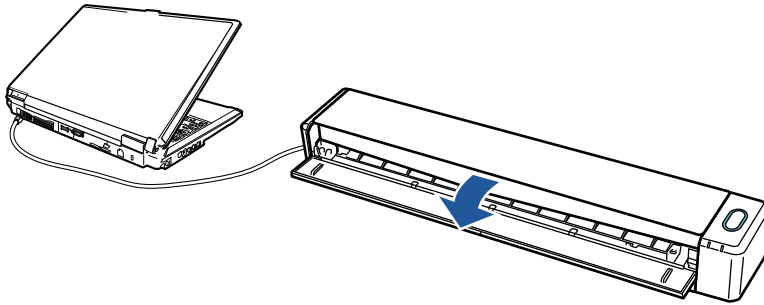

Example: iX100

⇒ The [Scan/Stop] button flashes in blue. The button returns to being lit normally when document scanning is enabled.

Press the [Scan] or [Stop] button on the ScanSnap.

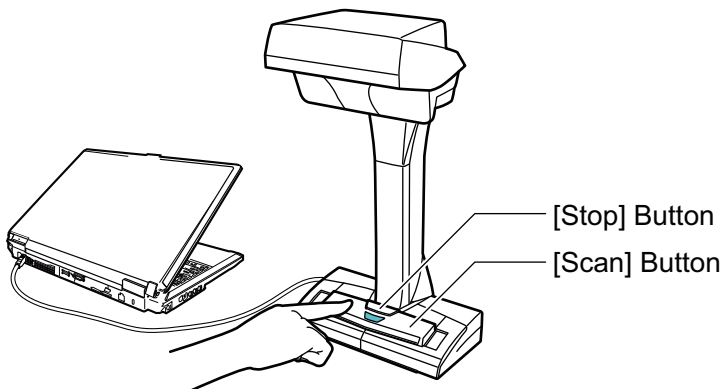

ATTENTION

When turning the power on, do not cover the white sheet with a hand.

⇒ The [Scan] button lights up in blue.

When the ScanSnap is turned on, the ScanSnap Manager icon in the notification area changes

from  to .

ATTENTION

For iX1600/iX1500/iX1400/iX1300/iX500/iX100/S1300i/S1100i, with some computers, the initialization of the ScanSnap may be performed several times when the computer is started up depending on some computers.

HINT

- It may take more time for the ScanSnap Manager icon in the notification area to change to  depending on computer performance, operating environment, or loading, for example, when many software programs are running at the same time.
- When the ScanSnap is turned on, a notification informs you of the ScanSnap's communication status.

To disable notifications of the ScanSnap's communication status, change the setting in the following procedure:

1. Right-click the ScanSnap Manager icon  in the notification area and select [Preferences] from the "Right-Click Menu" (page 100).
 - ⇒ The [ScanSnap Manager - Preferences] window appears.
2. Clear the [Notify of the communication status] checkbox in the [Status Display] list.

Turning the ScanSnap Off

1. Turn off the ScanSnap.

iX1600/iX1500/iX1400

Close the ADF paper chute (cover) of the ScanSnap.

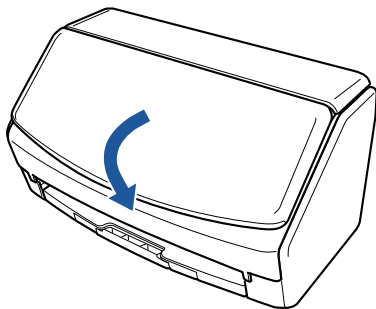

iX1300

Close the ADF paper chute (cover) of the ScanSnap.

When the ADF paper chute (cover) is closed, the extension will return to the original position in the ADF paper chute (cover) automatically.

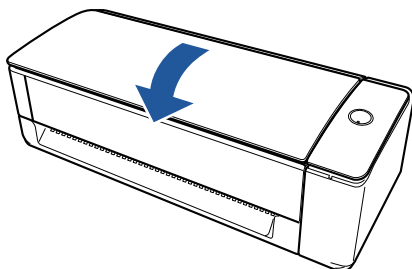

⇒ After the ScanSnap is left unused for one minute, it turns off resulting in the [Scan] button turning off.

iX500/S1300i

Close the ADF paper chute (cover) of the ScanSnap.

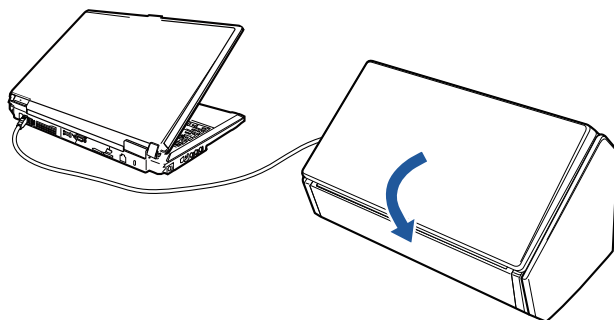

Example: iX500

⇒ The [Scan] button turns off.

iX100/S1100i

Close the feed guide of the ScanSnap.

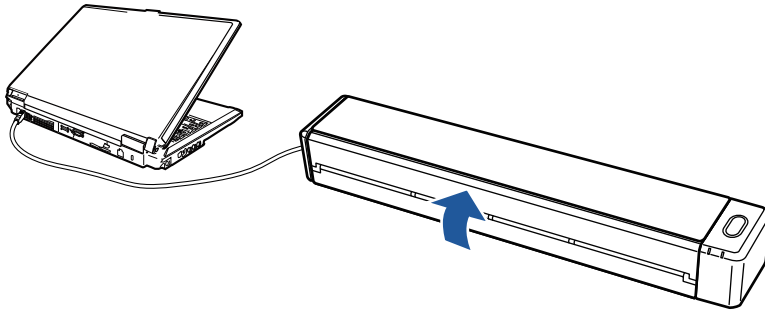

Example: iX100

⇒ The [Scan/Stop] button turns off.

SV600

Press the [Stop] button on the ScanSnap for three seconds or longer.

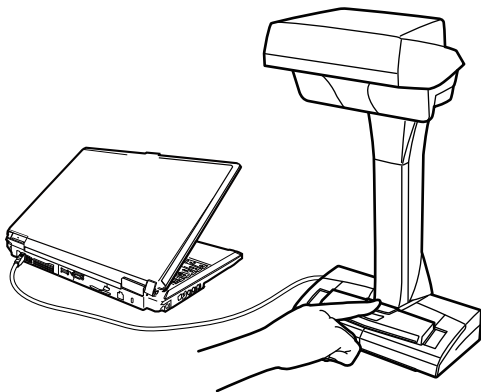

⇒ The power LED turns off.

The ScanSnap is turned off and the ScanSnap Manager icon in the notification area changes

from  to .

ATTENTION

- For iX1600/iX1500/iX1400/iX500/S1300i, close the ADF paper chute (cover) after putting the extension back.
- If moving the ScanSnap, first turn the power off and remove all cables.
- For iX1600/iX1500/iX1400/iX1300/iX500/S1300i, the bottom part of the ScanSnap may become hot when the ScanSnap is being used but this does not affect ScanSnap operation or cause any physical harm. Be careful not to drop the ScanSnap when carrying it.

HINT

- For iX1600/iX1500, the ScanSnap is turned on/off in conjunction with the computer's power if [Wi-Fi off] is selected for [Wi-Fi connect mode] in the [Wi-Fi settings] screen on the touch panel and if the ADF paper chute (cover) is open. If you keep the ScanSnap connected to the computer, you do not have to worry about turning the power ON/OFF.

For details about how to select [Wi-Fi off] for [Wi-Fi connect mode], refer to "[Turning Off the Wireless LAN Connection \(iX1600 / iX1500\)](#)" (page 177).

- For iX1300/iX500/iX100, if the Wi-Fi switch is off, the power of the ScanSnap and the computer is used to operate both devices. If you keep the ScanSnap connected to the computer, you do not have to worry about turning the power ON/OFF.

- For iX1400/S1300i/S1100i, the power of the ScanSnap is linked with the power of the computer to which the ScanSnap is connected. If you keep the ScanSnap connected to the computer, you do not have to worry about turning the power ON/OFF.
- For SV600, when the computer is turned off, the ScanSnap is also turned off.
- For iX1400/iX1300/iX500/iX100/S1300i/S1100i, it may take 2 to 3 minutes until the light of the [Scan] button goes out after the computer is turned off depending on some computers.
- When the ScanSnap is turned off, a notification informs you of the ScanSnap's communication status.

To disable notifications of the ScanSnap's communication status, change the setting in the following procedure:



1. Right-click the ScanSnap Manager icon  in the notification area and select [Preferences] from the "Right-Click Menu" (page 100).
⇒ The [ScanSnap Manager - Preferences] window appears.
2. Clear the [Notify of the communication status] checkbox in the [Status Display] list.

Startup Mode (iX1600 / iX1500 / iX1300)

The action that the ScanSnap takes when the ADF paper chute (cover) is opened and the ScanSnap is turned on depends on the start up mode setting of the ScanSnap.

The ScanSnap has two startup modes as described below.

- **Fast**

You can start scanning immediately. The ScanSnap enters sleep mode (standby mode) when the ADF paper chute (cover) is closed.

- **Normal**

The ScanSnap is turned on. The ScanSnap is turned off when the ADF paper chute (cover) is closed.

The procedure to change the setting for the startup mode of the ScanSnap is as follows:

iX1600/iX1500

1. Press  in the [home screen](#) on the touch panel of the ScanSnap to display the [Settings] screen.



2. Press  to display the [Scanner settings] screen.
3. Press [Startup Mode] to display the [Startup Mode] screen.
4. Change the setting.

5. Press  to return to the home screen.

iX1300

1. Right-click the ScanSnap Manager icon  in the notification area and select [Preferences] from the "Right-Click Menu" ([page 100](#)).
⇒ The [ScanSnap Manager - Preferences] window appears.
2. Change the setting for [Startup Mode] in the [Power] list.

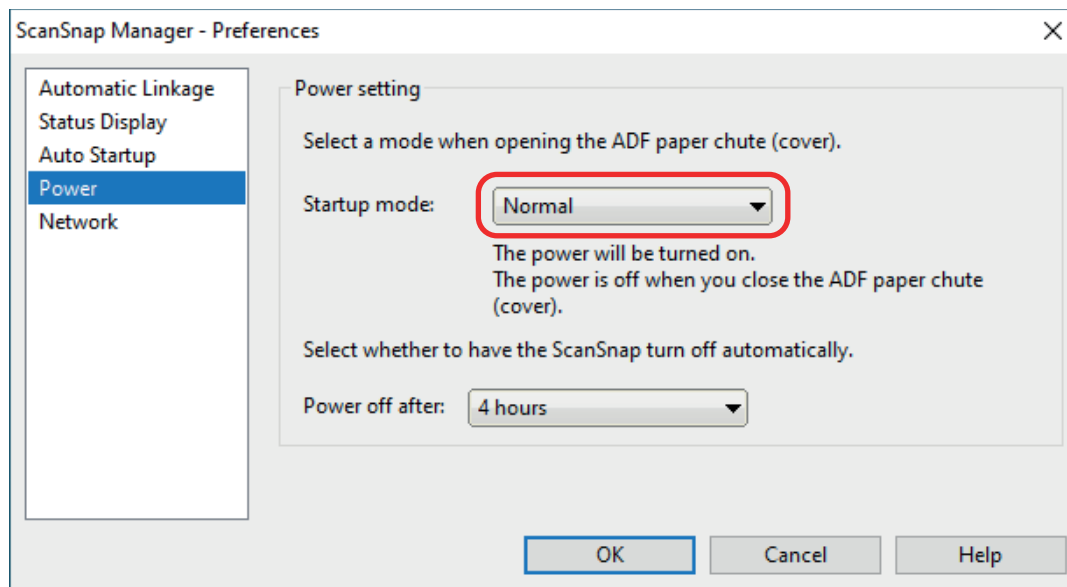

3. Click the [OK] button to close the [ScanSnap Manager - Preferences] window.

Sleep Mode

When the ScanSnap is on and has not been used for the following period of time, it enters sleep (power saving) mode.

iX1600/iX1500/iX1400/iX1300/SV600

15 minutes

iX500

14 minutes

iX100/S1300i/S1100i

1 minute

Automatic Power OFF (iX1600 / iX1500 / iX1400 / iX1300 / iX500 / iX100 / SV600 / S1300i)

When the ScanSnap is turned on and left unused for the specified time, it will turn itself off automatically.

HINT

- For iX1600/iX1500/iX1400/iX1300/iX500/SV600/S1300i, a notification informs you 5 minutes before the ScanSnap turns off automatically.
- For iX100, a notification appears in the following cases:
 - When a USB cable is used for connection, the ScanSnap will turn off automatically five minutes later.
 - When the ScanSnap is powered by the battery, the ScanSnap has turned off automatically.

Turning the ScanSnap back on after the ScanSnap Has Turned off Automatically

iX1600/iX1500

To turn the ScanSnap back on, perform one of the following operations:

- Press the touch panel of the ScanSnap
- Close the ADF paper chute (cover) and open it again

HINT

- To continue using the ScanSnap, reset the time until auto power-off by performing one of the following:
 - Load a document in the ScanSnap
 - Press the touch panel of the ScanSnap
 - Close the ADF paper chute (cover) and open it again
- When the startup mode of the ScanSnap is set to [Fast], the ScanSnap does not turn off and stays in sleep (power saving) mode.

iX1400/iX500/S1300i

To turn the ScanSnap back on, perform one of the following operations:

- Press the [Scan] button on the ScanSnap (this will not start scanning)
- Close the ADF paper chute (cover) and open it again

HINT

To continue using the ScanSnap, reset the time until auto power-off by performing one of the following:

- Load a document in the ScanSnap
- Press the [Scan] button on the ScanSnap
- Close the ADF paper chute (cover) and open it again

iX1300

To turn the ScanSnap back on, perform one of the following operations:

- Press the [Scan] button on the ScanSnap
- Close the ADF paper chute (cover) and open it again

HINT

- Regardless of the setting for the time of the ScanSnap to turn off automatically, if the ADF paper chute (cover) is closed, the ScanSnap is turned off automatically after it is left unused for one minute.
- To continue using the ScanSnap, reset the time until auto power-off by performing one of the following:
 - Load documents in the ADF paper chute (cover) or insert a document into the manual feeder
 - Press the [Scan] button on the ScanSnap
 - Close the ADF paper chute (cover) and open it again
- When the startup mode of the ScanSnap is set to [Fast], the ScanSnap does not turn off and stays in sleep (power saving) mode.

iX100

To turn the ScanSnap back on, perform one of the following operations:

- Press the [Scan/Stop] button on the ScanSnap
- Close the feed guide and open it again

HINT

To continue using the ScanSnap, reset the time until auto power-off by performing one of the following:

- Insert a document in the ScanSnap
- Press the [Scan/Stop] button on the ScanSnap
- Close the feed guide and open it again

SV600

To turn the ScanSnap back on, perform one of the following operations:

- Press the [Scan] button on the ScanSnap (this will not start scanning)
- Press the [Stop] button on the ScanSnap.

HINT

To continue using the ScanSnap, reset the time until auto power-off by pressing the [Scan] button on the ScanSnap.

Changing the ScanSnap's Power Settings

iX1600/iX1500

1. Press  in the [home screen](#) on the touch panel of the ScanSnap to display the [Settings] screen.



2. Press  to display the [Scanner settings] screen.
3. Press [Automatic power off] to display the [Automatic power off] screen.
4. Press the setting field for [ScanSnap will automatically power off] to display a list.
5. Change the setting.



6. Press  to return to the home screen.

iX1400/iX1300/iX500/iX100/SV600/S1300i

You can change the time of the ScanSnap to turn off automatically or change the setting so that it will not turn off automatically. Set according to the following procedures:

1. Right-click the ScanSnap Manager icon  in the notification area and select [Preferences] from the "Right-Click Menu" (page 100).
⇒ The [ScanSnap Manager - Preferences] window appears.
2. In the [Power] list, change the settings for [Power setting] based on how it is connected.

Checking the Remaining Battery Power (iX100)

The ScanSnap has a battery.

To check the remaining battery power, right-click the ScanSnap Manager icon  in the notification area located at the far right of the taskbar, and check [Battery] in the "Right-Click Menu" ([page 100](#)).

HINT

- The remaining battery power can be checked also in the [ScanSnap Manager - Scanner and driver information] window.
To open the [ScanSnap Manager - Scanner and driver information] window, select [ScanSnap information] in the "Right-Click Menu" ([page 100](#)).
- A notification appears in the following cases:
 - The remaining battery power is 10% or less.
 - No battery power remains and the ScanSnap is turned off.

Screens and Operations on the Touch Panel (iX1600 / iX1500)

- ["Screens on the Touch Panel \(iX1600 / iX1500\)" \(page 121\)](#)
- ["Entering Characters on the Touch Panel \(iX1600 / iX1500\)" \(page 126\)](#)
- ["Checking the Notification Displayed on the Touch Panel \(iX1600 / iX1500\)" \(page 127\)](#)

Screens on the Touch Panel (iX1600 / iX1500)

The screens displayed on the touch panel of the ScanSnap are either the home screen to start scanning or the [Settings] screen to check or modify the settings of the ScanSnap.

This section explains the following screens:

- "Home screen" (page 121)
- "[Settings] Screen" (page 123)

Home screen

The home screen is a screen where you perform a scan.

When the ScanSnap and a computer are connected, one of the following screens appears.

- When the ScanSnap and the computer are connected via a USB cable

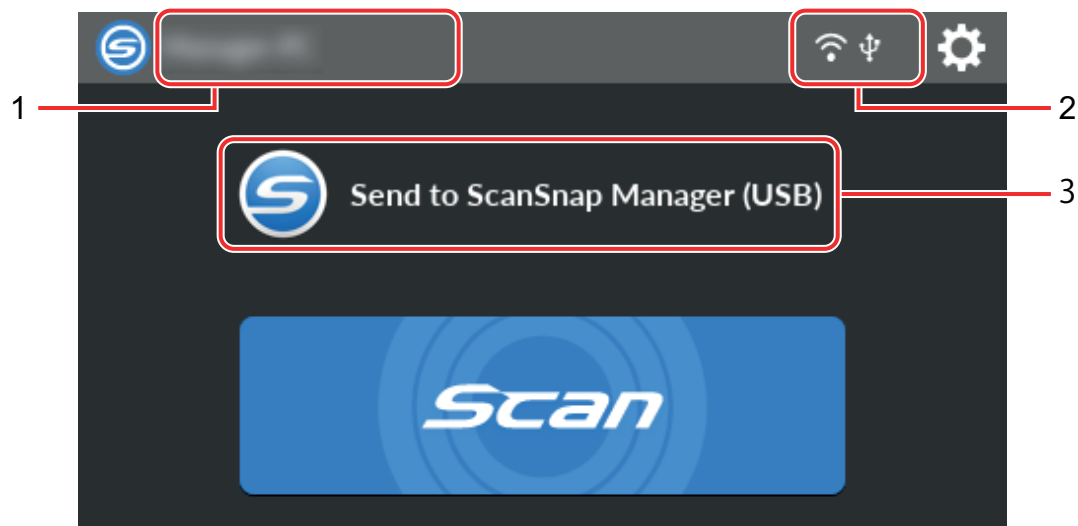

- When the ScanSnap and a computer are connected via wireless LAN

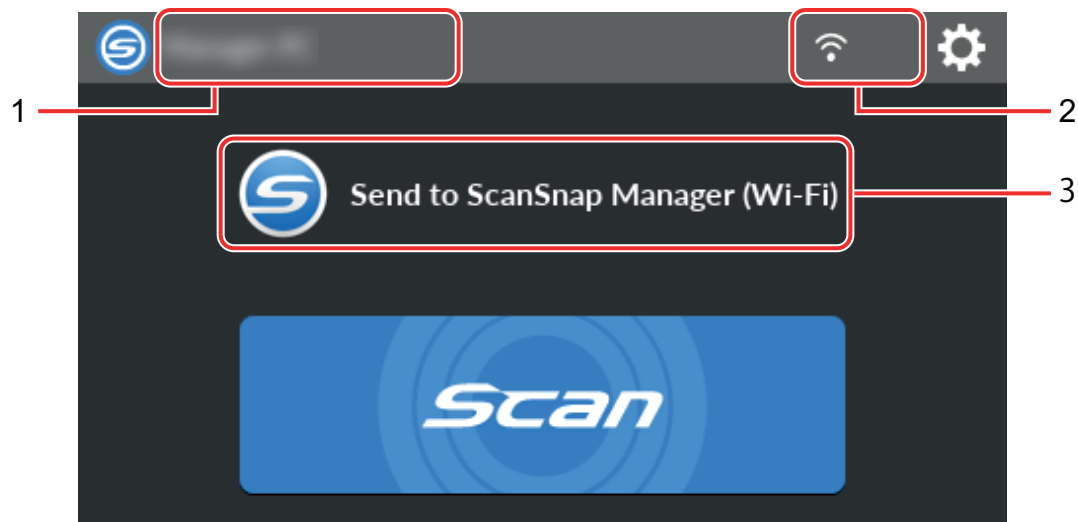

When the ScanSnap and a mobile device are connected, the following screen appears.

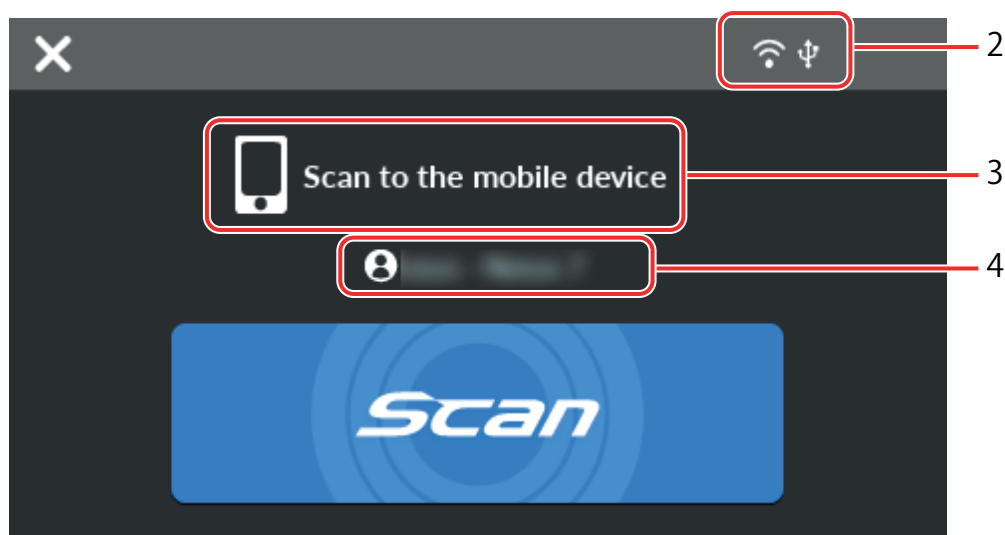

Displays the [Selecting a User] screen.

In the [Selecting a User] screen, user names of the computers that have been connected to the ScanSnap before are listed. Selecting a user name in the list can change the current computer to the computer that you want to connect the ScanSnap to.



is displayed in the following cases:

- The options below are selected in the [Settings] screen on the touch panel
 - [Selected user] is selected for [Display of profiles] in the [Scanner settings] screen
 - [Access point connection] or [Direct connection] is selected for [Wi-Fi connect mode] in the [Wi-Fi settings] screen
- Two or more history records of computers that have been connected to the ScanSnap before exist

User name (1)

Displays a user name that is connected with the ScanSnap.

A user name is displayed in the following cases:

- The options below are selected in the [Settings] screen on the touch panel
 - [Selected user] is selected for [Display of profiles] in the [Scanner settings] screen
 - [Access point connection] or [Direct connection] is selected for [Wi-Fi connect mode] in the [Wi-Fi settings] screen
- Two or more history records of computers that have been connected to the ScanSnap before exist

Connection status (2)

Displays the connection statuses of the ScanSnap.



Displays the signal status between a wireless access point and the ScanSnap in four levels.

When the ScanSnap is searching for a wireless access point or is not connected to a wireless access point,  appears.



Appears when the ScanSnap and the computer are connected via a USB cable.





Appears when the Wi-Fi connect mode for the ScanSnap is set to Direct Connect mode which is not via a wireless access point.

When the ScanSnap cannot establish a connection to a wireless access point, the ScanSnap and the computer or mobile device can be connected directly via wireless LAN.



Displays the [Settings] screen. You can configure the settings for the ScanSnap.

When there is a maintenance notification,  appears on .

Status (3)

Displays the status of a computer or mobile device that is connected to the ScanSnap.

Device name (4)



Displays a mobile device name when a device that is connected to the ScanSnap is a mobile device.



Disconnects the connection between the ScanSnap and the mobile device.

[Scan] button

Scanning starts.

When  is displayed on the [Scan] button, scanning does not start. Follow the message that is displayed when you press  to solve the problem.

[Settings] Screen

The [Settings] screen is the screen in which you can check the ScanSnap, wireless LAN, and maintenance information, and specify settings.



Returns to the home screen.



Displays the [Maintenance] screen.

The following operations can be performed in the [Maintenance] window.

- Specifying the setting to notify you when the scanner detects dirt on the glass which causes vertical streaks on scanned images

- Checking when to replace consumables
- Starting the cleaning operation for the feed rollers and eject rollers
- Updating the firmware to a newer version



In the following cases,  appears on

- When dirt on the glass is detected
- When the scanned page count exceeded the replacement cycle
- When the latest firmware is available



Displays the [Scanner settings] screen.

The following operations can be performed in the [Scanner settings] window.

- Checking the information on the ScanSnap, wireless LAN, or network
- Configuring the following settings
 - Name of the ScanSnap
 - Whether or not to display the results regarding the saving process of scanned images in a cloud service
 - Startup mode
 - Automatic power off
 - Method to display profiles
 - Language displayed on the touch panel
 - Type of USB operation
- Resetting the following settings
 - Settings other than [Display language] in the [Scanner settings] screen
 - Setting for the [Notify when the latest is available] checkbox in [Update firmware] in the [Maintenance] screen
 - Setting for the [Notify when glass is dirty] checkbox in [Dust detection] in the [Maintenance] screen



Displays the [Wi-Fi settings] screen.

The following operations can be performed in the [Wi-Fi settings] window.

- Switching the wireless LAN connect mode for connecting the ScanSnap to a computer or mobile device
- Modifying the settings for each connect mode
- Checking the information such as the wireless LAN connection status and the signal strength
- Resetting the wireless settings that are configured for the ScanSnap

When there is a device with the same IP address as that of the ScanSnap on the network,  is

displayed on  .



The [Connecting Devices] screen is displayed.

Shows the information below which is necessary when connecting a new computer or a new mobile device.

- Scanner name
- IP address
- Network name (SSID)
- Security key

The displayed information varies depending on the connection method.



Displays the [Help] screen.

Shows the reference page on ScanSnap Help.

Entering Characters on the Touch Panel (iX1600 / iX1500)

When changing the scanner name for the ScanSnap or entering a security key to connect to the wireless LAN, the keyboard screen is used to enter characters.

The keyboard screen is displayed when you press  in the input field.



No.	Description
1	To switch between upper case and lower case for characters to be input. Pressing this key twice continuously, locks it. To unlock this key, press it once.
2	To switch the letter types for characters to be input. A: Alphabets 1: Numbers
3	To switch the keyboard to enter symbols.
4	To enter a space.
5	To move the cursor.
6	To finish entering.
7	To delete a letter on the left of the cursor.

Checking the Notification Displayed on the Touch Panel (iX1600 / iX1500)

When the glass inside the ScanSnap is dirty, replacement for consumables is needed, or the latest firmware is available, a notification is displayed on the touch panel of the ScanSnap.

When there is a notification,  appears on  in the home screen on the touch panel.

When a notification is displayed, check the content and take measures accordingly.

1. Press  in the **home screen** on the touch panel of the ScanSnap to display the [Settings] screen.

2. Press  to display the [Maintenance] screen.

3. Press the menu on which  is displayed.

⇒ When the glass is dirty,  is displayed on [Dust detection].

When the consumables need to be replaced,  is displayed on [Check consumable status].

When the latest firmware is available,  is displayed on [Update firmware].

4. **Check the content of the notification and then clean the glass, replace the consumables, or update the firmware.**

For details about how to clean the ScanSnap, replace the consumables, or update the firmware, refer to the following:

- "Cleaning the Inside of iX1600 / iX1500 / iX1400" (page 510)
- "Replacing Consumables for iX1600 / iX1500 / iX1400" (page 553)
- "Updating the Firmware (iX1600 / iX1500)" (page 586)

HINT

- You can set whether to detect when the glass is dirty and display a notification on the touch panel with [Notify when glass is dirty] in the [Dust detection] screen.
- You can set whether to display a notification on the touch panel when the latest firmware is available with [Notify when the latest is available] in the [Update firmware] screen.

Attaching the Receipt Guide (iX1600 / iX1500 / iX1400)

When you scan business cards or receipts, attaching the Receipt Guide to the ScanSnap makes it easy to scan them. By using the Receipt Guide for business cards and receipts, you can place documents with different widths such as receipts in it to scan them at the same time.

Documents that can be scanned with the Receipt Guide

The Receipt Guide allows you to load three kinds of documents. It allows you to load different-sized documents in each loading section to scan them at the same time.

In addition, you can move side guides, or close the ADF paper chute (cover) to turn the power off with the Receipt Guide attached to the ScanSnap. Therefore, you do not need to attach and remove the Receipt Guide every time you use it.

HINT

Attaching the Receipt Guide on the ScanSnap limits the number of sheets that can be loaded in the ADF paper chute (cover). Remove the Receipt Guide from the ScanSnap when scanning a large number of documents.

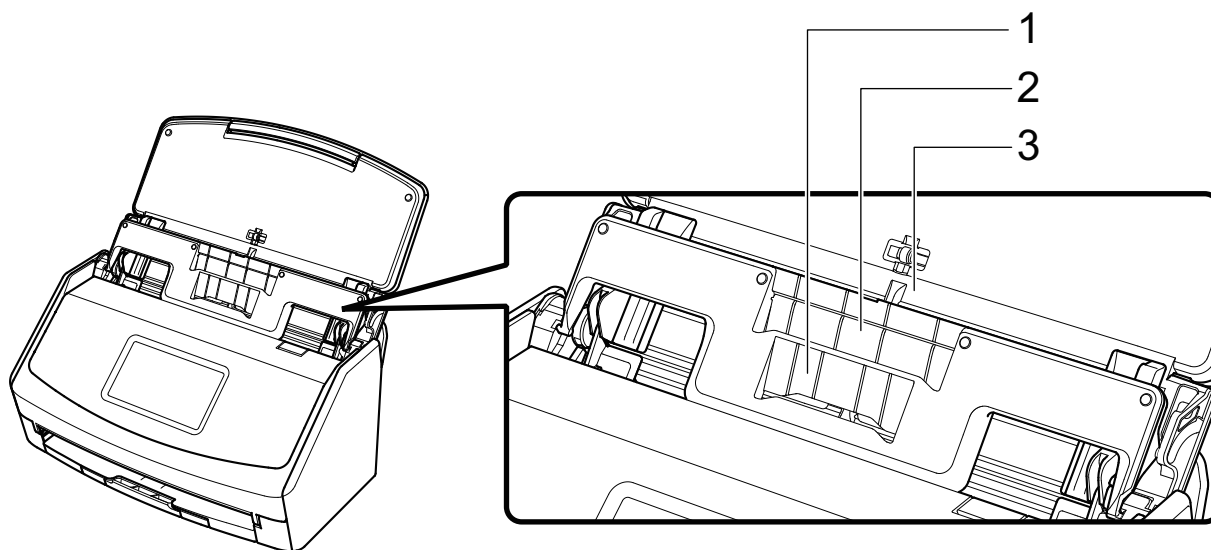

Example: iX1600

Loading section	1	2	3
Document type	Business cards and receipts	Receipts	Office paper
Paper weight	40 to 209 g/m ² (11 to 56 lb)		
Paper size	Width 58 mm (2.28 in.) Length 50.8 to 360 mm (2 to 14.17 in.) For long page documents, up to 863 mm (34 in.)	Width 83 mm (3.26 in.) Length 50.8 to 360 mm (2 to 14.17 in.) For long page documents, up to 863 mm (34 in.)	Width 148 to 216 mm (5.82 to 8.5 in.) Length 50.8 to 360 mm (2 to 14.17 in.) For long page documents, up to 863 mm (34 in.)

- 1. Open the ADF paper chute (cover) of the ScanSnap to turn the power on.**

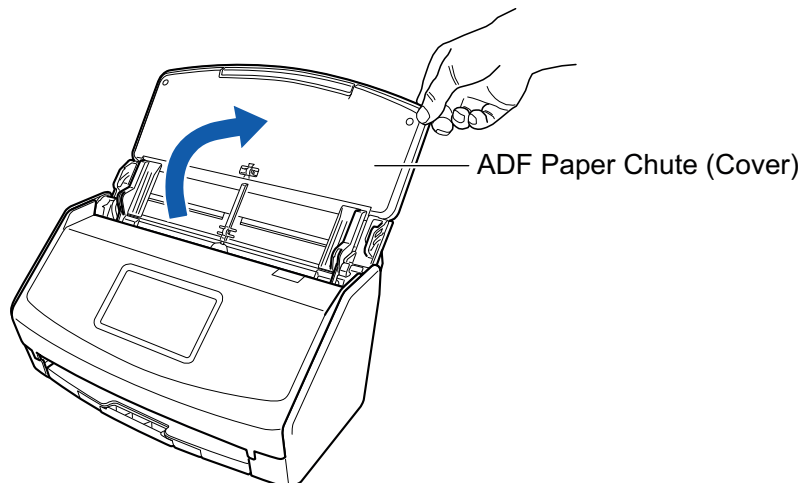

Example: iX1600

- 2. Slide the side guides all the way out.**

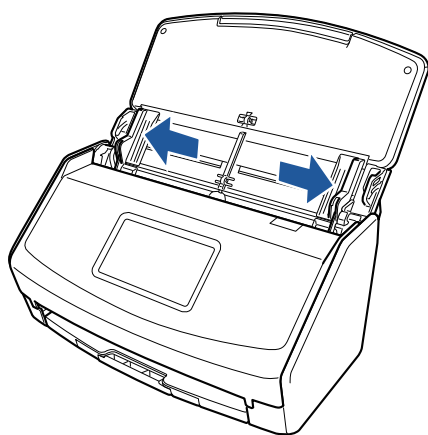

Example: iX1600

- 3. Fit the protrusions on the Receipt Guide in the slots on the ScanSnap.**

The body of the ScanSnap may vary in color depending on the region where you purchased the ScanSnap.



Example: iX1600

4. Slide the Receipt Guide down along the guide.

The body of the ScanSnap may vary in color depending on the region where you purchased the ScanSnap.

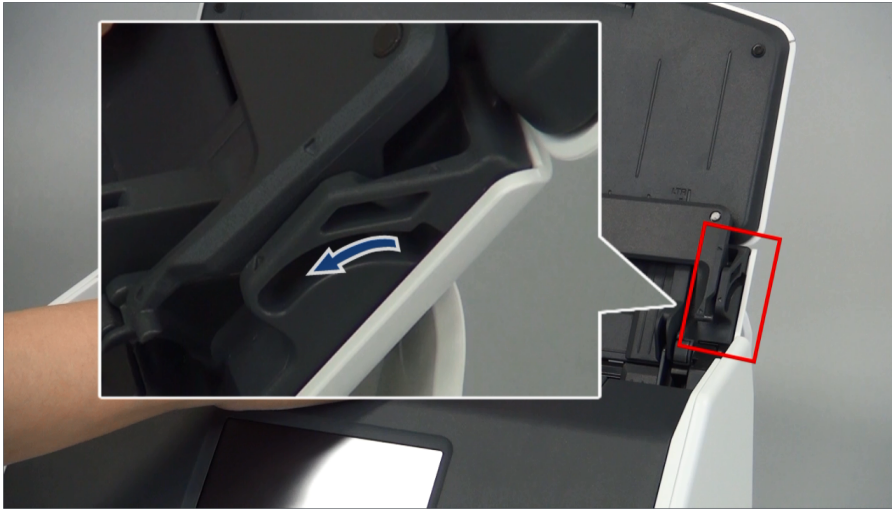

Example: iX1600

5. Press the protrusions on the right and left firmly to fit them in the slots until it clicks.

The body of the ScanSnap may vary in color depending on the region where you purchased the ScanSnap.

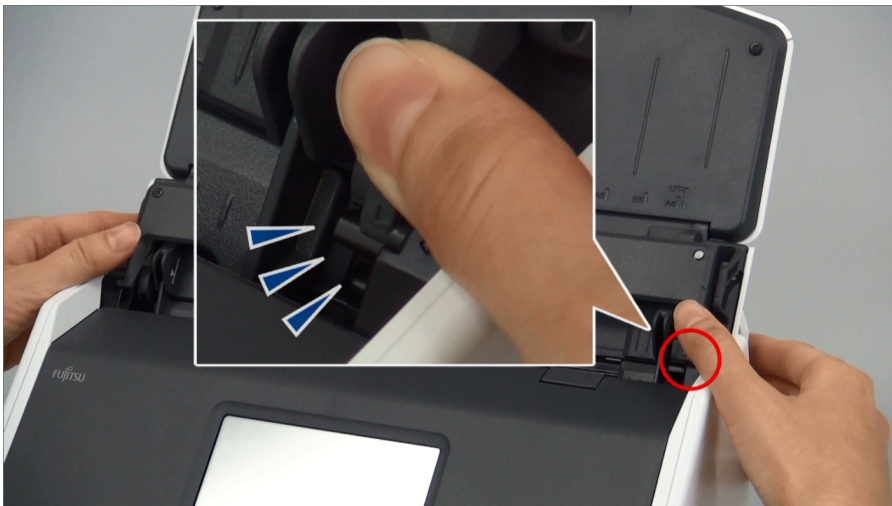

Example: iX1600

You can remove the Receipt Guide by holding it with one hand and pulling it.

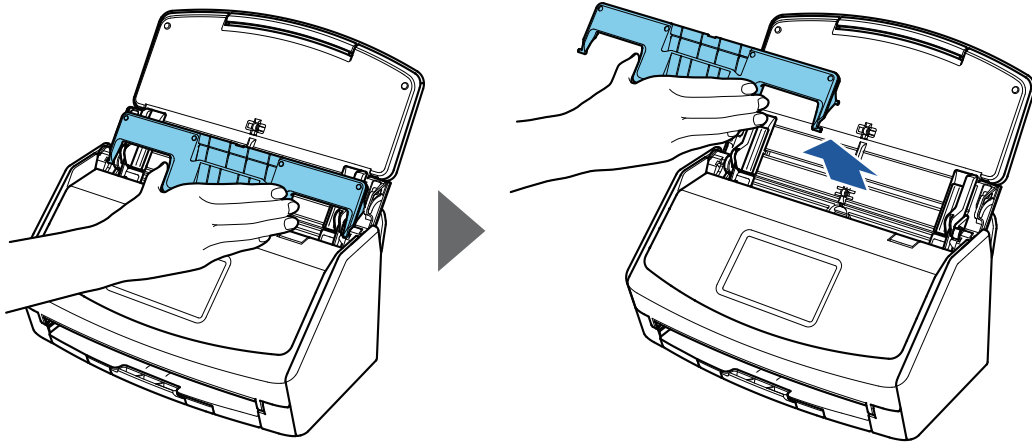

Example: iX1600

Connecting the ScanSnap via Wireless LAN (iX1600 / iX1500)

By connecting the ScanSnap to a computer or a mobile device via wireless LAN, you can scan documents.

Select one of the following wireless modes to connect the ScanSnap to the computer or mobile device.

- Access Point Connect mode

When a wireless LAN environment has already been configured, the ScanSnap and the computer or mobile device are connected via a wireless access point.

- Direct Connect mode

When a wireless LAN environment has not been configured or the ScanSnap cannot establish a connection to a wireless access point, the ScanSnap and the computer or mobile device are connected directly via wireless LAN.

The wireless mode can be switched from the touch panel of the ScanSnap.

- ["Preparations for Connecting the ScanSnap via Wireless LAN \(iX1600 / iX1500\)" \(page 133\)](#)
- ["Connecting the ScanSnap to a Wireless LAN \(iX1600 / iX1500\)" \(page 134\)](#)
- ["Connecting the ScanSnap to a computer or mobile device via Wireless LAN \(iX1600 / iX1500\)" \(page 139\)](#)

Preparations for Connecting the ScanSnap via Wireless LAN (iX1600 / iX1500)

To connect the ScanSnap via wireless LAN, prepare the following:

- An environment in which a wireless LAN is available

To connect the ScanSnap and a computer or a mobile device in Access Point Connect mode, prepare the wireless LAN environment.

When connecting the ScanSnap to a wireless access point, you may need information such as an SSID (network name) and a security key (password).

For details, refer to the manual for the wireless access point.

ATTENTION

Do not place the following within 100 mm (3.9 in.) of the ScanSnap, or near your wireless access point.

- Obstacles that block radio waves (such as walls and metal plates)
- Devices that may cause signal interference (such as microwaves and cordless phones) and wireless devices

- ScanSnap Connect Application

To connect the ScanSnap and a mobile device, you need to install ScanSnap Connect Application on your mobile device.

Download ScanSnap Connect Application for the mobile device from the following application stores:

- App Store
- Google Play
- Amazon Appstore

Connecting the ScanSnap to a Wireless LAN (iX1600 / iX1500)

To connect the ScanSnap and a computer or a mobile device in Access Point Connect mode, connect the ScanSnap to a wireless access point.

HINT

When you cannot connect the ScanSnap to a wireless access point, use Direct Connect mode to connect the ScanSnap to a computer or a mobile device directly.

For details, refer to the following:

- ["Connecting the ScanSnap to a Computer Directly in Direct Connect Mode \(iX1600 / iX1500\)" \(page 143\)](#)
- ["Connecting the ScanSnap to a Mobile Device in Direct Connect Mode \(iX1600 / iX1500\)" \(page 145\)](#)
- ["Connecting the ScanSnap to a Wireless Access Point by Using the ScanSnap Wireless Setup Tool \(iX1600 / iX1500\)" \(page 135\)](#)
- ["Connecting the ScanSnap to a Wireless Access Point from the Touch Panel \(iX1600 / iX1500\)" \(page 136\)](#)

Connecting the ScanSnap to a Wireless Access Point by Using the ScanSnap Wireless Setup Tool (iX1600 / iX1500)

The ScanSnap Wireless Setup Tool is an application to configure the wireless settings required for connecting your ScanSnap via wireless LAN in a wizard format. The ScanSnap Wireless Setup Tool can be used to configure and check the following wireless LAN settings and connection.

- Connecting the ScanSnap to a wireless access point
- Setting the IP address and name for the ScanSnap
- Checking the connection between the ScanSnap and the computer

Follow the procedure below to start the ScanSnap Wireless Setup Tool and configure the wireless settings.

1. Start the ScanSnap Wireless Setup Tool.

- Windows 10
Select [Start] menu → [ScanSnap Manager] → [ScanSnap Wireless Setup Tool].
 - Windows 8.1
Click  on the lower left side of the Start screen, and select [ScanSnap Wireless Setup Tool] under [ScanSnap Manager] on the All apps screen.
 - Windows 7
Select [Start] menu → [All Programs] → [ScanSnap Manager] → [ScanSnap Wireless Setup Tool].
- ⇒ The ScanSnap Wireless Setup Tool will start running.

2. Click the [Wireless Network Setup Wizard] button in the main menu.

⇒ The Wireless Network Setup Wizard appears.

3. Follow the instructions in the Wireless Network Setup Wizard to configure the wireless settings.

Configure and check the wireless settings based on the wireless LAN environment in which the ScanSnap is used.

HINT



- For details and operation of ScanSnap Wireless Setup Tool, refer to the ScanSnap Wireless Setup Tool Help.
- The ScanSnap Wireless Setup Tool is also started up when the ScanSnap software is installed.

Connecting the ScanSnap to a Wireless Access Point from the Touch Panel (iX1600 / iX1500)

To use the ScanSnap over a wireless LAN, connect the ScanSnap to a wireless access point which the computer is connected to. The ScanSnap can be connected to a wireless access point from the touch panel.

1. Press  in the **home screen** on the touch panel of the ScanSnap to display the **[Settings]** screen.



2. Press  to display the **[Wi-Fi settings]** screen.
3. Press **[Wi-Fi connect mode]** to display the **[Wi-Fi connect mode]** screen.
4. Select **[Access point connection]**.
5. Press  to return to the **[Wi-Fi settings]** screen.
6. Press **[Access point connection]** to display the **[Access point connection]** screen.
7. Press **[Access point connect settings]** to display the **[Connection information configuration method]** screen.
8. Connect the ScanSnap to a wireless access point.

When connecting the scanner by selecting a wireless access point from the list

1. Select **[Select an access point]**.
2. Press the **[Next]** button to display the **[Select network]** screen.
3. From the list of displayed wireless access points, select a wireless access point that you want to connect to.
4. Press the **[Next]** button to display the **[Enter connection information]** screen.
5. Enter the information of the wireless access point to be used and press the **[Next]** button.
The items which are displayed in the screen differ depending on the security protocol of the wireless access point.
 - To perform the authentication with a security key
Press the input field for **[Security key]** and enter the user name, and then press **[OK]**.

- To perform the authentication with a client certificate
Press [Client certificate] and select the certificate to be used.

HINT

To check the details about the certificate, press the [Certificate] button.

- To perform the authentication with a user ID and a password
Press the input field and enter a value for [User ID] and [Password] respectively, and then press [OK].
 - To perform the authentication with an external ID
Press the input field for [External ID], enter the external ID, and press [OK].
6. Press the [Complete] button in the [Check Connection Results] screen.



7. Press  to display the home screen.

When connecting the scanner by entering information of a wireless access point

1. Select [Configure manually].
2. Press the [Next] button to display the [Enter connection information] screen.
3. Enter the information of the wireless access point to be used and press the [Next] button.
The items which are displayed in the screen differ depending on the security protocol of the wireless access point.
4. Press the [Complete] button in the [Check Connection Results] screen.



5. Press  to display the home screen.

When connecting the scanner by using the WPS button of a wireless access point

1. Select [WPS (button)].
2. Press the [Next] button.
3. Press the button for the WPS function on the wireless access point.
The wireless access point is ready to be connected from the ScanSnap.

HINT

For details about the WPS function, refer to the manual of your wireless access point.

4. Go back to the touch panel of the ScanSnap, and press the [Next] button in the [WPS (button)] screen within two minutes.
5. Press the [Complete] button in the [Check Connection Results] screen.

6. Press  to display the home screen.

When connecting the scanner by using the PIN code of the WPS function of a wireless access point

1. Select [WPS (PIN)].
2. Press the [Next] button to display the [WPS (PIN)] screen.
Take a note of the PIN that is displayed in the screen in case you forget it.
3. Open the window for setting the WPS for the wireless access point in a computer or mobile device, and enter the PIN for the ScanSnap.

The wireless access point is ready to be connected from the ScanSnap.

HINT

For details about the WPS function, refer to the manual of your wireless access point.

4. Go back to the touch panel of the ScanSnap, and press the [Next] button in the [WPS (PIN)] screen within two minutes.
5. Press the [Complete] button in the [Check Connection Results] screen.

6. Press  to display the home screen.

⇒ The computer and the ScanSnap are connected via wireless LAN using the same wireless access point.

Connecting the ScanSnap to a computer or mobile device via Wireless LAN (iX1600 / iX1500)

- "Connecting the ScanSnap to a Computer in Access Point Connect Mode (iX1600 / iX1500)" (page 140)
- "Connecting the ScanSnap to a Mobile Device in Access Point Connect Mode (iX1600 / iX1500)" (page 142)
- "Connecting the ScanSnap to a Computer Directly in Direct Connect Mode (iX1600 / iX1500)" (page 143)
- "Connecting the ScanSnap to a Mobile Device in Direct Connect Mode (iX1600 / iX1500)" (page 145)

Connecting the ScanSnap to a Computer in Access Point Connect Mode (iX1600 / iX1500)

Configure the wireless settings for the ScanSnap in the ScanSnap Wireless Setup Tool Wizard or on the touch panel to complete the preparation for connecting the ScanSnap to a computer.

For details, refer to the following:

- ["Connecting the ScanSnap to a Wireless Access Point by Using the ScanSnap Wireless Setup Tool \(iX1600 / iX1500\)" \(page 135\)](#)
- ["Connecting the ScanSnap to a Wireless Access Point from the Touch Panel \(iX1600 / iX1500\)" \(page 136\)](#)

The following explains how to connect the ScanSnap and a computer when the wireless settings for the ScanSnap have already been configured.

1. Disconnect the USB cable connecting the ScanSnap to the computer.

ATTENTION

If the ScanSnap Manager icon is , exit ScanSnap Connect Application on the mobile device.

⇒ The ScanSnap is automatically connected to the computer via wireless LAN and the

ScanSnap Manager icon changes to .

If the icon does not change, go to step 2.

HINT

- If the [Connect automatically to previous ScanSnap by Wi-Fi] checkbox is selected and the previously connected ScanSnap is available for the connection, the computer is connected to the ScanSnap automatically.
- The computer can be connected to only one ScanSnap.
- Only one computer can be connected to the ScanSnap via wireless LAN.

2. Right-click the ScanSnap Manager icon in the notification area located at the far right of the taskbar and select [Connect by Wi-Fi] from the "Right-Click Menu" (page 100).

⇒ The [ScanSnap Manager - Connect by Wi-Fi] window appears.

3. From the list of the ScanSnap units to be connected, select the ScanSnap that you want to connect, and click the [Connect] button.

ATTENTION

If the intended ScanSnap for connection does not appear in the list of the ScanSnap units to be connected, refer to the ScanSnap Manager Help.

⇒ The ScanSnap is connected to a computer via wireless LAN and the ScanSnap Manager

icon changes to .

HINT

When the ScanSnap and a computer are connected via wireless LAN, a notification informs you of the communication status.

Connecting the ScanSnap to a Mobile Device in Access Point Connect Mode (iX1600 / iX1500)

Configure the wireless settings for the ScanSnap in the ScanSnap Wireless Setup Tool Wizard or on the touch panel to complete the preparation for connecting the ScanSnap to a mobile device.

For details, refer to the following:

- ["Connecting the ScanSnap to a Wireless Access Point by Using the ScanSnap Wireless Setup Tool \(iX1600 / iX1500\)" \(page 135\)](#)
- ["Connecting the ScanSnap to a Wireless Access Point from the Touch Panel \(iX1600 / iX1500\)" \(page 136\)](#)

The following explains how to connect the ScanSnap and a mobile device when the wireless settings for the ScanSnap have already been configured.

1. Start ScanSnap Connect Application on your mobile device.

- ⇒ The mobile device will automatically be connected to an available ScanSnap on the same network.

HINT

- If more than one available ScanSnap is detected, or if ScanSnap Connect Application is set not to connect a mobile device to a ScanSnap automatically, then tap the ScanSnap that you want by name, in order to connect to the mobile device, under [ScanSnap] on the [Connect to] screen. For details, refer to the Basic Operation Guide (Mobile Connection) for your mobile device.
- A notification appears in the following cases:
 - When the ScanSnap and the mobile device are connected via wireless LAN, and the communication with ScanSnap Manager is disconnected
 - When you log onto the computer which is connected to the ScanSnap with the ScanSnap and the mobile device already connected via wireless LAN



Connecting the ScanSnap to a Computer Directly in Direct Connect Mode (iX1600 / iX1500)

When a wireless LAN environment has not been configured or the ScanSnap cannot establish a connection to a wireless access point, and if you want to connect the ScanSnap to a computer via wireless LAN, use Direct Connect mode to connect the scanner to the computer directly.

- 1. When the ScanSnap is connected to a computer via the USB cable, unplug the USB cable.**
- 2. Set [Wi-Fi connect mode] to [Direct connection] for the ScanSnap.**



1. Press  in the **home screen** on the touch panel of the ScanSnap to display the [Settings] screen.



2. Press  to display the [Wi-Fi settings] screen.
3. Press [Wi-Fi connect mode] to display the [Wi-Fi connect mode] screen.
4. Select [Direct connection].
5. Press  twice to display the [Settings] screen.

- 3. Connect the ScanSnap and a computer directly by using a direct connection.**



1. Press  to display the [Connecting Devices] screen.
2. Click  in the notification area located at the far right of the taskbar, and connect the ScanSnap network displayed in the wireless network list.
 - ⇒ The ScanSnap is connected to a computer via wireless LAN and the ScanSnap Manager icon in the notification area located at the far right of the taskbar changes to



If the icon does not change, go to step 4.

ATTENTION

If the ScanSnap Manager icon is , exit ScanSnap Connect Application on the mobile device.

HINT

- If the [Connect automatically to previous ScanSnap by Wi-Fi] checkbox is selected and the previously connected ScanSnap is available for the connection, the computer is connected to the ScanSnap automatically.
- The computer can be connected to only one ScanSnap.
- Only one computer can be connected to the ScanSnap via wireless LAN.

4. **Right-click the ScanSnap Manager icon  in the notification area located at the far right of the taskbar and select [Connect by Wi-Fi] from the "Right-Click Menu" (page 100).**

⇒ The [ScanSnap Manager - Connect by Wi-Fi] window appears.

5. **From the list of the ScanSnap units to be connected, select the ScanSnap that you want to connect, and click the [Connect] button.**

ATTENTION

If the intended ScanSnap for connection does not appear in the list of the ScanSnap units to be connected, refer to the ScanSnap Manager Help.

⇒ The ScanSnap is connected to the computer via a wireless access point and the ScanSnap

Manager icon changes to .

HINT

When the ScanSnap and a computer are connected via wireless LAN, a notification informs you of the communication status.

Connecting the ScanSnap to a Mobile Device in Direct Connect Mode (iX1600 / iX1500)

If a wireless LAN environment has not been configured or the ScanSnap cannot establish a connection with a wireless access point, connect the ScanSnap to a mobile device directly in Direct Connect mode.

1. Set [Wi-Fi connect mode] to [Direct connection] for the ScanSnap.

1. Press  in the [home screen](#) on the touch panel of the ScanSnap to display the [Settings] screen.



2. Press  to display the [Wi-Fi settings] screen.
3. Press [Wi-Fi connect mode] to display the [Wi-Fi connect mode] screen.
4. Select [Direct connection].

5. Press  twice to display the [Settings] screen.

2. Connect the ScanSnap and a mobile device directly by using a direct connection.



1. Press  to display the [Connecting Devices] screen.
2. Open the screen for setting the Wi-Fi function on the mobile device.

HINT

For details, refer to the manual of the mobile device.

3. Enter the network name (SSID) and security key that are displayed in the [Connecting Devices] screen in the window for setting the Wi-Fi function.
4. Start up ScanSnap Connect Application on the mobile device, and connect the ScanSnap and the mobile device directly.

For details about how to connect the ScanSnap to a mobile device, refer to the Basic Operation Guide (Mobile Connection).

Connecting the ScanSnap via Wireless LAN (iX1300 / iX500 / iX100)

By connecting the ScanSnap to a computer or a mobile device via wireless LAN, you can scan documents.

iX1300/iX100

Select one of the following wireless modes to connect the ScanSnap to the computer or mobile device.

- Access Point Connect mode

When a wireless LAN environment has already been configured, the ScanSnap and the computer or mobile device are connected via a wireless access point.

- Direct Connect mode

When a wireless LAN environment has not been configured or the ScanSnap cannot establish a connection to a wireless access point, the ScanSnap and the computer or mobile device are connected directly via wireless LAN.

For iX100, the wireless mode automatically switches to the Access Point Connect mode or the Direct Connect mode in accordance with the wireless LAN environment where the ScanSnap is used.

When the ScanSnap is turned on, it is connected to the wireless access point that was set in the ScanSnap Wireless Setup Tool. If no wireless access point is detected, the mode is switched to the Direct Connect mode.

HINT

- When the wireless access point that was set in the ScanSnap Wireless Setup Tool is detected, even if the wireless access point is not connectable, the mode is not switched from the Access Point Connect mode to the Direct Connect mode.

To switch the mode to the Direct Connect mode, turn off the ScanSnap and then turn it on again in an environment in which no wireless access point is detected.

- Even if the wireless access point that was set in the ScanSnap Wireless Setup Tool is detected after the mode is switched to the Direct Connect mode, the mode is still not switched to the Access Point Connect mode.

To connect the ScanSnap in Access Point Connect mode, turn off the ScanSnap and then turn it on again.

For details about how to switch the wireless mode and how to configure the wireless settings, refer to the ScanSnap Wireless Setup Tool Help.

- ["Preparations for Connecting the ScanSnap via Wireless LAN \(iX1300 / iX500 / iX100\)" \(page 147\)](#)
- ["Connecting the ScanSnap to a Wireless LAN \(iX1300 / iX500 / iX100\)" \(page 148\)](#)
- ["Connecting the ScanSnap to a Computer or Mobile Device via Wireless LAN \(iX500\)" \(page 156\)](#)
- ["Connecting the ScanSnap to a computer or mobile device via Wireless LAN \(iX1300 / iX100\)" \(page 149\)](#)
- ["Reconnecting to a Wireless Access Point Using the ScanSnap WPS Button \(iX1300 / iX500 / iX100\)" \(page 160\)](#)

Preparations for Connecting the ScanSnap via Wireless LAN (iX1300 / iX500 / iX100)

To connect the ScanSnap via wireless LAN, prepare the following:

- An environment in which a wireless LAN is available

To connect the ScanSnap and a computer or a mobile device in Access Point Connect mode, prepare the wireless LAN environment.

When connecting the ScanSnap to a wireless access point, you may need information such as an SSID (network name) and a security key (password).

For details, refer to the manual for the wireless access point.

ATTENTION

- Do not place the following within 100 mm (3.9 in.) of the ScanSnap, or near your wireless access point.
 - Obstacles that block radio waves (such as walls and metal plates)
 - Devices that may cause signal interference (such as microwaves and cordless phones) and wireless devices
- If the wireless access point has two types of SSID (2.4 GHz and 5 GHz) when you connect iX500/iX100 to the wireless access point, the 2.4 GHz SSID needs to be used.

- ScanSnap Connect Application

To connect the ScanSnap and a mobile device, you need to install ScanSnap Connect Application on your mobile device.

Download ScanSnap Connect Application for the mobile device from the following application stores:

- App Store
- Google Play
- Amazon Appstore

HINT

To connect iX1300 with a mobile device, you can establish a connection between the ScanSnap and a mobile device by following the instructions in the wizard that appears after installing ScanSnap Connect Application.

For details about how to operate ScanSnap Connect Application, refer to the Basic Operation Guide (Mobile Connection).

Connecting the ScanSnap to a Wireless LAN (iX1300 / iX500 / iX100)

The ScanSnap Wireless Setup Tool is an application to configure the wireless settings required for connecting your ScanSnap via wireless LAN in a wizard format. The ScanSnap Wireless Setup Tool can be used to configure and check the following wireless LAN settings and connection.

- Connecting the ScanSnap to a wireless access point
- Registering the computer that will be connected to the ScanSnap via wireless LAN (iX500/iX100)
- Setting the IP address, name, and password for the ScanSnap
- Checking the connection between the ScanSnap and the computer (iX1300/iX100)
- Checking the connection between the ScanSnap and the mobile device

Follow the procedure below to start the ScanSnap Wireless Setup Tool and configure the wireless settings.

1. Start the ScanSnap Wireless Setup Tool.

- Windows 10
Select [Start] menu → [ScanSnap Manager] → [ScanSnap Wireless Setup Tool].
 - Windows 8.1
Click  on the lower left side of the Start screen, and select [ScanSnap Wireless Setup Tool] under [ScanSnap Manager] on the All apps screen.
 - Windows 7
Select [Start] menu → [All Programs] → [ScanSnap Manager] → [ScanSnap Wireless Setup Tool].
- ⇒ The ScanSnap Wireless Setup Tool will start running.

2. Click the [Wireless Network Setup Wizard] button in the main menu.

- ⇒ The Wireless Network Setup Wizard appears.

3. Follow the instructions in the Wireless Network Setup Wizard to configure the wireless settings.

For iX1300/iX100, configure and check the wireless settings based on the wireless LAN environment in which the ScanSnap is used.

HINT

- For details and operation of ScanSnap Wireless Setup Tool, refer to the ScanSnap Wireless Setup Tool Help.
- The ScanSnap Wireless Setup Tool is also started up when the ScanSnap software is installed.

Connecting the ScanSnap to a computer or mobile device via Wireless LAN (iX1300 / iX100)

- "Connecting the ScanSnap to a Computer in Access Point Connect Mode (iX1300 / iX100)" (page 150)
- "Connecting the ScanSnap to a Mobile Device in Access Point Connect Mode (iX1300 / iX100)" (page 152)
- "Connecting the ScanSnap to a Computer Directly in Direct Connect Mode (iX1300 / iX100)" (page 153)
- "Connecting the ScanSnap to a Mobile Device in Direct Connect Mode (iX1300 / iX100)" (page 155)

Connecting the ScanSnap to a Computer in Access Point Connect Mode (iX1300 / iX100)

You can use the ScanSnap Wireless Setup Tool Wizard to complete the preparation for connecting the ScanSnap to a computer.

For details, refer to "[Connecting the ScanSnap to a Wireless LAN \(iX1300 / iX500 / iX100\)](#)" (page 148).

The following explains how to connect the ScanSnap and a computer when the wireless settings have already been configured by using the ScanSnap Wireless Setup Tool Wizard.

1. Disconnect the USB cable connecting the ScanSnap to the computer.

ATTENTION

If the ScanSnap Manager icon is , exit ScanSnap Connect Application on the mobile device.

⇒ The ScanSnap is automatically connected to the computer via wireless LAN and the

ScanSnap Manager icon changes to .

If the icon does not change, go to step 2.

HINT

- If the [Connect automatically to previous ScanSnap by Wi-Fi] checkbox is selected and the previously connected ScanSnap is available for the connection, the computer is connected to the ScanSnap automatically.
- The computer can be connected to only one ScanSnap.
- Only one computer can be connected to the ScanSnap via wireless LAN.
- For iX100, when you automatically connect a computer and the ScanSnap that had been connected via wireless LAN before, if the password for the ScanSnap to be connected has been changed, a notification informs you of the status.

2. Right-click the ScanSnap Manager icon in the notification area located at the far right of the taskbar and select [Connect by Wi-Fi] from the "Right-Click Menu" (page 100).

⇒ The [ScanSnap Manager - Connect by Wi-Fi] window appears.

3. From the list of the ScanSnap units to be connected, select the ScanSnap that you want to connect, and click the [Connect] button.

ATTENTION

- If you select iX1300 and click the [Connect] button, another computer (which has been connected to the ScanSnap) is disconnected from the ScanSnap.
- For iX100, if the [ScanSnap Manager - Enter Destination Password] window appears, enter the password to connect it.

The default password is the last four digits of the ScanSnap serial number.

The password can be changed with the ScanSnap Wireless Setup Tool. For details, refer to the ScanSnap Wireless Setup Tool Help.

- If the intended ScanSnap for connection does not appear in the list of the ScanSnap units to be connected, refer to the ScanSnap Manager Help.

⇒ The ScanSnap is connected to a computer via wireless LAN and the ScanSnap Manager

icon changes to .

HINT

When the ScanSnap and a computer are connected via wireless LAN, a notification informs you of the communication status.

Connecting the ScanSnap to a Mobile Device in Access Point Connect Mode (iX1300 / iX100)

You can use the ScanSnap Wireless Setup Tool Wizard to complete the preparation for connecting the ScanSnap to a mobile device.

For details, refer to "[Connecting the ScanSnap to a Wireless LAN \(iX1300 / iX500 / iX100\)](#)" (page 148).

The following explains how to connect the ScanSnap and a mobile device when the wireless settings have already been configured by using the ScanSnap Wireless Setup Tool Wizard.

1. Start ScanSnap Connect Application on your mobile device.

- ⇒ The mobile device will automatically be connected to an available ScanSnap on the same network.

HINT

- If more than one available ScanSnap is detected, or if ScanSnap Connect Application is set not to connect a mobile device to a ScanSnap automatically, then tap the ScanSnap that you want by name, in order to connect to the mobile device, under [ScanSnap] on the [Connect to] screen. For details, refer to the Basic Operation Guide (Mobile Connection) for your mobile device.
- A notification appears in the following cases:
 - When the ScanSnap and the mobile device are connected via wireless LAN, and the communication with ScanSnap Manager is disconnected
 - When you log onto the computer which is connected to the ScanSnap with the ScanSnap and the mobile device already connected via wireless LAN

Connecting the ScanSnap to a Computer Directly in Direct Connect Mode (iX1300 / iX100)

You can use the ScanSnap Wireless Setup Tool Wizard to complete the preparation for connecting the ScanSnap to a computer.

For details, refer to "[Connecting the ScanSnap to a Wireless LAN \(iX1300 / iX500 / iX100\)](#)" (page 148).

The following explains how to connect the ScanSnap and a computer when the computer to be connected has already been registered by using the ScanSnap Wireless Setup Tool Wizard.

1. Click  in the notification area located at the far right of the taskbar, and connect the ScanSnap network displayed in the wireless network list.

The ScanSnap network name (SSID) and the security key are printed on the label attached to the bottom of the scanner.

HINT

The network name (SSID) and the security key can be checked or changed with the ScanSnap Wireless Setup Tool.

2. Disconnect the USB cable connecting the ScanSnap to the computer.

ATTENTION

If the ScanSnap Manager icon is , exit ScanSnap Connect Application on the mobile device.

⇒ The ScanSnap is automatically connected to the computer via wireless LAN and the

ScanSnap Manager icon changes to .

If the icon does not change, go to step 3.

HINT

- If the [Connect automatically to previous ScanSnap by Wi-Fi] checkbox is selected and the previously connected ScanSnap is available for the connection, the computer is connected to the ScanSnap automatically.
- The computer can be connected to only one ScanSnap.
- Only one computer can be connected to the ScanSnap via wireless LAN.
- For iX100, when you automatically connect a computer and the ScanSnap that had been connected via wireless LAN before, if the password for the ScanSnap to be connected has been changed, a notification informs you of the status.

3. Right-click the ScanSnap Manager icon  in the notification area located at the far right of the taskbar and select [Connect by Wi-Fi] from the "Right-Click Menu" (page 100).

⇒ The [ScanSnap Manager - Connect by Wi-Fi] window appears.

4. From the list of the ScanSnap units to be connected, select the ScanSnap that you want to connect, and click the [Connect] button.

ATTENTION

- If you select iX1300 and click the [Connect] button, another computer (which has been connected to the ScanSnap) is disconnected from the ScanSnap.
- For iX100, if the [ScanSnap Manager - Enter Destination Password] window appears, enter the password to connect it.
The default password is the last four digits of the ScanSnap serial number.
The password can be changed with the ScanSnap Wireless Setup Tool. For details, refer to the ScanSnap Wireless Setup Tool Help.
- If the intended ScanSnap for connection does not appear in the list of the ScanSnap units to be connected, refer to the ScanSnap Manager Help.

⇒ The ScanSnap is connected to the computer via a wireless access point and the ScanSnap

Manager icon changes to .

HINT

When the ScanSnap and a computer are connected via wireless LAN, a notification informs you of the communication status.

Connecting the ScanSnap to a Mobile Device in Direct Connect Mode (iX1300 / iX100)

When you connect a mobile device to the ScanSnap in Direct Connect mode, you do not need to configure settings in the ScanSnap Wireless Setup Tool.

For details, refer to the Basic Operation Guide (Mobile Connection).

Connecting the ScanSnap to a Computer or Mobile Device via Wireless LAN (iX500)

- "Connecting the ScanSnap and a Computer (iX500)" (page 157)
- "Connecting the ScanSnap and a Mobile Device (iX500)" (page 159)

Connecting the ScanSnap and a Computer (iX500)

You can use the ScanSnap Wireless Setup Tool Wizard to complete the preparation for connecting the ScanSnap to a computer.

For details, refer to "[Connecting the ScanSnap to a Wireless LAN \(iX1300 / iX500 / iX100\)](#)" (page 148).

The following explains how to connect the ScanSnap and a computer when the wireless settings have already been configured by using the ScanSnap Wireless Setup Tool Wizard.

1. Disconnect the USB cable connecting the ScanSnap to the computer.

ATTENTION

If the ScanSnap Manager icon is , exit ScanSnap Connect Application on the mobile device.

⇒ The ScanSnap is automatically connected to the computer via wireless LAN and the

ScanSnap Manager icon changes to .

If the icon does not change, go to step 2.

HINT

- If the [Connect automatically to the last connected ScanSnap by Wi-Fi] checkbox is selected and the last connected ScanSnap is available, the computer is connected to the ScanSnap automatically.
- The computer can be connected to only one ScanSnap.
- Only one computer can be connected to the ScanSnap.
- When you automatically connect a computer and the ScanSnap that had been connected via wireless LAN before, if the password for the ScanSnap to be connected is changed, a notification informs you of the status.

2. Right-click the ScanSnap Manager icon in the notification area located at the far right of the taskbar and select [Connect by Wi-Fi] from the "Right-Click Menu" (page 100).

⇒ The [ScanSnap Manager - Connect by Wi-Fi] window appears.

3. From the list of the ScanSnap units to be connected, select the ScanSnap that you want to connect, and click the [Connect] button.

ATTENTION

- If the [ScanSnap Manager - Enter Destination Password] window appears, enter the password to connect.

The default password is the last four digits of the ScanSnap serial number.

The password can be changed with the ScanSnap Wireless Setup Tool. For details, refer to the ScanSnap Wireless Setup Tool Help.

- If the intended ScanSnap for connection does not appear in the list of the ScanSnap units to be connected, refer to the ScanSnap Manager Help.

⇒ The ScanSnap is connected to a computer via wireless LAN and the ScanSnap Manager

icon changes to .

HINT

When the ScanSnap and a computer are connected via wireless LAN, a notification informs you of the communication status.

Connecting the ScanSnap and a Mobile Device (iX500)

You can use the ScanSnap Wireless Setup Tool Wizard to complete the preparation for connecting the ScanSnap to a mobile device.

For details, refer to "[Connecting the ScanSnap to a Wireless LAN \(iX1300 / iX500 / iX100\)](#)" (page 148).

The following explains how to connect the ScanSnap and a mobile device when the wireless settings have already been configured by using the ScanSnap Wireless Setup Tool Wizard.

1. Start ScanSnap Connect Application on your mobile device.

⇒ The mobile device will automatically be connected to an available ScanSnap on the same network.

HINT

- If more than one available ScanSnap is detected, or if ScanSnap Connect Application is set not to connect a mobile device to a ScanSnap automatically, then tap the ScanSnap that you want by name, in order to connect to the mobile device, under [ScanSnap] on the [Connect to] screen. For details, refer to the Basic Operation Guide (Mobile Connection) for your mobile device.
- A notification appears in the following cases:
 - When the ScanSnap and the mobile device are connected via wireless LAN, and the communication with ScanSnap Manager is disconnected
 - When you log onto the computer which is connected to the ScanSnap with the ScanSnap and the mobile device already connected via wireless LAN

Reconnecting to a Wireless Access Point Using the ScanSnap WPS Button (iX1300 / iX500 / iX100)

If the Wi-Fi indicator lights up or flashes in orange, reconnect the ScanSnap to a WPS compatible wireless access point. The reconnection can be established easily by pressing the WPS button on the ScanSnap.

ATTENTION

Perform the following before you connect using the WPS button.

- If the ScanSnap Wireless Setup Tool is running while the ScanSnap is being connected to the computer with a USB cable, exit the ScanSnap Wireless Setup Tool.
- If scanning is currently being performed from ScanSnap Manager or a mobile device, end the scanning operation.

HINT

Button names and operating procedures may differ depending on the wireless access point. For details, refer to the manual for your wireless access point.

1. Turn on the Wi-Fi switch on the back of the ScanSnap.

iX1300

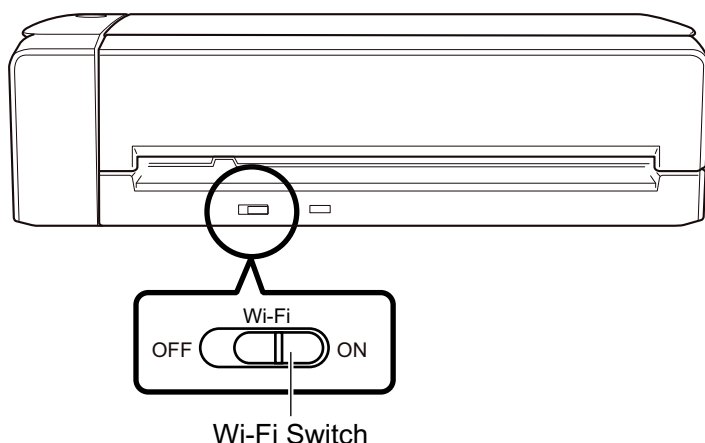

iX500

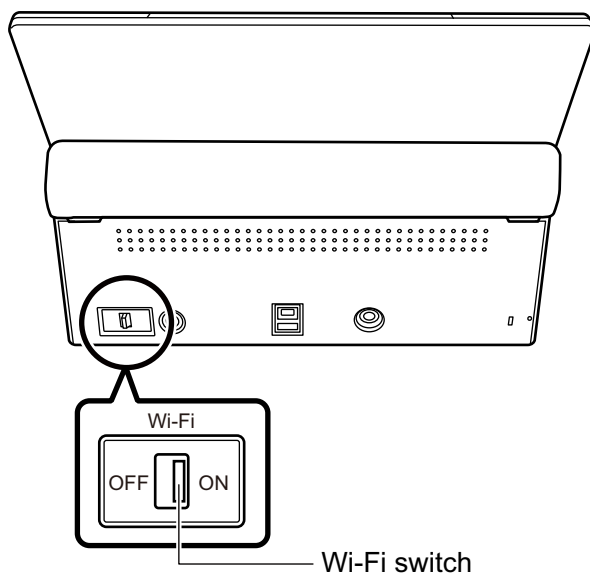

iX100

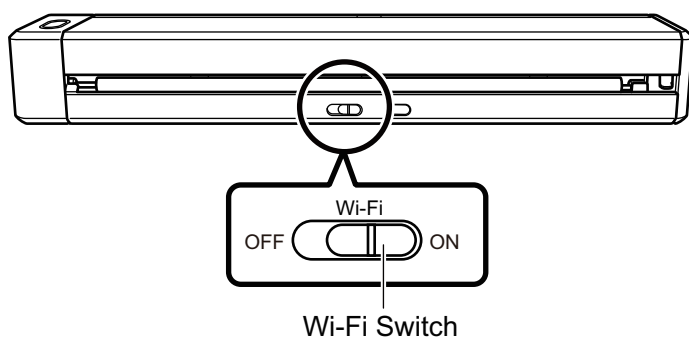

2. Turn on the ScanSnap.

For details, refer to ["Turning the ScanSnap On"](#) (page 105).

⇒ After blinking blue, the Wi-Fi indicator lights up in blue or orange.

3. Press the WPS button of the wireless access point.

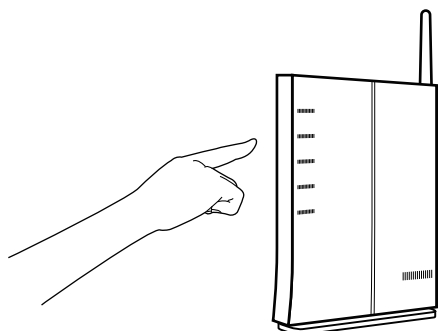

4. Press and hold (3 seconds or longer) the WPS button on the back of the ScanSnap within 2 minutes after pressing the WPS button of the wireless access point.

iX1300

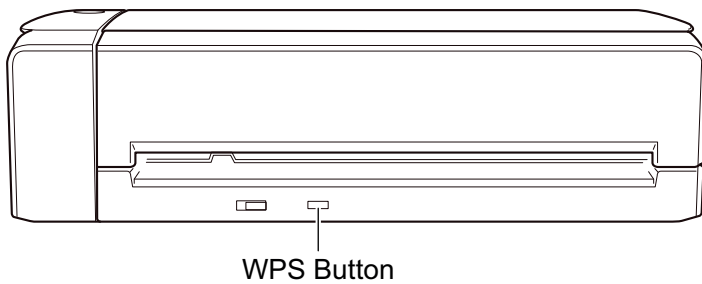

iX500

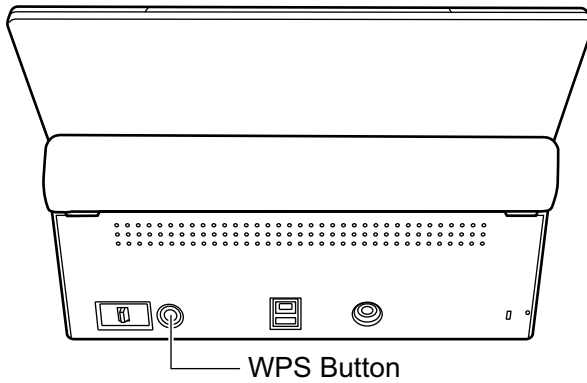

iX100

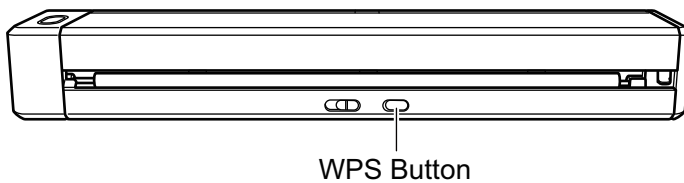

⇒ The ScanSnap is connected to the wireless access point and the Wi-Fi indicator lights up in blue.

If connection cannot be established, the Wi-Fi indicator blinks or lights up in orange.

ATTENTION

If you cannot connect the ScanSnap to a wireless access point, refer to "Troubleshooting" in the ScanSnap Manager Help.

HINT

For details about the Wi-Fi indicator status, refer to the following:

- iX1300
"Parts and Functions of iX1300" (page 81)
- iX500
"Parts and Functions of iX500" (page 84)
- iX100
"Parts and Functions of iX100" (page 86)

Wireless Settings for the ScanSnap (iX1600 / iX1500)

The following explains the procedure to configure the wireless settings for the ScanSnap, such as how to check the wireless LAN which the scanner is connected to or check network information, how to change a wireless access point which you want to connect the scanner to, and how to switch the wireless mode.

- ["Registering a Certificate/ Checking the Wireless LAN Settings \(iX1600 / iX1500\)" \(page 164\)](#)
- ["Changing the Wireless LAN Connection Method \(iX1600 / iX1500\)" \(page 170\)](#)
- ["Access Point Connect Settings \(iX1600 / iX1500\)" \(page 179\)](#)

Registering a Certificate/ Checking the Wireless LAN Settings (iX1600 / iX1500)

- ["Registering a Client Certificate or CA Certificate \(iX1600 / iX1500\)" \(page 165\)](#)
- ["Checking the Wireless LAN Settings \(iX1600 / iX1500\)" \(page 166\)](#)
- ["Checking the IP address of the ScanSnap \(iX1600 / iX1500\)" \(page 167\)](#)
- ["Checking the DNS Server of the ScanSnap \(iX1600 / iX1500\)" \(page 168\)](#)
- ["Checking the MAC address of the ScanSnap \(iX1600 / iX1500\)" \(page 169\)](#)

Registering a Client Certificate or CA Certificate (iX1600 / iX1500)

To connect the ScanSnap to a wireless access point, use a client certificate or CA certificate that has been registered on the ScanSnap to authenticate a connection to the wireless access point.

One certificate for each certificate type (client certificates and CA certificates) can be registered on the ScanSnap.

To register a client certificate or CA certificate, use the ScanSnap Wireless Setup Tool.

Follow the procedure below to start the ScanSnap Wireless Setup Tool.

- Windows 10
Select [Start] menu → [ScanSnap Manager] → [ScanSnap Wireless Setup Tool].
- Windows 8.1
Click the down arrow on the lower left side of the Start screen, and select [ScanSnap Wireless Setup Tool] under [ScanSnap Manager] on the All apps screen.
- Windows 7
Select [Start] menu → [All Programs] → [ScanSnap Manager] → [ScanSnap Wireless Setup Tool].

For details about registering a client certificate or CA certificate, refer to the ScanSnap Wireless Setup Tool Help.

Checking the Wireless LAN Settings (iX1600 / iX1500)

Check the connection status of the wireless LAN and its access point.

1. Press  in the **home screen** on the touch panel of the ScanSnap to display the **[Settings]** screen.

2. Press  to display the **[Wi-Fi settings]** screen.

3. Press **[Wi-Fi information]**.

⇒ Current wireless LAN information is displayed.

Checking the IP address of the ScanSnap (iX1600 / iX1500)

Check the IP address of the ScanSnap on the touch panel.

1. Press  in the **home screen** on the touch panel of the ScanSnap to display the **[Settings]** screen.



2. Press  to display the **[Wi-Fi settings]** screen.
3. Check that the name of a network which is currently connected, is displayed in **[Access point connection]**
If **[Access point connection]** is disabled or if a network name is not displayed, refer to "[Connecting the ScanSnap to a Computer in Access Point Connect Mode \(iX1600 / iX1500\)](#)" (page 140) and connect the ScanSnap to a wireless access point.
4. Press **[Wi-Fi information]** to display the **[ScanSnap information]** screen.
5. Check the **[IP address]** in the **[Network]** tab.

Checking the DNS Server of the ScanSnap (iX1600 / iX1500)

Check the DNS server of the ScanSnap on the touch panel.

1. Press  in the **home screen** on the touch panel of the ScanSnap to display the **[Settings]** screen.



2. Press  to display the **[Wi-Fi settings]** screen.
3. Check that the name of a network which is currently connected, is displayed in **[Access point connection]**
If **[Access point connection]** is disabled or if a network name is not displayed, refer to "[Connecting the ScanSnap to a Computer in Access Point Connect Mode \(iX1600 / iX1500\)](#)" (page 140) and connect the ScanSnap to a wireless access point.
4. Press **[Wi-Fi information]** to display the **[ScanSnap information]** screen.
5. Check the **[DNS Server]** in the **[Network]** tab.

Checking the MAC address of the ScanSnap (iX1600 / iX1500)

Check the MAC address of the ScanSnap on the touch panel.

1. Press  in the **home screen** on the touch panel of the ScanSnap to display the **[Settings]** screen.



2. Press  to display the **[Wi-Fi settings]** screen.
3. Check that **[Wi-Fi connect mode]** is set to **[Access point connection]** or **[Direct connection]**.
If **[Wi-Fi connect mode]** is set to **[Wi-Fi off]**, press **[Wi-Fi connect mode]** and set it to **[Access point connection]** or **[Direct connection]**
4. Press **[Wi-Fi information]** to display the **[ScanSnap information]** screen.
5. Check the **[MAC address]** in the **[Network]** tab.

Changing the Wireless LAN Connection Method (iX1600 / iX1500)

- ["Reconnecting the ScanSnap to Another Wireless Access Point \(iX1600 / iX1500\)" \(page 171\)](#)
- ["Changing the Connection Method from Access Point Connection to Direct Connection \(iX1600 / iX1500\)" \(page 173\)](#)
- ["Changing the Connection Method from Direct Connection to Access Point Connection \(iX1600 / iX1500\)" \(page 174\)](#)
- ["Changing the Frequency for Connecting the ScanSnap \(iX1600 / iX1500\)" \(page 176\)](#)
- ["Turning Off the Wireless LAN Connection \(iX1600 / iX1500\)" \(page 177\)](#)
- ["Resetting the Wireless LAN Settings \(iX1600 / iX1500\)" \(page 178\)](#)

Reconnecting the ScanSnap to Another Wireless Access Point (iX1600 / iX1500)

Change the wireless access point, to which the ScanSnap is connected, to another one.

HINT

Using the ScanSnap Wireless Setup Tool enables you to obtain the Wi-Fi settings configured on your computer and easily connect the ScanSnap to the same wireless access point as your computer.

For details, refer to "Connecting the ScanSnap to a Wireless Access Point by Using the ScanSnap Wireless Setup Tool (iX1600 / iX1500)" (page 135).

1. On the touch panel of the ScanSnap, display the [Enter connection information] screen.

1. Press  in the [home screen](#) on the touch panel of the ScanSnap to display the [Settings] screen.



2. Press  to display the [Wi-Fi settings] screen.
3. Press [Access point connection] to display the [Access point connection] screen.
4. Press [Access point connect settings] to display the [Connection information configuration method] screen.
5. Select [Select an access point].
6. Press the [Next] button to display the [Select network] screen.
7. From the list of wireless access points that appears, select a wireless access point that you want to connect to.
8. Press the [Next] button to display the [Enter connection information] screen.

2. Enter the information of the wireless access point to be used and press the [Next] button.

The items which are displayed in the screen differ depending on the security protocol of the wireless access point.

- To perform the authentication with a security key
Press the input field for [Security key] and enter the user name, and then press [OK].
- To perform the authentication with a client certificate
Press [Client certificate] and select the certificate to be used.

HINT

To check the details about the certificate, press the [Certificate] button.

- To perform the authentication with a user ID and a password
Press the input field and enter a value for [User ID] and [Password] respectively, and then press [OK].
- To perform the authentication with an external ID
Press the input field for [External ID], enter the external ID, and press [OK].

3. Press the [Complete] button in the [Check Connection Results] screen.

4. Press  to return to the home screen.

Changing the Connection Method from Access Point Connection to Direct Connection (iX1600 / iX1500)



When a computer or mobile device is connected to the ScanSnap by using an access point, change the connection method for the computer or mobile device to a direct connection and connect the computer or the mobile device to the ScanSnap directly rather than via a wireless access point.

This section explains the procedure to change the connection method for the computer and the ScanSnap from an access point connection to a direct connection.

1. Set [Wi-Fi connect mode] to [Direct connection] for the ScanSnap.

1. Press  in the [home screen](#) on the touch panel of the ScanSnap to display the [Settings] screen.



2. Press  to display the [Wi-Fi settings] screen.
3. Press [Wi-Fi connect mode] to display the [Wi-Fi connect mode] screen.
4. Select [Direct connection].
5. Press  twice to display the [Settings] screen.



2. Press  to display the [Connecting Devices] screen.

3. Open the window for setting the Wi-Fi function on the computer.

HINT

For details, refer to the manual of the computer.

4. Enter the network name (SSID) and security key that are displayed in the [Connecting Devices] screen in the window for setting the Wi-Fi function.

5. Press  to return to the home screen.

Changing the Connection Method from Direct Connection to Access Point Connection (iX1600 / iX1500)



When a computer or mobile device is connected to the ScanSnap directly, change the connection method for the computer or mobile device to an access point connection and connect the computer or the mobile device to the ScanSnap via a wireless access point.

This section explains the procedure to change the connection method for the computer and the ScanSnap from a direct connection to an access point connection.

1. Set [Wi-Fi connect mode] to [Access point connection] for the ScanSnap.

1. Press  in the [home screen](#) on the touch panel of the ScanSnap to display the [Settings] screen.



2. Press  to display the [Wi-Fi settings] screen.
3. Press [Wi-Fi connect mode] to display the [Wi-Fi connect mode] screen.
4. Select [Access point connection].
5. Press  to return to the [Wi-Fi settings] screen.

2. Connect the ScanSnap to a wireless access point.

1. Press [Access point connection] to display the [Access point connection] screen.
2. Press [Access point connect settings] to display the [Connection information configuration method] screen.
3. Select [Select an access point].
4. Press the [Next] button to display the [Select network] screen.
5. From the list of wireless access points that appears, select a wireless access point that you want to connect to.
6. Press the [Next] button to display the [Enter connection information] screen.
7. Enter the information of the wireless access point to be used and press the [Next] button.
The items which are displayed in the screen differ depending on the security protocol of the wireless access point.
 - To perform the authentication with a security key
Press the input field for [Security key] and enter the user name, and then press [OK].
 - To perform the authentication with a client certificate
Press [Client certificate] and select the certificate to be used.

HINT

To check the details about the certificate, press the [Certificate] button.

- To perform the authentication with a user ID and a password
Press the input field and enter a value for [User ID] and [Password] respectively, and then press [OK].
- To perform the authentication with an external ID
Press the input field for [External ID], enter the external ID, and press [OK].

8. Press the [Complete] button in the [Check Connection Results] screen.



9. Press  to display the home screen.

3. Click the [Network] icon in the notification area, at the far right of the taskbar on the computer.

4. In the window that appears, select the wireless access point which the ScanSnap is connected to.

5. When the window for entering a password appears, enter a password and click [Connect].

⇒ The connection method has been changed from a direct connection to an access point connection. The computer and the ScanSnap are connected via Wi-Fi using the wireless access point.

Changing the Frequency for Connecting the ScanSnap (iX1600 / iX1500)

Change the setting of the frequency for connecting the ScanSnap which is used when the scanner is connected to a wireless access point.

HINT

In some regions, a 5 GHz wireless LAN cannot be used.

If you are using the ScanSnap in the region where a 5 GHz wireless LAN cannot be used, you cannot change the frequency for the connection.

1. Press  in the **home screen** on the touch panel of the ScanSnap to display the **[Settings]** screen.



2. Press  to display the **[Wi-Fi settings]** screen.
3. Press **[Access point connection]** to display the **[Access point connection]** screen.
4. Press **[Frequency for the Connection]** to change the frequency for the connection.



5. Press  to return to the home screen.

Turning Off the Wireless LAN Connection (iX1600 / iX1500)

Disable the wireless LAN function on the ScanSnap to turn off the wireless LAN connection temporarily.

1. Press  in the **home screen** on the touch panel of the ScanSnap to display the **[Settings]** screen.



2. Press  to display the **[Wi-Fi settings]** screen.
3. Press **[Wi-Fi connect mode]** to display the **[Wi-Fi connect mode]** screen.
4. Select **[Wi-Fi off]**.



5. Press  to return to the home screen.

Resetting the Wireless LAN Settings (iX1600 / iX1500)

Reset the wireless LAN settings that are configured for the ScanSnap.

1. Press  in the **home screen** on the touch panel of the ScanSnap to display the **[Settings]** screen.



2. Press  to display the **[Wi-Fi settings]** screen.
3. Press **[Initialize Wi-Fi settings]** to display the **[Initialize Wi-Fi settings]** screen.
4. Press the **[Initialize]** button.
5. Press  to return to the home screen.

Access Point Connect Settings (iX1600 / iX1500)

- ["Authenticating a Wireless Access Point with a Client Certificate \(iX1600 / iX1500\)" \(page 180\)](#)
- ["Authenticating a Wireless Access Point with a User ID and Password \(iX1600 / iX1500\)" \(page 181\)](#)
- ["Authenticating a Wireless Access Point with an External ID \(iX1600 / iX1500\)" \(page 182\)](#)
- ["Setting an IP Address for the ScanSnap \(iX1600 / iX1500\)" \(page 183\)](#)
- ["Using a DNS Server for the Internet Connection \(iX1600 / iX1500\)" \(page 184\)](#)
- ["Using a Proxy Server for the Internet Connection \(iX1600 / iX1500\)" \(page 185\)](#)

Authenticating a Wireless Access Point with a Client Certificate (iX1600 / iX1500)

To connect the ScanSnap to a wireless access point, use a client certificate or CA certificate that has been registered on the ScanSnap to authenticate a connection to the wireless access point.

1. On the touch panel of the ScanSnap, display the [Enter connection information] screen.

1. Press  in the [home screen](#) on the touch panel of the ScanSnap to display the [Settings] screen.



2. Press  to display the [Wi-Fi settings] screen.
3. Press [Access point connection] to display the [Access point connection] screen.
4. Press [Access point connect settings] to display the [Connection information configuration method] screen.
5. Select [Select an access point].
6. Press the [Next] button to display the [Select network] screen.
7. From the list of wireless access points that appears, select a wireless access point that you want to connect to.
8. Press the [Next] button to display the [Enter connection information] screen.

2. Press [Client certificate] and select the certificate to be used.

HINT

To check the details about the certificate, press the [Certificate] button.

3. Press the [Next] button to display the [Select network] screen.
4. Press the [Complete] button in the [Check Connection Results] screen.

5. Press  to return to the home screen.

Authenticating a Wireless Access Point with a User ID and Password (iX1600 / iX1500)

To connect the ScanSnap to a wireless access point, authenticate a connection to the wireless access point by entering a user ID and password.

1. On the touch panel of the ScanSnap, display the [Enter connection information] screen.

1. Press  in the [home screen](#) on the touch panel of the ScanSnap to display the [Settings] screen.



2. Press  to display the [Wi-Fi settings] screen.
3. Press [Access point connection] to display the [Access point connection] screen.
4. Press [Access point connect settings] to display the [Connection information configuration method] screen.
5. Select [Select an access point].
6. Press the [Next] button to display the [Select network] screen.
7. From the list of wireless access points that appears, select a wireless access point that you want to connect to.
8. Press the [Next] button to display the [Enter connection information] screen.

2. Press the input field for [User ID], enter the user ID, and press [OK].

3. Press the input field for [Password], enter the password, and press [OK].

4. Press the [Next] button.

5. Press the [Complete] button in the [Check Connection Results] screen.

6. Press  to return to the home screen.

Authenticating a Wireless Access Point with an External ID (iX1600 / iX1500)

To connect the ScanSnap to a wireless access point, authenticate a connection to the wireless access point by entering an external ID.

1. On the touch panel of the ScanSnap, display the [Enter connection information] screen.

1. Press  in the [home screen](#) on the touch panel of the ScanSnap to display the [Settings] screen.



2. Press  to display the [Wi-Fi settings] screen.
3. Press [Access point connection] to display the [Access point connection] screen.
4. Press [Access point connect settings] to display the [Connection information configuration method] screen.
5. Select [Select an access point].
6. Press the [Next] button to display the [Select network] screen.
7. From the list of wireless access points that appears, select a wireless access point that you want to connect to.
8. Press the [Next] button to display the [Enter connection information] screen.

2. Press the input field for [External ID], enter the external ID, and press [OK].

3. Press the [Next] button.

4. Press the [Complete] button in the [Check Connection Results] screen.

5. Press  to return to the home screen.

Setting an IP Address for the ScanSnap (iX1600 / iX1500)

To identify your ScanSnap on a network, set an IP address for the ScanSnap.

When setting an IP address, [Access point connection] needs to be selected for [Wi-Fi connect mode] temporarily.

1. Press  in the **home screen** on the touch panel of the ScanSnap to display the [Settings] screen.

2. Press  to display the [Wi-Fi settings] screen.

3. Press [Access point connection] to display the [Access point connection] screen.

4. Press [IP address] to display the [IP address] screen.

5. Press the setting field for [Configuration method] to display a list.

6. **Set an IP Address.**

When obtaining an IP address from the DHCP server and automatically assigning it to the ScanSnap, select [Obtain automatically (DHCP)].

When setting an IP addresses manually, select [Configure IP address manually] and configure the following settings.

1. Press the input field for [IP address], enter the IP address, and then press [OK].
2. Press the input field for [Subnet Mask], enter the subnet mask, and then press [OK].
3. Press the input field for [Default Gateway], enter the default gateway, and then press [OK].

7. Press  to return to the home screen.

ATTENTION

If there is a device with the same IP address as the ScanSnap on the network,  is displayed on



in the [Settings] screen. Change the IP address which has been set for the ScanSnap to avoid an IP address conflict on the network.

Using a DNS Server for the Internet Connection (iX1600 / iX1500)

When an IP address is set for the ScanSnap, the setting for using a DNS server can be configured on the ScanSnap.

1. Press  in the **home screen** on the touch panel of the ScanSnap to display the **[Settings]** screen.



2. Press  to display the **[Wi-Fi settings]** screen.
3. Press **[Access point connection]** to display the **[Access point connection]** screen.
4. Press **[DNS Server]** to display the **[DNS Server]** screen.
5. Turn on **[Use of DNS Server]**.
6. Press the input field for **[Primary DNS]**, enter the IP address of the primary DNS server, and then press **[OK]**.
7. Press the input field for **[Secondary DNS]**, enter the IP address of the secondary DNS server, and then press **[OK]**.

8. Press  to return to the home screen.



Using a Proxy Server for the Internet Connection (iX1600 / iX1500)

Configure the Internet connection via a proxy server.

The setting for using a proxy server can be configured when [Access point connection] is selected for [Wi-Fi connect mode].

1. Press  in the **home screen** on the touch panel of the ScanSnap to display the [Settings] screen.



2. Press  to display the [Wi-Fi settings] screen.
3. Press [Access point connection] to display the [Access point connection] screen.
4. Press [Proxy Server] to display the [Proxy Server] screen.
5. Turn on [Use of Proxy Server].
6. Press the input field for [Host Name/IP address], enter the host name or the IP address, and press [OK].
7. Press the input field for [Port Number], enter the port number, and press [OK].
8. When the proxy server requires authentication, turn on [Authentication] and perform the following operations.
 1. Press the input field for [User name], enter the user name and press [OK].
 2. Press the input field for [Password], enter the password, and press [OK].
9. Press  to return to the home screen.

Changing a Connected Computer to a Computer that You Want to Connect to the ScanSnap (iX1600 / iX1500)

If a user name is displayed in the upper left of the home screen on the touch panel, selecting a user name can change the computer that is connected to the ScanSnap.

ATTENTION

- You can change the computer that is connected to the ScanSnap from the touch panel in any of the following cases:
 - The options below are selected in the [Settings] screen on the touch panel
 - [Selected user] is selected for [Display of profiles] in the [Scanner settings] screen
 - [Access point connection] or [Direct connection] is selected for [Wi-Fi connect mode] in the [Wi-Fi settings] screen
 - Two or more history records of computers that have been connected to the ScanSnap before exist
- The default setting for [Display of profiles] is [Selected user].
If the setting is changed to [All users] or [Connected user], establishing a connection with the ScanSnap may fail or another problem may occur.
Do not change the setting for [Display of profiles].

This section explains how to set a user name, how to change a computer that is connected to the ScanSnap, and how to troubleshoot problems that prevent you from connecting to the ScanSnap.

- ["Setting a User Name Displayed on the Touch Panel \(iX1600 / iX1500\)" \(page 187\)](#)
- ["Changing a Connected Computer to a Computer That You Want to Connect to the ScanSnap from the Touch Panel \(iX1600 / iX1500\)" \(page 189\)](#)
- ["Troubleshooting When You Cannot Connect to the ScanSnap \(iX1600 / iX1500\)" \(page 192\)](#)

Setting a User Name Displayed on the Touch Panel (iX1600 / iX1500)

User names displayed on the touch panel can be set for each computer that is connected to the ScanSnap.

HINT

When the ScanSnap is used by multiple user accounts on the same computer, a user name can be set for each user account.

If you change a user account on the computer, you also need to change the user for the ScanSnap.

1. Right-click the ScanSnap Manager icon  in the notification area and select [Preferences] from the "Right-Click Menu" (page 100).
⇒ The [ScanSnap Manager - Preferences] window appears.
2. Select [Touch screen] from the list, enter a user name (which you want to display on the touch panel) in [User setting].

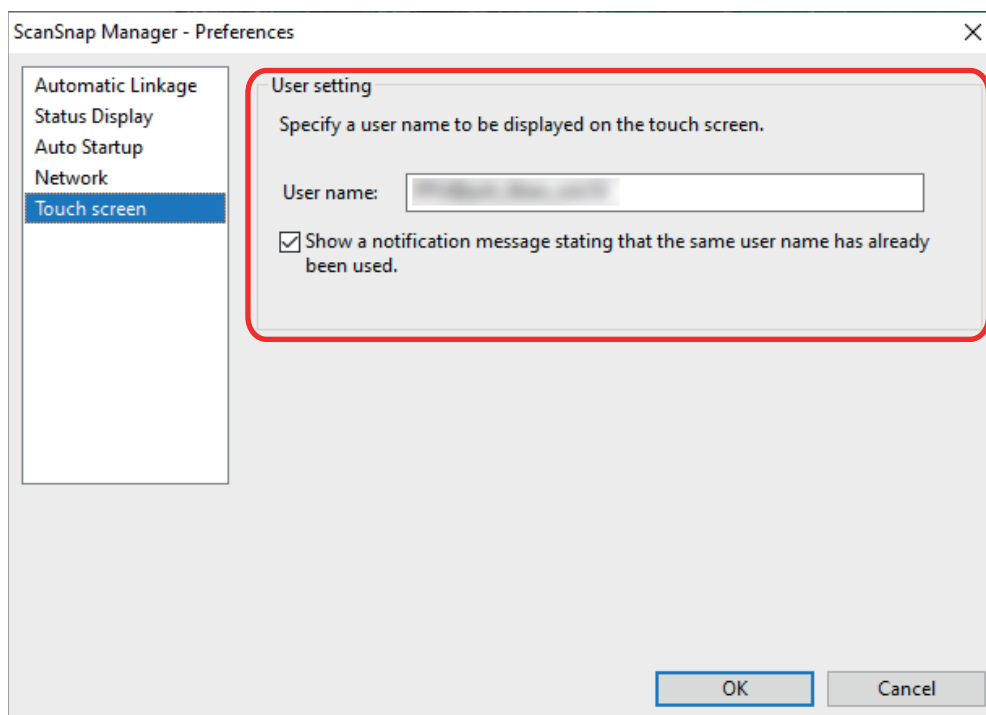

Example: iX1600

- [User name:]

Enter the user name for your computer (which is displayed on the touch panel) within 30 characters.

HINT

A default user name is set when the ScanSnap is connected with a computer for the first time, in the format "login user name@computer name".

- [Show a notification message stating that the same user name has already been used.] checkbox

Select this checkbox to display a message if a user name that is set in [User name] and a user name of a computer that has been connected with the ScanSnap you are using before are the same.

This checkbox is selected by default.

- 3. Click the [OK] button to close the [ScanSnap Manager - Preferences] window.**

Changing a Connected Computer to a Computer That You Want to Connect to the ScanSnap from the Touch Panel (iX1600 / iX1500)

Change a connected computer to a computer that you want to connect to the ScanSnap in the following procedure:

1. Press  in the **home screen** on the touch panel of the ScanSnap.
⇒ The [Selecting a User] screen appears.
2. **Select a user name for a computer that you want to connect the ScanSnap to.**

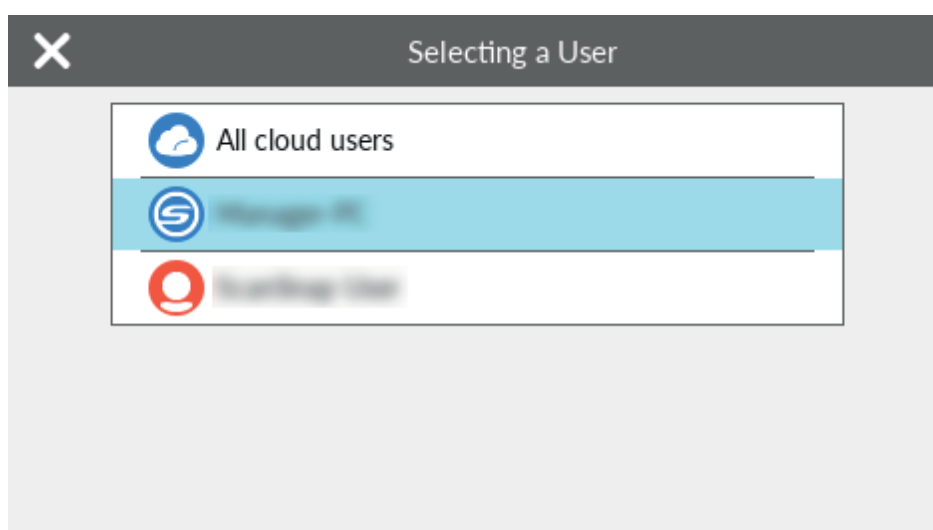

HINT

- If you do not want to change computers, press  to close the [Selecting a User] screen.
- To use ScanSnap Cloud to save scanned images to a cloud service, select [All cloud users].
- The [Selecting a User] screen displays up to 20 user names of the most recent computers that have been connected to the ScanSnap. If a new computer connects to the ScanSnap when 20 user names are displayed, the user name for the least recent user to connect to the ScanSnap is removed.

To connect the ScanSnap to a computer with a user name that is not listed in the [Selecting a User] screen, follow the procedure below.

- When connecting the ScanSnap to a computer via wireless LAN

1. Right-click the ScanSnap Manager icon  in the notification area located at the far right of the taskbar and select [Connect by Wi-Fi] from the "Right-Click Menu" ([page 100](#)).
⇒ The [ScanSnap Manager - Connect by Wi-Fi] window appears.
2. From the list of the ScanSnap units to be connected, select the ScanSnap that you want to connect, and click the [Connect] button.

If the intended ScanSnap for connection does not appear in the list of the ScanSnap units to be connected, refer to the ScanSnap Manager Help.

⇒ The ScanSnap is connected to a computer via wireless LAN and the ScanSnap

Manager icon changes to .

When the ScanSnap and a computer are connected via wireless LAN, a notification informs you of the communication status.

- When connecting the ScanSnap to a computer via the USB cable
 - Unplug the USB cable, then plug it back in.
Make sure to leave at least 5 seconds between unplugging and plugging the cable.
 - Restart ScanSnap Manager.
 - Turn off the ScanSnap and then turn it on again.
Make sure to leave at least 5 seconds between turning off and on the ScanSnap.
- The following screen appears on the touch panel, until a connection is established with a computer that has a user name selected in the [Selecting a User] screen.

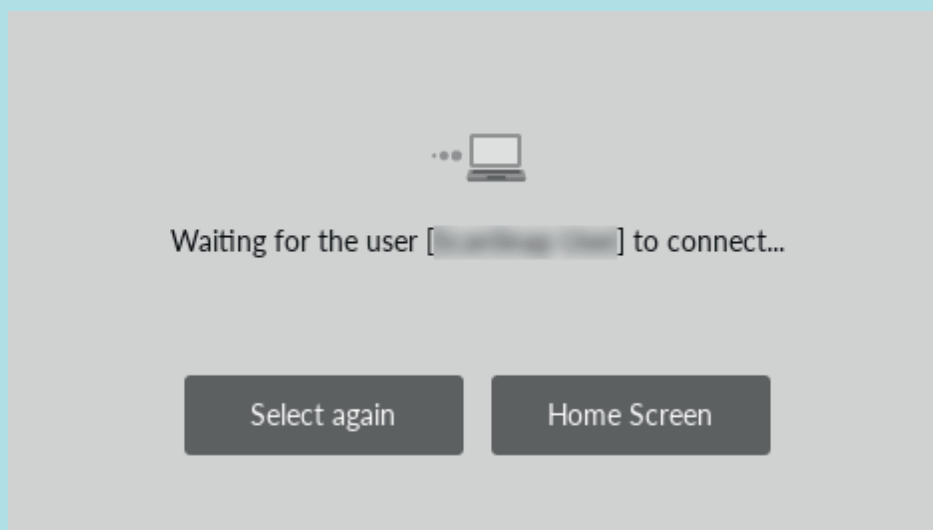



⇒ The computer that has a user name selected in the [Selecting a User] screen is connected to the ScanSnap and the ScanSnap is ready for use.

In addition, the user name displayed in the upper left of the home screen on the touch panel is changed to the user name that was selected in the [Selecting a User] screen.

⇒ After the change, the connection between the ScanSnap and the computer with the previously connected user name is disconnected.

On the disconnected computer, the ScanSnap Manager icon in the notification area

changes from  to  with a message displayed, indicating that the connection with the ScanSnap is disconnected.

HINT

- When the ScanSnap and a computer are connected, a notification informs you of the communication status.
- When the ScanSnap and a computer are disconnected, a notification informs you of the communication status.
- To disable a notification that appears when the connection between the ScanSnap and the computer is disconnected, change the setting in the following procedure:

1. Right-click the ScanSnap Manager icon  in the notification area and select [Preferences] from the "Right-Click Menu" (page 100).

⇒ The [ScanSnap Manager - Preferences] window appears.

2. Clear the [Notify me if a user change has occurred] checkbox in the [Status Display] list.

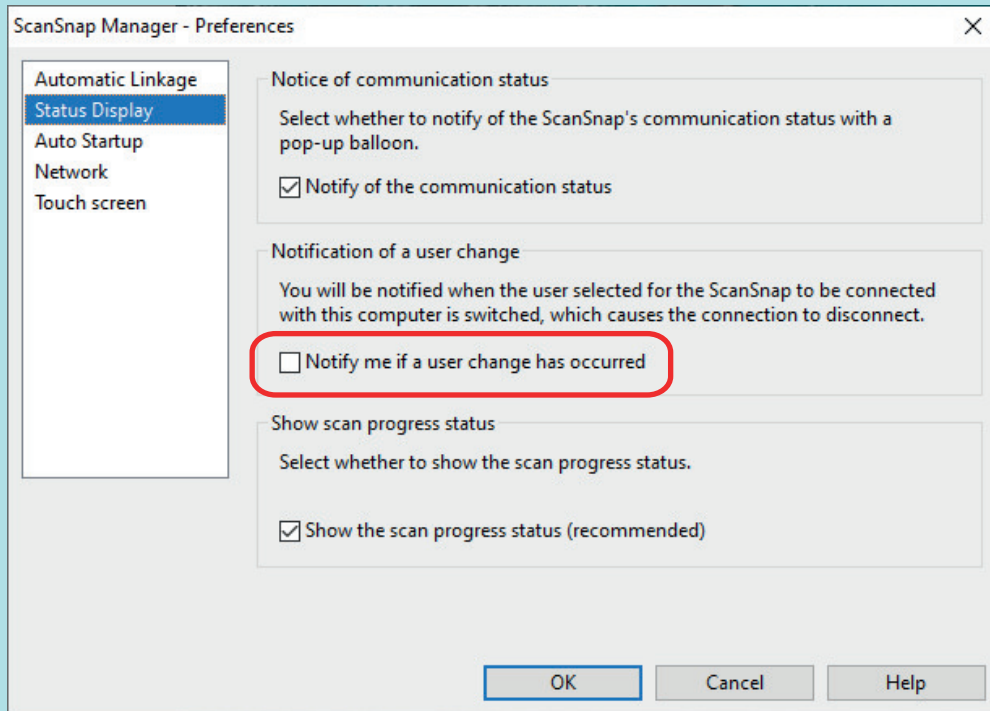

Example: iX1600

3. Click the [OK] button to close the [ScanSnap Manager - Preferences] window.

Troubleshooting When You Cannot Connect to the ScanSnap (iX1600 / iX1500)

This section explains how to troubleshoot when you cannot connect to the ScanSnap.

- ["Checking Whether Another Computer Is Connected to the ScanSnap \(iX1600 / iX1500\)" \(page 193\)](#)
- ["Checking Whether a Setting for the ScanSnap Has Been Changed or Not \(iX1600 / iX1500\)" \(page 194\)](#)

Checking Whether Another Computer Is Connected to the ScanSnap (iX1600 / iX1500)

Another computer may be connected to the ScanSnap in the following cases:

- The ScanSnap Manager icon in the notification area is 
- The user name displayed in the upper left of the home screen on the touch panel is another user

To connect to the ScanSnap, select the user name of the computer that is connected to the ScanSnap in the [Selecting a User] screen on the touch panel.

For details, refer to "[Changing a Connected Computer to a Computer That You Want to Connect to the ScanSnap from the Touch Panel \(iX1600 / iX1500\)](#)" (page 189).

When the ScanSnap and the computer are connected via a USB cable, you can connect to the ScanSnap in either of the following procedures.

- Unplug the USB cable, then plug it back in.
Make sure to leave at least 5 seconds between unplugging and plugging the cable.
- Restart ScanSnap Manager.
- Turn off the ScanSnap and then turn it on again.
Make sure to leave at least 5 seconds between turning off and on the ScanSnap.

Checking Whether a Setting for the ScanSnap Has Been Changed or Not (iX1600 / iX1500)

If the setting for [Display of profiles] on the ScanSnap is changed to [All users] or [Connected user], establishing a connection with the ScanSnap may fail or another problem may occur.

Reset the setting for [Display of profiles] on the ScanSnap to [Selected user] and connect the ScanSnap to the computer again.

1. Check the setting for [Display of profiles] on the ScanSnap and change it if needed.

1. Press  in the [home screen](#) on the touch panel of the ScanSnap to display the [Settings] screen.



2. Press  to display the [Scanner settings] screen.
3. Press [Display of profiles] to display the [Display of profiles] screen.
4. If [All users] or [Connected user] is selected, change it to [Selected user].

HINT

- If [All users] is set for [Display of profiles] and the ScanSnap and the computer are connected via the USB cable, unplug the USB cable, then plug it back in. Once the USB cable is plugged back in, the setting for [Display of profiles] is changed to [Selected user], and the connection between the ScanSnap and the computer is established. Make sure to leave at least 5 seconds between unplugging and plugging the cable.
- When you also use ScanSnap Home to operate the ScanSnap, ScanSnap Home shows a message indicating that the setting for [Display of profiles] has been changed to [Selected user].

5. Press  to return to the home screen.

2. When connecting the ScanSnap to a computer via wireless LAN, establish a connection in the following procedure.

1. Right-click the ScanSnap Manager icon  in the notification area located at the far right of the taskbar and select [Connect by Wi-Fi] from the "Right-Click Menu" ([page 100](#)).
⇒ The [ScanSnap Manager - Connect by Wi-Fi] window appears.
2. From the list of the ScanSnap units to be connected, select the ScanSnap that you want to connect, and click the [Connect] button.

ATTENTION

If the intended ScanSnap for connection does not appear in the list of the ScanSnap units to be connected, refer to the ScanSnap Manager Help.

⇒ The ScanSnap is connected to a computer via wireless LAN and the ScanSnap

Manager icon changes to .

HINT

When the ScanSnap and a computer are connected via wireless LAN, a notification informs you of the communication status.

Scanning Documents

- ["Scanning Documents with iX1600 / iX1500 / iX1400" \(page 197\)](#)
- ["Scanning Documents with iX1300" \(page 228\)](#)
- ["Scanning Documents with iX500" \(page 286\)](#)
- ["Scanning Documents with iX100" \(page 315\)](#)
- ["Scanning Documents with SV600" \(page 345\)](#)
- ["Scanning Documents with S1300i" \(page 373\)](#)
- ["Scanning Documents with S1100i" \(page 390\)](#)

Scanning Documents with iX1600 / iX1500 / iX1400

- "Documents to Scan (iX1600 / iX1500 / iX1400)" (page 198)
- "Scanning Documents (iX1600 / iX1500 / iX1400)" (page 202)
- "Scanning Long Pages (iX1600 / iX1500 / iX1400)" (page 207)
- "Scanning Documents of Different Widths or Lengths in One Batch (iX1600 / iX1500 / iX1400)" (page 211)
- "Scanning Small Size Documents such as Receipts in One Go (iX1600 / iX1500 / iX1400)" (page 216)
- "Scanning Documents Larger Than A4 or Letter Size (iX1600 / iX1500 / iX1400)" (page 220)
- "Scanning Documents Such as Photographs and Clippings (iX1600 / iX1500 / iX1400)" (page 224)

Documents to Scan (iX1600 / iX1500 / iX1400)

This section explains about the conditions for documents that can be loaded directly into the ScanSnap and the conditions for documents that can be scanned using the Carrier Sheet.

Documents That Can Be Loaded Directly into the ScanSnap

Conditions for documents that can be loaded directly into the ScanSnap are as follows:

Document type	Office paper, postcards, business cards Plastic cards conforming to the ISO7810 ID-1 type (54 × 86 mm)
Paper weight	40 to 209 g/m ² (10.7 to 55.7 lb) A8 size (52 × 72 mm) or less 128 to 209 g/m ² (33.9 to 55.7 lb) Plastic cards 0.76 mm (0.03 in.) or less (embossed cards can be used)
Paper size	Width 50.8 to 216 mm (2 to 8.5 in.) Length 50.8 to 360 mm (2 to 14.17 in.) For long page (*1), up to 863 mm (34 in.)

*1: For iX1600/iX1500, scanning starts when you hold down the [Scan] button in the home screen on the touch panel for 3 seconds or longer until the button changes color.

For iX1400, scanning starts when you hold down the [Scan] button on the ScanSnap for 3 seconds or longer until the button flashes in blue.

ATTENTION

- The following types of documents must not be scanned:
 - Documents attached with the metals such as paper clips or staples that can damage the inside of the ScanSnap
Remove the metals for scanning.
 - Documents on which the ink is still wet
Wait until the ink dries completely to scan these documents.
 - Documents larger than 216 × 863 (mm)/8.5 × 34 (in.) (width × length)
 - Documents other than paper such as fabric, metal foil and OHP film
- When you scan picture postcards, be aware that the picture side may get damaged. It is the responsibility of the customer to scan picture postcards.
- When you scan plastic cards, in [Multifeed Detection] of the [Paper] tab of the "ScanSnap Setup Window" (page 102), select [None] or [Check Length].
- Be careful of the following when you scan plastic cards:
 - Cards that are bent may not be fed properly.
 - If the surface of the card is dirty with grease marks such as fingerprints, perform scanning after wiping the dirt off.

- When you scan plastic cards with strong luster, some parts of the image may appear lighter or darker than the original.

Example: gold colored credit card

- When you scan embossed cards, put the embossed side down, and load the card in landscape orientation.
- If the embossed characters are not coated in gold or silver and the background color of the card and the color of the embossed characters are similar, it may be difficult for the ScanSnap to recognize embossed characters.

In which case, performing the following may result in an improvement.

1. Click the [Option] button in the [Scanning] tab of the "ScanSnap Setup Window" (page 102).
⇒ The [Scanning mode option] window appears.
2. Select the [Increase text contrast] checkbox.

Documents That Can Be Scanned Using the Carrier Sheet

The optional Carrier Sheet is a sheet designed to transport documents through the ScanSnap.

You can scan documents that are larger than A4/Letter size, photographs, and clippings.

Conditions for documents that can be scanned using the Carrier Sheet are as follows:



- Do not use a damaged Carrier Sheet. Otherwise, it may damage or cause the ScanSnap to malfunction.
- Be careful not to cut your finger on the edge of the Carrier Sheet.

Document type	Documents that cannot be loaded directly into the ScanSnap
Paper weight	Up to 209 g/m ² (55.7 lb) When scanning documents folded in half: Up to 105 g/m ² (27.9 lb)
Paper size	Carrier Sheet size (216 × 297 mm) A3 (297 × 420 mm) (*1) A4 (210 × 297 mm) A5 (148 × 210 mm) A6 (105 × 148 mm) B4 (257 × 364 mm) (*1) B5 (182 × 257 mm) B6 (128 × 182 mm) Postcard (100 × 148 mm) Business card (90 × 55 mm, 55 × 90 mm) Letter (8.5 × 11 in., 216 × 279.4 mm) 11 × 17 in. (279.4 × 431.8 mm) (*1) Custom size Width: 25.4 to 216 mm (1 to 8.5 in.) Length: 25.4 to 297 mm (1 to 11.69 in.)

*1: Fold in half to scan.

Documents for Which the Carrier Sheet is Recommended for Scanning

It is recommended that you use the Carrier Sheet to scan the following documents.

- Documents written in pencil

Because there may be black traces left on the documents, it is recommended that you use the Carrier Sheet to scan such documents.

When you scan such documents directly without using a Carrier Sheet, dirt will accumulate on the rollers, which may cause feeding errors. Clean the rollers occasionally.

For details about how to perform cleaning, refer to "[Cleaning the Inside of iX1600 / iX1500 / iX1400](#)" (page 510).

- Carbonless paper

Because carbonless paper may contain chemicals that can harm the ScanSnap internal rollers, it is recommended that you use the Carrier Sheet to scan such documents.

Make sure to clean the rollers occasionally to maintain the scanner performance when scanning carbonless paper directly without using the Carrier Sheet. For details about how to perform cleaning, refer to "[Cleaning the Inside of iX1600 / iX1500 / iX1400](#)" (page 510).

Depending on the type of carbonless paper, the life span of the scanner may be shortened compared to scanning office paper.

- Scanning the following types of documents without using the Carrier Sheet can result in documents being damaged or scanned incorrectly

- Documents smaller than 50.8 × 50.8 (mm)/2 × 2 (in.) (width × length)
- Documents whose paper weight is less than 40 g/m² (10.7 lb)
- Documents with an uneven surface (such as envelopes and paper sheets with attached materials)
- Wrinkled or curled documents
- Folded or torn documents
- Tracing paper
- Coated paper
- Photographs (photographic paper)
- Perforated or punched documents
- Documents that are not rectangular or square
- Carbon paper or thermal paper
- Documents with memo papers or sticky notes attached

ATTENTION

- Using the Carrier Sheet

Be careful of the following when you use the Carrier Sheet:

- Do not stain, or cut the black and white patterned end of the Carrier Sheet. Otherwise, the Carrier Sheet will not be recognized properly.
- Do not place the Carrier Sheet upside down. Otherwise, a paper jam may occur and damage the Carrier Sheet and the document inside.
- Do not fold or pull the Carrier Sheet.
- Paper jams may occur when several small size documents such as photographs and postcards are placed inside the Carrier Sheet to be scanned at once. It is recommended that you scan such documents one at a time.
- If paper jams occur frequently, feed about 50 sheets of PPC paper (recycled paper) before scanning with the Carrier Sheet. The PPC paper can either be blank or printed.

- Storing the Carrier Sheet

Be careful of the following when you store the Carrier Sheet:

- Do not leave your document inside the Carrier Sheet for a long time. Otherwise, the ink on the document may be transferred onto the Carrier Sheet.
- Do not leave the Carrier Sheet in high temperature places such as under direct sunlight or near a heating apparatus for a long time. Also, do not use the Carrier Sheet in high temperature places. The Carrier Sheet may be deformed.
- To avoid deformation, store the Carrier Sheet on a flat surface without any weight on it.

Scanning Documents (iX1600 / iX1500 / iX1400)

You can load documents such as handouts for meetings or business cards directly in the ScanSnap for scanning.

For details about documents that can be scanned, refer to "[Documents to Scan \(iX1600 / iX1500 / iX1400\)](#)" (page 198).

1. If you are loading multiple sheets, check the number of sheets.

The maximum number of sheets in the ScanSnap is as follows:

For A4 or smaller sizes: Up to 50 sheets can be loaded (with paper weight of 80 g/m² [20 lb] and thickness of the document stack under 5 mm [0.2 in.]).

ATTENTION

If you try to scan more than the maximum amount that can be loaded, the following problems may occur:

- Files cannot be properly created due to excessive file size.
- Paper jams occur during scanning.

2. Fan the documents.

1. Hold both ends of the documents and fan them a few times.

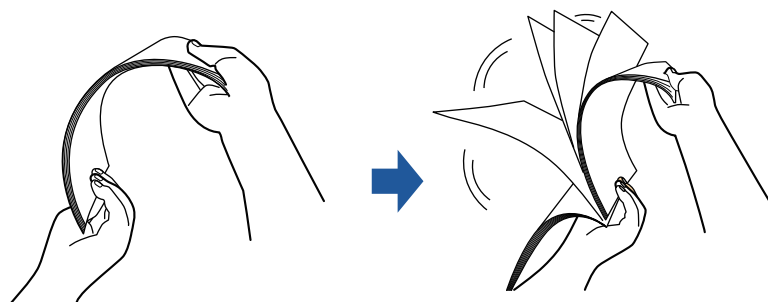

2. Rotate the documents 90 degrees and fan them in the same manner.

3. Straighten the edges of the documents and slightly displace the top edges at an angle.

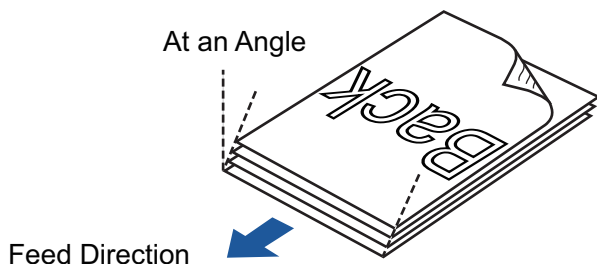

ATTENTION

Paper jams or damage to documents may occur if you scan the documents without aligning the edges first.

4. Open the ADF paper chute (cover) of the ScanSnap.

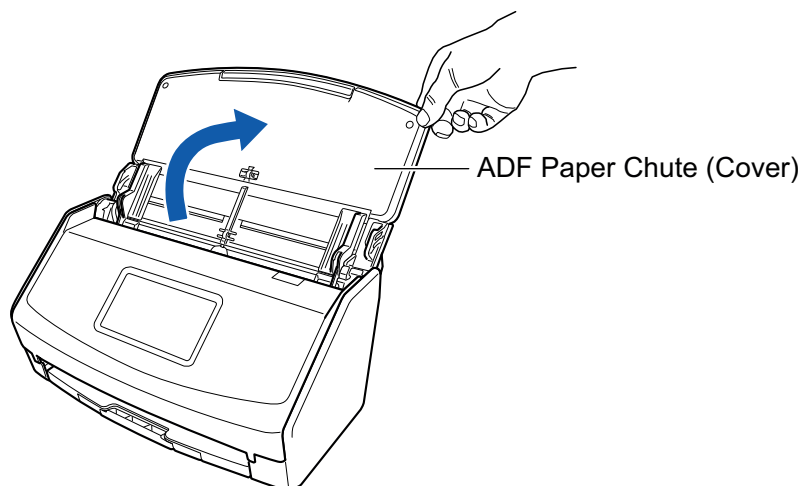



Example: iX1600

⇒ For iX1600/iX1500, the touch panel is activated.

For iX1400, the [Scan] button flashes in blue. The button returns to being lit normally when document scanning is enabled.

In addition, the ScanSnap Manager icon in the notification area located at the far right of

the taskbar changes from  to .

5. Pull out the extension and the stacker on the ADF paper chute (cover).

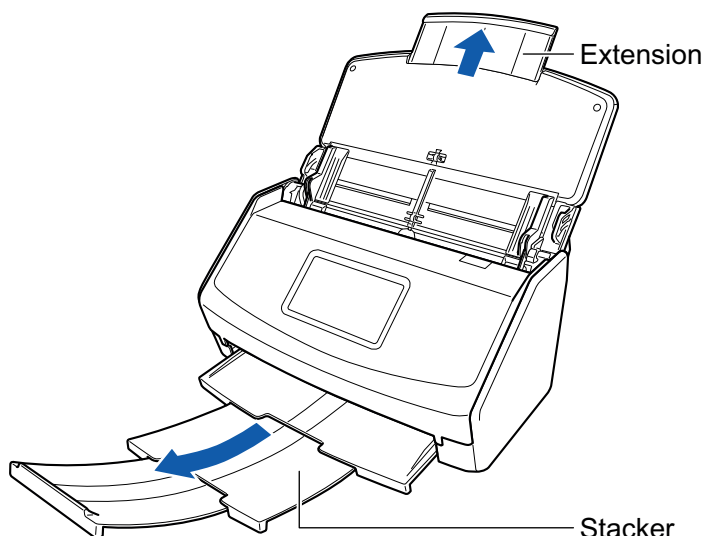

Example: iX1600

6. Load the documents in the ADF paper chute (cover).

Load the document face-down and head-first with the back facing you (when loading multiple documents, the last page is on the top). Adjust the number of documents so that they do not go beyond the reference marks and are kept within the side guides when they are loaded.

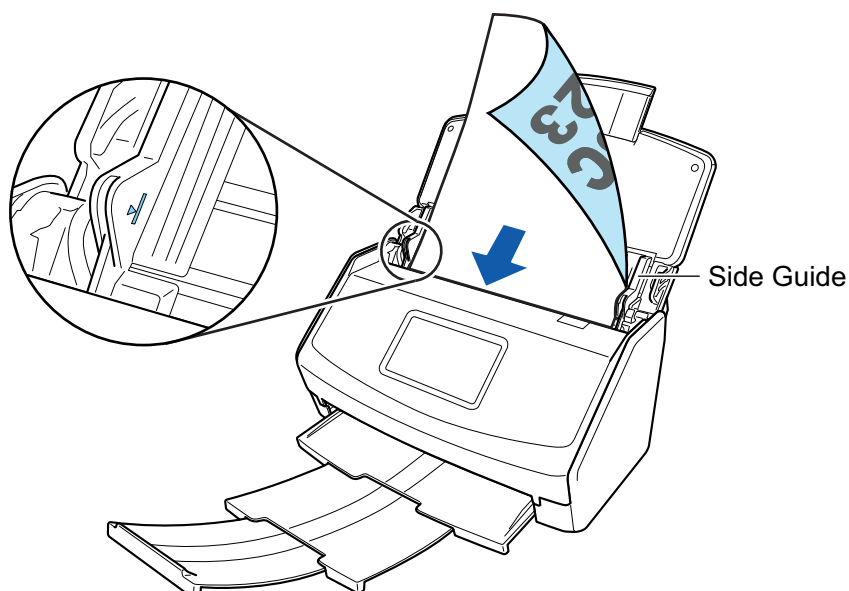

Example: iX1600

ATTENTION

- Do not accumulate more than 50 sheets (with paper weight of 80 g/m² [20 lb]) in the stacker.
- When the [Place document face up] checkbox is selected in the [Scanning mode option] window, load the documents face-up and bottom edge down.

To open the [Scanning mode option] window, click the [Option] button in the [Scanning] tab of the "ScanSnap Setup Window" (page 102).

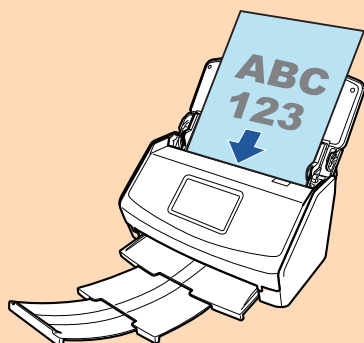

Example: iX1600

7. Adjust the side guides to the width of the documents.

Hold each side guide in the middle to adjust them. Otherwise, the documents may be fed skewed.

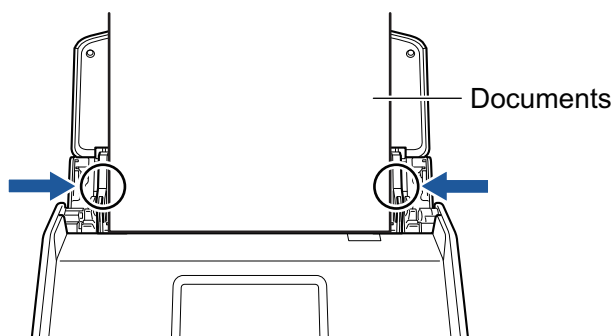

Example: iX1600

8. Start scanning.

For iX1600/iX1500, press the [Scan] button in the [home screen](#) on the touch panel.

For iX1400, press the [Scan] button on the ScanSnap.

ATTENTION

Do not perform the following operations during scanning. Doing so will stop scanning.

- Connect or disconnect the ScanSnap and other USB devices.
- Close the ADF paper chute (cover).
- Change user accounts on the computer
- Allow the computer to enter sleep mode.

⇒ For iX1600/iX1500, [Scanning] is displayed on the touch panel while the documents are being scanned.

For iX1400, the [Scan] button on the ScanSnap flashes in blue while the documents are being scanned.

In addition, the [ScanSnap Manager - Image scanning and file saving] window appears on the computer.

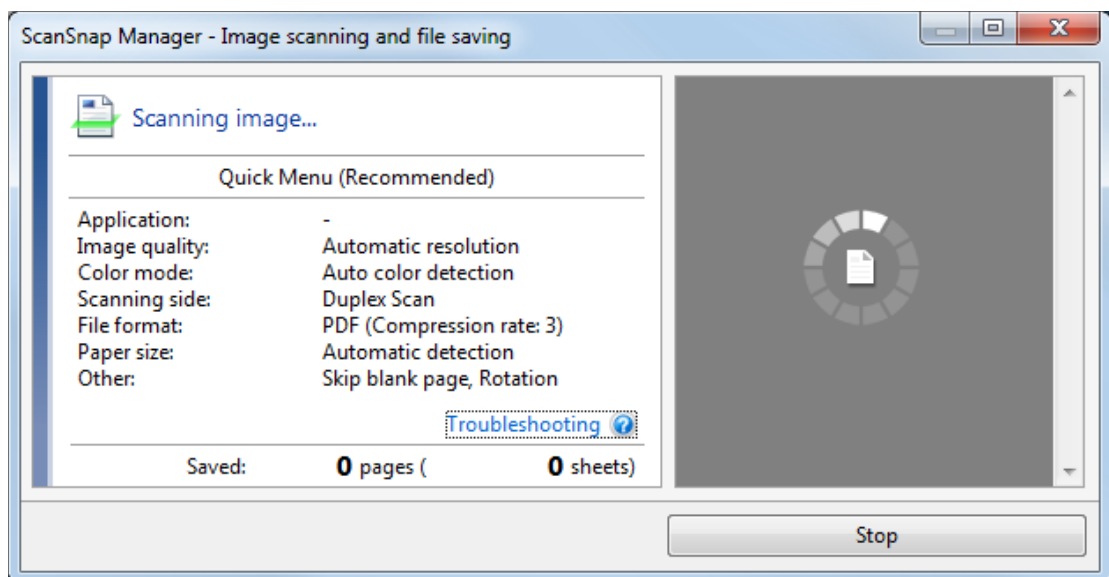

⇒ The Quick Menu appears when the scanning is completed.

9. In the Quick Menu, click the icon of the application to link with ScanSnap Manager.

For details about linking the following applications with ScanSnap Manager, refer to ["Useful Usages"](#) (page 439).

- Save Documents
- Save Business Cards
- Save Receipts
- Save Photos

HINT

The following applications are displayed in the Quick Menu when ScanSnap Organizer and CardMinder are installed.

- When ScanSnap Organizer is installed
ScanSnap Organizer

- When CardMinder is installed
CardMinder

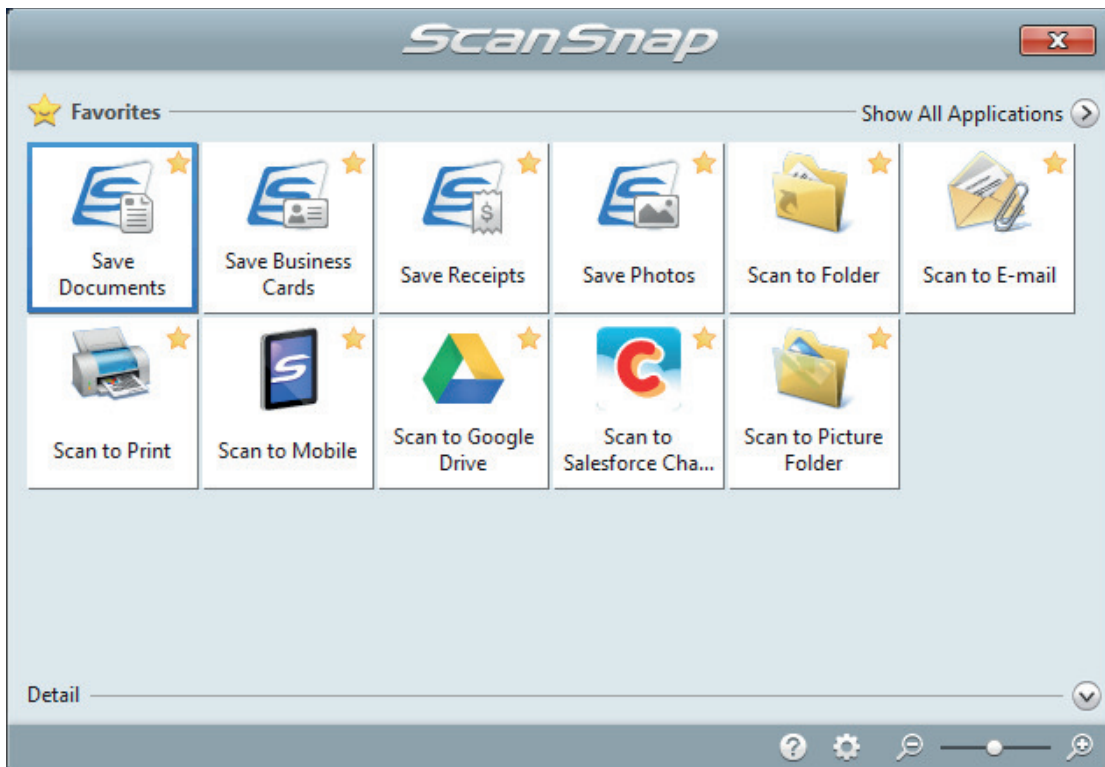

⇒ The selected application starts up. For details, refer to the Advanced Operation Guide.

ATTENTION

- You cannot start scanning when the Quick Menu is displayed. Either select an icon from the Quick Menu and finish the process, or close the Quick Menu before you perform the next scan.
- Do not move, delete, or rename scanned images using other applications while the Quick Menu is displayed.

HINT

- Clicking  displays the description of an application. Placing the mouse cursor over the icon of another application displays the description of the application.
- Performing a scan while an application that can be automatically linked with is active automatically starts the linkage between ScanSnap Manager and the application.
For details, refer to the Advanced Operation Guide.

Scanning Long Pages (iX1600 / iX1500 / iX1400)

Documents up to 863 mm (34 in.) in length can be scanned.

For details about documents that can be scanned, refer to "[Documents to Scan \(iX1600 / iX1500 / iX1400\)](#)" (page 198).

HINT

For details about how to load documents that are 360 mm (14.17 in.) or less in length, refer to "[Scanning Documents \(iX1600 / iX1500 / iX1400\)](#)" (page 202).

1. Open the ADF paper chute (cover) of the ScanSnap.

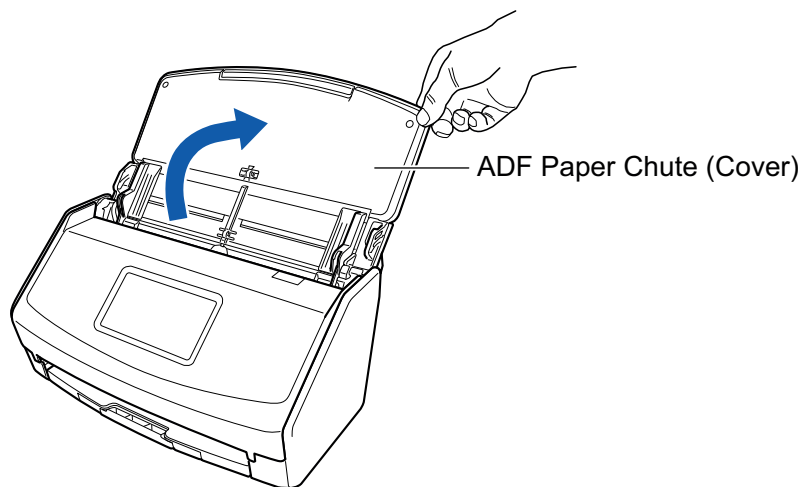

Example: iX1600

⇒ For iX1600/iX1500, the touch panel is activated.

For iX1400, the [Scan] button flashes in blue. The button returns to being lit normally when document scanning is enabled.

In addition, the ScanSnap Manager icon in the notification area located at the far right of

the taskbar changes from  to .

2. Pull out the extension and the stacker on the ADF paper chute (cover).

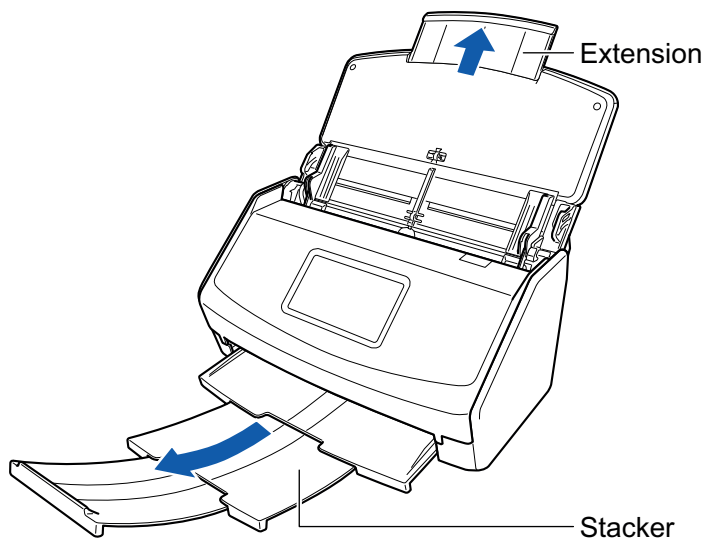

Example: iX1600

3. Load only one document in the ADF paper chute (cover).

Hold the document with your hand so that it does not fall out of the ADF paper chute (cover).

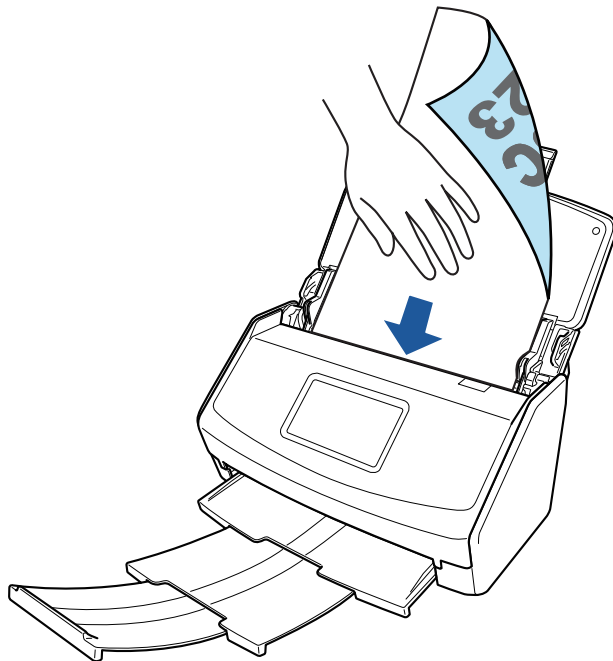

Example: iX1600

4. Start scanning.

For iX1600/iX1500, press the [Scan] button in the [home screen](#) on the touch panel for 3 seconds or longer until the button changes color.

For iX1400, press the [Scan] button on the ScanSnap (for three seconds or longer) until the button flashes in blue.

ATTENTION

- Secure enough space where the scanned documents are ejected from the ScanSnap, and pick up the documents with your hands to prevent them from falling off the unit where the ScanSnap is placed on.

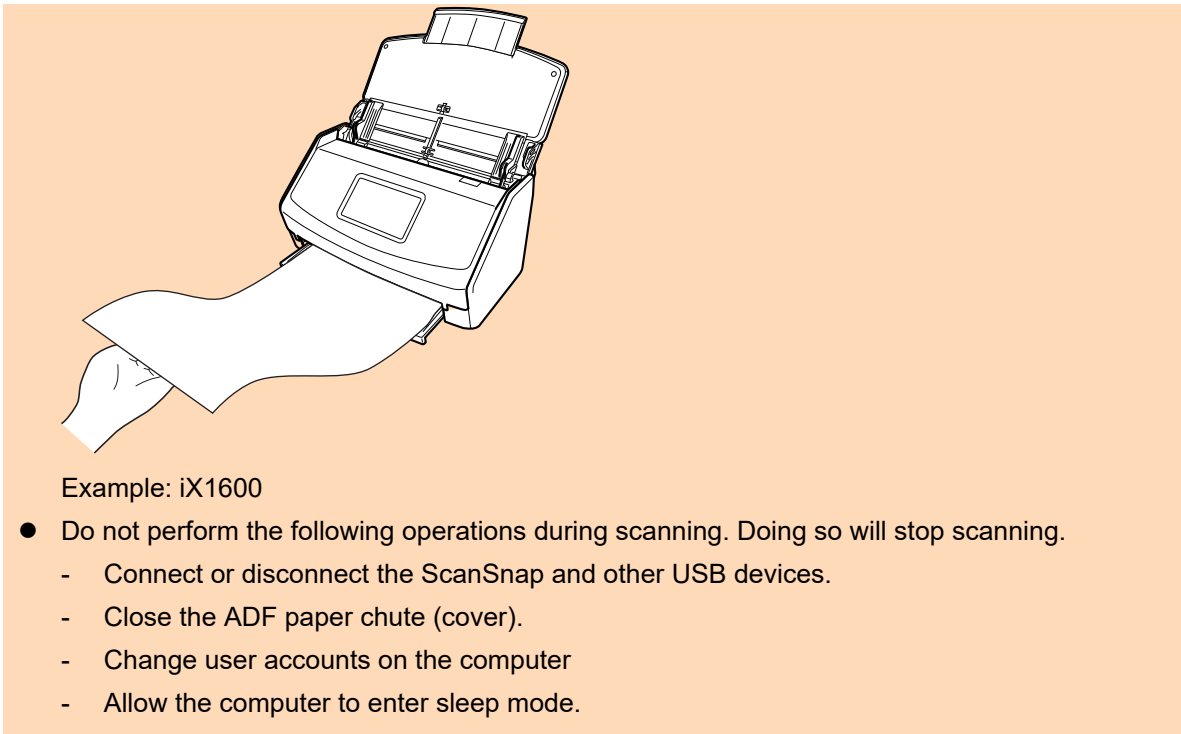

HINT

When you scan the first page as a long page and continue scanning, the subsequent documents are also scanned as long pages.

⇒ For iX1600/iX1500, [Scanning] is displayed on the touch panel while the documents are being scanned.

For iX1400, the [Scan] button on the ScanSnap flashes in blue while the documents are being scanned.

In addition, the [ScanSnap Manager - Image scanning and file saving] window appears on the computer.

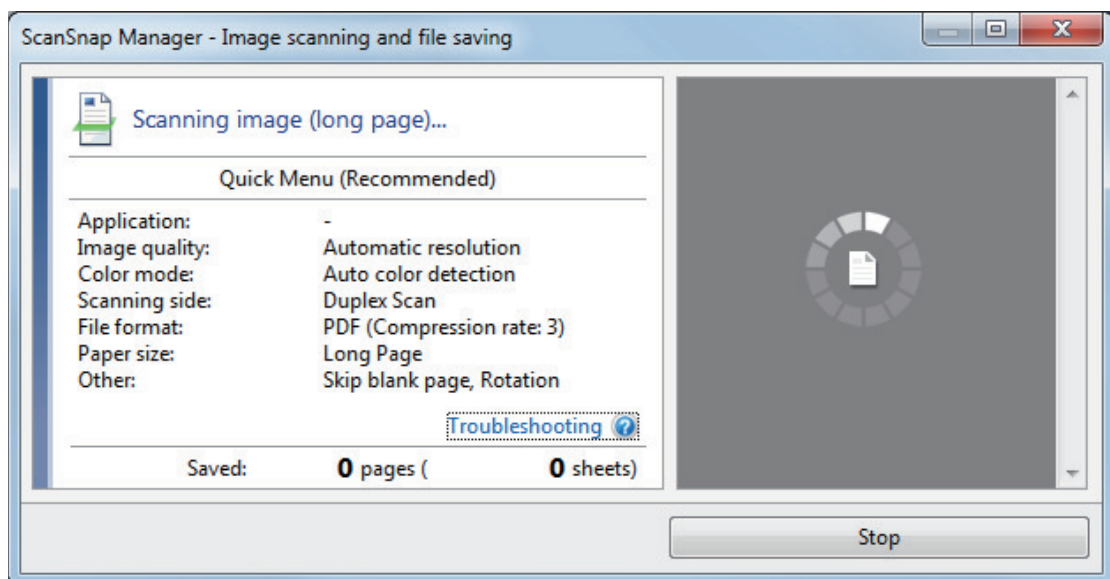

⇒ The Quick Menu appears when the scanning is completed.

5. In the Quick Menu, click the icon of the application to link with ScanSnap Manager.

When you select [Save Documents], you can manage scanned images by folder with ScanSnap Home.

For details, refer to "Managing Paper Documents by Folder on a Computer with ScanSnap Home" (page 440).

HINT

[ScanSnap Organizer] is displayed in the Quick Menu when ScanSnap Organizer is installed.

To manage scanned images by folder with ScanSnap Organizer, refer to "Managing Paper Documents by Folder on a Computer with ScanSnap Organizer" (page 443).



⇒ The selected application starts up. For details, refer to the Advanced Operation Guide.

ATTENTION

- You cannot start scanning when the Quick Menu is displayed. Either select an icon from the Quick Menu and finish the process, or close the Quick Menu before you perform the next scan.
- Do not move, delete, or rename scanned images using other applications while the Quick Menu is displayed.

HINT

- Clicking  displays the description of an application. Placing the mouse cursor over the icon of another application displays the description of the application.
- Performing a scan while an application that can be automatically linked with is active automatically starts the linkage between ScanSnap Manager and the application.
For details, refer to the Advanced Operation Guide.

Scanning Documents of Different Widths or Lengths in One Batch (iX1600 / iX1500 / iX1400)

Documents of different widths or lengths can be scanned in one batch.

For details about documents that can be scanned, refer to "[Documents to Scan \(iX1600 / iX1500 / iX1400\)](#)" (page 198).

1. Open the ADF paper chute (cover) of the ScanSnap.

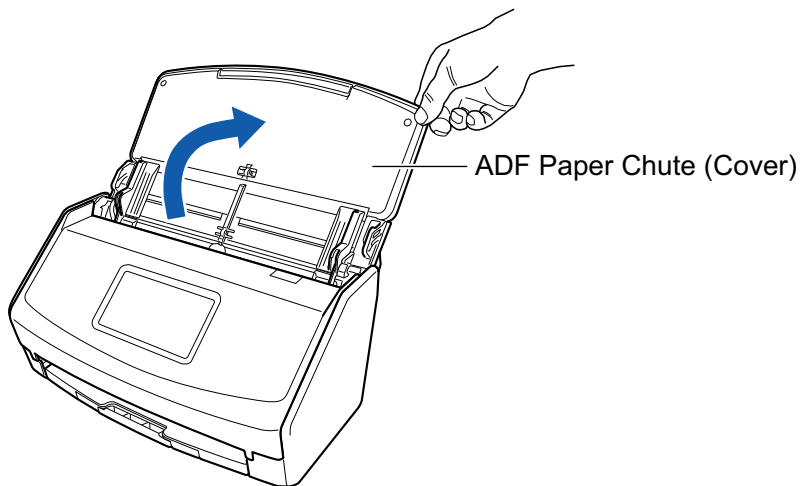



Example: iX1600

⇒ For iX1600/iX1500, the touch panel is activated.

For iX1400, the [Scan] button flashes in blue. The button returns to being lit normally when document scanning is enabled.

In addition, the ScanSnap Manager icon in the notification area located at the far right of

the taskbar changes from  to .

2. Pull out the extension and the stacker on the ADF paper chute (cover).

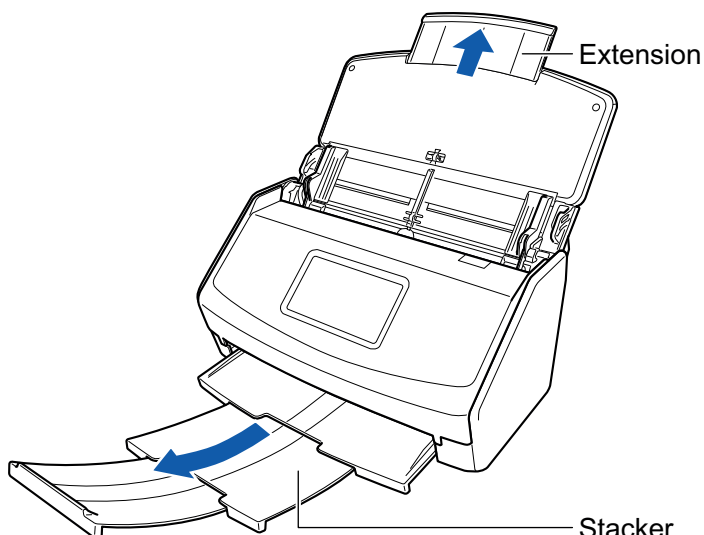

Example: iX1600

3. Right-click the ScanSnap Manager icon  in the notification area located at the far right of the taskbar, and select the [Scan Button Settings] from the "Right-Click Menu" (page 100).

⇒ The ScanSnap setup window appears.

4. In the [Paper] tab, select [Automatic detection] in [Paper size].

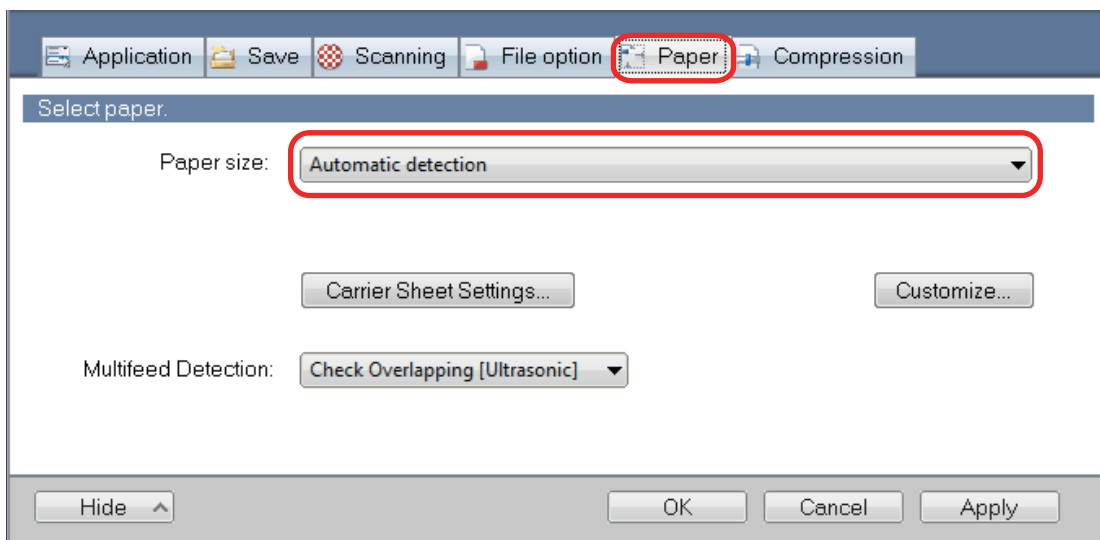

5. Select [None] in [Multifeed Detection].

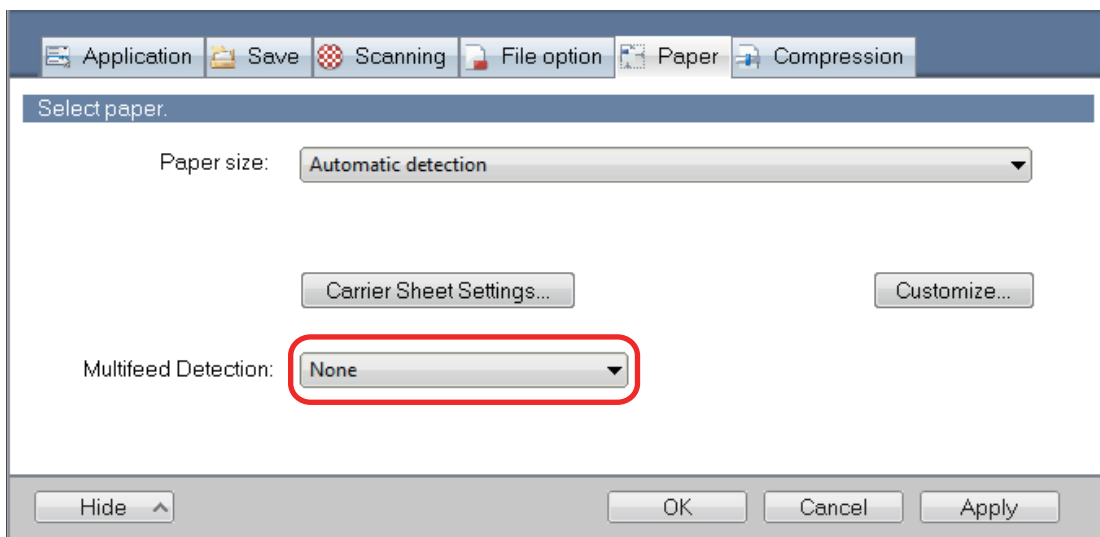

6. Click the [OK] button to close the ScanSnap setup window.
7. Load documents in the ScanSnap.
 1. Align the edges of the documents.

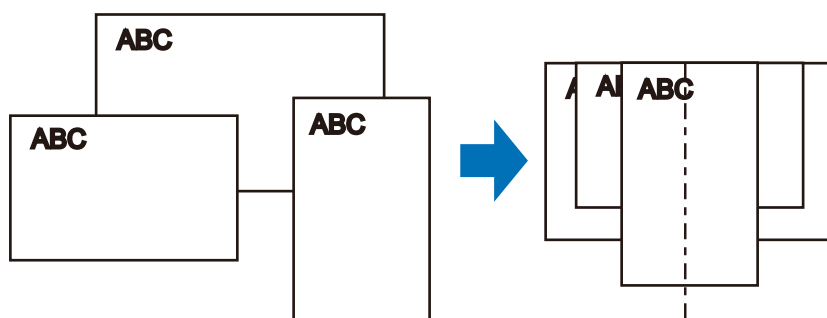

2. Load the documents face-down and top-first with the back of the last document facing you.

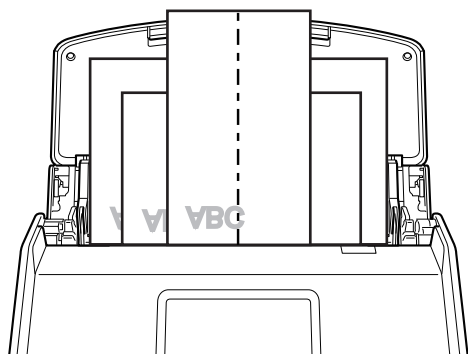

Example: iX1600

ATTENTION

- The pick roller feeds the documents. Load all documents over one another above the pick roller (center). Documents that are not loaded above the pick roller cannot be fed.

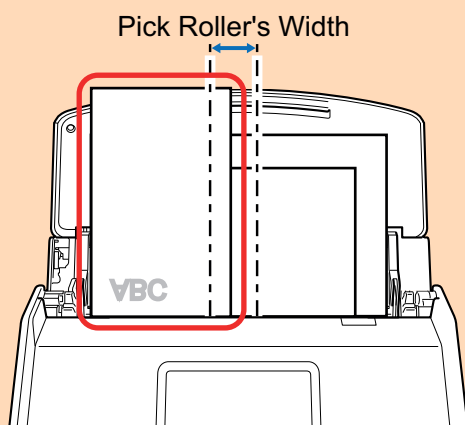

Example: iX1600

- Adjust the side guides to the widest document. If the side guides are not adjusted properly, a paper jam may occur.
- Load smaller documents so that they can be scanned straight.

If the documents are skewed during scanning, the following problems may occur:

- Part of the document does not appear in the scanned image
- Slant lines appear in the scanned image
- The documents are scanned in a wrong paper size

If the documents are not scanned straight, it is recommended that you select the [Continue scanning after last page] checkbox in the [Scanning] tab of the "[ScanSnap Setup Window](#)" ([page 102](#)), separate the documents by their widths, and scan them in different batches.

8. Start scanning.

For iX1600/iX1500, press the [Scan] button in the [home screen](#) on the touch panel.

For iX1400, press the [Scan] button on the ScanSnap.

ATTENTION

Do not perform the following operations during scanning. Doing so will stop scanning.

- Connect or disconnect the ScanSnap and other USB devices.
- Close the ADF paper chute (cover).
- Change user accounts on the computer
- Allow the computer to enter sleep mode.

⇒ For iX1600/iX1500, [Scanning] is displayed on the touch panel while the documents are being scanned.

For iX1400, the [Scan] button on the ScanSnap flashes in blue while the documents are being scanned.

In addition, the [ScanSnap Manager - Image scanning and file saving] window appears on the computer.

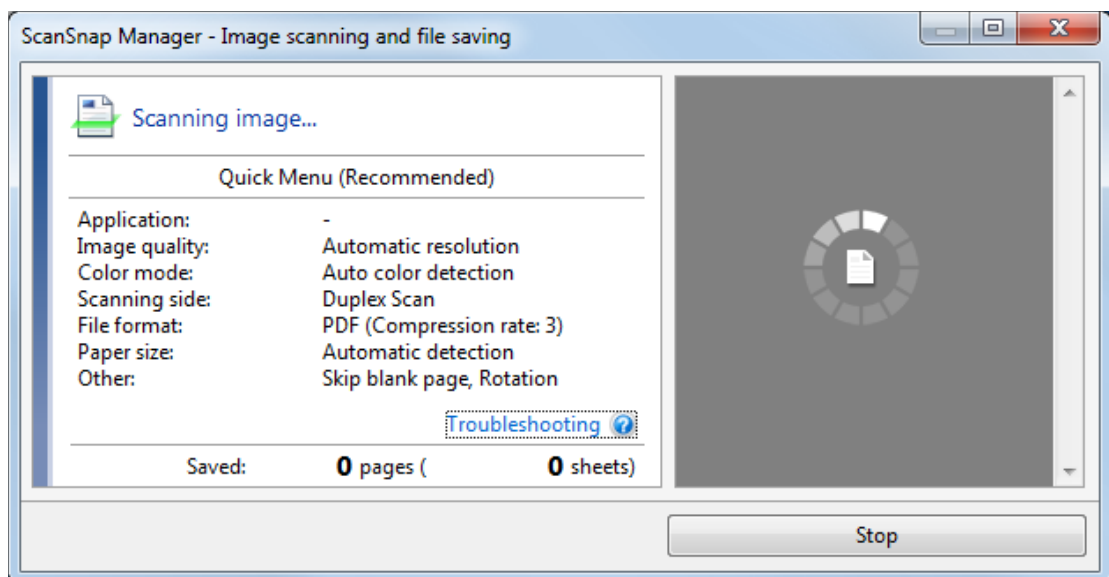

⇒ The Quick Menu appears when the scanning is completed.

9. In the Quick Menu, click the icon of the application to link with ScanSnap Manager.

When you select [Save Documents], you can manage scanned images by folder with ScanSnap Home.

For details, refer to "[Managing Paper Documents by Folder on a Computer with ScanSnap Home](#)" (page 440).

HINT

[ScanSnap Organizer] is displayed in the Quick Menu when ScanSnap Organizer is installed.

To manage scanned images by folder with ScanSnap Organizer, refer to "[Managing Paper Documents by Folder on a Computer with ScanSnap Organizer](#)" (page 443).

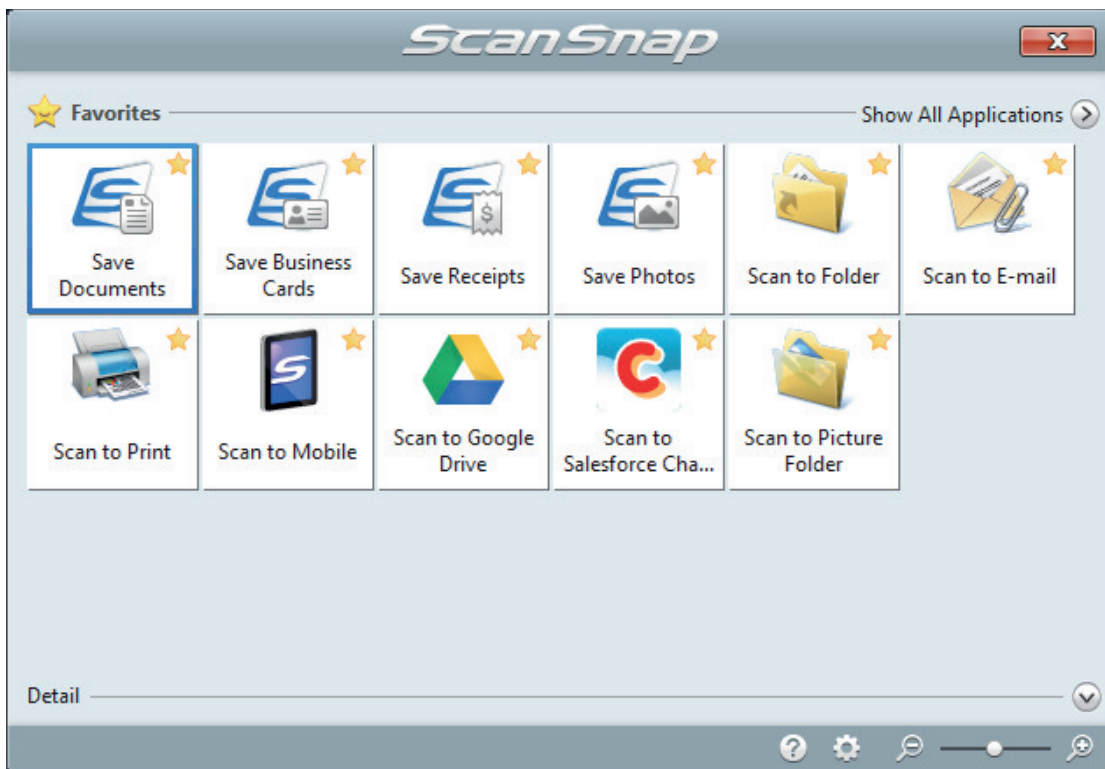

⇒ The selected application starts up. For details, refer to the Advanced Operation Guide.

ATTENTION

- You cannot start scanning when the Quick Menu is displayed. Either select an icon from the Quick Menu and finish the process, or close the Quick Menu before you perform the next scan.
- Do not move, delete, or rename scanned images using other applications while the Quick Menu is displayed.

HINT

- Clicking  displays the description of an application. Placing the mouse cursor over the icon of another application displays the description of the application.
- Performing a scan while an application that can be automatically linked with is active automatically starts the linkage between ScanSnap Manager and the application. For details, refer to the Advanced Operation Guide.

Scanning Small Size Documents such as Receipts in One Go (iX1600 / iX1500 / iX1400)

If the Receipt Guide is attached to the ScanSnap, a batch of small size documents such as receipts can be loaded in the ScanSnap at the same time.

In addition, the Receipt Guide gives you the option to load different-sized documents according to the size of each document by using three kinds of guides at the same time.

1. Open the ADF paper chute (cover) of the ScanSnap.

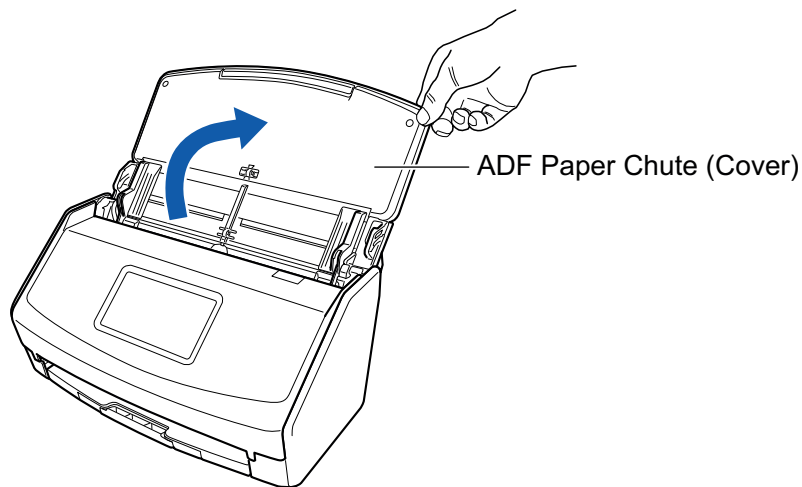



Example: iX1600

⇒ For iX1600/iX1500, the touch panel is activated.

For iX1400, the [Scan] button flashes in blue. The button returns to being lit normally when document scanning is enabled.

In addition, the ScanSnap Manager icon in the notification area located at the far right of

the taskbar changes from  to .

2. Pull out the extension and the stacker on the ADF paper chute (cover).

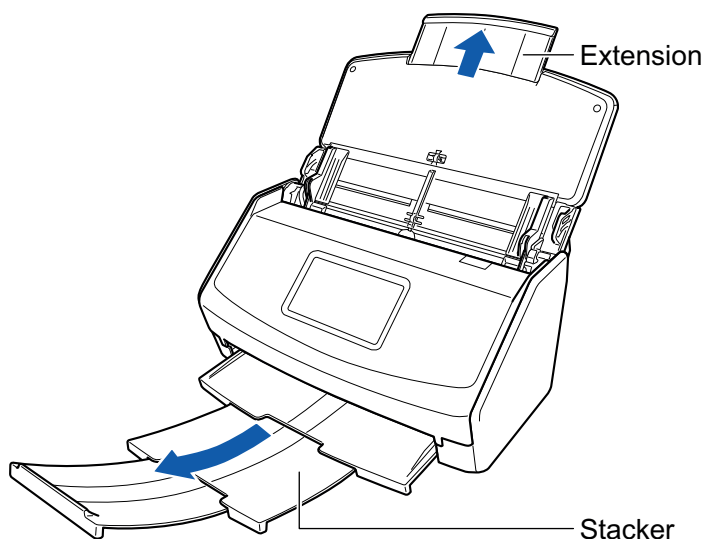

Example: iX1600

3. Attach the Receipt Guide.

For details, refer to "[Attaching the Receipt Guide \(iX1600 / iX1500 / iX1400\)](#)" (page 128).

4. Load documents in the ADF paper chute (cover).

Load documents in the guides on the Receipt Guide according to the width of each guide. Load the documents face-down and top-first with their back facing you.

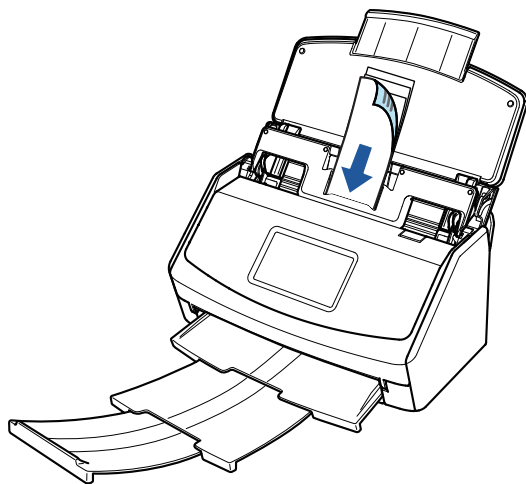

Example: iX1600

5. Start scanning.

For iX1600/iX1500, press the [Scan] button in the [home screen](#) on the touch panel.

For iX1400, press the [Scan] button on the ScanSnap.

ATTENTION

Do not perform the following operations during scanning. Doing so will stop scanning.

- Connect or disconnect the ScanSnap and other USB devices.
- Close the ADF paper chute (cover).
- Change user accounts on the computer
- Allow the computer to enter sleep mode.

⇒ For iX1600/iX1500, [Scanning] is displayed on the touch panel while the documents are being scanned.

For iX1400, the [Scan] button on the ScanSnap flashes in blue while the documents are being scanned.

In addition, the [ScanSnap Manager - Image scanning and file saving] window appears on the computer.

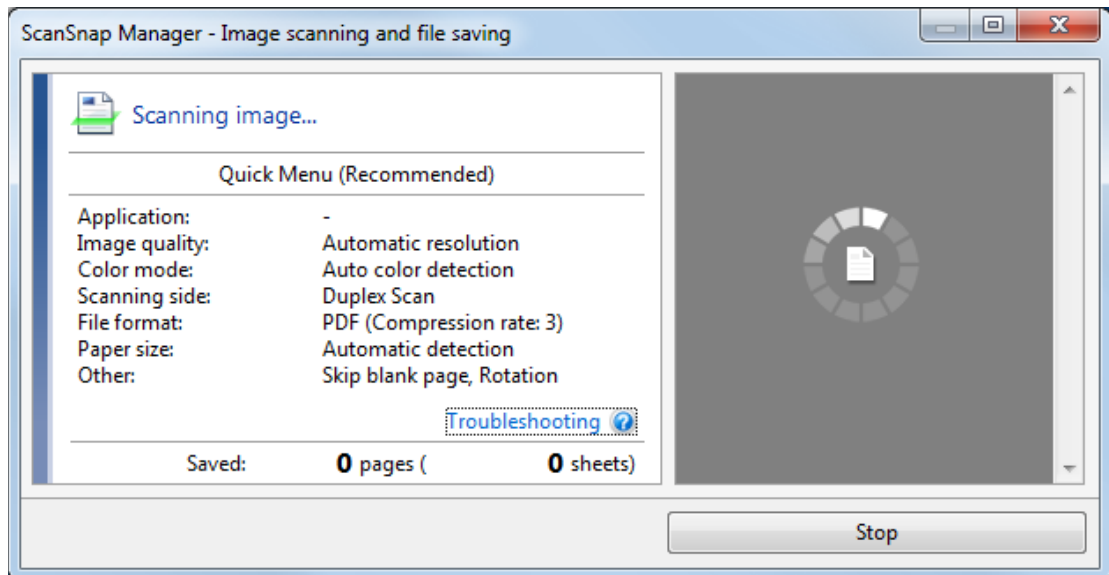

⇒ The Quick Menu appears when the scanning is completed.

6. In the Quick Menu, click the icon of the application to link with ScanSnap Manager.

For details about linking the following applications with ScanSnap Manager, refer to "Useful Usages" (page 439).

- Save Business Cards
- Save Receipts

HINT

[Scan to CardMinder] is displayed in the Quick Menu when ScanSnap CardMinder is installed.



⇒ The selected application starts up. For details, refer to the Advanced Operation Guide.

ATTENTION

- You cannot start scanning when the Quick Menu is displayed. Either select an icon from the Quick Menu and finish the process, or close the Quick Menu before you perform the next scan.
- Do not move, delete, or rename scanned images using other applications while the Quick Menu is displayed.

HINT

- Clicking  displays the description of an application. Placing the mouse cursor over the icon of another application displays the description of the application.
- Performing a scan while an application that can be automatically linked with is active automatically starts the linkage between ScanSnap Manager and the application.
For details, refer to the Advanced Operation Guide.

Scanning Documents Larger Than A4 or Letter Size (iX1600 / iX1500 / iX1400)

Documents larger than A4/Letter size (such as A3, 11 × 17 in. and B4) can be scanned with the optional Carrier Sheet. By folding the document in half and scanning in duplex mode, the two sides are merged into a single image.

For details about documents that can be loaded, refer to "[Documents to Scan \(iX1600 / iX1500 / iX1400\)](#)" (page 198).

ATTENTION

The [Deskew by text on document] checkbox in the [Scanning mode option] window will be disabled. To open the [Scanning mode option] window, click the [Option] button in the [Scanning] tab of the "[ScanSnap Setup Window](#)" (page 102).

HINT

Both sides of a double-sided A4/Letter size document or smaller can also be scanned and merged into a single image.

1. **Right-click the ScanSnap Manager icon  in the notification area located at the far right of the taskbar, and select the [Scan Button Settings] from the "Right-Click Menu" (page 100).**
⇒ The ScanSnap setup window appears.
2. **In the [Paper] tab, select [Automatic detection] in [Paper size], and then click the [Carrier Sheet Settings] button.**

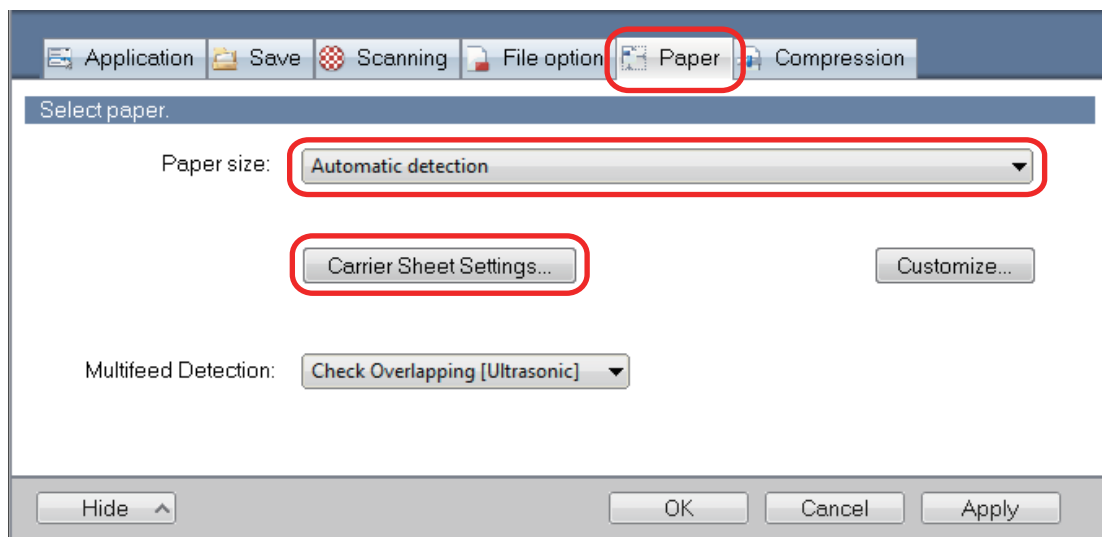

⇒ The [Carrier Sheet Settings] window appears.

3. **Select [one double-page spread image] in [Save as] and click the [OK] button.**

For details, refer to the ScanSnap Manager Help.

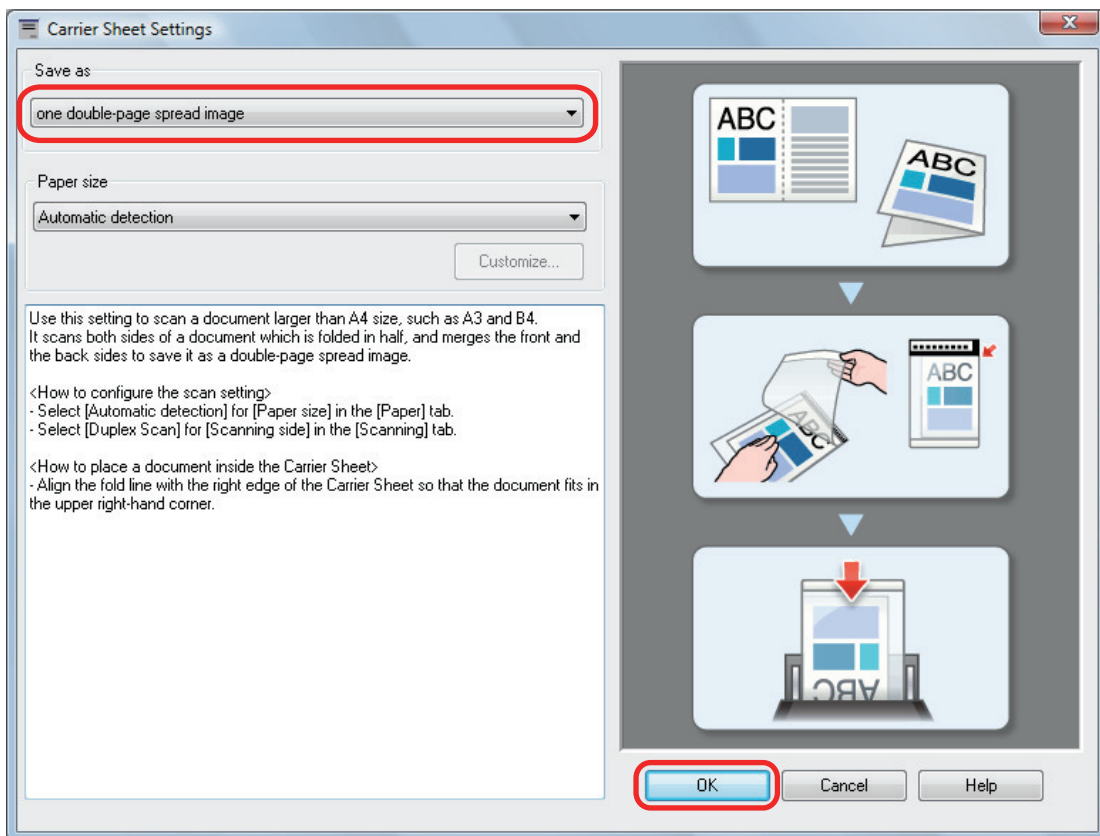

4. In [Scanning side] in the [Scanning] tab, select [Duplex Scan (Double-sided)] and click the [OK] button.

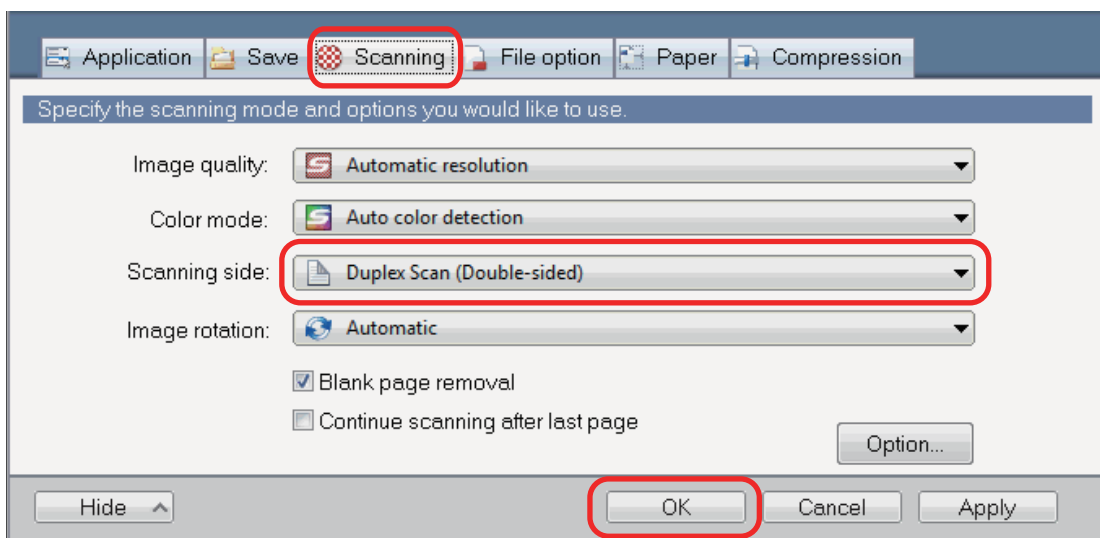

ATTENTION

If [Simplex Scan (Single-sided)] is selected, the ScanSnap outputs the same result as performing a simplex scan in [two separate images (front and back)] mode.

5. Place the document inside the Carrier Sheet.

1. Fold the document in half with the sides to be scanned facing out.
Fold it tightly and smooth out any creases.

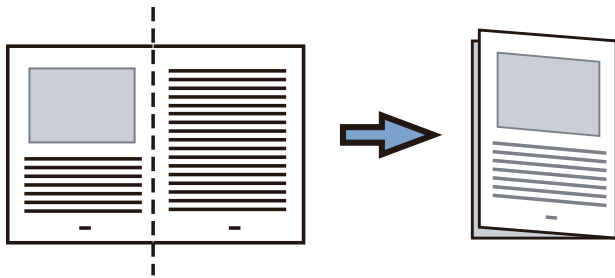

2. Open the Carrier Sheet to bind the document.

Align the fold line with the right edge of the Carrier Sheet so that the document fits in the upper right-hand corner of the Carrier Sheet.

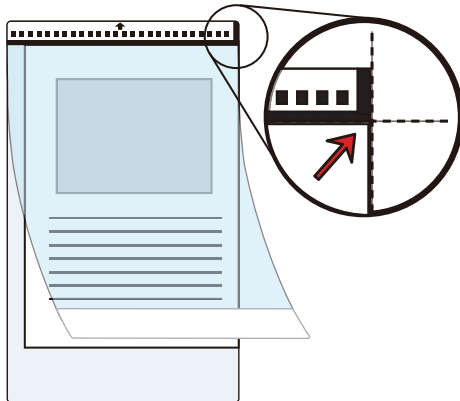

HINT

Note that the front side of the Carrier Sheet has a black and white pattern at the top and a thick vertical line in the upper right-hand corner.

6. Place the end with the black and white pattern as the leading edge in the direction of the arrow.

Secure the Carrier Sheet with the side guides to avoid skewing.

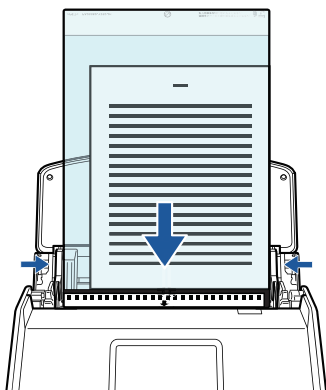

Example: iX1600

7. Start scanning.

For iX1600/iX1500, press the [Scan] button in the [home screen](#) on the touch panel.

For iX1400, press the [Scan] button on the ScanSnap.

⇒ Both sides of the document are scanned and saved as one double-page spread image.

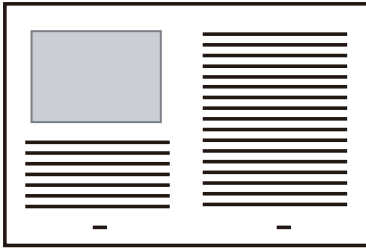

ATTENTION

- There may be a line or a gap appearing between the front and back side images. Also when you scan a thick document in the Carrier Sheet, the scanned image on the left and the scanned image on the right of a double-page spread image may skew towards each other from the top.

These symptoms may be improved when you place the document in the Carrier Sheet as follows:

- Fold the document properly
- Neatly align the edges of the document with the edges of the Carrier Sheet
- Turn over the Carrier Sheet to the other (reverse) side
- If [Automatic detection] is specified for [Paper size] in the [Carrier Sheet Settings] window, an optimal size will be selected automatically from the available standard sizes (A3, B4, or 11 × 17 in.) in [Paper size]. Note that the size of the image may become smaller than the original document depending on the document.

Example: When characters and illustrations are printed to fit in A4 size in the center of an A3 size document, the scanned image is output in B4 size.

To output the scanned image in its original size, specify the document size in [Paper size].

- Part of the scanned image around where the document is folded may appear missing. In that case, place the document so that its edge is about 1 mm (0.04 in.) inside from the edge of the Carrier Sheet.

HINT

Multiple Carrier Sheets can be loaded in the ADF paper chute (cover) and scanned.

Scanning Documents Such as Photographs and Clippings (iX1600 / iX1500 / iX1400)

Using the optional Carrier Sheet allows you to scan documents that can be damaged quite easily such as photographs, or non-standard size documents that are difficult to load directly such as clippings.

For details about documents that can be loaded, refer to "[Documents to Scan \(iX1600 / iX1500 / iX1400\)](#)" (page 198).

ATTENTION

The [Deskew by text on document] checkbox in the [Scanning mode option] window will be disabled.

To open the [Scanning mode option] window, click the [Option] button in the [Scanning] tab of the "[ScanSnap Setup Window](#)" (page 102).

1. **Right-click the ScanSnap Manager icon  in the notification area located at the far right of the taskbar, and select the [Scan Button Settings] from the "Right-Click Menu" (page 100).**
⇒ The ScanSnap setup window appears.
2. **In the [Paper] tab, select [Automatic detection] in [Paper size], and then click the [Carrier Sheet Settings] button.**

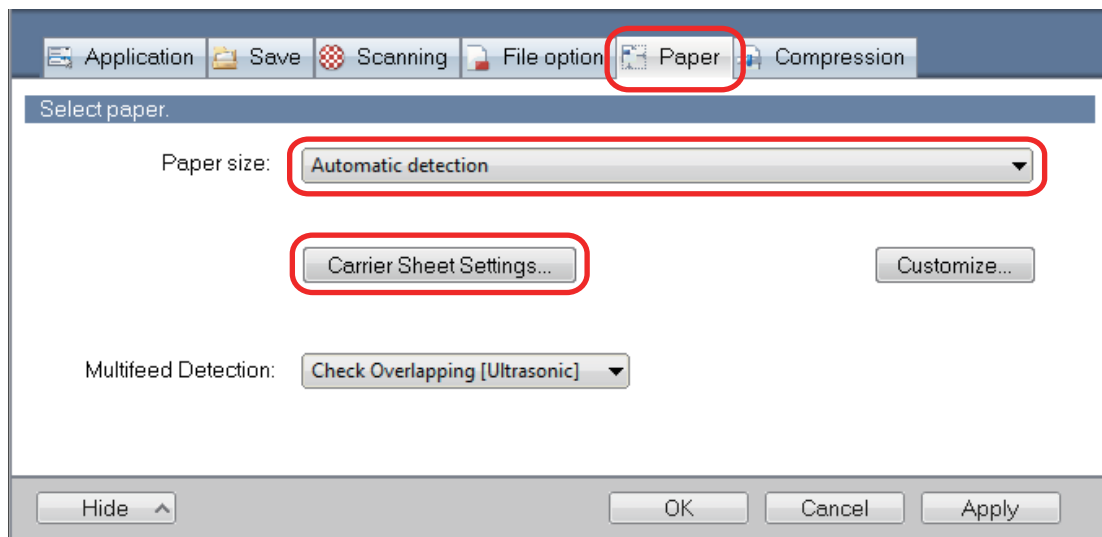

⇒ The [Carrier Sheet Settings] window appears.

3. **Select [two separate images (front and back)] in [Save as] and click the [OK] button.**

For details, refer to the ScanSnap Manager Help.

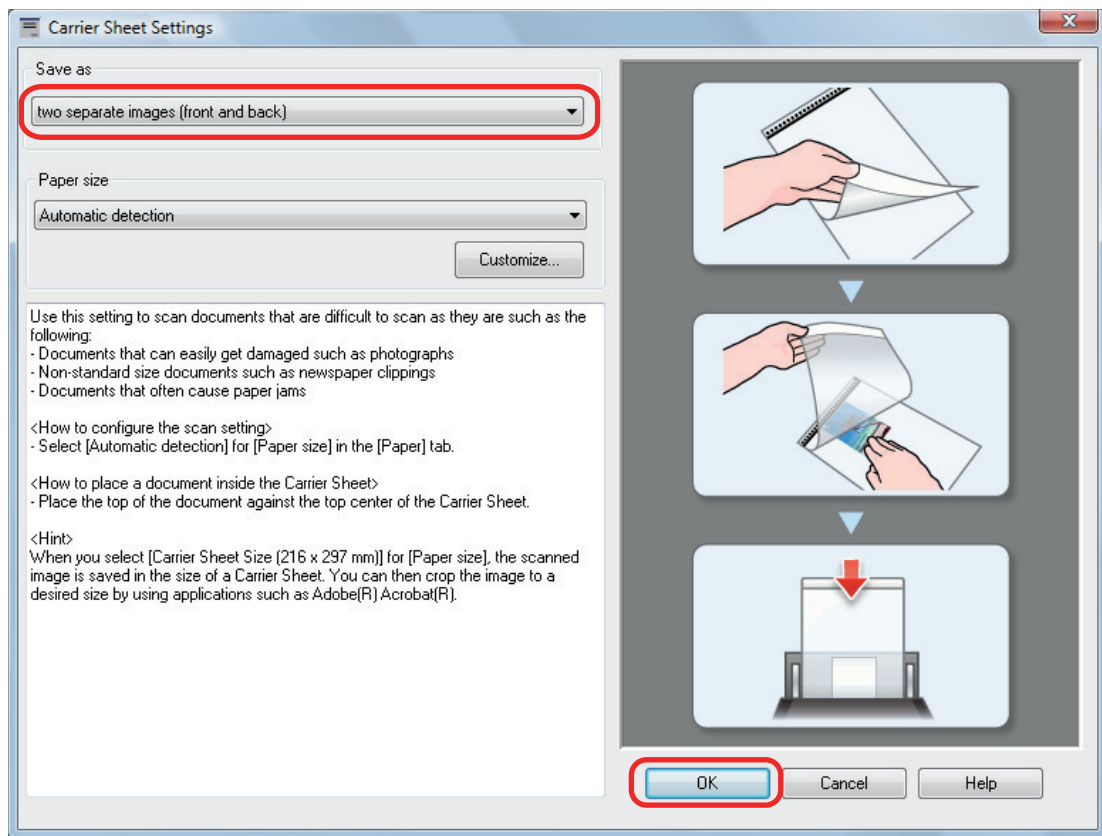

4. Click the [OK] button to close the ScanSnap setup window.

5. Place the document inside the Carrier Sheet.

Open the Carrier Sheet and place the top of the document against the top center of the Carrier Sheet.

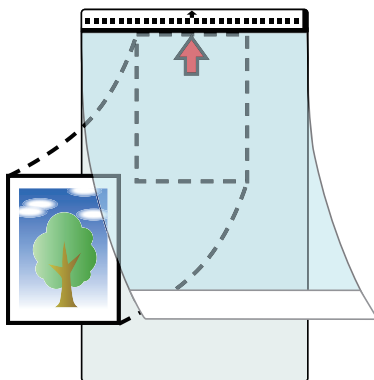

6. Place the end with the black and white pattern as the leading edge in the direction of the arrow.

Place the back side of the document towards you.

Secure the Carrier Sheet with the side guides to avoid skewing.

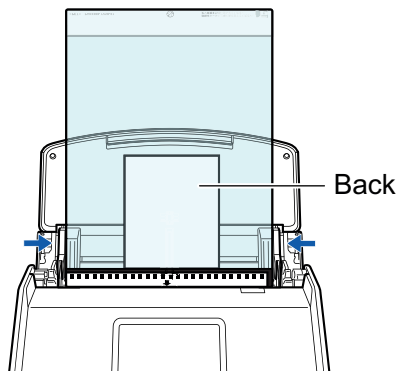

Example: iX1600

ATTENTION

When the [Place document face up] checkbox is selected in the [Scanning mode option] window, place the document in the Carrier Sheet face-up and bottom edge down.

To open the [Scanning mode option] window, click the [Option] button in the [Scanning] tab of the "ScanSnap Setup Window" (page 102).

7. Start scanning.

For iX1600/iX1500, press the [Scan] button in the [home screen](#) on the touch panel.

For iX1400, press the [Scan] button on the ScanSnap.

⇒ When scanning is completed, the scanned image is saved.

ATTENTION

- The scanned image is output at the center of the page in the size specified for [Paper size] in the [Carrier Sheet Settings] window.
- If [Automatic detection] is specified for [Paper size] in the [Carrier Sheet Settings] window, an optimal size will be selected automatically from the available standard sizes in [Paper size]. Note that the size of the image may become smaller than the original document depending on the document scanned, or part of the image may appear missing.

Example: When the contents are printed to fit in A5 size in the center of an A4 size document, the scanned image is output in A5 size.

To output the scanned image in its original size, specify the document size in [Paper size].

HINT

- In the following cases, place a blank (white) sheet of paper underneath the document when scanning:
 - The scanned image is not saved in the correct size (when [Automatic detection] is selected for [Paper size] in the [Carrier Sheet Settings] window)
 - Shadows appear around the edges of the scanned image
 - Black lines appear around the edges of a uniquely shaped cutting document if you place the document in the Carrier Sheet

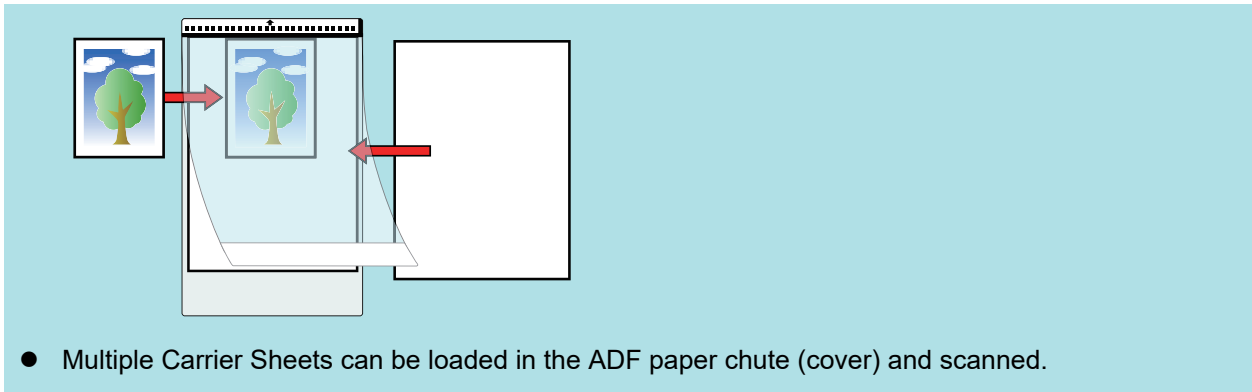

Scanning Documents with iX1300

- ["Two Scanning Methods for iX1300" \(page 229\)](#)
- ["Documents to Scan \(iX1300\)" \(page 231\)](#)
- ["Scanning Documents \(iX1300\)" \(page 235\)](#)
- ["Scanning Documents in Multiple Batches to Create a Single Scanned Image \(iX1300\)" \(page 242\)](#)
- ["Scanning Long Pages \(iX1300\)" \(page 250\)](#)
- ["Scanning Documents of Different Widths or Lengths in One Batch \(iX1300\)" \(page 256\)](#)
- ["Scanning Documents Larger Than A4 or Letter Size by Directly Inserting Them in the ScanSnap \(iX1300\)" \(page 263\)](#)
- ["Scanning Documents Larger than A4 or Letter Size with the Carrier Sheet \(iX1300\)" \(page 268\)](#)
- ["Scanning Documents Such as Photographs and Clippings \(iX1300\)" \(page 274\)](#)
- ["Scanning Booklets or Documents with Overlapped Areas such as Envelopes \(iX1300\)" \(page 279\)](#)
- ["How to Remove a Jammed Document from iX1300" \(page 283\)](#)

Two Scanning Methods for iX1300

The ScanSnap has two scanning methods for different purposes. One is U-turn Scan, which is suitable for scanning multiple documents all at once, and the other is Return Scan, which allows you to scan thick documents such as plastic cards and booklets.

If you start scanning documents with the scanning method in which [Continuous scan] is set for the feeding method, you can scan documents with U-turn Scan and Return Scan alternatively.

For details about how to perform a scan, refer to ["Scanning Documents in Multiple Batches to Create a Single Scanned Image \(iX1300\)"](#) (page 242).

U-turn Scan

You can load multiple documents in one batch into the ScanSnap and scan them.

When you load documents in the ADF paper chute (cover) and scan them, the scanned documents are ejected onto the stacker. The stacker rises and the top part extends automatically when documents are scanned, and the stacker returns to the original place after scanning all the documents.

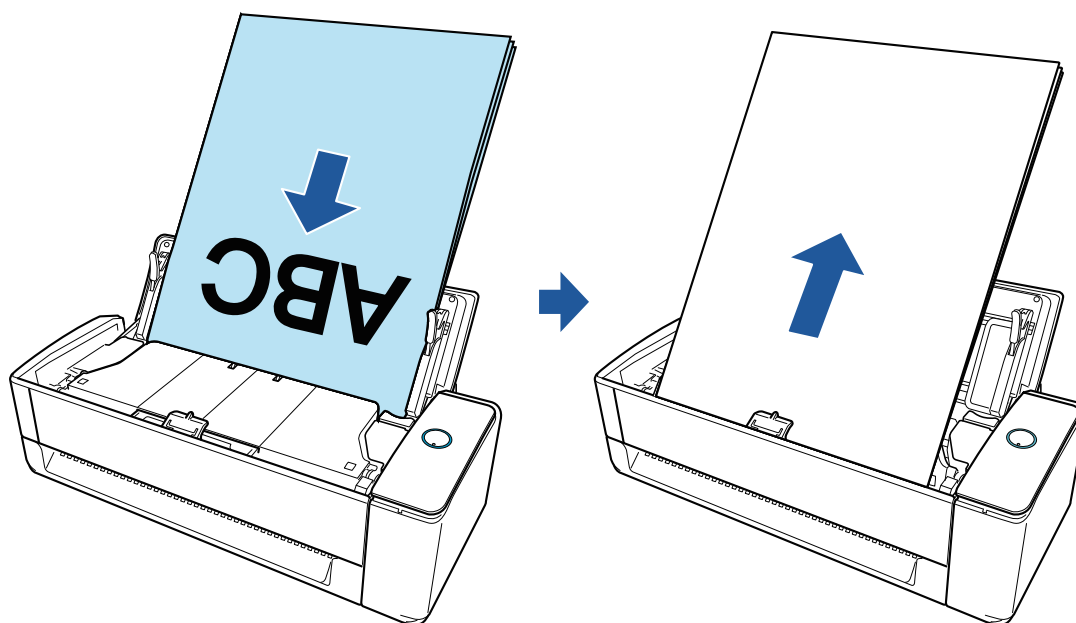

Return Scan

You can scan various documents such as office paper, post cards, business cards, and thick documents (e.g. plastic cards and booklets).

When you insert one document into the manual feeder at a time and scan it, the scanned document is ejected towards you from the same opening.

The optional Carrier Sheet is useful for protecting documents.

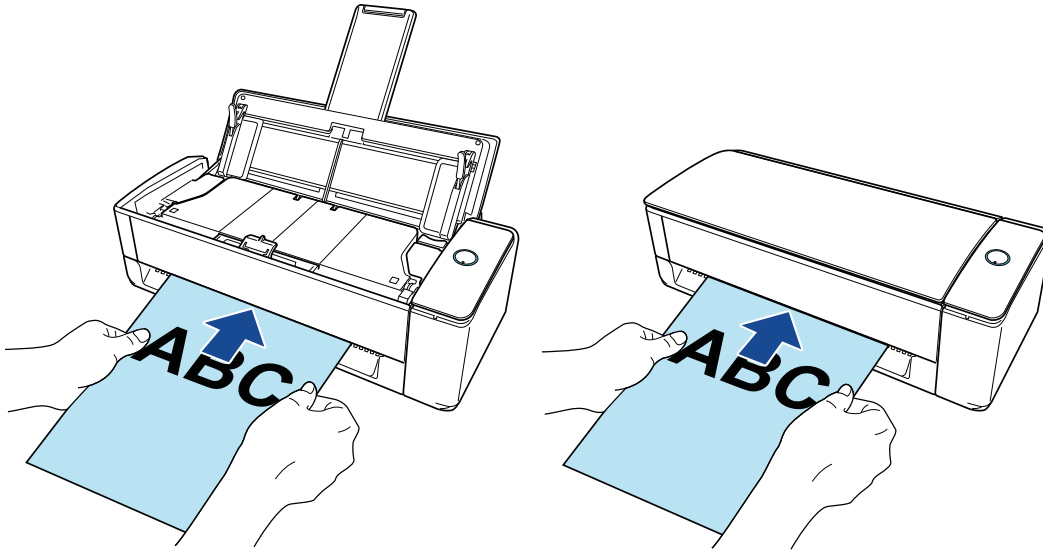

Documents to Scan (iX1300)

This section explains about the conditions for documents that can be loaded directly into the ScanSnap and the conditions for documents that can be scanned using the Carrier Sheet.

Documents That Can Be Loaded Directly into the ScanSnap

When loading a document directly in the ScanSnap, the conditions for documents that can be loaded vary depending on the scanning method.

For U-turn Scan

The conditions for documents that can be loaded in the ADF paper chute (cover) of the ScanSnap for scanning are as follows:

Document type	Office paper such as wood-free paper, wood-containing paper, and PPC paper (recycled paper)
Paper weight	<ul style="list-style-type: none"> ● 40 to 128 g/m² (11 to 34 lb) ● A6 or smaller size paper: 40 to 209 g/m² (11 to 56 lb) (*1) ● A8 or smaller size paper: 128 to 209 g/m² (34 to 56 lb) (*1)
Paper size	<p>Width 50.8 to 215.9 mm (2 to 8.5 in.)</p> <p>Length 50.8 to 355.6 mm (2 to 14 in.) For long page documents, up to 863 mm (34 in.)</p>

*1: For thick documents, inserting a document into the manual feeder and performing a scan is recommended.

For Return Scan

The conditions for documents that can be inserted into the manual feeder of the ScanSnap for scanning are as follows:

Document type	<ul style="list-style-type: none"> ● Office paper such as wood-free paper, wood-containing paper, and PPC paper (recycled paper) ● Plastic cards conforming to the ISO7810 ID-1 type (54 × 86 mm) ● Booklets
Paper weight	<ul style="list-style-type: none"> ● 20 to 413 g/m² (5.4 to 110 lb) ● Plastic cards: 1.4 mm (0.06 in.) or less (embossed cards can be used) ● Booklets: 2.0 mm (0.08 in.) or less
Paper size	<p>Width 50.8 to 215.9 mm (2 to 8.5 in.)</p> <p>Length 50.8 to 355.6 mm (2 to 14 in.)</p>

ATTENTION

- The following types of documents must not be scanned:

- Documents attached with the metals such as paper clips or staples that can damage the inside of the ScanSnap
Remove the metals for scanning.
- Documents on which the ink is still wet
Wait until the ink dries completely to scan these documents.
- Documents larger than 216 × 863 (mm)/8.5 × 34 (in.) (width × length)
- Documents other than paper such as fabric, metal foil and OHP film
- When you scan picture postcards, be aware that the picture side may get damaged. It is the responsibility of the customer to scan picture postcards.
- Be careful of the following when you scan plastic cards:
 - Cards that are bent may not be fed properly.
 - If the surface of the card is dirty with grease marks such as fingerprints, perform scanning after wiping the dirt off.
 - When you scan plastic cards with strong luster, some parts of the image may appear lighter or darker than the original.

Example: gold colored credit card
- When you scan embossed cards, put the embossed side down, and load the card in landscape orientation.
- If the embossed characters are not coated in gold or silver and the background color of the card and the color of the embossed characters are similar, it may be difficult for the ScanSnap to recognize embossed characters.

In which case, performing the following may result in an improvement.
 1. Click the [Option] button in the [Scanning] tab of the "ScanSnap Setup Window" (page 102).
⇒ The [Scanning mode option] window appears.
 2. Select the [Increase text contrast] checkbox.

Documents That Can Be Scanned Using the Carrier Sheet

The optional Carrier Sheet is a sheet designed to transport documents through the ScanSnap.

You can scan documents that are larger than A4/Letter size, photographs, and clippings.

The conditions for documents that can be placed in the Carrier Sheet for scanning using the manual feeder of the ScanSnap are as follows:



- Do not use a damaged Carrier Sheet. Otherwise, it may damage or cause the ScanSnap to malfunction.
- Be careful not to cut your finger on the edge of the Carrier Sheet.

Document type	Documents that cannot be loaded directly into the ScanSnap
Paper weight	Up to 209 g/m ² (56 lb)
	When scanning documents folded in half:
	Up to 105 g/m ² (28 lb)

Paper size	Carrier Sheet size (216 × 297 mm) A3 (297 × 420 mm) (*1) A4 (210 × 297 mm) A5 (148 × 210 mm) A6 (105 × 148 mm) B4 (257 × 364 mm) (*1) B5 (182 × 257 mm) B6 (128 × 182 mm) Postcard (100 × 148 mm) Business card (90 × 55 mm, 55 × 90 mm) Letter (8.5 × 11 in., 216 × 279.4 mm) 11 × 17 in. (279.4 × 431.8 mm) (*1) Custom size Width: 25.4 to 216 mm (1 to 8.5 in.) Length: 25.4 to 297 mm (1 to 11.69 in.)
-------------------	--

*1: Fold in half to scan.

Documents for Which the Carrier Sheet is Recommended for Scanning

It is recommended that you use the Carrier Sheet to scan the following documents.

- Documents written in pencil

Because there may be black traces left on the documents, it is recommended that you use the Carrier Sheet to scan such documents.

When you scan such documents directly without using a Carrier Sheet, dirt will accumulate on the rollers, which may cause feeding errors. Clean the rollers occasionally.

For details about how to perform cleaning, refer to "[Cleaning the Inside of iX1300](#)" (page 519).

- Carbonless paper

Because carbonless paper may contain chemicals that can harm the ScanSnap internal rollers, it is recommended that you use the Carrier Sheet to scan such documents.

Make sure to clean the rollers occasionally to maintain the scanner performance when scanning carbonless paper directly without using the Carrier Sheet. For details about how to perform cleaning, refer to "[Cleaning the Inside of iX1300](#)" (page 519).

Depending on the type of carbonless paper, the life span of the scanner may be shortened compared to scanning office paper.

- Scanning the following types of documents without using the Carrier Sheet can result in documents being damaged or scanned incorrectly

- Documents smaller than 50.8 × 50.8 (mm)/2 × 2 (in.) (width × length)
- Documents whose paper weight is less than 40 g/m² (10.7 lb)
- Documents with an uneven surface (such as envelopes and paper sheets with attached materials)
- Wrinkled or curled documents
- Folded or torn documents
- Tracing paper
- Coated paper
- Photographs (photographic paper)
- Perforated or punched documents
- Documents that are not rectangular or square

- Carbon paper or thermal paper
- Documents with memo papers or sticky notes attached

ATTENTION

- Using the Carrier Sheet

Be careful of the following when you use the Carrier Sheet:

- Do not stain, or cut the black and white patterned end of the Carrier Sheet. Otherwise, the Carrier Sheet will not be recognized properly.
- Do not place the Carrier Sheet upside down. Otherwise, a paper jam may occur and damage the Carrier Sheet and the document inside.
- Do not fold or pull the Carrier Sheet.
- Paper jams may occur when several small size documents such as photographs and postcards are placed inside the Carrier Sheet to be scanned at once. It is recommended that you scan such documents one at a time.
- If paper jams occur frequently, feed about 50 sheets of PPC paper (recycled paper) before scanning with the Carrier Sheet. The PPC paper can either be blank or printed.

- Storing the Carrier Sheet

Be careful of the following when you store the Carrier Sheet:

- Do not leave your document inside the Carrier Sheet for a long time. Otherwise, the ink on the document may be transferred onto the Carrier Sheet.
- Do not leave the Carrier Sheet in high temperature places such as under direct sunlight or near a heating apparatus for a long time. Also, do not use the Carrier Sheet in high temperature places. The Carrier Sheet may be deformed.
- To avoid deformation, store the Carrier Sheet on a flat surface without any weight on it.

Scanning Documents (iX1300)

You can load documents such as handouts for meetings or business cards directly in the ScanSnap for scanning.

For details about documents that can be scanned, refer to ["Documents to Scan \(iX1300\)"](#) (page 231).

1. Hold the right side of the ADF paper chute (cover) of the ScanSnap then open it or press the [Scan] button to turn it on.

Open the ADF paper chute (cover) fully so that the [Scan] button lights up in blue.

When the ADF paper chute (cover) is opened, the extension will rise automatically.

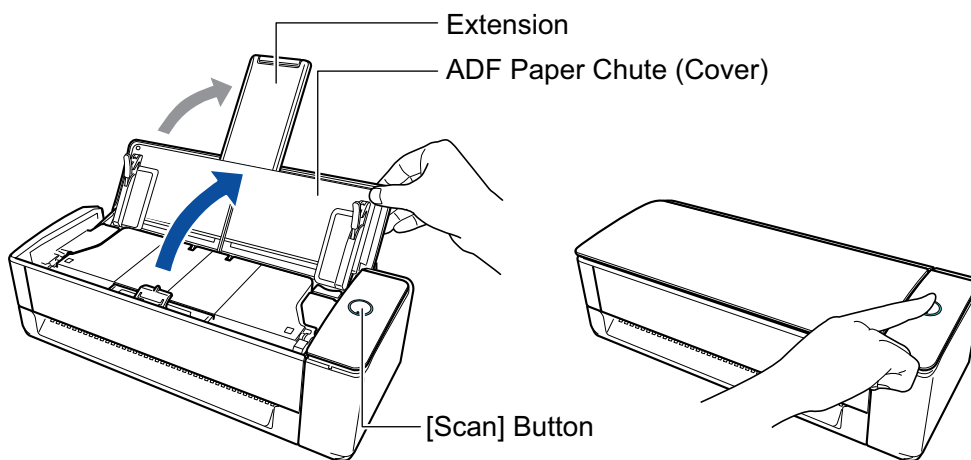

⇒ The ScanSnap Manager icon in the notification area located at the far right of the taskbar

changes from  to .

2. Specify the feeding method if needed.

1. Right-click the ScanSnap Manager icon  in the notification area located at the far right of the taskbar, and select the [Scan Button Settings] from the ["Right-Click Menu"](#) (page 100).

⇒ The ScanSnap setup window appears.

2. Click the [Feed option] button in the [Scanning] tab.

⇒ The [Feed option] window appears.

3. Select the feeding method for [Feed] in [ADF] or [Manual feeder].

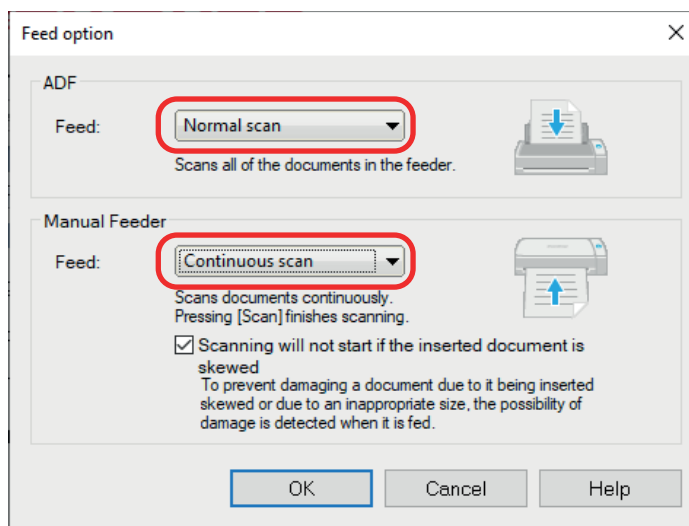

ADF

For [Feed], select the feeding method for **U-turn Scan** (which is the scanning method used when loading documents in the ADF paper chute (cover)).

[Normal scan] is selected by default.

Feed

- Normal scan

When all of documents loaded in the ADF paper chute (cover) are scanned, scanning is complete automatically and the Quick Menu appears.

- Continuous scan

Scans documents continuously in multiple batches.

To scan documents more than the amount that can be loaded in the ADF paper chute (cover) on the ScanSnap, select [Continuous scan].

If you scan documents after the first scan, you can use the ADF paper chute (cover) or the manual feeder for scanning.

Manual feeder

For [Feed], select the feeding method for **Return Scan** (which is the scanning method that is used when inserting a document into the manual feeder).

[Continuous scan] is selected by default.

Feed

- Normal scan

When a document inserted into the manual feeder of the ScanSnap is scanned, scanning is complete automatically.

- Continuous scan

Scans documents continuously in multiple batches.

If you scan documents after the first scan, you can use the ADF paper chute (cover) or the manual feeder for scanning.

[Scanning will not start if the inserted document is skewed] checkbox

Selecting this checkbox displays a message and cancels scanning if a skewed document is inserted into the manual feeder of the ScanSnap.

Selecting this option reduces damage to documents caused by feeding them skewed.

Depending on the skew or size of documents, some errors may not be detected.

This checkbox is selected by default.

4. Click the [OK] button.
5. Click the [OK] button to close the ScanSnap setup window.

3. Load documents in the ADF paper chute (cover) or insert a document into the manual feeder.

- When scanning documents all at once (U-turn Scan)
 1. If you are loading multiple sheets, check the number of sheets.

The maximum number of sheets in the ScanSnap is as follows:

For A4 or smaller sizes: Up to 20 sheets can be loaded (with paper weight of 80 g/m² [20 lb] and thickness of the document stack under 2 mm [0.08 in.]).

ATTENTION

If you try to scan more than the maximum amount that can be loaded, the following problems may occur:

- Files cannot be properly created due to excessive file size.
- Paper jams occur during scanning.

2. Fan the documents.
 1. Hold both ends of the documents and fan them a few times.

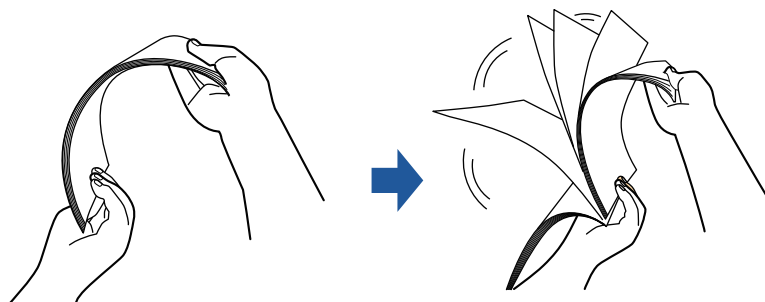

2. Rotate the documents by 90 degrees and fan them in the same manner.
3. Straighten the edges of the documents and slightly displace the top edges at an angle.

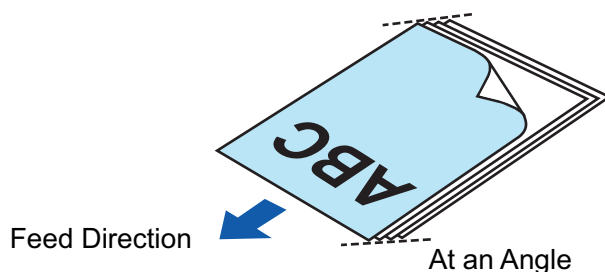

ATTENTION

Paper jams or damage to documents may occur if you scan the documents without aligning the edges first.

4. Load documents in the ADF paper chute (cover).

Load the document face-up and head-first with the front facing you (when loading multiple documents, the first page is on the top).

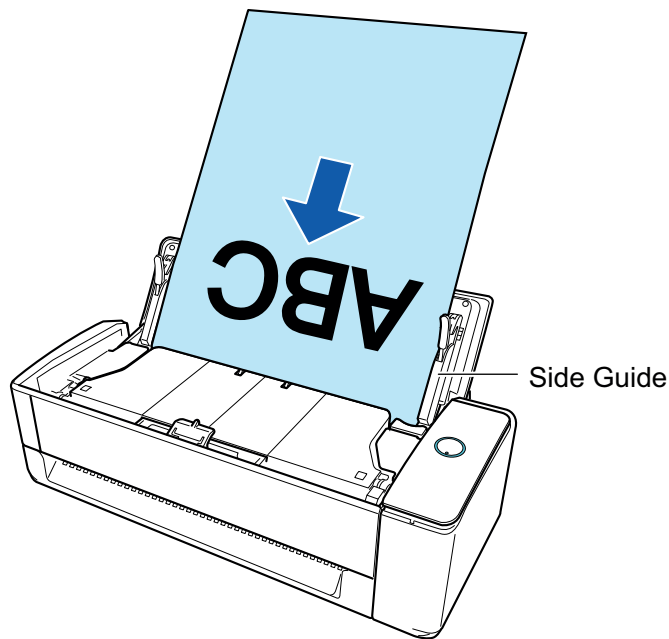

5. Align the side guides with both ends of the documents.

Hold each side guide in the middle to adjust them. When there is a space between the side guides and the documents, the documents may be fed skewed.

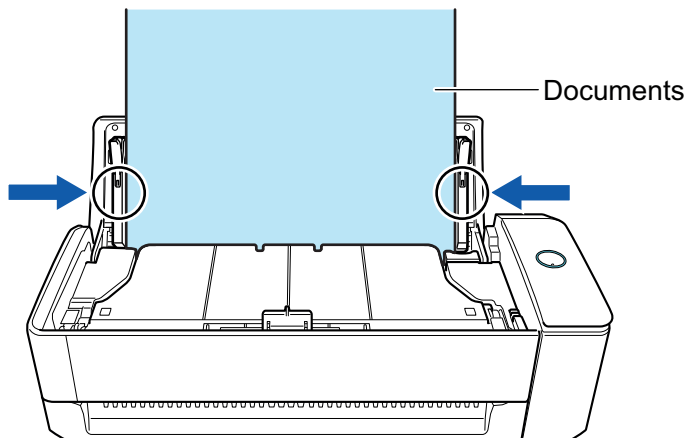

ATTENTION

- Make sure that the document support tab is open. Otherwise, a paper jam may occur. If the document support tab is closed, pull it up with your fingers.

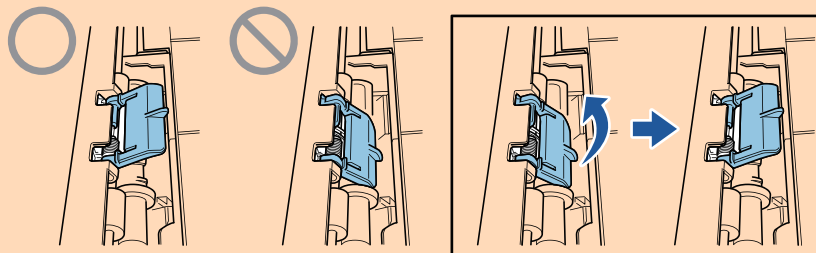

- If the document support tab comes off, refer to "Customer Support" in ["About Customer Support and Maintenance"](#) (page 606) to inquire about the problem.

- When scanning documents one by one (Return Scan)

Insert a document into the manual feeder.

Face the front side of a document upwards and insert the top end of the document straight into the middle of the manual feeder.

Make sure that the document is fed into the ScanSnap and is held firmly.

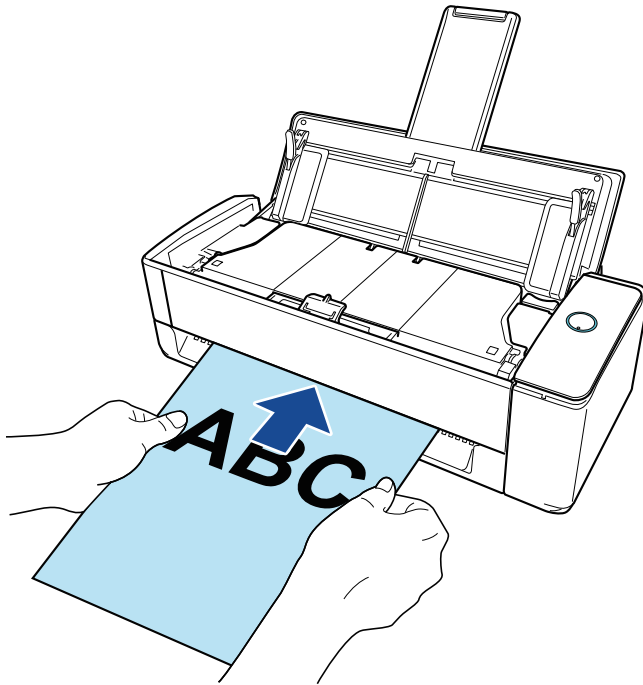

ATTENTION

When you scan a document, the document comes out from the back of the ScanSnap. Leave space (about the length of the document) at the back of the ScanSnap.

HINT

You can scan a document with the ADF paper chute (cover) closed.

4. Press the [Scan] button on the ScanSnap to start a scan.

ATTENTION

- If a document is inserted into the manual feeder in a skewed way, the message "The inserted document is skewed. If the document is scanned in the current condition, it may be damaged." may be displayed.

Remove the document, insert the top of the document into the center of the manual feeder in a straight direction, and then click the [Continue Scanning] button or press the [Scan] button on the ScanSnap.

To prevent the message from being displayed, clear the [Scanning will not start if the inserted document is skewed] checkbox in the [Feed option] window.

- In the following cases, the message "Documents have been loaded in the ADF paper chute (cover) and inserted into the manual feeder at the same time." is displayed.
 - Pressing the [Scan] button on the ScanSnap while documents are loaded in the ADF paper chute (cover) and a document is inserted into the manual feeder at the same time
Remove either of the documents and then click the [Continue Scanning] button or press the [Scan] button on the ScanSnap.
 - A document getting jammed in the ScanSnap

Refer to "[How to Remove a Jammed Document from iX1300](#)" (page 283) to remove the jammed document.

Load documents in the ADF paper chute (cover) or insert a document into the manual feeder again and then click the [Continue Scanning] button or press the [Scan] button on the ScanSnap.

- A document cannot be inserted into the manual feeder during U-turn Scan.
- When there are no documents in either the ADF paper chute (cover) or manual feeder, the message "Documents have not been loaded in the ADF paper chute (cover) or inserted into the Manual Feeder." is displayed. Load documents in the ADF paper chute (cover) or insert a document into the manual feeder and then click the [Continue Scanning] button or press the [Scan] button on the ScanSnap.
- Do not perform the following operations during scanning. Doing so will stop scanning.
 - Connect or disconnect the ScanSnap and other USB devices.
 - Close the ADF paper chute (cover).
 - Switch users.
 - Allow the computer to enter sleep mode.

⇒ The [Scan] button on the ScanSnap flashes in blue while the documents are being scanned.

The [ScanSnap Manager - Image scanning and file saving] window appears.

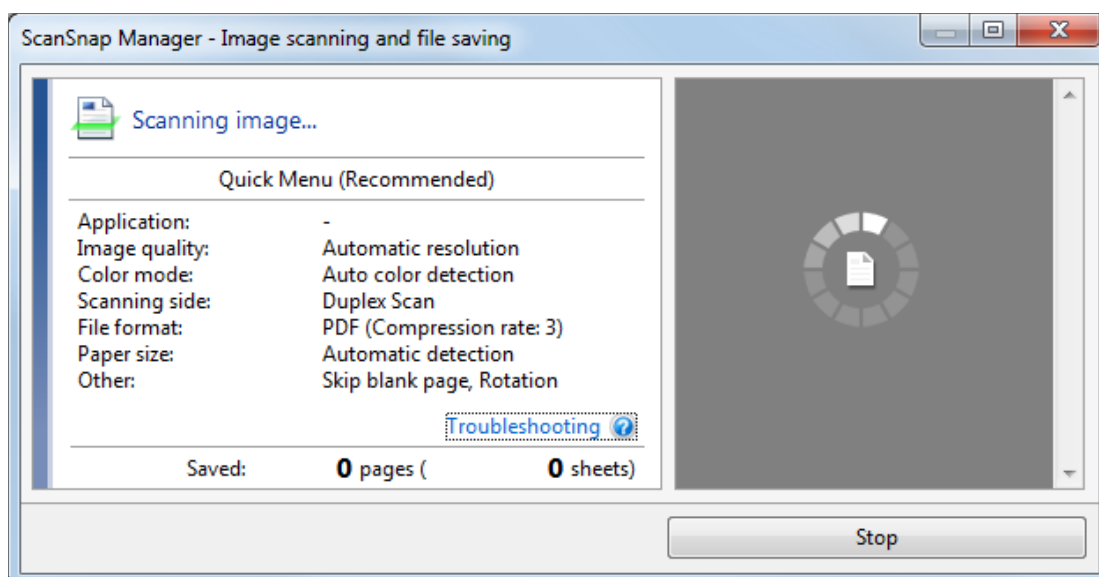

After scanning is complete, if the message "Load the next document." is displayed on the [ScanSnap Manager - Image scanning and file saving] window, you can continue scanning by loading documents and clicking the [Continue Scanning] button or pressing the [Scan] button on the ScanSnap.

When the document is inserted into the manual feeder, scanning starts automatically.

5. Click the [Finish Scanning] button in the [ScanSnap Manager - Image scanning and file saving] window or press the [Scan] button on the ScanSnap without loading any more documents in the ScanSnap.

⇒ Scanning is complete and the Quick Menu appears.

6. In the Quick Menu, click the icon of the application to link with ScanSnap Manager.

For details about linking the following applications with ScanSnap Manager, refer to "[Useful Usages](#)" (page 439).

- Save Documents
- Save Business Cards
- Save Receipts
- Save Photos

HINT

The following applications are displayed in the Quick Menu when ScanSnap Organizer and CardMinder are installed.

- When ScanSnap Organizer is installed
ScanSnap Organizer
- When CardMinder is installed
CardMinder

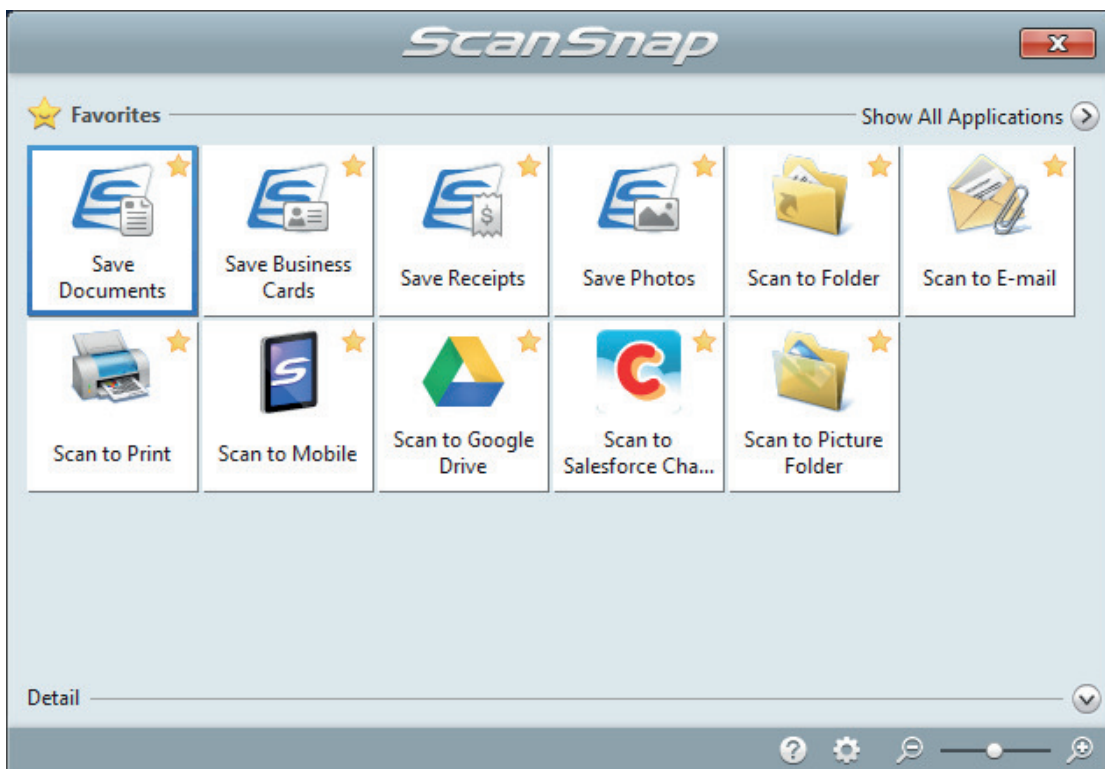

⇒ The selected application starts up. For details, refer to the Advanced Operation Guide.

ATTENTION

- You cannot start scanning when the Quick Menu is displayed. Either select an icon from the Quick Menu and finish the process, or close the Quick Menu before you perform the next scan.
- Do not move, delete, or rename scanned images using other applications while the Quick Menu is displayed.

HINT

- Clicking  displays the description of an application. Placing the mouse cursor over the icon of another application displays the description of the application.
- Performing a scan while an application that can be automatically linked with is active automatically starts the linkage between ScanSnap Manager and the application.
For details, refer to the Advanced Operation Guide.

Scanning Documents in Multiple Batches to Create a Single Scanned Image (iX1300)

When you scan documents more than the amount that can be loaded in the ADF paper chute (cover) on the ScanSnap, if you divide the documents in multiple batches and scan them continuously, you can create a single scanned image that contains all of the documents.

1. Hold the right side of the ADF paper chute (cover) of the ScanSnap then open it or press the [Scan] button to turn it on.

Open the ADF paper chute (cover) fully so that the [Scan] button lights up in blue.

When the ADF paper chute (cover) is opened, the extension will rise automatically.

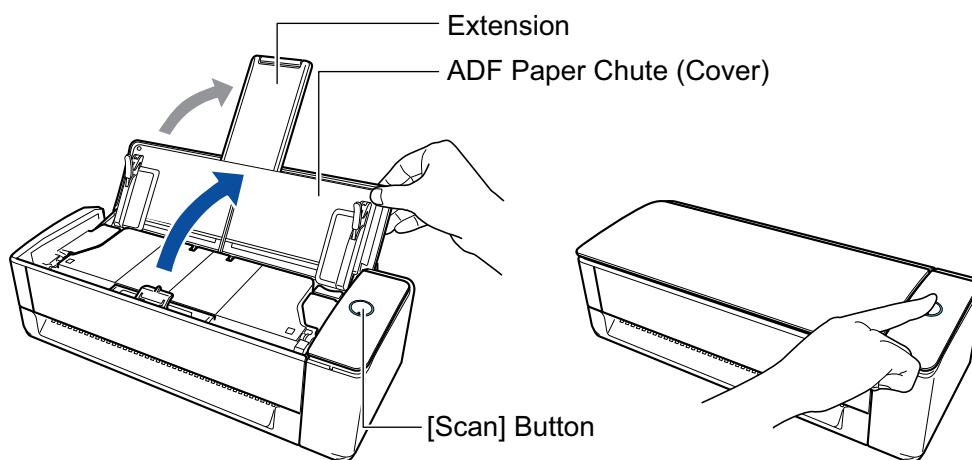

⇒ The ScanSnap Manager icon in the notification area located at the far right of the taskbar

changes from  to .

2. Specify the feeding method.

1. Right-click the ScanSnap Manager icon  in the notification area located at the far right of the taskbar, and select the [Scan Button Settings] from the "Right-Click Menu" (page 100).

⇒ The ScanSnap setup window appears.

2. Click the [Feed option] button in the [Scanning] tab.

⇒ The [Feed option] window appears.

3. Select [Continuous scan] for [Feed] in [ADF] or [Manual feeder].

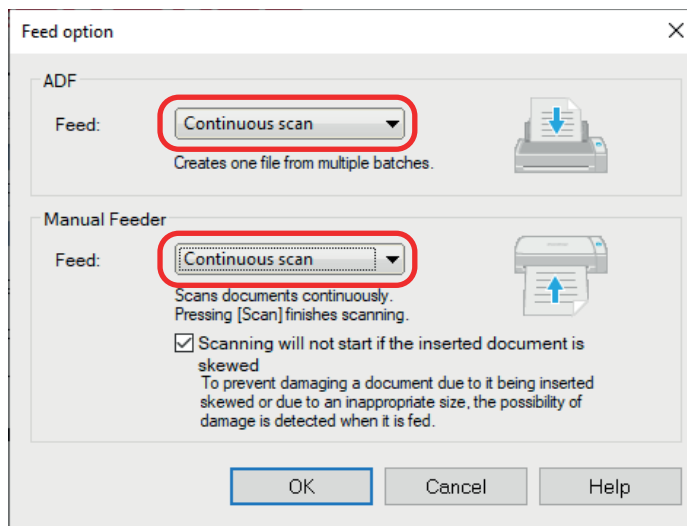

ADF

For [Feed], select the feeding method for **U-turn Scan** (which is the scanning method used when loading documents in the ADF paper chute (cover)).

[Normal scan] is selected by default.

Feed

- Normal scan

When all of documents loaded in the ADF paper chute (cover) are scanned, scanning is complete automatically and the Quick Menu appears.

- Continuous scan

Scans documents continuously in multiple batches.

To scan documents more than the amount that can be loaded in the ADF paper chute (cover) on the ScanSnap, select [Continuous scan].

If you scan documents after the first scan, you can use the ADF paper chute (cover) or the manual feeder for scanning.

Manual feeder

For [Feed], select the feeding method for **Return Scan** (which is the scanning method that is used when inserting a document into the manual feeder).

[Continuous scan] is selected by default.

Feed

- Normal scan

When a document inserted into the manual feeder of the ScanSnap is scanned, scanning is complete automatically.

- Continuous scan

Scans documents continuously in multiple batches.

If you scan documents after the first scan, you can use the ADF paper chute (cover) or the manual feeder for scanning.

[Scanning will not start if the inserted document is skewed] checkbox

Selecting this checkbox displays a message and cancels scanning if a skewed document is inserted into the manual feeder of the ScanSnap.

Selecting this option reduces damage to documents caused by feeding them skewed.

Depending on the skew or size of documents, some errors may not be detected.

This checkbox is selected by default.

4. Click the [OK] button.
5. Click the [OK] button to close the ScanSnap setup window.

3. Load documents in the ADF paper chute (cover) or insert a document into the manual feeder.

- When scanning documents all at once (U-turn Scan)
 1. If you are loading multiple sheets, check the number of sheets.

The maximum number of sheets in the ScanSnap is as follows:

For A4 or smaller sizes: Up to 20 sheets can be loaded (with paper weight of 80 g/m² [20 lb] and thickness of the document stack under 2 mm [0.08 in.]).

ATTENTION

If you try to scan more than the maximum amount that can be loaded, the following problems may occur:

- Files cannot be properly created due to excessive file size.
- Paper jams occur during scanning.

2. Fan the documents.
 1. Hold both ends of the documents and fan them a few times.

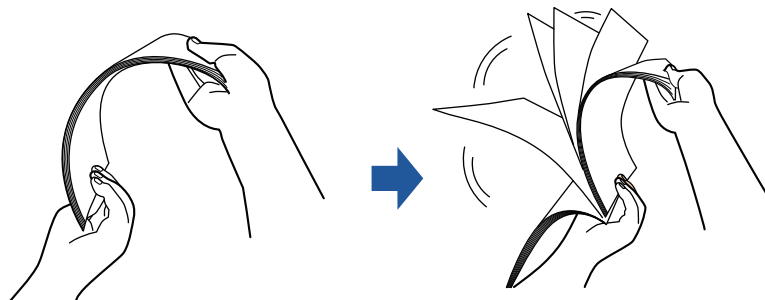

2. Rotate the documents by 90 degrees and fan them in the same manner.
3. Straighten the edges of the documents and slightly displace the top edges at an angle.

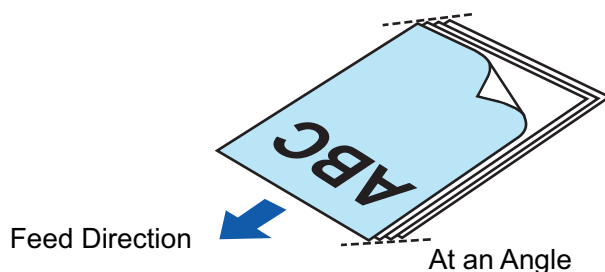

ATTENTION

Paper jams or damage to documents may occur if you scan the documents without aligning the edges first.

4. Load documents in the ADF paper chute (cover).

Load the document face-up and head-first with the front facing you (when loading multiple documents, the first page is on the top).

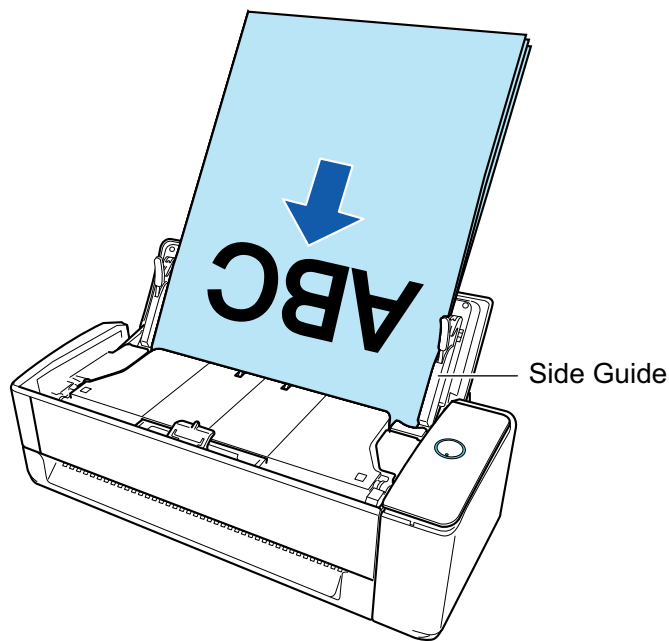

5. Align the side guides with both ends of the documents.

Hold each side guide in the middle to adjust them. When there is a space between the side guides and the documents, the documents may be fed skewed.

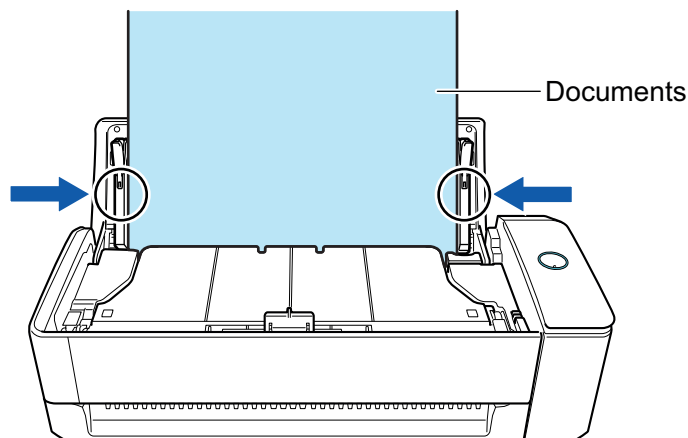

ATTENTION

- Make sure that the document support tab is open. Otherwise, a paper jam may occur. If the document support tab is closed, pull it up with your fingers.

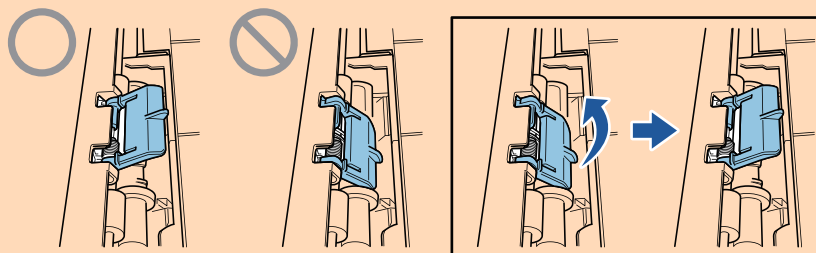

- If the document support tab comes off, refer to "Customer Support" in ["About Customer Support and Maintenance"](#) (page 606) to inquire about the problem.

- When scanning documents one by one (Return Scan)

Insert a document into the manual feeder.

Face the front side of a document upwards and insert the top end of the document straight into the middle of the manual feeder.

Make sure that the document is fed into the ScanSnap and is held firmly.

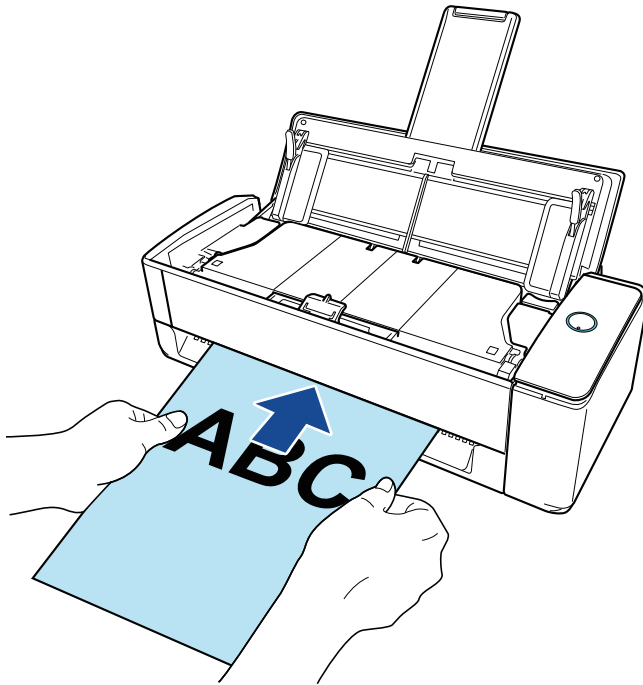

ATTENTION

When you scan a document, the document comes out from the back of the ScanSnap. Leave space (about the length of the document) at the back of the ScanSnap.

HINT

You can scan a document with the ADF paper chute (cover) closed.

4. Press the [Scan] button on the ScanSnap to start a scan.

ATTENTION

- If a document is inserted into the manual feeder in a skewed way, the message "The inserted document is skewed. If the document is scanned in the current condition, it may be damaged." may be displayed.

Remove the document, insert the top of the document into the center of the manual feeder in a straight direction, and then click the [Continue Scanning] button or press the [Scan] button on the ScanSnap.

To prevent the message from being displayed, clear the [Scanning will not start if the inserted document is skewed] checkbox in the [Feed option] window.

- In the following cases, the message "Documents have been loaded in the ADF paper chute (cover) and inserted into the manual feeder at the same time." is displayed.
 - Pressing the [Scan] button on the ScanSnap while documents are loaded in the ADF paper chute (cover) and a document is inserted into the manual feeder at the same time
Remove either of the documents and then click the [Continue Scanning] button or press the [Scan] button on the ScanSnap.
 - A document getting jammed in the ScanSnap

Refer to "How to Remove a Jammed Document from iX1300" (page 283) to remove the jammed document.

Load documents in the ADF paper chute (cover) or insert a document into the manual feeder again and then click the [Continue Scanning] button or press the [Scan] button on the ScanSnap.

- A document cannot be inserted into the manual feeder during U-turn Scan.
- When there are no documents in either the ADF paper chute (cover) or manual feeder, the message "Documents have not been loaded in the ADF paper chute (cover) or inserted into the Manual Feeder." is displayed. Load documents in the ADF paper chute (cover) or insert a document into the manual feeder and then click the [Continue Scanning] button or press the [Scan] button on the ScanSnap.
- Do not perform the following operations during scanning. Doing so will stop scanning.
 - Connect or disconnect the ScanSnap and other USB devices.
 - Close the ADF paper chute (cover).
 - Switch users.
 - Allow the computer to enter sleep mode.

⇒ The [Scan] button on the ScanSnap flashes in blue while the documents are being scanned.

The [ScanSnap Manager - Image scanning and file saving] window appears.

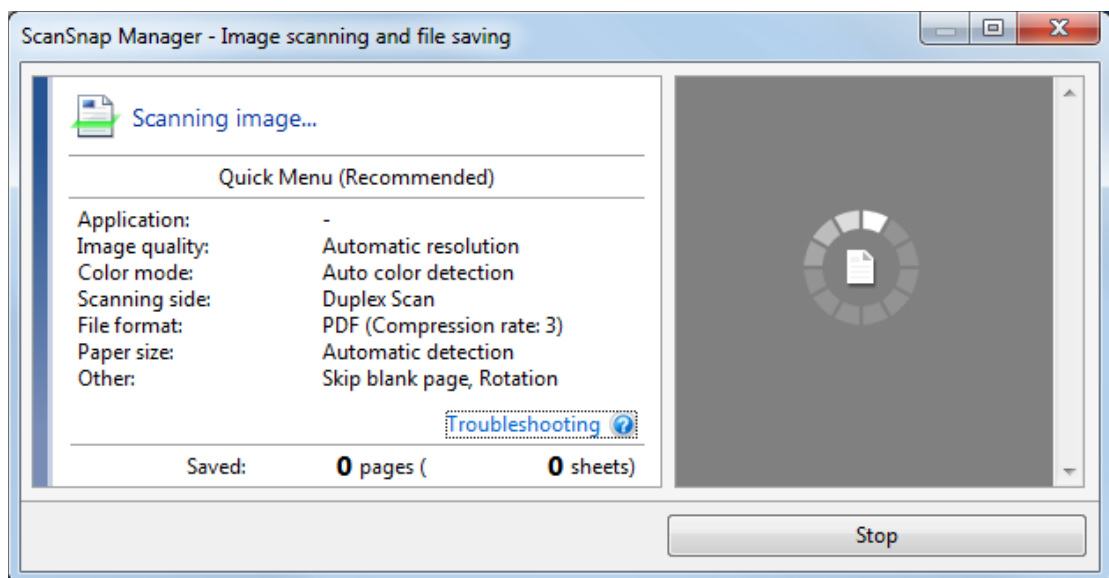

- 5.** After scanning is complete, load the next documents in the ADF paper chute (cover) on the ScanSnap and click the [Continue Scanning] button in the [ScanSnap Manager - Image scanning and file saving] window or press the [Scan] button on the ScanSnap.

Repeat step 5 until all documents are scanned.

For details about how to load documents or insert a document, refer to step 3.

When the document is inserted into the manual feeder, scanning starts automatically.

- 6.** Click the [Finish Scanning] button in the [ScanSnap Manager - Image scanning and file saving] window or press the [Scan] button on the ScanSnap without loading any more documents in the ScanSnap.

⇒ Scanning is complete and the Quick Menu appears.

7. In the Quick Menu, click the icon of the application to link with ScanSnap Manager.

For details about linking the following applications with ScanSnap Manager, refer to "Useful Usages" (page 439).

- Save Documents
- Save Business Cards
- Save Receipts
- Save Photos

HINT

The following applications are displayed in the Quick Menu when ScanSnap Organizer and CardMinder are installed.

- When ScanSnap Organizer is installed
ScanSnap Organizer
- When CardMinder is installed
CardMinder

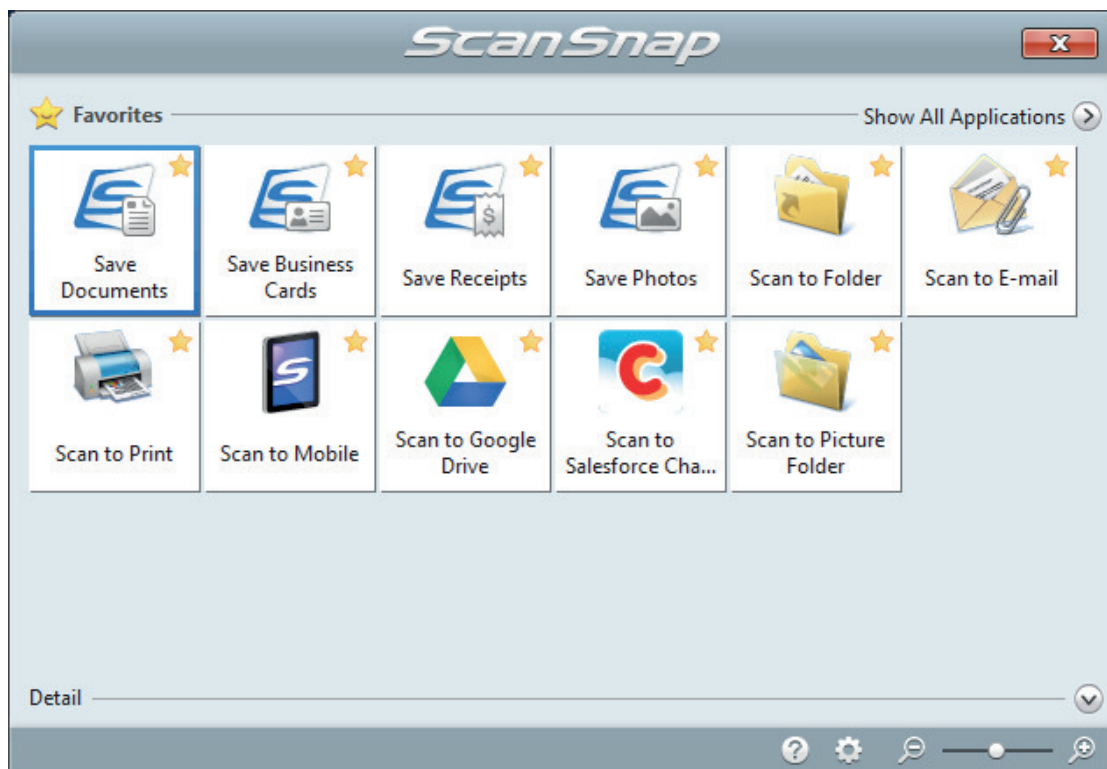

⇒ The selected application starts up. For details, refer to the Advanced Operation Guide.

ATTENTION

- You cannot start scanning when the Quick Menu is displayed. Either select an icon from the Quick Menu and finish the process, or close the Quick Menu before you perform the next scan.
- Do not move, delete, or rename scanned images using other applications while the Quick Menu is displayed.

HINT

- Clicking  displays the description of an application. Placing the mouse cursor over the icon of another application displays the description of the application.

- Performing a scan while an application that can be automatically linked with is active automatically starts the linkage between ScanSnap Manager and the application.
For details, refer to the Advanced Operation Guide.

Scanning Long Pages (iX1300)

Documents up to 863 mm (34 in.) in length can be scanned.

ATTENTION

Scanning long page documents is only available for **U-turn Scan**, in which a document is loaded in the ADF paper chute (cover) and scanned.

For details about documents that can be scanned with U-turn Scan, refer to "[Documents to Scan \(iX1300\)](#)" (page 231) in the ScanSnap Help.

HINT

For details about how to load documents that are 360 mm (14.17 in.) or less in length, refer to "[Scanning Documents \(iX1300\)](#)" (page 235).

1. Hold the right side of the ADF paper chute (cover) of the ScanSnap then open it to turn the power on.

Open the ADF paper chute (cover) fully so that the [Scan] button lights up in blue.

When the ADF paper chute (cover) is opened, the extension will rise automatically.

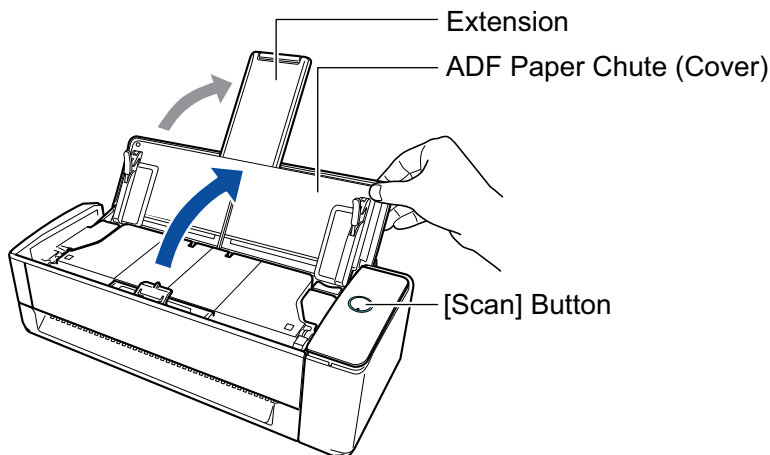

⇒ The ScanSnap Manager icon in the notification area located at the far right of the taskbar

changes from  to .

2. Specify the feeding method if needed.

1. Right-click the ScanSnap Manager icon  in the notification area located at the far right of the taskbar, and select the [Scan Button Settings] from the "[Right-Click Menu](#)" (page 100).

⇒ The ScanSnap setup window appears.

2. Click the [Feed option] button in the [Scanning] tab.

⇒ The [Feed option] window appears.

3. Select the feeding method for [Feed] in [ADF].

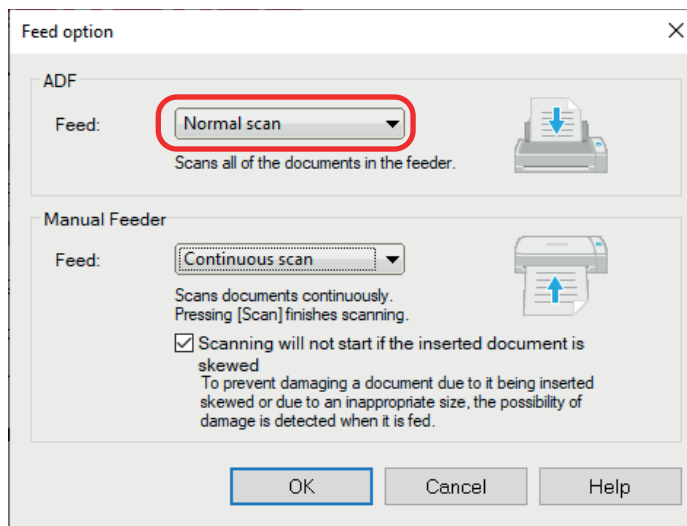

ADF

For [Feed], select the feeding method for **U-turn Scan** (which is the scanning method used when loading documents in the ADF paper chute (cover)).

[Normal scan] is selected by default.

Feed

- Normal scan

When all of documents loaded in the ADF paper chute (cover) are scanned, scanning is complete automatically and the Quick Menu appears.

- Continuous scan

Scans documents continuously in multiple batches.

To scan documents more than the amount that can be loaded in the ADF paper chute (cover) on the ScanSnap, select [Continuous scan].

If you scan documents after the first scan, you can use the ADF paper chute (cover) or the manual feeder for scanning.

4. Click the [OK] button.
5. Click the [OK] button to close the ScanSnap setup window.

3. Load only one document in the ADF paper chute (cover).

Hold the document with your hand so that it does not fall out of the ADF paper chute (cover).

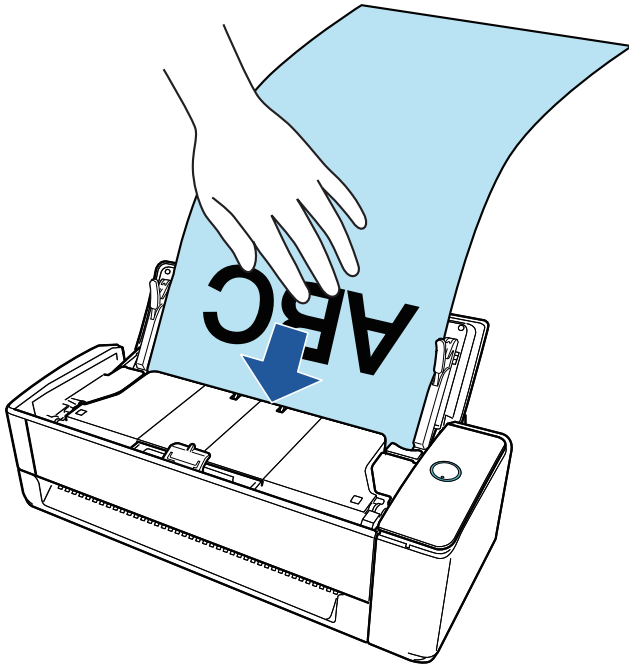

4. Align the side guides with both ends of the document.

Hold each side guide in the middle to adjust them. When there is a space between the side guides and the document, the document may be fed skewed.

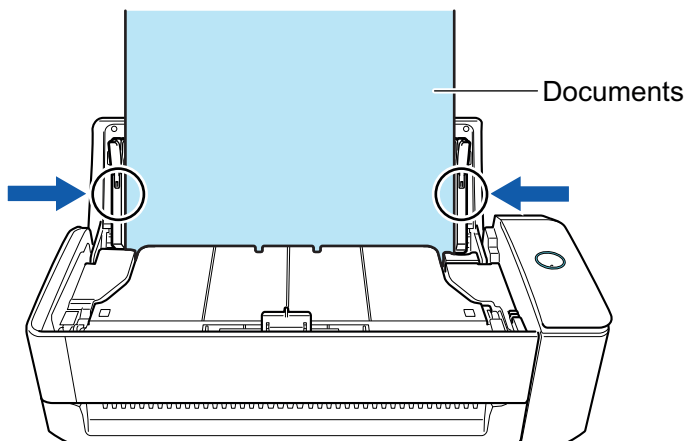

ATTENTION

- Make sure that the document support tab is open. Otherwise, a paper jam may occur. If the document support tab is closed, pull it up with your fingers.

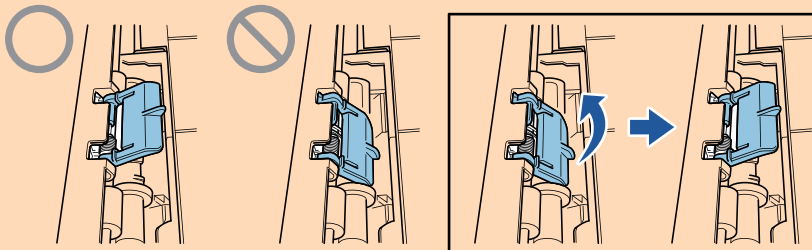

- If the document support tab comes off, refer to "Customer Support" in ["About Customer Support and Maintenance"](#) (page 606) to inquire about the problem.

- 5. Press the [Scan] button on the ScanSnap (for three seconds or longer) until the button flashes in blue to start a scan.**

ATTENTION

- When scanning a long page document, give support to the document in a way that prevents it from being fed skewed into the ScanSnap. If the document is fed skewed into the ScanSnap, it may be damaged.

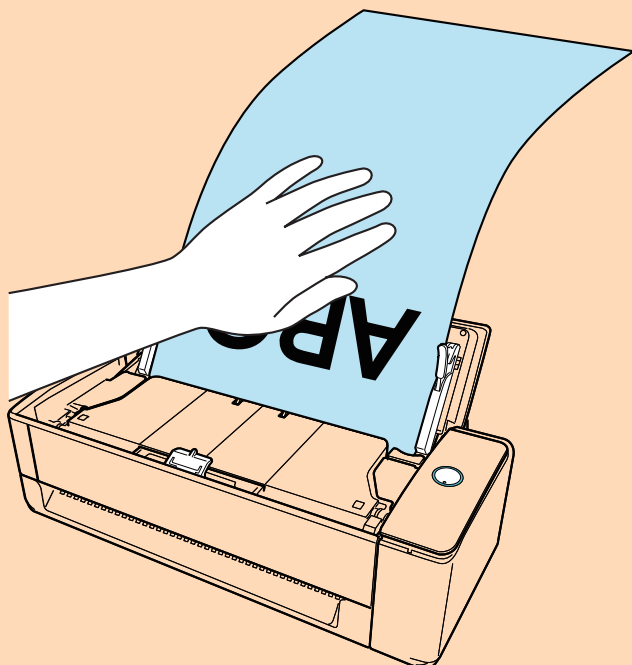

- In the following cases, the message "Documents have been loaded in the ADF paper chute (cover) and inserted into the manual feeder at the same time." is displayed.
 - Pressing the [Scan] button on the ScanSnap while documents are loaded in the ADF paper chute (cover) and a document is inserted into the manual feeder at the same time
Remove the document from the manual feeder and then click the [Continue Scanning] button or press the [Scan] button on the ScanSnap.
 - A document getting jammed in the ScanSnap
Refer to "[How to Remove a Jammed Document from iX1300](#)" (page 283) to remove the jammed document.
Load documents in the ADF paper chute (cover) or insert a document into the manual feeder again and then click the [Continue Scanning] button or press the [Scan] button on the ScanSnap.
- A document cannot be inserted into the manual feeder during U-turn Scan.
- When there are no documents in either the ADF paper chute (cover) or manual feeder, the message "Documents have not been loaded in the ADF paper chute (cover) or inserted into the Manual Feeder." is displayed. Load documents in the ADF paper chute (cover) and then click the [Continue Scanning] button or press the [Scan] button on the ScanSnap.
- Do not perform the following operations during scanning. Doing so will stop scanning.
 - Connect or disconnect the ScanSnap and other USB devices.
 - Close the ADF paper chute (cover).
 - Switch users.
 - Allow the computer to enter sleep mode.

HINT

When you scan the first page as a long page and continue scanning, the subsequent documents are also scanned as long pages.

- ⇒ The [Scan] button on the ScanSnap flashes in blue while the documents are being scanned.

In addition, the [ScanSnap Manager - Image scanning and file saving] window appears on the computer.

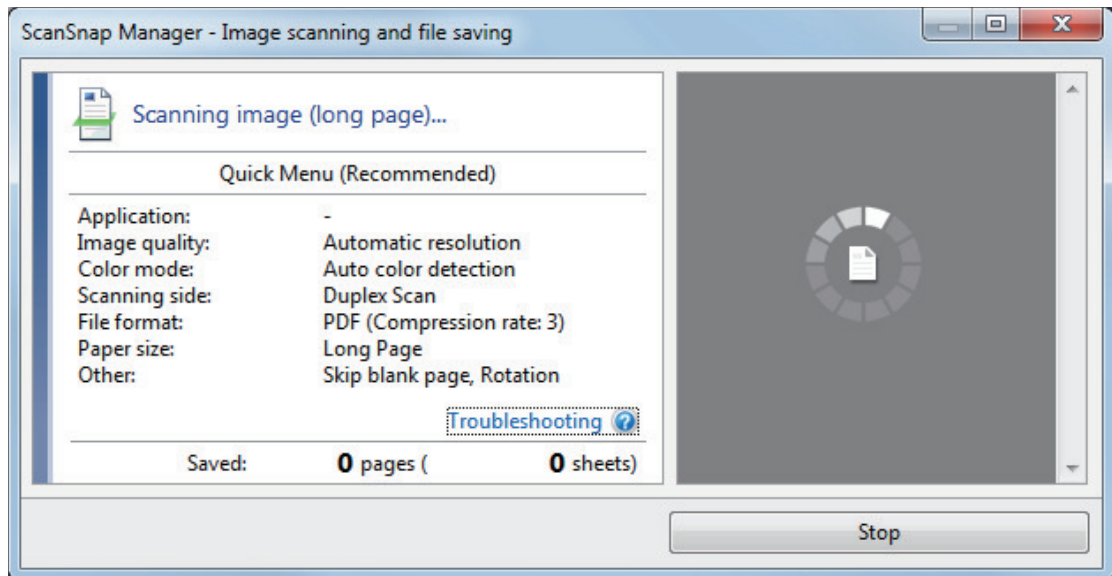

After scanning is complete, if the message "Load the next document." is displayed on the [ScanSnap Manager - Image scanning and file saving] window, you can continue scanning by loading documents and clicking the [Continue Scanning] button or pressing the [Scan] button on the ScanSnap.

6. Click the [Finish Scanning] button in the [ScanSnap Manager - Image scanning and file saving] window or press the [Scan] button on the ScanSnap without loading any more documents in the ScanSnap.

- ⇒ Scanning is complete and the Quick Menu appears.

7. In the Quick Menu, click the icon of the application to link with ScanSnap Manager.

When you select [Save Documents], you can manage scanned images by folder with ScanSnap Home.

For details, refer to "[Managing Paper Documents by Folder on a Computer with ScanSnap Home](#)" (page 440).

HINT

[ScanSnap Organizer] is displayed in the Quick Menu when ScanSnap Organizer is installed.

To manage scanned images by folder with ScanSnap Organizer, refer to "[Managing Paper Documents by Folder on a Computer with ScanSnap Organizer](#)" (page 443).

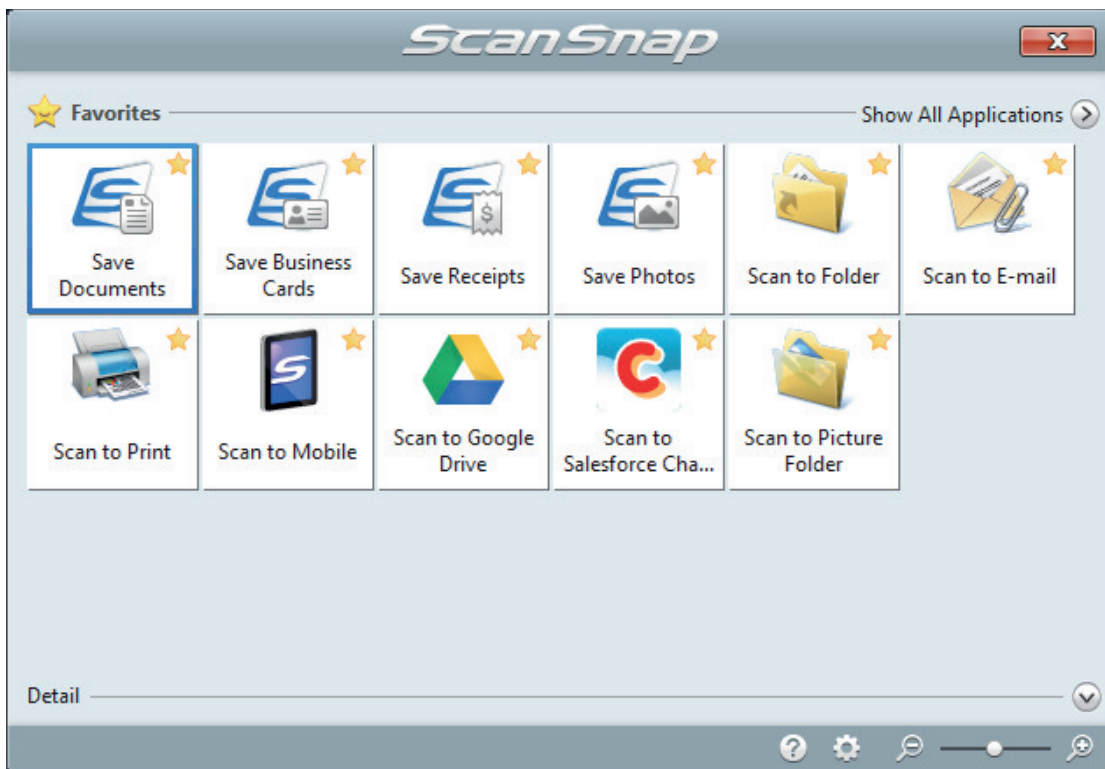

⇒ The selected application starts up. For details, refer to the Advanced Operation Guide.

ATTENTION

- You cannot start scanning when the Quick Menu is displayed. Either select an icon from the Quick Menu and finish the process, or close the Quick Menu before you perform the next scan.
- Do not move, delete, or rename scanned images using other applications while the Quick Menu is displayed.

HINT

- Clicking  displays the description of an application. Placing the mouse cursor over the icon of another application displays the description of the application.
- Performing a scan while an application that can be automatically linked with is active automatically starts the linkage between ScanSnap Manager and the application. For details, refer to the Advanced Operation Guide.

Scanning Documents of Different Widths or Lengths in One Batch (iX1300)

Load and scan the documents of different widths and lengths together in the ADF paper chute (cover) on the ScanSnap.

ATTENTION

Scanning documents of different sizes in one batch is only available for **U-turn Scan**, in which a document is loaded in the ADF paper chute (cover) and scanned.

For details about documents that can be scanned with U-turn Scan, refer to "[Documents to Scan \(iX1300\)](#)" (page 231) in the ScanSnap Help.

1. Hold the right side of the ADF paper chute (cover) of the ScanSnap then open it to turn the power on.

Open the ADF paper chute (cover) fully so that the [Scan] button lights up in blue.

When the ADF paper chute (cover) is opened, the extension will rise automatically.

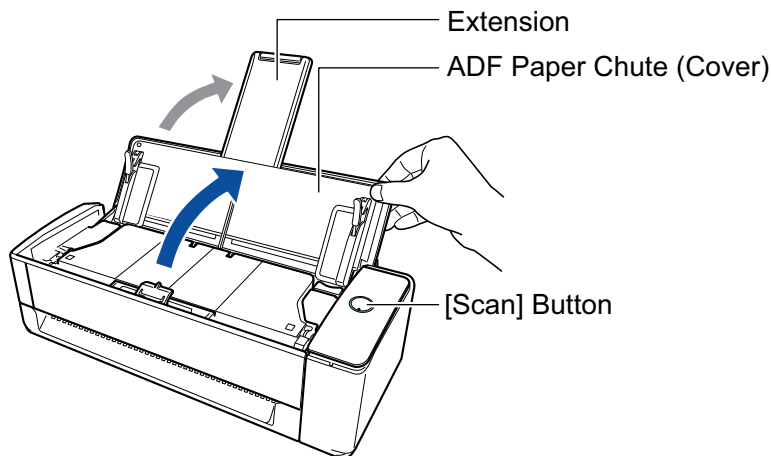

⇒ The ScanSnap Manager icon in the notification area located at the far right of the taskbar

changes from  to .

2. Right-click the ScanSnap Manager icon in the notification area located at the far right of the taskbar, and select the [Scan Button Settings] from the "Right-Click Menu" (page 100).

⇒ The ScanSnap setup window appears.

3. In the [Paper] tab, select [Automatic detection] in [Paper size].

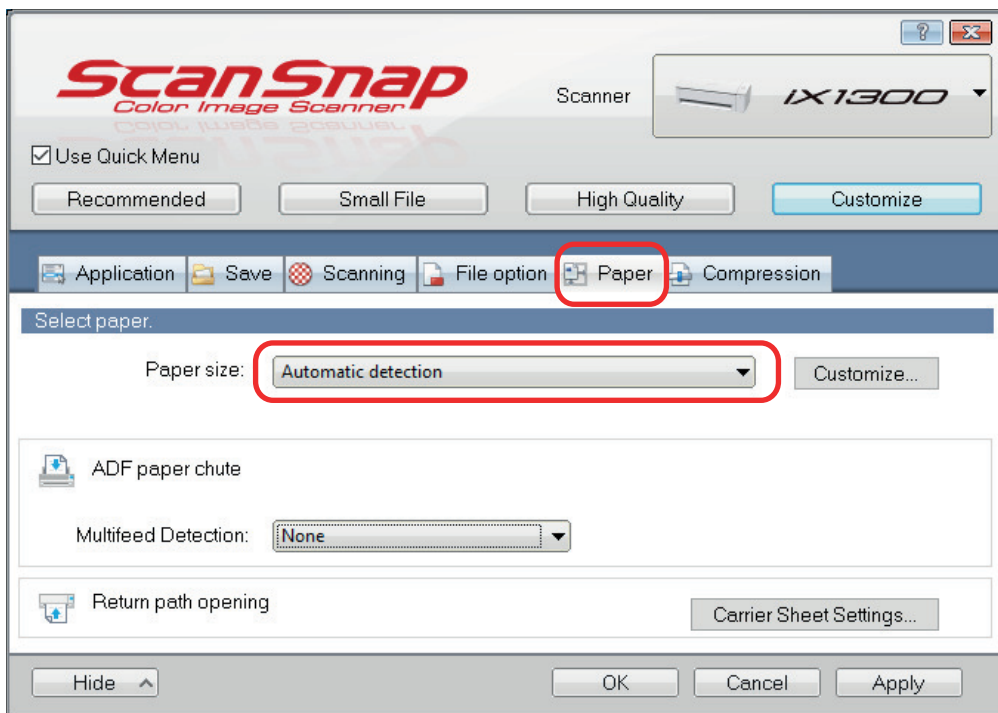

4. Select [None] for [Multifeed Detection] in [ADF] (U-turn Scan).

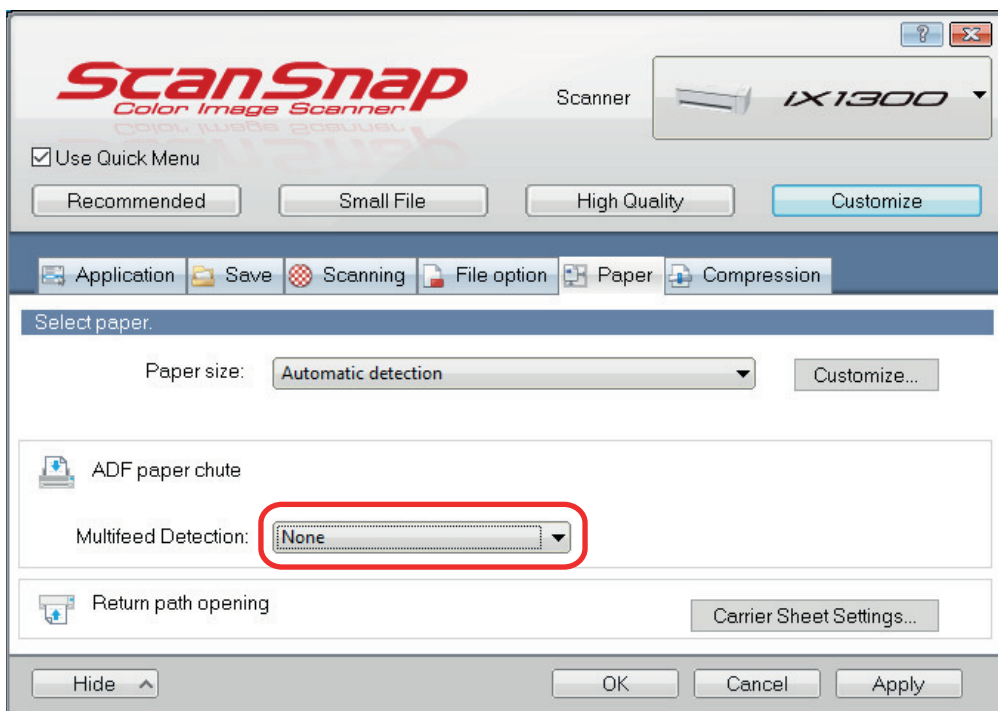

5. Click the [OK] button to close the ScanSnap setup window.
6. Load documents in the ScanSnap.
 1. Align the edges of the documents.

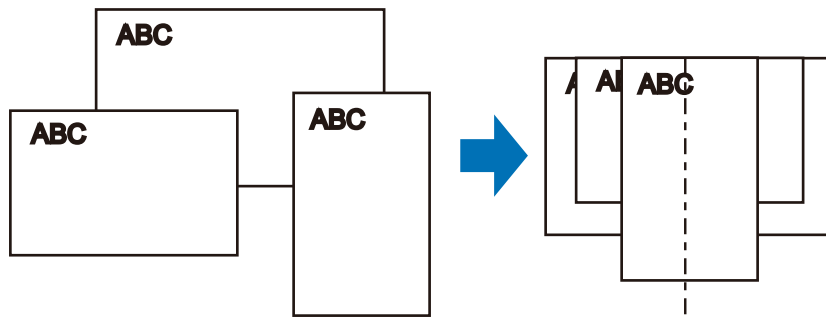

- In the ADF paper chute (cover), load the document face-up and head-first with the front facing you (when loading multiple documents, the first page is on the top).

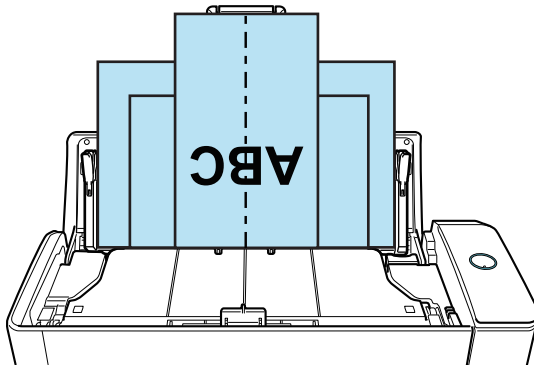

ATTENTION

- The pick roller feeds the documents. Load all documents over one another above the pick roller (center). Documents that are not loaded above the pick roller cannot be fed.

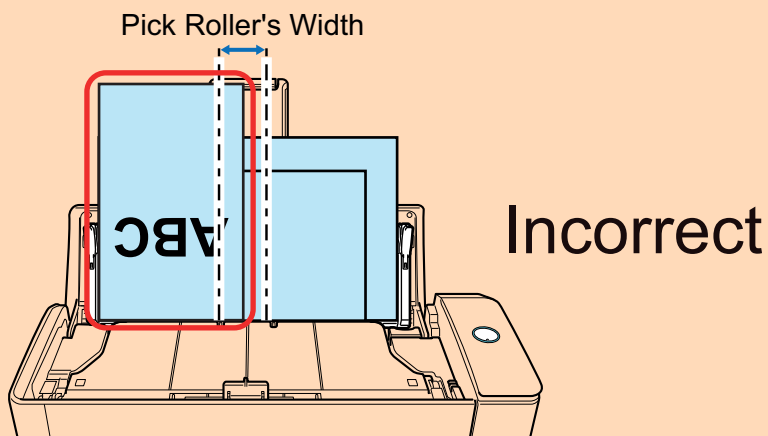

- Adjust the side guides to the widest document. If the side guides are not adjusted properly, a paper jam may occur.
- Load smaller documents so that they can be scanned straight.

If the documents are skewed during scanning, the following problems may occur:

- Part of the document does not appear in the scanned image
- Slant lines appear in the scanned image
- The documents are scanned in a wrong paper size

If the documents are not scanned straight, it is recommended that you configure the following settings, separate the documents by width, and scan them in different batches.

1. Right-click the ScanSnap Manager icon  in the notification area located at the far right of the taskbar, and select the [Scan Button Settings] from the "Right-Click Menu" (page 100).
⇒ The ScanSnap setup window appears.
2. Click the [Feed option] button in the [Scanning] tab.
⇒ The [Feed option] window appears.
3. Select [Continuous scan] for [Feed] in [ADF].

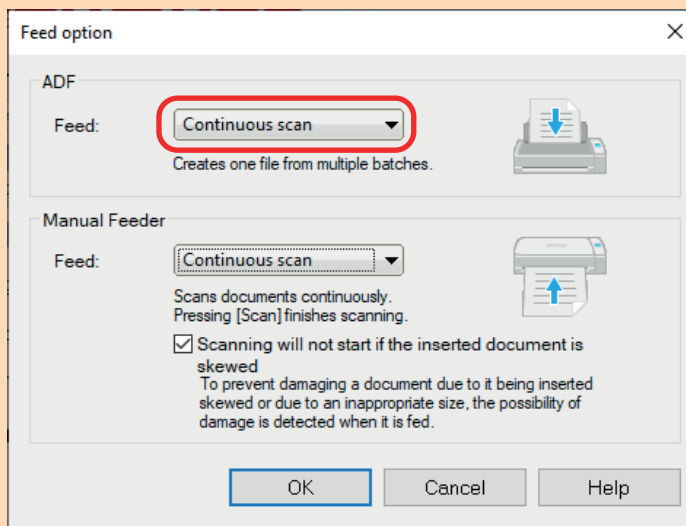

ADF

For [Feed], select the feeding method for **U-turn Scan** (which is the scanning method used when loading documents in the ADF paper chute (cover)).

[Normal scan] is selected by default.

Feed

- Normal scan

When all of documents loaded in the ADF paper chute (cover) are scanned, scanning is complete automatically and the Quick Menu appears.

- Continuous scan

Scans documents continuously in multiple batches.

If you scan documents after the first scan, you can use the ADF paper chute (cover) or the manual feeder for scanning.

4. Click the [OK] button.
 5. Click the [OK] button to close the ScanSnap setup window.
- Make sure that the document support tab is open.
Otherwise, a paper jam may occur.
If the document support tab is closed, pull it up with your fingers.

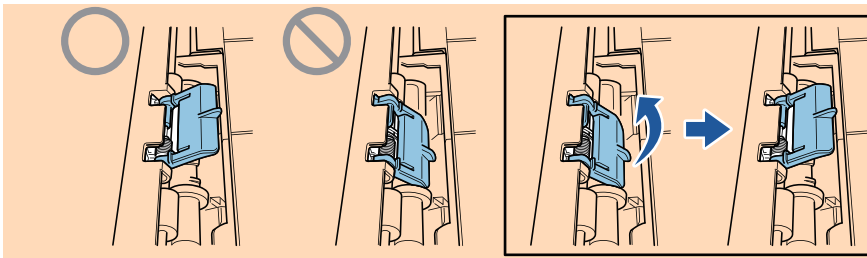

- If the document support tab comes off, refer to "Customer Support" in ["About Customer Support and Maintenance"](#) (page 606) to inquire about the problem.

7. Press the [Scan] button on the ScanSnap to start a scan.

ATTENTION

- In the following cases, the message "Documents have been loaded in the ADF paper chute (cover) and inserted into the manual feeder at the same time." is displayed.
 - Pressing the [Scan] button on the ScanSnap while documents are loaded in the ADF paper chute (cover) and a document is inserted into the manual feeder at the same time
Remove the document from the manual feeder and then click the [Continue Scanning] button or press the [Scan] button on the ScanSnap.
 - A document getting jammed in the ScanSnap
Refer to ["How to Remove a Jammed Document from iX1300"](#) (page 283) to remove the jammed document.
Load documents in the ADF paper chute (cover) or insert a document into the manual feeder again and then click the [Continue Scanning] button or press the [Scan] button on the ScanSnap.
- A document cannot be inserted into the manual feeder during U-turn Scan.
- When there are no documents in either the ADF paper chute (cover) or manual feeder, the message "Documents have not been loaded in the ADF paper chute (cover) or inserted into the Manual Feeder." is displayed. Load documents in the ADF paper chute (cover) and then click the [Continue Scanning] button or press the [Scan] button on the ScanSnap.
- Do not perform the following operations during scanning. Doing so will stop scanning.
 - Connect or disconnect the ScanSnap and other USB devices.
 - Close the ADF paper chute (cover).
 - Switch users.
 - Allow the computer to enter sleep mode.

⇒ The [Scan] button on the ScanSnap flashes in blue while the documents are being scanned.

The [ScanSnap Manager - Image scanning and file saving] window appears.

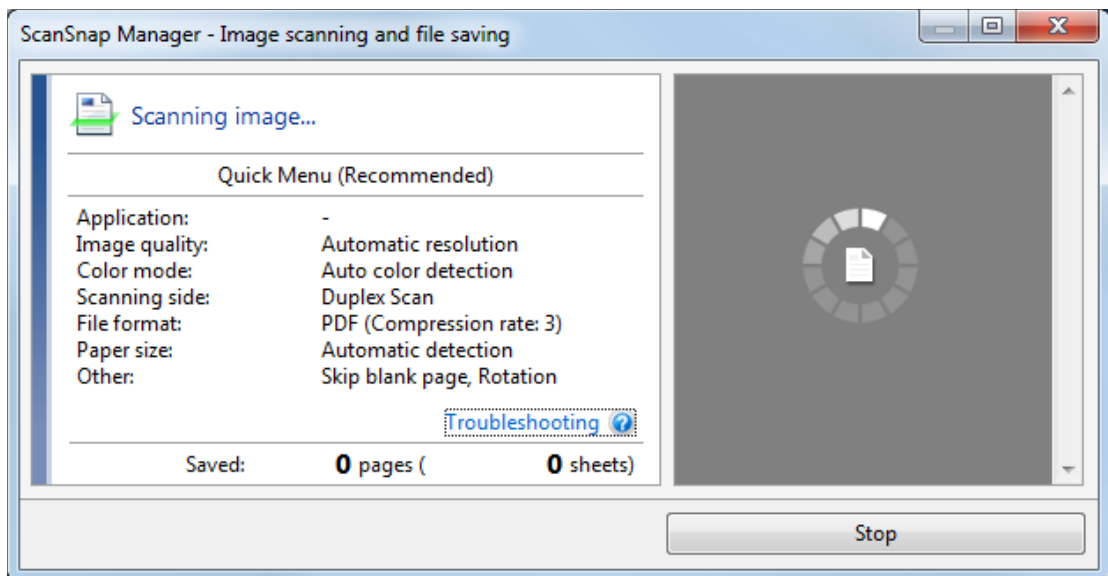

⇒ The Quick Menu appears when the scanning is completed.

8. In the Quick Menu, click the icon of the application to link with ScanSnap Manager.

When you select [Save Documents], you can manage scanned images by folder with ScanSnap Home.

For details, refer to "Managing Paper Documents by Folder on a Computer with ScanSnap Home" (page 440).

HINT

[ScanSnap Organizer] is displayed in the Quick Menu when ScanSnap Organizer is installed. To manage scanned images by folder with ScanSnap Organizer, refer to "Managing Paper Documents by Folder on a Computer with ScanSnap Organizer" (page 443).



⇒ The selected application starts up. For details, refer to the Advanced Operation Guide.

ATTENTION

- You cannot start scanning when the Quick Menu is displayed. Either select an icon from the Quick Menu and finish the process, or close the Quick Menu before you perform the next scan.
- Do not move, delete, or rename scanned images using other applications while the Quick Menu is displayed.

HINT

- Clicking  displays the description of an application. Placing the mouse cursor over the icon of another application displays the description of the application.
- Performing a scan while an application that can be automatically linked with is active automatically starts the linkage between ScanSnap Manager and the application.
For details, refer to the Advanced Operation Guide.

Scanning Documents Larger Than A4 or Letter Size by Directly Inserting Them in the ScanSnap (iX1300)

By folding an A3, B4, or Double Letter size document in half and scanning it, the scanned images of both sides are automatically merged and saved as a single image.

ATTENTION

- Scanning documents larger than A4 or letter size is only available for [Return Scan](#), in which a document is inserted into the manual feeder and scanned.

For details about documents that can be scanned with Return Scan, refer to ["Documents to Scan \(iX1300\)" \(page 231\)](#).

- Scanned images are automatically merged only when there is text, diagram, or a table on the fold line of the folded document.
 - When scanned images are automatically merged

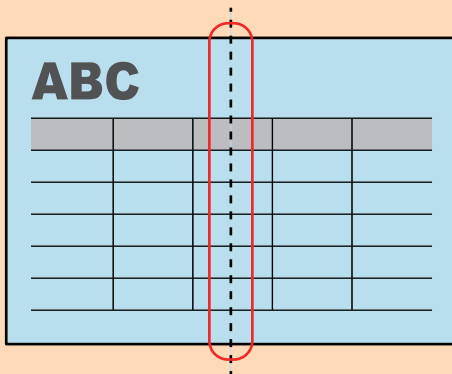

- When scanned images are not automatically merged

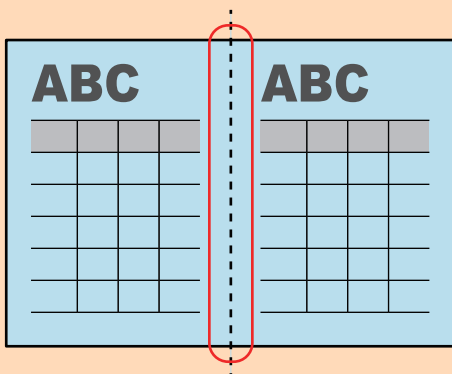

- After a document is scanned, if the scanned images are not merged automatically, you can use the ScanSnap Organizer Merge Pages function to merge the scanned images.

For details, refer to the ScanSnap Organizer Help.

- For a document that will have scanned images which are not merged automatically, you can use the optional Carrier Sheet to scan the document and merge the scanned images automatically.

For details, refer to ["Scanning Documents Larger than A4 or Letter Size with the Carrier Sheet \(iX1300\)" \(page 268\)](#).

- If scanned images are unexpectedly merged, clear the [Merge both side images] checkbox on the [Scanning mode option] window, and then scan the document again.

To open the [Scanning mode option] window, click the [Option] button in the [Scanning] tab of the ["ScanSnap Setup Window" \(page 102\)](#).

1. Fold the document in half so that the sides to be scanned are facing out.**ATTENTION**

Fold the long side of the document in half. If the left and right areas of the folded document are different in size from each other, the scanned images may not be merged automatically.

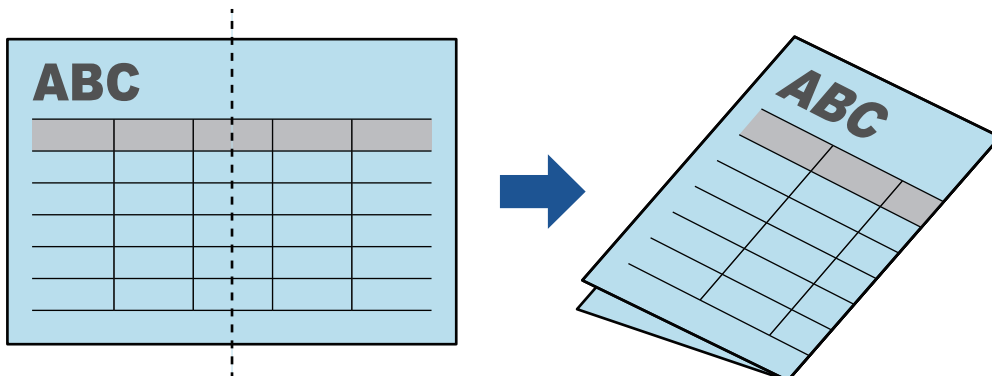
**2. Insert the top end of the document straight into the manual feeder.**

Make sure that the documents are fed into the ScanSnap and are held firmly.

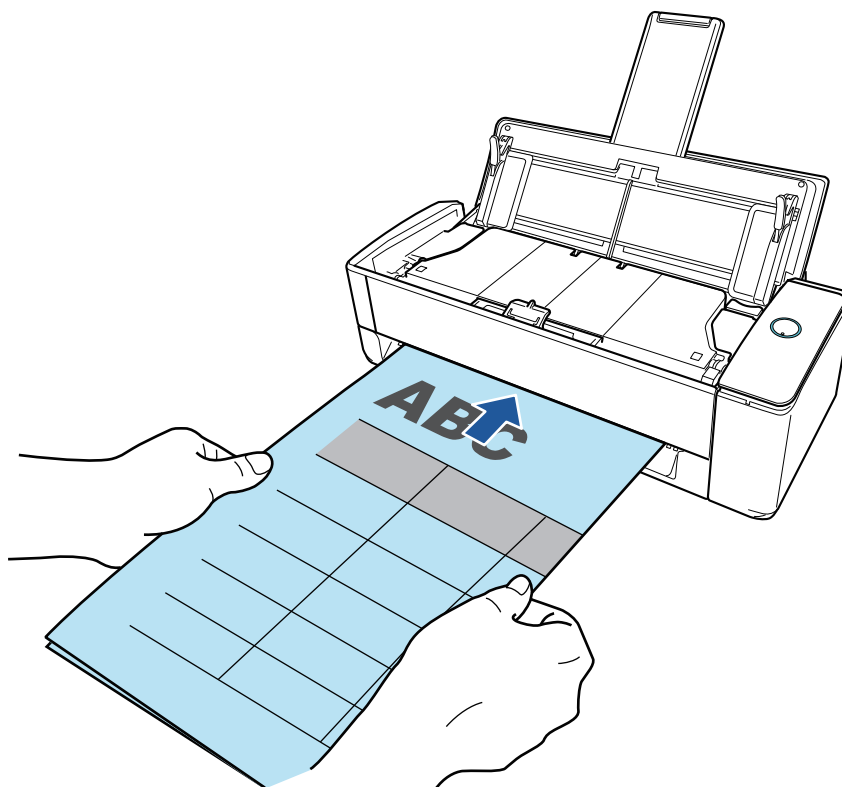
**ATTENTION**

When you scan a document, the document comes out from the back of the ScanSnap. Leave space (about the length of the document) at the back of the ScanSnap.

HINT

You can scan a document with the ADF paper chute (cover) closed.

3. Press the [Scan] button on the ScanSnap to start a scan.

ATTENTION

- If a document is inserted into the manual feeder in a skewed way, the message "The inserted document is skewed. If the document is scanned in the current condition, it may be damaged." may be displayed.

Remove the document, insert the top of the document into the center of the manual feeder in a straight direction, and then click the [Continue Scanning] button or press the [Scan] button on the ScanSnap.

To prevent the message from being displayed, clear the [Scanning will not start if the inserted document is skewed] checkbox in the [Feed option] window.

- In the following cases, the message "Documents have been loaded in the ADF paper chute (cover) and inserted into the manual feeder at the same time." is displayed.

- Pressing the [Scan] button on the ScanSnap while documents are loaded in the ADF paper chute (cover) and a document is inserted into the manual feeder at the same time

Remove the documents from the ADF paper chute (cover) and then click the [Continue Scanning] button or press the [Scan] button on the ScanSnap.

- A document getting jammed in the ScanSnap

Refer to "[How to Remove a Jammed Document from iX1300](#)" (page 283) to remove the jammed document.

Load documents in the ADF paper chute (cover) or insert a document into the manual feeder again and then click the [Continue Scanning] button or press the [Scan] button on the ScanSnap.

- A document cannot be inserted into the manual feeder during U-turn Scan.
- When there are no documents in either the ADF paper chute (cover) or manual feeder, the message "Documents have not been loaded in the ADF paper chute (cover) or inserted into the Manual Feeder." is displayed. Insert a document into the manual feeder and then click the [Continue Scanning] button or press the [Scan] button on the ScanSnap.
- Do not perform the following operations during scanning. Doing so will stop scanning.
 - Connect or disconnect the ScanSnap and other USB devices.
 - Close the ADF paper chute (cover).
 - Switch users.
 - Allow the computer to enter sleep mode.

⇒ The [Scan] button on the ScanSnap flashes in blue and the [ScanSnap Manager - Image scanning and file saving] window appears while the document is being scanned.

When scanning is completed, scanned images of the front and back side of the document are displayed as a double-page spread image in the preview area.

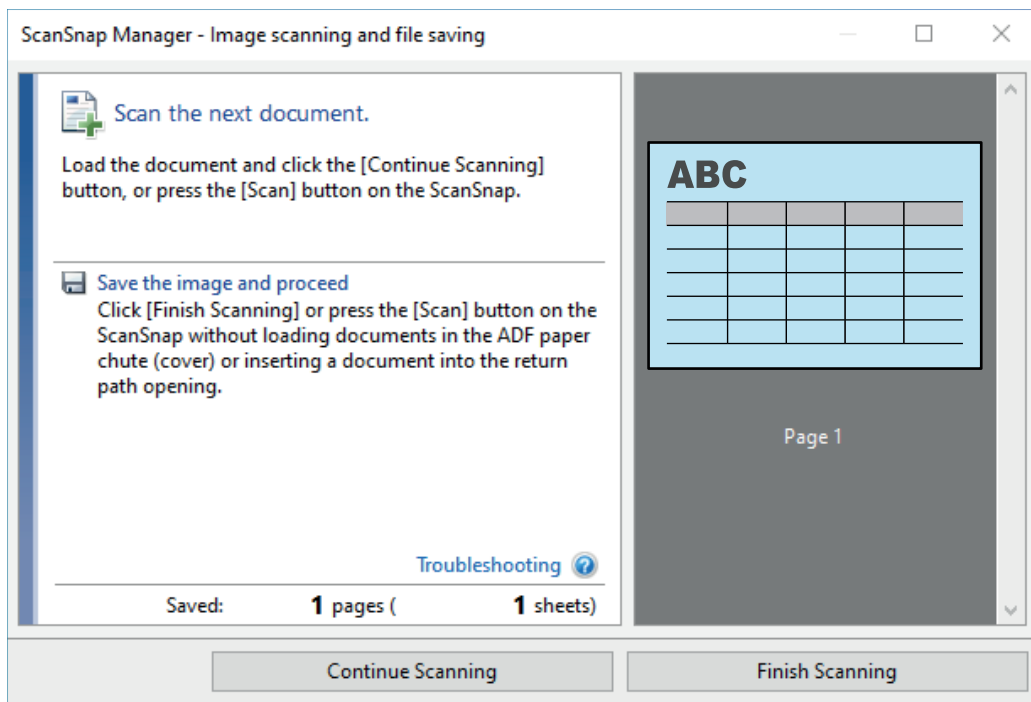

To continue scanning, insert the next document to be scanned. When the document is inserted, scanning starts automatically.

4. **Click the [Finish Scanning] button in the [ScanSnap Manager - Image scanning and file saving] window or press the [Scan] button on the ScanSnap without loading any more documents in the ScanSnap.**

⇒ Scanning is complete and the Quick Menu appears.

5. **In the Quick Menu, click the icon of the application to link with ScanSnap Manager.**

When you select [Save Documents], you can manage scanned images by folder with ScanSnap Home.

For details, refer to "[Managing Paper Documents by Folder on a Computer with ScanSnap Home](#)" (page 440).

HINT

[ScanSnap Organizer] is displayed in the Quick Menu when ScanSnap Organizer is installed.

To manage scanned images by folder with ScanSnap Organizer, refer to "[Managing Paper Documents by Folder on a Computer with ScanSnap Organizer](#)" (page 443).



⇒ The selected application starts up. For details, refer to the Advanced Operation Guide.

ATTENTION

- You cannot start scanning when the Quick Menu is displayed. Either select an icon from the Quick Menu and finish the process, or close the Quick Menu before you perform the next scan.
- Do not move, delete, or rename scanned images using other applications while the Quick Menu is displayed.

HINT

- Clicking  displays the description of an application. Placing the mouse cursor over the icon of another application displays the description of the application.
- Performing a scan while an application that can be automatically linked with is active automatically starts the linkage between ScanSnap Manager and the application.
For details, refer to the Advanced Operation Guide.

Scanning Documents Larger than A4 or Letter Size with the Carrier Sheet (iX1300)

Documents larger than A4/Letter size (such as A3, 11 × 17 in. and B4) can be scanned with the optional Carrier Sheet. By folding the document in half and scanning in duplex mode, the two sides are merged into a single image.

ATTENTION

- The Carrier Sheet is only available for [Return Scan](#), in which a document is inserted into the manual feeder and scanned.

For details about documents that can be scanned with Return Scan, refer to "[Documents to Scan \(iX1300\)](#)" (page 231).

- The [Deskew by text on document] checkbox in the [Scanning mode option] window will be disabled.

To open the [Scanning mode option] window, click the [Option] button in the [Scanning] tab of the "[ScanSnap Setup Window](#)" (page 102).

HINT

Both sides of a double-sided A4/Letter size document or smaller can also be scanned and merged into a single image.

- 1. Right-click the ScanSnap Manager icon  in the notification area located at the far right of the taskbar, and select the [Scan Button Settings] from the "Right-Click Menu" (page 100).**
⇒ The ScanSnap setup window appears.
- 2. In the [Paper] tab, select [Automatic detection] in [Paper size], and then click the [Carrier Sheet Settings] button in [Manual feeder] (Return Scan).**

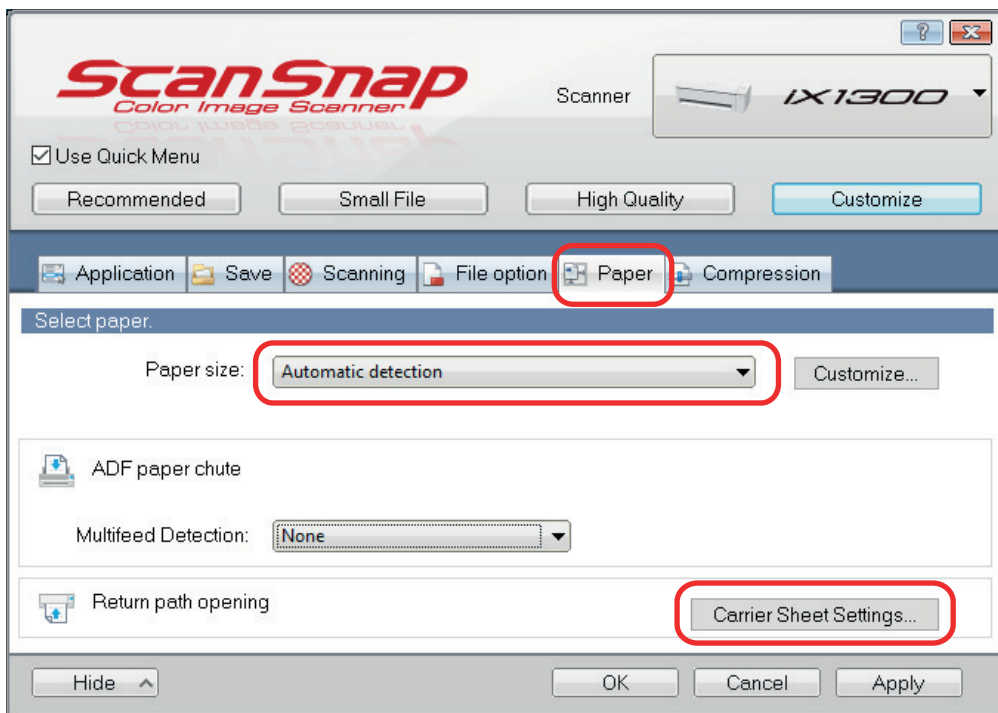

⇒ The [Carrier Sheet Settings] window appears.

3. Select [one double-page spread image] in [Save as] and click the [OK] button.

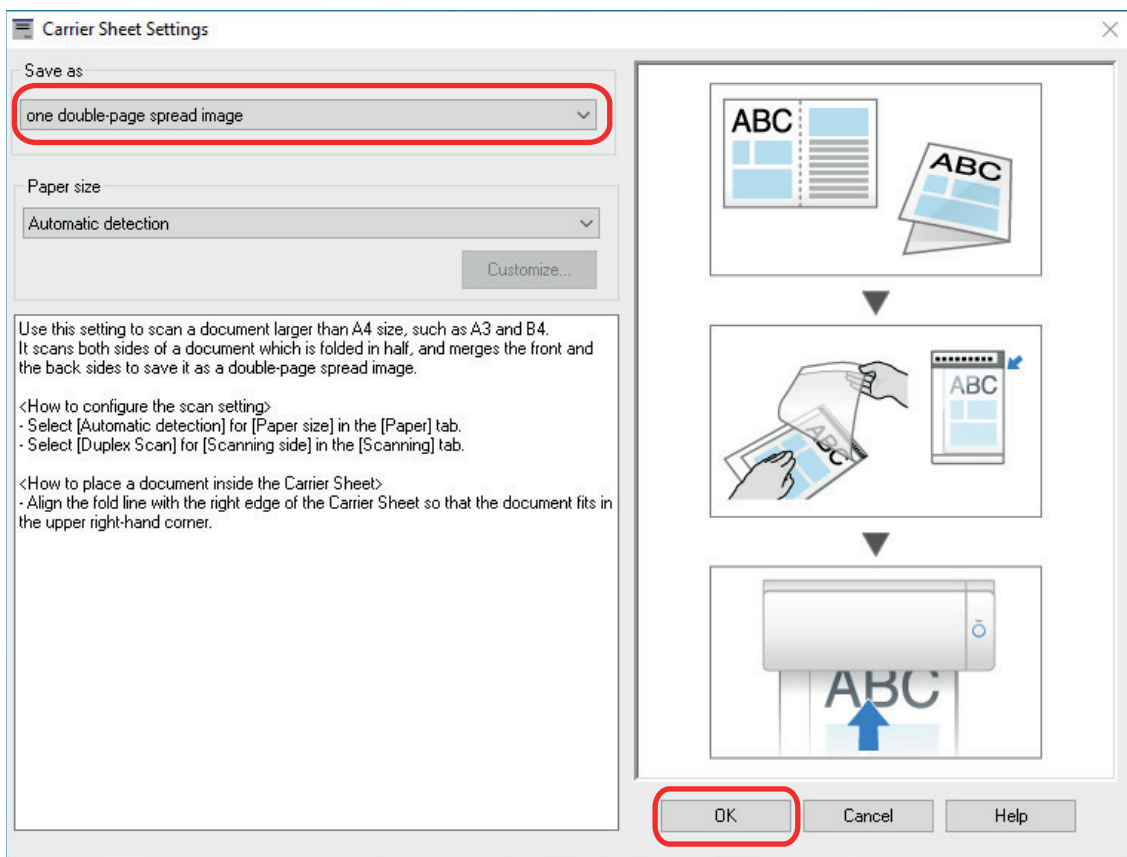

4. In [Scanning side] in the [Scanning] tab, select [Duplex Scan (Double-sided)] and click the [OK] button.

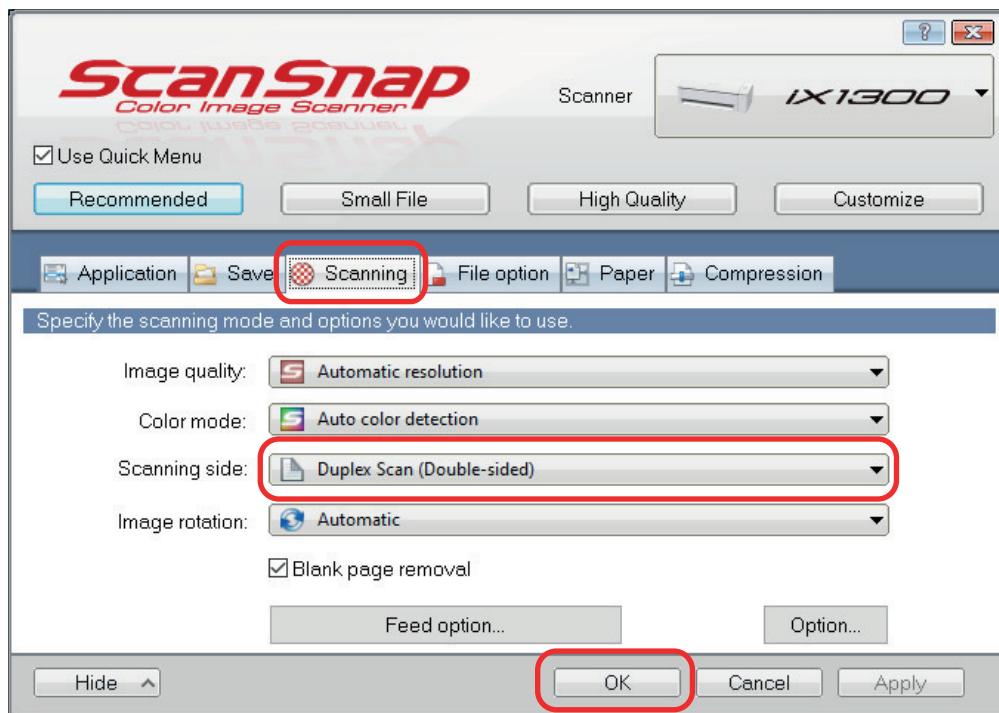

ATTENTION

If [Simplex Scan (Single-sided)] is selected, the ScanSnap outputs the same result as performing a simplex scan in [two separate images (front and back)] mode.

5. Place the document inside the Carrier Sheet.

1. Fold the document in half with the sides to be scanned facing out.
Fold it tightly and smooth out any creases.

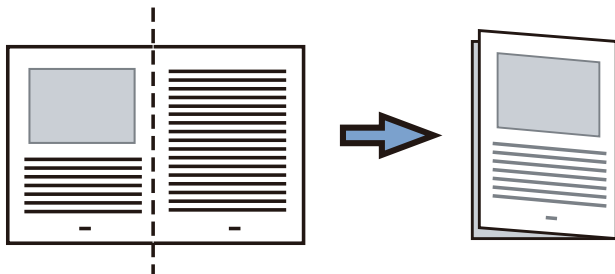

2. Open the Carrier Sheet to bind the document.

Align the fold line with the right edge of the Carrier Sheet so that the document fits in the upper right-hand corner of the Carrier Sheet.

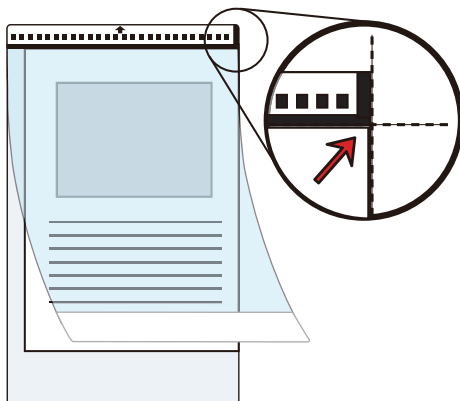

HINT

Note that the front side of the Carrier Sheet has a black and white pattern at the top and a thick vertical line in the upper right-hand corner.

6. Insert the part with the black and white pattern straight into the manual feeder, with the front side of the Carrier Sheet facing up.

Make sure that the Carrier Sheet is fed into the ScanSnap and is held firmly.

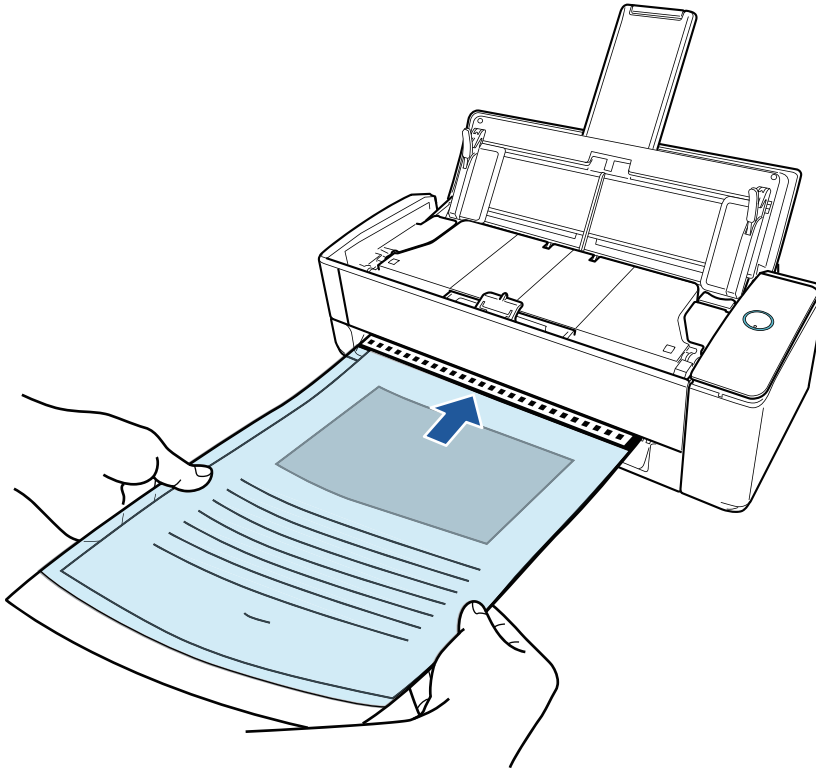
**ATTENTION**

When you scan a document, the document comes out from the back of the ScanSnap. Leave space (about the length of the Carrier Sheet) at the back of the ScanSnap.

HINT

You can scan a document with the ADF paper chute (cover) closed.

7. Press the [Scan] button on the ScanSnap to start a scan.

ATTENTION

- If the Carrier Sheet is inserted into the manual feeder in a skewed way, the message "The inserted document is skewed. If the document is scanned in the current condition, it may be damaged." may be displayed.

Remove the Carrier Sheet, insert it into the manual feeder in a straight direction, and then click the [Continue Scanning] button or press the [Scan] button on the ScanSnap.

To prevent the message from being displayed, clear the [Scanning will not start if the inserted document is skewed] checkbox in the [Feed option] window.

- In the following cases, the message "Documents have been loaded in the ADF paper chute (cover) and inserted into the manual feeder at the same time." is displayed.
 - Pressing the [Scan] button on the ScanSnap while documents are loaded in the ADF paper chute (cover) and a document is inserted into the manual feeder at the same time

Remove the documents from the ADF paper chute (cover) and then click the [Continue Scanning] button or press the [Scan] button on the ScanSnap.

- A document getting jammed in the ScanSnap

Refer to "[How to Remove a Jammed Document from iX1300](#)" (page 283) to remove the jammed document.

Load documents in the ADF paper chute (cover) or insert a document into the manual feeder again and then click the [Continue Scanning] button or press the [Scan] button on the ScanSnap.

- A document cannot be inserted into the manual feeder during U-turn Scan.
- When there are no documents in either the ADF paper chute (cover) or manual feeder, the message "Documents have not been loaded in the ADF paper chute (cover) or inserted into the Manual Feeder." is displayed. Insert a document into the manual feeder and then click the [Continue Scanning] button or press the [Scan] button on the ScanSnap.
- Do not perform the following operations during scanning. Doing so will stop scanning.
 - Connect or disconnect the ScanSnap and other USB devices.
 - Close the ADF paper chute (cover).
 - Switch users.
 - Allow the computer to enter sleep mode.

⇒ The [Scan] button on the ScanSnap flashes in blue and the [ScanSnap Manager - Image scanning and file saving] window appears while the document is being scanned.

Both sides of the document are scanned and displayed as a single double-page spread image in the preview area.

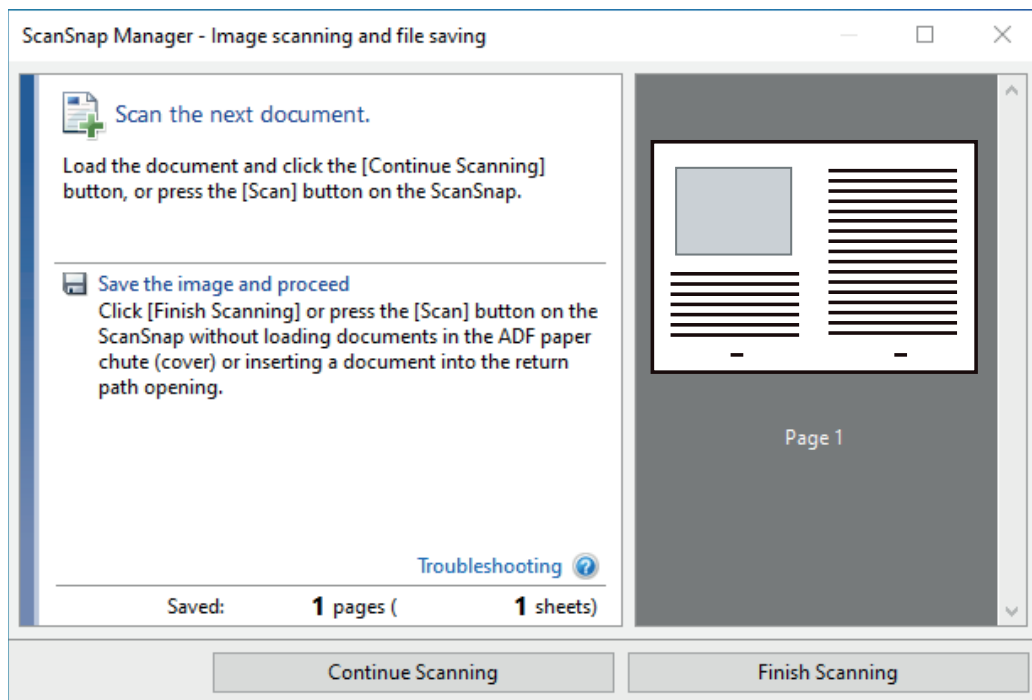

To continue scanning, insert the next document to be scanned. When the document is inserted, scanning starts automatically.

8. Click the [Finish Scanning] button in the [ScanSnap Manager - Image scanning and file saving] window or press the [Scan] button on the ScanSnap without loading any more documents in the ScanSnap.

⇒ The scanned images of the front and back sides of the document are saved as a double-page spread image.

ATTENTION

- There may be a line or a gap appearing between the front and back side images. Also when you scan a thick document in the Carrier Sheet, the scanned image on the left and the scanned image on the right of a double-page spread image may skew towards each other from the top.

These symptoms may be improved when you place the document in the Carrier Sheet as follows:

- Fold the document properly
 - Neatly align the edges of the document with the edges of the Carrier Sheet
 - Turn over the Carrier Sheet to the other (reverse) side
- If [Automatic detection] is specified for [Paper size] in the [Carrier Sheet Settings] window, an optimal size will be selected automatically from the available standard sizes (A3, B4, or 11 × 17 in.) in [Paper size]. Note that the size of the image may become smaller than the original document depending on the document.

Example: When characters and illustrations are printed to fit in A4 size in the center of an A3 size document, the scanned image is output in B4 size.

To output the scanned image in its original size, specify the document size in [Paper size].

- Part of the scanned image around where the document is folded may appear missing. In that case, place the document so that its edge is about 1 mm (0.04 in.) inside from the edge of the Carrier Sheet.

Scanning Documents Such as Photographs and Clippings (iX1300)

Using the optional Carrier Sheet allows you to scan documents that can be damaged quite easily such as photographs, or non-standard size documents that are difficult to load directly such as clippings.

ATTENTION

- The Carrier Sheet is only available for [Return Scan](#), in which a document is inserted into the manual feeder and scanned.

For details about documents that can be scanned with Return Scan, refer to ["Documents to Scan \(iX1300\)" \(page 231\)](#).

- The [Deskew by text on document] checkbox in the [Scanning mode option] window will be disabled.

To open the [Scanning mode option] window, click the [Option] button in the [Scanning] tab of the ["ScanSnap Setup Window" \(page 102\)](#).

1. Right-click the ScanSnap Manager icon  in the notification area located at the far right of the taskbar, and select the [Scan Button Settings] from the ["Right-Click Menu" \(page 100\)](#).
⇒ The ScanSnap setup window appears.
2. In the [Paper] tab, select [Automatic detection] in [Paper size], and then click the [Carrier Sheet Settings] button in [Manual feeder] (Return Scan).

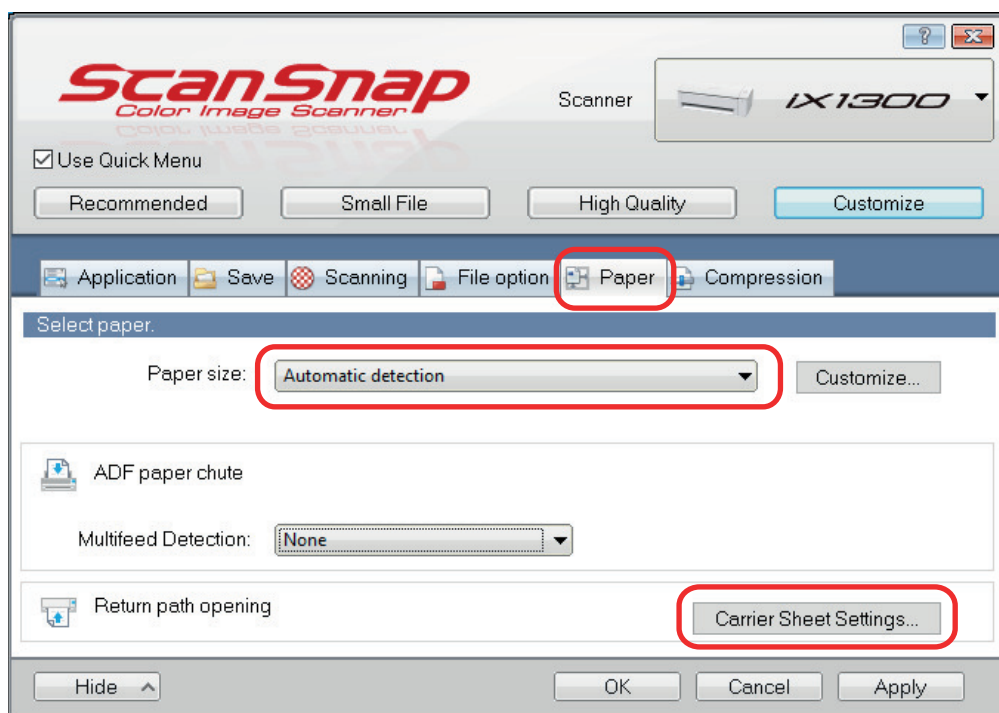

⇒ The [Carrier Sheet Settings] window appears.

3. Select **[two separate images (front and back)]** in **[Save as]** and click the **[OK]** button.

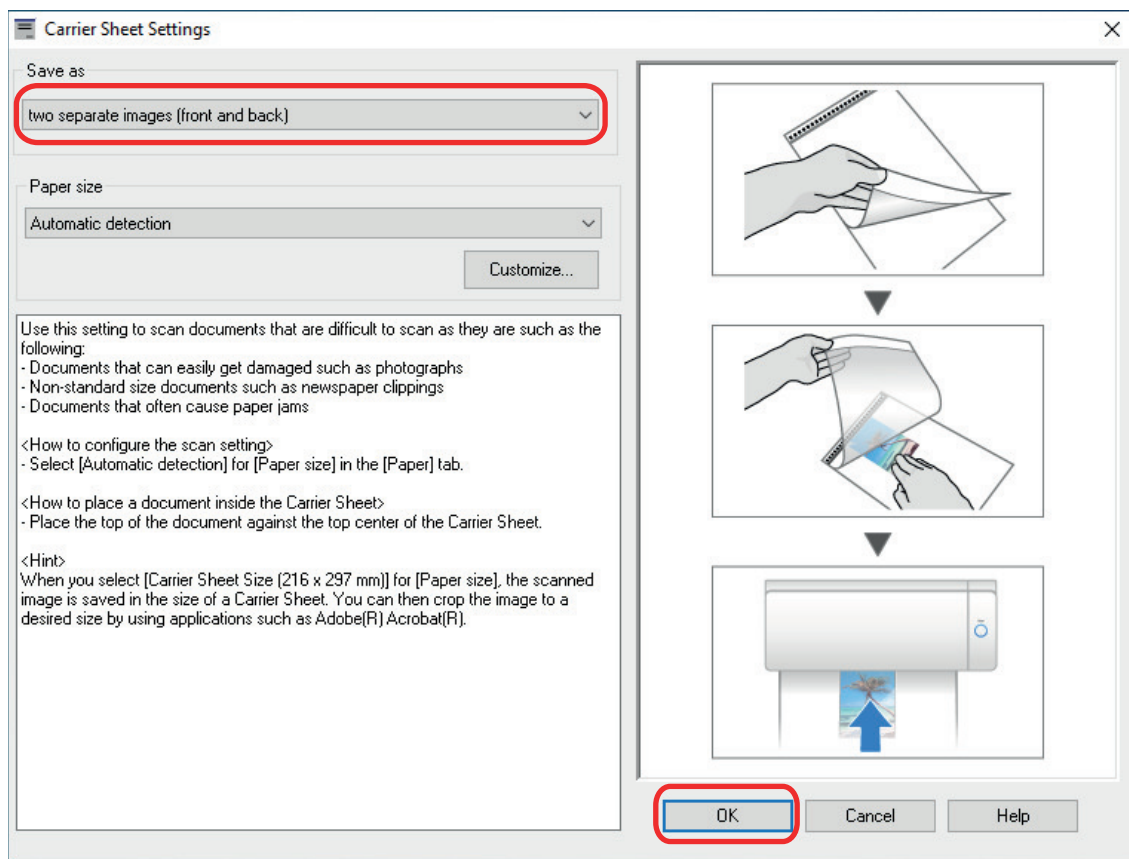

4. Click the **[OK]** button to close the ScanSnap setup window.

5. Place the document inside the Carrier Sheet.

Open the Carrier Sheet and place the top of the document against the top center of the Carrier Sheet.

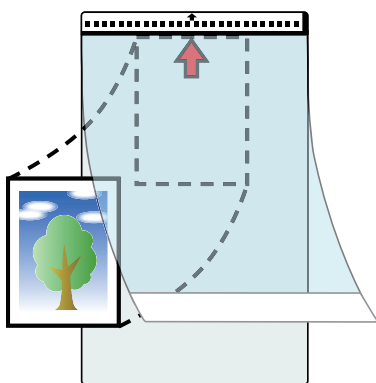

6. Insert the part with the black and white pattern straight into the manual feeder, with the front side of the Carrier Sheet facing up.

Make sure that the Carrier Sheet is fed into the ScanSnap and is held firmly.

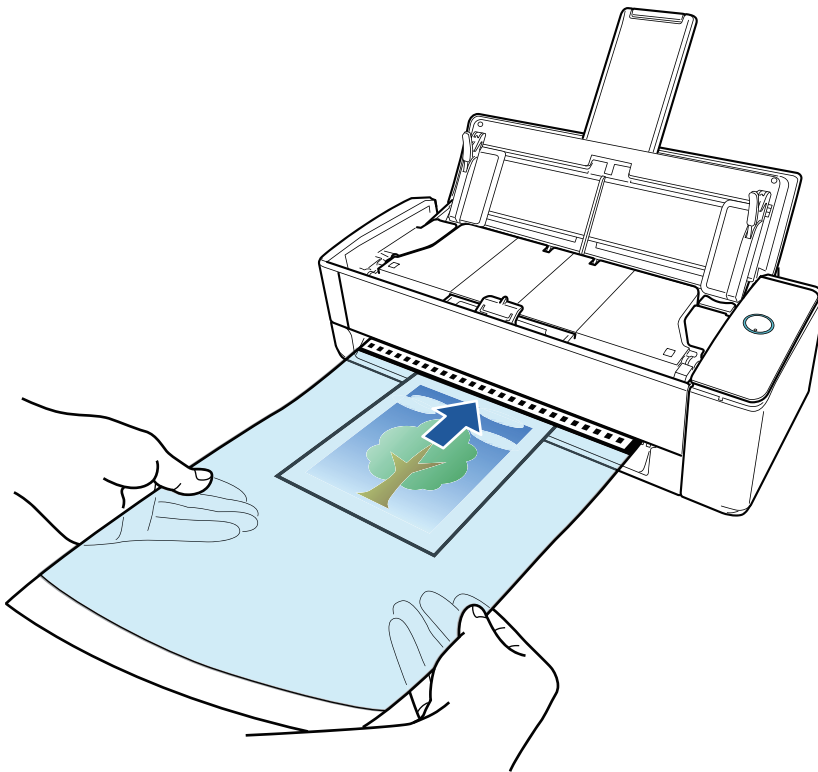
**ATTENTION**

When you scan a document, the document comes out from the back of the ScanSnap. Leave space (about the length of the Carrier Sheet) at the back of the ScanSnap.

HINT

You can scan a document with the ADF paper chute (cover) closed.

7. Press the [Scan] button on the ScanSnap to start a scan.

ATTENTION

- If the Carrier Sheet is inserted into the manual feeder in a skewed way, the message "The inserted document is skewed. If the document is scanned in the current condition, it may be damaged." may be displayed.

Remove the Carrier Sheet, insert it into the manual feeder in a straight direction, and then click the [Continue Scanning] button or press the [Scan] button on the ScanSnap.

To prevent the message from being displayed, clear the [Scanning will not start if the inserted document is skewed] checkbox in the [Feed option] window.

- In the following cases, the message "Documents have been loaded in the ADF paper chute (cover) and inserted into the manual feeder at the same time." is displayed.
 - Pressing the [Scan] button on the ScanSnap while documents are loaded in the ADF paper chute (cover) and a document is inserted into the manual feeder at the same time
Remove the documents from the ADF paper chute (cover) and then click the [Continue Scanning] button or press the [Scan] button on the ScanSnap.
 - A document getting jammed in the ScanSnap

Refer to "[How to Remove a Jammed Document from iX1300](#)" (page 283) to remove the jammed document.

Load documents in the ADF paper chute (cover) or insert a document into the manual feeder again and then click the [Continue Scanning] button or press the [Scan] button on the ScanSnap.

- A document cannot be inserted into the manual feeder during U-turn Scan.
- When there are no documents in either the ADF paper chute (cover) or manual feeder, the message "Documents have not been loaded in the ADF paper chute (cover) or inserted into the Manual Feeder." is displayed. Insert a document into the manual feeder and then click the [Continue Scanning] button or press the [Scan] button on the ScanSnap.
- Do not perform the following operations during scanning. Doing so will stop scanning.
 - Connect or disconnect the ScanSnap and other USB devices.
 - Close the ADF paper chute (cover).
 - Switch users.
 - Allow the computer to enter sleep mode.

⇒ The [Scan] button on the ScanSnap flashes in blue and the [ScanSnap Manager - Image scanning and file saving] window appears while the document is being scanned.

When scanning is complete, the scanned image is displayed in the preview area.

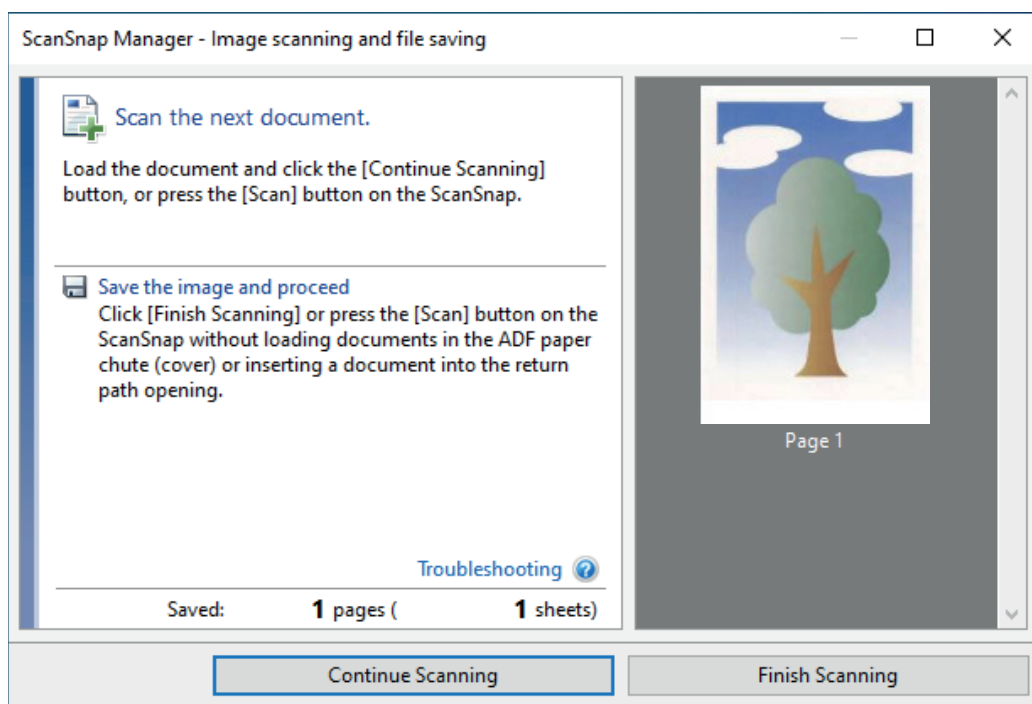

To continue scanning, insert the next document to be scanned. When the document is inserted, scanning starts automatically.

8. Click the [Finish Scanning] button in the [ScanSnap Manager - Image scanning and file saving] window or press the [Scan] button on the ScanSnap without loading any more documents in the ScanSnap.

⇒ The scanned image is saved.

ATTENTION

- The scanned image is output at the center of the page in the size specified for [Paper size] in the [Carrier Sheet Settings] window.
- If [Automatic detection] is specified for [Paper size] in the [Carrier Sheet Settings] window, an optimal size will be selected automatically from the available standard sizes in [Paper size]. Note that the size of the image may become smaller than the original document depending on the document scanned, or part of the image may appear missing.

Example: When the contents are printed to fit in A5 size in the center of an A4 size document, the scanned image is output in A5 size.

To output the scanned image in its original size, specify the document size in [Paper size].

HINT

- In the following cases, place a blank (white) sheet of paper underneath the document when scanning:
 - The scanned image is not saved in the correct size (when [Automatic detection] is selected for [Paper size] in the [Carrier Sheet Settings] window)
 - Shadows appear around the edges of the scanned image
 - Black lines appear around the edges of a uniquely shaped cutting document if you place the document in the Carrier Sheet

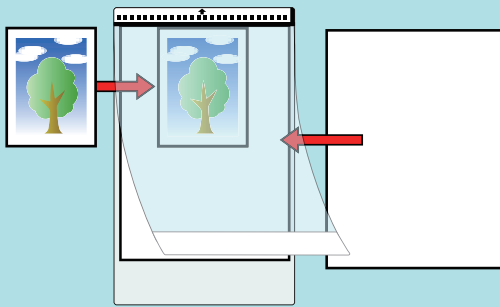

Scanning Booklets or Documents with Overlapped Areas such as Envelopes (iX1300)

The manual feeder of the ScanSnap enables you to scan booklets or documents that have overlapped areas such as envelopes, documents folded in half, and transfer paper.

ATTENTION

- Scanning booklets or documents that have overlapped areas is only available for [Return Scan](#), in which a document is inserted into the manual feeder and scanned.

For details about documents that can be scanned with Return Scan, refer to "[Documents to Scan \(iX1300\)](#)" (page 231).

- The [Deskew by text on document] checkbox in the [Scanning mode option] window will be disabled.

To open the [Scanning mode option] window, click the [Option] button in the [Scanning] tab of the "[ScanSnap Setup Window](#)" (page 102).

1. Insert a document into the manual feeder of the ScanSnap.

Face the front side of a document upwards and insert the top end of the document straight into the middle of the manual feeder.

Make sure that the document is fed into the ScanSnap and is held firmly.

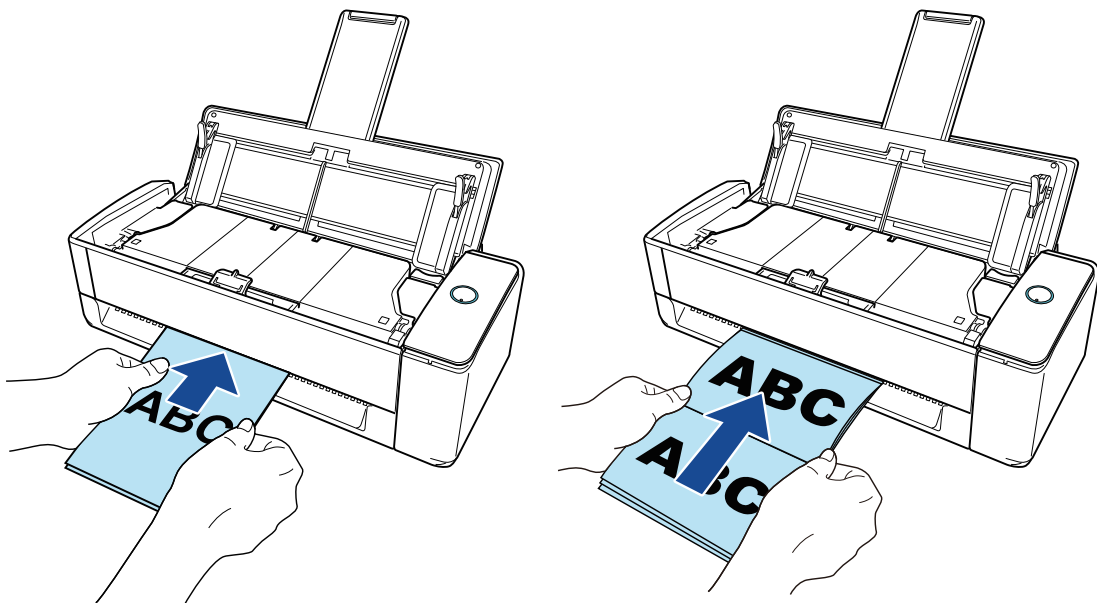

ATTENTION

When you scan a document, the document comes out from the back of the ScanSnap. Leave space (about the length of the document) at the back of the ScanSnap.

HINT

You can scan a document with the ADF paper chute (cover) closed.

2. Press the [Scan] button on the ScanSnap to start a scan.

ATTENTION

- If a document is inserted into the manual feeder in a skewed way, the message "The inserted document is skewed. If the document is scanned in the current condition, it may be damaged." may be displayed.

Remove the document, insert the top of the document into the center of the manual feeder in a straight direction, and then click the [Continue Scanning] button or press the [Scan] button on the ScanSnap.

To prevent the message from being displayed, clear the [Scanning will not start if the inserted document is skewed] checkbox in the [Feed option] window.

- In the following cases, the message "Documents have been loaded in the ADF paper chute (cover) and inserted into the manual feeder at the same time." is displayed.
 - Pressing the [Scan] button on the ScanSnap while documents are loaded in the ADF paper chute (cover) and a document is inserted into the manual feeder at the same time
Remove the documents from the ADF paper chute (cover) and then click the [Continue Scanning] button or press the [Scan] button on the ScanSnap.
 - A document getting jammed in the ScanSnap
Refer to "[How to Remove a Jammed Document from iX1300](#)" (page 283) to remove the jammed document.
Load documents in the ADF paper chute (cover) or insert a document into the manual feeder again and then click the [Continue Scanning] button or press the [Scan] button on the ScanSnap.
- A document cannot be inserted into the manual feeder during U-turn Scan.
- When there are no documents in either the ADF paper chute (cover) or manual feeder, the message "Documents have not been loaded in the ADF paper chute (cover) or inserted into the Manual Feeder." is displayed. Insert a document into the manual feeder and then click the [Continue Scanning] button or press the [Scan] button on the ScanSnap.
- Do not perform the following operations during scanning. Doing so will stop scanning.
 - Connect or disconnect the ScanSnap and other USB devices.
 - Close the ADF paper chute (cover).
 - Switch users.
 - Allow the computer to enter sleep mode.

⇒ The [Scan] button on the ScanSnap flashes in blue while the documents are being scanned.

The [ScanSnap Manager - Image scanning and file saving] window appears.

⇒ When scanning is complete, the [ScanSnap Manager - Image scanning and file saving] window displays a scanning standby status.

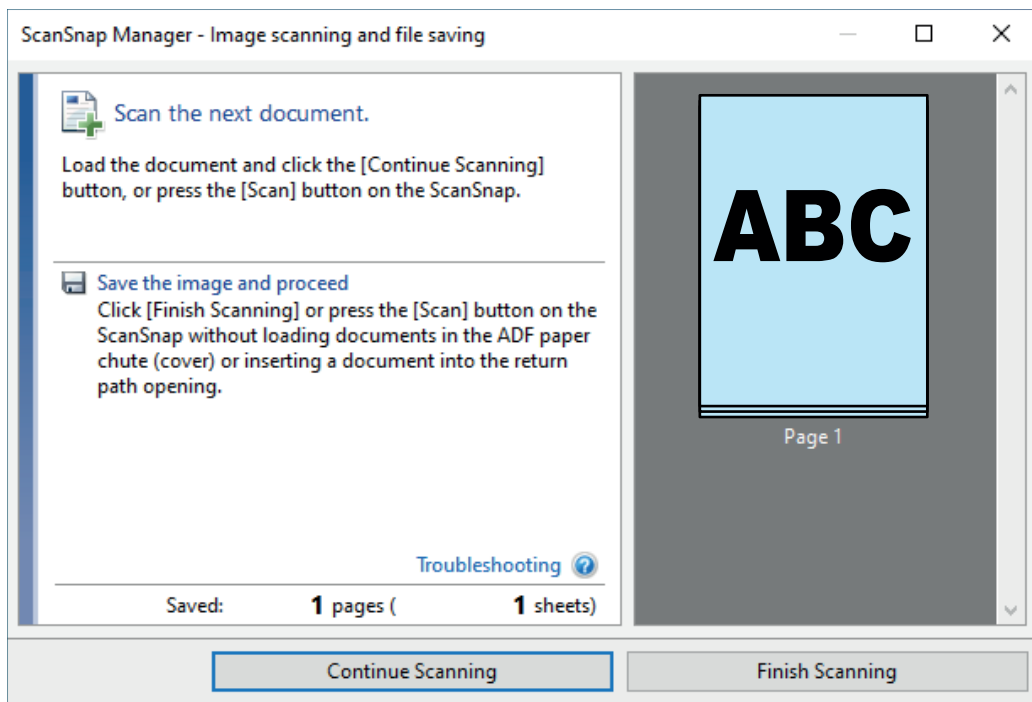

To continue scanning, insert the next document to be scanned. When the document is inserted, scanning starts automatically.

3. Click the [Finish Scanning] button in the [ScanSnap Manager - Image scanning and file saving] window or press the [Scan] button on the ScanSnap without loading any more documents in the ScanSnap.

⇒ Scanning is complete and the Quick Menu appears.

4. In the Quick Menu, click the icon of the application to link with ScanSnap Manager.

For details about linking the following applications with ScanSnap Manager, refer to "[Useful Usages](#)" (page 439).

- Save Documents
- Save Business Cards
- Save Receipts
- Save Photos

HINT

The following applications are displayed in the Quick Menu when ScanSnap Organizer and CardMinder are installed.

- When ScanSnap Organizer is installed
ScanSnap Organizer
- When CardMinder is installed
CardMinder



⇒ The selected application starts up. For details, refer to the Advanced Operation Guide.

ATTENTION

- You cannot start scanning when the Quick Menu is displayed. Either select an icon from the Quick Menu and finish the process, or close the Quick Menu before you perform the next scan.
- Do not move, delete, or rename scanned images using other applications while the Quick Menu is displayed.

HINT

- Clicking  displays the description of an application. Placing the mouse cursor over the icon of another application displays the description of the application.
- Performing a scan while an application that can be automatically linked with is active automatically starts the linkage between ScanSnap Manager and the application. For details, refer to the Advanced Operation Guide.

How to Remove a Jammed Document from iX1300

Do not use force to pull out a jammed document, and make sure to open the ADF top section first and then remove the document. For Return Scan, in which a document is inserted into the manual feeder and scanned, also open the ADF top section, and remove the jammed document.



- Be careful not to touch any sharp parts upon removing jammed documents. This may cause injury.
- Be careful not to get your accessories (for example, ties and necklaces) or hair caught inside the ScanSnap. This may cause injury.
- The glass surface may become extremely hot during operation. Be careful not to burn yourself.

- 1. Remove a document from the ADF paper chute (cover).**
- 2. Pull the ADF release tab towards you to open the ADF top section.**

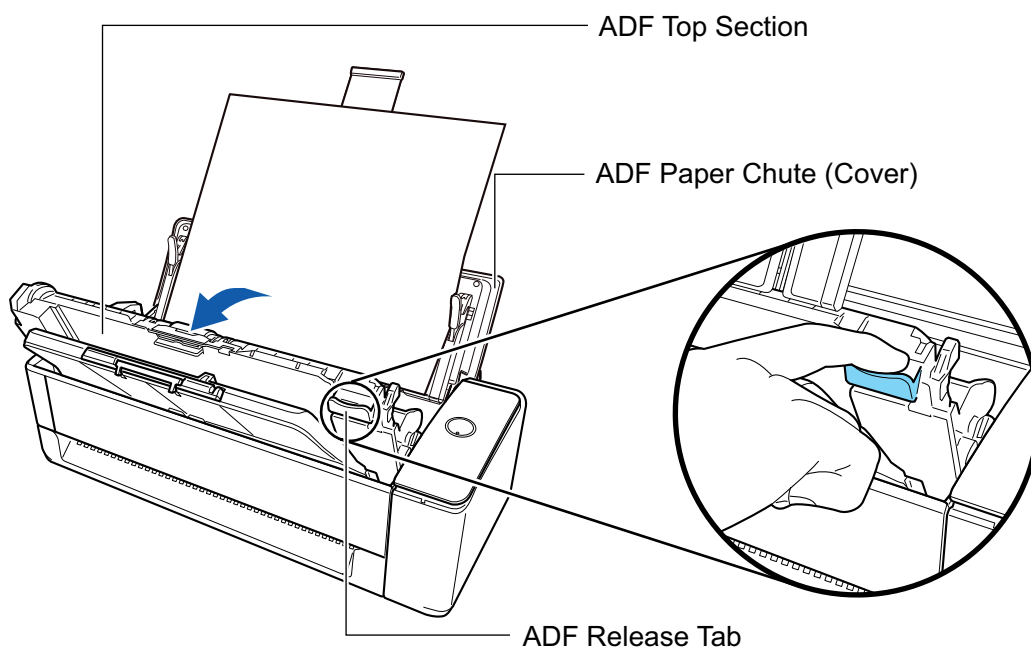

- 3. Remove a jammed document.**

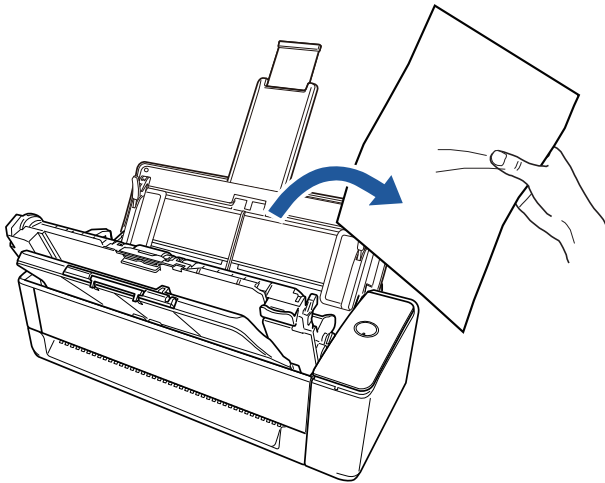

4. Close the ADF top section.

Close the ADF top section together with the stacker until it locks into position, indicated by a clicking sound.

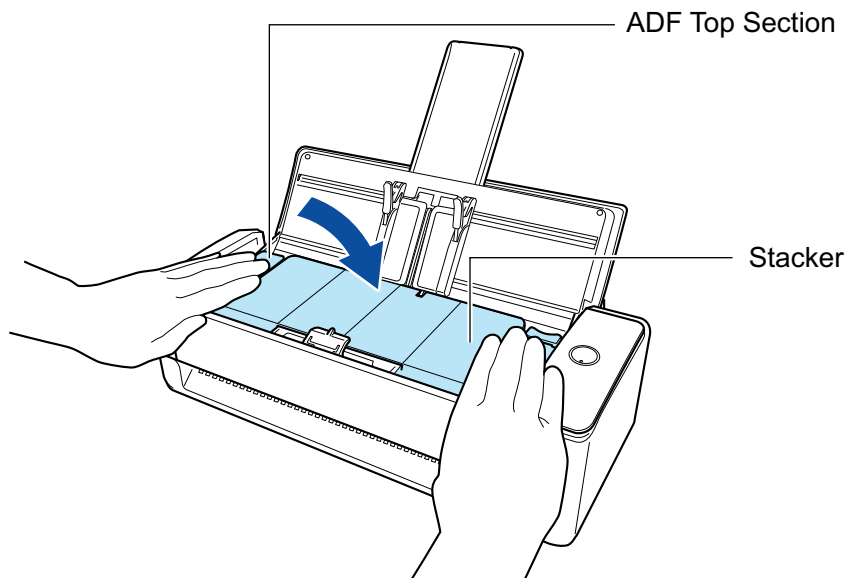

ATTENTION

Make sure that the ADF top section is completely closed.
Otherwise, paper jams or other feeding errors, or image faults may occur.

When the ADF top section is closed, the sound of the roller rotating comes out.
Load documents after the sound stops.

HINT

- If the stacker cannot be put back in the original position properly, open the ADF top section and close it again.
- Open the ADF top section in order to remove a jammed document even when a document is inserted into the manual feeder and scanned.



Scanning Documents with iX500

- "Documents to Scan (iX500)" (page 287)
- "Scanning Documents (iX500)" (page 291)
- "Scanning Long Pages (iX500)" (page 297)
- "Scanning Documents of Different Widths or Lengths in One Batch (iX500)" (page 301)
- "Scanning Documents Larger Than A4 or Letter Size (iX500)" (page 307)
- "Scanning Documents Such as Photographs and Clippings (iX500)" (page 311)

Documents to Scan (iX500)

This section explains about the conditions for documents that can be loaded directly into the ScanSnap and the conditions for documents that can be scanned using the Carrier Sheet.

Documents That Can Be Loaded Directly into the ScanSnap

Conditions for documents that can be loaded directly into the ScanSnap are as follows:

Document type	Office paper, postcards, business cards Plastic cards conforming to the ISO7810 ID-1 type (54 × 86 mm)
Paper weight	40 to 209 g/m ² (10.7 to 55.7 lb) Long page documents 52 to 128 g/m ² (13.9 to 33.9 lb) A8 size (52 × 72 mm) or less 128 to 209 g/m ² (33.9 to 55.7 lb) Plastic cards 0.76 mm (0.03 in.) or less (embossed cards can be used)
Paper size	Width 50.8 to 216 mm (2 to 8.5 in.) Length 50.8 to 360 mm (2 to 14.17 in.) For long page (*1), up to 863 mm (34 in.)

*1: Scanning starts when you hold down the [Scan] button on the ScanSnap for 3 seconds or longer.



If you scan a magnetic card or IC card, do not bring the black magnetic part in contact with the magnetic part of the ADF top section. Otherwise, the data on the card may be lost.

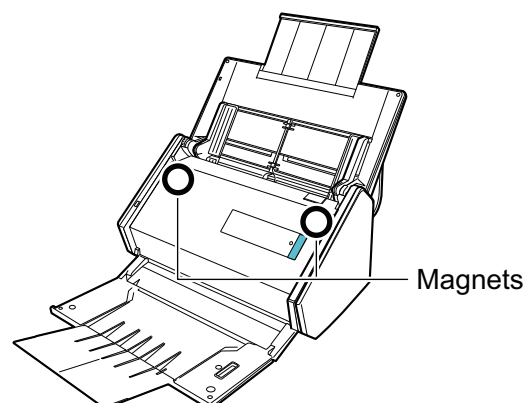

ATTENTION

- The following types of documents must not be scanned:
 - Documents attached with the metals such as paper clips or staples that can damage the inside of the ScanSnap
Remove the metals for scanning.
 - Documents on which the ink is still wet
Wait until the ink dries completely to scan these documents.
 - Documents larger than 216 × 863 (mm)/8.5 × 34 (in.) (width × length)
 - Documents other than paper such as fabric, metal foil and OHP film
- When you scan picture postcards, be aware that the picture side may get damaged. It is the responsibility of the customer to scan picture postcards.
- When you scan plastic cards, in [Multifeed Detection] of the [Paper] tab of the "ScanSnap Setup Window" (page 102), select [None] or [Check Length].
- Be careful of the following when you scan plastic cards:
 - Cards that are bent may not be fed properly.
 - If the surface of the card is dirty with grease marks such as fingerprints, perform scanning after wiping the dirt off.
 - When you scan plastic cards with strong luster, some parts of the image may appear lighter or darker than the original.

Example: gold colored credit card
 - When you scan embossed cards, put the embossed side down, and load the card in landscape orientation.
 - If the embossed characters are not coated in gold or silver and the background color of the card and the color of the embossed characters are similar, it may be difficult for the ScanSnap to recognize embossed characters.

In which case, performing the following may result in an improvement.
 1. Click the [Option] button in the [Scanning] tab of the "ScanSnap Setup Window" (page 102).
⇒ The [Scanning mode option] window appears.
 2. Select the [Increase text contrast] checkbox.

Documents That Can Be Scanned Using the Carrier Sheet

The bundled Carrier Sheet is a sheet designed to transport documents through the ScanSnap.

You can scan documents that are larger than A4/Letter size, photographs, and clippings.

Conditions for documents that can be scanned using the Carrier Sheet are as follows:



- Do not use a damaged Carrier Sheet. Otherwise, it may damage or cause the ScanSnap to malfunction.
- Be careful not to cut your finger on the edge of the Carrier Sheet.

Document type	Documents that cannot be loaded directly into the ScanSnap
Paper weight	Up to 209 g/m ² (55.7 lb) When scanning documents folded in half: Up to 105 g/m ² (27.9 lb)

Paper size	Carrier Sheet size (216 × 297 mm) A3 (297 × 420 mm) (*1) A4 (210 × 297 mm) A5 (148 × 210 mm) A6 (105 × 148 mm) B4 (257 × 364 mm) (*1) B5 (182 × 257 mm) B6 (128 × 182 mm) Postcard (100 × 148 mm) Business card (90 × 55 mm, 55 × 90 mm) Letter (8.5 × 11 in., 216 × 279.4 mm) 11 × 17 in. (279.4 × 431.8 mm) (*1) Custom size Width: 25.4 to 216 mm (1 to 8.5 in.) Length: 25.4 to 297 mm (1 to 11.69 in.)
-------------------	--

*1: Fold in half to scan.

Documents for Which the Carrier Sheet is Recommended for Scanning

It is recommended that you use the Carrier Sheet to scan the following documents.

- Documents written in pencil

Because there may be black traces left on the documents, it is recommended that you use the Carrier Sheet to scan such documents.

When you scan such documents directly without using a Carrier Sheet, dirt will accumulate on the rollers, which may cause feeding errors. Clean the rollers occasionally.

For details about how to perform cleaning, refer to "[Cleaning the Inside of iX500](#)" (page 526).

- Carbonless paper

Because carbonless paper may contain chemicals that can harm the ScanSnap internal rollers, it is recommended that you use the Carrier Sheet to scan such documents.

Make sure to clean the rollers occasionally to maintain the scanner performance when scanning carbonless paper directly without using the Carrier Sheet. For details about how to perform cleaning, refer to "[Cleaning the Inside of iX500](#)" (page 526).

Depending on the type of carbonless paper, the life span of the scanner may be shortened compared to scanning office paper.

- Scanning the following types of documents without using the Carrier Sheet can result in documents being damaged or scanned incorrectly

- Documents smaller than 50.8 × 50.8 (mm)/2 × 2 (in.) (width × length)
- Documents whose paper weight is less than 40 g/m² (10.7 lb)
- Documents with an uneven surface (such as envelopes and paper sheets with attached materials)
- Wrinkled or curled documents
- Folded or torn documents
- Tracing paper
- Coated paper
- Photographs (photographic paper)
- Perforated or punched documents
- Documents that are not rectangular or square

- Carbon paper or thermal paper
- Documents with memo papers or sticky notes attached

ATTENTION

- Using the Carrier Sheet

Be careful of the following when you use the Carrier Sheet:

- Do not stain, or cut the black and white patterned end of the Carrier Sheet. Otherwise, the Carrier Sheet will not be recognized properly.
- Do not place the Carrier Sheet upside down. Otherwise, a paper jam may occur and damage the Carrier Sheet and the document inside.
- Do not fold or pull the Carrier Sheet.
- Paper jams may occur when several small size documents such as photographs and postcards are placed inside the Carrier Sheet to be scanned at once. It is recommended that you scan such documents one at a time.
- If paper jams occur frequently, feed about 50 sheets of PPC paper (recycled paper) before scanning with the Carrier Sheet. The PPC paper can either be blank or printed.

- Storing the Carrier Sheet

Be careful of the following when you store the Carrier Sheet:

- Do not leave your document inside the Carrier Sheet for a long time. Otherwise, the ink on the document may be transferred onto the Carrier Sheet.
- Do not leave the Carrier Sheet in high temperature places such as under direct sunlight or near a heating apparatus for a long time. Also, do not use the Carrier Sheet in high temperature places. The Carrier Sheet may be deformed.
- To avoid deformation, store the Carrier Sheet on a flat surface without any weight on it.

Scanning Documents (iX500)

You can load documents such as handouts for meetings or business cards directly in the ScanSnap for scanning.

For details about documents that can be scanned, refer to ["Documents to Scan \(iX500\)" \(page 287\)](#).

1. If you are loading multiple sheets, check the number of sheets.

The maximum number of sheets in the ScanSnap is as follows:

For A4 or smaller sizes: Up to 50 sheets can be loaded (with paper weight of 80 g/m² [20 lb] and thickness of the document stack under 5 mm [0.2 in.]).

ATTENTION

If you try to scan more than the maximum amount that can be loaded, the following problems may occur:

- Files cannot be properly created due to excessive file size.
- Paper jams occur during scanning.

2. Fan the documents.

1. Hold both ends of the documents and fan them a few times.

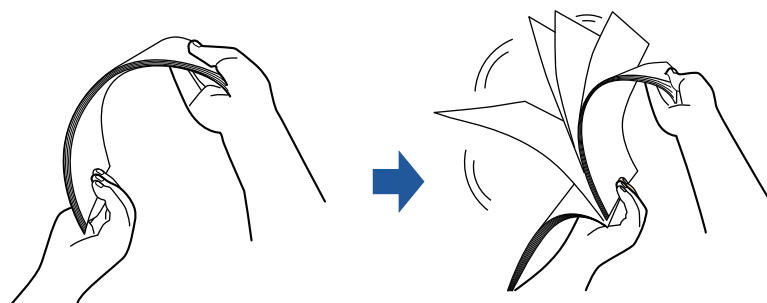

2. Rotate the documents 90 degrees and fan them in the same manner.

3. Straighten the edges of the documents and slightly displace the top edges at an angle.

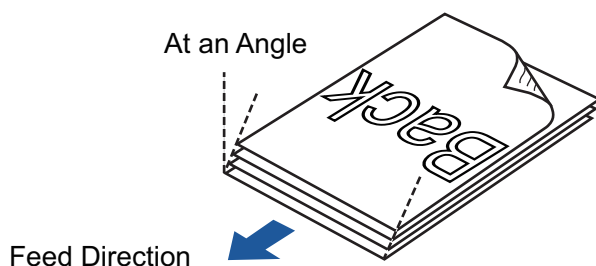

ATTENTION

Paper jams or damage to documents may occur if you scan the documents without aligning the edges first.

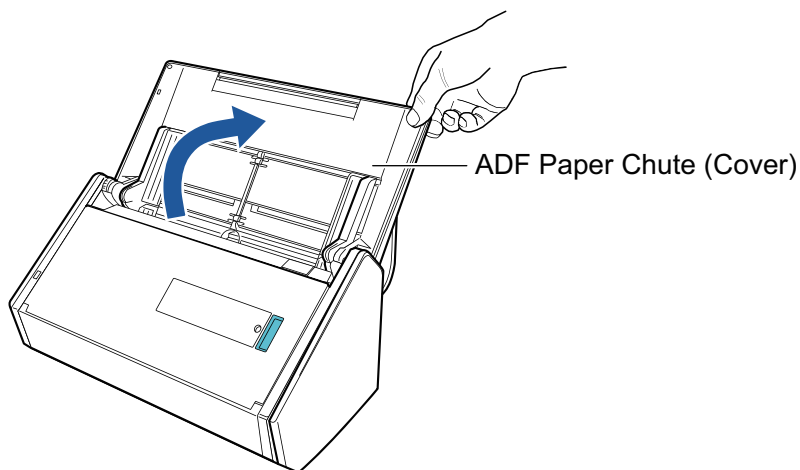
4. Open the ADF paper chute (cover) of the ScanSnap.

⇒ The [Scan] button flashes in blue. The button returns to being lit normally when document scanning is enabled.

In addition, the ScanSnap Manager icon in the notification area located at the far right of

the taskbar changes from  to .

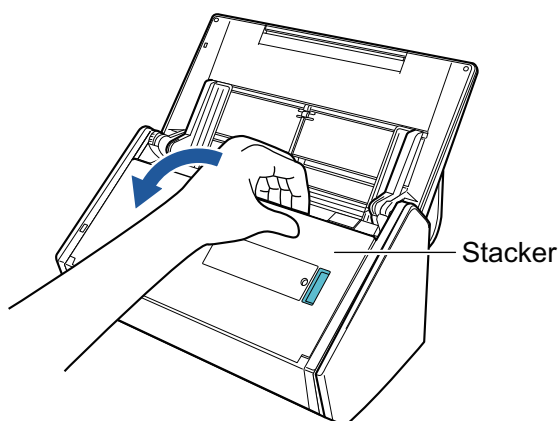
5. Pull the stacker towards you.**6. Depending on documents to scan, pull out the extension on the ADF paper chute (cover) and open the stacker.**

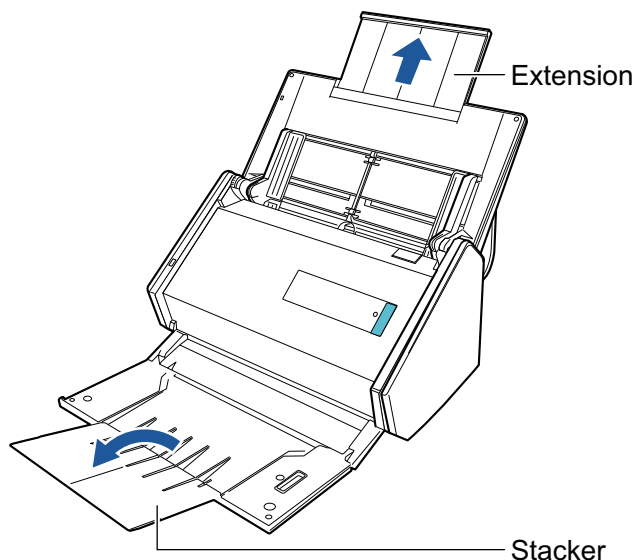

7. Load the documents in the ADF paper chute (cover).

Load the document face-down and head-first with the back facing you (when loading multiple documents, the last page is on the top). Adjust the number of documents so that they do not go beyond the reference marks and are kept within the side guides when they are loaded.

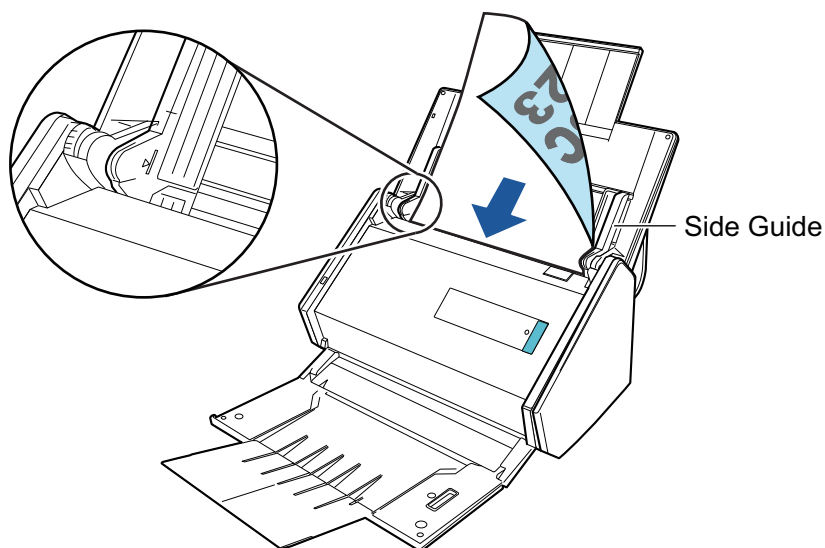

ATTENTION

- Do not accumulate more than 50 sheets (with paper weight of 80 g/m² [20 lb]) in the stacker.
- When the [Place document face up] checkbox is selected in the [Scanning mode option] window, load the documents face-up and bottom edge down.

To open the [Scanning mode option] window, click the [Option] button in the [Scanning] tab of the "ScanSnap Setup Window" (page 102).

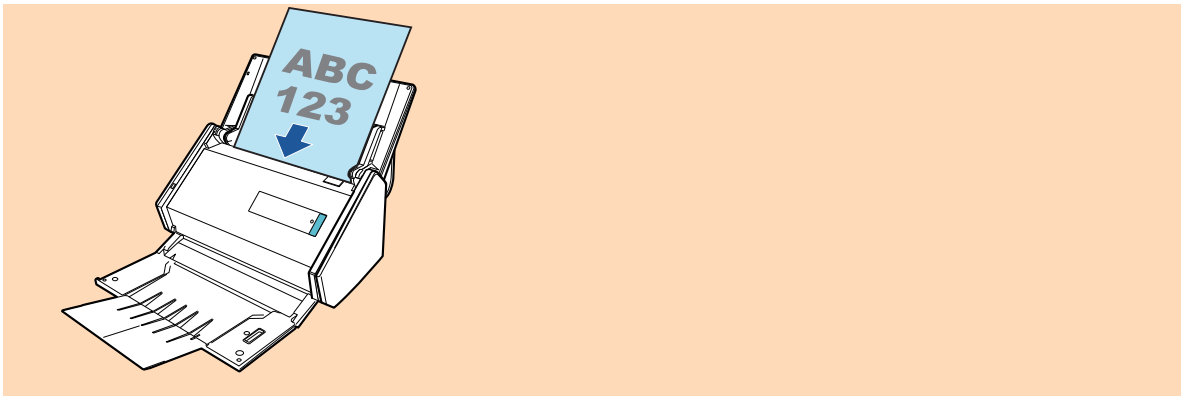

8. Adjust the side guides to the width of the documents.

Hold each side guide in the middle to adjust them. Otherwise, the documents may be fed skewed.

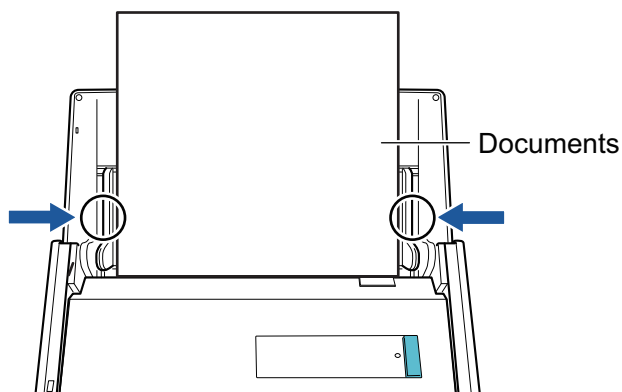

9. Press the [Scan] button on the ScanSnap to start a scan.

ATTENTION

Do not perform the following operations during scanning. Doing so will stop scanning.

- Connect or disconnect the ScanSnap and other USB devices.
- Close the ADF paper chute (cover).
- Switch users.
- Allow the computer to enter sleep mode.

⇒ The [Scan] button on the ScanSnap flashes in blue while the documents are being scanned.

The [ScanSnap Manager - Image scanning and file saving] window appears.

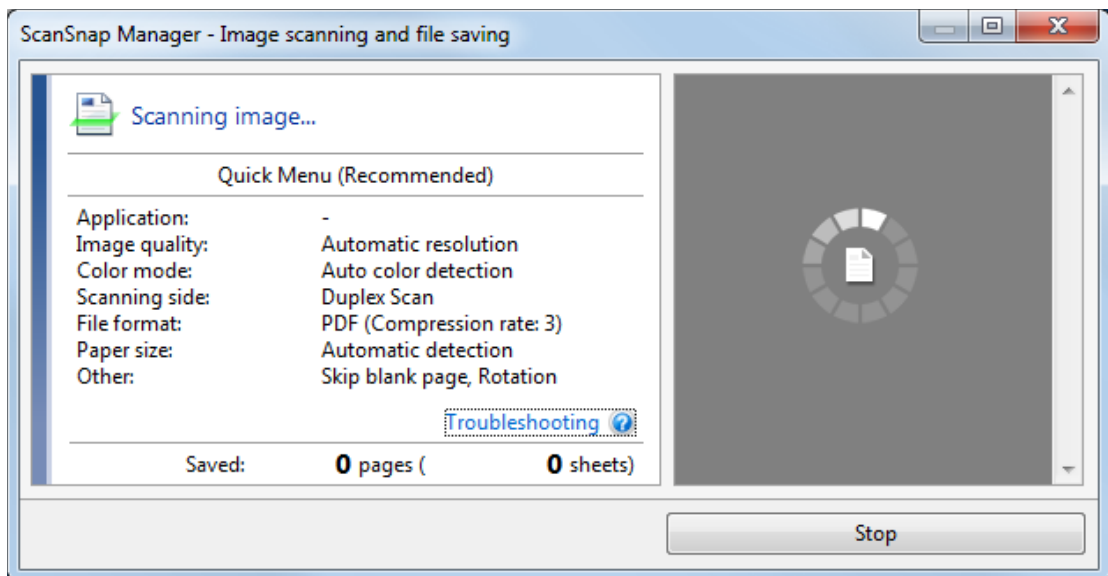

⇒ The Quick Menu appears when the scanning is completed.

10. In the Quick Menu, click the icon of the application to link with ScanSnap Manager.

For details about linking the following applications with ScanSnap Manager, refer to "[Useful Usages](#)" (page 439).

- Save Documents
- Save Business Cards
- Save Receipts
- Save Photos

HINT

The following applications are displayed in the Quick Menu when ScanSnap Organizer and CardMinder are installed.

- When ScanSnap Organizer is installed
ScanSnap Organizer
- When CardMinder is installed
CardMinder



⇒ The selected application starts up. For details, refer to the Advanced Operation Guide.

ATTENTION

- You cannot start scanning when the Quick Menu is displayed. Either select an icon from the Quick Menu and finish the process, or close the Quick Menu before you perform the next scan.
- Do not move, delete, or rename scanned images using other applications while the Quick Menu is displayed.

HINT

- Clicking  displays the description of an application. Placing the mouse cursor over the icon of another application displays the description of the application.
- Performing a scan while an application that can be automatically linked with is active automatically starts the linkage between ScanSnap Manager and the application.
For details, refer to the Advanced Operation Guide.

Scanning Long Pages (iX500)

Documents up to 863 mm (34 in.) in length can be scanned.

For details about documents that can be scanned, refer to "[Documents to Scan \(iX500\)](#)" (page 287).

HINT

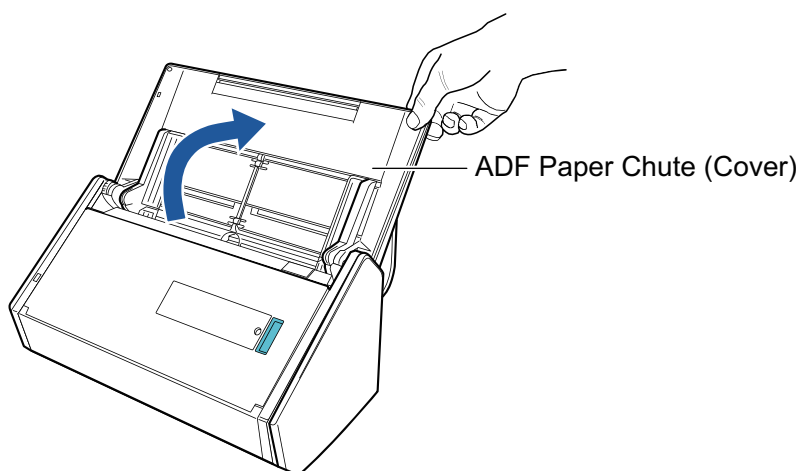

For details about how to load documents that are 360 mm (14.17 in.) or less in length, refer to "[Scanning Documents \(iX500\)](#)" (page 291).

1. Open the ADF paper chute (cover) of the ScanSnap.



⇒ The [Scan] button flashes in blue. The button returns to being lit normally when document scanning is enabled.

In addition, the ScanSnap Manager icon in the notification area located at the far right of

the taskbar changes from  to .

2. Pull the stacker towards you.

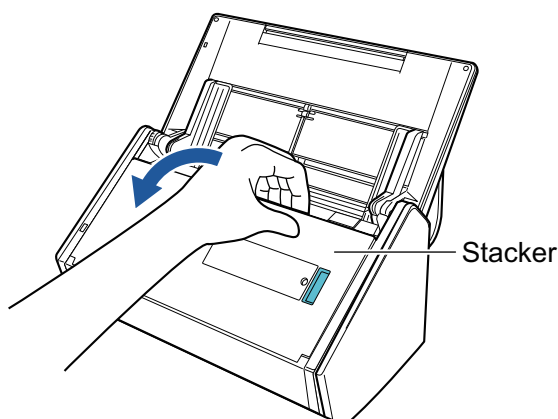

3. Pull out the extension on the ADF paper chute (cover) and open the stacker.

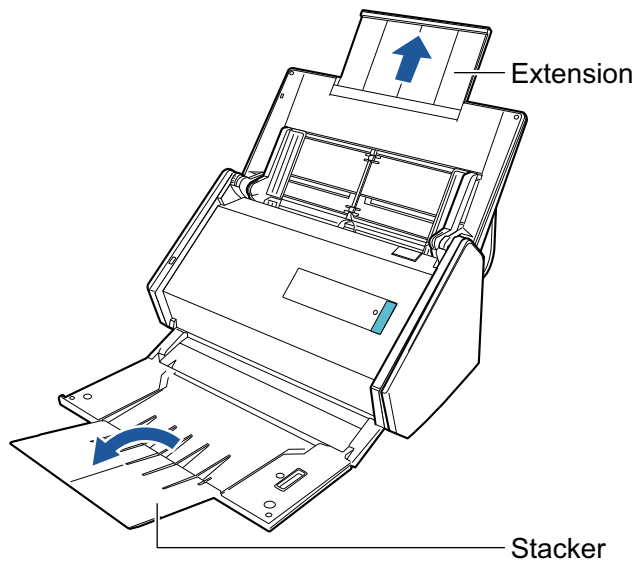

4. Load only one document in the ADF paper chute (cover).

Hold the document with your hand so that it does not fall out of the ADF paper chute (cover).

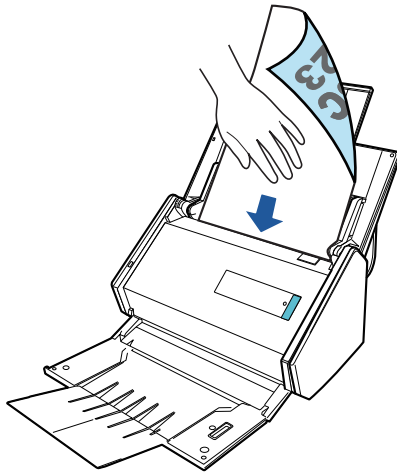

5. Press the [Scan] button on the ScanSnap (for three seconds or longer) until the button flashes in blue to start a scan.

ATTENTION

- Secure enough space where the scanned documents are ejected from the ScanSnap, and pick up the documents with your hands to prevent them from falling off the unit where the ScanSnap is placed on.

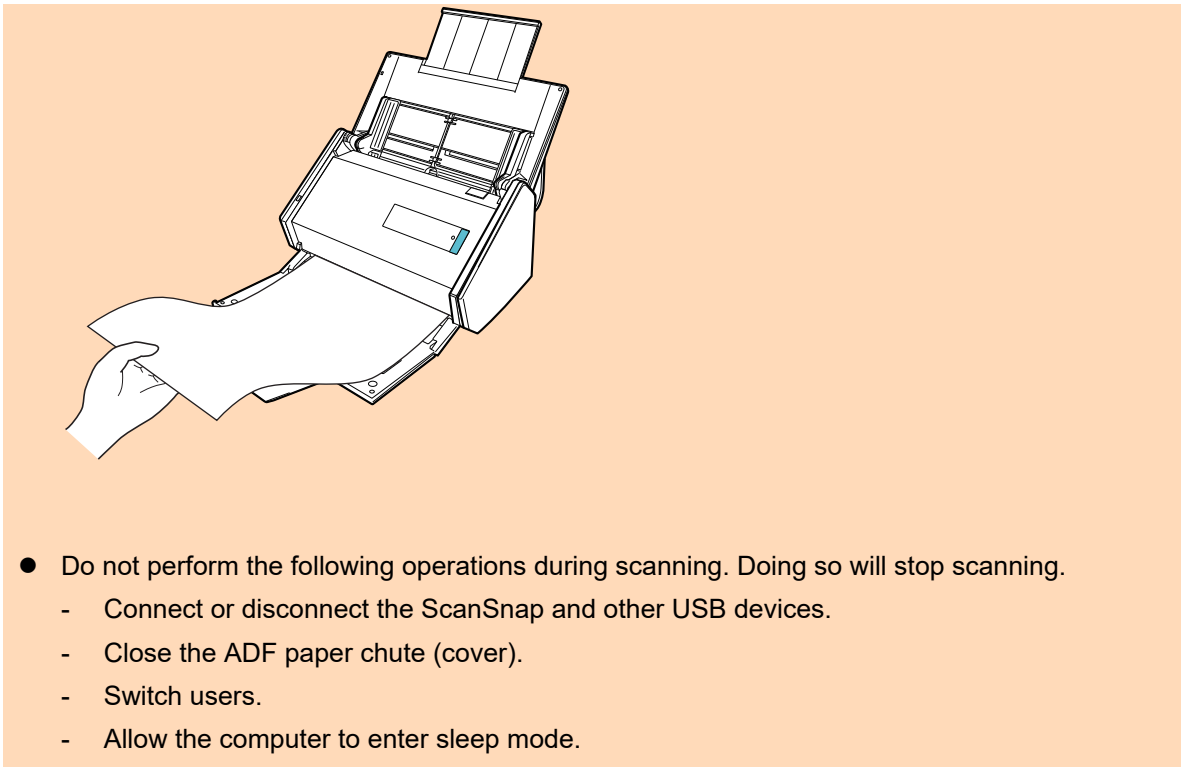

HINT

When you scan the first page as a long page and continue scanning, the subsequent documents are also scanned as long pages.

⇒ The [Scan] button on the ScanSnap flashes in blue while the documents are being scanned.

The [ScanSnap Manager - Image scanning and file saving] window appears.

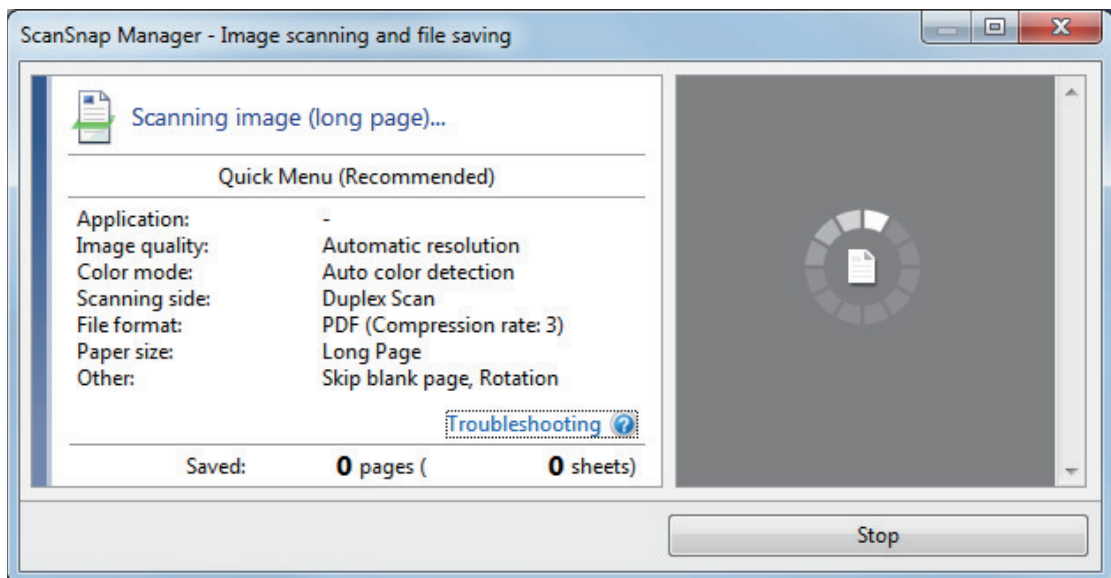

⇒ The Quick Menu appears when the scanning is completed.

6. In the Quick Menu, click the icon of the application to link with ScanSnap Manager.

When you select [Save Documents], you can manage scanned images by folder with ScanSnap Home.

For details, refer to "Managing Paper Documents by Folder on a Computer with ScanSnap Home" (page 440).

HINT

[ScanSnap Organizer] is displayed in the Quick Menu when ScanSnap Organizer is installed. To manage scanned images by folder with ScanSnap Organizer, refer to "Managing Paper Documents by Folder on a Computer with ScanSnap Organizer" (page 443).

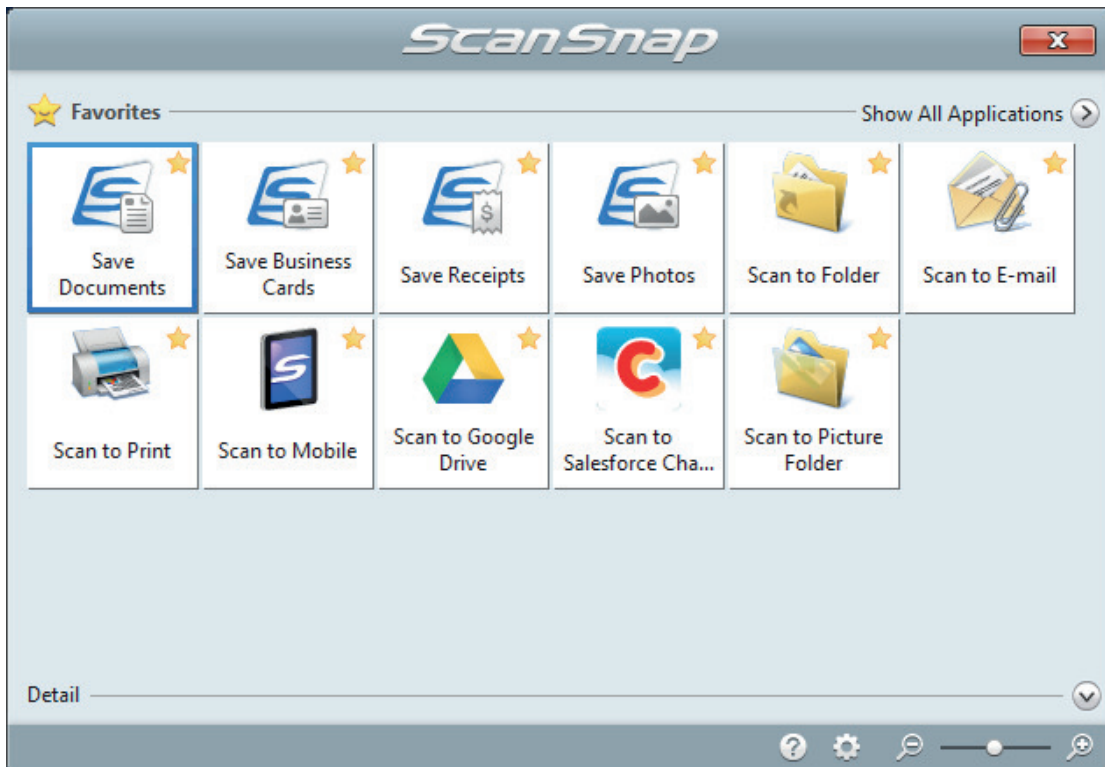

⇒ The selected application starts up. For details, refer to the Advanced Operation Guide.

ATTENTION

- You cannot start scanning when the Quick Menu is displayed. Either select an icon from the Quick Menu and finish the process, or close the Quick Menu before you perform the next scan.
- Do not move, delete, or rename scanned images using other applications while the Quick Menu is displayed.

HINT

- Clicking  displays the description of an application. Placing the mouse cursor over the icon of another application displays the description of the application.
- Performing a scan while an application that can be automatically linked with is active automatically starts the linkage between ScanSnap Manager and the application. For details, refer to the Advanced Operation Guide.

Scanning Documents of Different Widths or Lengths in One Batch (iX500)

Documents of different widths or lengths can be scanned in one batch.

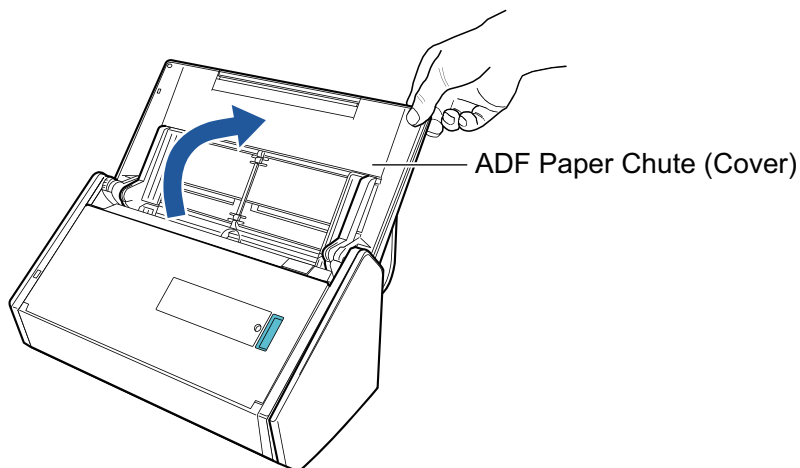

For details about documents that can be scanned, refer to "[Documents to Scan \(iX500\)](#)" (page 287).

1. Open the ADF paper chute (cover) of the ScanSnap.



⇒ The [Scan] button flashes in blue. The button returns to being lit normally when document scanning is enabled.

In addition, the ScanSnap Manager icon in the notification area located at the far right of

the taskbar changes from  to .

2. Pull the stacker towards you.

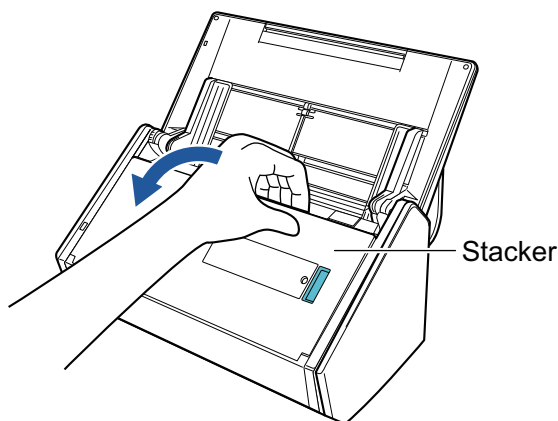

3. Depending on documents to scan, pull out the extension on the ADF paper chute (cover) and open the stacker.

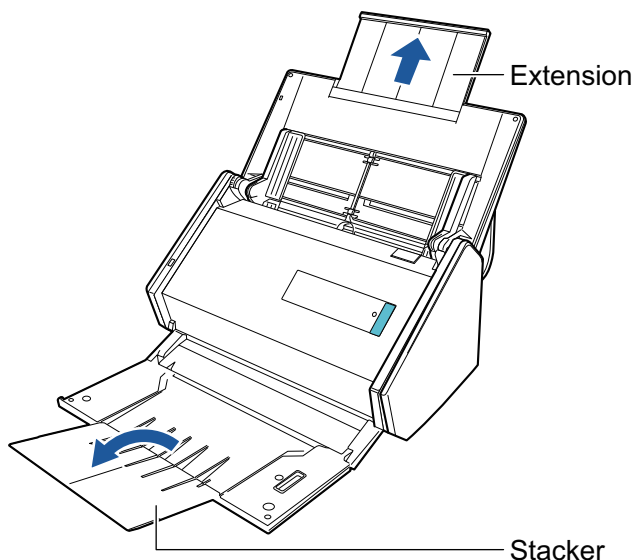

4. Right-click the ScanSnap Manager icon  in the notification area located at the far right of the taskbar, and select the [Scan Button Settings] from the "Right-Click Menu" (page 100).

⇒ The ScanSnap setup window appears.

5. In the [Paper] tab, select [Automatic detection] in [Paper size].

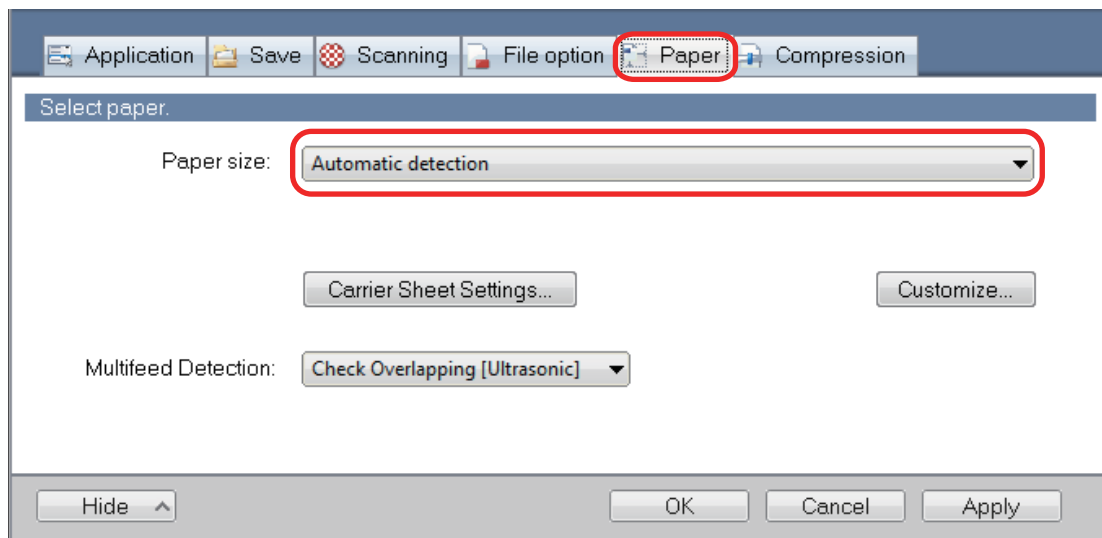

6. Select [None] in [Multifeed Detection].

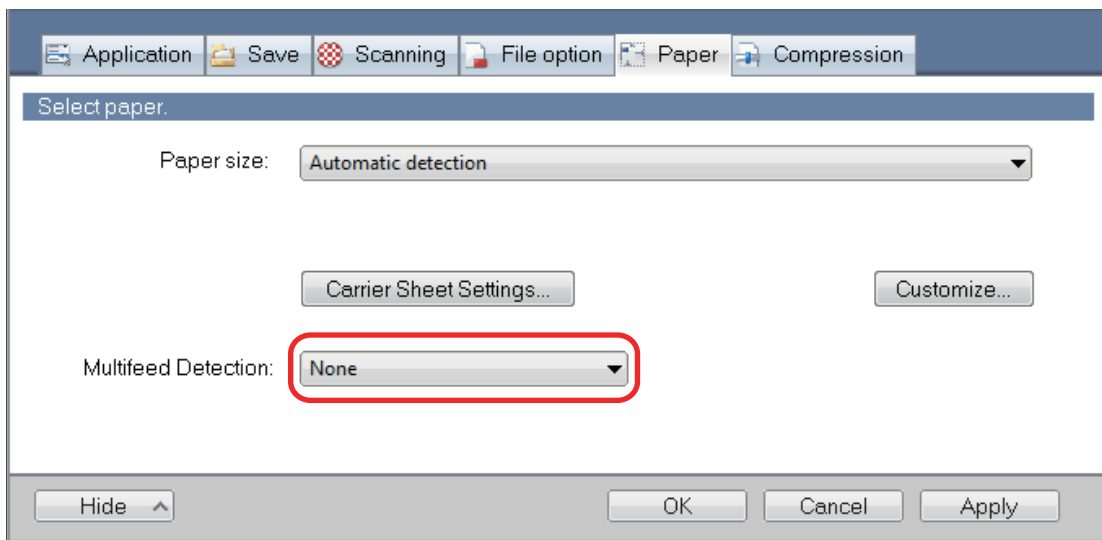

7. Click the [OK] button to close the ScanSnap setup window.

8. Load documents in the ScanSnap.

1. Align the edges of the documents.

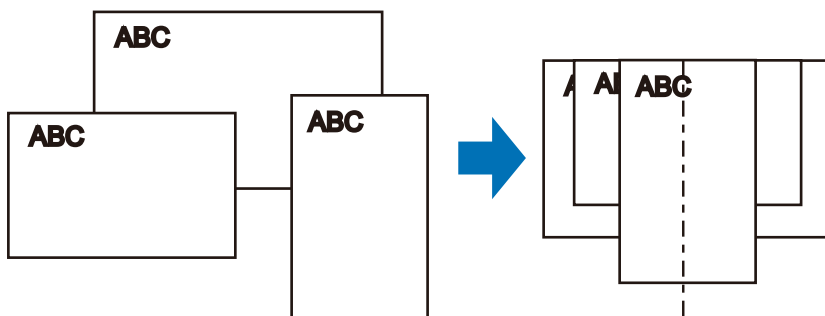

2. Load the documents face-down and top-first with the back of the last document facing you.

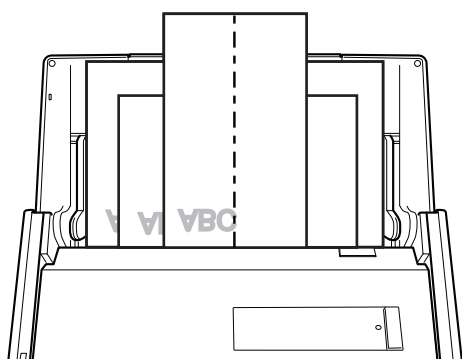

ATTENTION

- The pick roller feeds the documents. Load all documents over one another above the pick roller (center). Documents that are not loaded above the pick roller cannot be fed.

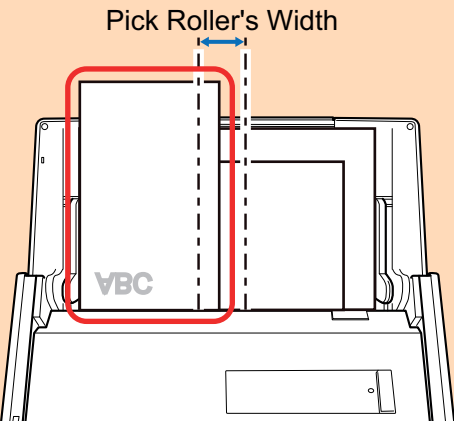

Incorrect

- Adjust the side guides to the widest document. If the side guides are not adjusted properly, a paper jam may occur.
- Load smaller documents so that they can be scanned straight.

If the documents are skewed during scanning, the following problems may occur:

- Part of the document does not appear in the scanned image
- Slant lines appear in the scanned image
- The documents are scanned in a wrong paper size

If the documents are not scanned straight, it is recommended that you select the [Continue scanning after last page] checkbox in the [Scanning] tab of the ["ScanSnap Setup Window"](#) (page 102), separate the documents by their widths, and scan them in different batches.

9. Press the [Scan] button on the ScanSnap to start a scan.

ATTENTION

Do not perform the following operations during scanning. Doing so will stop scanning.

- Connect or disconnect the ScanSnap and other USB devices.
- Close the ADF paper chute (cover).
- Switch users.
- Allow the computer to enter sleep mode.

⇒ The [Scan] button on the ScanSnap flashes in blue while the documents are being scanned.

The [ScanSnap Manager - Image scanning and file saving] window appears.

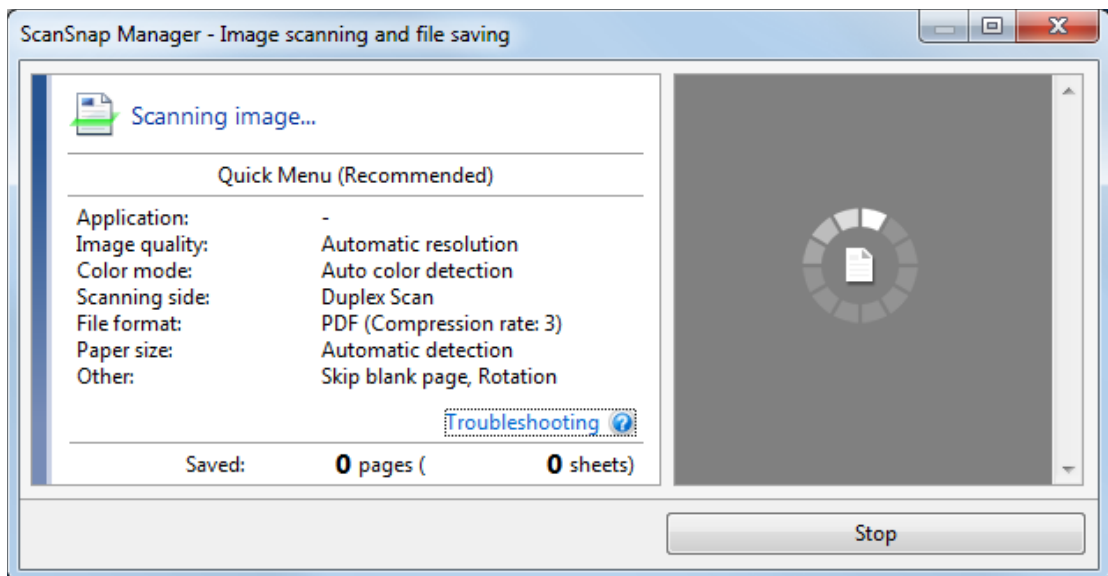

⇒ The Quick Menu appears when the scanning is completed.

10. In the Quick Menu, click the icon of the application to link with ScanSnap Manager.

When you select [Save Documents], you can manage scanned images by folder with ScanSnap Home.

For details, refer to "Managing Paper Documents by Folder on a Computer with ScanSnap Home" (page 440).

HINT

[ScanSnap Organizer] is displayed in the Quick Menu when ScanSnap Organizer is installed. To manage scanned images by folder with ScanSnap Organizer, refer to "Managing Paper Documents by Folder on a Computer with ScanSnap Organizer" (page 443).



⇒ The selected application starts up. For details, refer to the Advanced Operation Guide.

ATTENTION

- You cannot start scanning when the Quick Menu is displayed. Either select an icon from the Quick Menu and finish the process, or close the Quick Menu before you perform the next scan.
- Do not move, delete, or rename scanned images using other applications while the Quick Menu is displayed.

HINT

- Clicking  displays the description of an application. Placing the mouse cursor over the icon of another application displays the description of the application.
- Performing a scan while an application that can be automatically linked with is active automatically starts the linkage between ScanSnap Manager and the application.
For details, refer to the Advanced Operation Guide.

Scanning Documents Larger Than A4 or Letter Size (iX500)

Documents larger than A4/Letter size (such as A3, 11 × 17 in. and B4) can be scanned with the optional Carrier Sheet. By folding the document in half and scanning in duplex mode, the two sides are merged into a single image.

For details about documents that can be loaded, refer to "[Documents to Scan \(iX500\)](#)" (page 287).

ATTENTION

The [Deskew by text on document] checkbox in the [Scanning mode option] window will be disabled.

To open the [Scanning mode option] window, click the [Option] button in the [Scanning] tab of the "[ScanSnap Setup Window](#)" (page 102).

HINT

Both sides of a double-sided A4/Letter size document or smaller can also be scanned and merged into a single image.

1. **Right-click the ScanSnap Manager icon  in the notification area located at the far right of the taskbar, and select the [Scan Button Settings] from the "Right-Click Menu" (page 100).**
⇒ The ScanSnap setup window appears.
2. **In the [Paper] tab, select [Automatic detection] in [Paper size], and then click the [Carrier Sheet Settings] button.**

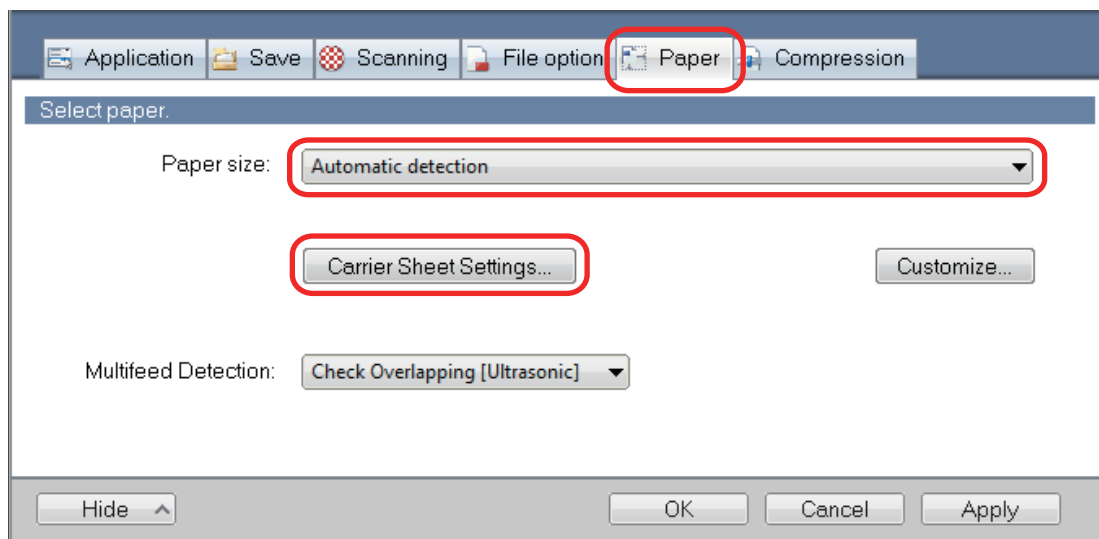

⇒ The [Carrier Sheet Settings] window appears.

3. **Select [one double-page spread image] in [Save as] and click the [OK] button.**

For details, refer to the ScanSnap Manager Help.

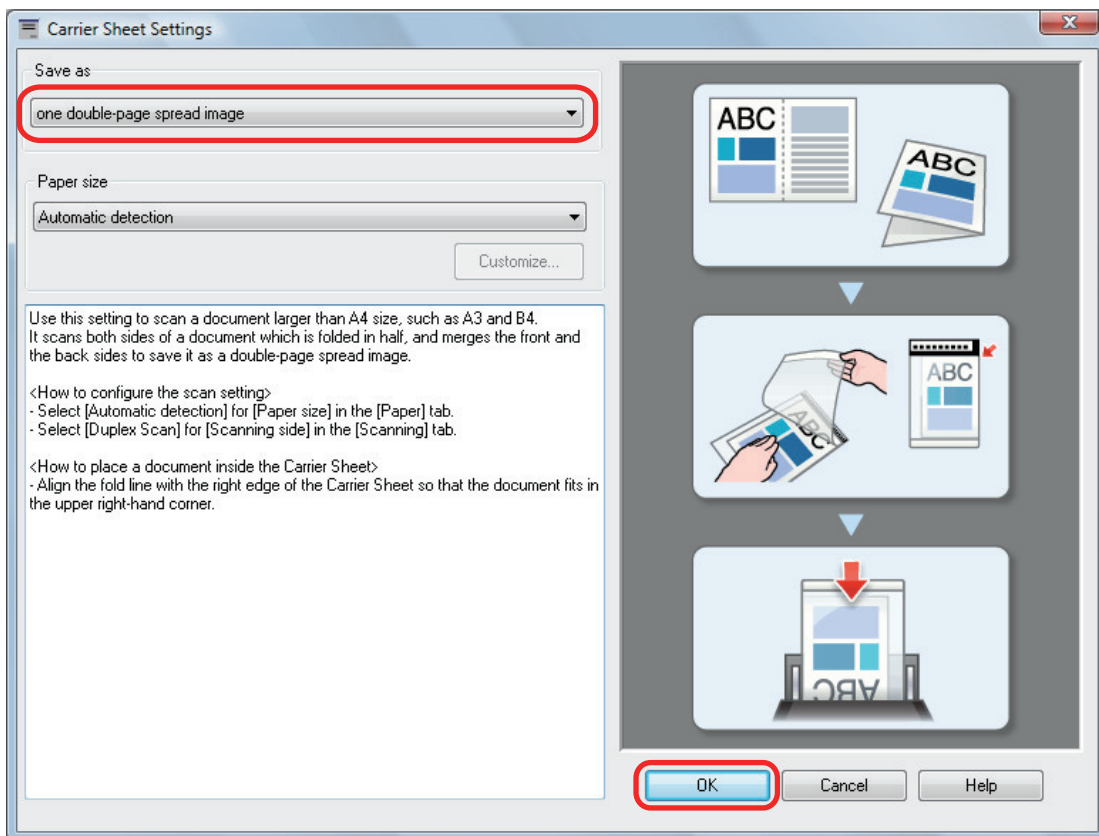

4. In [Scanning side] in the [Scanning] tab, select [Duplex Scan (Double-sided)] and click the [OK] button.

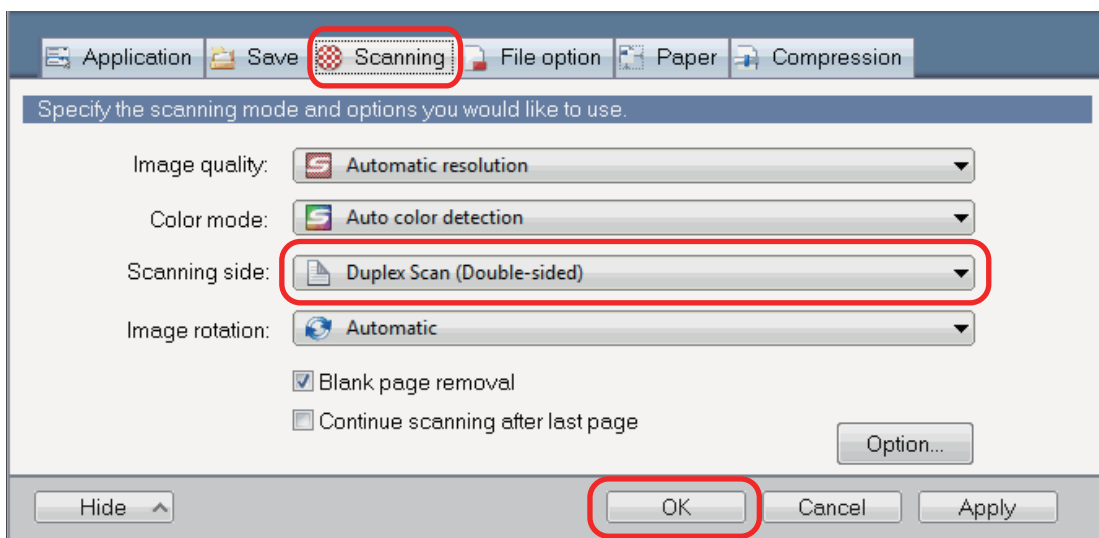

ATTENTION

If [Simplex Scan (Single-sided)] is selected, the ScanSnap outputs the same result as performing a simplex scan in [two separate images (front and back)] mode.

5. Place the document inside the Carrier Sheet.

1. Fold the document in half with the sides to be scanned facing out.
Fold it tightly and smooth out any creases.

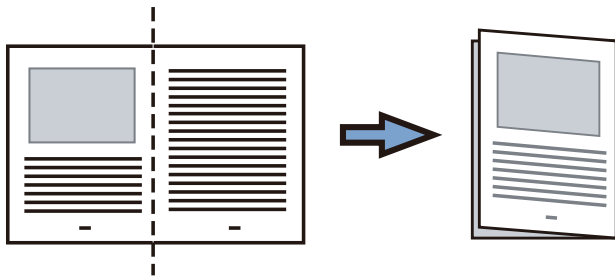

2. Open the Carrier Sheet to bind the document.

Align the fold line with the right edge of the Carrier Sheet so that the document fits in the upper right-hand corner of the Carrier Sheet.

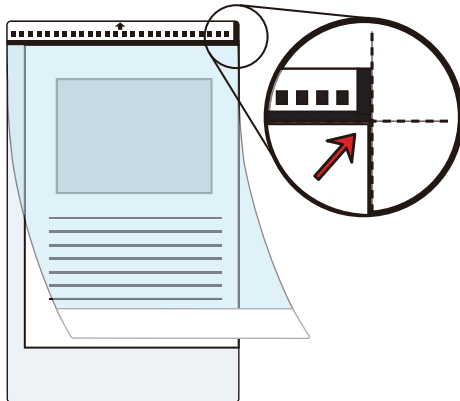

HINT

Note that the front side of the Carrier Sheet has a black and white pattern at the top and a thick vertical line in the upper right-hand corner.

6. Place the end with the black and white pattern as the leading edge in the direction of the arrow.

Secure the Carrier Sheet with the side guides to avoid skewing.

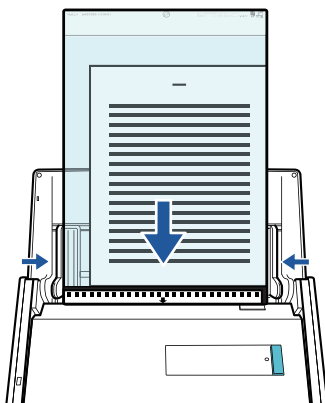

7. Press the [Scan] button on the ScanSnap to start a scan.

⇒ Both sides of the document are scanned and saved as one double-page spread image.

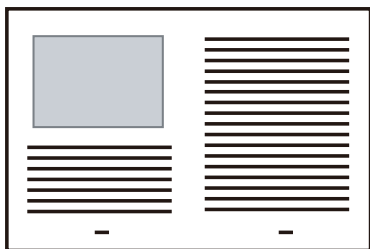

ATTENTION

- There may be a line or a gap appearing between the front and back side images. Also when you scan a thick document in the Carrier Sheet, the scanned image on the left and the scanned image on the right of a double-page spread image may skew towards each other from the top.

These symptoms may be improved when you place the document in the Carrier Sheet as follows:

- Fold the document properly
- Neatly align the edges of the document with the edges of the Carrier Sheet
- Turn over the Carrier Sheet to the other (reverse) side
- If [Automatic detection] is specified for [Paper size] in the [Carrier Sheet Settings] window, an optimal size will be selected automatically from the available standard sizes (A3, B4, or 11 × 17 in.) in [Paper size]. Note that the size of the image may become smaller than the original document depending on the document.

Example: When characters and illustrations are printed to fit in A4 size in the center of an A3 size document, the scanned image is output in B4 size.

To output the scanned image in its original size, specify the document size in [Paper size].

- Part of the scanned image around where the document is folded may appear missing. In that case, place the document so that its edge is about 1 mm (0.04 in.) inside from the edge of the Carrier Sheet.

HINT

Multiple Carrier Sheets can be loaded in the ADF paper chute (cover) and scanned.

Scanning Documents Such as Photographs and Clippings (iX500)

Using the optional Carrier Sheet allows you to scan documents that can be damaged quite easily such as photographs, or non-standard size documents that are difficult to load directly such as clippings.

For details about documents that can be loaded, refer to "[Documents to Scan \(iX500\)](#)" (page 287).

ATTENTION

The [Deskew by text on document] checkbox in the [Scanning mode option] window will be disabled.

To open the [Scanning mode option] window, click the [Option] button in the [Scanning] tab of the "[ScanSnap Setup Window](#)" (page 102).

1. **Right-click the ScanSnap Manager icon  in the notification area located at the far right of the taskbar, and select the [Scan Button Settings] from the "Right-Click Menu" (page 100).**
⇒ The ScanSnap setup window appears.
2. **In the [Paper] tab, select [Automatic detection] in [Paper size], and then click the [Carrier Sheet Settings] button.**

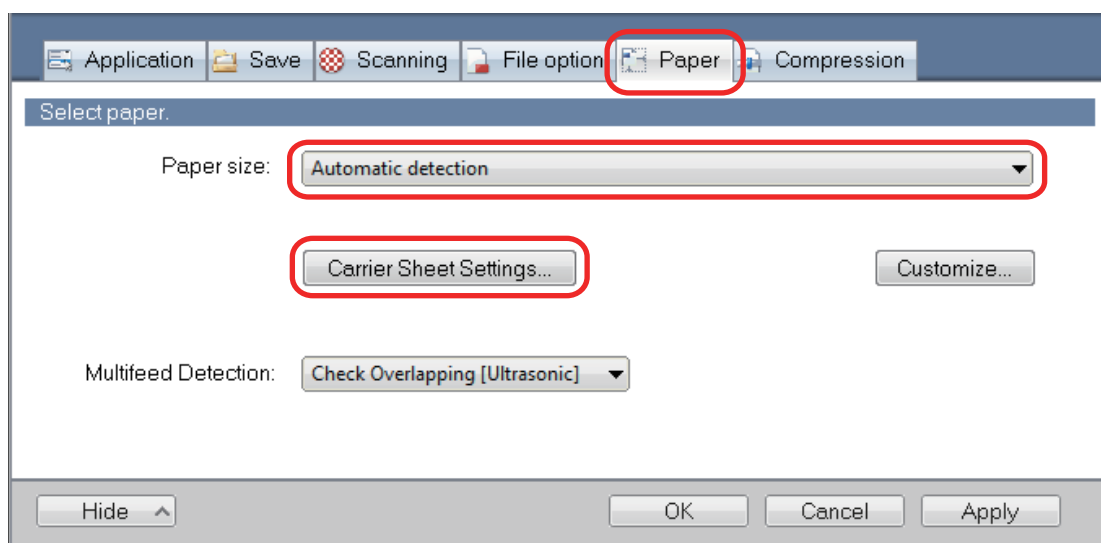

⇒ The [Carrier Sheet Settings] window appears.

3. **Select [two separate images (front and back)] in [Save as] and click the [OK] button.**

For details, refer to the ScanSnap Manager Help.

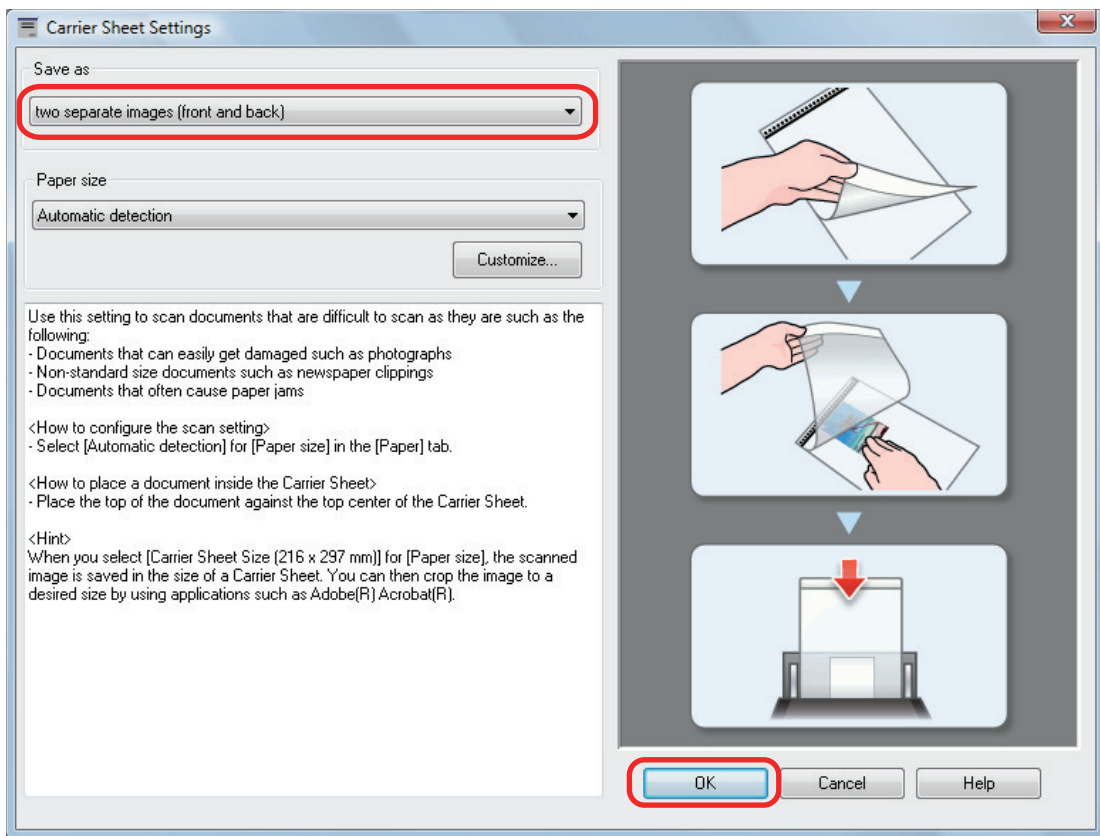

4. Click the [OK] button to close the ScanSnap setup window.

5. Place the document inside the Carrier Sheet.

Open the Carrier Sheet and place the top of the document against the top center of the Carrier Sheet.

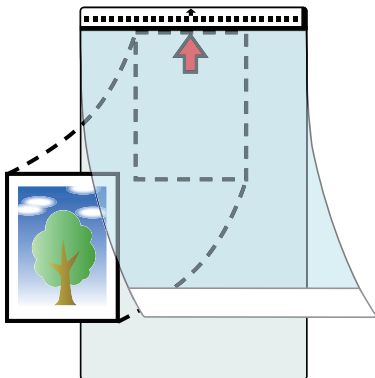

6. Place the end with the black and white pattern as the leading edge in the direction of the arrow.

Place the back side of the document towards you.

Secure the Carrier Sheet with the side guides to avoid skewing.

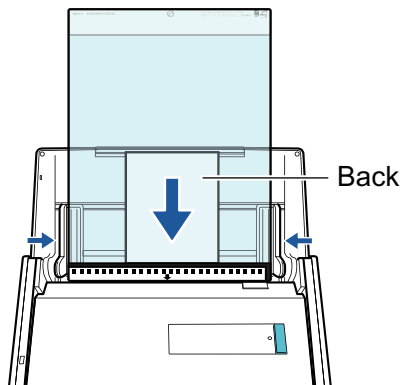

ATTENTION

When the [Place document face up] checkbox is selected in the [Scanning mode option] window, place the document in the Carrier Sheet face-up and bottom edge down.

To open the [Scanning mode option] window, click the [Option] button in the [Scanning] tab of the "ScanSnap Setup Window" (page 102).

7. Press the [Scan] button on the ScanSnap to start a scan.

⇒ When scanning is completed, the scanned image is saved.

ATTENTION

- The scanned image is output at the center of the page in the size specified for [Paper size] in the [Carrier Sheet Settings] window.
- If [Automatic detection] is specified for [Paper size] in the [Carrier Sheet Settings] window, an optimal size will be selected automatically from the available standard sizes in [Paper size]. Note that the size of the image may become smaller than the original document depending on the document scanned, or part of the image may appear missing.

Example: When the contents are printed to fit in A5 size in the center of an A4 size document, the scanned image is output in A5 size.

To output the scanned image in its original size, specify the document size in [Paper size].

HINT

- In the following cases, place a blank (white) sheet of paper underneath the document when scanning:
 - The scanned image is not saved in the correct size (when [Automatic detection] is selected for [Paper size] in the [Carrier Sheet Settings] window)
 - Shadows appear around the edges of the scanned image
 - Black lines appear around the edges of a uniquely shaped cutting document if you place the document in the Carrier Sheet

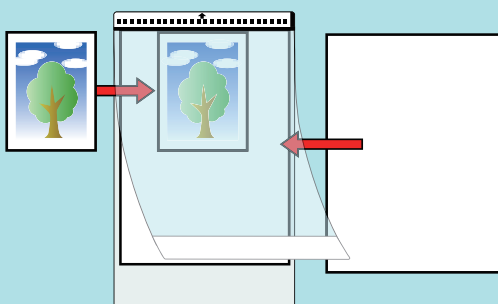

- Multiple Carrier Sheets can be loaded in the ADF paper chute (cover) and scanned.

Scanning Documents with iX100

- "Documents to Scan (iX100)" (page 316)
- "Scanning Documents (iX100)" (page 320)
- "Scanning Documents by Inserting Two Documents at a Time or by Inserting the Next Document While the Current Document Is Being Scanned (iX100)" (page 325)
- "Scanning Documents Larger Than A4 or Letter Size by Directly Inserting Them in the ScanSnap (iX100)" (page 332)
- "Scanning Documents Larger than A4 or Letter Size with the Carrier Sheet (iX100)" (page 336)
- "Scanning Documents Such as Photographs and Clippings (iX100)" (page 341)

Documents to Scan (iX100)

This section explains about the conditions for documents that can be loaded directly into the ScanSnap and the conditions for documents that can be scanned using the Carrier Sheet.

Documents That Can Be Loaded Directly into the ScanSnap

Conditions for documents that can be loaded directly into the ScanSnap are as follows:

Eject method (*1)	With the output guide closed	With the output guide open
Document type	Office paper, postcards, business cards Plastic cards conforming to the ISO7810 ID-1 type (54 × 86 mm/3.37 × 2.13 in.) (*2)	Office paper
Paper weight	52 to 209 g/m ² (14 to 56.1 lb) When merging scanned images automatically (*3) 52 to 105 g/m ² (14 to 28 lb) Plastic cards 0.76 mm (0.03 in.) or less (embossed cards can be used)	52 to 80 g/m ² (14 to 20 lb)
Paper size	Width 25.4 to 216 mm (1 to 8.5 in.) For a dual scan, a total width of 200 mm (7.87 in.) or less for two documents Length 25.4 to 863 mm (1 to 34 in.) When merging scanned images automatically (*3) <ul style="list-style-type: none"> ● A3 (297 × 420 mm) ● B4 (257 × 364 mm) ● Double Letter (11 × 17 in. (279.4 × 432 mm)) 	

*1: For details about the eject methods, refer to "Parts and Functions of iX100" (page 86).

*2: A dual scan cannot be used for plastic cards.

*3: Fold in half to scan.

ATTENTION

- The following types of documents must not be scanned:
 - Documents attached with the metals such as paper clips or staples that can damage the inside of the ScanSnap
Remove the metals for scanning.
 - Documents on which the ink is still wet
Wait until the ink dries completely to scan these documents.
 - Documents larger than 216 × 863 (mm)/8.5 × 34 (in.) (width × length)

- Documents other than paper such as fabric, metal foil and OHP film
 - When you scan picture postcards, be aware that the picture side may get damaged. It is the responsibility of the customer to scan picture postcards.
 - Be careful of the following when you scan plastic cards:
 - Cards that are bent may not be fed properly.
 - If the surface of the card is dirty with grease marks such as fingerprints, perform scanning after wiping the dirt off.
 - Insert the plastic card straight into the feeding section of the ScanSnap. Do not tilt the plastic card when you insert it because the plastic card may not be fed properly.
 - When you scan plastic cards with strong luster, some parts of the image may appear lighter or darker than the original.
- Example: gold colored credit card
- When you scan an embossed card, insert it in the direction shown below.

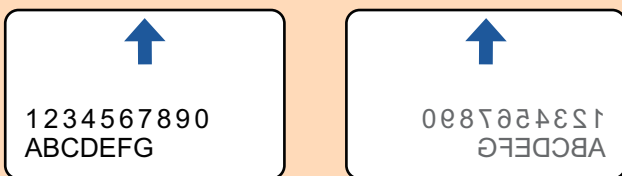

- If the embossed characters are not coated in gold or silver and the background color of the card and the color of the embossed characters are similar, it may be difficult for the ScanSnap to recognize embossed characters.
- In which case, performing the following may result in an improvement.
1. Click the [Option] button in the [Scanning] tab of the "ScanSnap Setup Window" (page 102).
 - ⇒ The [Scanning mode option] window appears.
 2. Select the [Increase text contrast] checkbox.

Documents That Can Be Scanned Using the Carrier Sheet

The optional Carrier Sheet is a sheet designed to transport documents through the ScanSnap. You can scan documents that are larger than A4/Letter size, photographs, and clippings. Conditions for documents that can be scanned using the Carrier Sheet are as follows:



- Do not use a damaged Carrier Sheet. Otherwise, it may damage or cause the ScanSnap to malfunction.
- Be careful not to cut your finger on the edge of the Carrier Sheet.

Eject method	With the output guide closed
Document type	Documents that cannot be loaded directly into the ScanSnap
Paper weight	52 to 209 g/m ² (14 to 56 lb)
	When scanning documents folded in half:
	Up to 105 g/m ² (28 lb)

Paper size	Carrier Sheet size (216 × 297 mm) A3 (297 × 420 mm) (*1) A4 (210 × 297 mm) A5 (148 × 210 mm) A6 (105 × 148 mm) B4 (257 × 364 mm) (*1) B5 (182 × 257 mm) B6 (128 × 182 mm) Postcard (100 × 148 mm) Business card (90 × 55 mm, 55 × 90 mm) Letter (8.5 × 11 in., 216 × 279.4 mm) 11 × 17 in. (279.4 × 431.8 mm) (*1) Custom size Width: 25.4 to 216 mm (1 to 8.5 in.) Length: 25.4 to 297 mm (1 to 11.69 in.)
-------------------	--

*1: Fold in half to scan.

Documents for Which the Carrier Sheet is Recommended for Scanning

It is recommended that you use the Carrier Sheet to scan the following documents.

- Documents written in pencil

Because there may be black traces left on the documents, it is recommended that you use the Carrier Sheet to scan such documents.

When you scan such documents directly without using a Carrier Sheet, dirt will accumulate on the rollers, which may cause feeding errors. Clean the rollers occasionally.

For details about how to perform cleaning, refer to "[Cleaning the Inside of iX100](#)" (page 532).

- Carbonless paper

Because carbonless paper may contain chemicals that can harm the ScanSnap internal rollers, it is recommended that you use the Carrier Sheet to scan such documents.

Make sure to clean the rollers occasionally to maintain the scanner performance when scanning carbonless paper directly without using the Carrier Sheet. For details about how to perform cleaning, refer to "[Cleaning the Inside of iX100](#)" (page 532).

Depending on the type of carbonless paper, the life span of the scanner may be shortened compared to scanning office paper.

- Scanning the following types of documents without using the Carrier Sheet can result in documents being damaged or scanned incorrectly

- Documents smaller than 25.4 × 25.4 (mm)/1 × 1 (in.) (width × length)
- Documents whose paper weight is less than 52.3 g/m² (14 lb)
- Documents with an uneven surface (such as envelopes and paper sheets with attached materials)
- Wrinkled or curled documents
- Folded or torn documents
- Tracing paper
- Coated paper
- Photographs (photographic paper)
- Perforated or punched documents
- Documents that are not rectangular or square

- Carbon paper or thermal paper
- Documents with memo papers or sticky notes attached

ATTENTION

- Using the Carrier Sheet

Be careful of the following when you use the Carrier Sheet:

- Do not stain, or cut the black and white patterned end of the Carrier Sheet. Otherwise, the Carrier Sheet will not be recognized properly.
- Do not place the Carrier Sheet upside down. Otherwise, a paper jam may occur and damage the Carrier Sheet and the document inside.
- Do not fold or pull the Carrier Sheet.
- Paper jams may occur when several small size documents such as photographs and postcards are placed inside the Carrier Sheet to be scanned at once. It is recommended that you scan such documents one at a time.

- Storing the Carrier Sheet

Be careful of the following when you store the Carrier Sheet:

- Do not leave your document inside the Carrier Sheet for a long time. Otherwise, the ink on the document may be transferred onto the Carrier Sheet.
- Do not leave the Carrier Sheet in high temperature places such as under direct sunlight or near a heating apparatus for a long time. Also, do not use the Carrier Sheet in high temperature places. The Carrier Sheet may be deformed.
- To avoid deformation, store the Carrier Sheet on a flat surface without any weight on it.

Scanning Documents (iX100)

The procedure for scanning documents by inserting one document at a time is as follows.

For details about documents that can be scanned, refer to ["Documents to Scan \(iX100\)"](#) (page 316).

1. Open the feed guide of the ScanSnap.

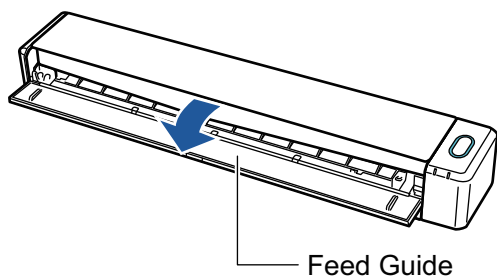

HINT

- If you want the document to be ejected from the front of the ScanSnap or when there is not enough space where the document exits the ScanSnap, open the output guide.

For details about documents that can be scanned with the output guide open, refer to ["Documents to Scan \(iX100\)"](#) (page 316).

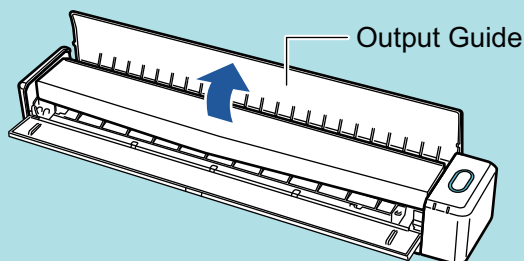

- How the document is ejected differs as below depending on whether the output guide is open or closed.

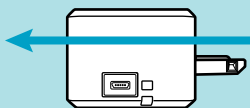

- When the output guide is closed

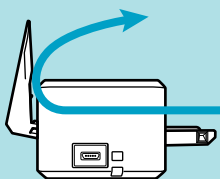

- When the output guide is open



⇒ The [Scan/Stop] button flashes in blue. The button returns to being lit normally when document scanning is enabled.

In addition, the ScanSnap Manager icon in the notification area located at the far right of the taskbar changes from  to .

2. Insert the document straight into the feeding section of the ScanSnap, with the scanning side facing up.

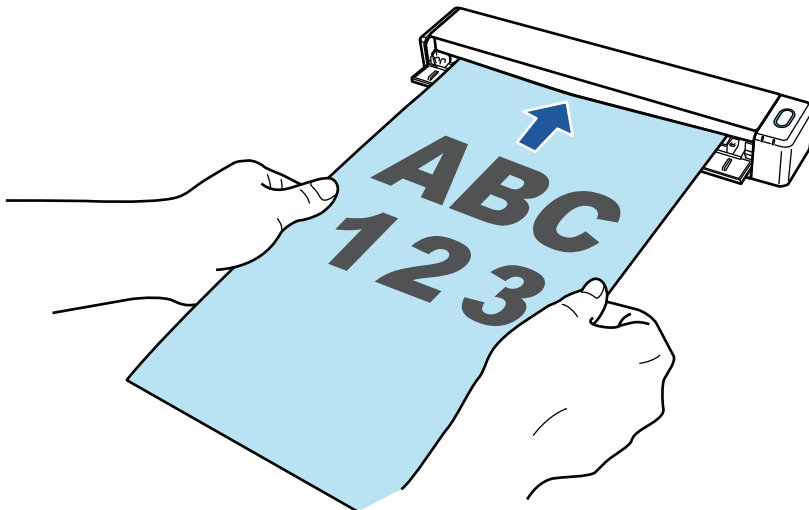

⇒ The document is pulled in until it is set inside the ScanSnap.

ATTENTION

- If you specify a standard size instead of selecting [Automatic detection] (default), insert the document by aligning it with the left edge of the feeding section.

You can configure the scan settings in the "[ScanSnap Setup Window](#)" (page 102).

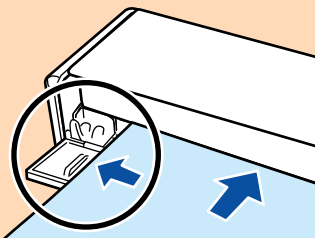

- When you perform scanning with the output guide closed, leave enough space at the back of the ScanSnap to allow the document to be completely ejected. In addition, when you scan long page documents, hold the scanned documents with your hands to prevent them from falling off the unit where the ScanSnap is placed on.

Make sure that the area where the document exits the scanner is clear of any obstacles. Otherwise, paper jam may occur.

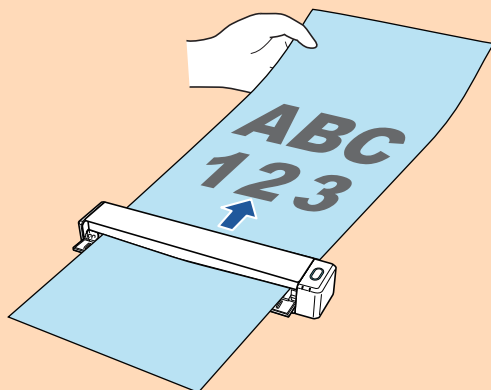

- If you scan the following documents with the output guide open, a paper jam may occur and damage the documents. Scan the following documents with the output guide closed.
 - Thick paper (80 g/m² [20 lb] or heavier)
 - Postcards
 - Business cards
 - Plastic cards
 - Carrier Sheets

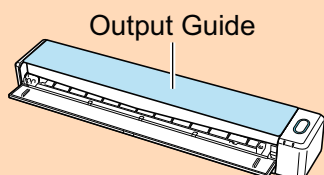

3. Press the [Scan/Stop] button on the ScanSnap to start scanning.

ATTENTION

Do not perform the following operations during scanning. Doing so will stop scanning.

- Connect or disconnect the ScanSnap and other USB devices.
- Close the feed guide.
- Switch users.
- Allow the computer to enter sleep mode.

⇒ The [Scan/Stop] button on the ScanSnap flashes in blue while the documents are being scanned.

The [ScanSnap Manager - Image scanning and file saving] window appears.

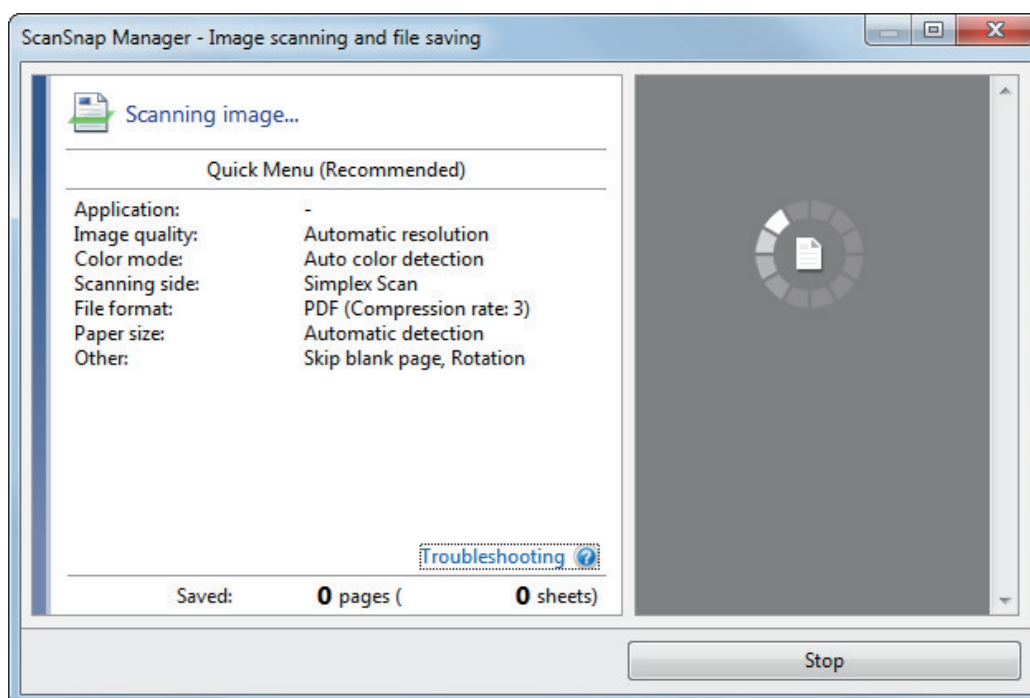

⇒ When scanning is complete, the [ScanSnap Manager - Image scanning and file saving] window displays a scanning standby status.

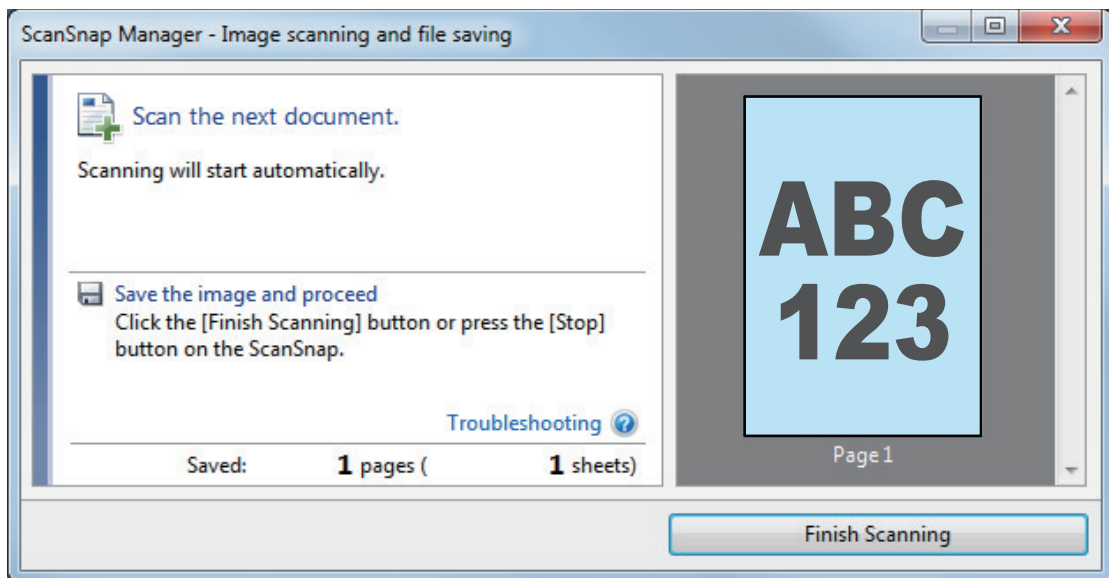

HINT

To continue scanning, insert the next document to be scanned. When the document is inserted, scanning starts automatically.

4. Press the [Scan/Stop] button on the ScanSnap to finish scanning.

⇒ The Quick Menu appears.

5. In the Quick Menu, click the icon of the application to link with ScanSnap Manager.

For details about linking the following applications with ScanSnap Manager, refer to "[Useful Usages](#)" (page 439).

- Save Documents
- Save Business Cards
- Save Receipts
- Save Photos

HINT

The following applications are displayed in the Quick Menu when ScanSnap Organizer and CardMinder are installed.

- When ScanSnap Organizer is installed
ScanSnap Organizer
- When CardMinder is installed
Scan to CardMinder



⇒ The selected application starts up. For details, refer to the Advanced Operation Guide.

ATTENTION

- You cannot start scanning when the Quick Menu is displayed. Either select an icon from the Quick Menu and finish the process, or close the Quick Menu before you perform the next scan.
- Do not move, delete, or rename scanned images using other applications while the Quick Menu is displayed.

HINT

- Clicking  displays the description of an application. Placing the mouse cursor over the icon of another application displays the description of the application.
- Performing a scan while an application that can be automatically linked with is active automatically starts the linkage between ScanSnap Manager and the application. For details, refer to the Advanced Operation Guide.

Scanning Documents by Inserting Two Documents at a Time or by Inserting the Next Document While the Current Document Is Being Scanned (iX100)

When scanning small size documents such as business cards and postcards with the ScanSnap, you can insert two documents at a time or you can insert the next document while the current document is being scanned. These scanning methods are referred to as dual scans.

Documents can be inserted in the following two methods:

- Inserting two documents at a time in the ScanSnap

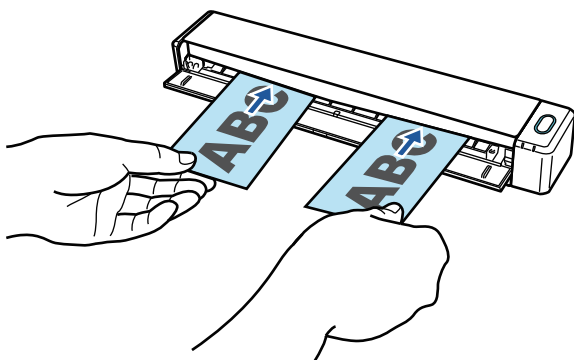

- Inserting the next document while the current document is being scanned

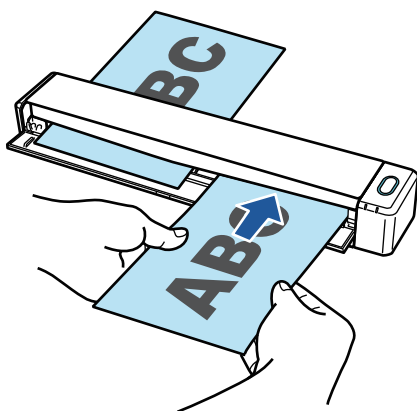

For details about documents that can be scanned, refer to "[Documents to Scan \(iX100\)](#)" (page 316).

ATTENTION

- When you select an option other than [Automatic detection] for [Paper size] in the [Paper] tab of the "[ScanSnap Setup Window](#)" (page 102), the dual scan function is disabled.
- Use a dual scan to scan a document within the following ranges. If one of the following ranges is exceeded, a length error occurs and part of the document may not appear in the scanned image.
 - Maximum scanning length: 863 mm (34 in.) (355.6 mm (14 in.) when [Excellent] is specified for [Image Quality] in the [Scanning] tab of the "[ScanSnap Setup Window](#)" (page 102))
 - Maximum number of documents for scanning: 20 sheets
- When you continue scanning by inserting the next document while the current document is being scanned, the [Scan/Stop] button flashes more quickly if the scanning length exceeds 650 mm (26 in.). If this occurs, wait until scanning is complete without continuing to insert more documents. After scanning is complete, insert the next document. The next scan is started automatically.

1. Open the feed guide of the ScanSnap.

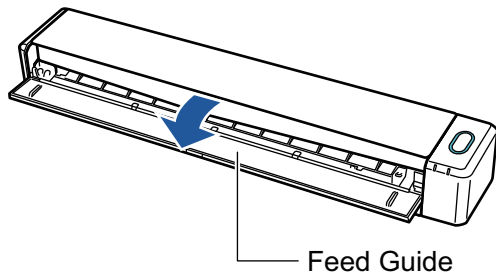

HINT

- If you want the document to be ejected from the front of the ScanSnap or when there is not enough space where the document exits the ScanSnap, open the output guide.

For details about documents that can be scanned with the output guide open, refer to "Documents to Scan (iX100)" (page 316).

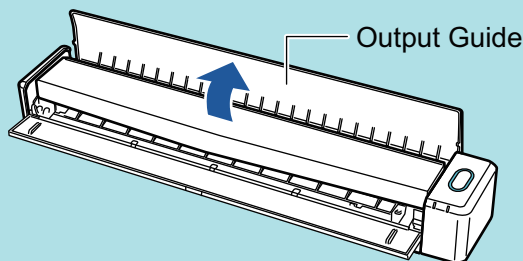

- How the document is ejected differs as below depending on whether the output guide is open or closed.

- When the output guide is closed



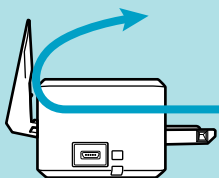

- When the output guide is open



⇒ The [Scan/Stop] button flashes in blue. The button returns to being lit normally when document scanning is enabled.

In addition, the ScanSnap Manager icon in the notification area located at the far right of

the taskbar changes from  to .

2. Insert the document straight into the feeding section of the ScanSnap, with the scanning side facing up.

Insert each document in the center of the left or right half of the feeding section.

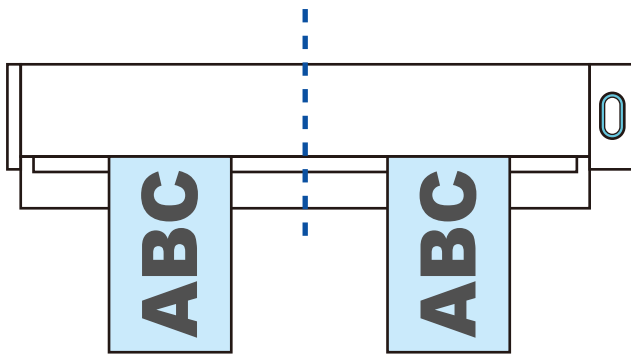
**ATTENTION**

When inserting the documents, insert them at least 10 mm (0.39 in.) apart from each other. If the space between the documents is less than 10 mm (0.39 in.), the scanned images may not be cropped correctly.

⇒ The document is pulled in until it is set inside the ScanSnap.

ATTENTION

- When you perform scanning with the output guide closed, leave enough space at the back of the ScanSnap to allow the document to be completely ejected. In addition, when you scan long page documents, hold the scanned documents with your hands to prevent them from falling off the unit where the ScanSnap is placed on.

Make sure that the area where the document exits the scanner is clear of any obstacles. Otherwise, paper jam may occur.

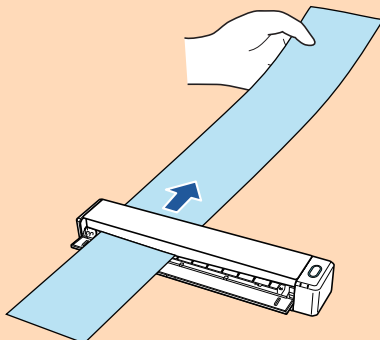

- If you scan the following documents with the output guide open, a paper jam may occur and damage the documents. Scan the following documents with the output guide closed.

- Thick paper (80 g/m² [20 lb] or heavier)
- Postcards
- Business cards

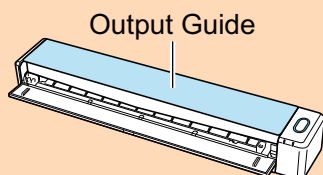

3. Press the [Scan/Stop] button on the ScanSnap to start scanning.

ATTENTION

Do not perform the following operations during scanning. Doing so will stop scanning.

- Connect or disconnect the ScanSnap and other USB devices.
- Close the feed guide.

- Switch users.
- Allow the computer to enter sleep mode.

⇒ The [Scan/Stop] button on the ScanSnap flashes in blue while the documents are being scanned.

The [ScanSnap Manager - Image scanning and file saving] window appears.

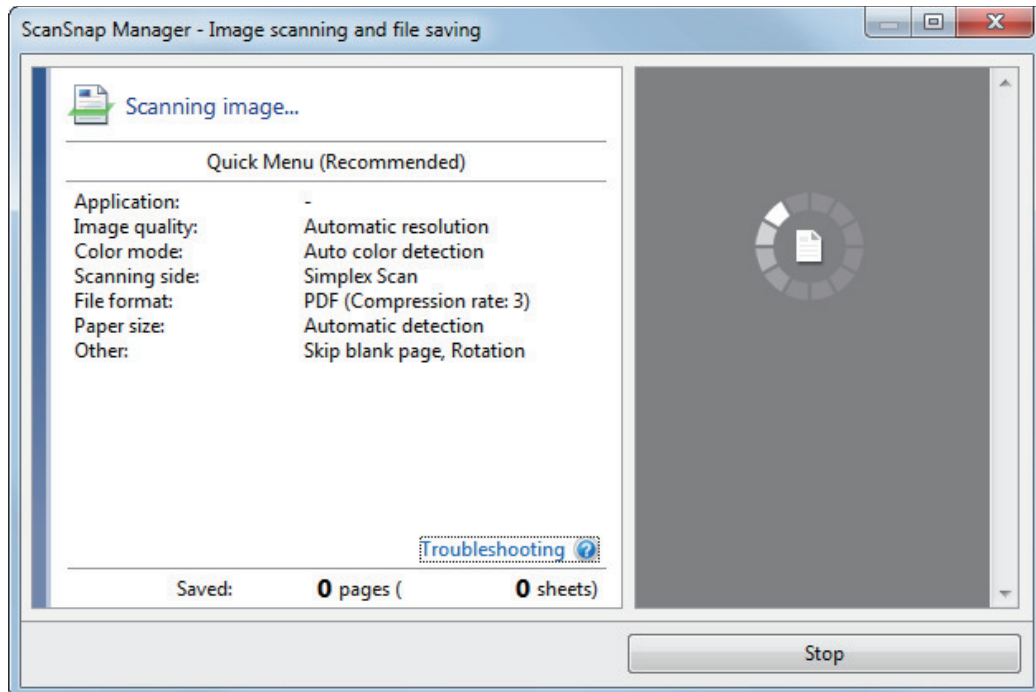

HINT

When the [ScanSnap Manager - Image scanning and file saving] window is maximized, multiple scanned images are displayed in the preview area. When you use a dual scan, it is recommended that you maximize the [ScanSnap Manager - Image scanning and file saving] window to check that scanned images are created correctly while scanning documents.

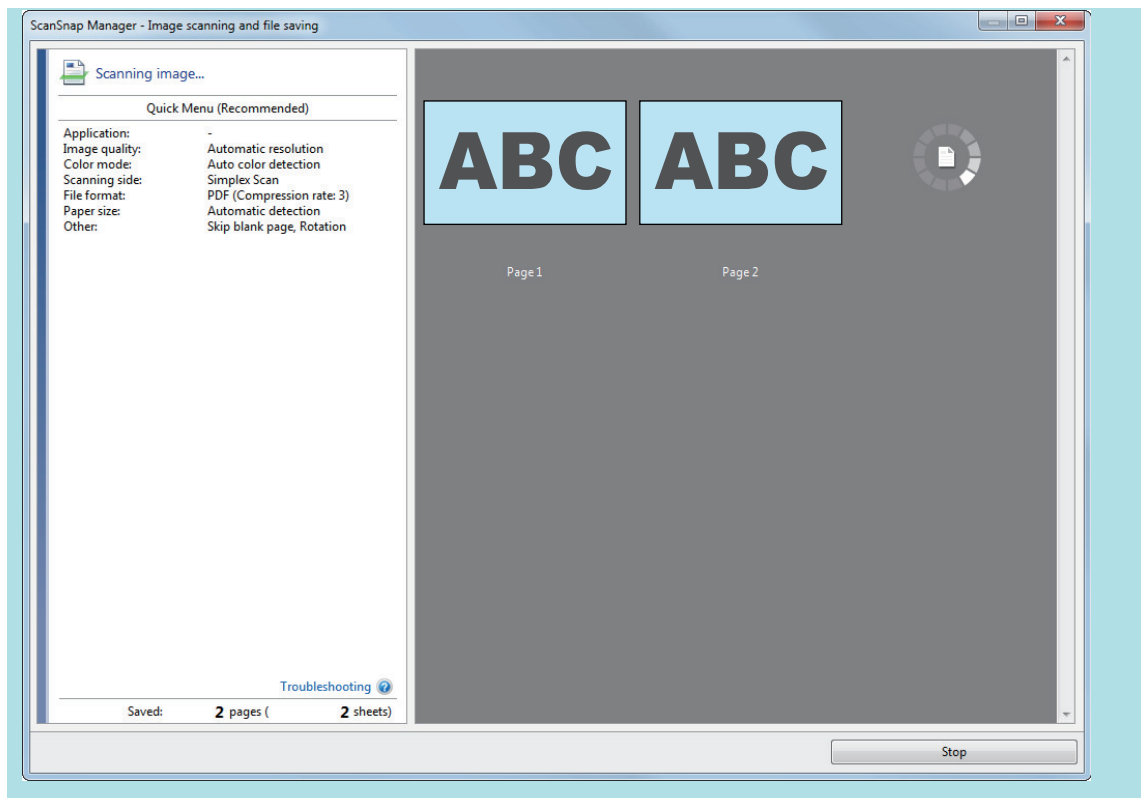

⇒ When scanning is complete, the [ScanSnap Manager - Image scanning and file saving] window displays a scanning standby status.

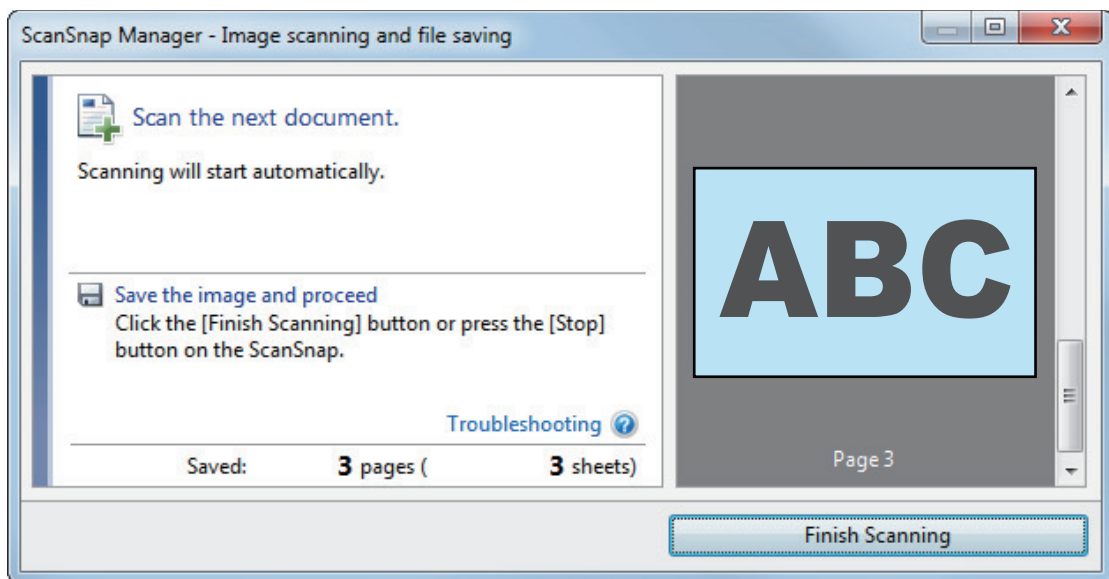

HINT

To continue scanning, insert the next document to be scanned. When the document is inserted, scanning starts automatically.

4. Press the [Scan/Stop] button on the ScanSnap to finish scanning.

⇒ The Quick Menu appears.

5. In the Quick Menu, click the icon of the application to link with ScanSnap Manager.

For details about linking the following applications with ScanSnap Manager, refer to "[Useful Usages](#)" (page 439).

- Save Documents
- Save Business Cards
- Save Receipts
- Save Photos

HINT

The following applications are displayed in the Quick Menu when ScanSnap Organizer and CardMinder are installed.

- When ScanSnap Organizer is installed
ScanSnap Organizer
- When CardMinder is installed
Scan to CardMinder



⇒ The selected application starts up. For details, refer to the Advanced Operation Guide.

ATTENTION

- You cannot start scanning when the Quick Menu is displayed. Either select an icon from the Quick Menu and finish the process, or close the Quick Menu before you perform the next scan.
- Do not move, delete, or rename scanned images using other applications while the Quick Menu is displayed.

HINT

- Clicking  displays the description of an application. Placing the mouse cursor over the icon of another application displays the description of the application.
- Performing a scan while an application that can be automatically linked with is active automatically starts the linkage between ScanSnap Manager and the application.

For details, refer to the Advanced Operation Guide.

Scanning Documents Larger Than A4 or Letter Size by Directly Inserting Them in the ScanSnap (iX100)

By folding an A3, B4, or Double Letter size document in half and scanning each side continuously, the scanned images of both sides are automatically merged and saved as a single image.

For details about documents that can be scanned, refer to "[Documents to Scan \(iX100\)](#)" (page 316).

ATTENTION

- Scanned images are automatically merged only when there is text, diagram, or a table on the fold line of the folded document.

- When scanned images are automatically merged

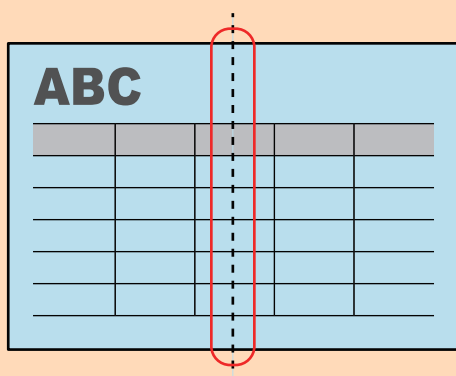

- When scanned images are not automatically merged

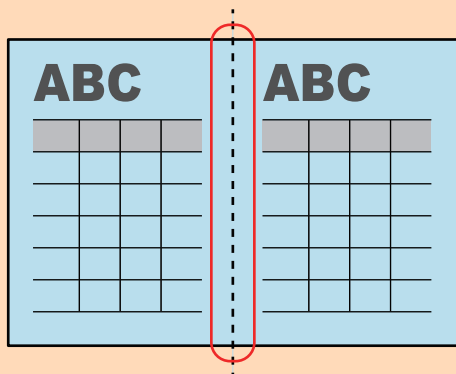

- After a document is scanned, if the scanned images are not merged automatically, you can use the ScanSnap Organizer Merge Pages function to merge the scanned images.

For details, refer to the ScanSnap Organizer Help.

- For a document that will have scanned images which are not merged automatically, you can use the optional Carrier Sheet to scan the document and merge the scanned images automatically.

For details, refer to "[Scanning Documents Larger than A4 or Letter Size with the Carrier Sheet \(iX100\)](#)" (page 336).

- If scanned images are unexpectedly merged, clear the [Merge both side images] checkbox on the [Scanning mode option] window, and then scan the document again.

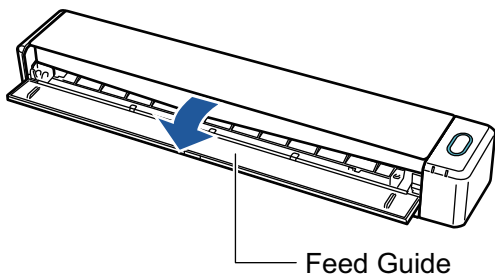

To open the [Scanning mode option] window, click the [Option] button in the [Scanning] tab of the "[ScanSnap Setup Window](#)" (page 102).

1. Open the feed guide of the ScanSnap.



⇒ The [Scan/Stop] button flashes in blue. The button returns to being lit normally when document scanning is enabled.

In addition, the ScanSnap Manager icon in the notification area located at the far right of

the taskbar changes from  to .

2. Fold the document in half so that the sides to be scanned are facing out.

ATTENTION

Fold the long side of the document in half. If the left and right areas of the folded document are different in size from each other, the scanned images may not be merged automatically.

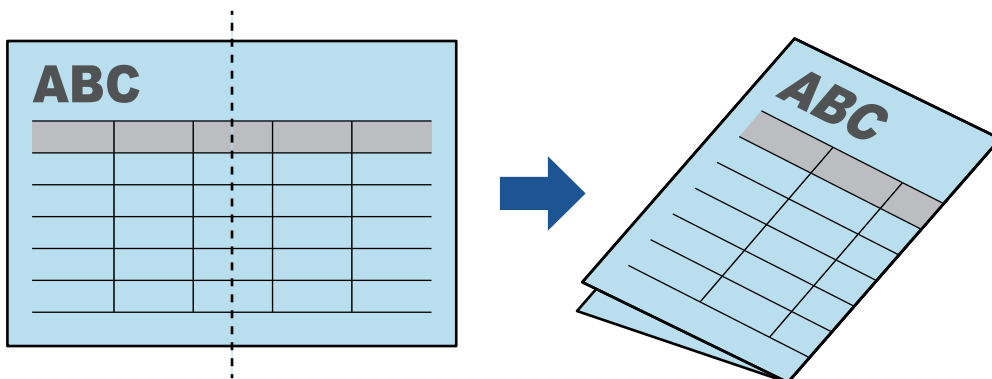

3. Insert the document straight into the feeding section of the ScanSnap, with the scanning side facing up.

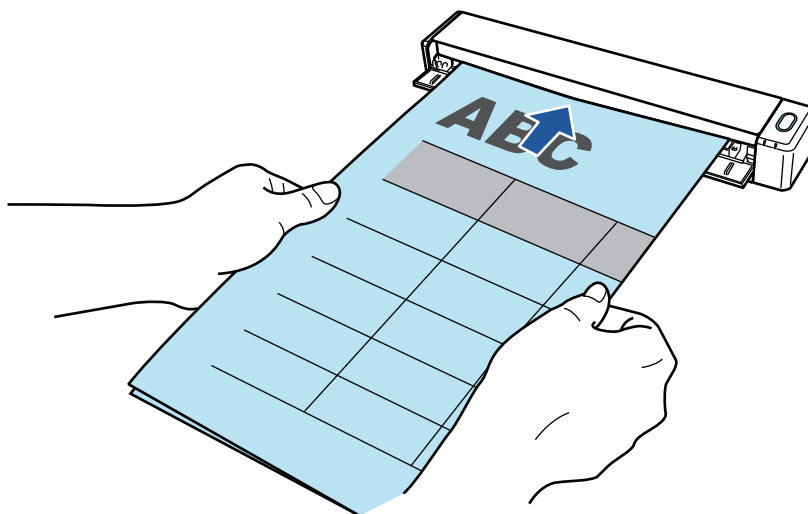

⇒ The document is pulled in until it is set inside the ScanSnap.

HINT

If you scan a document folded in half with the output guide open, a paper jam may occur. Make sure to close the output guide when you scan a document folded in half.

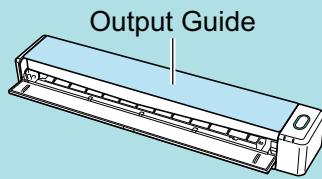

4. Press the [Scan/Stop] button on the ScanSnap to start scanning.

- ⇒ The [Scan/Stop] button on the ScanSnap flashes in blue and the [ScanSnap Manager - Image scanning and file saving] window appears while the document is being scanned. When scanning is complete, the scanned image of the scanning side is displayed in the preview area.

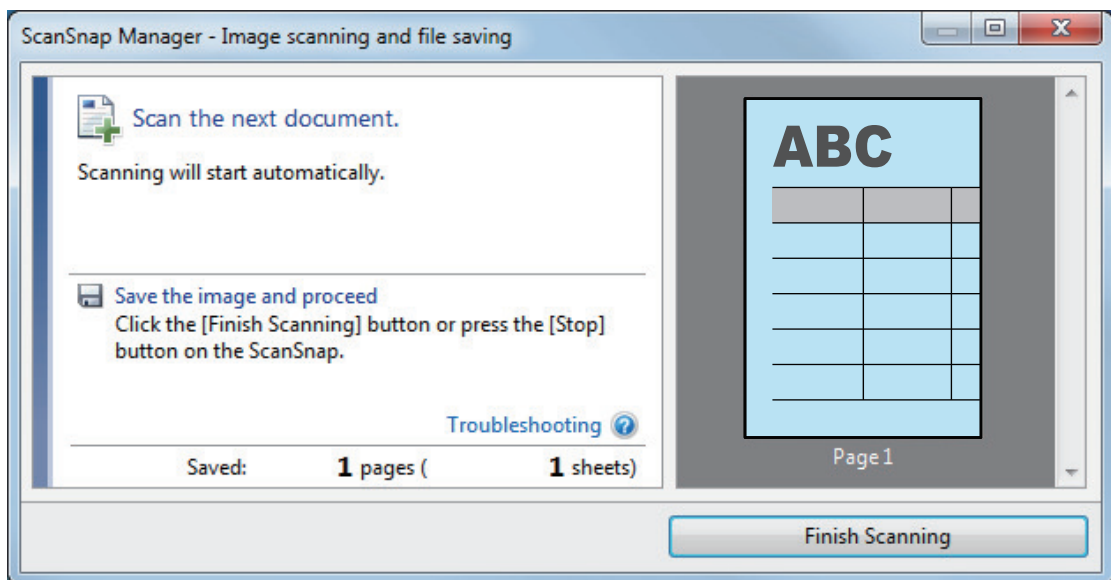

5. Turn over the document and insert it as described in step 3.

ATTENTION

Make sure to scan the front and back sides of the document folded in half consecutively.

- ⇒ Scanning starts automatically.

HINT

Repeat steps 2 to 5 to continue scanning more A3, B4, or Double Letter size documents. You can also continue scanning documents smaller than A4 or Letter size.

For details about how to perform a scan, refer to "[Scanning Documents \(iX100\)](#)" (page 320).

6. Press the [Scan/Stop] button on the ScanSnap to finish scanning.

- ⇒ The Quick Menu appears.

7. In the Quick Menu, click the icon of the application to link with ScanSnap Manager.

When you select [Save Documents], you can manage scanned images by folder with ScanSnap Home.

For details, refer to ["Managing Paper Documents by Folder on a Computer with ScanSnap Home"](#) (page 440).

HINT

[ScanSnap Organizer] is displayed in the Quick Menu when ScanSnap Organizer is installed.

To manage scanned images by folder with ScanSnap Organizer, refer to ["Managing Paper Documents by Folder on a Computer with ScanSnap Organizer"](#) (page 443).



⇒ The selected application starts up. For details, refer to the Advanced Operation Guide.

ATTENTION

- You cannot start scanning when the Quick Menu is displayed. Either select an icon from the Quick Menu and finish the process, or close the Quick Menu before you perform the next scan.
- Do not move, delete, or rename scanned images using other applications while the Quick Menu is displayed.

HINT

- Clicking  displays the description of an application. Placing the mouse cursor over the icon of another application displays the description of the application.
 - Performing a scan while an application that can be automatically linked with is active automatically starts the linkage between ScanSnap Manager and the application.
- For details, refer to the Advanced Operation Guide.

Scanning Documents Larger than A4 or Letter Size with the Carrier Sheet (iX100)

Documents larger than A4/Letter size (such as A3, 11 × 17 in. and B4) can be scanned with the optional Carrier Sheet. By folding the document in half and scanning both sides, one at a time, the two sides are merged into a single image.

For details about documents that can be loaded, refer to "[Scanning Documents \(iX100\)](#)" (page 320).

ATTENTION

The [Deskew by text on document] checkbox in the [Scanning mode option] window will be disabled. To open the [Scanning mode option] window, click the [Option] button in the [Scanning] tab of the "[ScanSnap Setup Window](#)" (page 102).

HINT

Both sides of a double-sided A4/Letter size document or smaller can also be scanned and merged into a single image.

1. **Right-click the ScanSnap Manager icon  in the notification area located at the far right of the taskbar, and select the [Scan Button Settings] from the "Right-Click Menu" (page 100).**
⇒ The ScanSnap setup window appears.
2. **In the [Paper] tab, select [Automatic detection] in [Paper size], and then click the [Carrier Sheet Settings] button.**

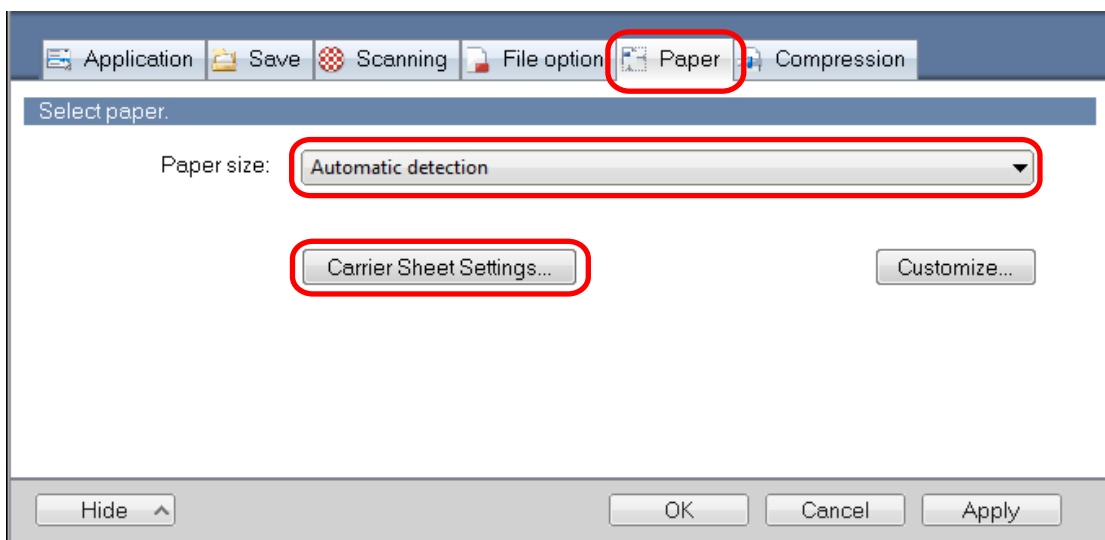

⇒ The [Carrier Sheet Settings] window appears.

3. **Select [one double-page spread image] in [Save as] and click the [OK] button.**

For details, refer to the ScanSnap Manager Help.

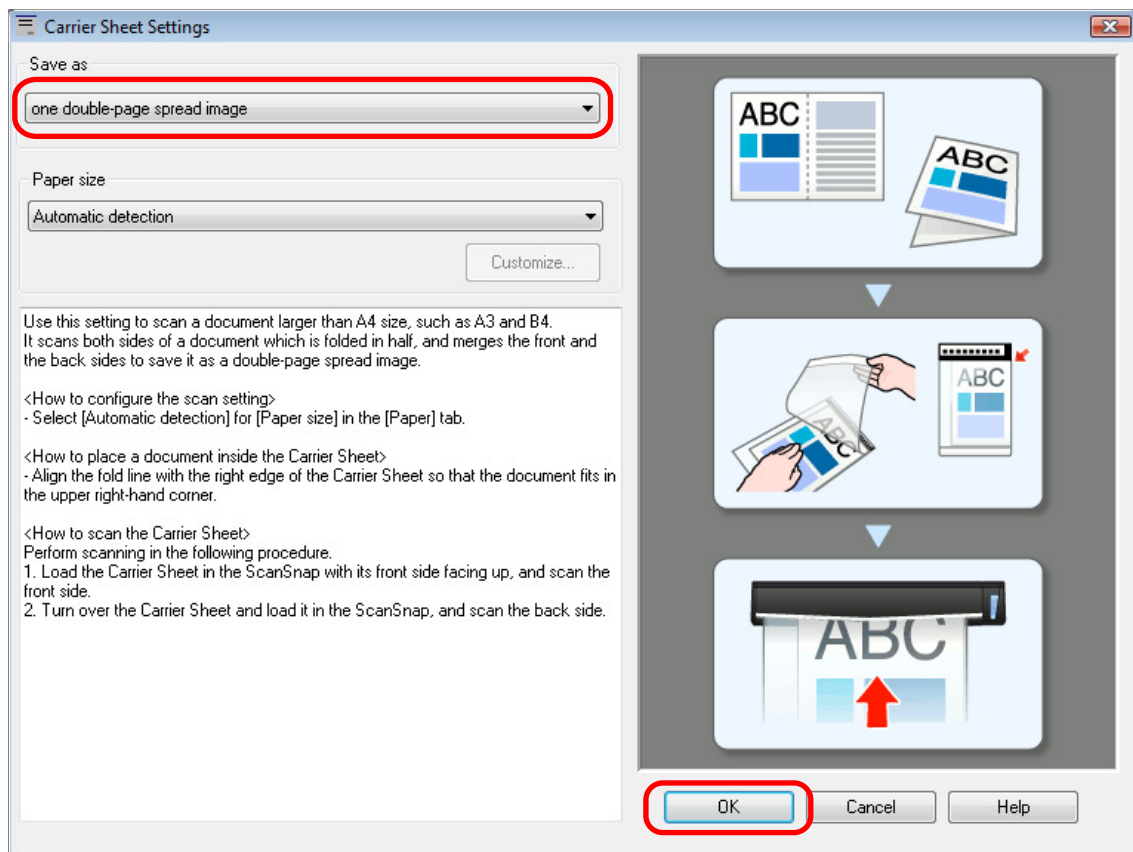

4. Click the [OK] button to close the ScanSnap setup window.

5. Place the document inside the Carrier Sheet.

1. Fold the document in half with the sides to be scanned facing out.
 Fold it tightly and smooth out any creases.

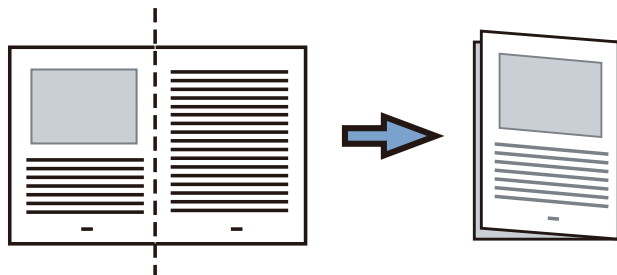

2. Open the Carrier Sheet to bind the document.

Align the fold line with the right edge of the Carrier Sheet so that the document fits in the upper right-hand corner of the Carrier Sheet.

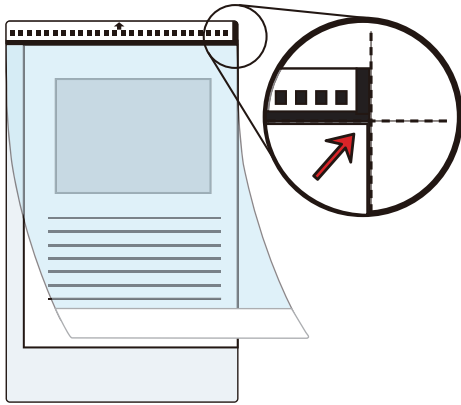
**HINT**

Note that the front side of the Carrier Sheet has a black and white pattern at the top and a thick vertical line in the upper right-hand corner.

- 6. Insert the part with the black and white pattern straight into the feeding section of the ScanSnap, with the front side of the Carrier Sheet facing up.**

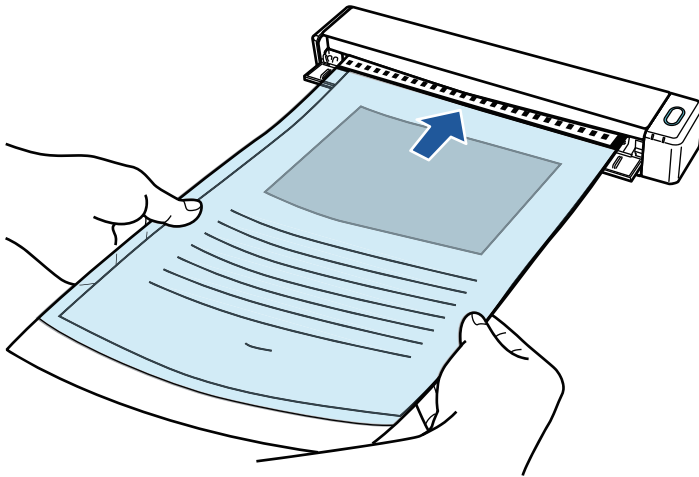

⇒ The Carrier Sheet is pulled in until it is set inside the ScanSnap.

HINT

If you perform a scan using the Carrier Sheet with the output guide open, a paper jam may occur and damage the documents. Make sure to close the output guide when you perform a scan using the Carrier Sheet.

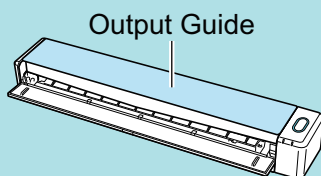

- 7. Press the [Scan/Stop] button on the ScanSnap to start scanning.**

⇒ Scanning starts and the [ScanSnap Manager - Image scanning and file saving] window appears. When the front side of the Carrier Sheet is scanned, the scanned image is displayed in the preview area.

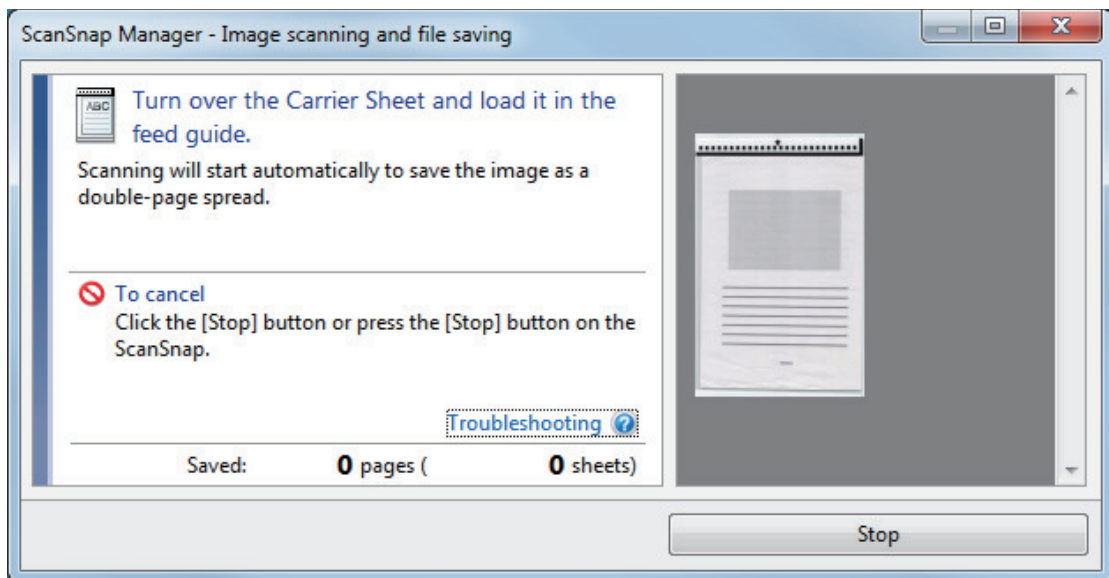

8. Turn over the Carrier Sheet and insert it as described in step 6.

ATTENTION

Make sure to scan the front and back side of the Carrier Sheet consecutively.

- ⇒ Scanning starts automatically and the [ScanSnap Manager - Image scanning and file saving] window appears. When scanning is completed, scanned images of the front and back side of the document inside the Carrier Sheet are displayed as a double-page spread image in the preview area.

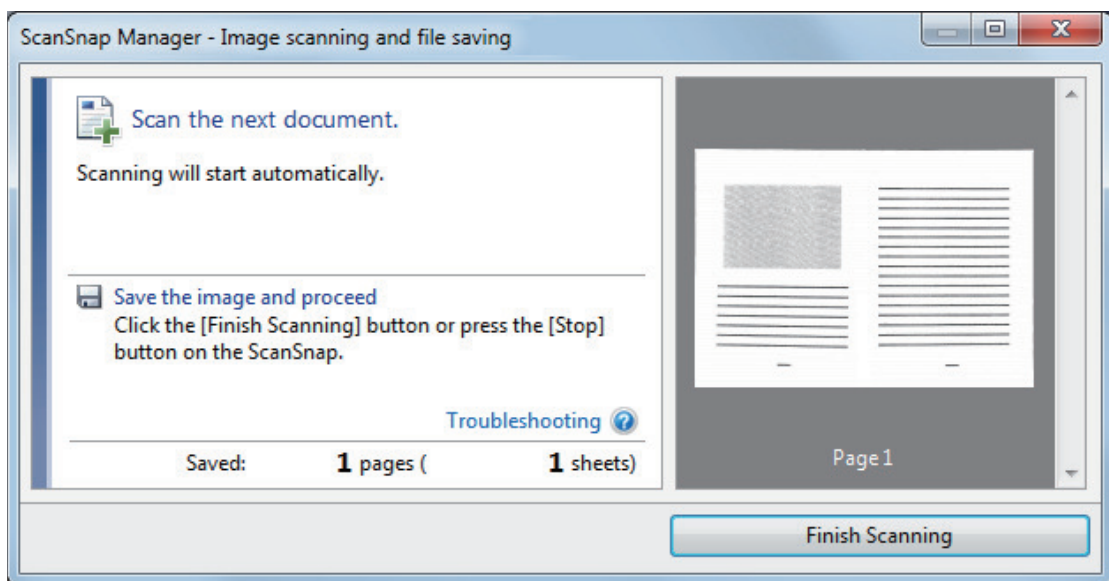

HINT

Repeat steps 5 to 8 to scan more documents larger than A4/Letter size. You can continue to scan documents that can be inserted directly in the ScanSnap.

For details about how to perform a scan, refer to "Scanning Documents (iX100)" (page 320).

9. Press the [Scan/Stop] button on the ScanSnap to finish scanning.

- ⇒ The scanned images of the front and back sides of the document are saved as a double-page spread image.

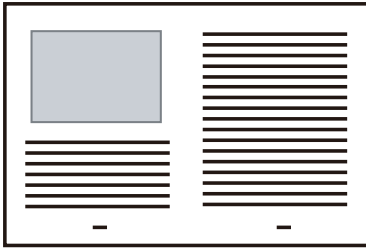

ATTENTION

- There may be a line or a gap appearing between the front and back side images. Also when you scan a thick document in the Carrier Sheet, the scanned image on the left and the scanned image on the right of a double-page spread image may skew towards each other from the top.

These symptoms may be improved when you place the document in the Carrier Sheet as follows:

- Fold the document properly
- Neatly align the edges of the document with the edges of the Carrier Sheet
- Turn over the Carrier Sheet to the other (reverse) side
- If [Automatic detection] is specified for [Paper size] in the [Carrier Sheet Settings] window, an optimal size will be selected automatically from the available standard sizes (A3, B4, or 11 × 17 in.) in [Paper size]. Note that the size of the image may become smaller than the original document depending on the document.

Example: When characters and illustrations are printed to fit in A4 size in the center of an A3 size document, the scanned image is output in B4 size.

To output the scanned image in its original size, specify the document size in [Paper size].

- Part of the scanned image around where the document is folded may appear missing. In that case, place the document so that its edge is about 1 mm (0.04 in.) inside from the edge of the Carrier Sheet.

Scanning Documents Such as Photographs and Clippings (iX100)

Using the optional Carrier Sheet allows you to scan documents that can be damaged quite easily such as photographs, or non-standard size documents that are difficult to load directly such as clippings.

For details about documents that can be loaded, refer to "[Documents to Scan \(iX100\)](#)" (page 316).

ATTENTION

The [Deskew by text on document] checkbox in the [Scanning mode option] window will be disabled.

To open the [Scanning mode option] window, click the [Option] button in the [Scanning] tab of the "[ScanSnap Setup Window](#)" (page 102).

1. **Right-click the ScanSnap Manager icon  in the notification area located at the far right of the taskbar, and select the [Scan Button Settings] from the "Right-Click Menu" (page 100).**
⇒ The ScanSnap setup window appears.
2. **In the [Paper] tab, select [Automatic detection] in [Paper size], and then click the [Carrier Sheet Settings] button.**

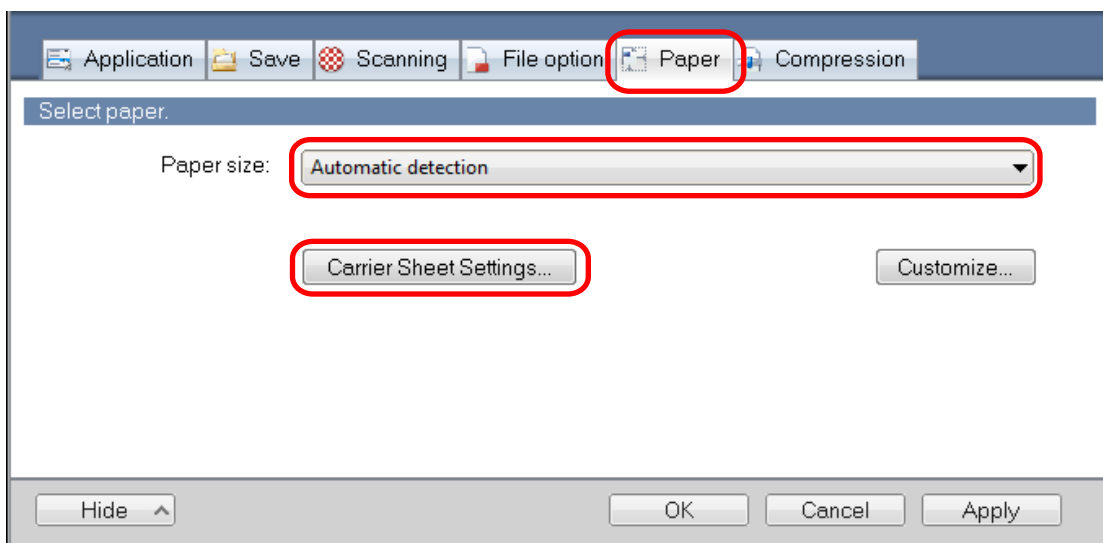

⇒ The [Carrier Sheet Settings] window appears.

3. **Select [two separate images (front and back)] in [Save as] and click the [OK] button.**

For details, refer to the ScanSnap Manager Help.

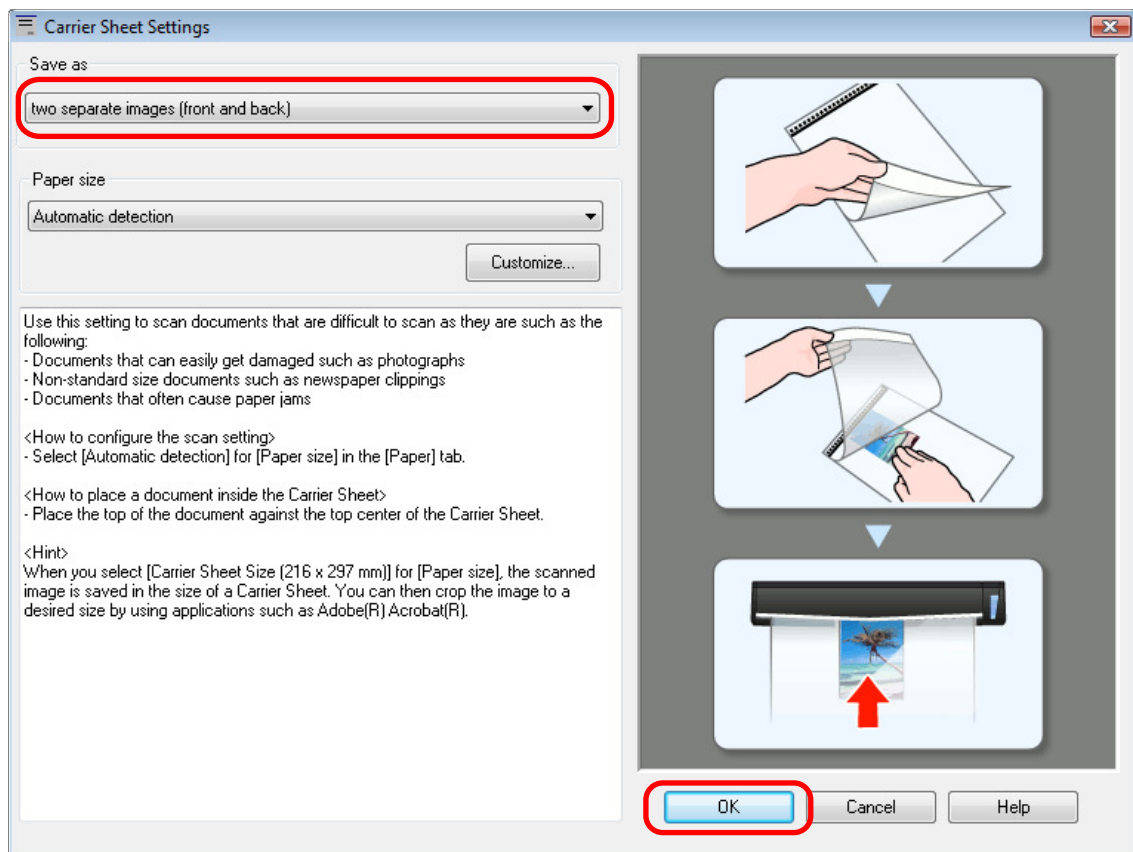

4. Click the [OK] button to close the ScanSnap setup window.

5. Place the document inside the Carrier Sheet.

Open the Carrier Sheet and place the top of the document against the top center of the Carrier Sheet.

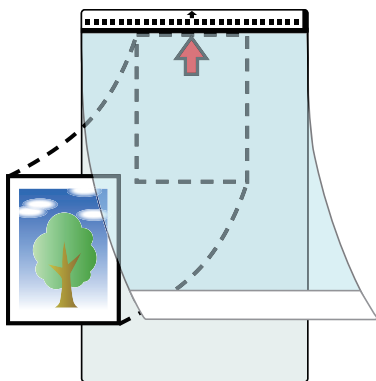

6. Insert the part with the black and white pattern straight into the feeding section of the ScanSnap, with the scanning side of the document inside the Carrier Sheet facing up.

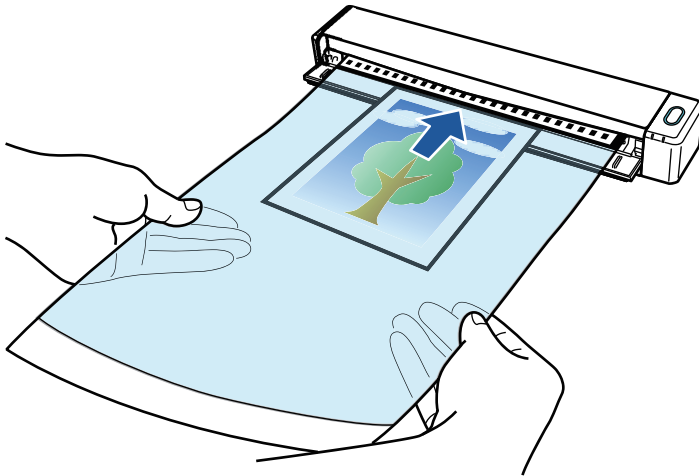

⇒ The Carrier Sheet is pulled in until it is set inside the ScanSnap.

ATTENTION

If you perform a scan using the Carrier Sheet with the output guide open, a paper jam may occur and damage the documents. Make sure to close the output guide when you perform a scan using the Carrier Sheet.

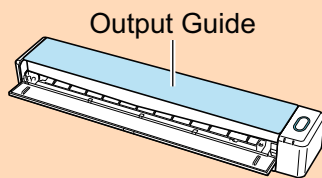

7. Press the [Scan/Stop] button on the ScanSnap to start scanning.

⇒ When scanning is complete, the scanned image of the document that is inside the Carrier Sheet is displayed in the preview area.

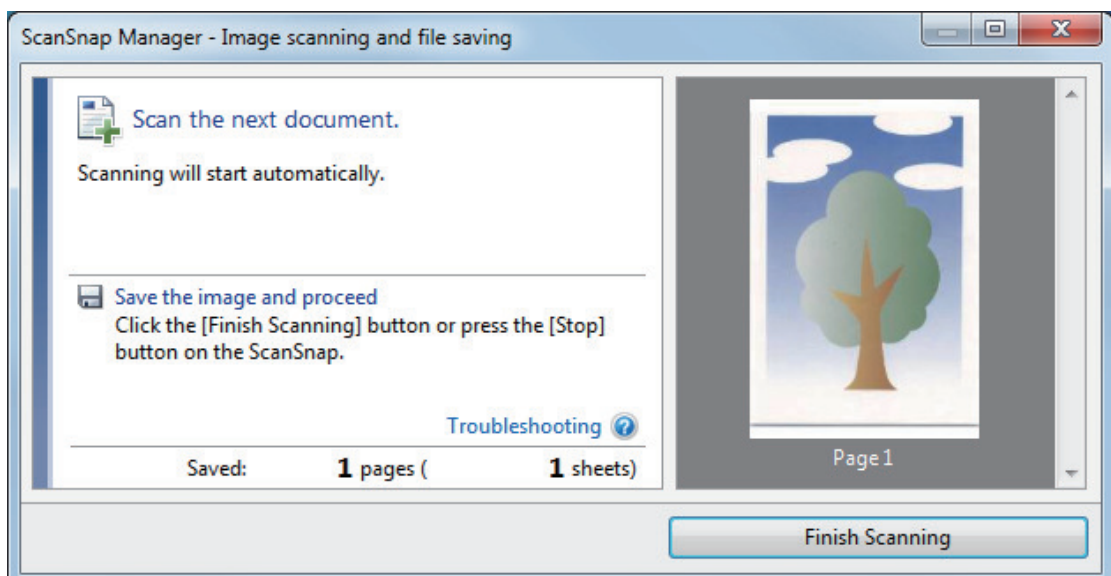

HINT

Repeat steps 5 to 7 to scan more documents such as photographs and clippings. You can continue to scan documents that can be inserted directly in the ScanSnap. For details about how to perform a scan, refer to "Scanning Documents (iX100)" (page 320).

8. Press the [Scan/Stop] button on the ScanSnap to finish scanning.

⇒ The scanned image is saved.

ATTENTION

- The scanned image is output at the center of the page in the size specified for [Paper size] in the [Carrier Sheet Settings] window.
- If [Automatic detection] is specified for [Paper size] in the [Carrier Sheet Settings] window, an optimal size will be selected automatically from the available standard sizes in [Paper size]. Note that the size of the image may become smaller than the original document depending on the document scanned, or part of the image may appear missing.

Example: When the contents are printed to fit in A5 size in the center of an A4 size document, the scanned image is output in A5 size.

To output the scanned image in its original size, specify the document size in [Paper size].

HINT

In the following cases, place a blank (white) sheet of paper underneath the document when scanning:

- The scanned image is not saved in the correct size (when [Automatic detection] is selected for [Paper size] in the [Carrier Sheet Settings] window)
- Shadows appear around the edges of the scanned image
- Black lines appear around the edges of a uniquely shaped cutting

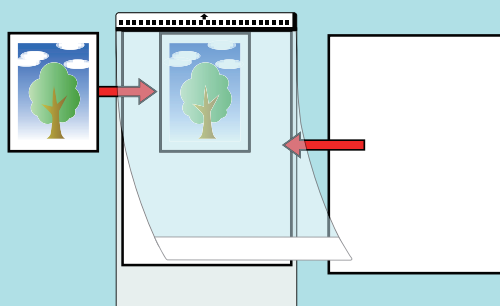

Scanning Documents with SV600

- "Documents to Scan (SV600)" (page 346)
- "How to Place Documents (SV600)" (page 347)
- "Scanning Documents (SV600)" (page 350)
- "Scanning Books (SV600)" (page 355)
- "Scanning Multiple Documents at Once (SV600)" (page 360)
- "Scanning Books Using Page Turning Detection (SV600)" (page 365)
- "Scanning Documents Using Timed Mode (SV600)" (page 369)
- "Scanning Documents with Two ScanSnaps Connected to a Computer (SV600)" (page 372)

Documents to Scan (SV600)

The following documents can be scanned because the scanning unit does not touch the documents.

- Thick documents, such as books
- Documents that you want to keep intact, such as photographs and handwritten illustrations

Conditions for Documents to Scan

Document type	Flat documents, such as office paper, postcards, and business cards	Thick documents, such as books
Document thickness	5 mm (0.2 in.) or less	5 to 30 mm (0.2 to 1.18 in.)
Paper size	Width: 25.4 to 432 mm (1 to 17 in.) Length: 25.4 to 300 mm (1 to 11.8 in.)	Width: 25.4 to 400 mm (1 to 15.7 in.) Length: 25.4 to 300 mm (1 to 11.8 in.)

ATTENTION

- When you scan a glossy document, the scanned image may be affected as follows:
 - Part of the scanned image appears brighter or darker than the original
 - Glare from the lamp is caught in the scanned image
- If a document has wrinkles, curls, or folds, smooth it out before scanning. Otherwise, the scanned image may be affected as follows:
 - The scanned image is distorted
 - The scanned image is blurred
 - Part of the document does not appear in the scanned image
- When you scan irregular shaped documents that are not rectangular or square, the scanned images are not corrected automatically.

HINT

You can show a confirmation message in the case of scanning documents that reflect lamp light causing glare, such as glossy paper.

For details, refer to the ScanSnap Manager Help.

How to Place Documents (SV600)

When you place down documents, use the Background Pad.

If you scan documents without using the Background Pad, the document edges may not be detected correctly and the created scanned image may be different from the document.

For details about documents that can be scanned with the ScanSnap, refer to ["Documents to Scan \(SV600\)"](#) (page 346).

- ["Scan Area"](#) (page 347)
- ["When Placing a Standard Size Document"](#) (page 348)
- ["When Placing a Book"](#) (page 348)
- ["When Placing Multiple Documents at Once"](#) (page 348)

Scan Area

Place documents with the scanned side face-up in the following scan area.

Use the following to determine the scan area.

- Area: Reference marks of the Background Pad
- Height: Lines on the base of the ScanSnap

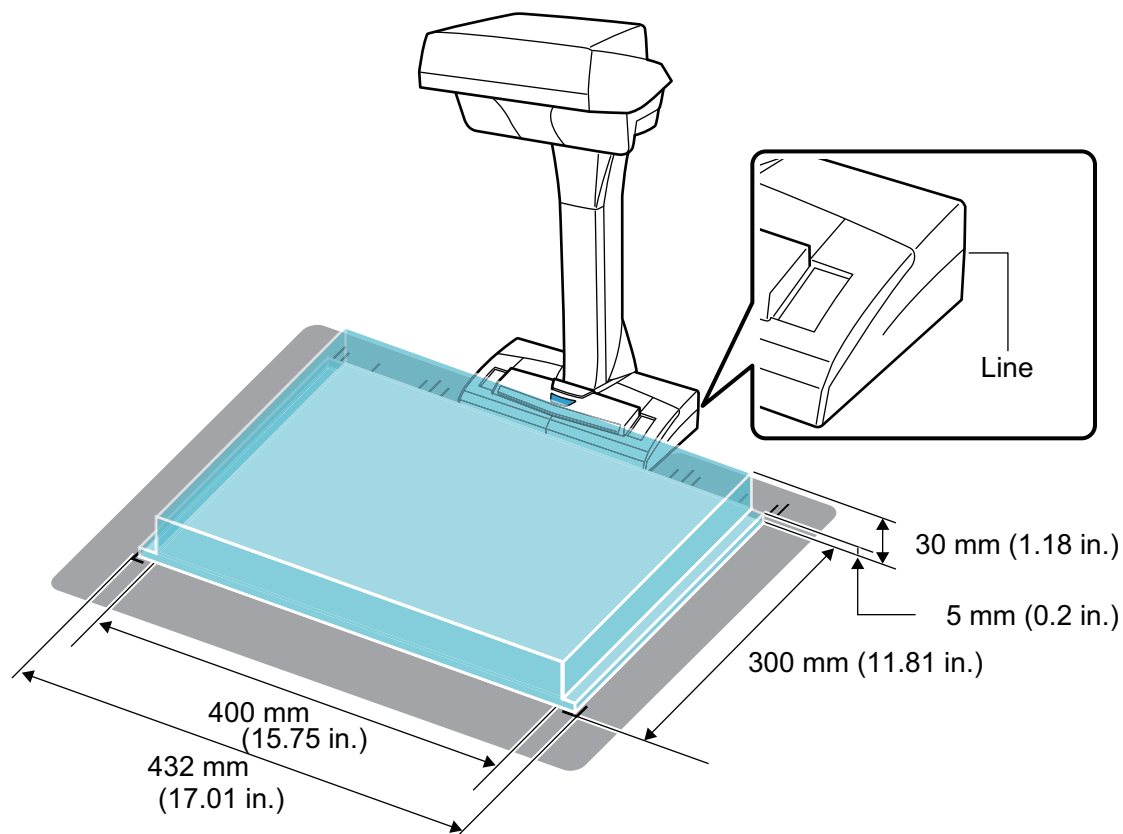

ATTENTION

If a document is placed outside of the scan area, part of the scanned image may be left out or blurred.

When Placing a Standard Size Document

When you select an option other than [Automatic detection] for [Paper size] on the [Paper] tab in the "ScanSnap Setup Window" (page 102), align the center of the document with the centering mark on the ScanSnap.

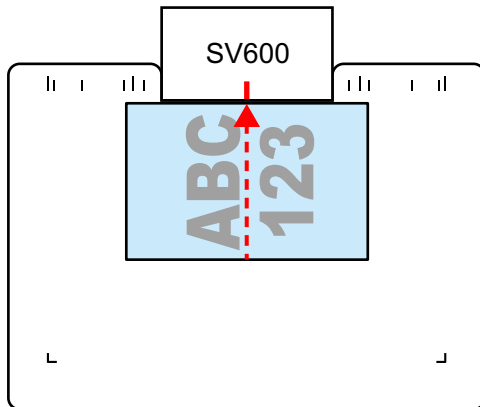

When Placing a Book

Place a book as follows:

- Open a book horizontally.
- Align the center of the opened book face-up with the centering mark.
- Hold the book down with fingers within the appropriate areas.

When holding the book down, use your fingers as follows:

- Keep your fingers straight.
- When using multiple fingers to hold down the book, keep fingers apart by at least 2 cm (0.79 in.).

Appropriate Areas for Holding the Book Down

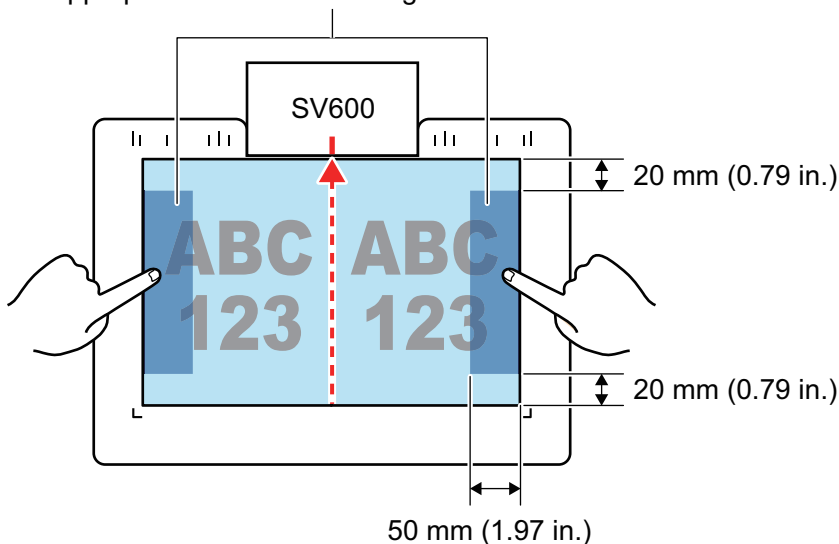

When Placing Multiple Documents at Once

To scan multiple documents at once, place them in the following conditions:

- The documents must be placed at least 15 mm (0.59 in.) apart from each other.

- The number of documents placed must not exceed 10.

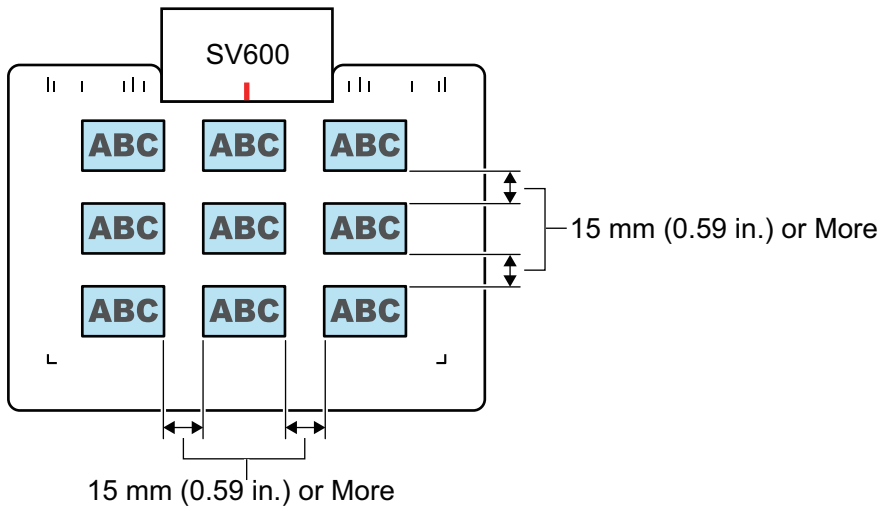

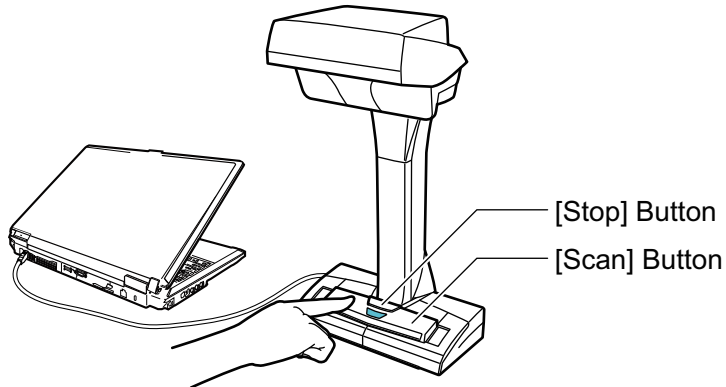

Scanning Documents (SV600)

1. Press the [Scan] or [Stop] button on the ScanSnap to turn the power on.



⇒ The power LED lights up in blue.

In addition, the ScanSnap Manager icon in the notification area changes from  to .

2. Place the Background Pad on the front side of the ScanSnap.

Place the Background Pad so that it is in contact with the ScanSnap.

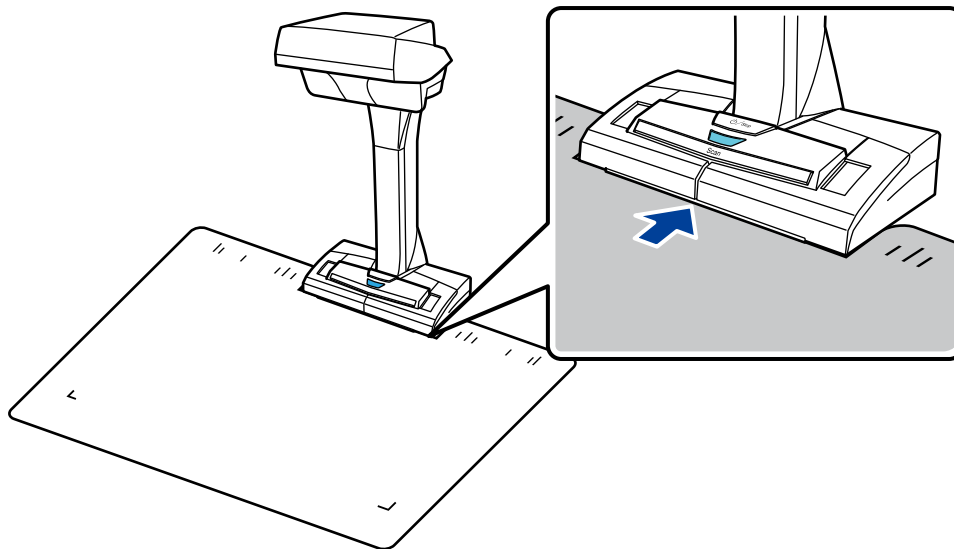

3. Place a document in the scan area of the ScanSnap and press the [Scan] button.

For details, refer to "[Documents to Scan \(SV600\)](#)" (page 346).

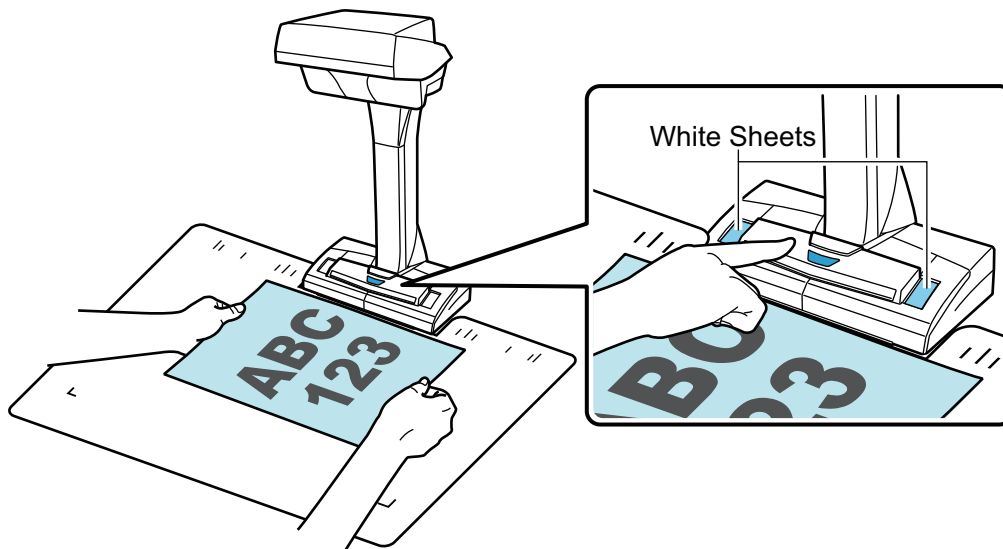

⇒ Scanning starts.

ATTENTION

- Do not perform the following operations during scanning. Doing so will stop scanning.
 - Connect or disconnect the ScanSnap and other USB devices.
 - Switch users.
 - Allow the computer to enter sleep mode.
- Do not cover the white sheet with an object or hand during scanning. The color reproducibility of the scanned image will be affected.
- Do not shake the table or desk when the ScanSnap is being used or move the documents while they are being scanned. Doing so may distort the scanned image or blur the color.

HINT

You can also start scanning documents by right-clicking the ScanSnap Manager icon  in the notification area and then selecting [Scan] from the "Right-Click Menu" (page 100).

⇒ The power LED on the ScanSnap flashes in blue while the documents are being scanned. The [ScanSnap Manager - Image scanning and file saving] window appears.

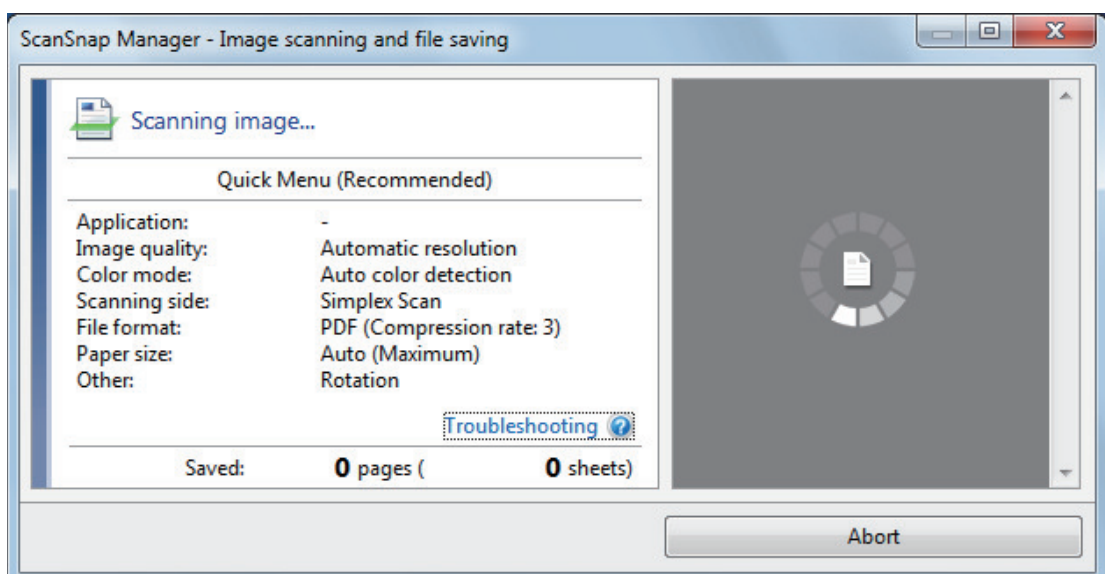

- ⇒ When scanning is complete, the [ScanSnap Manager - Image scanning and file saving] window displays a scanning standby status.

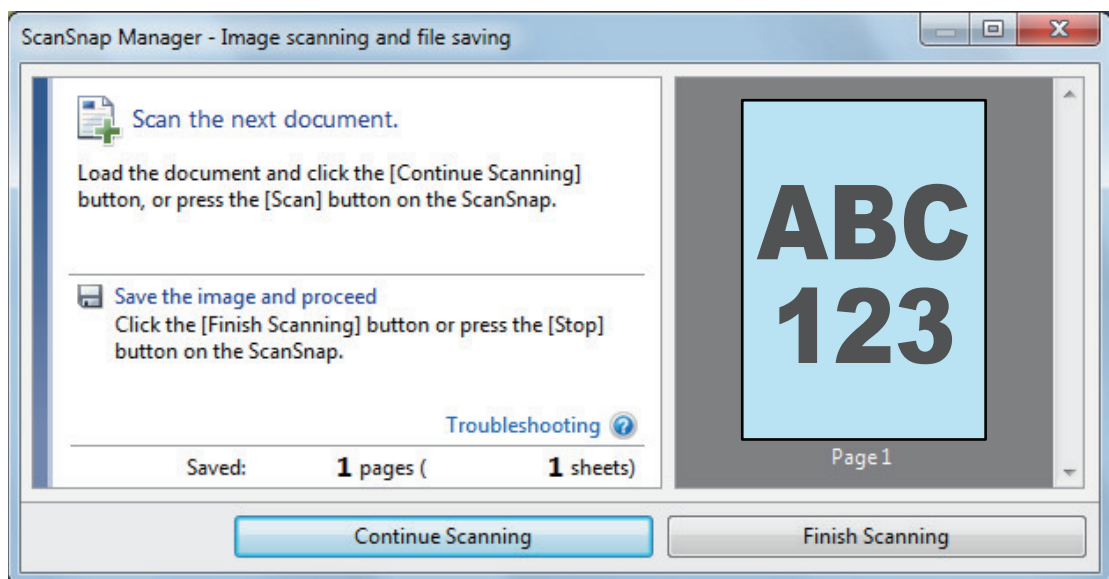

HINT

To continue scanning, place down the next document to be scanned, and then perform one of the following operations. Continuous scanning starts.

- Clicking the [Continue Scanning] button in the [ScanSnap Manager - Image scanning and file saving] window
- Pressing the [Scan] button on the ScanSnap

4. To finish scanning, click the [Finish Scanning] button or press the [Stop] button on the ScanSnap.

- ⇒ A window is displayed for selecting how to save the scanned images.
In the preview area, the scanned images are cropped and displayed.

5. Select [Crop and save flat document images as-is], and then click the [Save this image] button.

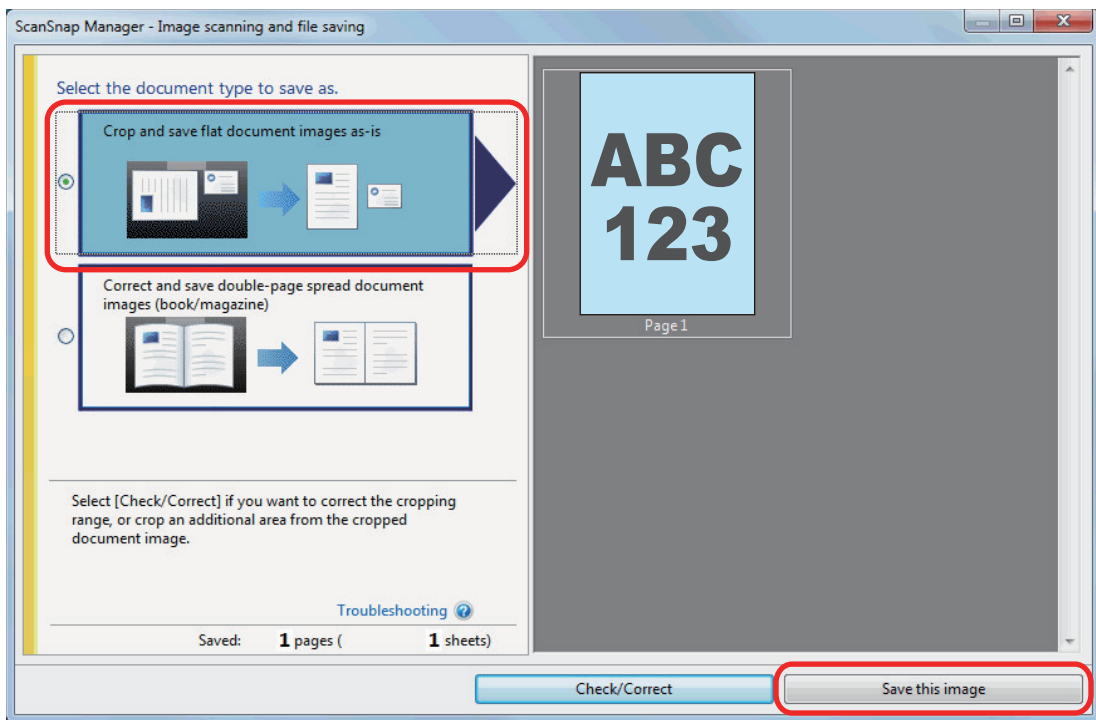

HINT

Click the [Check/Correct] button in the [ScanSnap Manager - Image scanning and file saving] window to correct the scanned image. The following functions are available:

- "Filling in Fingers Captured in a Scanned Image (When a Document Is Scanned)(SV600)" (page 460)
- "Correcting the Scanned Image Orientation (SV600)" (page 477)
- "Modifying the Crop Area (SV600)" (page 480)

⇒ The Quick Menu appears.

6. In the Quick Menu, click the icon of the application to link with ScanSnap Manager.

When you select [Save Documents], you can manage scanned images by folder with ScanSnap Home.

For details, refer to "Managing Paper Documents by Folder on a Computer with ScanSnap Home" (page 440).

HINT

[ScanSnap Organizer] is displayed in the Quick Menu when ScanSnap Organizer is installed.

To manage scanned images by folder with ScanSnap Organizer, refer to "Managing Paper Documents by Folder on a Computer with ScanSnap Organizer" (page 443).



⇒ The selected application starts up. For details, refer to the Advanced Operation Guide.

ATTENTION

- You cannot start scanning when the Quick Menu is displayed. Either select an icon from the Quick Menu and finish the process, or close the Quick Menu before you perform the next scan.
- Do not move, delete, or rename scanned images using other applications while the Quick Menu is displayed.

HINT

- Clicking  displays the description of an application. Placing the mouse cursor over the icon of another application displays the description of the application.
- Performing a scan while an application that can be automatically linked with is active automatically starts the linkage between ScanSnap Manager and the application. For details, refer to the Advanced Operation Guide.

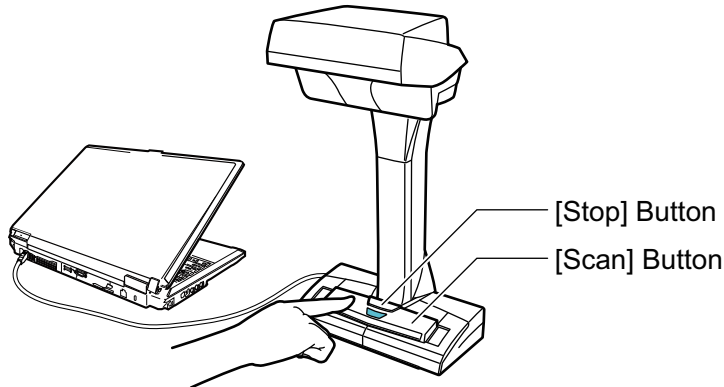

Scanning Books (SV600)

1. Press the [Scan] or [Stop] button on the ScanSnap to turn the power on.



⇒ The power LED lights up in blue.

In addition, the ScanSnap Manager icon in the notification area located at the far right of

the taskbar changes from  to .

2. Place the Background Pad on the front side of the ScanSnap.

Place the Background Pad so that it is in contact with the ScanSnap.

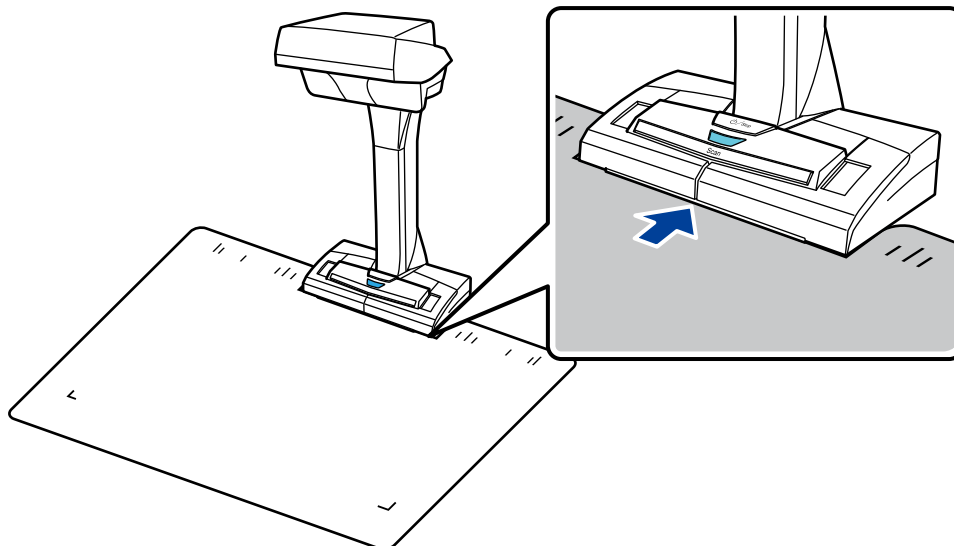

3. Place a book in the scan area of the ScanSnap and press the [Scan] button.

For details, refer to ["How to Place Documents \(SV600\)"](#) (page 347).

HINT

You can also enable page turning detection by holding down the [Scan] button on the ScanSnap for 2 seconds or longer. When page turning detection is used, turning a book's page automatically starts scanning.

For details, refer to ["Scanning Books Using Page Turning Detection \(SV600\)"](#) (page 365).

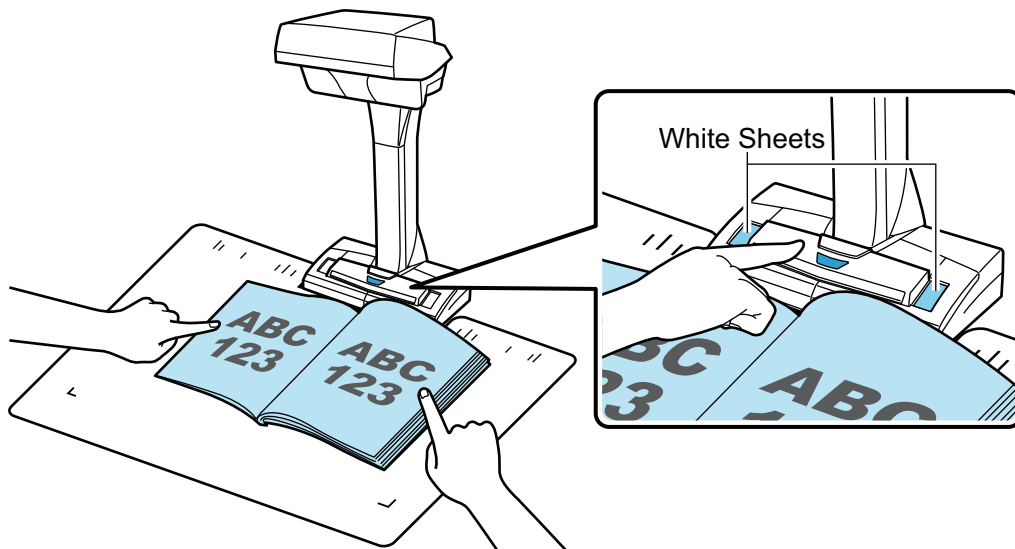

⇒ Scanning of the book starts.

ATTENTION

- Do not perform the following operations during scanning. Doing so will stop scanning.
 - Connect or disconnect the ScanSnap and other USB devices.
 - Switch users.
 - Allow the computer to enter sleep mode.
- Do not cover the white sheet with an object or hand during scanning. The color reproducibility of the scanned image will be affected.
- Do not shake the table or desk when the ScanSnap is being used or move the documents while they are being scanned. Doing so may distort the scanned image or blur the color.

HINT

- You can also start scanning a book by right-clicking the ScanSnap Manager icon  in the notification area and then selecting [Scan] from the "Right-Click Menu" (page 100).
- When timed mode is used, after the specified time the ScanSnap automatically starts scanning. For details, refer to "Scanning Documents Using Timed Mode (SV600)" (page 369).

⇒ The power LED on the ScanSnap flashes in blue while the book is being scanned.
The [ScanSnap Manager - Image scanning and file saving] window appears.

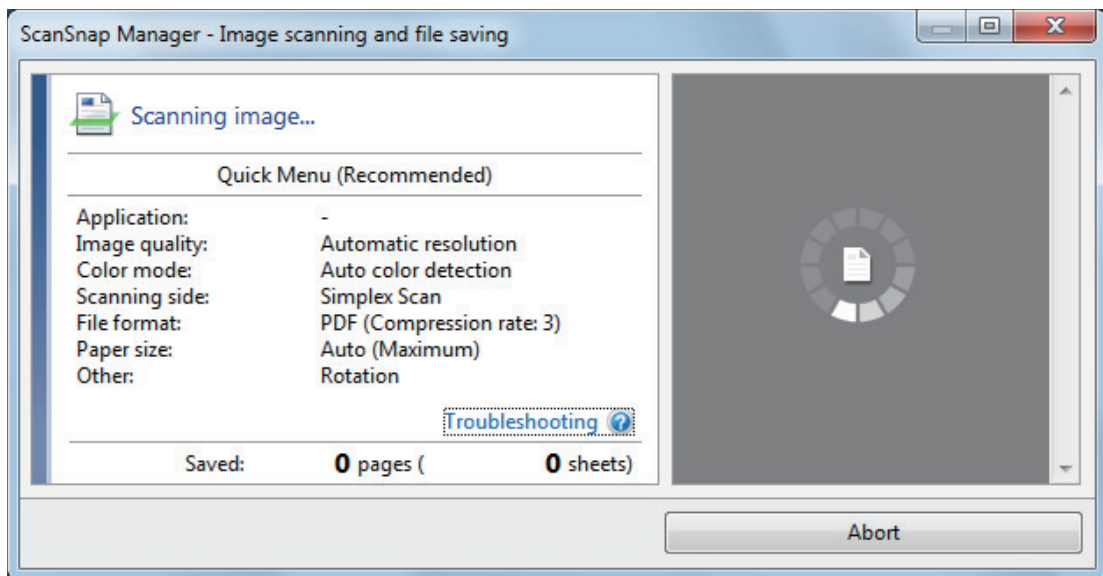

⇒ When scanning the book is complete, the [ScanSnap Manager - Image scanning and file saving] window displays a scanning standby status.

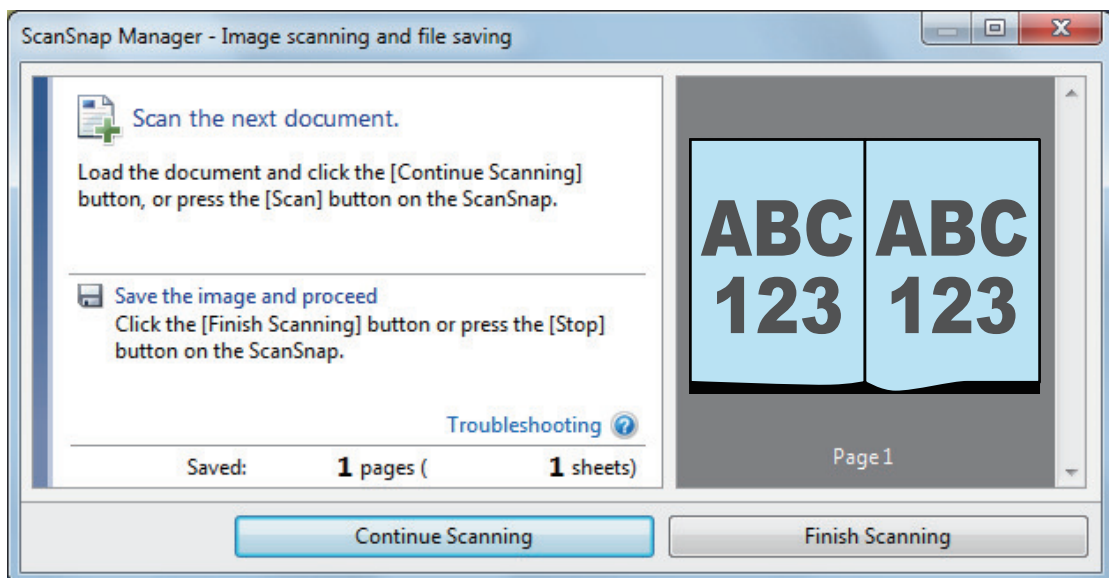

HINT

To continue scanning the book, open the next page to be scanned, and then perform one of the following operations: Continuous scanning of the book starts.

- Clicking the [Continue Scanning] button in the [ScanSnap Manager - Image scanning and file saving] window
- Pressing the [Scan] button on the ScanSnap

4. To finish scanning the book, click the [Finish Scanning] button or press the [Stop] button on the ScanSnap.

⇒ A window is displayed for selecting how to save the scanned images.

In the preview area, the scanned images of the book are cropped and displayed.

5. Select [Correct and save double-page spread document images (book/magazine)], and then click the [Save this image] button.

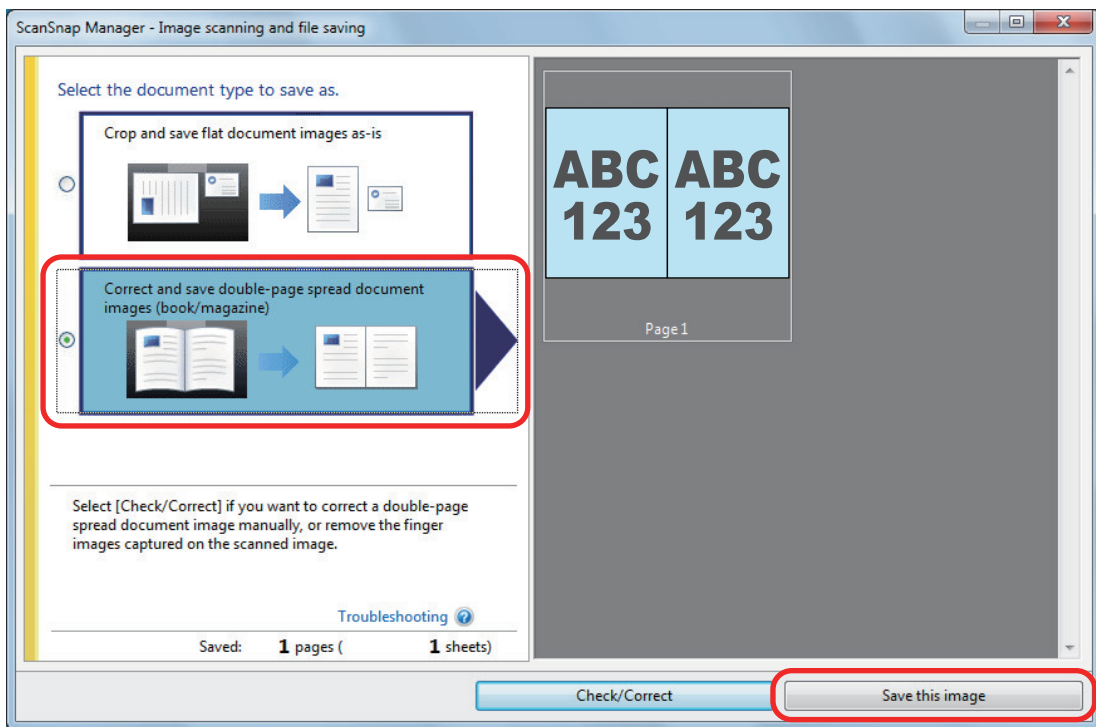

HINT

Click the [Check/Correct] button in the [ScanSnap Manager - Image scanning and file saving] window to correct the scanned image. The following functions are available:

- "Correcting Distorted Book Images (SV600)" (page 465)
- "Splitting a Double-Page Spread Image into Two Page Images (SV600)" (page 470)
- "Filling in Fingers Captured in a Scanned Image (When a Book Is Scanned)(SV600)" (page 473)

⇒ The Quick Menu appears.

6. In the Quick Menu, click the icon of the application to link with ScanSnap Manager.

When you select [Save Documents], you can manage scanned images by folder with ScanSnap Home.

For details, refer to "Managing Paper Documents by Folder on a Computer with ScanSnap Home" (page 440).

HINT

[ScanSnap Organizer] is displayed in the Quick Menu when ScanSnap Organizer is installed.

To manage scanned images by folder with ScanSnap Organizer, refer to "Managing Paper Documents by Folder on a Computer with ScanSnap Organizer" (page 443).

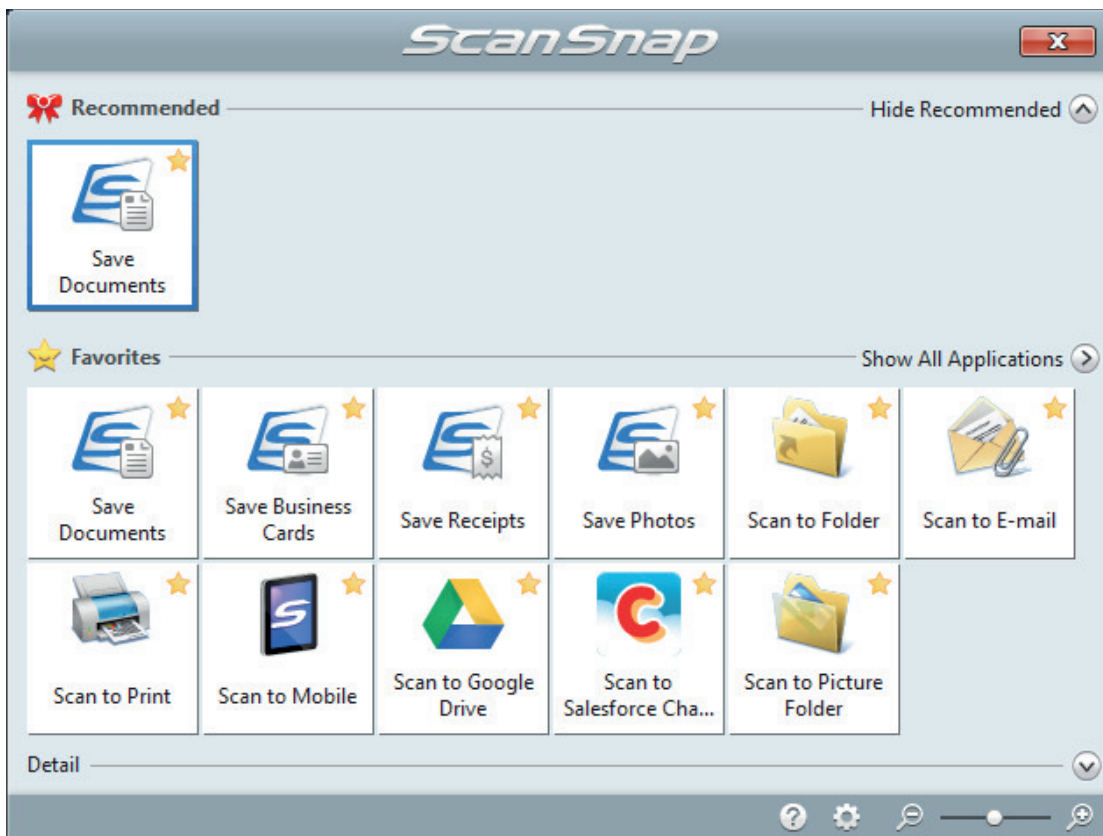

⇒ The selected application starts up. For details, refer to the Advanced Operation Guide.

ATTENTION

- You cannot start scanning when the Quick Menu is displayed. Either select an icon from the Quick Menu and finish the process, or close the Quick Menu before you perform the next scan.
- Do not move, delete, or rename scanned images using other applications while the Quick Menu is displayed.

HINT

- Clicking  displays the description of an application. Placing the mouse cursor over the icon of another application displays the description of the application.
- Performing a scan while an application that can be automatically linked with is active automatically starts the linkage between ScanSnap Manager and the application.
For details, refer to the Advanced Operation Guide.

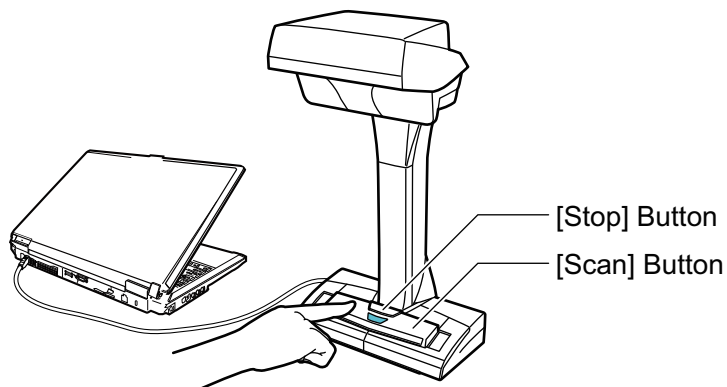

Scanning Multiple Documents at Once (SV600)

- 1. Press the [Scan] or [Stop] button on the ScanSnap to turn the power on.**



⇒ The power LED lights up in blue.

In addition, the ScanSnap Manager icon in the notification area located at the far right of

the taskbar changes from  to .

- 2. Place the Background Pad on the front side of the ScanSnap.**

Place the Background Pad so that it is in contact with the ScanSnap.

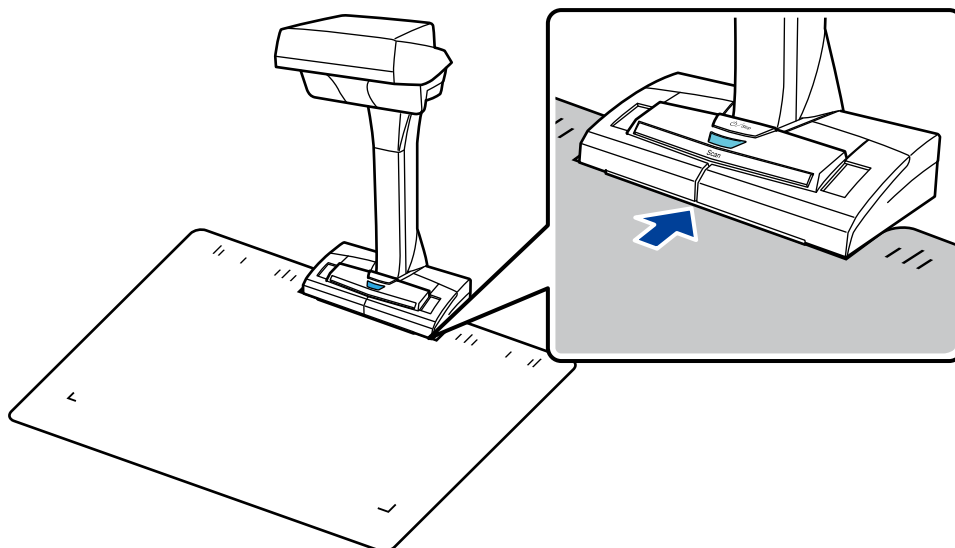

- 3. Place documents in the scan area of the ScanSnap and press the [Scan] button.**

For details, refer to "[How to Place Documents \(SV600\)](#)" (page 347).

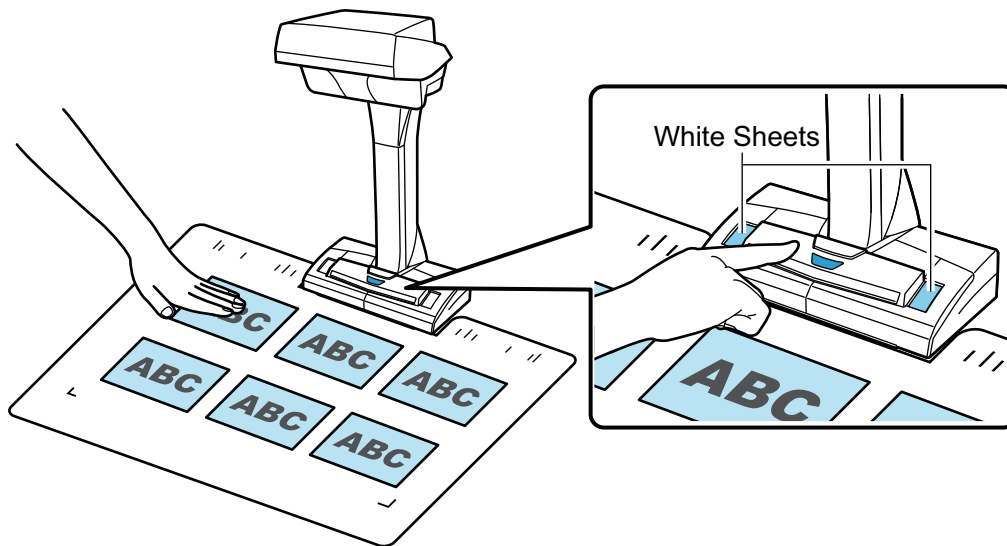

⇒ Scanning starts.

ATTENTION

- Do not perform the following operations during scanning. Doing so will stop scanning.
 - Connect or disconnect the ScanSnap and other USB devices.
 - Switch users.
 - Allow the computer to enter sleep mode.
- Do not cover the white sheet with an object or hand during scanning. The color reproducibility of the scanned image will be affected.
- Do not shake the table or desk when the ScanSnap is being used or move the documents while they are being scanned. Doing so may distort the scanned image or blur the color.

HINT

You can also start scanning documents by right-clicking the ScanSnap Manager icon  in the notification area and then selecting [Scan] from the "Right-Click Menu" (page 100).

⇒ The power LED on the ScanSnap flashes in blue while the documents are being scanned. The [ScanSnap Manager - Image scanning and file saving] window appears.

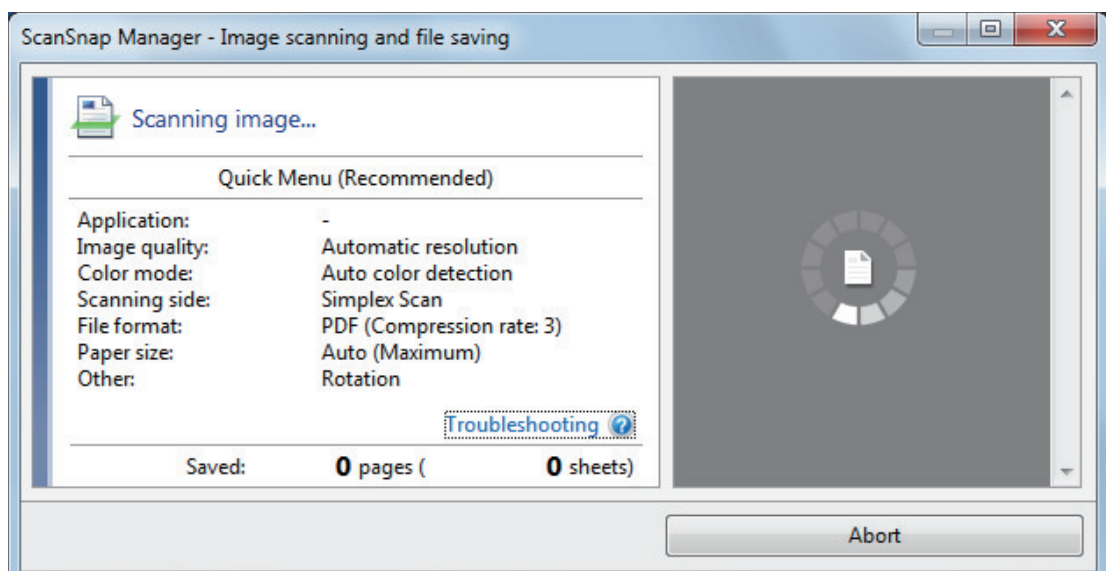

- ⇒ When scanning is complete, the [ScanSnap Manager - Image scanning and file saving] window displays a scanning standby status.

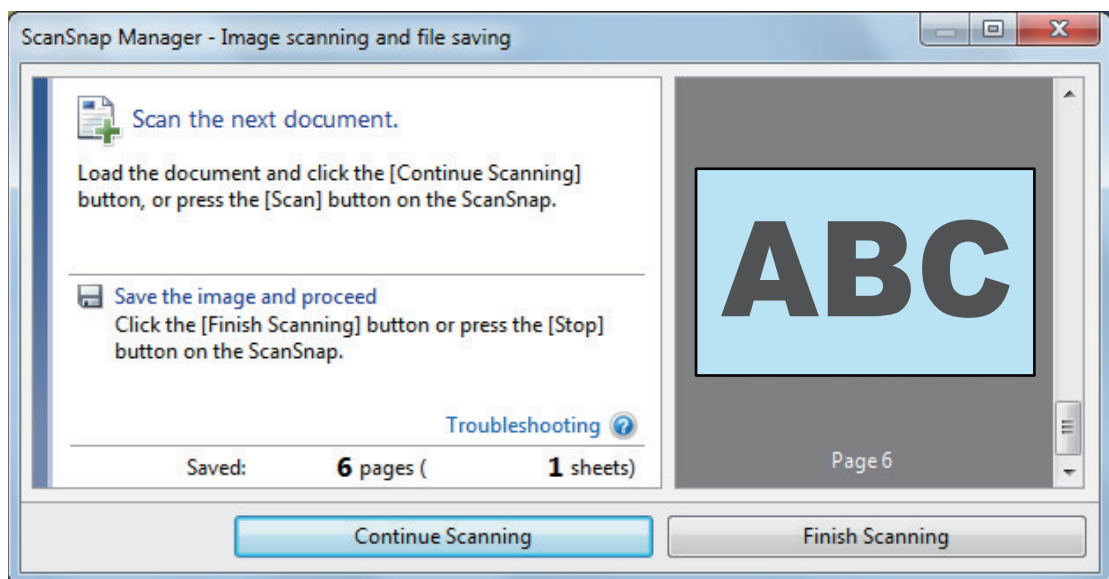

HINT

To continue scanning, place down the next document to be scanned, and then perform one of the following operations. Continuous scanning starts.

- Clicking the [Continue Scanning] button in the [ScanSnap Manager - Image scanning and file saving] window
- Pressing the [Scan] button on the ScanSnap

4. To finish scanning, click the [Finish Scanning] button or press the [Stop] button on the ScanSnap.

- ⇒ A window is displayed for selecting how to save the scanned images.

In the preview area, the scanned images are cropped and each scanned image is displayed as a separate document.

5. Select [Crop and save flat document images as-is], and then click the [Save this image] button.

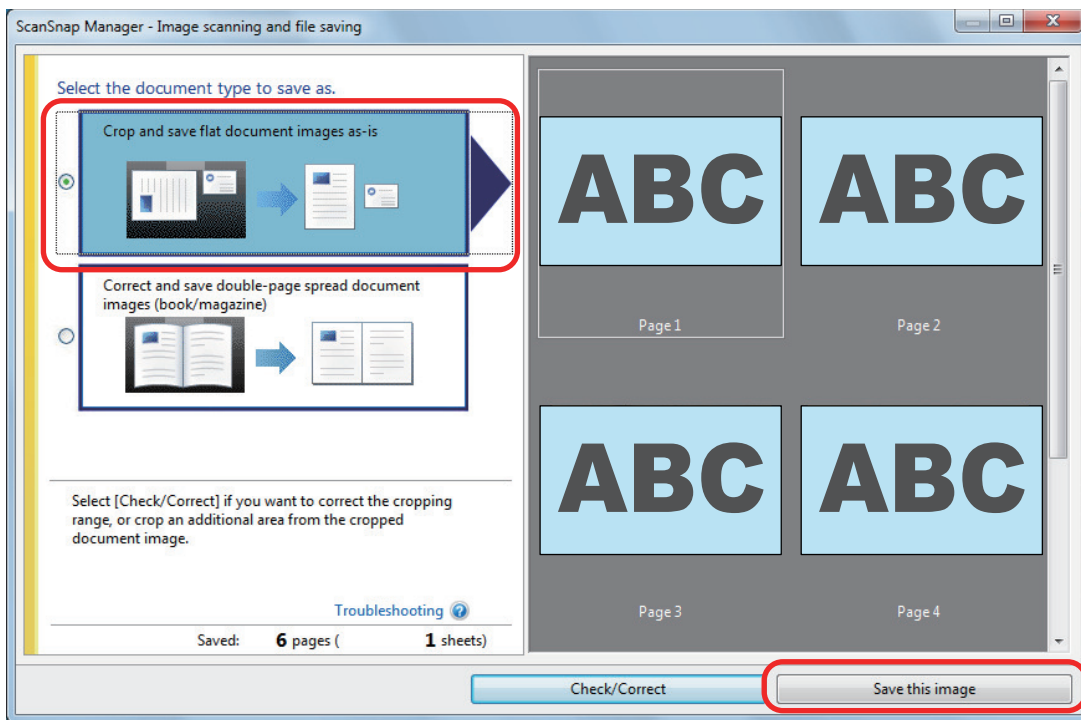

HINT

Click the [Check/Correct] button in the [ScanSnap Manager - Image scanning and file saving] window to correct the scanned image. The following functions are available:

- "Correcting the Scanned Image Orientation (SV600)" (page 477)
- "Modifying the Crop Area (SV600)" (page 480)
- "Adding the Necessary Scanned Images (SV600)" (page 482)
- "Deleting Unnecessary Scanned Images (SV600)" (page 484)

⇒ The Quick Menu appears.

6. In the Quick Menu, click the icon of the application to link with ScanSnap Manager.

When you select [Save Business Cards], you can manage the card data with ScanSnap Home. For details, refer to "Saving Business Card Data to a Computer with ScanSnap Home" (page 446).

HINT

[Scan to CardMinder] is displayed in the Quick Menu when ScanSnap CardMinder is installed. To manage scanned images by folder with ScanSnap CardMinder, refer to "Saving Business Cards to a Computer with CardMinder" (page 449).



⇒ The selected application starts up. For details, refer to the Advanced Operation Guide.

ATTENTION

- You cannot start scanning when the Quick Menu is displayed. Either select an icon from the Quick Menu and finish the process, or close the Quick Menu before you perform the next scan.
- Do not move, delete, or rename scanned images using other applications while the Quick Menu is displayed.

HINT

- Clicking  displays the description of an application. Placing the mouse cursor over the icon of another application displays the description of the application.
- Performing a scan while an application that can be automatically linked with is active automatically starts the linkage between ScanSnap Manager and the application.
For details, refer to the Advanced Operation Guide.

Scanning Books Using Page Turning Detection (SV600)

This section explains how to detect page turning to start scanning automatically.

ATTENTION

When the installation environment of the ScanSnap or the specification of the book to be scanned encounters any of the following, use timed mode to scan a document.

- Installation environment of the ScanSnap
 - The ScanSnap is installed under direct sunlight
 - The ScanSnap is installed under lighting that emits a lot of infrared rays such as incandescent lamps
 - The ScanSnap is under uneven lighting caused by some environmental factors such as the use of a spotlight
 - An object other than the book to be scanned is placed on the Background Pad
 - A device that emits infrared light such as a heater is placed near the ScanSnap
 - Movement of shadow such as a person appears on the Background Pad

- Book specifications

Books that are smaller than A4 (210 × 297 mm)/Letter (8.5 × 11 in. (216 × 279.4 mm)) when opened in a double-page spread

Example: Comic books or pocket edition books

HINT

When scanning a document, you can also enable page turning detection by holding down the [Scan] button on the ScanSnap for 2 seconds or longer. In this case, when one scanning operation is finished, the page turning detection returns to disabled.

- 1. Right-click the ScanSnap Manager icon  in the notification area located at the far right of the taskbar, and select the [Scan Button Settings] from the "Right-Click Menu" (page 100).**
 - ⇒ The ScanSnap setup window appears.
- 2. In the "ScanSnap Setup Window" (page 102), select the [Scanning] tab, and click the [Option] button.**

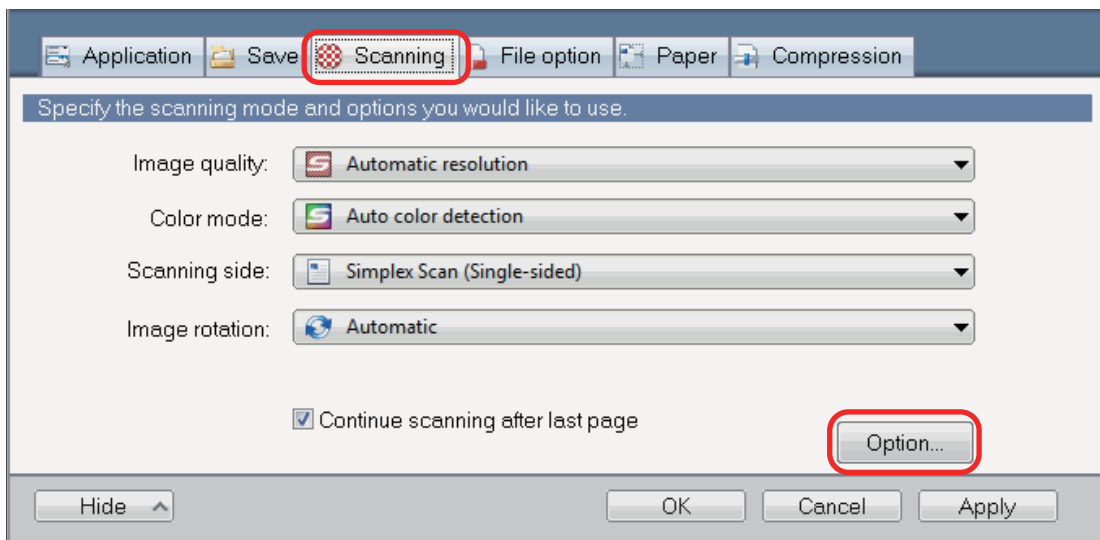

⇒ The [Scanning mode option] window appears.

3. Select the [Configure settings for starting the next scan] checkbox and then [Page turning detection mode].

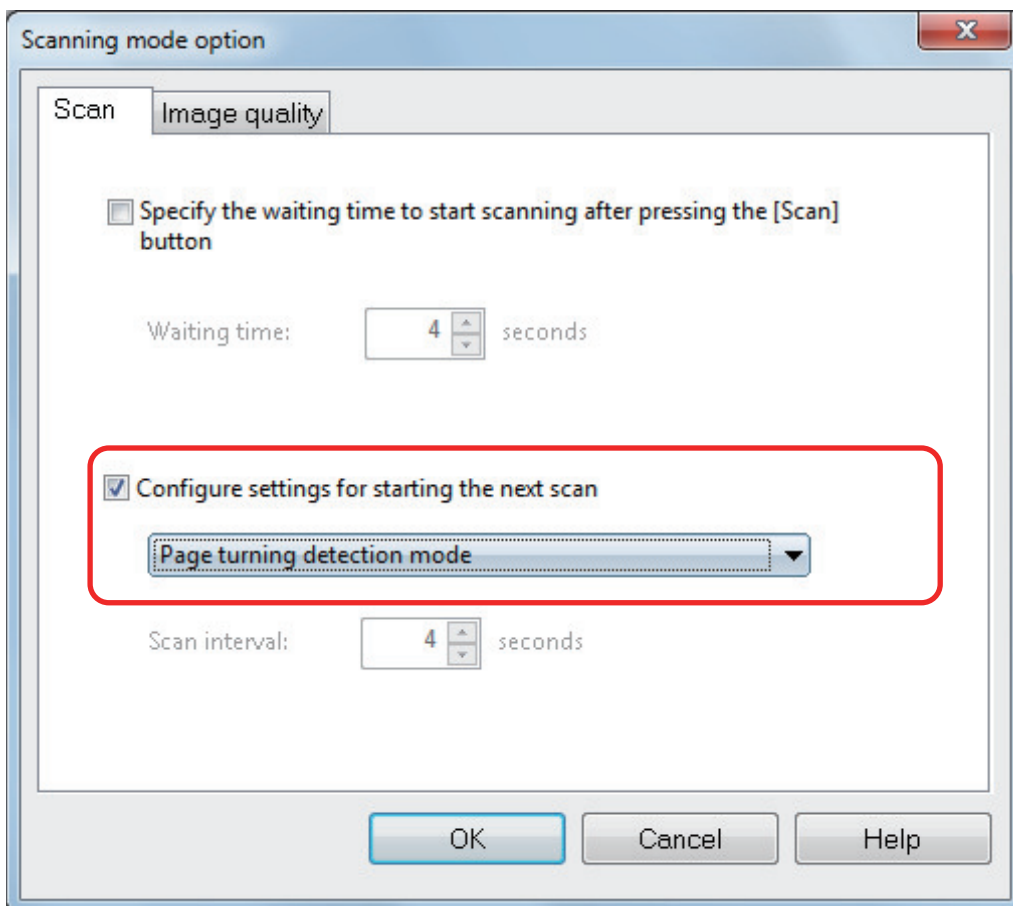

4. Click the [OK] button to close all the windows.
5. Open the page of a book you want to scan and place the book in the scan area of the ScanSnap.

For details, refer to "How to Place Documents (SV600)" (page 347).

6. Press the [Scan] button on the ScanSnap to start scanning the book.

⇒ The [ScanSnap Manager - Image scanning and file saving] window appears.

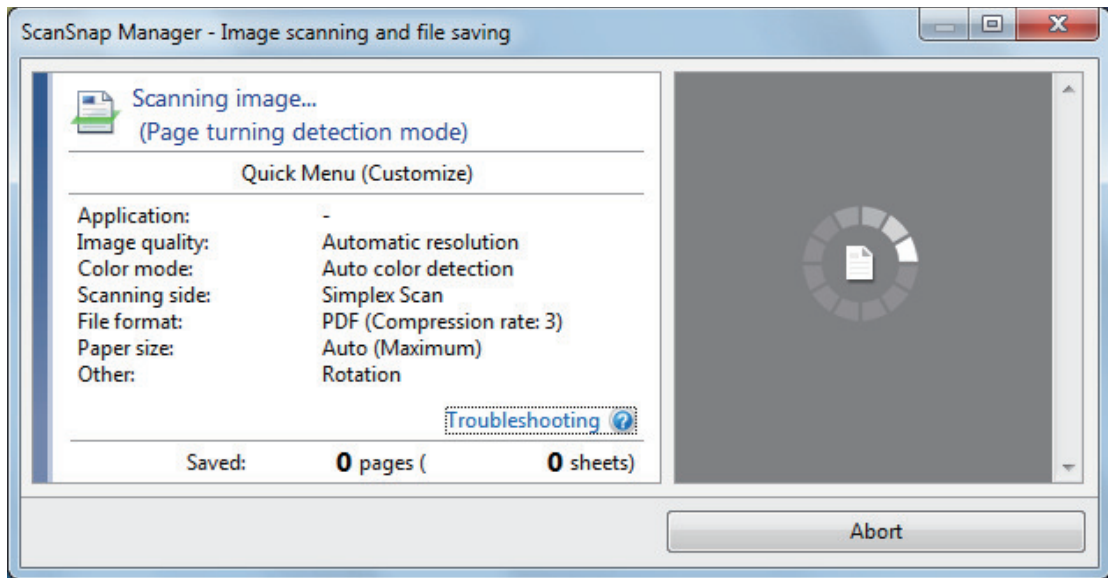

⇒ Once the scanning of the book page is complete, [Turn the page.] appears on the [ScanSnap Manager - Image scanning and file saving] window.

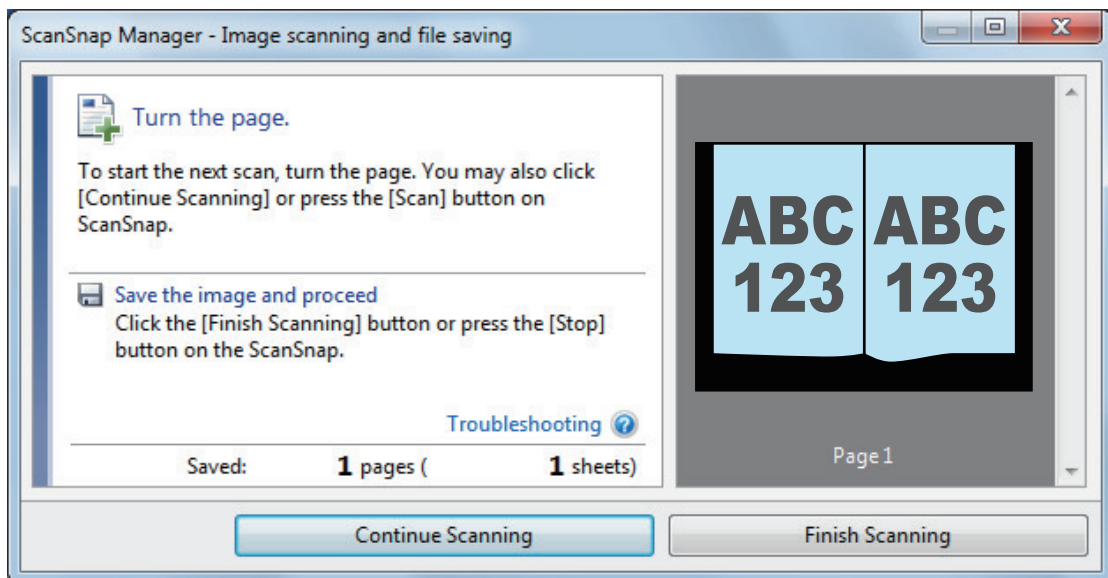

7. Open the next page to be scanned.

Turn the pages at a constant speed. The recommended page turning speed is approximately one to two seconds per page.

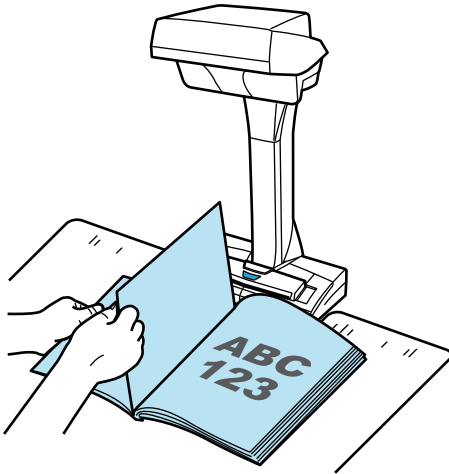

⇒ The page turning is detected and continuous scanning starts.

ATTENTION

- While the [Turn the page.] message appears on the [ScanSnap Manager - Image scanning and file saving] window, if you hold or move your hand over the Background Pad, such motion may be incorrectly detected as page turning.
- If continuous scanning does not start after a page is turned, click the [Continue Scanning] button in the [ScanSnap Manager - Image scanning and file saving] window or press the [Scan] button on the ScanSnap.

HINT

- To make page turning easy to detect, turn each page as follows:
 - Pinch the bottom part of the page and turn it.
 - Keep the page straight when turning it.
- You can change the time before the ScanSnap starts to scan a document after page turning is detected.

On the [Scanning mode option] window shown in step 3, select the [Specify the waiting time to start scanning after pressing the [Scan] button] checkbox, and change [Waiting time].
- To continue scanning, repeat step 7.

8. To finish scanning, click the [Finish Scanning] button or press the [Stop] button on the ScanSnap.

Scanning Documents Using Timed Mode (SV600)

This section explains how to automatically start scanning by setting the time period for the document scanning to start.

1. Right-click the ScanSnap Manager icon  in the notification area, and select [Scan Button Settings] from the "Right-Click Menu" (page 100).
⇒ The ScanSnap setup window appears.
2. In the "ScanSnap Setup Window" (page 102), select the [Scanning] tab, and click the [Option] button.

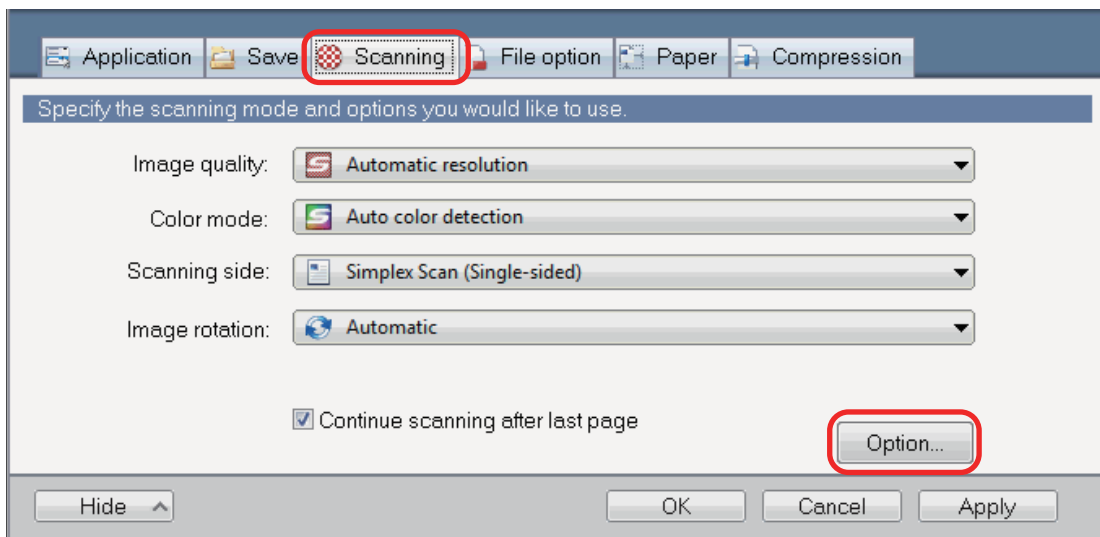

⇒ The [Scanning mode option] window appears.

3. Set the time period before the ScanSnap starts scanning a document.
 - To set the time period before the ScanSnap starts scanning a document after the [Scan] button is pressed:
Select the [Specify the waiting time to start scanning after pressing the [Scan] button] checkbox, and then specify [Waiting time].

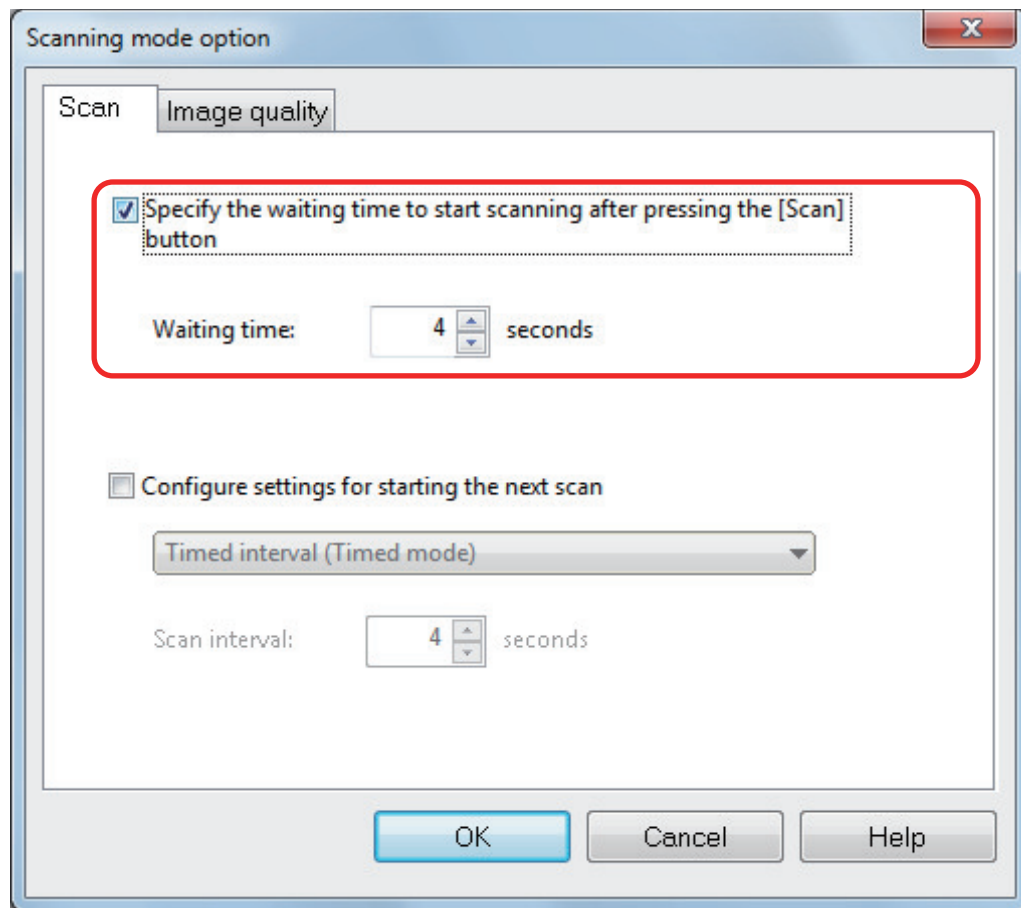

- To set the time period for the ScanSnap to start the next scan when a document is scanned continuously:
 1. Select the [Configure settings for starting the next scan] checkbox, and then select [Timed interval (Timed mode)].
 2. Specify [Scan interval].

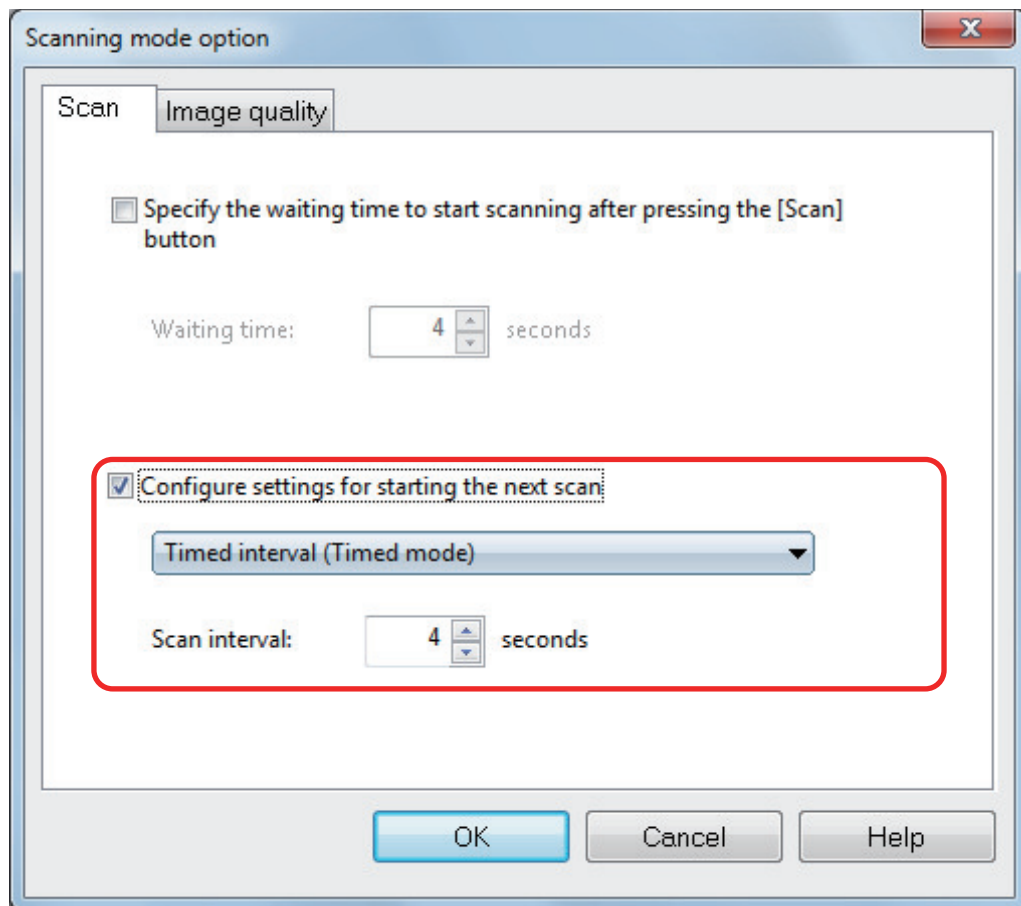

4. Click the [OK] button to close all the windows.
5. Place a document with the scanned side face-up in the scan area of the ScanSnap.
For details, refer to ["How to Place Documents \(SV600\)"](#) (page 347).
6. Press the [Scan] button on the ScanSnap.
⇒ Scanning starts after the time period specified in [Waiting time] passes.
7. Place the next document to be scanned with the scanned side face-up in the scan area.
For details, refer to ["How to Place Documents \(SV600\)"](#) (page 347).
⇒ Scanning starts after the time period specified in [Scan interval] passes.

HINT

To continue scanning, repeat step 7.

8. To finish scanning, click the [Finish Scanning] button or press the [Stop] button on the ScanSnap.

Scanning Documents with Two ScanSnaps Connected to a Computer (SV600)

You can use SV600 and another ScanSnap connected to a computer. When both of the ScanSnap models are connected and turned on, you can use one of them at a time.

Note that you cannot scan documents with two ScanSnap models simultaneously. Before switching the ScanSnap to use, make sure that a series of operations (from scanning a document to linking the ScanSnap with an application) has been completed.

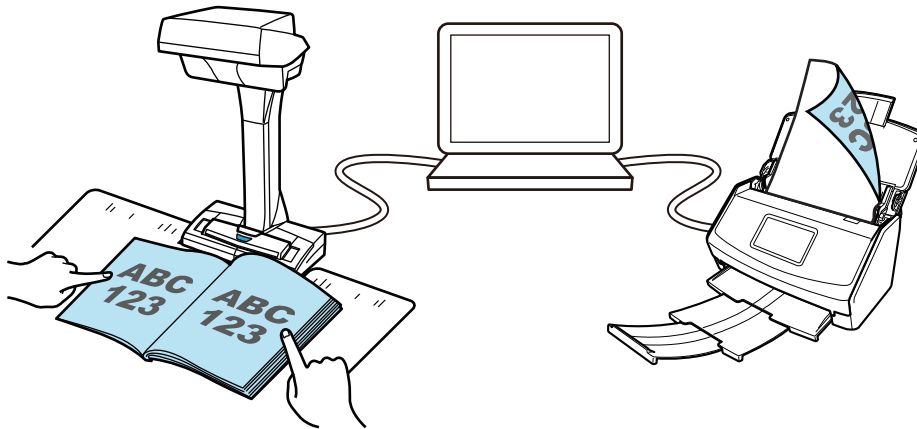

The following ScanSnap models can be connected to a computer and used together with SV600:

- iX1600
- iX1500
- iX1400
- iX1300
- iX500
- iX100
- S1300i
- S1100i

HINT

When you want to create a single PDF file from multiple PDF files created by scanning documents with each of the ScanSnap models, you can use the following applications to merge the PDF files.

- ScanSnap Home
- ScanSnap Organizer
- Nuance Power PDF Standard or Kofax Power PDF Standard

For details, refer to the Help file of each application.

Scanning Documents with S1300i

- "Documents to Scan (S1300i)" (page 374)
- "Scanning Documents (S1300i)" (page 376)
- "Scanning Long Pages (S1300i)" (page 381)
- "Scanning Documents of Different Widths or Lengths in One Batch (S1300i)" (page 385)

Documents to Scan (S1300i)

Conditions for documents that can be loaded into the ScanSnap are as follows:

Office Paper, Postcards, Business Cards

Document type	Office paper, postcards, business cards
Paper weight	64 to 104.7 g/m ² (17 to 20 lb)
Paper size	Width: 50.8 to 216 mm (2 to 8.5 in.) Length: 50.8 to 360 mm (2 to 14.17 in.) ● For long page (*1) 216 × 863 mm (8.5 × 34 in.)

*1: Scanning starts when you hold down the [Scan] button on the ScanSnap for 3 seconds or longer.

ATTENTION

The following types of documents must not be scanned:

- Documents attached with the metals such as paper clips or staples that can damage the inside of the ScanSnap
Remove the metals for scanning.
- Documents on which the ink is still wet
Wait until the ink dries completely to scan these documents.
- Documents larger than width 216 mm (8.5 in.), length 863 mm (34 in.)
- Documents other than paper such as fabric, metal foil, OHP film, or plastic card
- Documents with photographs or memo papers attached

Documents that you need to treat with caution

- Documents written in pencil
When you scan documents written in pencil, there may be black traces left on them. Also, dirt accumulating on the rollers may cause feeding errors. Clean the rollers occasionally when you scan such documents. For details about how to perform cleaning, refer to "Troubleshooting" in the ScanSnap Manager Help.
- Carbonless paper
Carbonless paper may contain chemicals that can harm the pad assy and the pick roller inside the ScanSnap. Make sure to perform cleaning occasionally to maintain the scanner performance when scanning carbonless paper. For details about how to perform cleaning, refer to "Troubleshooting" in the ScanSnap Manager Help. Depending on the type of carbonless paper, the life span of the scanner may be shortened compared to scanning office paper.
- Scanning the following types of documents can result in documents being damaged or scanned incorrectly.
 - Documents smaller than width 50.8 mm (2 in.), length 50.8 mm (2 in.)
 - Documents that weigh less than 64 g/m² (17 lb)
 - Documents with an uneven surface (such as envelopes and paper sheets with attached materials)
 - Wrinkled or curled documents

- Folded or torn documents
- Tracing paper
- Coated paper
- Photographs (photographic paper)
- Perforated or punched documents
- Documents that are not rectangular or square
- Carbon paper or thermal paper
- Documents with memo papers or sticky notes attached

Picture Postcards

Picture postcards can be scanned when a power cable connection is used.

Document type	Picture postcards
Paper weight	64 to 326 g/m ² (17 to 87 lb)
Paper size	Width: 50.8 to 100 mm (2 to 3.9 in.) Length: 50.8 to 148 mm (2 to 5.8 in.)

ATTENTION

- All conditions below must be satisfied when scanning picture postcards. Otherwise, paper jam may occur.
 - Power cable connection
 - Normal room temperature and humidity levels
 - Load the picture postcard face-down in the ScanSnap
- When you scan photographs or picture postcards, be aware that the picture side may get damaged. It is the responsibility of the customer to scan photographs or picture postcards.

Scanning Documents (S1300i)

You can scan documents such as handouts for meetings or business cards.

For details about documents that can be scanned, refer to ["Documents to Scan \(S1300i\)"](#) (page 374).

1. If you are loading multiple sheets, check the number of sheets.

The maximum number of sheets in the ScanSnap is as follows:

For A4 or smaller sizes: Up to 10 sheets can be loaded (with paper weight of 80 g/m² [20 lb] and thickness of the document stack under 1 mm [0.04 in.]).

ATTENTION

If you try to scan more than the maximum amount that can be loaded, the following problems may occur:

- Files cannot be properly created due to excessive file size.
- Paper jams occur during scanning.

2. Fan the documents.

1. Hold both ends of the documents and fan them a few times.

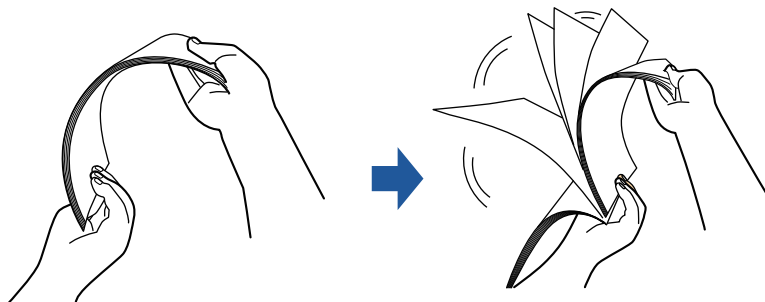

2. Rotate the documents 90 degrees and fan them in the same manner.

3. Straighten the edges of the documents and slightly displace the top edges at an angle.

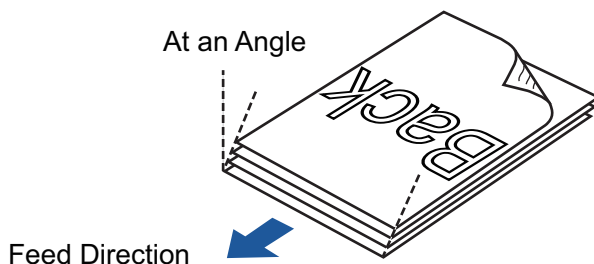

ATTENTION

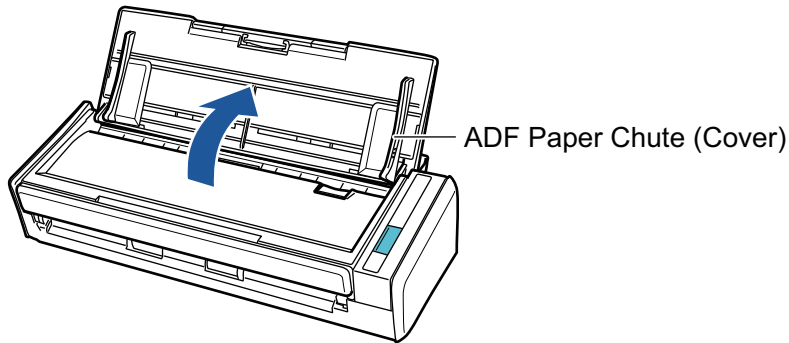

Paper jams or damage to documents may occur if you scan the documents without aligning the edges first.

4. Open the ADF paper chute (cover) of the ScanSnap.



⇒ The [Scan] button flashes in blue. The button returns to being lit normally when document scanning is enabled.

In addition, the ScanSnap Manager icon in the notification area located at the far right of

the taskbar changes from  to .

5. Pull out the extension.

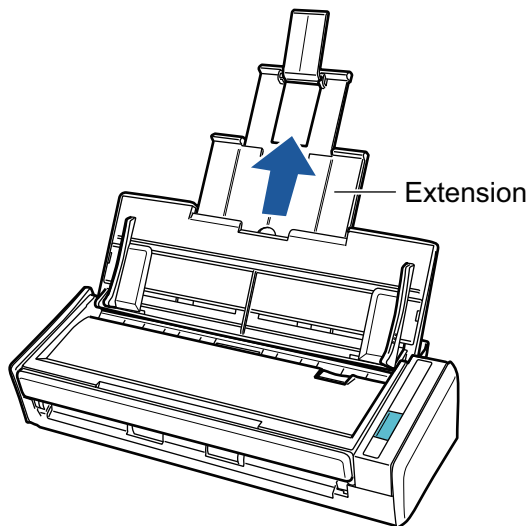

6. Load the documents in the ADF paper chute (cover).

Load the document face-down and head-first with the back facing you (when loading multiple documents, the last page is on the top). Adjust the number of documents so that they do not go beyond the reference marks and are kept within the side guides when they are loaded.

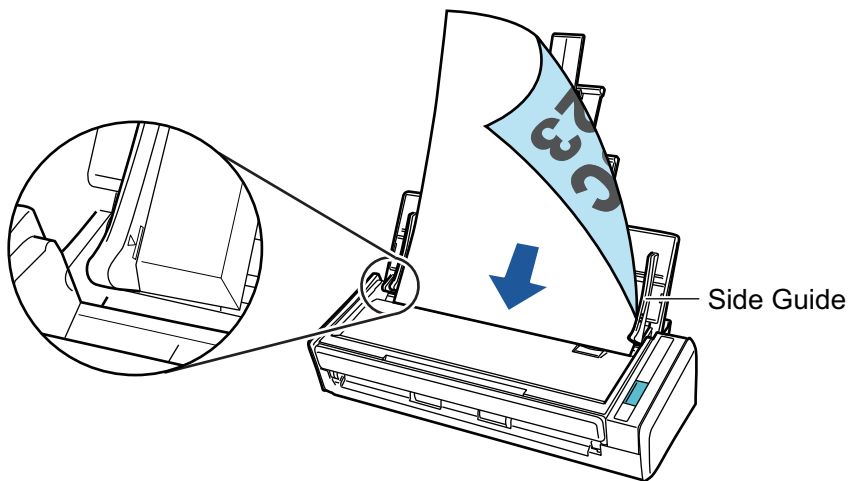
**ATTENTION**

When the [Place document face up] checkbox is selected in the [Scanning mode option] window, load the documents face-up and bottom edge down.

To open the [Scanning mode option] window, click the [Option] button in the [Scanning] tab of the "ScanSnap Setup Window" (page 102).

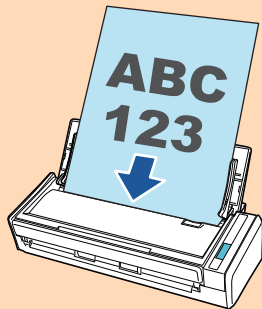
**7. Adjust the side guides to the width of the documents.**

Hold each side guide in the middle to adjust them. Otherwise, the documents may be fed skewed.

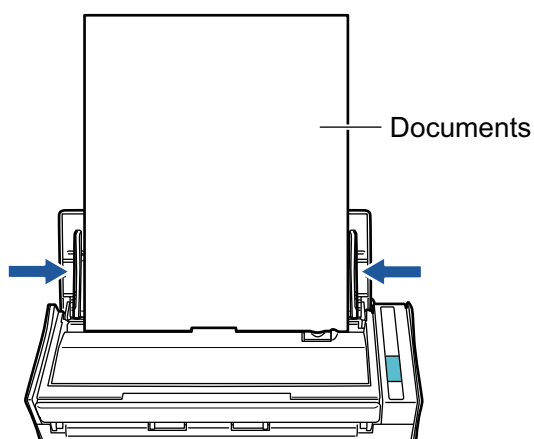
**8. Press the [Scan] button on the ScanSnap to start a scan.****ATTENTION**

Do not perform the following operations during scanning. Doing so will stop scanning.

- Connect or disconnect the ScanSnap and other USB devices.

- Close the ADF paper chute (cover).
- Switch users.
- Allow the computer to enter sleep mode.

⇒ The [Scan] button on the ScanSnap flashes in blue while the documents are being scanned.

The [ScanSnap Manager - Image scanning and file saving] window appears.

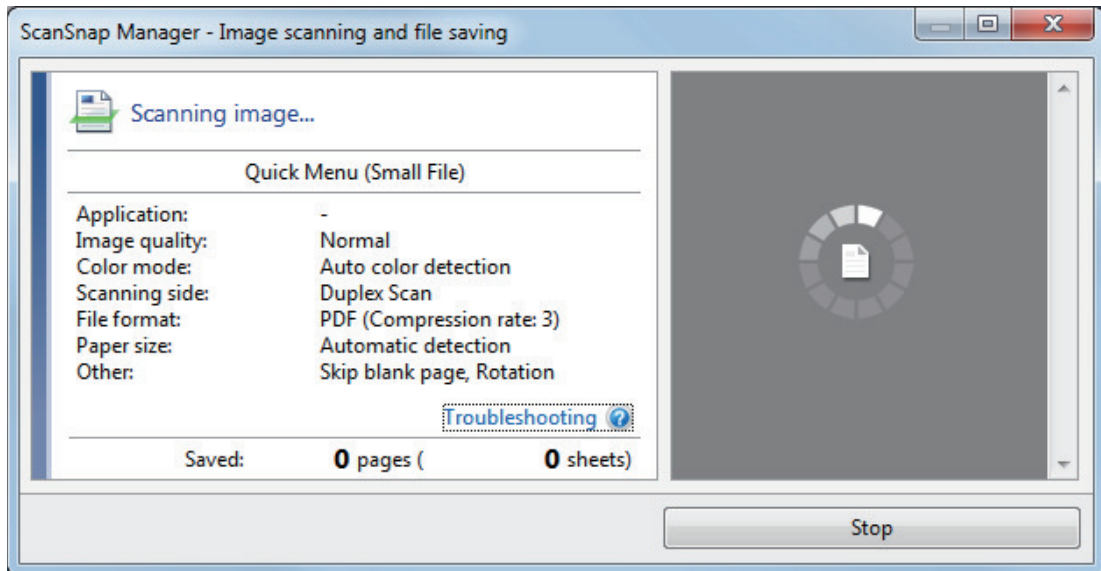

⇒ The Quick Menu appears when the scanning is completed.

9. In the Quick Menu, click the icon of the application to link with ScanSnap Manager.

For details about linking the following applications with ScanSnap Manager, refer to "[Useful Usages](#)" (page 439).

- Save Documents
- Save Business Cards
- Save Receipts
- Save Photos

HINT

The following applications are displayed in the Quick Menu when ScanSnap Organizer and CardMinder are installed.

- When ScanSnap Organizer is installed
ScanSnap Organizer
- When CardMinder is installed
Scan to CardMinder

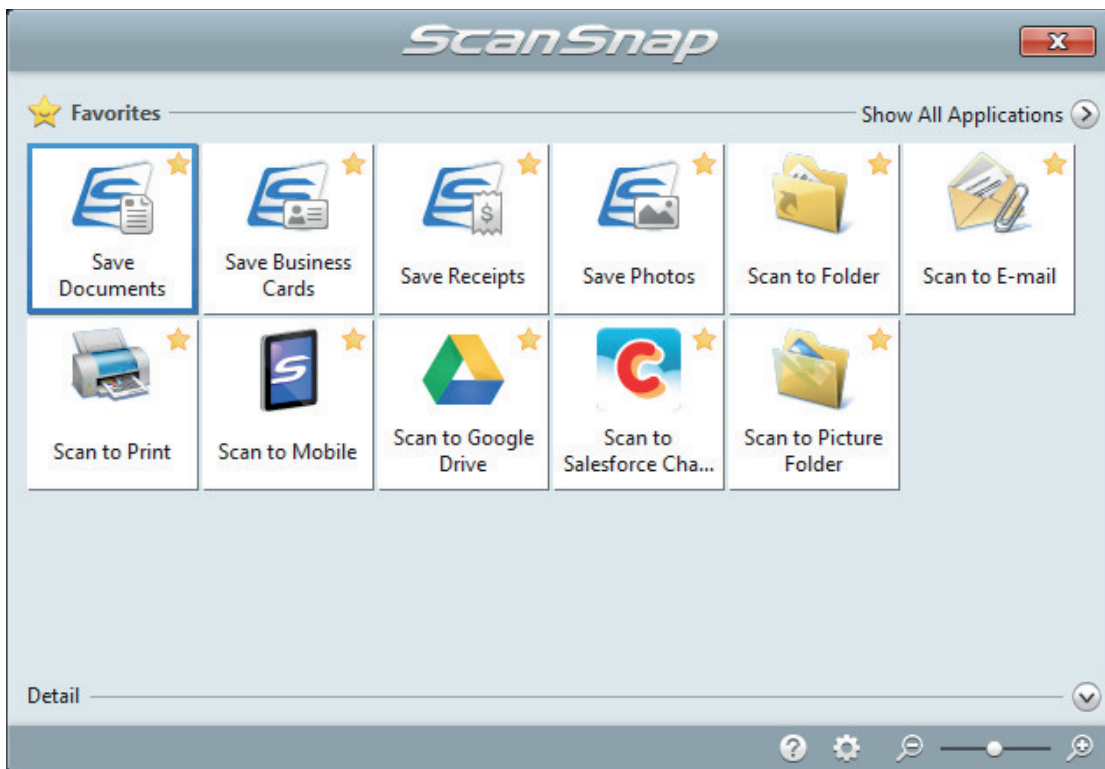

⇒ The selected application starts up. For details, refer to the Advanced Operation Guide.

ATTENTION

- You cannot start scanning when the Quick Menu is displayed. Either select an icon from the Quick Menu and finish the process, or close the Quick Menu before you perform the next scan.
- Do not move, delete, or rename scanned images using other applications while the Quick Menu is displayed.

HINT

- Clicking  displays the description of an application. Placing the mouse cursor over the icon of another application displays the description of the application.
- Performing a scan while an application that can be automatically linked with is active automatically starts the linkage between ScanSnap Manager and the application. For details, refer to the Advanced Operation Guide.

Scanning Long Pages (S1300i)

Documents up to 863 mm (34 in.) in length can be scanned.

For details about documents that can be scanned, refer to ["Documents to Scan \(S1300i\)"](#) (page 374).

HINT

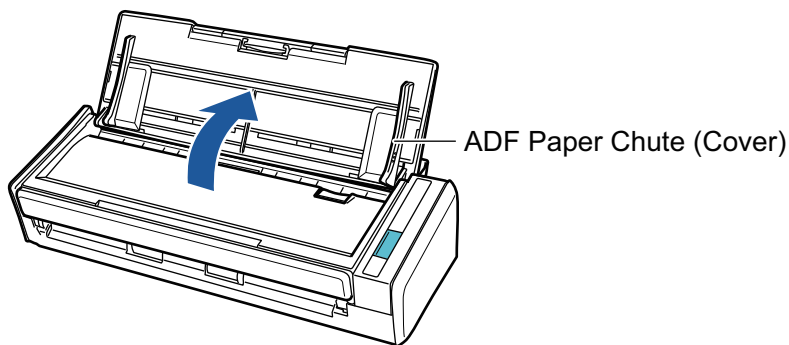

For details about how to load documents that are 360 mm (14.17 in.) or less in length, refer to ["Scanning Documents \(S1300i\)"](#) (page 376).

1. Open the ADF paper chute (cover) of the ScanSnap.



⇒ The [Scan] button flashes in blue. The button returns to being lit normally when document scanning is enabled.

In addition, the ScanSnap Manager icon in the notification area located at the far right of

the taskbar changes from  to .

2. Pull out the extension.

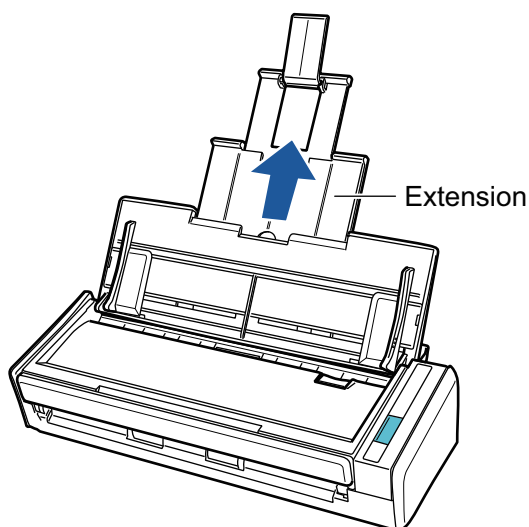

3. Load only one document in the ADF paper chute (cover).

Hold the document with your hand so that it does not fall out of the ADF paper chute (cover).

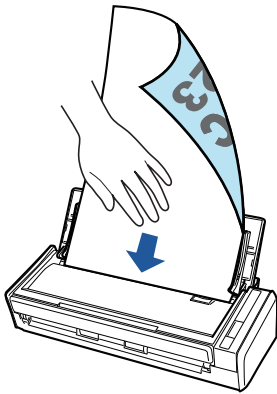

- 4. Press the [Scan] button on the ScanSnap (for three seconds or longer) until the button flashes in blue to start a scan.**

ATTENTION

- Secure enough space where the scanned documents are ejected from the ScanSnap, and pick up the documents with your hands to prevent them from falling off the unit where the ScanSnap is placed on.

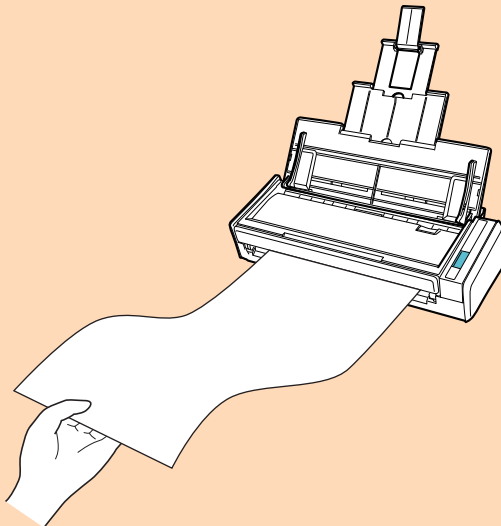

- Do not perform the following operations during scanning. Doing so will stop scanning.
 - Connect or disconnect the ScanSnap and other USB devices.
 - Close the ADF paper chute (cover).
 - Switch users.
 - Allow the computer to enter sleep mode.

HINT

When you scan the first page as a long page and continue scanning, the subsequent documents are also scanned as long pages.

- ⇒ The [Scan] button on the ScanSnap flashes in blue while the documents are being scanned.

The [ScanSnap Manager - Image scanning and file saving] window appears.

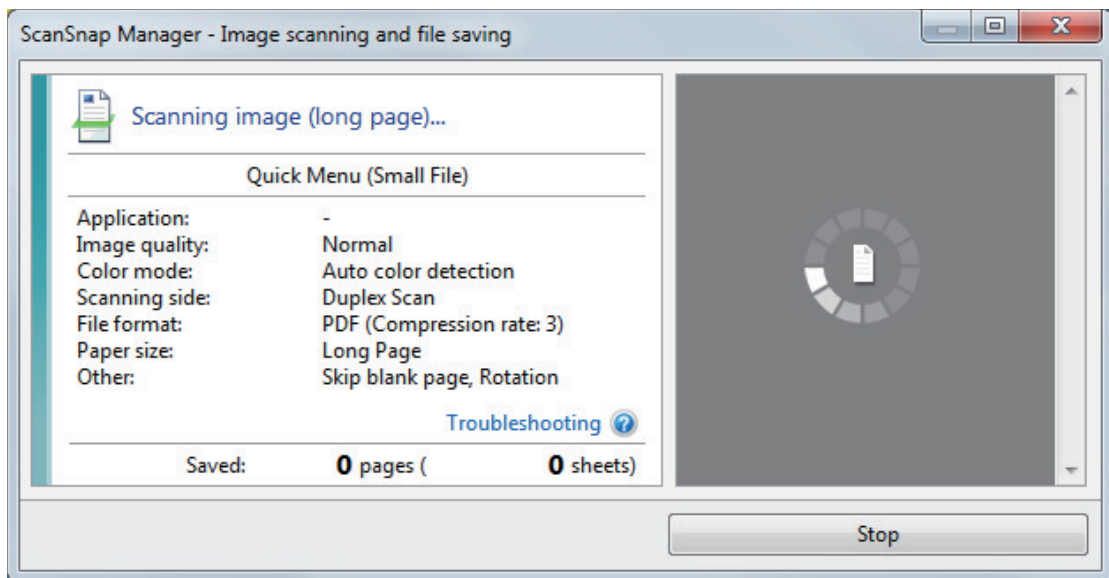

⇒ The Quick Menu appears when the scanning is completed.

5. In the Quick Menu, click the icon of the application to link with ScanSnap Manager.

When you select [Save Documents], you can manage scanned images by folder with ScanSnap Home.

For details, refer to "[Managing Paper Documents by Folder on a Computer with ScanSnap Home](#)" (page 440).

HINT

[ScanSnap Organizer] is displayed in the Quick Menu when ScanSnap Organizer is installed. To manage scanned images by folder with ScanSnap Organizer, refer to "[Managing Paper Documents by Folder on a Computer with ScanSnap Organizer](#)" (page 443).



⇒ The selected application starts up. For details, refer to the Advanced Operation Guide.

ATTENTION

- You cannot start scanning when the Quick Menu is displayed. Either select an icon from the Quick Menu and finish the process, or close the Quick Menu before you perform the next scan.
- Do not move, delete, or rename scanned images using other applications while the Quick Menu is displayed.

HINT

- Clicking  displays the description of an application. Placing the mouse cursor over the icon of another application displays the description of the application.
- Performing a scan while an application that can be automatically linked with is active automatically starts the linkage between ScanSnap Manager and the application.
For details, refer to the Advanced Operation Guide.

Scanning Documents of Different Widths or Lengths in One Batch (S1300i)

Documents of different widths or lengths can be scanned in one batch.

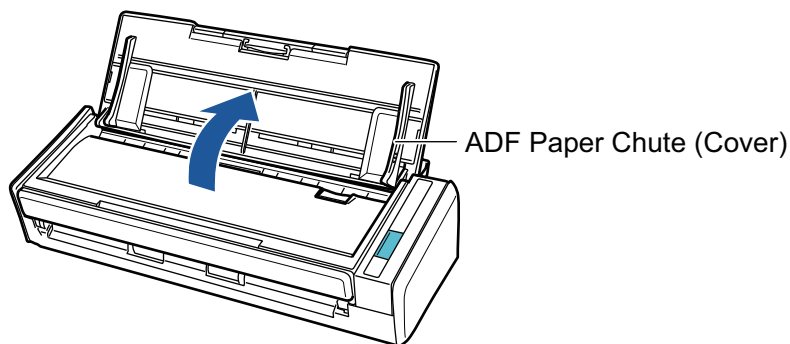

For details about documents that can be scanned, refer to "[Documents to Scan \(S1300i\)](#)" (page 374).

1. Open the ADF paper chute (cover) of the ScanSnap.



⇒ The [Scan] button flashes in blue. The button returns to being lit normally when document scanning is enabled.

In addition, the ScanSnap Manager icon in the notification area located at the far right of

the taskbar changes from  to .

2. Pull out the extension.

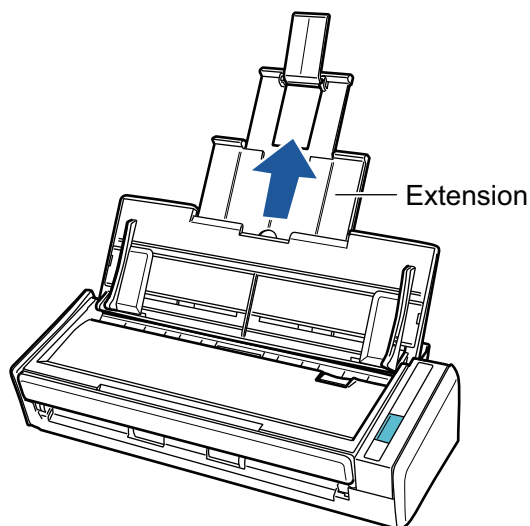

3. Right-click the ScanSnap Manager icon in the notification area located at the far right of the taskbar, and select the [Scan Button Settings] from the "[Right-Click Menu](#)" (page 100).

⇒ The ScanSnap setup window appears.

4. In the [Paper] tab, select [Automatic detection] in [Paper size].

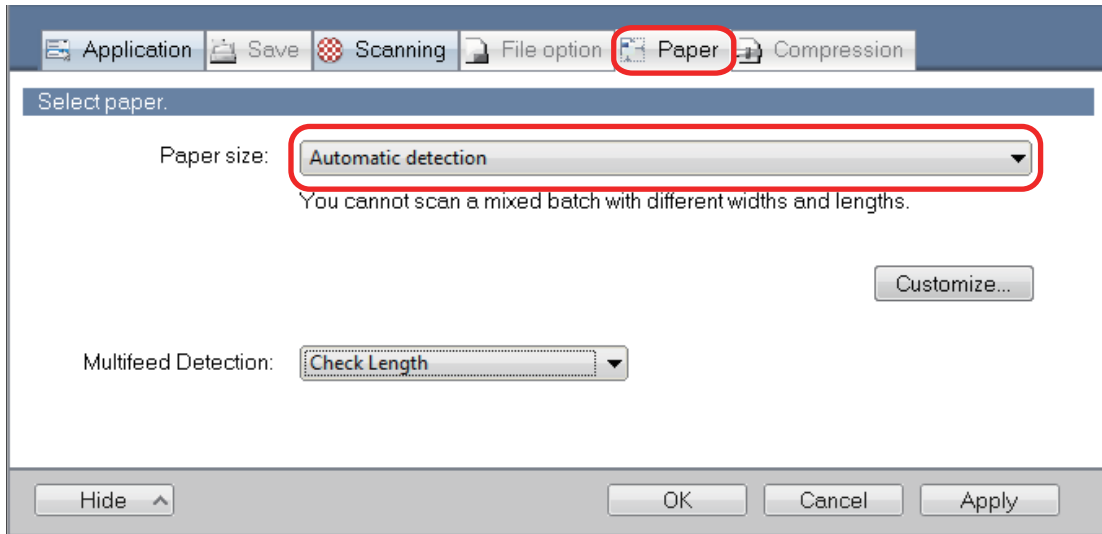

5. Select [None] in [Multifeed Detection].

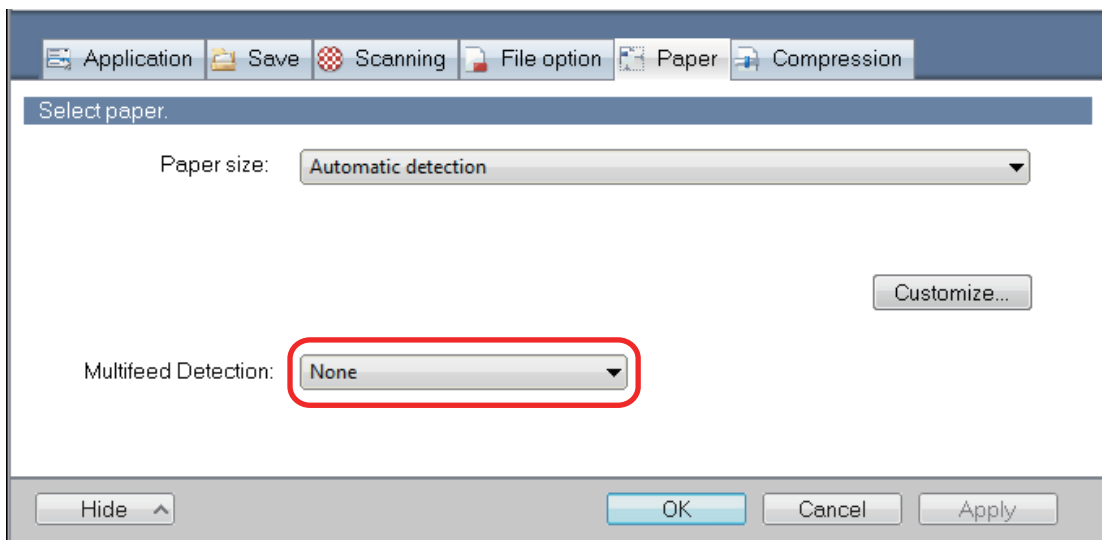

6. Click the [OK] button to close the ScanSnap setup window.

7. Load documents in the ScanSnap.

1. Align the edges of the documents.

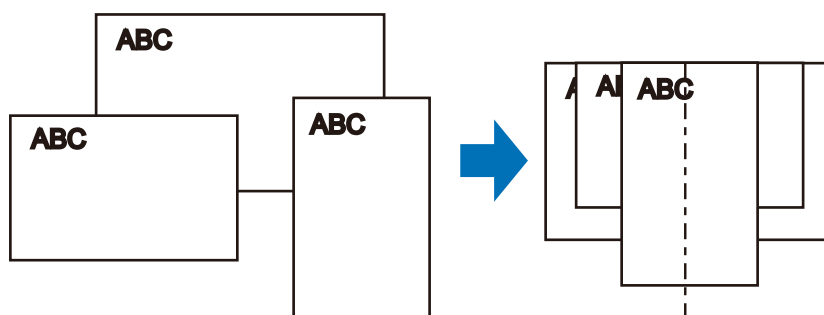

2. Load the documents face-down and top-first with the back of the last document facing you.

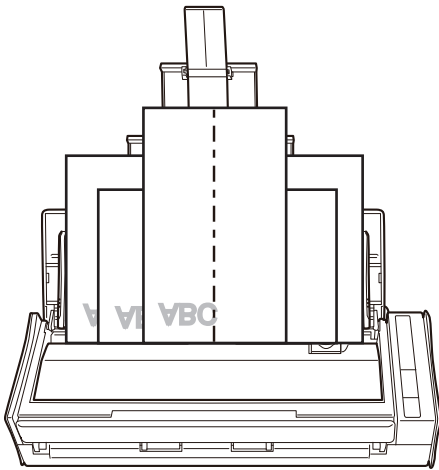

ATTENTION

- The pick roller feeds the documents. Load all documents over one another above the pick roller (center). Documents that are not loaded above the pick roller cannot be fed.

Pick Roller's Width

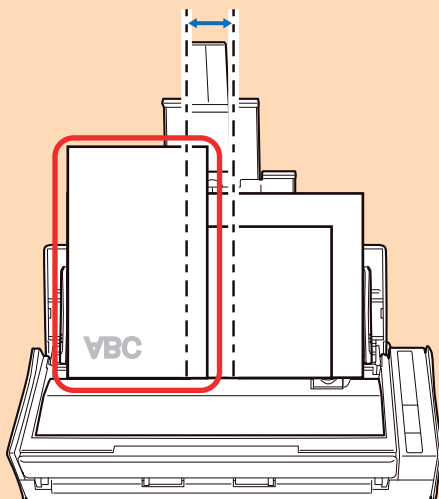

Incorrect

- Adjust the side guides to the widest document. If the side guides are not adjusted properly, a paper jam may occur.
- Load smaller documents so that they can be scanned straight.

If the documents are skewed during scanning, the following problems may occur:

- Part of the document does not appear in the scanned image
- Slant lines appear in the scanned image
- The documents are scanned in a wrong paper size

If the documents are not scanned straight, it is recommended that you select the [Continue scanning after last page] checkbox in the [Scanning] tab of the "ScanSnap Setup Window" (page 102), separate the documents by their widths, and scan them in different batches.

8. Press the [Scan] button on the ScanSnap to start a scan.

ATTENTION

Do not perform the following operations during scanning. Doing so will stop scanning.

- Connect or disconnect the ScanSnap and other USB devices.
- Close the ADF paper chute (cover).

- Switch users.
- Allow the computer to enter sleep mode.

⇒ The [Scan] button on the ScanSnap flashes in blue while the documents are being scanned.

The [ScanSnap Manager - Image scanning and file saving] window appears.

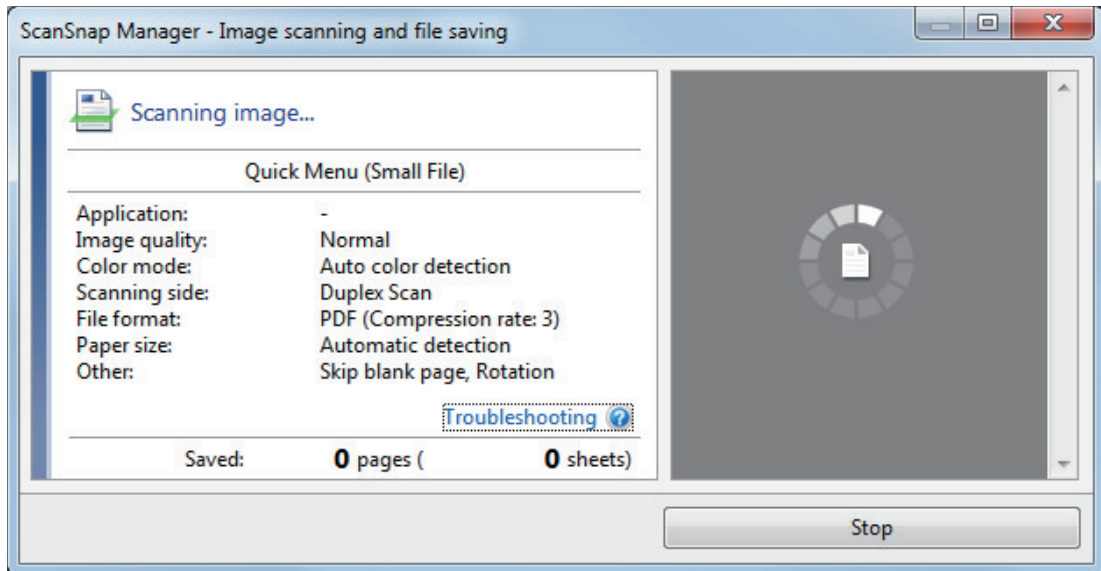

⇒ The Quick Menu appears when the scanning is completed.

9. In the Quick Menu, click the icon of the application to link with ScanSnap Manager.

When you select [Save Documents], you can manage scanned images by folder with ScanSnap Home.

For details, refer to "[Managing Paper Documents by Folder on a Computer with ScanSnap Home](#)" (page 440).

HINT

[ScanSnap Organizer] is displayed in the Quick Menu when ScanSnap Organizer is installed.

To manage scanned images by folder with ScanSnap Organizer, refer to "[Managing Paper Documents by Folder on a Computer with ScanSnap Organizer](#)" (page 443).



⇒ The selected application starts up. For details, refer to the Advanced Operation Guide.

ATTENTION

- You cannot start scanning when the Quick Menu is displayed. Either select an icon from the Quick Menu and finish the process, or close the Quick Menu before you perform the next scan.
- Do not move, delete, or rename scanned images using other applications while the Quick Menu is displayed.

HINT

- Clicking  displays the description of an application. Placing the mouse cursor over the icon of another application displays the description of the application.
- Performing a scan while an application that can be automatically linked with is active automatically starts the linkage between ScanSnap Manager and the application. For details, refer to the Advanced Operation Guide.

Scanning Documents with S1100i

- "Documents to Scan (S1100i)" (page 391)
- "Scanning Documents (S1100i)" (page 395)
- "Scanning Documents by Inserting Two Documents at a Time or by Inserting the Next Document While the Current Document Is Being Scanned (S1100i)" (page 400)
- "Scanning Documents Larger Than A4 or Letter Size by Directly Inserting It in the ScanSnap (S1100i)" (page 407)
- "Scanning Documents Larger than A4 or Letter Size with the Carrier Sheet (S1100i)" (page 411)
- "Scanning Documents Such as Photographs and Clippings (S1100i)" (page 416)

Documents to Scan (S1100i)

This section explains about the conditions for documents that can be loaded directly into the ScanSnap and the conditions for documents that can be scanned using the Carrier Sheet.

Documents That Can Be Loaded Directly into the ScanSnap

Conditions for documents that can be loaded directly into the ScanSnap are as follows:

Eject method (*1)	With the output guide closed	With the output guide open
Document type	Office paper, postcards, business cards Plastic cards conforming to the ISO7810 ID-1 type (54 × 86 mm/3.37 × 2.13 in.) (*2)	Office paper
Paper weight	52 to 209 g/m ² (14 to 56.1 lb) When merging scanned images automatically (*3) 52 to 105 g/m ² (14 to 28 lb) Plastic cards 0.76 mm (0.03 in.) or less (embossed cards can be used)	52 to 80 g/m ² (14 to 20 lb)
Paper size	Width 25.4 to 216 mm (1 to 8.5 in.) For a dual scan, a total width of 200 mm (7.87 in.) or less for two documents Length 25.4 to 863 mm (1 to 34 in.) When merging scanned images automatically (*3) <ul style="list-style-type: none"> ● A3 (297 × 420 mm) ● B4 (257 × 364 mm) ● Double Letter (11 × 17 in. (279.4 × 432 mm)) 	

*1: For details about the eject methods, refer to "Parts and Functions of S1100i" (page 94).

*2: A dual scan cannot be used for plastic cards.

*3: Fold in half to scan.

ATTENTION

- The following types of documents must not be scanned:
 - Documents attached with the metals such as paper clips or staples that can damage the inside of the ScanSnap
Remove the metals for scanning.
 - Documents on which the ink is still wet
Wait until the ink dries completely to scan these documents.
 - Documents larger than 216 × 863 (mm)/8.5 × 34 (in.) (width × length)

- Documents other than paper such as fabric, metal foil and OHP film
- When you scan picture postcards, be aware that the picture side may get damaged. It is the responsibility of the customer to scan picture postcards.
- Be careful of the following when you scan plastic cards:
 - Cards that are bent may not be fed properly.
 - If the surface of the card is dirty with grease marks such as fingerprints, perform scanning after wiping the dirt off.
 - Insert the plastic card straight into the feeding section of the ScanSnap. Do not tilt the plastic card when you insert it because the plastic card may not be fed properly.
 - When you scan plastic cards with strong luster, some parts of the image may appear lighter or darker than the original.

Example: gold colored credit card

- When you scan an embossed card, insert it in the direction shown below.

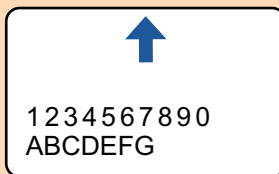

- If the embossed characters are not coated in gold or silver and the background color of the card and the color of the embossed characters are similar, it may be difficult for the ScanSnap to recognize embossed characters.

In which case, performing the following may result in an improvement.

1. Click the [Option] button in the [Scanning] tab of the "ScanSnap Setup Window" (page 102).
 - ⇒ The [Scanning mode option] window appears.
2. Select the [Increase text contrast] checkbox.

Documents That Can Be Scanned Using the Carrier Sheet

The optional Carrier Sheet is a sheet designed to transport documents through the ScanSnap.

You can scan documents that are larger than A4/Letter size, photographs, and clippings.

Conditions for documents that can be scanned using the Carrier Sheet are as follows:



- Do not use a damaged Carrier Sheet. Otherwise, it may damage or cause the ScanSnap to malfunction.
- Be careful not to cut your finger on the edge of the Carrier Sheet.

Eject method	With the output guide closed
Document type	Documents that cannot be loaded directly into the ScanSnap
Paper weight	52.3 to 104.7 g/m ² (14 to 28 lb) When scanning documents folded in half: Up to 64 g/m ² (17 lb)

Paper size	Carrier Sheet size (216 × 297 mm) A3 (297 × 420 mm) (*1) A4 (210 × 297 mm) A5 (148 × 210 mm) A6 (105 × 148 mm) B4 (257 × 364 mm) (*1) B5 (182 × 257 mm) B6 (128 × 182 mm) Postcard (100 × 148 mm) Business card (90 × 55 mm, 55 × 90 mm) Letter (8.5 × 11 in., 216 × 279.4 mm) 11 × 17 in. (279.4 × 431.8 mm) (*1) Custom size Width: 25.4 to 216 mm (1 to 8.5 in.) Length: 25.4 to 297 mm (1 to 11.69 in.)
-------------------	--

*1: Fold in half to scan.

Documents for Which the Carrier Sheet is Recommended for Scanning

It is recommended that you use the Carrier Sheet to scan the following documents.

- Documents written in pencil

Because there may be black traces left on the documents, it is recommended that you use the Carrier Sheet to scan such documents.

When you scan such documents directly without using a Carrier Sheet, dirt will accumulate on the rollers, which may cause feeding errors. Clean the rollers occasionally.

For details about how to perform cleaning, refer to "[Cleaning the Inside of S1100i](#)" (page 544).

- Carbonless paper

Because carbonless paper may contain chemicals that can harm the ScanSnap internal rollers, it is recommended that you use the Carrier Sheet to scan such documents.

Make sure to clean the rollers occasionally to maintain the scanner performance when scanning carbonless paper directly without using the Carrier Sheet. For details about how to perform cleaning, refer to "[Cleaning the Inside of S1100i](#)" (page 544).

Depending on the type of carbonless paper, the life span of the scanner may be shortened compared to scanning office paper.

- Scanning the following types of documents without using the Carrier Sheet can result in documents being damaged or scanned incorrectly

- Documents smaller than 25.4 × 25.4 (mm)/1 × 1 (in.) (width × length)
- Documents whose paper weight is less than 52.3 g/m² (14 lb)
- Documents with an uneven surface (such as envelopes and paper sheets with attached materials)
- Wrinkled or curled documents
- Folded or torn documents
- Tracing paper
- Coated paper
- Photographs (photographic paper)
- Perforated or punched documents
- Documents that are not rectangular or square

- Carbon paper or thermal paper
- Documents with memo papers or sticky notes attached

ATTENTION

- Using the Carrier Sheet

Be careful of the following when you use the Carrier Sheet:

- Do not stain, or cut the black and white patterned end of the Carrier Sheet. Otherwise, the Carrier Sheet will not be recognized properly.
- Do not place the Carrier Sheet upside down. Otherwise, a paper jam may occur and damage the Carrier Sheet and the document inside.
- Do not fold or pull the Carrier Sheet.
- Paper jams may occur when several small size documents such as photographs and postcards are placed inside the Carrier Sheet to be scanned at once. It is recommended that you scan such documents one at a time.

- Storing the Carrier Sheet

Be careful of the following when you store the Carrier Sheet:

- Do not leave your document inside the Carrier Sheet for a long time. Otherwise, the ink on the document may be transferred onto the Carrier Sheet.
- Do not leave the Carrier Sheet in high temperature places such as under direct sunlight or near a heating apparatus for a long time. Also, do not use the Carrier Sheet in high temperature places. The Carrier Sheet may be deformed.
- To avoid deformation, store the Carrier Sheet on a flat surface without any weight on it.

Scanning Documents (S1100i)

The procedure for scanning documents by inserting one document at a time is as follows.

For details about documents that can be scanned, refer to ["Documents to Scan \(S1100i\)"](#) (page 391).

1. Open the feed guide of the ScanSnap.

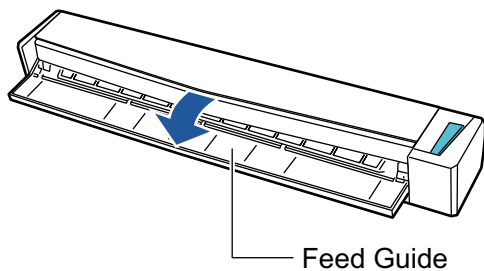

HINT

- If you want the document to be ejected from the front of the ScanSnap or when there is not enough space where the document exits the ScanSnap, open the output guide.

For details about documents that can be scanned with the output guide open, refer to ["Documents to Scan \(S1100i\)"](#) (page 391).

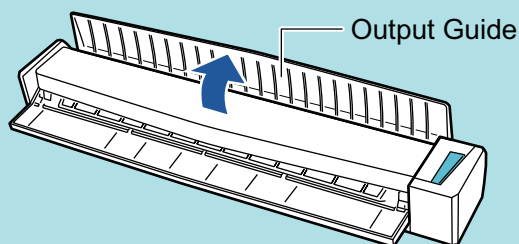

- How the document is ejected differs as below depending on whether the output guide is open or closed.

- When the output guide is closed



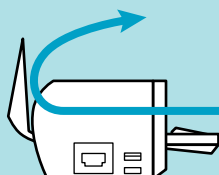

- When the output guide is open



⇒ The [Scan/Stop] button flashes in blue. The button returns to being lit normally when document scanning is enabled.

In addition, the ScanSnap Manager icon in the notification area located at the far right of

the taskbar changes from  to .

- 2. Insert the document straight into the feeding section of the ScanSnap, with the scanning side facing up.**

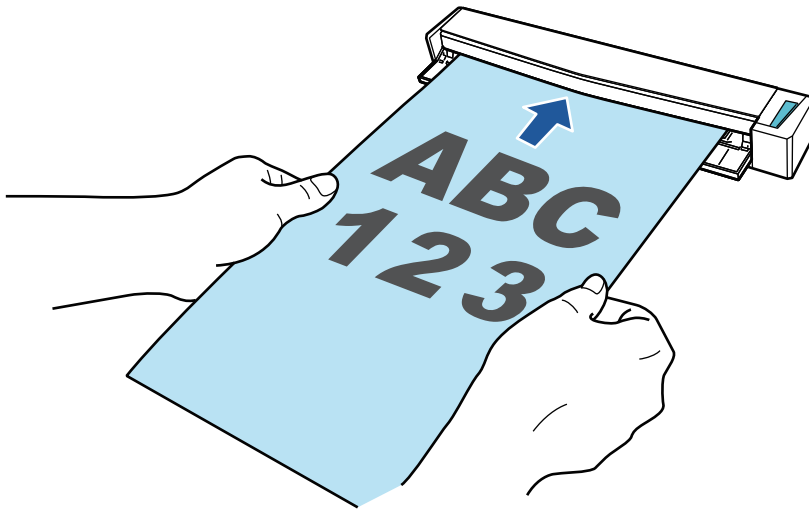

⇒ The document is pulled in until it is set inside the ScanSnap.

ATTENTION

- If you specify a standard size instead of selecting [Automatic detection] (default), insert the document by aligning it with the left edge of the feeding section.

You can configure the scan settings in the "[ScanSnap Setup Window](#)" (page 102).

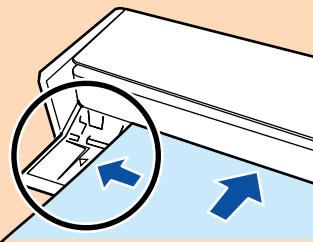

- When you perform scanning with the output guide closed, leave enough space at the back of the ScanSnap to allow the document to be completely ejected. In addition, when you scan long page documents, hold the scanned documents with your hands to prevent them from falling off the unit where the ScanSnap is placed on.

Make sure that the area where the document exits the scanner is clear of any obstacles. Otherwise, paper jam may occur.

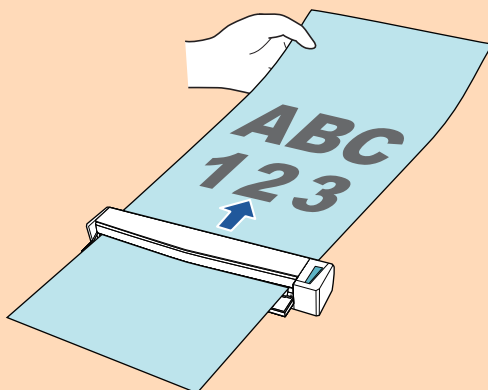

- If you scan the following documents with the output guide open, a paper jam may occur and damage the documents. Scan the following documents with the output guide closed.
 - Thick paper (80 g/m² [20 lb] or heavier)
 - Postcards

- Business cards
- Plastic cards
- Carrier Sheets

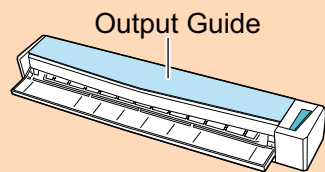

3. Press the [Scan/Stop] button on the ScanSnap to start scanning.

ATTENTION

Do not perform the following operations during scanning. Doing so will stop scanning.

- Connect or disconnect the ScanSnap and other USB devices.
- Close the feed guide.
- Switch users.
- Allow the computer to enter sleep mode.

⇒ The [Scan/Stop] button on the ScanSnap flashes in blue while the documents are being scanned.

The [ScanSnap Manager - Image scanning and file saving] window appears.

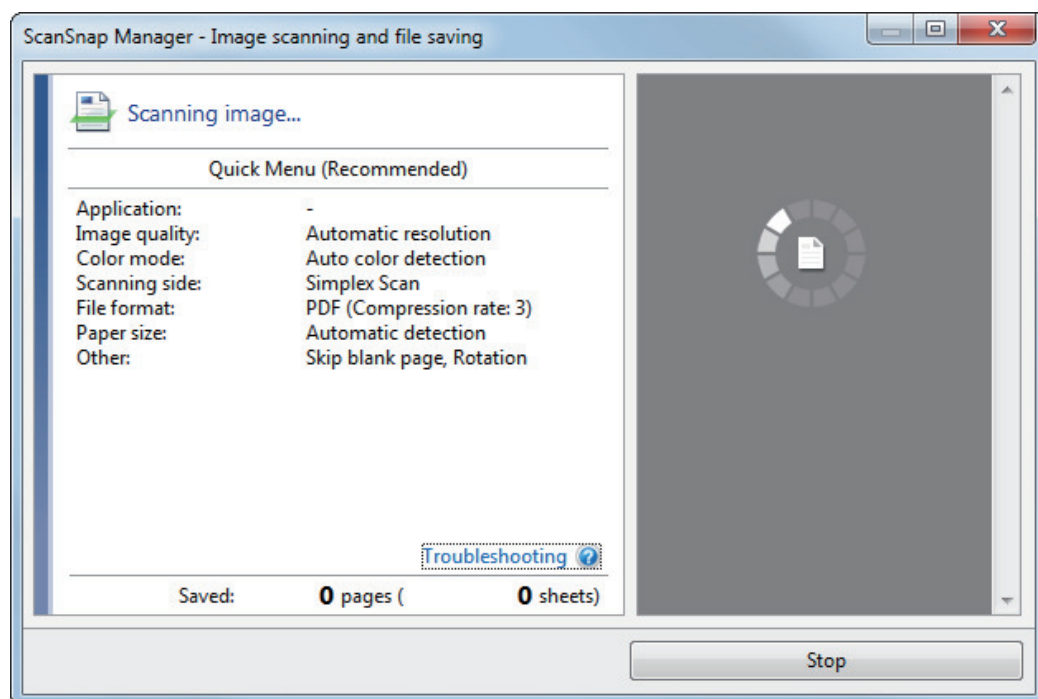

⇒ When scanning is complete, the [ScanSnap Manager - Image scanning and file saving] window displays a scanning standby status.

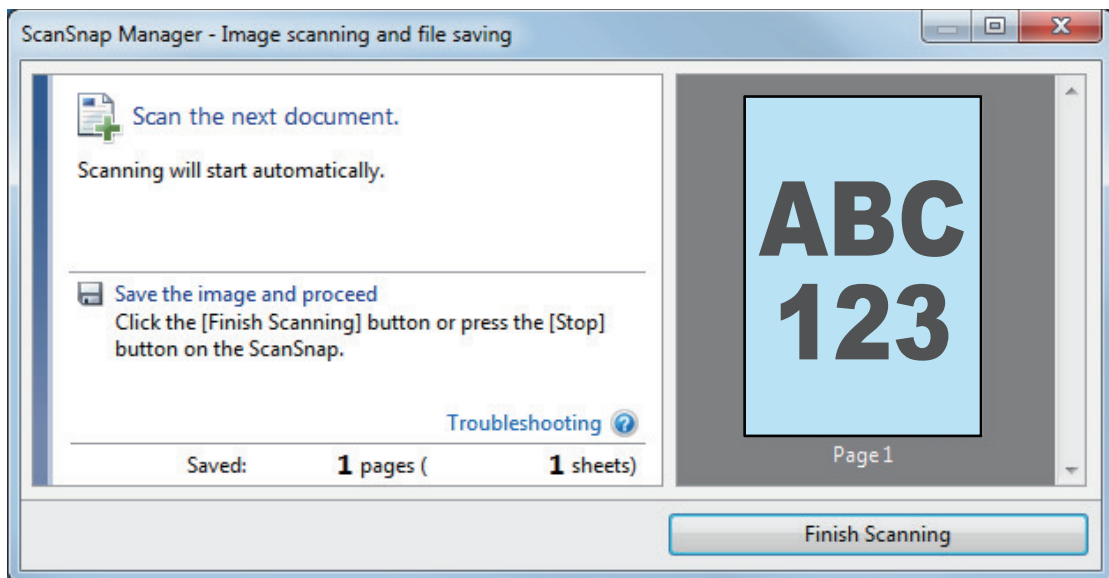

HINT

To continue scanning, insert the next document to be scanned. When the document is inserted, scanning starts automatically.

4. Press the [Scan/Stop] button on the ScanSnap to finish scanning.

⇒ The Quick Menu appears.

5. In the Quick Menu, click the icon of the application to link with ScanSnap Manager.

For details about linking the following applications with ScanSnap Manager, refer to "[Useful Usages](#)" (page 439).

- Save Documents
- Save Business Cards
- Save Receipts
- Save Photos

HINT

The following applications are displayed in the Quick Menu when ScanSnap Organizer and CardMinder are installed.

- When ScanSnap Organizer is installed
ScanSnap Organizer
- When CardMinder is installed
Scan to CardMinder

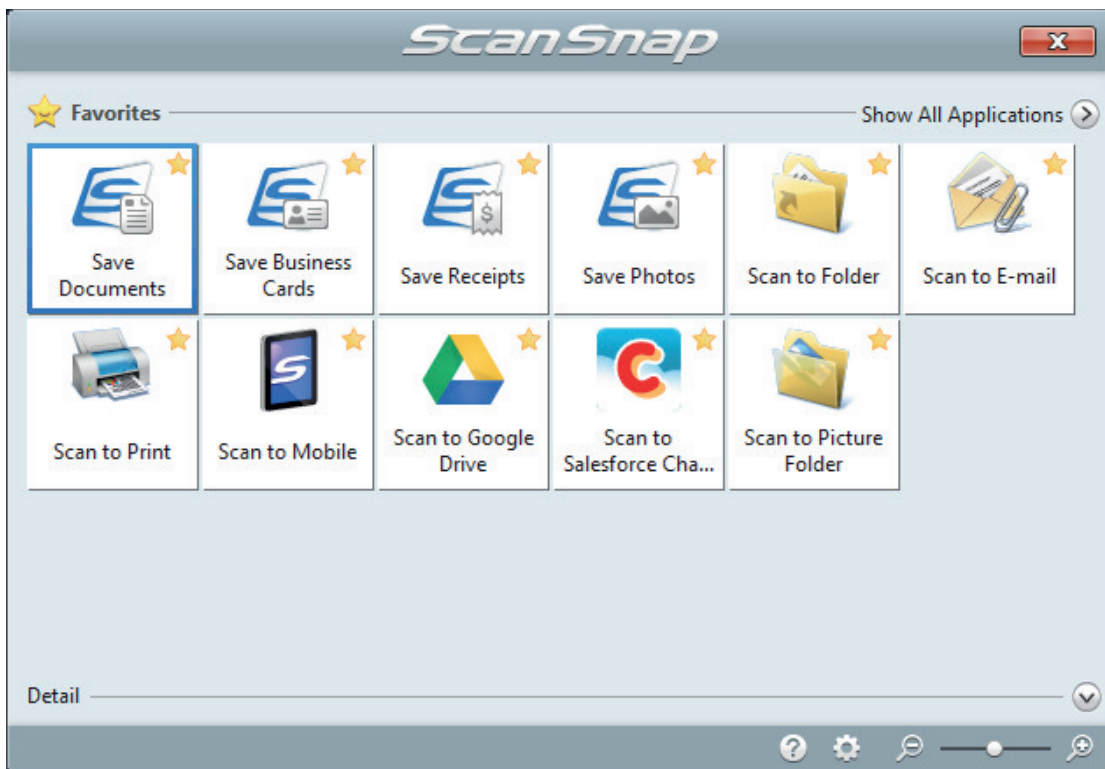

⇒ The selected application starts up. For details, refer to the Advanced Operation Guide.

ATTENTION

- You cannot start scanning when the Quick Menu is displayed. Either select an icon from the Quick Menu and finish the process, or close the Quick Menu before you perform the next scan.
- Do not move, delete, or rename scanned images using other applications while the Quick Menu is displayed.

HINT

- Clicking  displays the description of an application. Placing the mouse cursor over the icon of another application displays the description of the application.
- Performing a scan while an application that can be automatically linked with is active automatically starts the linkage between ScanSnap Manager and the application.
For details, refer to the Advanced Operation Guide.

Scanning Documents by Inserting Two Documents at a Time or by Inserting the Next Document While the Current Document Is Being Scanned (S1100i)

When scanning small size documents such as business cards and postcards with the ScanSnap, you can insert two documents at a time or you can insert the next document while the current document is being scanned. These scanning methods are referred to as dual scans.

Documents can be inserted in the following two methods:

- Inserting two documents at a time in the ScanSnap

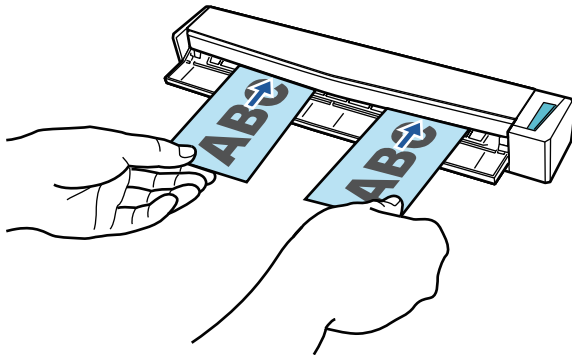

- Inserting the next document while the current document is being scanned

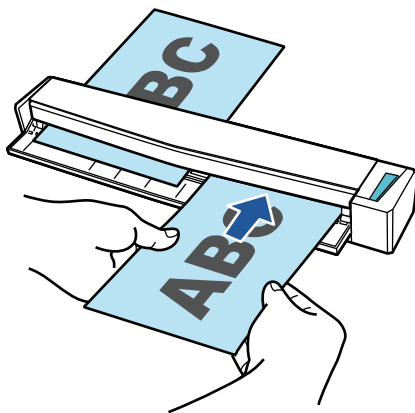

For details about documents that can be scanned, refer to ["Documents to Scan \(S1100i\)"](#) (page 391).

ATTENTION

- When you select an option other than [Automatic detection] for [Paper size] in the [Paper] tab of the ["ScanSnap Setup Window"](#) (page 102), the dual scan function is disabled.
- Use a dual scan to scan a document within the following ranges. If one of the following ranges is exceeded, a length error occurs and part of the document may not appear in the scanned image.
 - Maximum scanning length: 863 mm (34 in.) (355.6 mm (14 in.) when [Excellent] is specified for [Image Quality] in the [Scanning] tab of the ["ScanSnap Setup Window"](#) (page 102))
 - Maximum number of documents for scanning: 20 sheets
- When you continue scanning by inserting the next document while the current document is being scanned, the [Scan/Stop] button flashes more quickly if the scanning length exceeds 650 mm (26 in.). If this occurs, wait until scanning is complete without continuing to insert more documents. After scanning is complete, insert the next document. The next scan is started automatically.

1. Open the feed guide of the ScanSnap.

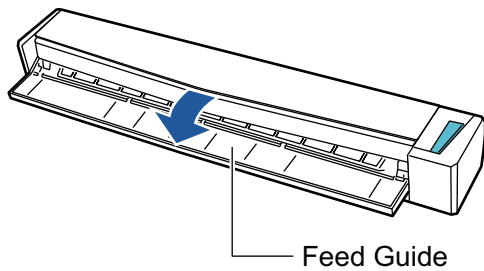

HINT

- If you want the document to be ejected from the front of the ScanSnap or when there is not enough space where the document exits the ScanSnap, open the output guide.

For details about documents that can be scanned with the output guide open, refer to "Documents to Scan (S1100i)" (page 391).

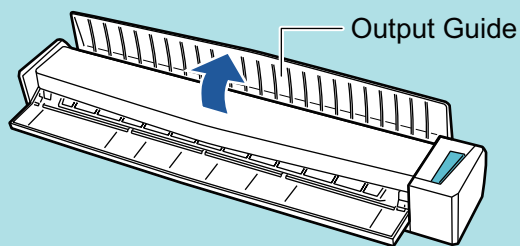

- How the document is ejected differs as below depending on whether the output guide is open or closed.

- When the output guide is closed



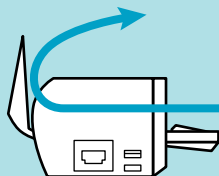

- When the output guide is open



⇒ The [Scan/Stop] button flashes in blue. The button returns to being lit normally when document scanning is enabled.

In addition, the ScanSnap Manager icon in the notification area located at the far right of

the taskbar changes from  to .

2. Insert the document straight into the feeding section of the ScanSnap, with the scanning side facing up.

Insert each document in the center of the left or right half of the feeding section.

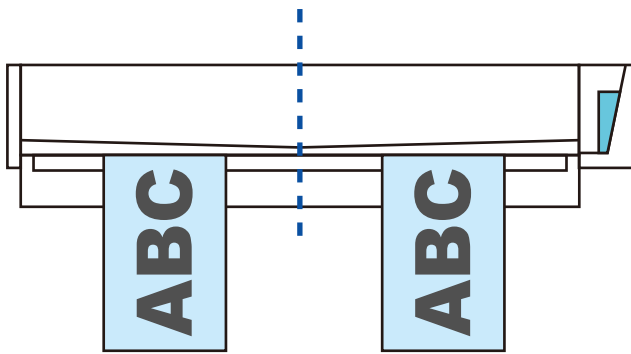
**ATTENTION**

When inserting the documents, insert them at least 10 mm (0.39 in.) apart from each other. If the space between the documents is less than 10 mm (0.39 in.), the scanned images may not be cropped correctly.

⇒ The document is pulled in until it is set inside the ScanSnap.

ATTENTION

- When you perform scanning with the output guide closed, leave enough space at the back of the ScanSnap to allow the document to be completely ejected. In addition, when you scan long page documents, hold the scanned documents with your hands to prevent them from falling off the unit where the ScanSnap is placed on.

Make sure that the area where the document exits the scanner is clear of any obstacles. Otherwise, paper jam may occur.

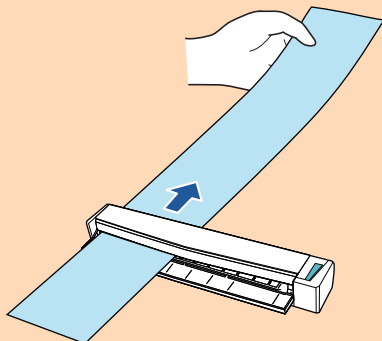

- If you scan the following documents with the output guide open, a paper jam may occur and damage the documents. Scan the following documents with the output guide closed.

- Thick paper (80 g/m² [20 lb] or heavier)
- Postcards
- Business cards

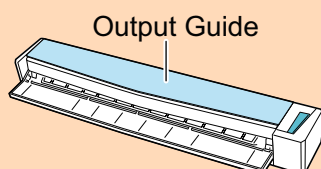

3. Press the [Scan/Stop] button on the ScanSnap to start scanning.

ATTENTION

Do not perform the following operations during scanning. Doing so will stop scanning.

- Connect or disconnect the ScanSnap and other USB devices.

- Close the feed guide.
- Switch users.
- Allow the computer to enter sleep mode.

⇒ The [Scan/Stop] button on the ScanSnap flashes in blue while the documents are being scanned.

The [ScanSnap Manager - Image scanning and file saving] window appears.

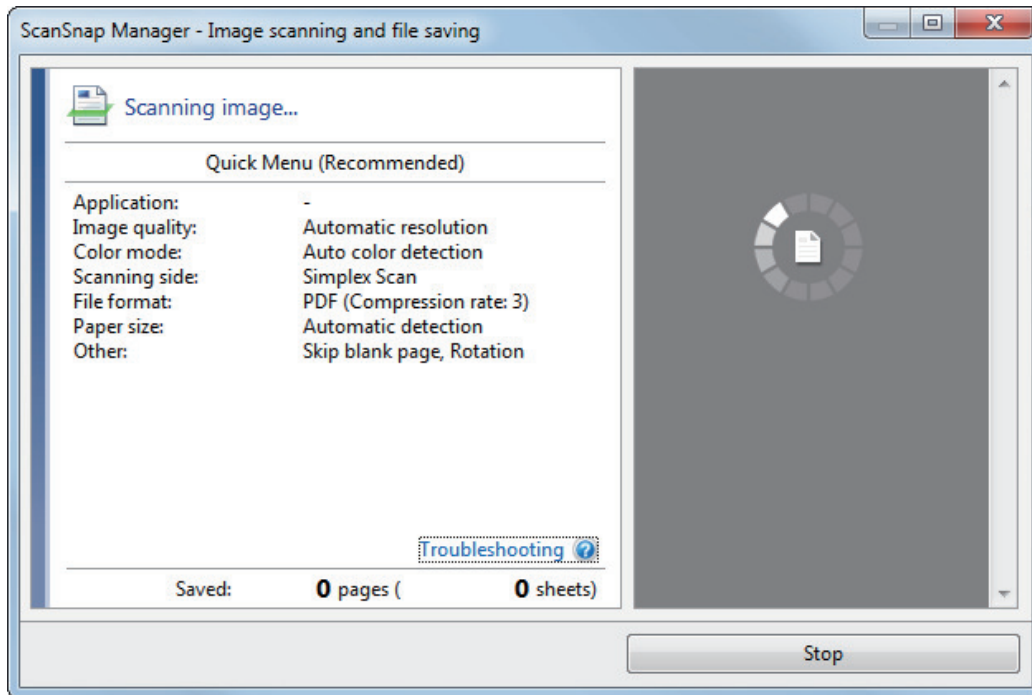

HINT

When the [ScanSnap Manager - Image scanning and file saving] window is maximized, multiple scanned images are displayed in the preview area. When you use a dual scan, it is recommended that you maximize the [ScanSnap Manager - Image scanning and file saving] window to check that scanned images are created correctly while scanning documents.

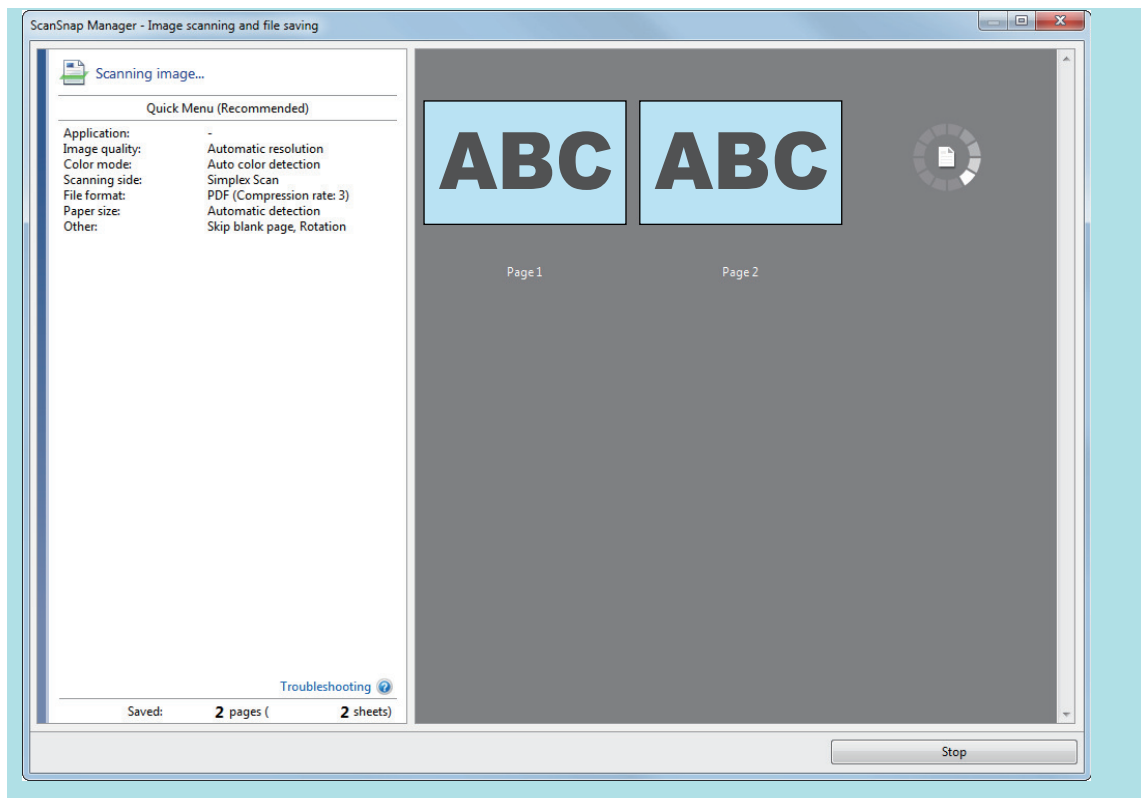

⇒ When scanning is complete, the [ScanSnap Manager - Image scanning and file saving] window displays a scanning standby status.

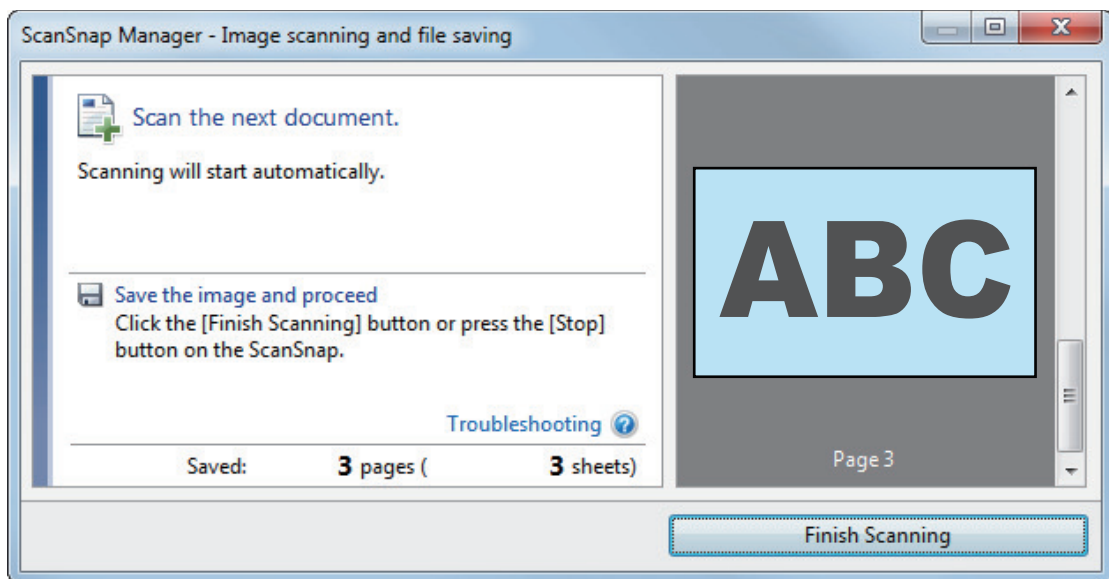

HINT

To continue scanning, insert the next document to be scanned. When the document is inserted, scanning starts automatically.

4. Press the [Scan/Stop] button on the ScanSnap to finish scanning.

⇒ The Quick Menu appears.

5. In the Quick Menu, click the icon of the application to link with ScanSnap Manager.

For details about linking the following applications with ScanSnap Manager, refer to "[Useful Usages](#)" (page 439).

- Save Documents
- Save Business Cards
- Save Receipts
- Save Photos

HINT

The following applications are displayed in the Quick Menu when ScanSnap Organizer and CardMinder are installed.

- When ScanSnap Organizer is installed
ScanSnap Organizer
- When CardMinder is installed
Scan to CardMinder



⇒ The selected application starts up. For details, refer to the Advanced Operation Guide.

ATTENTION

- You cannot start scanning when the Quick Menu is displayed. Either select an icon from the Quick Menu and finish the process, or close the Quick Menu before you perform the next scan.
- Do not move, delete, or rename scanned images using other applications while the Quick Menu is displayed.

HINT

- Clicking  displays the description of an application. Placing the mouse cursor over the icon of another application displays the description of the application.
- Performing a scan while an application that can be automatically linked with is active automatically starts the linkage between ScanSnap Manager and the application.

For details, refer to the Advanced Operation Guide.

Scanning Documents Larger Than A4 or Letter Size by Directly Inserting It in the ScanSnap (S1100i)

By folding an A3, B4, or Double Letter size document in half and scanning each side continuously, the scanned images of both sides are automatically merged and saved as a single image.

For details about documents that can be scanned, refer to "[Documents to Scan \(S1100i\)](#)" (page 391).

ATTENTION

- Scanned images are automatically merged only when there is text, diagram, or a table on the fold line of the folded document.
 - When scanned images are automatically merged

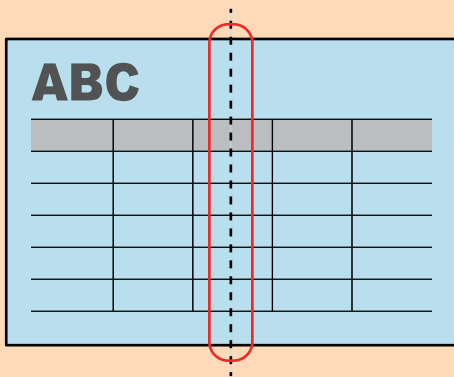

- When scanned images are not automatically merged

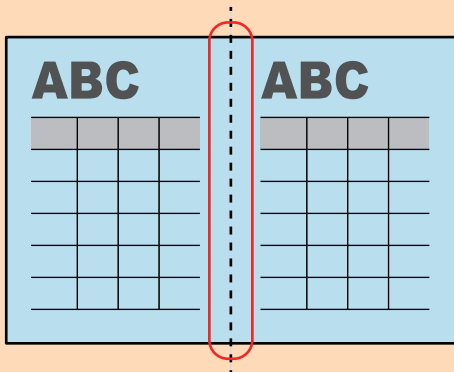

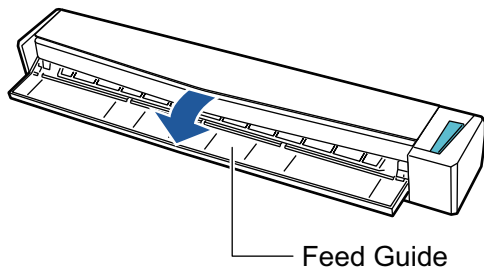

- After a document is scanned, if the scanned images are not merged automatically, you can use the ScanSnap Organizer Merge Pages function to merge the scanned images.
For details, refer to the ScanSnap Organizer Help.
- For a document that will have scanned images which are not merged automatically, you can use the optional Carrier Sheet to scan the document and merge the scanned images automatically.
For details, refer to "[Scanning Documents Larger than A4 or Letter Size with the Carrier Sheet \(S1100i\)](#)" (page 411).
- If scanned images are unexpectedly merged, clear the [Merge both side images] checkbox on the [Scanning mode option] window, and then scan the document again.
To open the [Scanning mode option] window, click the [Option] button in the [Scanning] tab of the "[ScanSnap Setup Window](#)" (page 102).

1. Open the feed guide of the ScanSnap.



⇒ The [Scan/Stop] button flashes in blue. The button returns to being lit normally when document scanning is enabled.

In addition, the ScanSnap Manager icon in the notification area located at the far right of

the taskbar changes from  to .

2. Fold the document in half so that the sides to be scanned are facing out.

ATTENTION

Fold the long side of the document in half. If the left and right areas of the folded document are different in size from each other, the scanned images may not be merged automatically.

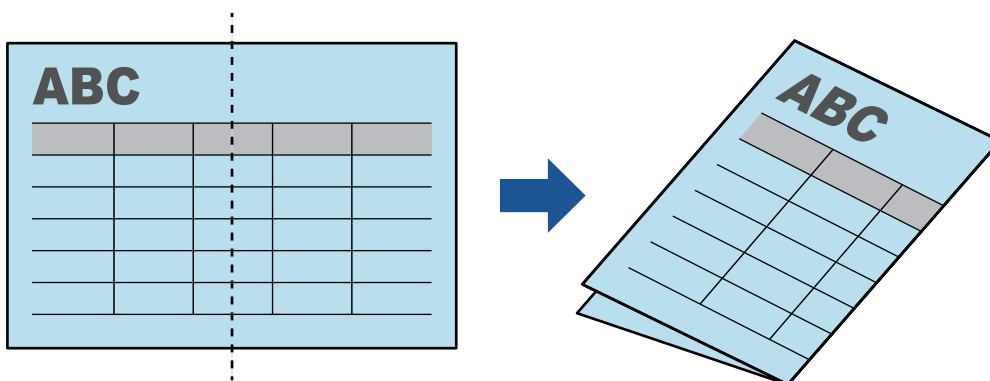

3. Insert the document straight into the feeding section of the ScanSnap, with the scanning side facing up.

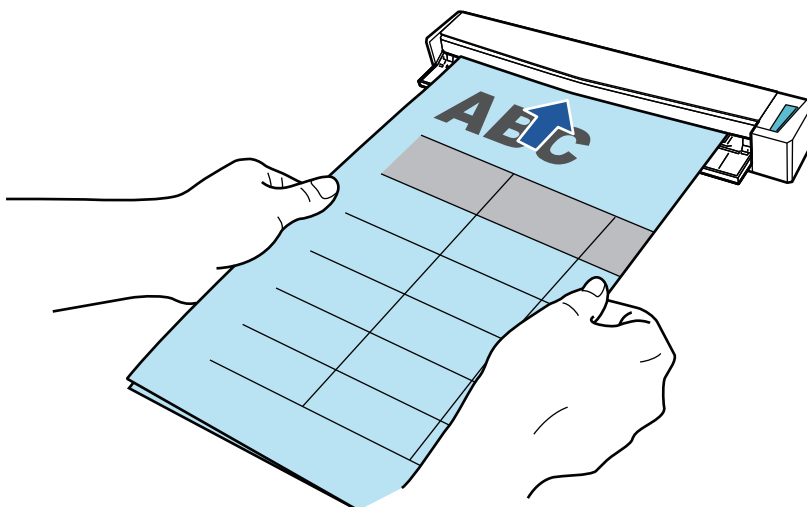

⇒ The document is pulled in until it is set inside the ScanSnap.

HINT

If you scan a document folded in half with the output guide open, a paper jam may occur. Make sure to close the output guide when you scan a document folded in half.

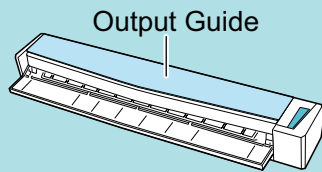

4. Press the [Scan/Stop] button on the ScanSnap to start scanning.

- ⇒ The [Scan/Stop] button on the ScanSnap flashes in blue and the [ScanSnap Manager - Image scanning and file saving] window appears while the document is being scanned. When scanning is complete, the scanned image of the scanning side is displayed in the preview area.

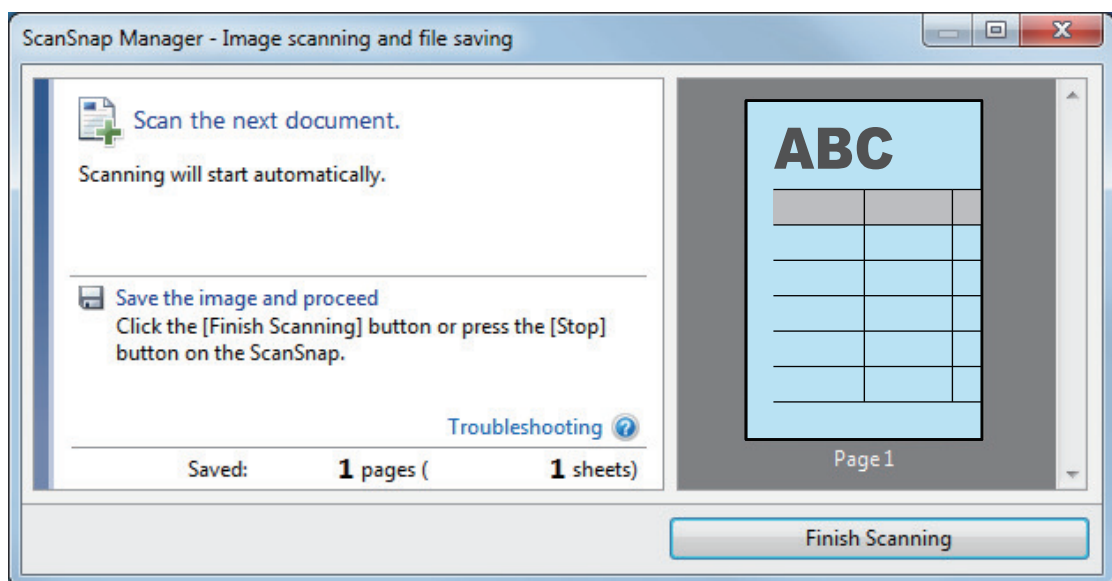

5. Turn over the document and insert it as described in step 3.

ATTENTION

Make sure to scan the front and back sides of the document folded in half consecutively.

- ⇒ Scanning starts automatically.

HINT

Repeat steps 2 to 5 to continue scanning more A3, B4, or Double Letter size documents. You can also continue scanning documents smaller than A4 or Letter size.

For details about how to perform a scan, refer to "[Scanning Documents \(S1100i\)](#)" (page 395).

6. Press the [Scan/Stop] button on the ScanSnap to finish scanning.

- ⇒ The Quick Menu appears.

7. In the Quick Menu, click the icon of the application to link with ScanSnap Manager.

When you select [Save Documents], you can manage scanned images by folder with ScanSnap Home.

For details, refer to "Managing Paper Documents by Folder on a Computer with ScanSnap Home" (page 440).

HINT

[ScanSnap Organizer] is displayed in the Quick Menu when ScanSnap Organizer is installed.

To manage scanned images by folder with ScanSnap Organizer, refer to "Managing Paper Documents by Folder on a Computer with ScanSnap Organizer" (page 443).



⇒ The selected application starts up. For details, refer to the Advanced Operation Guide.

ATTENTION

- You cannot start scanning when the Quick Menu is displayed. Either select an icon from the Quick Menu and finish the process, or close the Quick Menu before you perform the next scan.
- Do not move, delete, or rename scanned images using other applications while the Quick Menu is displayed.

HINT

- Clicking  displays the description of an application. Placing the mouse cursor over the icon of another application displays the description of the application.
- Performing a scan while an application that can be automatically linked with is active automatically starts the linkage between ScanSnap Manager and the application.
For details, refer to the Advanced Operation Guide.

Scanning Documents Larger than A4 or Letter Size with the Carrier Sheet (S1100i)

Documents larger than A4/Letter size (such as A3, 11 × 17 in. and B4) can be scanned with the optional Carrier Sheet. By folding the document in half and scanning both sides, one at a time, the two sides are merged into a single image.

For details about documents that can be loaded, refer to "[Documents to Scan \(S1100i\)](#)" (page 391).

ATTENTION

The [Deskew by text on document] checkbox in the [Scanning mode option] window will be disabled. To open the [Scanning mode option] window, click the [Option] button in the [Scanning] tab of the "[ScanSnap Setup Window](#)" (page 102).

HINT

Both sides of a double-sided A4/Letter size document or smaller can also be scanned and merged into a single image.

1. Right-click the ScanSnap Manager icon  in the notification area located at the far right of the taskbar, and select the [Scan Button Settings] from the "[Right-Click Menu](#)" (page 100).
⇒ The ScanSnap setup window appears.
2. In the [Paper] tab, select [Automatic detection] in [Paper size], and then click the [Carrier Sheet Settings] button.

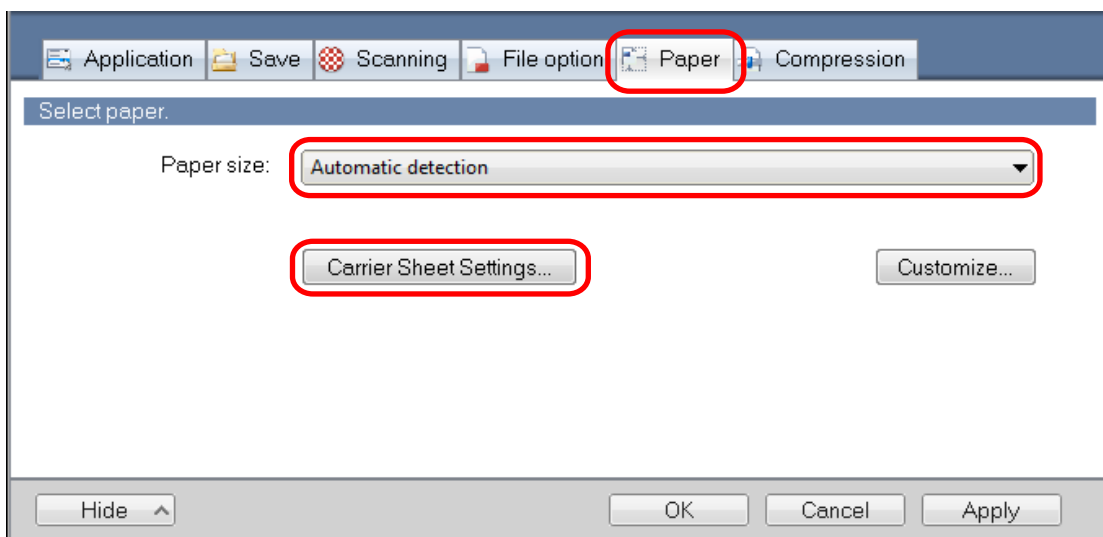

⇒ The [Carrier Sheet Settings] window appears.

3. Select [one double-page spread image] in [Save as] and click the [OK] button.

For details, refer to the ScanSnap Manager Help.

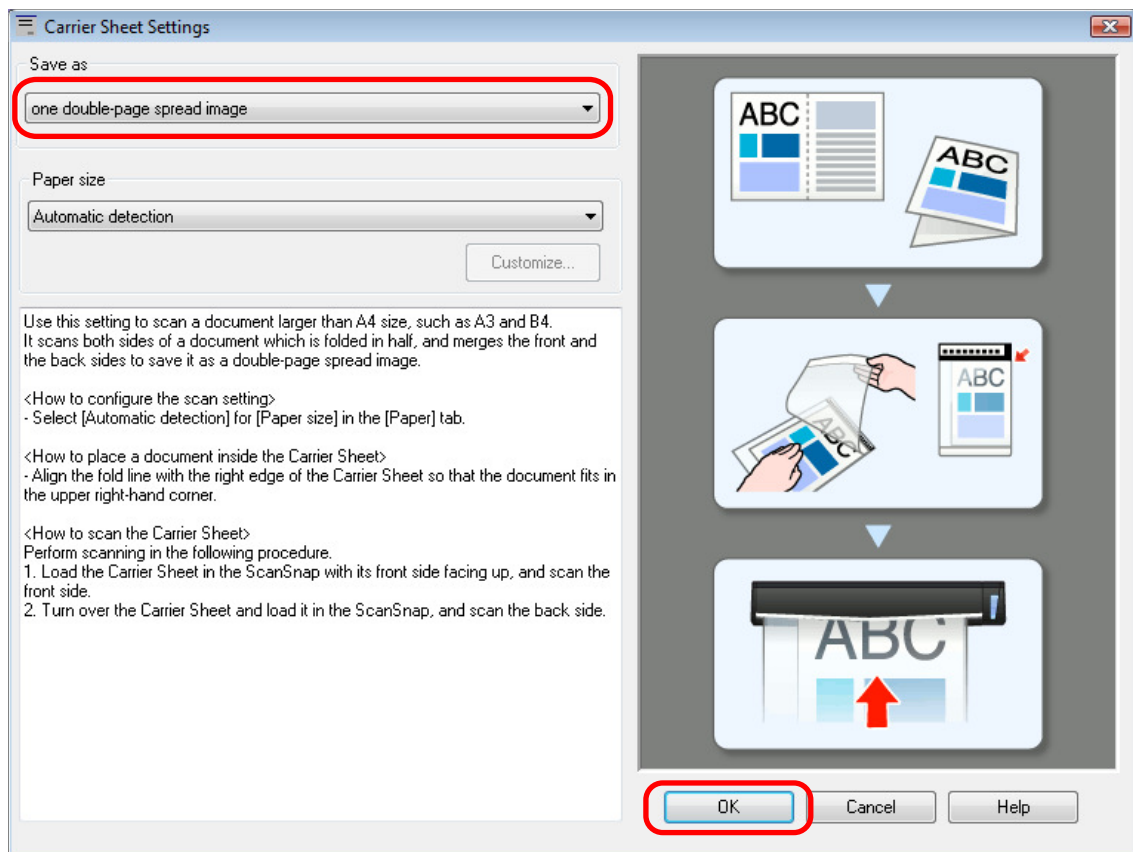

4. Click the [OK] button to close the ScanSnap setup window.

5. Place the document inside the Carrier Sheet.

1. Fold the document in half with the sides to be scanned facing out.
Fold it tightly and smooth out any creases.

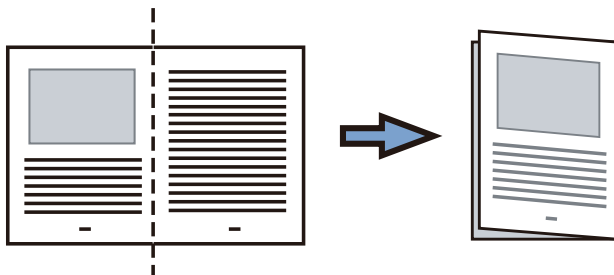

2. Open the Carrier Sheet to bind the document.

Align the fold line with the right edge of the Carrier Sheet so that the document fits in the upper right-hand corner of the Carrier Sheet.

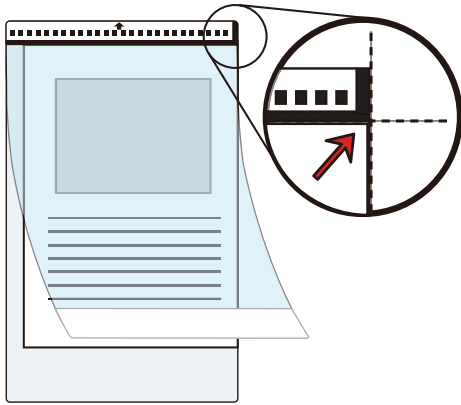
**HINT**

Note that the front side of the Carrier Sheet has a black and white pattern at the top and a thick vertical line in the upper right-hand corner.

- 6. Insert the part with the black and white pattern straight into the feeding section of the ScanSnap, with the front side of the Carrier Sheet facing up.**

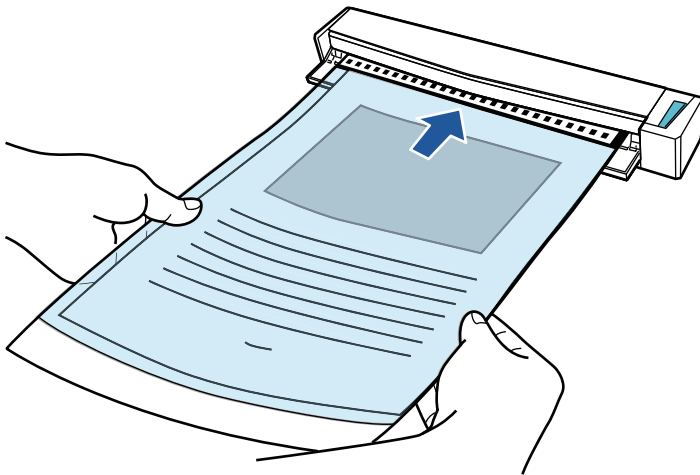

⇒ The Carrier Sheet is pulled in until it is set inside the ScanSnap.

HINT

If you perform a scan using the Carrier Sheet with the output guide open, a paper jam may occur and damage the documents. Make sure to close the output guide when you perform a scan using the Carrier Sheet.

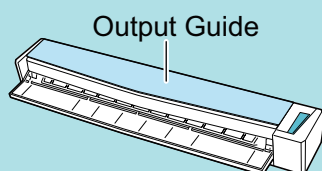

- 7. Press the [Scan/Stop] button on the ScanSnap to start scanning.**

⇒ Scanning starts and the [ScanSnap Manager - Image scanning and file saving] window appears. When the front side of the Carrier Sheet is scanned, the scanned image is displayed in the preview area.

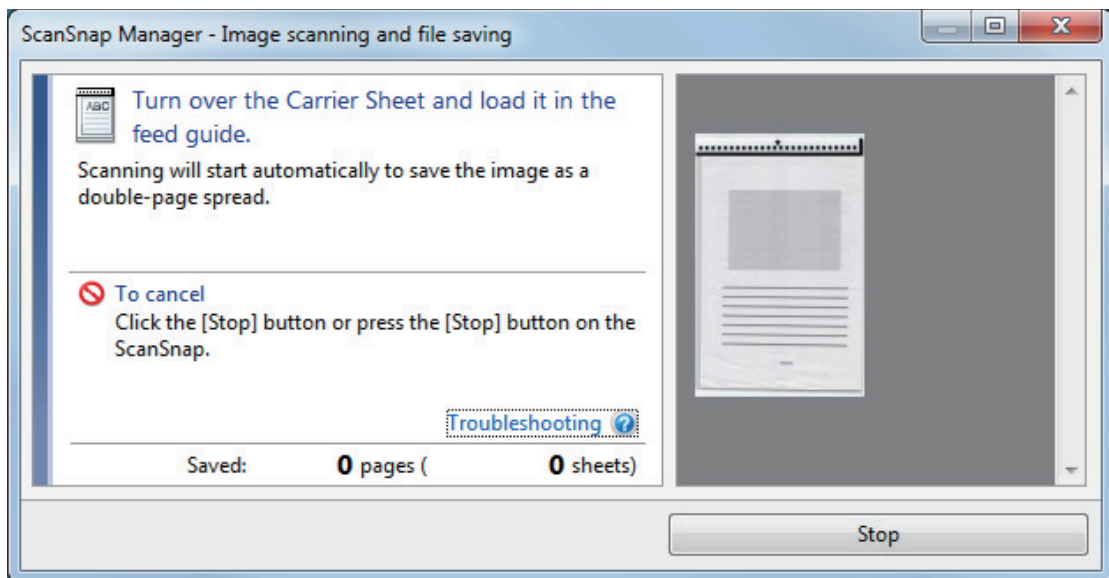

8. Turn over the Carrier Sheet and insert it as described in step 6.

ATTENTION

Make sure to scan the front and back side of the Carrier Sheet consecutively.

- ⇒ Scanning starts automatically and the [ScanSnap Manager - Image scanning and file saving] window appears. When scanning is completed, scanned images of the front and back side of the document inside the Carrier Sheet are displayed as a double-page spread image in the preview area.

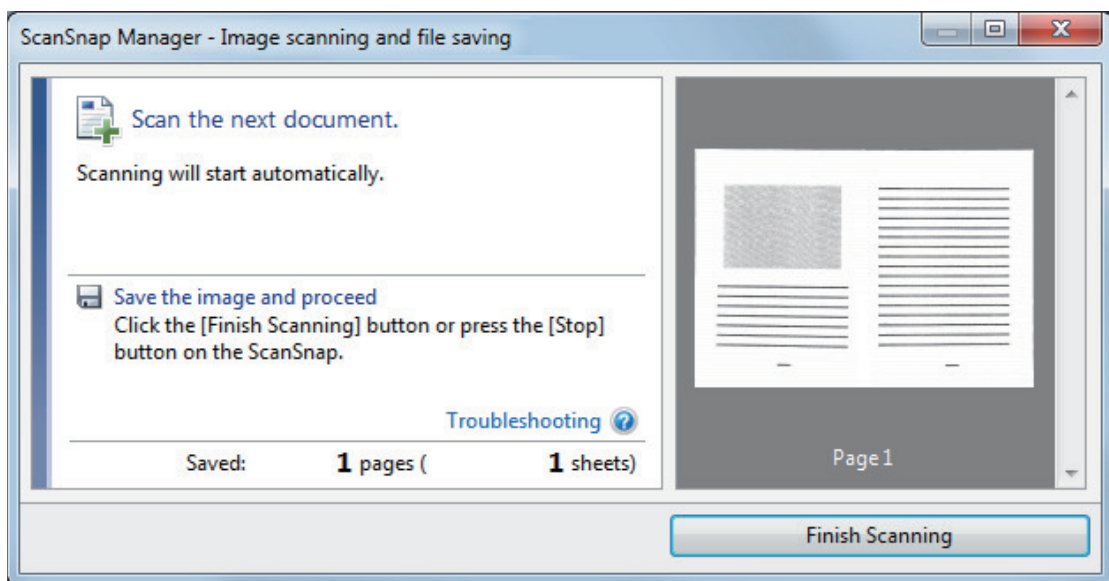

HINT

Repeat steps 5 to 8 to scan more documents larger than A4/Letter size. You can continue to scan documents that can be inserted directly in the ScanSnap.

For details about how to perform a scan, refer to "Scanning Documents (S1100i)" (page 395).

9. Press the [Scan/Stop] button on the ScanSnap to finish scanning.

- ⇒ The scanned images of the front and back sides of the document are saved as a double-page spread image.

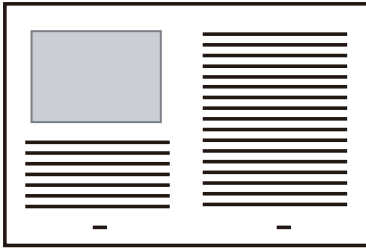

ATTENTION

- There may be a line or a gap appearing between the front and back side images. Also when you scan a thick document in the Carrier Sheet, the scanned image on the left and the scanned image on the right of a double-page spread image may skew towards each other from the top.

These symptoms may be improved when you place the document in the Carrier Sheet as follows:

- Fold the document properly
- Neatly align the edges of the document with the edges of the Carrier Sheet
- Turn over the Carrier Sheet to the other (reverse) side
- If [Automatic detection] is specified for [Paper size] in the [Carrier Sheet Settings] window, an optimal size will be selected automatically from the available standard sizes (A3, B4, or 11 × 17 in.) in [Paper size]. Note that the size of the image may become smaller than the original document depending on the document.

Example: When characters and illustrations are printed to fit in A4 size in the center of an A3 size document, the scanned image is output in B4 size.

To output the scanned image in its original size, specify the document size in [Paper size].

- Part of the scanned image around where the document is folded may appear missing. In that case, place the document so that its edge is about 1 mm (0.04 in.) inside from the edge of the Carrier Sheet.

Scanning Documents Such as Photographs and Clippings (S1100i)

Using the optional Carrier Sheet allows you to scan documents that can be damaged quite easily such as photographs, or non-standard size documents that are difficult to load directly such as clippings.

For details about documents that can be loaded, refer to ["Documents to Scan \(S1100i\)" \(page 391\)](#).

ATTENTION

The [Deskew by text on document] checkbox in the [Scanning mode option] window will be disabled. To open the [Scanning mode option] window, click the [Option] button in the [Scanning] tab of the ["ScanSnap Setup Window" \(page 102\)](#).

1. Right-click the ScanSnap Manager icon  in the notification area located at the far right of the taskbar, and select the [Scan Button Settings] from the ["Right-Click Menu" \(page 100\)](#).
⇒ The ScanSnap setup window appears.
2. In the [Paper] tab, select [Automatic detection] in [Paper size], and then click the [Carrier Sheet Settings] button.

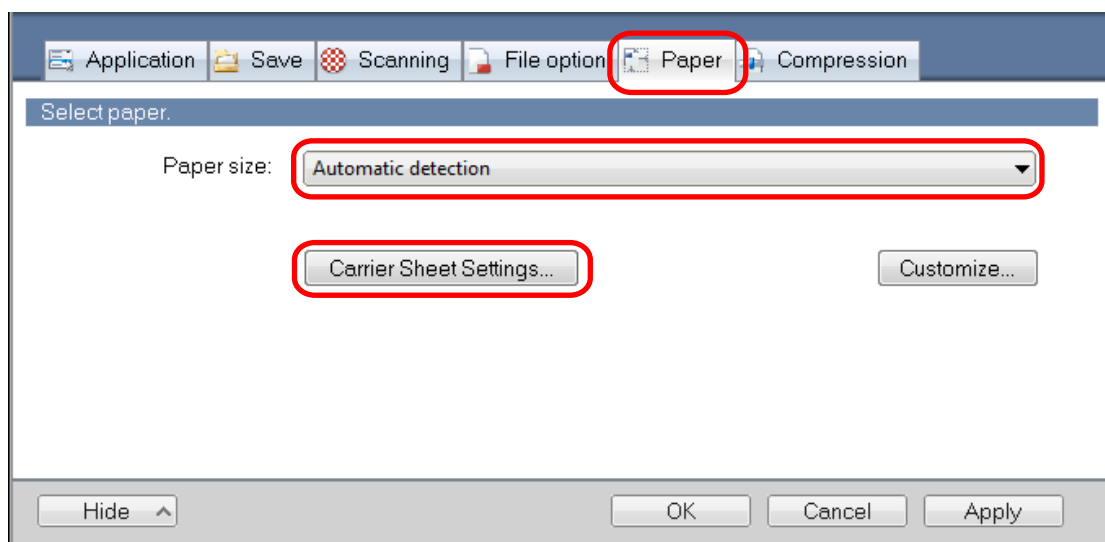

⇒ The [Carrier Sheet Settings] window appears.

3. Select [two separate images (front and back)] in [Save as] and click the [OK] button.

For details, refer to the ScanSnap Manager Help.

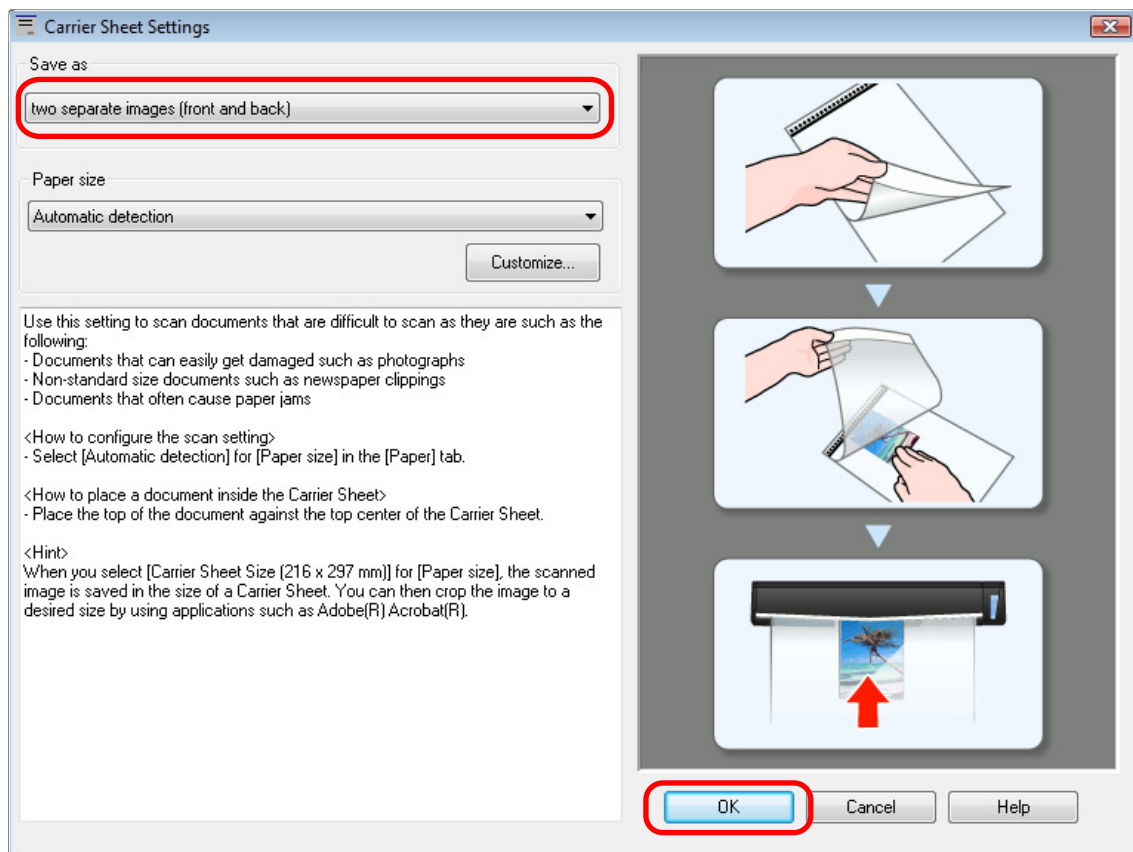

4. Click the [OK] button to close the ScanSnap setup window.

5. Place the document inside the Carrier Sheet.

Open the Carrier Sheet and place the top of the document against the top center of the Carrier Sheet.

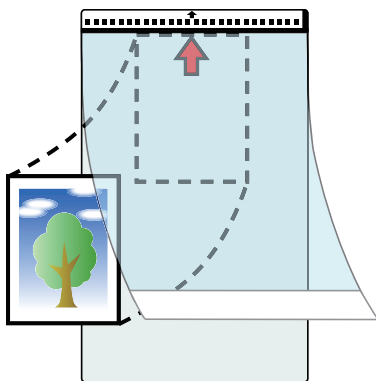

6. Insert the part with the black and white pattern straight into the feeding section of the ScanSnap, with the scanning side of the document inside the Carrier Sheet facing up.

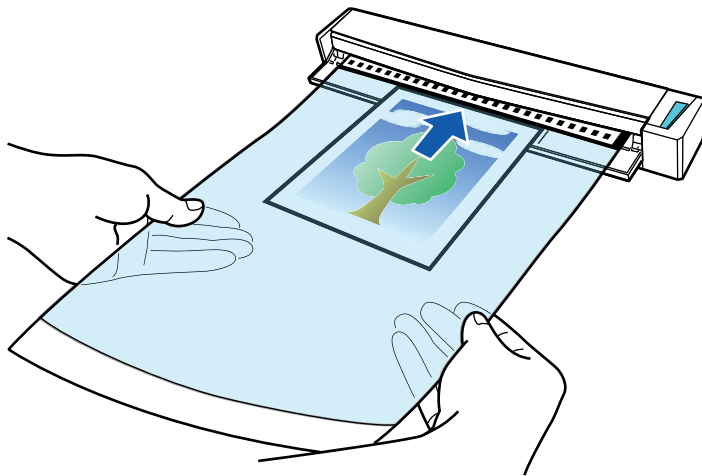

⇒ The Carrier Sheet is pulled in until it is set inside the ScanSnap.

ATTENTION

If you perform a scan using the Carrier Sheet with the output guide open, a paper jam may occur and damage the documents. Make sure to close the output guide when you perform a scan using the Carrier Sheet.

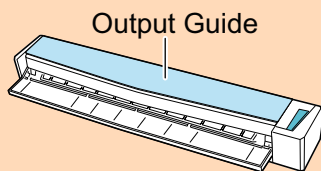

7. Press the [Scan/Stop] button on the ScanSnap to start scanning.

⇒ When scanning is complete, the scanned image of the document that is inside the Carrier Sheet is displayed in the preview area.

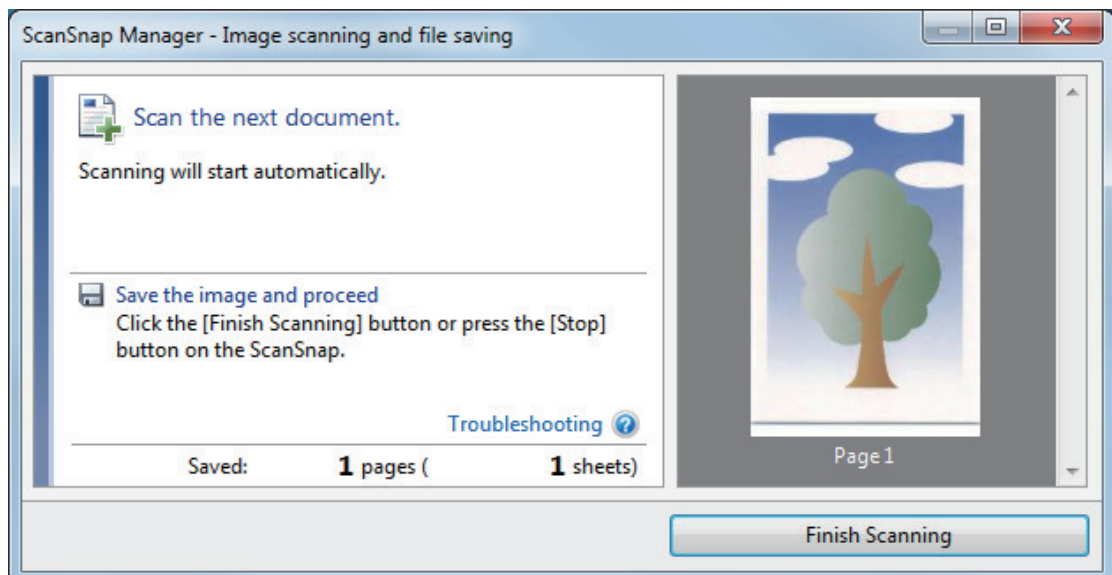

HINT

Repeat steps 5 to 7 to scan more documents such as photographs and clippings. You can continue to scan documents that can be inserted directly in the ScanSnap. For details about how to perform a scan, refer to "[Scanning Documents \(S1100i\)](#)" (page 395).

8. Press the [Scan/Stop] button on the ScanSnap to finish scanning.

⇒ The scanned image is saved.

ATTENTION

- The scanned image is output at the center of the page in the size specified for [Paper size] in the [Carrier Sheet Settings] window.
- If [Automatic detection] is specified for [Paper size] in the [Carrier Sheet Settings] window, an optimal size will be selected automatically from the available standard sizes in [Paper size]. Note that the size of the image may become smaller than the original document depending on the document scanned, or part of the image may appear missing.

Example: When the contents are printed to fit in A5 size in the center of an A4 size document, the scanned image is output in A5 size.

To output the scanned image in its original size, specify the document size in [Paper size].

HINT

In the following cases, place a blank (white) sheet of paper underneath the document when scanning:

- The scanned image is not saved in the correct size (when [Automatic detection] is selected for [Paper size] in the [Carrier Sheet Settings] window)
- Shadows appear around the edges of the scanned image
- Black lines appear around the edges of a uniquely shaped cutting

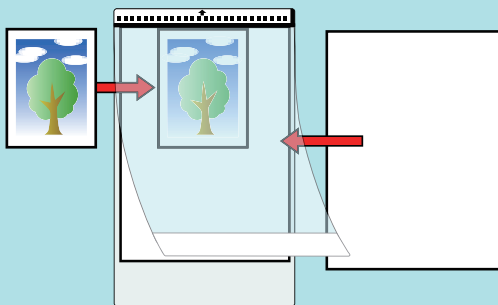

What You Can Do with Related Software

This section explains the basic operation procedure of software related to the ScanSnap and gives an overview of its functions.

- ["What You Can Do with ScanSnap Home" \(page 421\)](#)
- ["What You Can Do with the ScanSnap Organizer" \(page 423\)](#)
- ["What You Can Do with CardMinder" \(page 430\)](#)

What You Can Do with ScanSnap Home

ScanSnap Home is a desktop application used for managing images created from documents that you scanned with the ScanSnap and for managing the meta information of those images (such as the date and time you scanned the documents and the result of the text recognition for the character string of a document) for all document types ("Documents", "Business Cards", "Receipts" or "Photos").



What you can do with ScanSnap Home are as follows:

For details about operations, refer to the [ScanSnap Home Help](#).

HINT

A scanned image together with meta information is referred to as a content data record in ScanSnap Home.

Managing files in a local folder or a network folder comprehensively

You can comprehensively manage the files in the local folders or the network folders as well as the images created from the documents that you scanned with the ScanSnap.

Editing scanned images by using ScanSnap Home viewer

You can perform a variety of editing operations (such as rearranging, adding, or rotating a page) on an image created from a document that you scanned by using ScanSnap Home viewer.

Categorizing content data records by adding tags

You can display the content data records for each record that is tagged or search for content data records by tags after tags are added to content data records in ScanSnap Home.

Scan recipes with the ScanSnap and tag them by ingredients such as "Meat" and "Fish" or by cooking methods such as "Boil", "Grill", and "Steam" so that you can search for a recipe with ease.

Performing a particular action on content data records by using other applications linked with ScanSnap Home

If you add an application to ScanSnap Home, you can perform a particular action on the scanned images or business card data by selecting the added application from ScanSnap Home.

For example, if you add client applications for Dropbox, Evernote, or other cloud services in ScanSnap Home, you can send images to those cloud services.

Also, adding a business card management application to ScanSnap Home allows you to import contact information on a business card (in a format such as CSV) to the added application and use it with the application.

What You Can Do with the ScanSnap Organizer

ScanSnap Organizer is an application used for displaying, organizing, and managing image data (PDF or JPEG files) scanned with the ScanSnap.

You can use this application to display image data (PDF or JPEG files) without opening them, create folders and arrange files for various uses.

Pages of a PDF file can also be flipped through in thumbnails to verify the scanned image data.

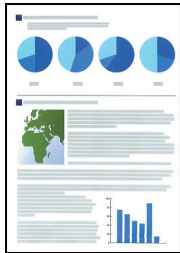

Scan documents with the ScanSnap

Main Window

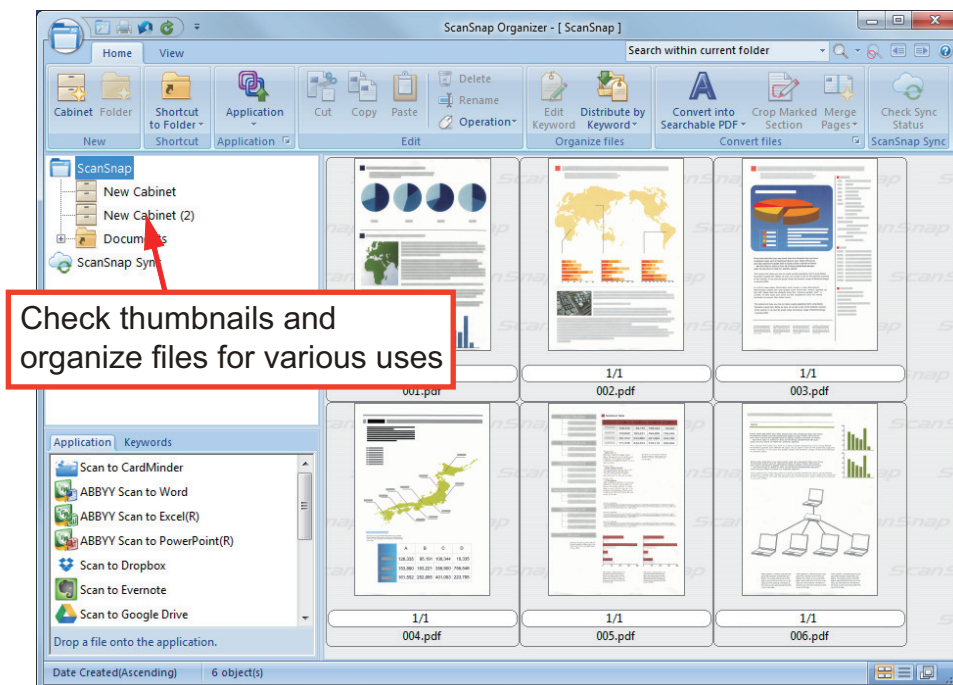

- "Basic Operation Procedure of ScanSnap Organizer" (page 424)
- "Managing Files" (page 426)
- "Editing Files" (page 428)
- "Using Files" (page 429)

Basic Operation Procedure of ScanSnap Organizer

This section explains the basic operation procedure of ScanSnap Organizer.

1. Start up ScanSnap Organizer.

Start up ScanSnap Organizer by double-clicking the [ScanSnap Organizer] icon on the desktop.

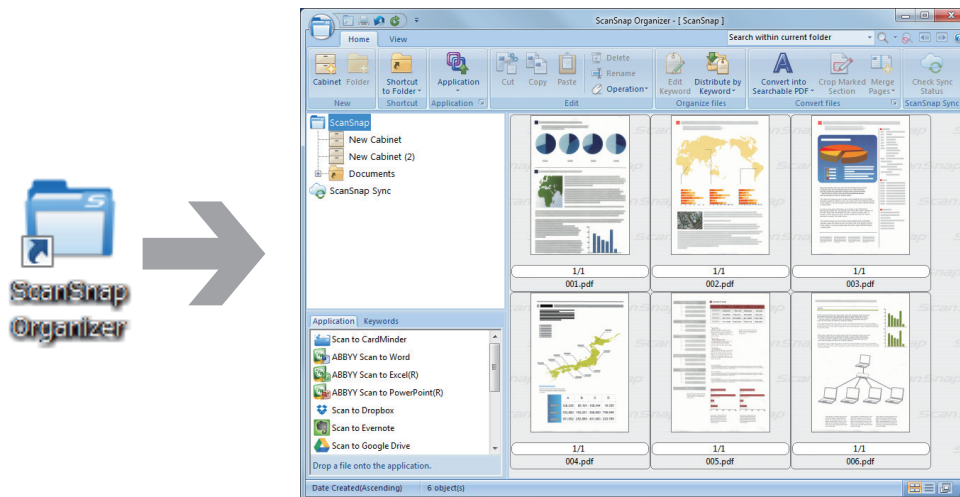

2. Scan documents with the ScanSnap.

⇒ A list of scanned images is displayed in ScanSnap Organizer.

3. Start up ScanSnap Organizer Viewer.

Double-click a scanned image to start up the Viewer Window for displaying and editing scanned images.

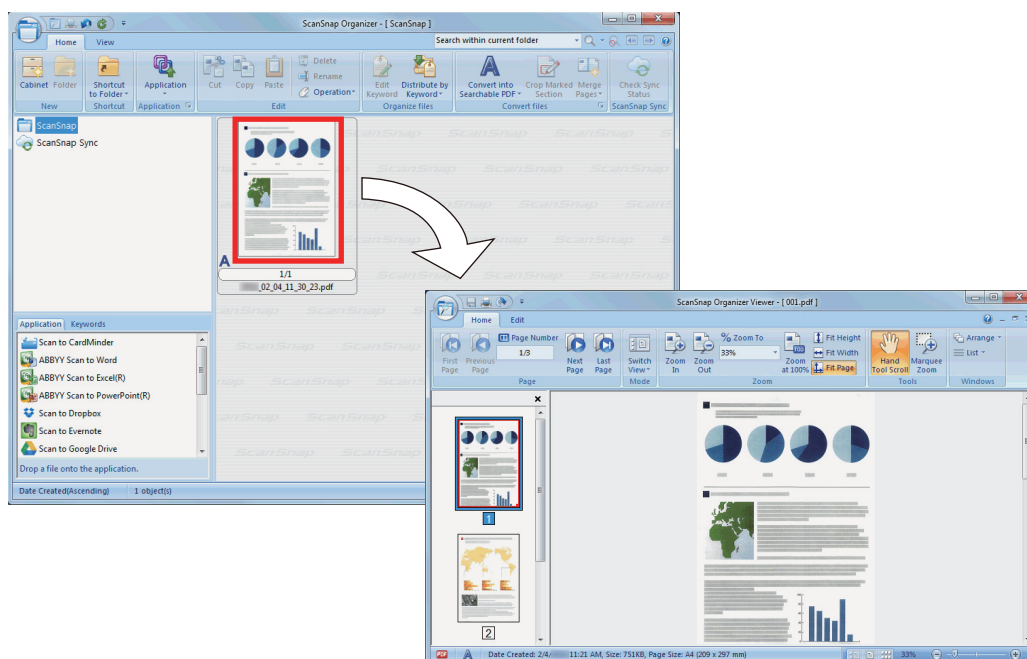

4. In the Viewer Window, check the orientation of scanned images, and check for unnecessary pages.

Rotate any scanned images that are not oriented correctly. Delete any unnecessary pages. Make other edits such as inserting a page where necessary.

5. Exit ScanSnap Organizer Viewer.

To exit ScanSnap Organizer Viewer, click the Application button and then click the [Exit] button in the menu that appears.

Managing Files

For details about operations, refer to the ScanSnap Organizer Help.

Setting Keywords for a File

You can set a character string (keyword) indicating the content of a PDF file so that you can immediately recognize the file without opening it.

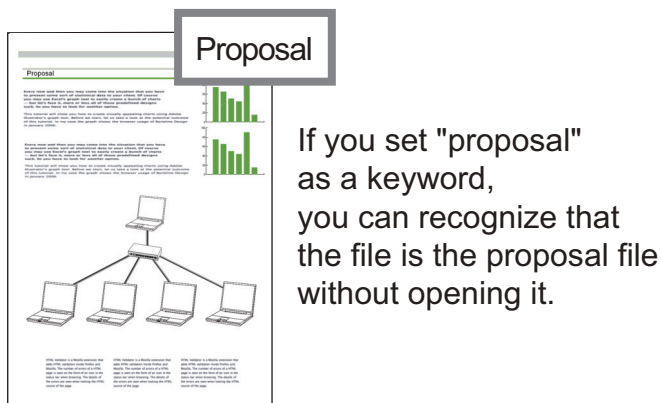

Setting a Marked Character String as a Keyword

Keywords can be set to a PDF file by using the keyword setting function.

These keywords can be used when you search for PDF files.

When black and white documents that have been marked are scanned by the ScanSnap, the marked character strings are set as keywords for the PDF file.

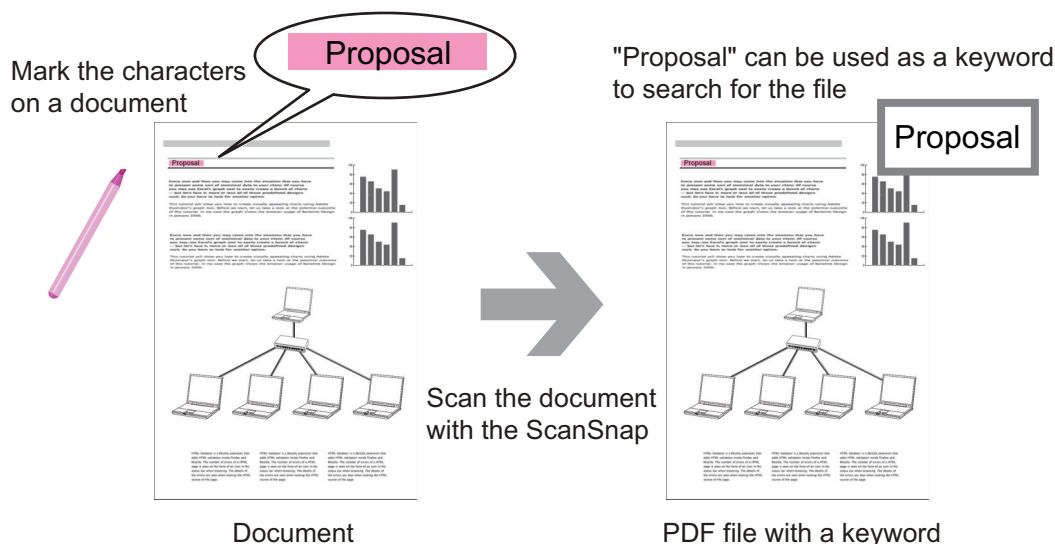

For other keyword setting methods, refer to ScanSnap Organizer Help.

Recognizing a Character String in a Page to Embed It into the Page

By using text recognition (OCR) software, you can embed character strings into the page of a PDF file scanned by the ScanSnap, and then search the PDF file using the character strings.

OCR recognizes "proposal" as textual information.

Proposal

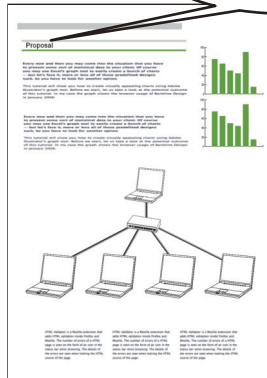

PDF file

"Proposal" can be used as a keyword to search for the file

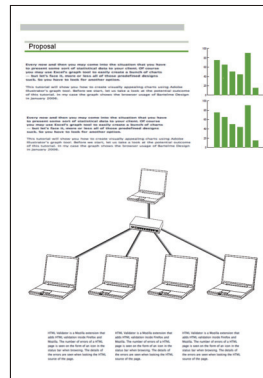

Searching Files

You can search files that are managed in ScanSnap Organizer.

There are two search methods of Adobe Acrobat search and Windows Desktop Search.

Automatically Distributing Files According to Set Conditions

You can use the keyword distribution function so that PDF files are automatically distributed into cabinets and folders according to the keywords that have been set.

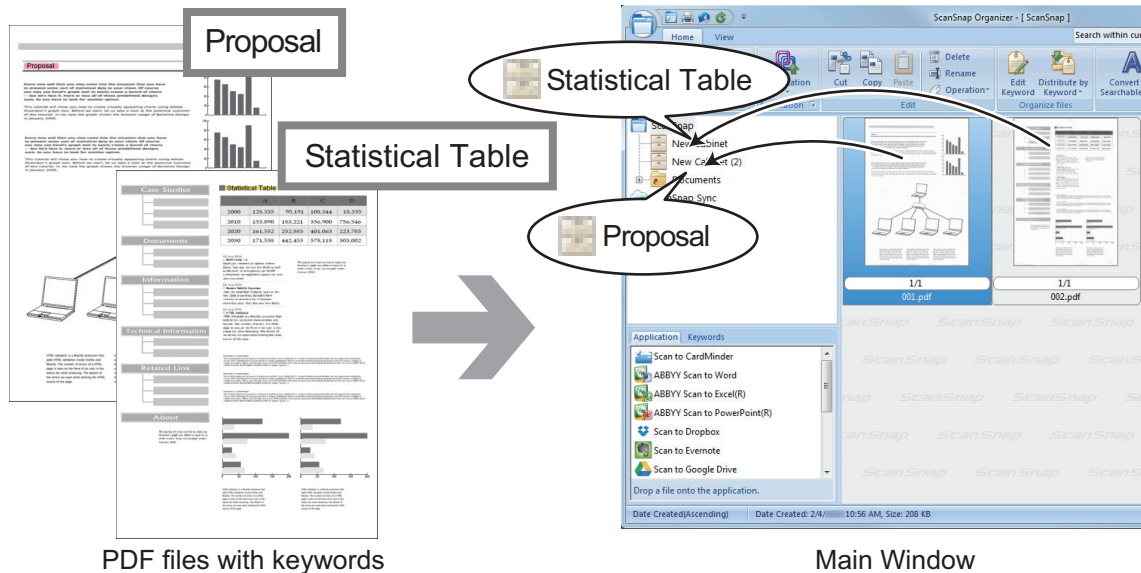

Editing Files

For details about operations, refer to the ScanSnap Organizer Help.

Correcting a book distortion

If you scan a book with SV600, you can correct distorted images by using book image correction in ScanSnap Organizer Viewer.

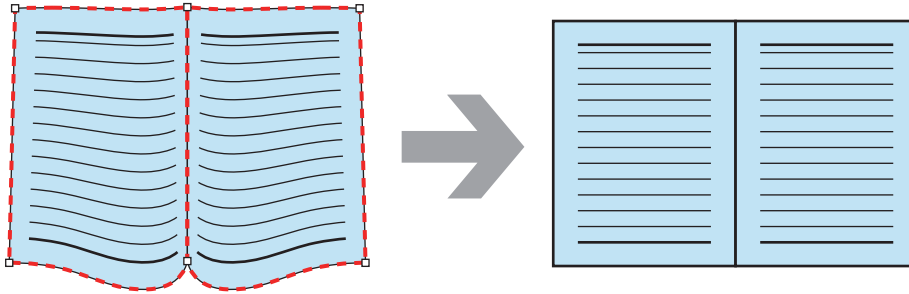

For details about other image correction functions, refer to the ScanSnap Organizer Help.

Using Files

For details about operations, refer to the ScanSnap Organizer Help.

Linking Files with Other Applications

You can use files with a variety of applications.

The applications that can be used are displayed in the Application List Pane at the lower left corner of the Main Window.

Sending Files by E-mail

Files can be sent by e-mail.

Clipping Important Items from Documents

You can use the marked section cropping function to clip important items from documents.

Mark the necessary sections of a black & white document and scan it with the ScanSnap to create a new PDF or JPEG file that contains only the marked section.

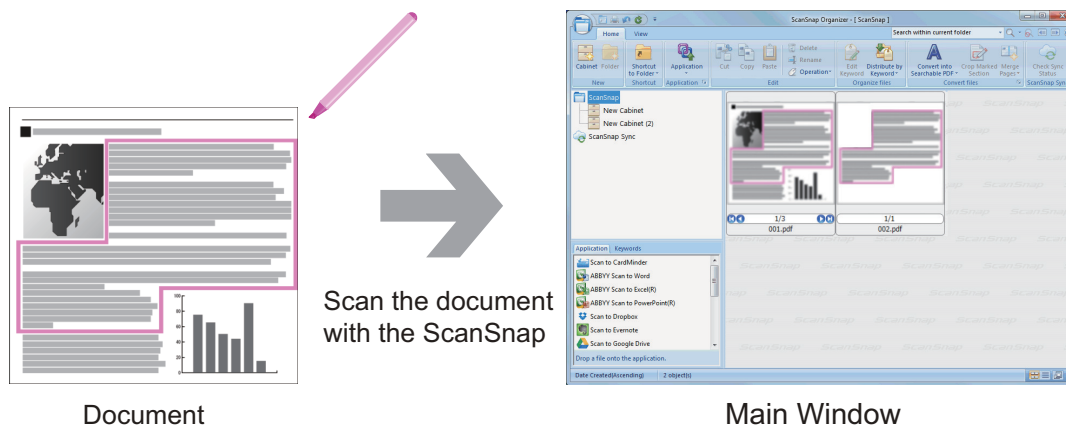

Using Files by Syncing with a Mobile Device

By using the ScanSnap Sync function, an image file scanned by the ScanSnap can be synced automatically with a mobile device and can be used easily anytime or anywhere via a cloud service.

The files are organized and managed in the "ScanSnap Sync" folder in ScanSnap Organizer.

Syncing Files Made up of Images That Were Saved Together ("JPEG (Save together)" Files)

Using the ScanSnap Sync function allows you to sync "JPEG (Save together)" files between a mobile device and ScanSnap Organizer.

A "JPEG (Save together)" file consists of multiple images that are scanned with ScanSnap Connect Application.

What You Can Do with CardMinder

CardMinder is an application used for displaying, organizing, and managing card image data scanned with a scanner.

This application digitalizes large amounts of business cards into images at a high speed and recognizes text on those cards, thus allowing you to search for your clients' business cards from those data quickly, and create your client databases conveniently. CardMinder uses an Optical Character Recognition (OCR) engine to recognize text on cards and shares the data with Personal Information Manager (PIM) applications.

CardMinder contains two separate functions: CardMinder Viewer to enable business card data to be quickly searched from other applications, and CardMinder Mobile Viewer to enable scanned business card data to be viewed on a computer in which CardMinder is not installed.

Card

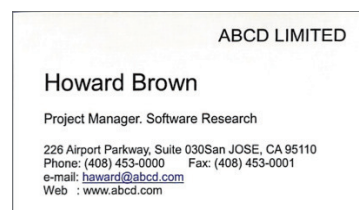

Scan

CardMinder window

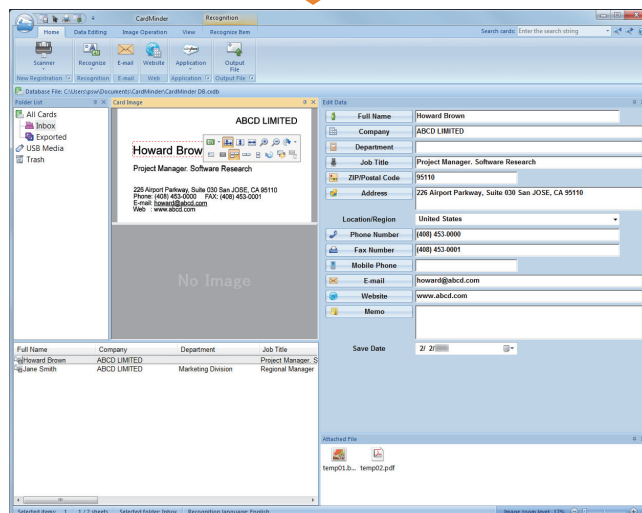

Recognized data

Share the recognized data with PIM
(Example: Outlook)

- "Basic Operation Procedure of CardMinder" (page 432)
- "Linking Card Data with Other Applications" (page 435)
- "Searching Card Data with the Basic Search Toolbar" (page 436)

- ["Searching Card Data with CardMinder Viewer" \(page 437\)](#)
- ["Attaching a File to Card Data" \(page 438\)](#)

Basic Operation Procedure of CardMinder

This section explains the basic operation procedure of CardMinder.

1. Start CardMinder.

Start up CardMinder by double-clicking the [CardMinder] icon on the desktop.

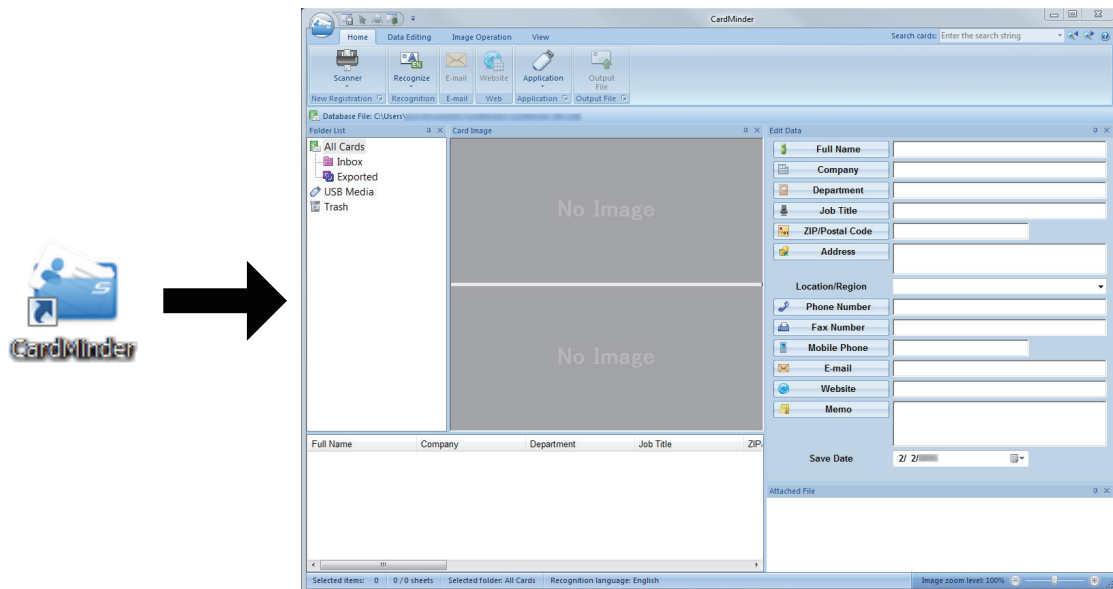

2. Scan a card with the scanner.

Click the [Scanner] button on the [Home] tab to start scanning a card.

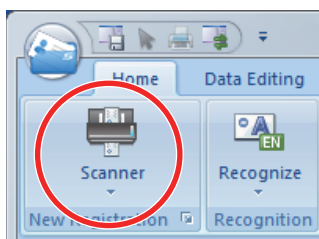

When scanning is complete, the information printed on the card (such as name, company, and address) is automatically recognized as text and displayed in the Edit Data pane.

The image data scanned from the card is displayed in the Card Image pane.

ATTENTION

ScanSnap Manager must be installed on your computer when you want to recognize the following languages:

- Chinese (simplified)
- Chinese (traditional)
- Korean

3. Check the card data.

Make sure that the front and back card images are correct, and that the text on the card images are displayed correctly in the Edit Data pane.

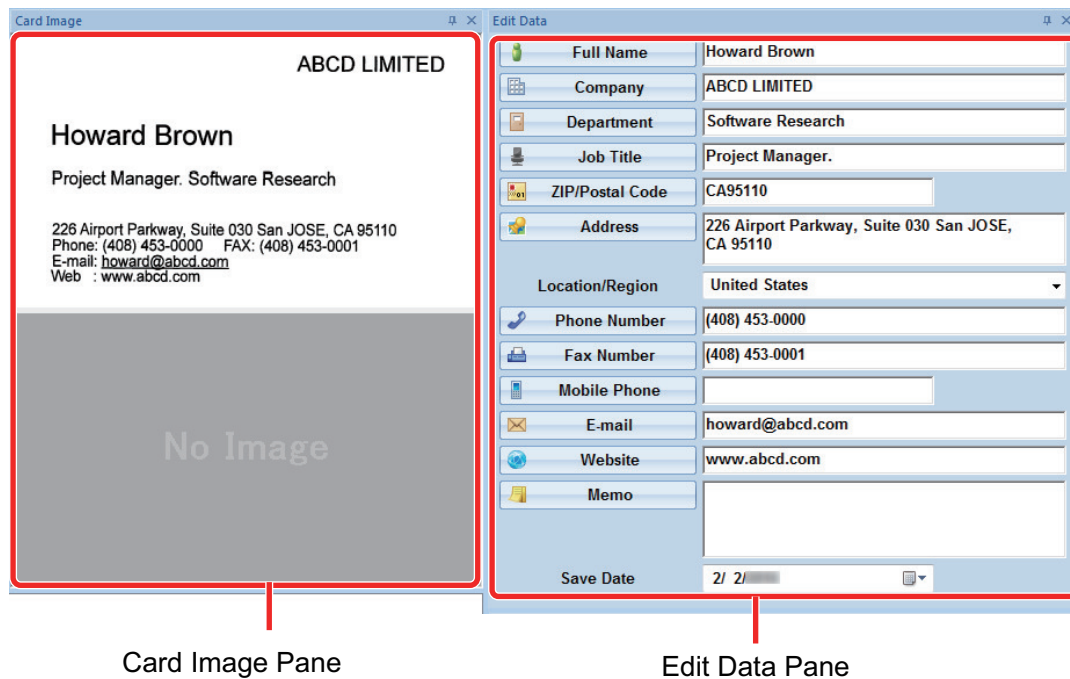

4. If the language to be used for text recognition is different, perform text recognition again in the following procedure:

1. Click  on the [Home] tab.
 - ⇒ The recognized languages are displayed.
2. Select a language for the character strings to be recognized.
 - ⇒ The icon for the [Recognize] button changes to the selected language.
3. Click the icon for the [Recognize] button.



Example: To recognize English, click .

⇒ A confirmation message for the recognition process is displayed.

4. Click the [Yes] button.
 - ⇒ Character strings on the card data will be recognized as the selected language.

5. Correct the card data, if necessary.

The card data can be corrected in the following ways. For details, refer to the CardMinder Help.

- Redoing the recognition process on the character strings in the selected areas
- Entering text directly in the Edit Data pane
- Correcting the orientation of the card image or switching the front and back images

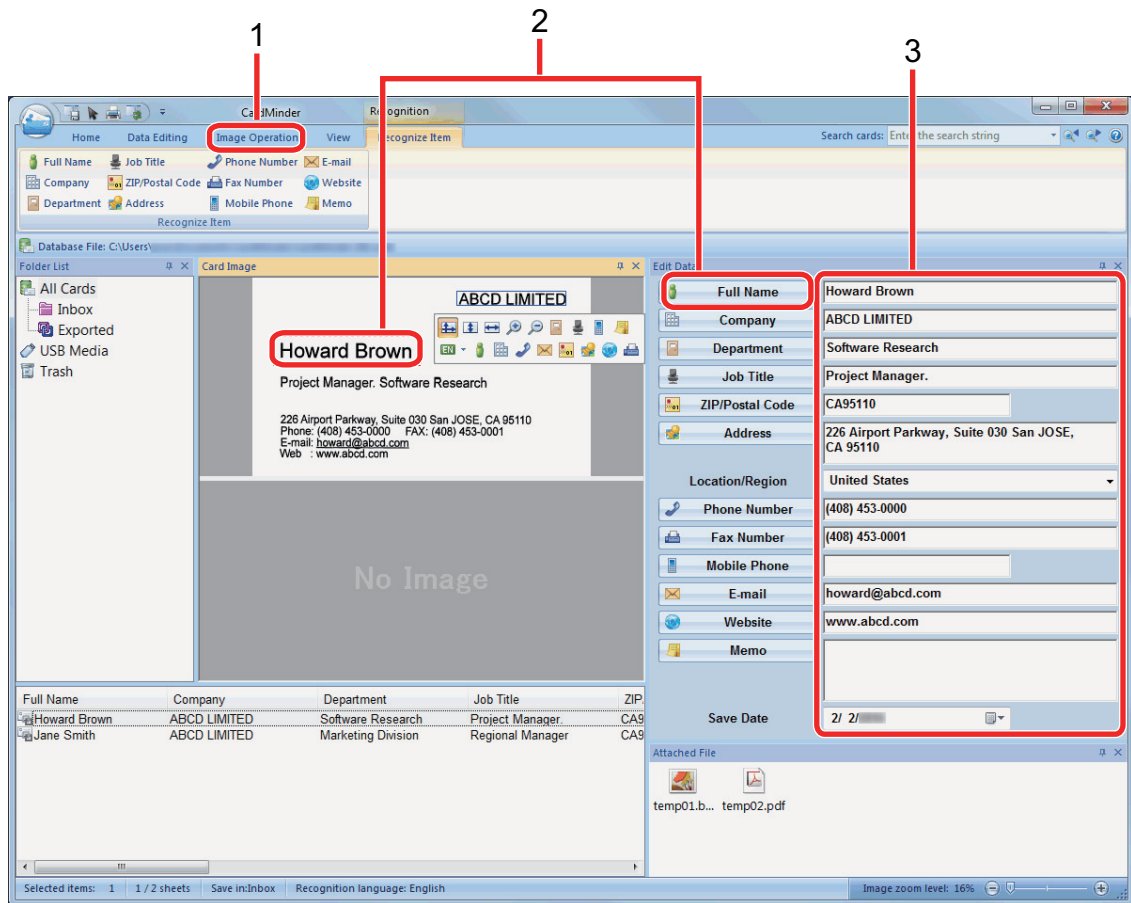

No.	Description
1	In the [Image Operation] tab, you can perform corrections, such as rotating the card image or switching the front and back images.
2	By selecting character strings in the card image and then clicking the buttons of the appropriate fields in the Edit Data pane, you can redo the recognition process on the selected areas.
3	You can directly correct the text of each field in the Edit Data pane.

6. Exit CardMinder.

To exit CardMinder, click the application button and then click the [Exit] button in the menu that appears.

Linking Card Data with Other Applications

Click the following buttons on the [Home] tab to use card data in a variety of applications.

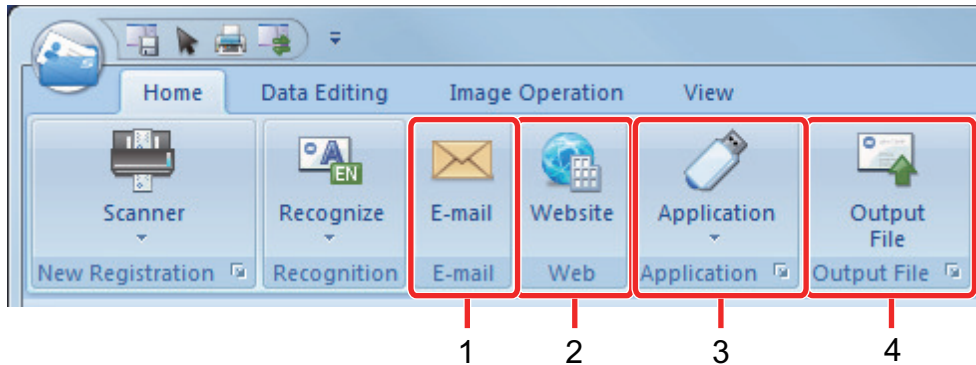

No.	Item	Description
1	E-mail	You can start an e-mail program, using the e-mail address specified in [E-mail] for the card data as the destination address.
2	Internet search	You can search the URL specified in [Website] for the card data with a web browser.
3	Linking card data with another application	You can link card data with another application such as Outlook or Salesforce CRM to use the card data in the linked application. You can also link card data with USB media to use the card data on a different computer.
4	Outputting card data in a different format	You can output card data in the vCard, CSV, text, or ContactXML format.

For details, refer to CardMinder Help.

Searching Card Data with the Basic Search Toolbar

This section explains how to search card data with the CardMinder Basic Search Toolbar.

Search cards (Basic Search Toolbar)

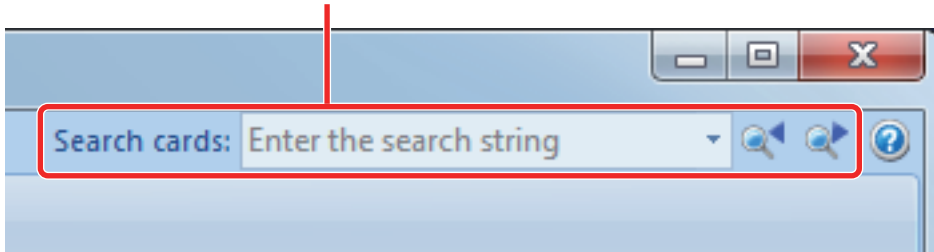

To search card data, type in a search term (such as an individual name or a company name) in the Basic Search Toolbar.

The search results are displayed in the main window.

If multiple cards match the search conditions, click  to display the next result of the search in the main window.

Searching Card Data with CardMinder Viewer

This section explains how to search card data with CardMinder Viewer.

Even when CardMinder is not running, you can search card data by using a character string in another application (such as Microsoft Notepad) as the keyword for searching.

- 1. Drag the mouse to select a character string you want to search for.**
- 2. Press [Alt] + [F3] keys on the keyboard at the same time.**
 - ⇒ CardMinder Viewer starts and the card data found, based on the search conditions entered (such as an individual name and a company name), is displayed in the window.

If multiple cards match the search conditions, click  to display the next result of the search in the CardMinder Viewer window.

HINT

Click  to display in the CardMinder window the details of the card data selected in the CardMinder Viewer window.

Attaching a File to Card Data

A file can be attached to card data easily by dragging and dropping it.

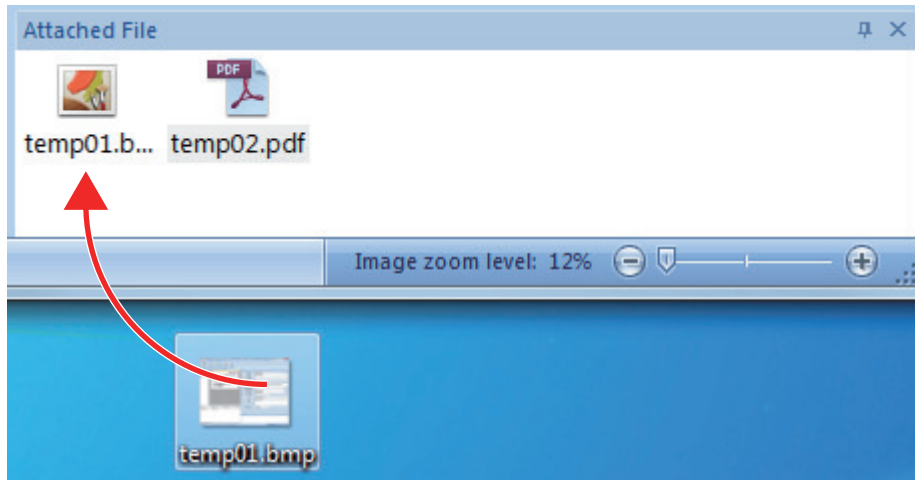

Useful Usages

This section explains how to use related software for the scanned image that is created after a document is scanned with the ScanSnap.

- ["Managing Paper Documents by Folder on a Computer with ScanSnap Home" \(page 440\)](#)
- ["Managing Paper Documents by Folder on a Computer with ScanSnap Organizer" \(page 443\)](#)
- ["Saving Business Card Data to a Computer with ScanSnap Home" \(page 446\)](#)
- ["Saving Business Cards to a Computer with CardMinder" \(page 449\)](#)
- ["Saving Receipt Data to a Computer" \(page 452\)](#)
- ["Creating a Photo Album and Saving it to a Computer" \(page 455\)](#)

Managing Paper Documents by Folder on a Computer with ScanSnap Home

This section explains how to digitize paper documents and manage the data by folder in ScanSnap Home.

1. Scan a paper document with the ScanSnap.

For details about how to perform a scan, refer to "Scanning Documents" (page 196).

⇒ The Quick Menu appears.

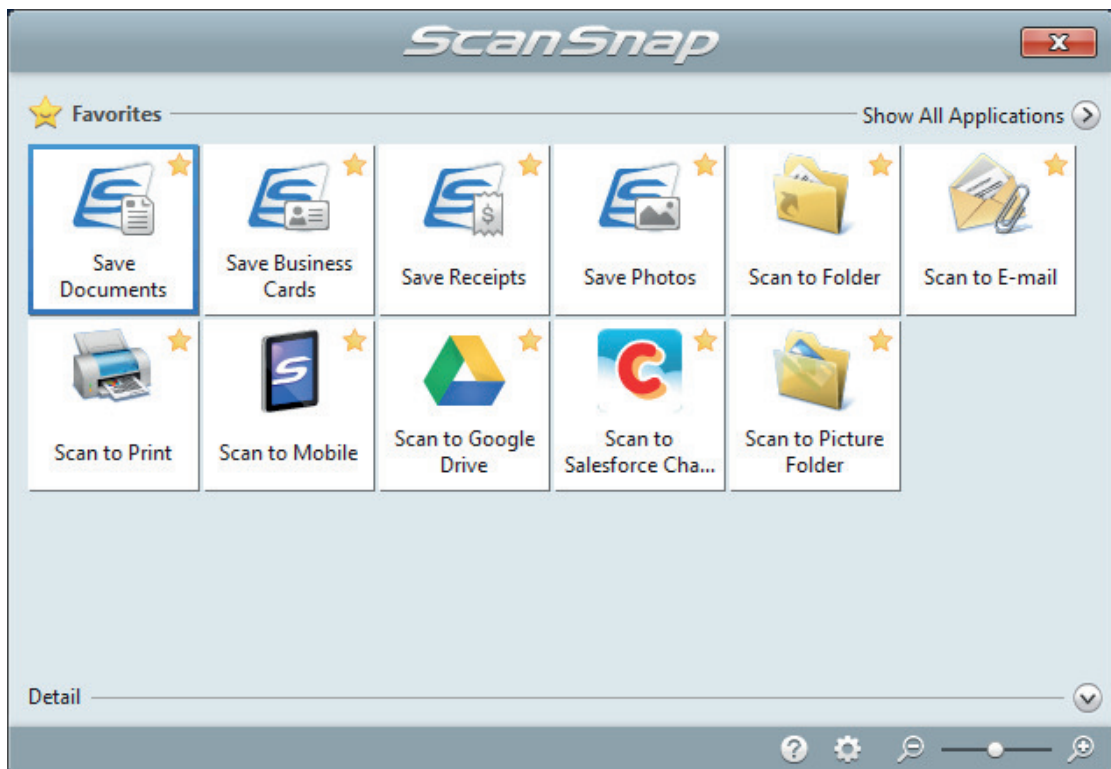

2. Click the [Save Documents] icon in the Quick Menu.

⇒ A scanned image together with meta information (such as character strings that were recognized by the text recognition function and the date when you scanned it) of a document that you scanned is saved as a content data record in ScanSnap Home.

In addition, the main window of ScanSnap Home appears, so that you can check the content data record created from the document that you scanned.

HINT

A scanned image together with meta information is referred to as content data record in ScanSnap Home.

3. Select [ScanSnap Home] under the [PC] folder.

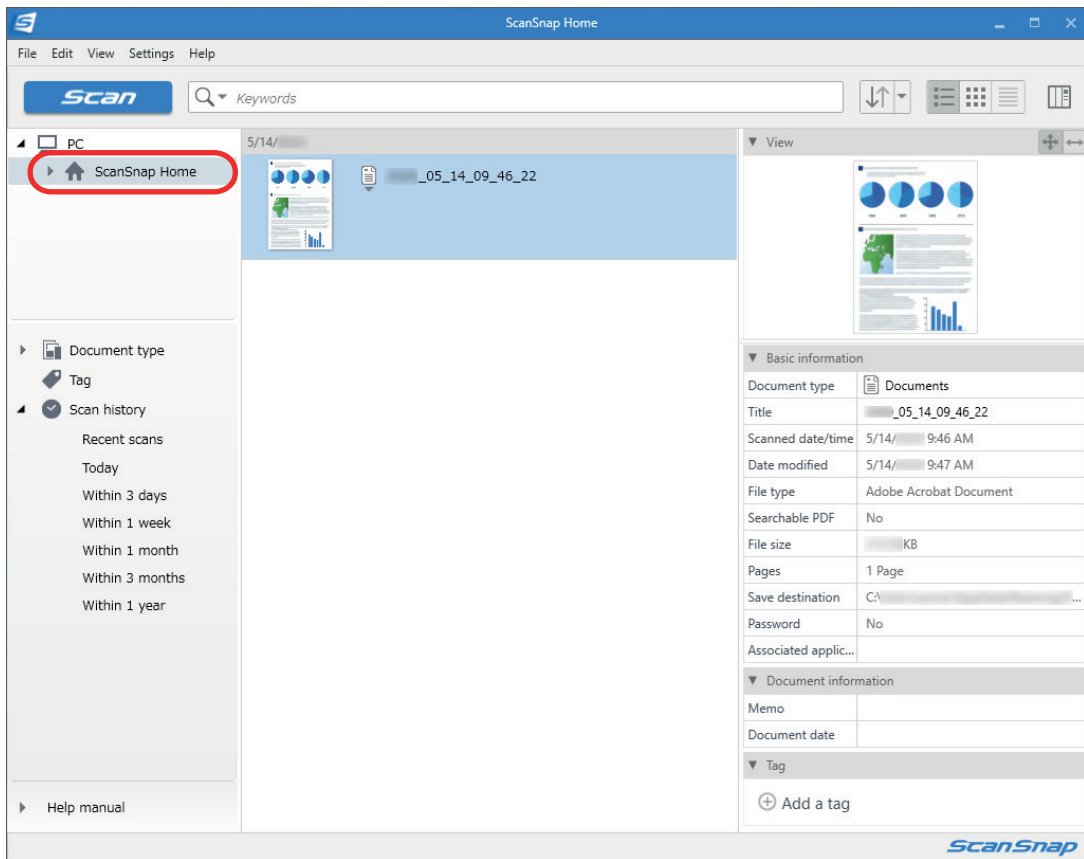

4. Select [Create new folder] in the menu that appears when you right-click the folder.

⇒ A new folder is created.

5. Rename the created folder.

HINT

To create multiple folders, repeat steps 3 to 5.

6. In the list that is displayed when you select [Recent scans], select a content data record and drag and drop it onto the created folder.

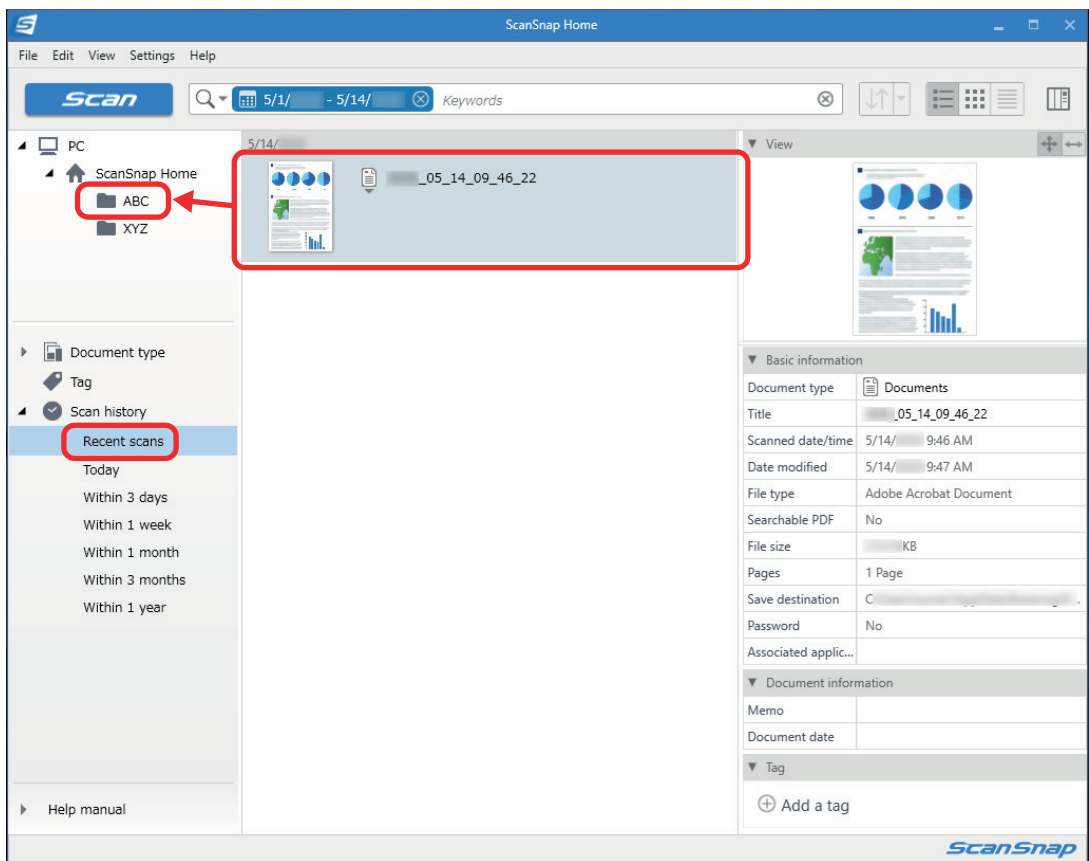

⇒ The content data record is moved to the folder.

HINT

ScanSnap Home has various functions for using saved content data records. For details, refer to the [ScanSnap Home Help](#).

Managing Paper Documents by Folder on a Computer with ScanSnap Organizer

This section explains how to digitize paper documents and manage the data by folder in ScanSnap Organizer.

1. Scan a paper document with the ScanSnap.

For details about how to perform a scan, refer to "Scanning Documents" (page 196).

⇒ The Quick Menu appears.

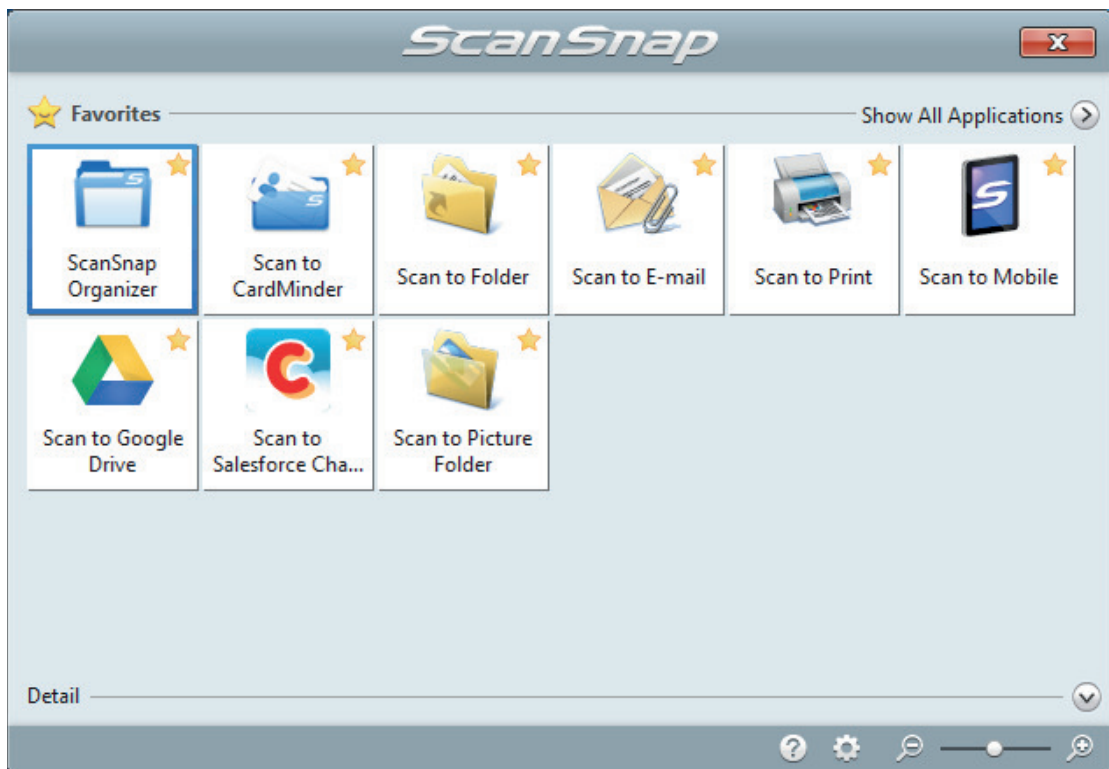

2. Click the [ScanSnap Organizer] icon in the Quick Menu.

⇒ The [ScanSnap Organizer] window appears.

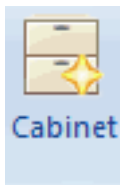
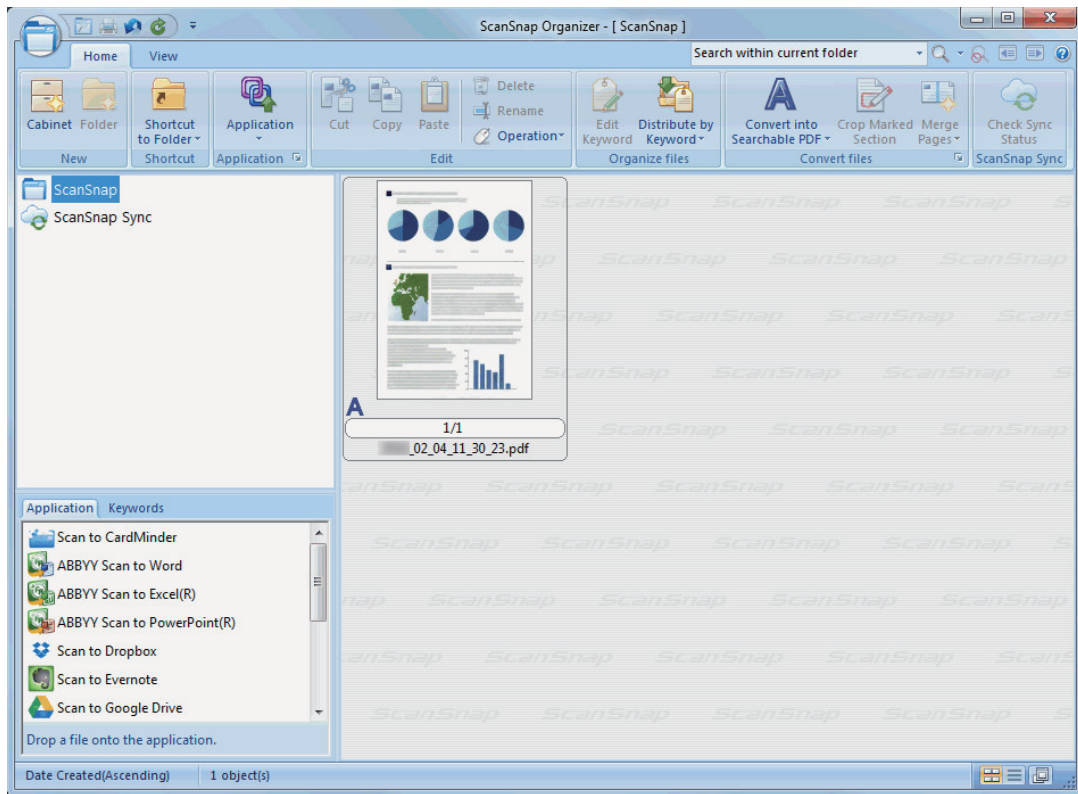

3. Click **Cabinet** on the [Home] tab.
⇒ A new cabinet is created in the folder list.

4. **Rename the created cabinet.**

HINT

To create multiple cabinets, repeat steps 3 to 4.

5. **Select the scanned image from the file list, and drag and drop it to the cabinet.**

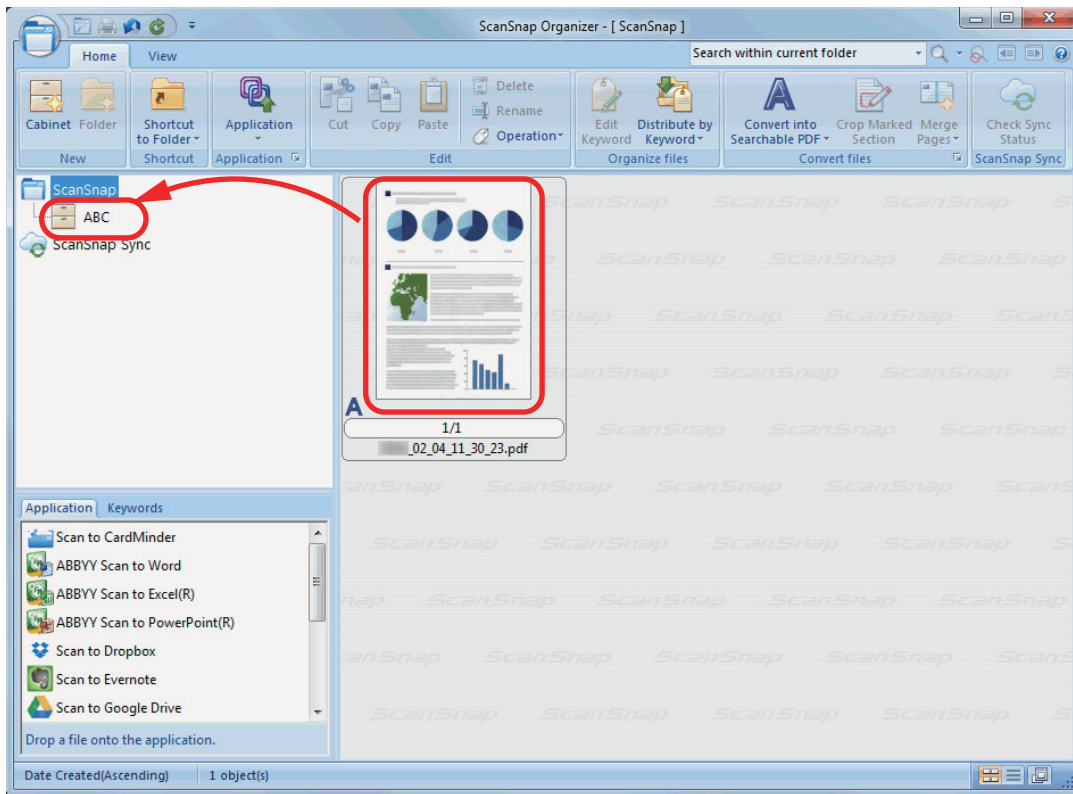

⇒ The scanned image is moved to the cabinet.

HINT

ScanSnap Organizer has various functions for using saved files.
For details, refer to the ScanSnap Organizer Help.

Saving Business Card Data to a Computer with ScanSnap Home

This section explains how to digitize business cards and save the card data in ScanSnap Home.

1. Scan business cards with the ScanSnap.

For details about how to perform a scan, refer to "Scanning Documents" (page 196).

⇒ The Quick Menu appears.

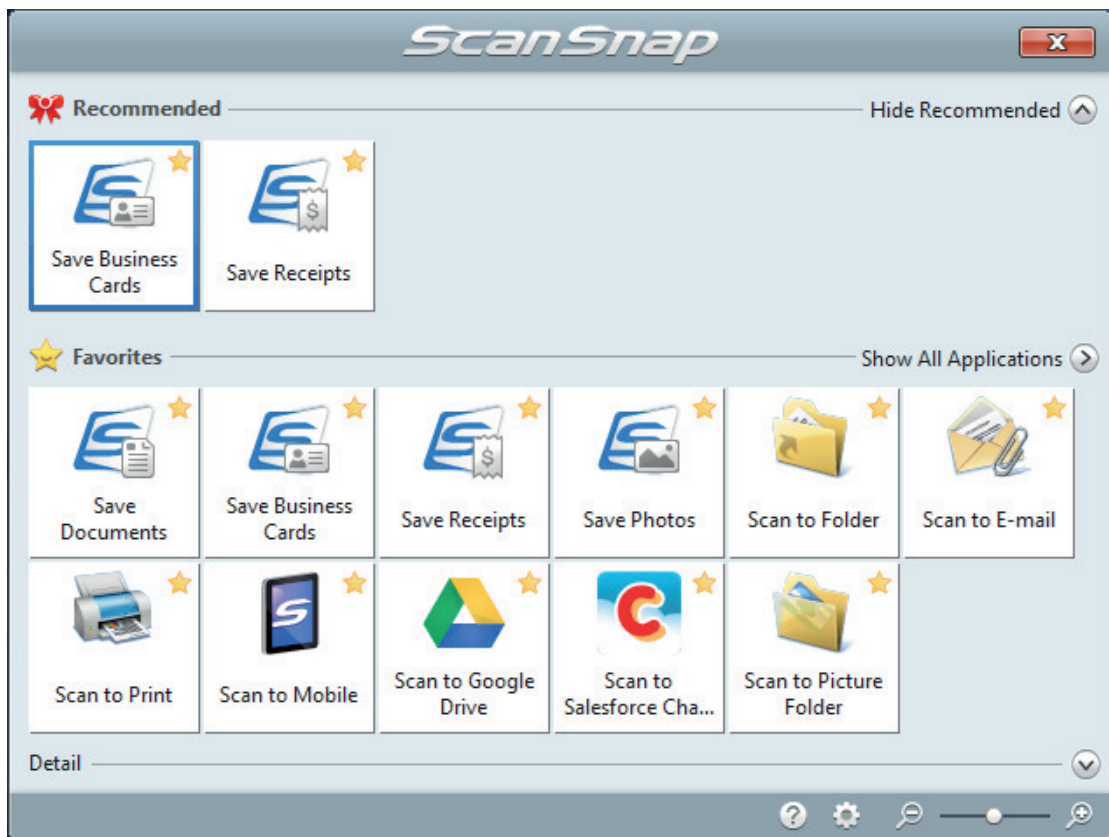

2. Click the [Save Business Cards] icon in the Quick Menu.

⇒ A scanned image together with meta information (such as character strings that were recognized by the text recognition function and the date when you scanned it) of a business card that you scanned is saved as a content data record in ScanSnap Home. In addition, the main window of ScanSnap Home appears, so that you can check the content data record created from the business card that you scanned.

HINT

A scanned image together with meta information is referred to as content data record in ScanSnap Home.

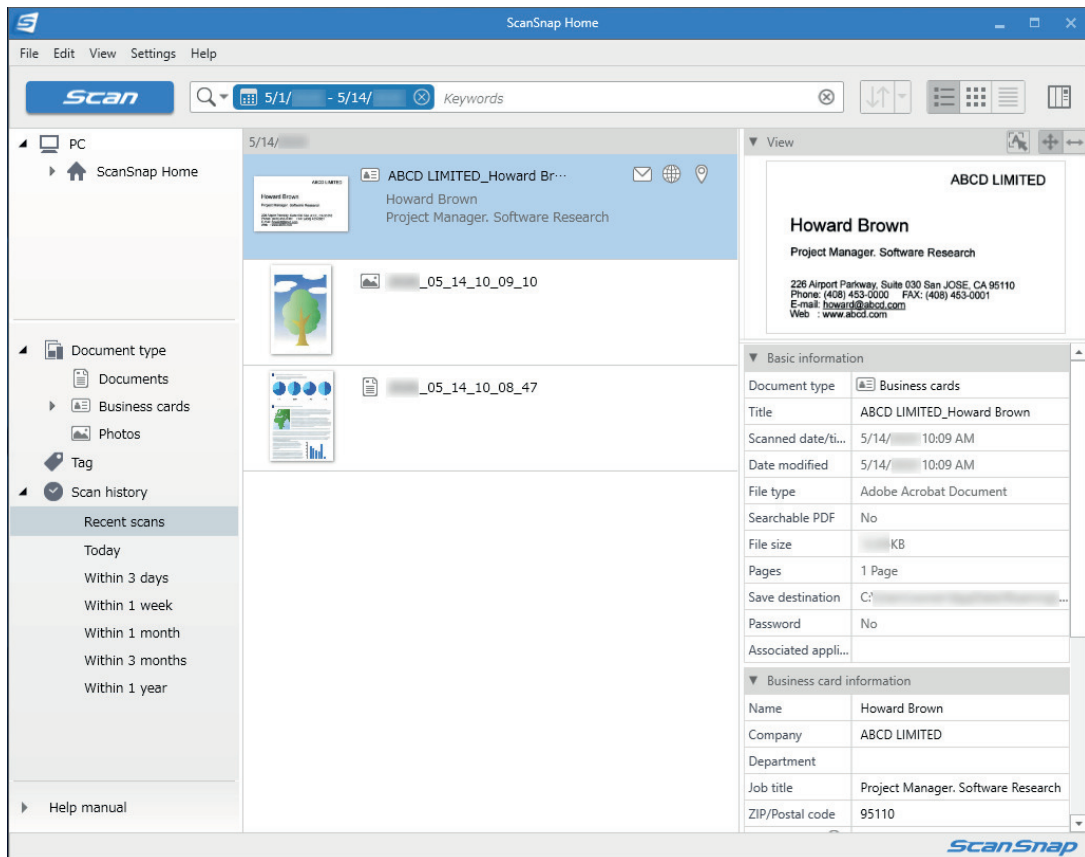

3. Check the card data.

Check whether characters in the image that is displayed in [View] are entered in [Business card information] correctly.

If the card information must be corrected, click the text to be corrected and then directly edit it.

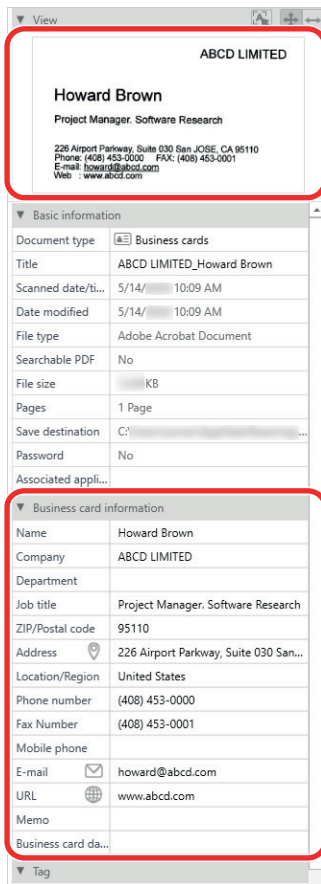

HINT

For details about ScanSnap Home operations, refer to the [ScanSnap Home Help](#).

Saving Business Cards to a Computer with CardMinder

This section explains how to digitize business cards and save the card data in CardMinder.

ATTENTION

If you do not log on as a user with Administrator privileges, you may not be able to link the ScanSnap with another application properly.

1. Scan business cards with the ScanSnap.

For details about how to perform a scan, refer to "Scanning Documents" (page 196).

⇒ The Quick Menu appears.



2. Click the [Scan to CardMinder] icon in the Quick Menu.

⇒ The [CardMinder] window appears.

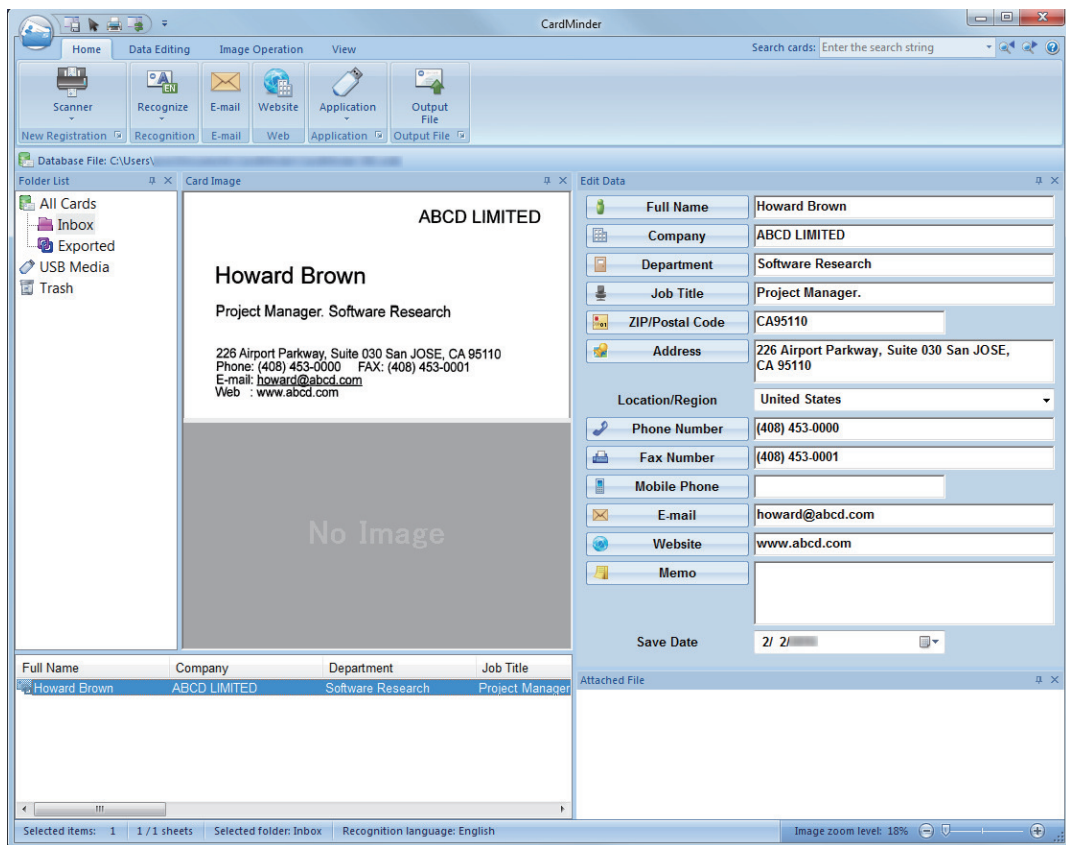

3. Check the card data.

Make sure that the text on the card images are displayed correctly in the Edit Data pane. If the card data must be corrected, click the text to be corrected and then directly edit it.

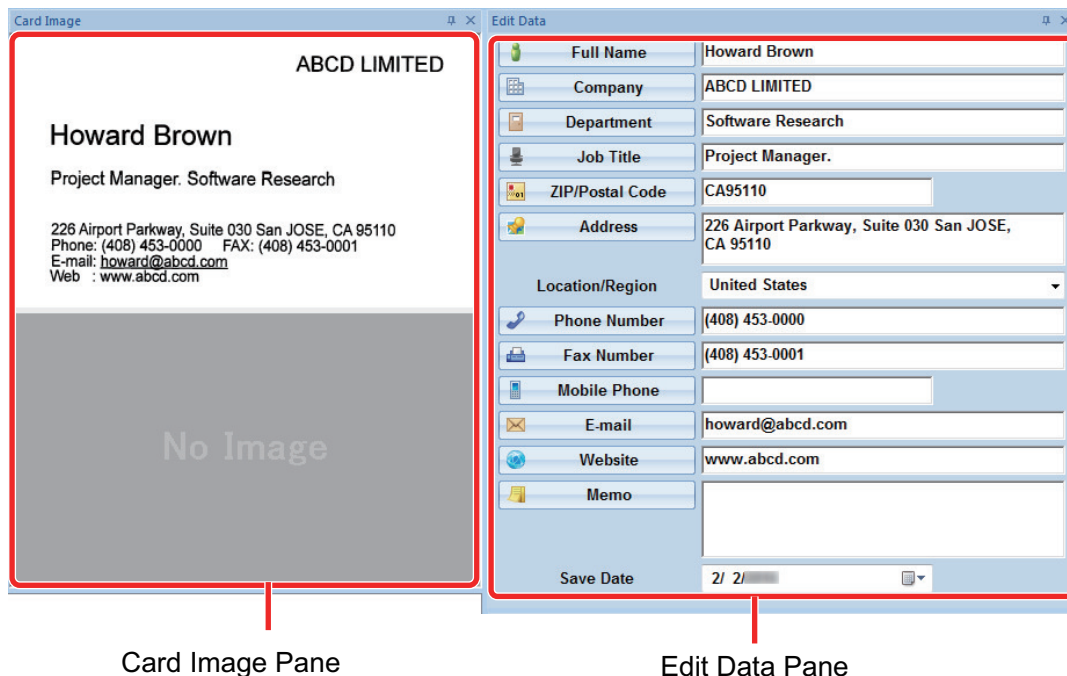

HINT

When you scan double-sided business cards, you must scan one side of each card and edit the card data in CardMinder.

For details, refer to the CardMinder Help.

Saving Receipt Data to a Computer

This section explains how to digitize receipts and save the receipt data in ScanSnap Home.

1. Scan receipts with the ScanSnap.

For details about how to perform a scan, refer to "Scanning Documents" (page 196).

⇒ The Quick Menu appears.

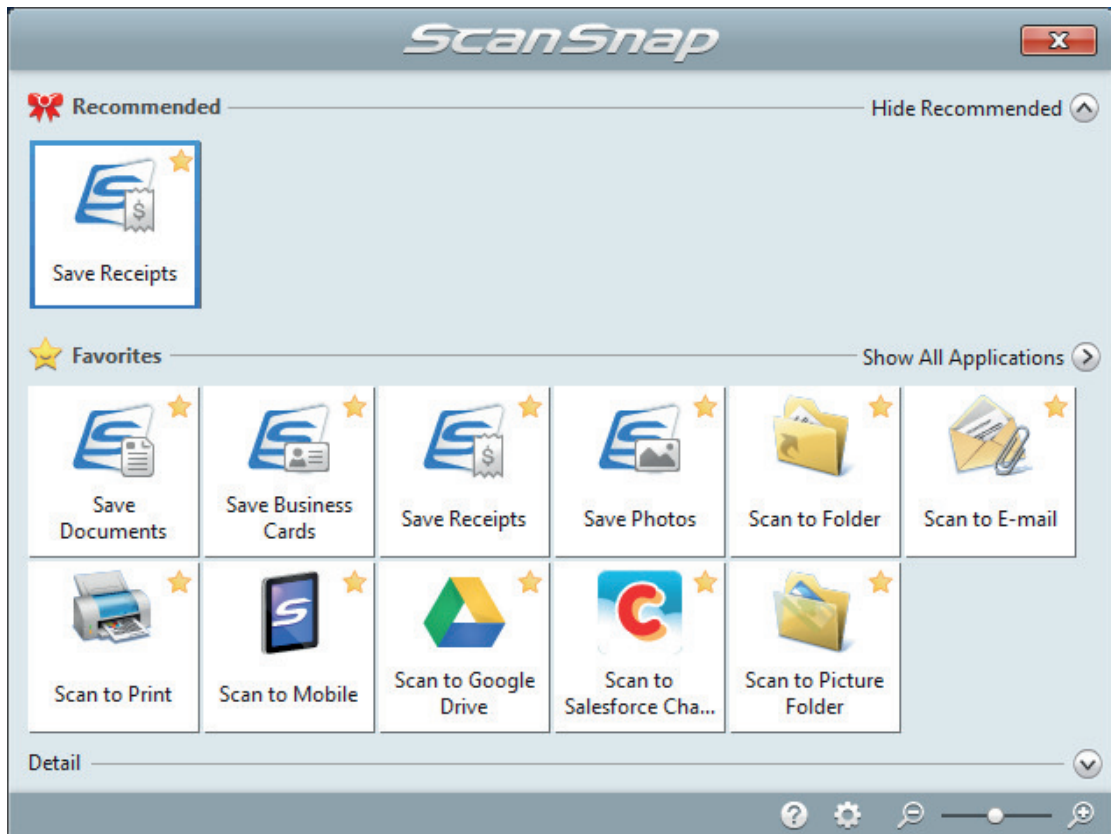

2. Click the [Save Receipts] icon in the Quick Menu.

⇒ A scanned image together with meta information (such as character strings that were recognized by the text recognition function and the date when you scanned it) of a receipt that you scanned is saved as a content data record in ScanSnap Home.

In addition, the main window of ScanSnap Home appears, so that you can check the content data record created from the receipt that you scanned.

HINT

A scanned image together with meta information is referred to as content data record in ScanSnap Home.

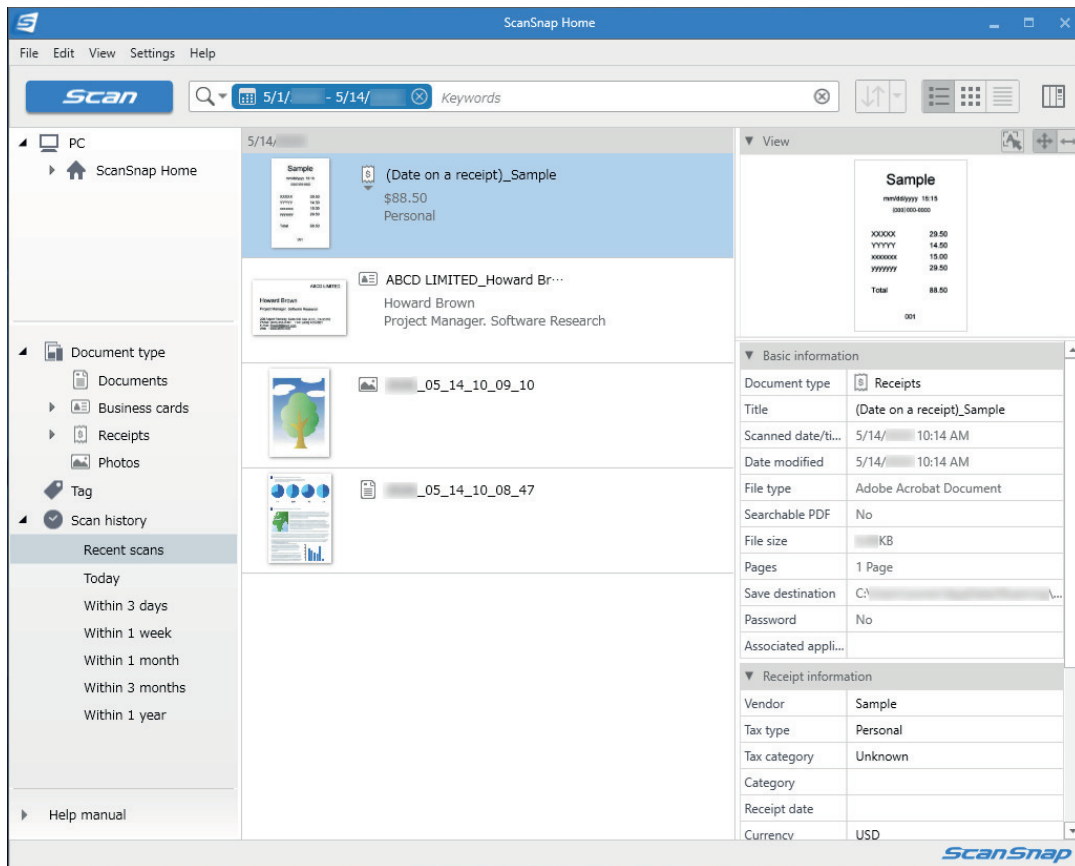

3. Check the receipt data.

Check whether characters in the image that is displayed in [View] are entered in [Receipt information] correctly.

If the receipt information must be corrected, click the text to be corrected and then directly edit it.

View

Sample

XXXXXXXXXX 15:13
XXXXXXXXXX

XXXXXX	29.50
YYYYY	14.00
XXXXXXXX	15.00
YYYYYYY	29.50
Total	88.00

001

▼ Basic information

Document type Receipts

Title (Date on a receipt)_Sample

Scanned date/ti... 5/14/ 10:14 AM

Date modified 5/14/ 10:14 AM

File type Adobe Acrobat Document

Searchable PDF No

File size KB

Pages 1 Page

Save destination C:\

Password No

Associated appli...

▼ Receipt information

Vendor Sample

Tax type Personal

Tax category Unknown

Category

Receipt date

Currency USD

Amount \$88.50

Tax \$0.00

Payment method

Card type

Card number

Comment

▼ Tag

HINT

For details about ScanSnap Home operations, refer to the [ScanSnap Home Help](#).

Creating a Photo Album and Saving it to a Computer

This section explains how to digitize photos and tag each digitized photo by name or by place in order to create an album in ScanSnap Home.

1. Scan photos with the ScanSnap.

For details about how to perform a scan, refer to "Scanning Documents" (page 196).

⇒ The Quick Menu appears.

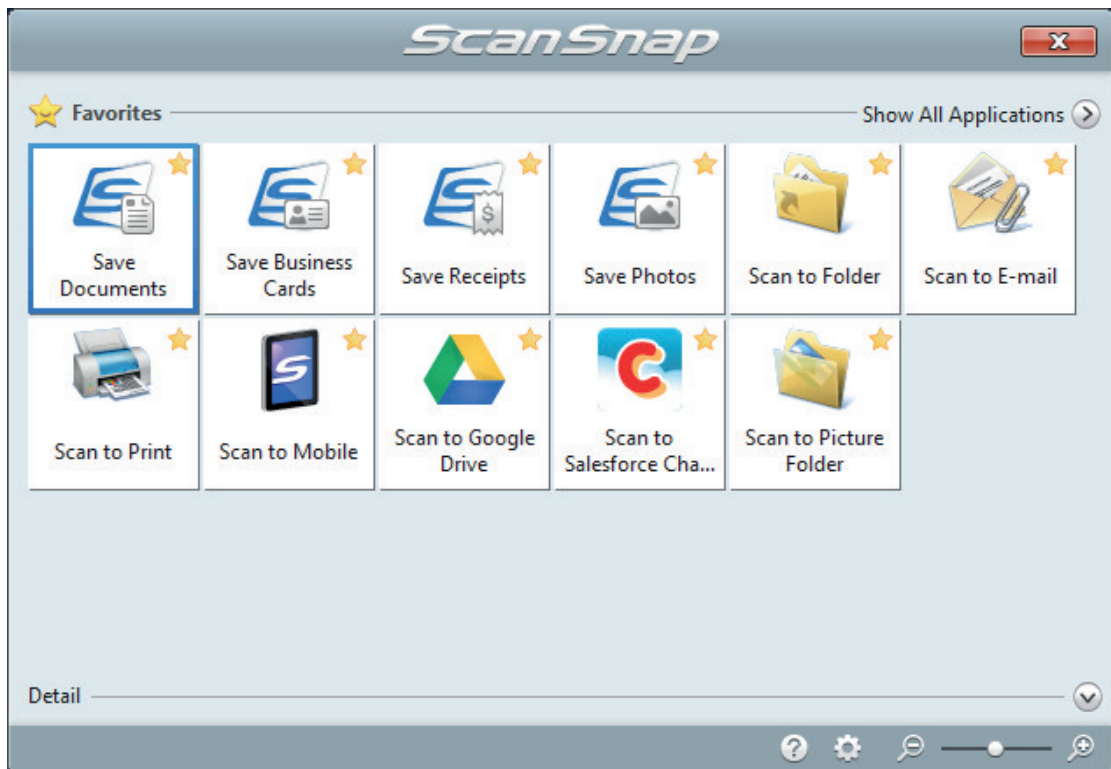

2. Click the [Save Photos] icon in the Quick Menu.

⇒ A scanned image together with meta information (such as the date when you scanned it) of a photo that you scanned is saved as a content data record in ScanSnap Home.

In addition, the main window of ScanSnap Home appears, so that you can check the content data record created from the photo that you scanned.

HINT

A scanned image together with meta information is referred to as content data record in ScanSnap Home.

3. Select a content data record created from the photo that you scanned.

4. Click for [Tag].

⇒ The input field appears.

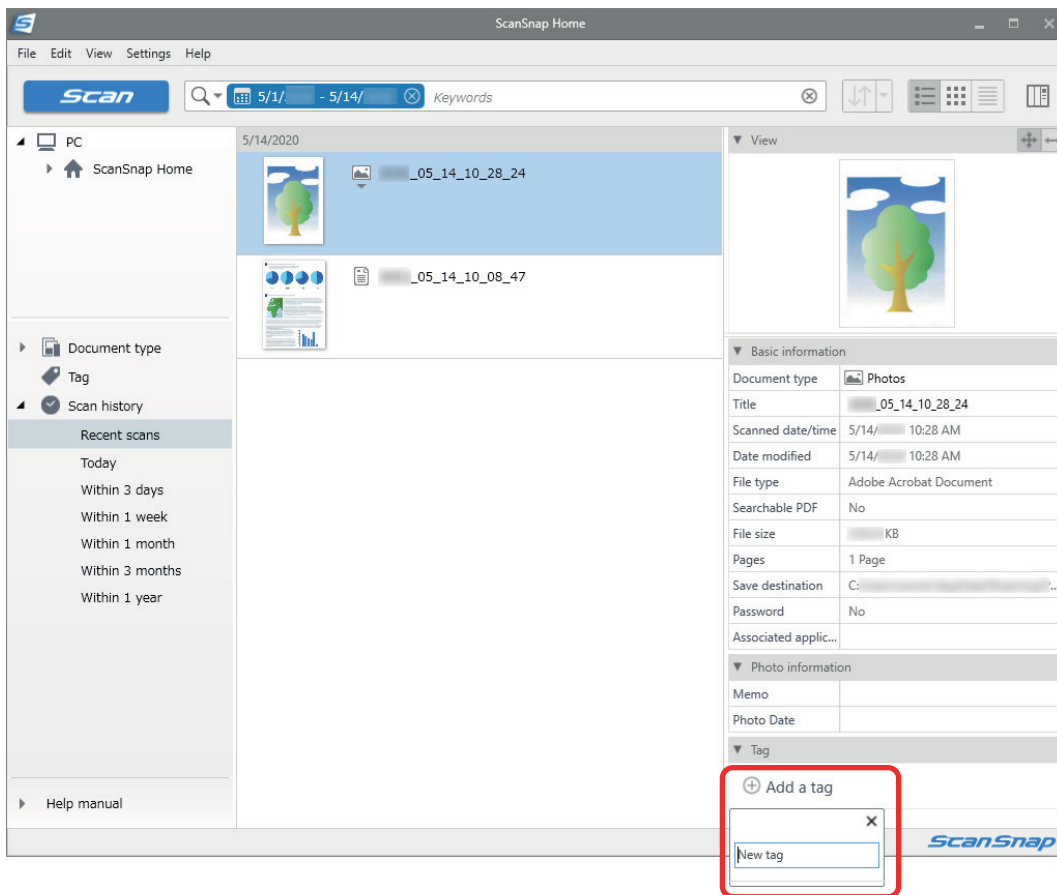

- 5. Enter a name in the input field to categorize the photo and press the [Enter] key.**
 - ⇒ A content data record created from the photo that you scanned is tagged with the specified name used to categorize the photo.
- 6. Select a tag that you specified as a name used to categorize the photo in [Tag].**

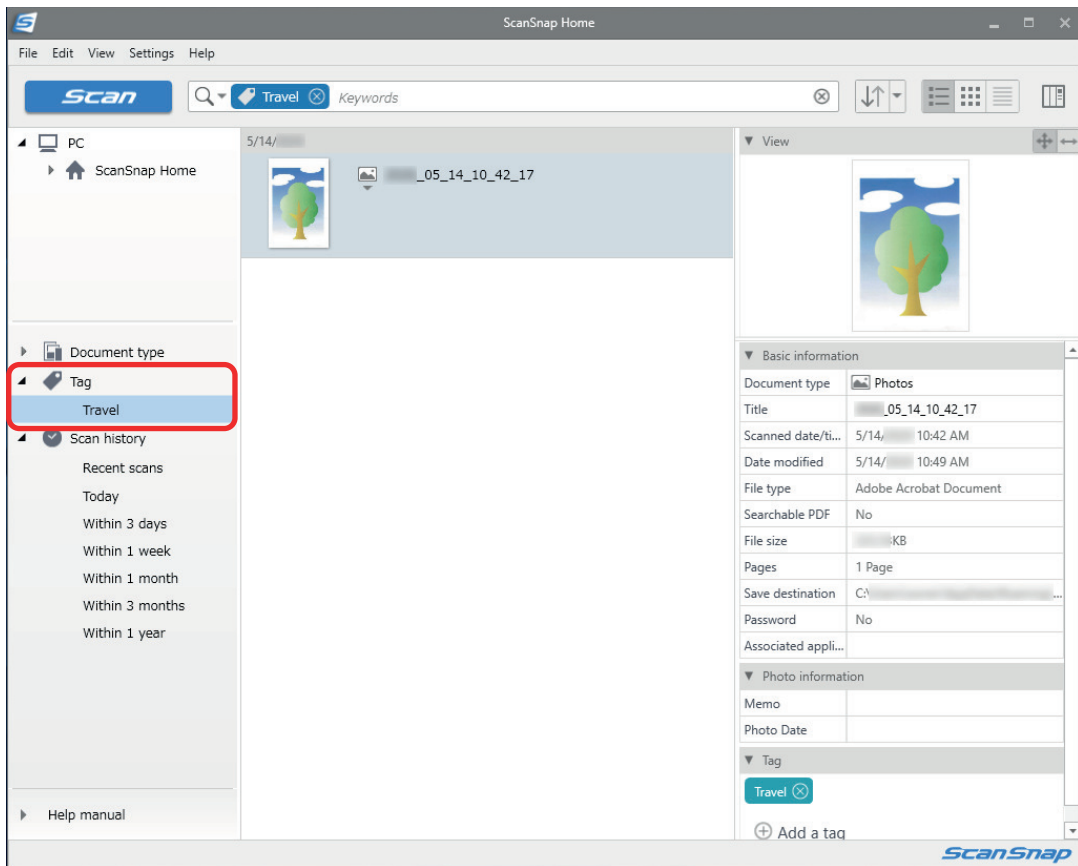

⇒ The tagged content data record created from the photo is displayed.

HINT

For details about ScanSnap Home operations, refer to the [ScanSnap Home Help](#).

Correcting Scanned Images (SV600)

The scanned images can be corrected before ScanSnap Manager is linked with an application. The scanned images can be corrected in the following cases:

- ["When a Document Is Scanned \(SV600\)" \(page 459\)](#)
- ["When a Book Is Scanned \(SV600\)" \(page 464\)](#)
- ["When Multiple Documents Are Scanned at Once \(SV600\)" \(page 476\)](#)

When a Document Is Scanned (SV600)

When a document is scanned with the ScanSnap, the following correction can be made on the scanned image:

- ["Filling in Fingers Captured in a Scanned Image \(When a Document Is Scanned\)\(SV600\)" \(page 460\)](#)

Filling in Fingers Captured in a Scanned Image (When a Document Is Scanned)(SV600)

Fingers that are captured when a document is scanned can be filled in.

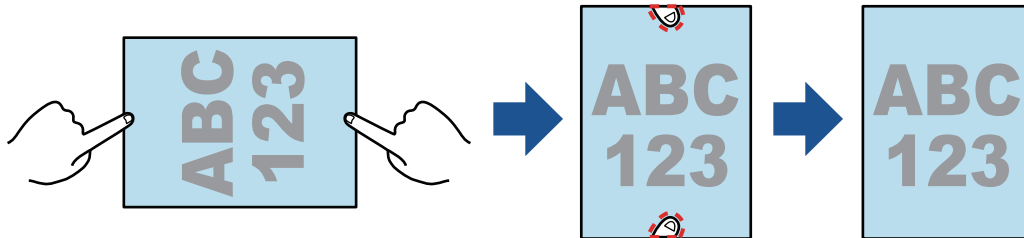

ATTENTION

- Do not hold the corners of the document when you scan.
If you do so, the shape of the image may not be recognized correctly.
- To fill in fingers captured in the scanned image, the fingers need to be detected.
If a document is scanned in the following ways, captured fingers may not be detected correctly.
 - When two or more fingers that are used to hold down a document to be scanned are touching each other (Figure 1)
 - When you hold down a document to be scanned with manicured fingers or fingers with artificial nails (Figure 2)
 - When you hold down a document to be scanned with your fingers bent (Figure 3)
 - When fingers that are used to hold down a document to be scanned are captured 1 cm (0.39 in.) or more (Figure 4)
 - When there is text or an image within 5 mm (0.2 in.) around the fingers that are used to hold down a document to be scanned (Figure 5)
 - When a document that has a background color other than white is scanned (Figure 6)
 - When a document is scanned after [Gray], [B&W], or [Color high compression] is selected from the [Color mode] drop-down list in the [Scanning] tab of the "ScanSnap Setup Window" (page 102)

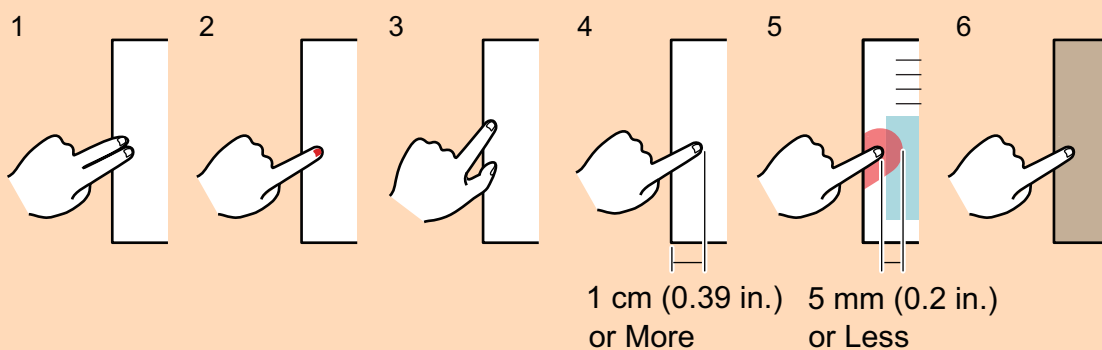

HINT

- Up to five fingers on each side (top/bottom/right/left) of the document can be filled in.
- To prevent image deterioration, select and fill in as many fingers as possible in one go.

1. On the window that appears after a document is scanned, select **[Crop and save flat document images as-is]** and click the **[Check/Correct]** button.

For details about how to perform a scan, refer to "Scanning Documents (SV600)" (page 350).

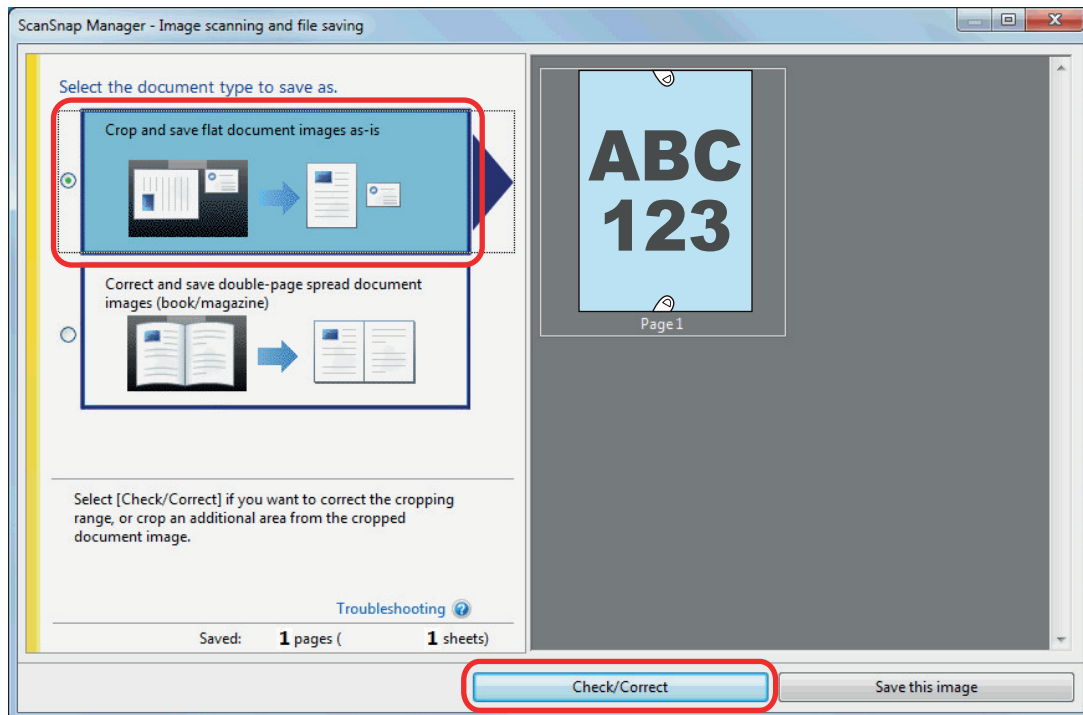

⇒ The [ScanSnap Manager - View cropped images] window is displayed.

2. Select a scanned image to fill in fingers captured in the image.
3. Select the **[Continue with Point Retouch]** checkbox and click the **[Next]** button.

HINT

The orientation of the scanned image and the crop area cannot be corrected in the [ScanSnap Manager - Book Image Viewer] window. Modify them in the [ScanSnap Manager - View cropped images] window beforehand.

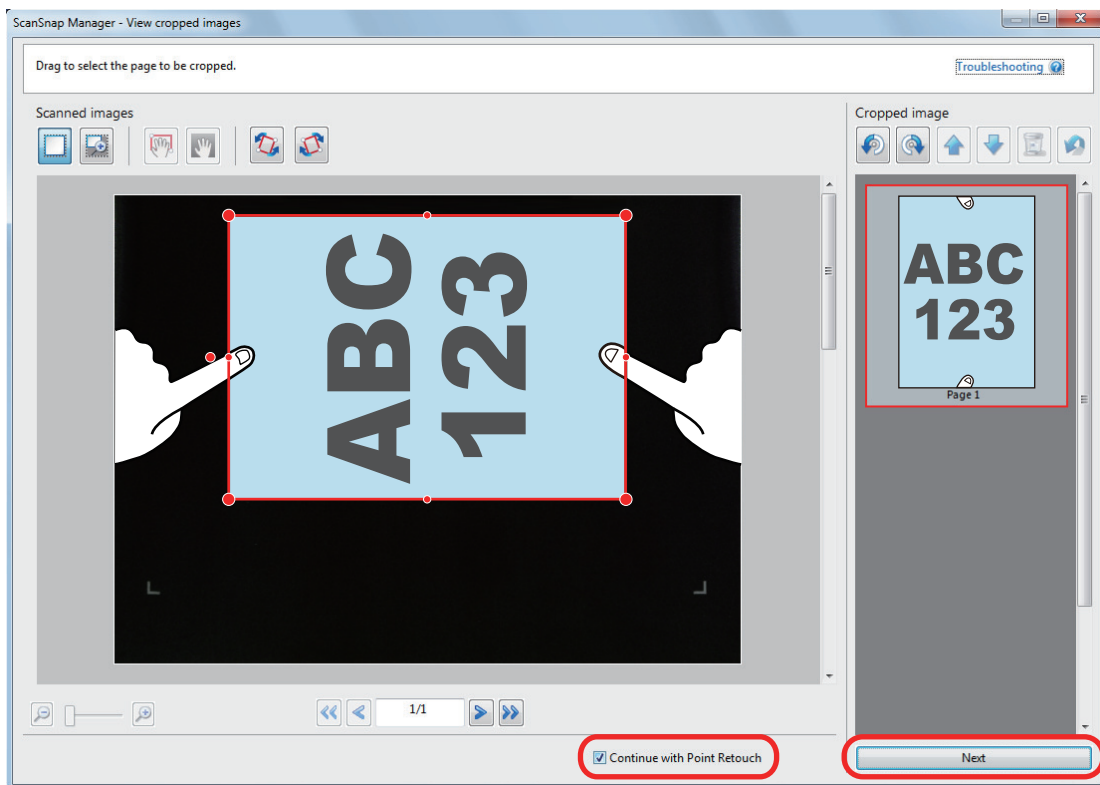

⇒ The [ScanSnap Manager - Book Image Viewer] window appears in the point retouch mode.

4. Click on a finger captured in a scanned image with the mouse.

⇒ When a finger is detected, it is indicated with a red dashed outline.

To change a range of the outline, drag the white dot on the outline.

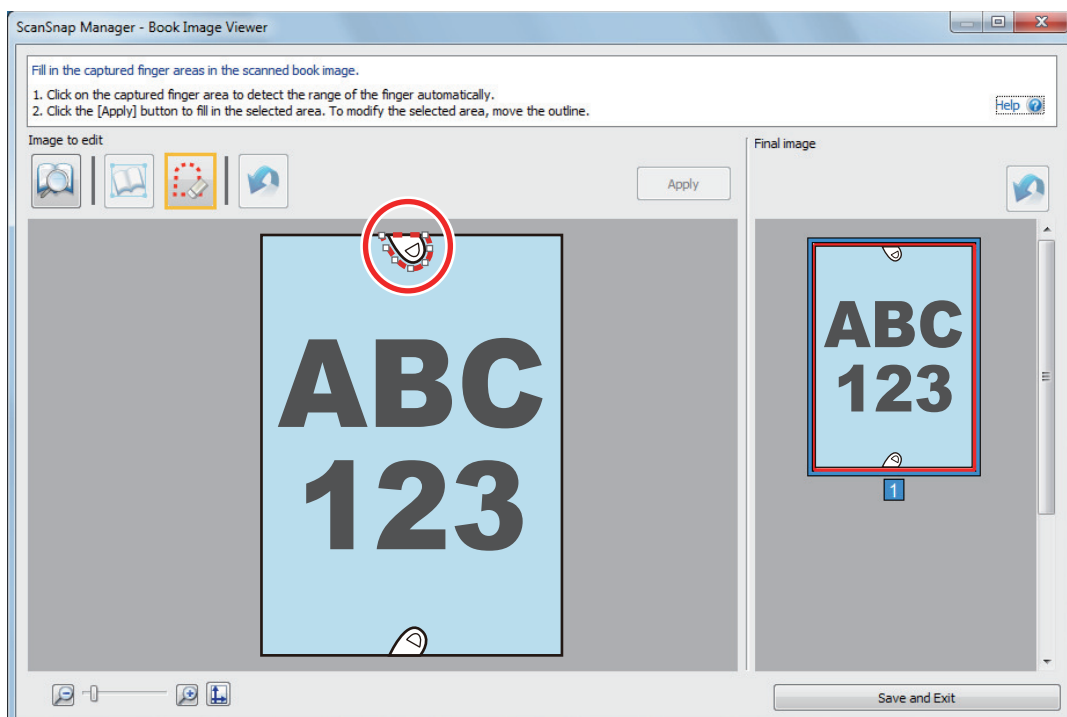

HINT

When a finger captured in a scanned image is not detected, a default outline is displayed around the finger.

In that case, drag the white dot on the outline to align the outline with the shape of the finger.

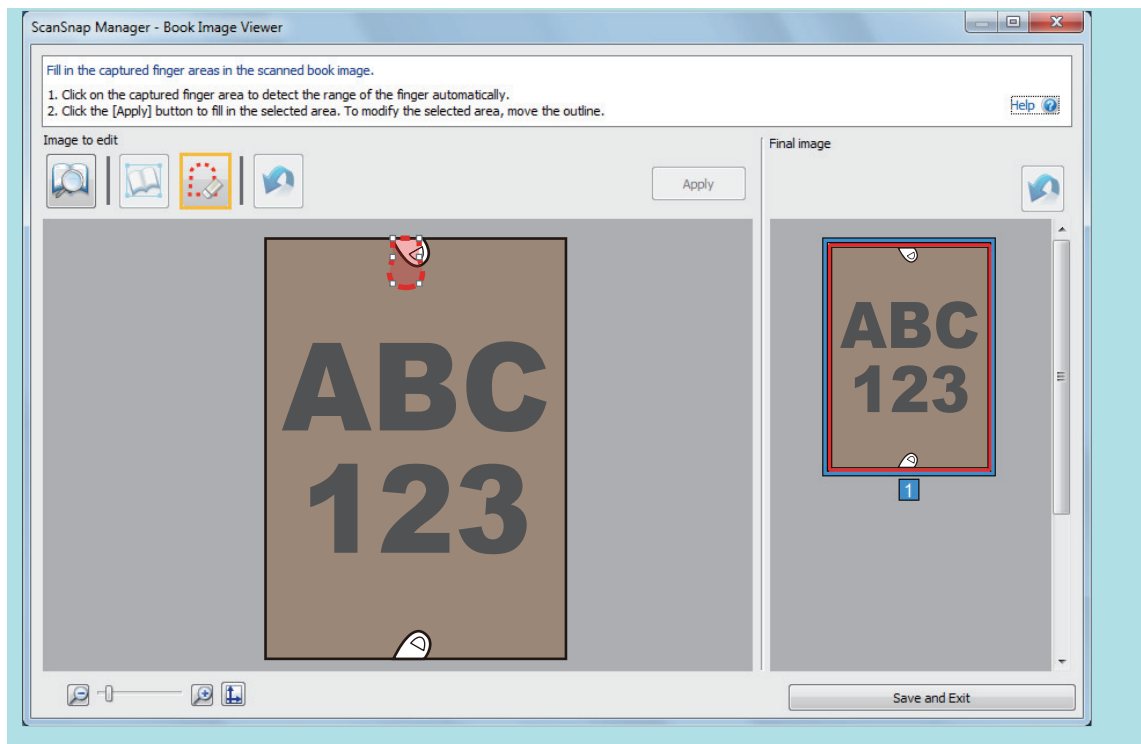

5. Click the [Apply] button.

⇒ The finger captured in a scanned image is filled in.

When you have completed filling in the captured finger, click the [Save and Exit] button.

When a Book Is Scanned (SV600)

The book image correction allows you to correct scanned images.

The book image correction refers to making the following corrections to the images scanned from books with the ScanSnap:

- ["Correcting Distorted Book Images \(SV600\)" \(page 465\)](#)
- ["Splitting a Double-Page Spread Image into Two Page Images \(SV600\)" \(page 470\)](#)
- ["Filling in Fingers Captured in a Scanned Image \(When a Book Is Scanned\)\(SV600\)" \(page 473\)](#)

Correcting Distorted Book Images (SV600)

To correct the distortion of a scanned image from a book, follow the procedure below.

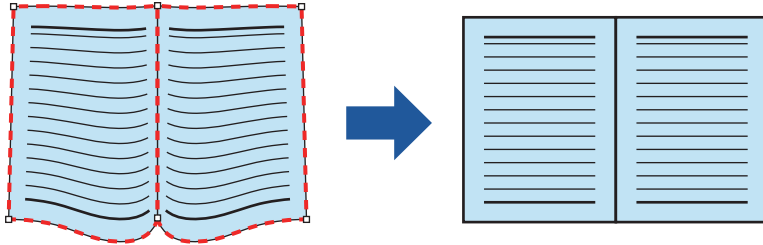

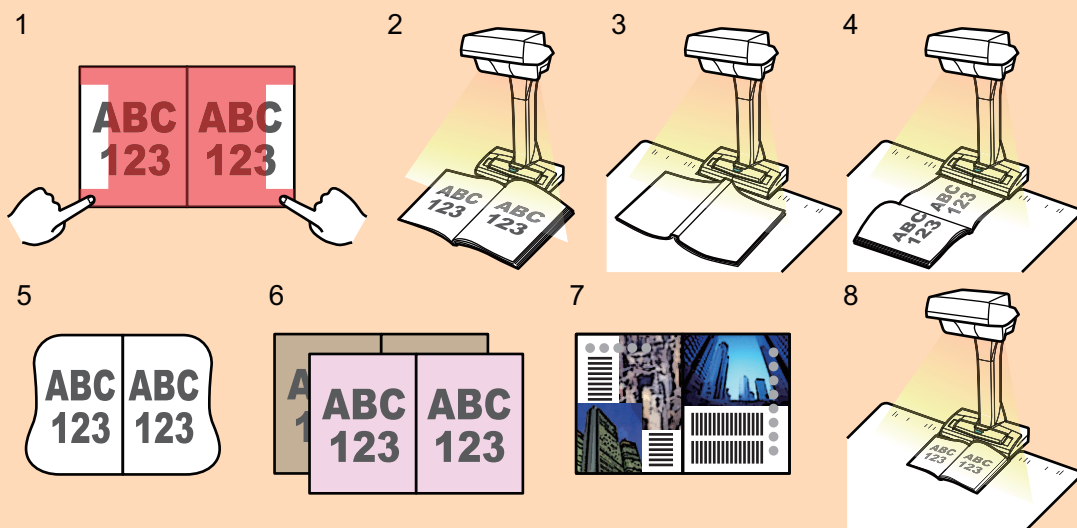

ATTENTION

- To correct the distortion of a scanned image, the shape of the book needs to be detected. If a book is scanned as follows, the shape of the book may not be detected correctly.
 - When a book to be scanned is held down outside of the appropriate areas (Figure 1)
 - When a book is scanned without the Background Pad (Figure 2)
 - When a book to be scanned is spread open and is placed face-down (Figure 3)
 - When a book to be scanned is placed in a vertical orientation (Figure 4)
 - When a book that is not rectangular or square is scanned (Figure 5)
 - When a book that has a background color other than white (such as a comic magazine) is scanned (Figure 6)
 - When a book that has a narrow margin space (such as a catalogue or a magazine) is scanned (Figure 7)
 - When a book that is smaller than A5 size (148 × 210 mm/5.83 × 8.27 in.) in a double-page spread is scanned (Figure 8)

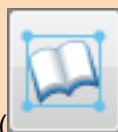

- Follow the procedure below to perform multiple book image correction for one page.



1. Edit in book image correction mode ().
 - Correcting a distorted book image
 - Splitting a double-page spread image



2. Edit in point retouch mode ().
 - Filling in the captured fingers in image

If you edit in the book image correction mode after editing in the point retouch mode, the edited results in point retouch mode are overridden.

1. On the window that appears after a book is scanned, select **[Correct and save double-page spread document images (book/magazine)]** and click the **[Check/Correct]** button.

For details about how to perform a scan, refer to ["Scanning Books \(SV600\)" \(page 355\)](#).

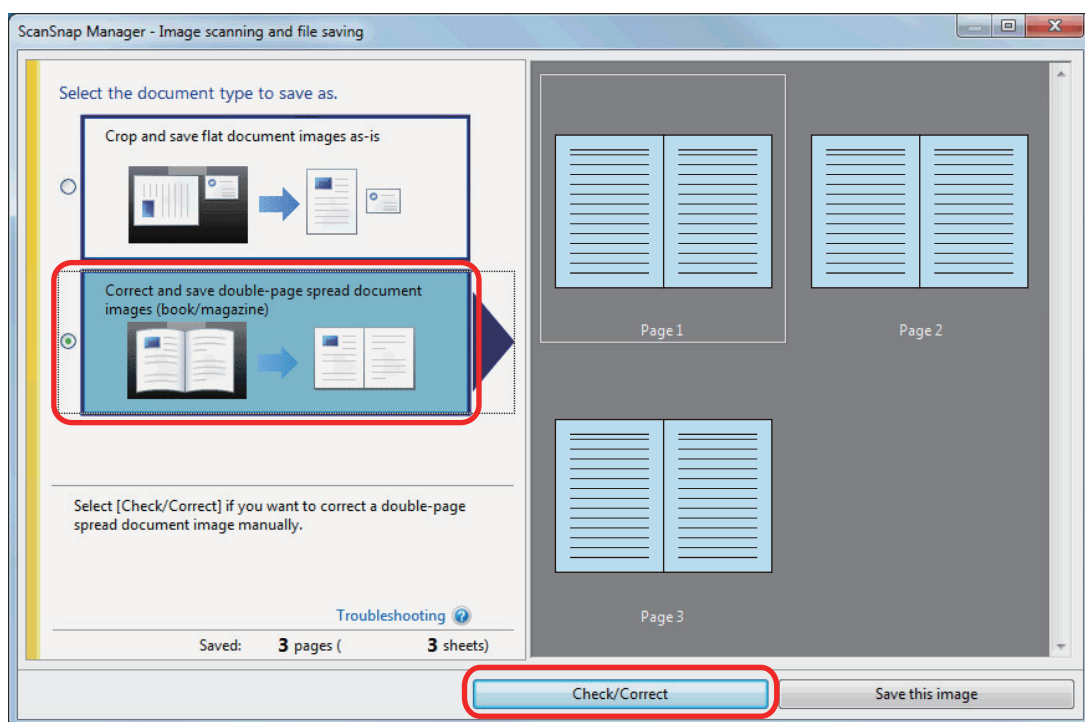

⇒ The [ScanSnap Manager - Book Image Viewer] window appears.

2. Select the page to correct the distortion in [Final image].



3. Click

⇒ The shape of the book is automatically detected, and the following items are displayed on the page:

- Corner points
Corner points are displayed around the corners of the book and both ends of the gutter.
- Outline
The shape of the book is indicated with a red dashed outline.

HINT



For the output format selection button, select .

4. On the page, drag the corner points to move the corners of the book and both ends of the gutter to any location.

On the front and back cover of the book, make the middle outline for the gutter parallel to the right and left outlines.

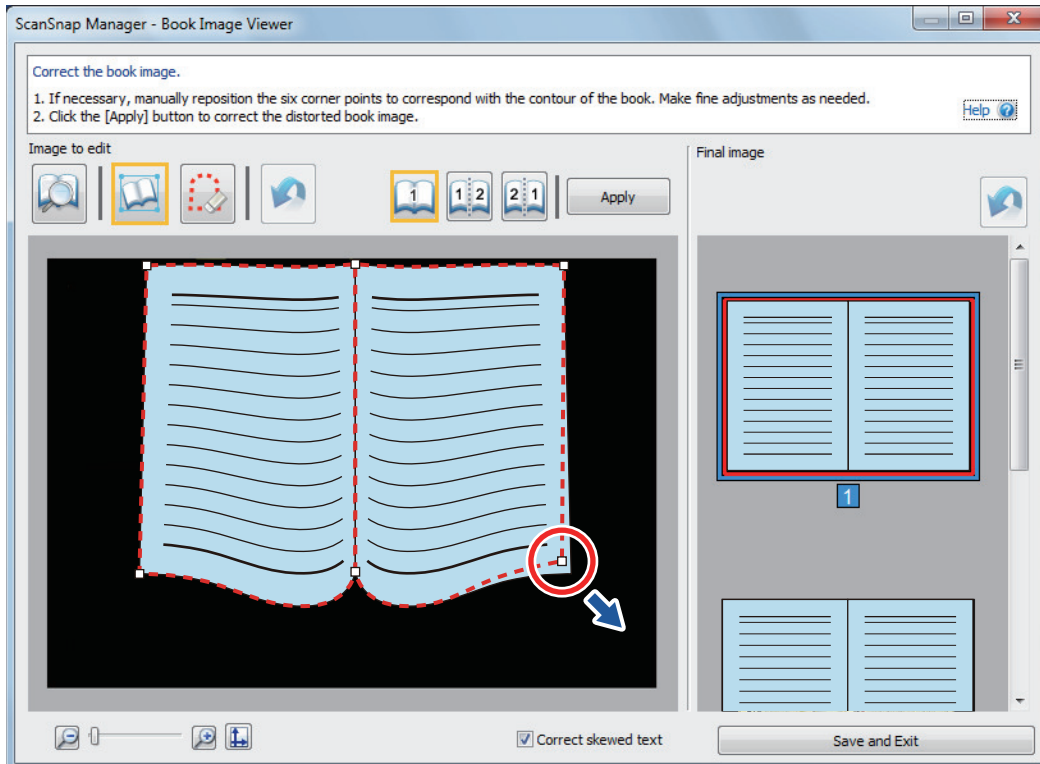

If the outline of the book is not aligned with the shape of the book in the scanned image, drag the upper part and lower part of the outline to correct each position.

HINT

If the shape of the book was not detected, the corner points and the outline are displayed on the entire window.

If this is the case, align the corner points and the outline with the shape of the book.

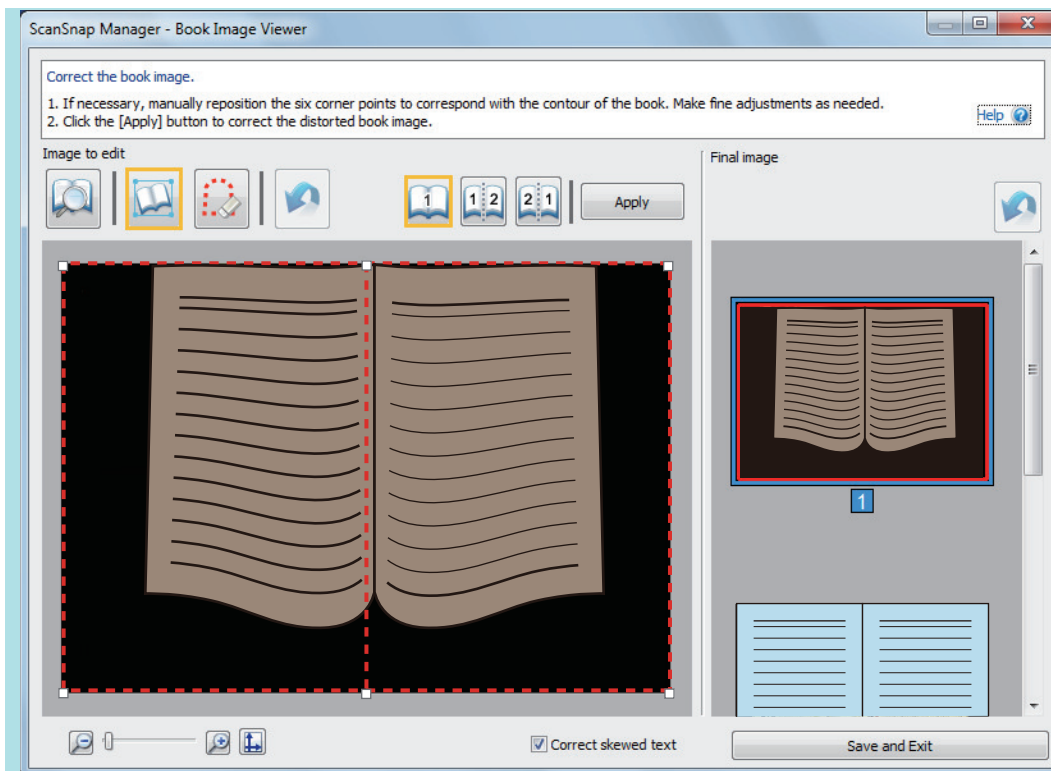

Follow the procedure below to modify the corner points and the outline.

1. Modify the corner points.

The corner points can be modified by either of the following:

- Double-click the position where you want to move the corner points.
 - ⇒ The corner points automatically move to the double-clicked position.
 - If the corner points cannot be modified properly, drag them to move.
- Drag the corner points to desired positions.

Modify the corner points at both ends of the gutter first and then the corners of the book.

2. Modify the outline.

Drag the outline to align it with the shape of the book. If it is hard to align the outline with the shape of the book, position the outline little by little.

To make it easy, click an outline near the corner points and drag and drop the outline to align it with the shape of the book repeatedly.

5. Click the [Apply] button.

⇒ A message for confirming the correction target appears.

6. Click the [Selected Pages] button.

⇒ The page distortion is corrected.

When you have completed correcting the page distortion, click the [Save and Exit] button.

HINT

- To correct another distorted page, select the page for which the distortion is to be corrected in [Final image], and repeat steps 2 to 6.
- When the text, lines, or graphics in the scanned image are horizontally skewed, clear the [Correct skewed text] checkbox.

When there are curved/slanted lines or graphics with curved/slanted lines on the document, the scanned image of the document may not be corrected properly and the layout may not look right.

Splitting a Double-Page Spread Image into Two Page Images (SV600)

The double-page spread image can be split into the right and left pages.

When a JPEG file is split, the file is divided into two files.

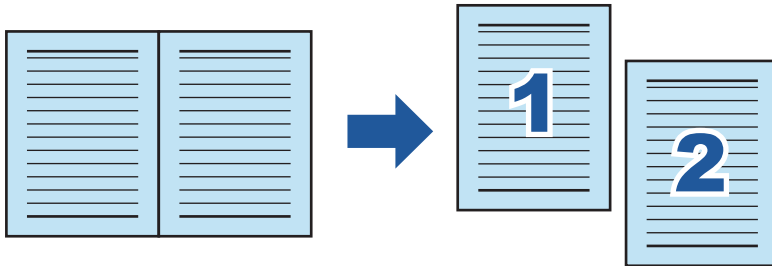

ATTENTION

Follow the procedure below to perform multiple book image correction for one page.



1. Edit in book image correction mode ().
 - Correcting a distorted book image
 - Splitting a double-page spread image



2. Edit in point retouch mode ().
 - Filling in the captured fingers in image

If you edit in the book image correction mode after editing in the point retouch mode, the edited results in point retouch mode are overridden.

- 1. On the window that appears after a book is scanned, select [Correct and save double-page spread document images (book/magazine)] and click the [Check/Correct] button.**

For details about how to perform a scan, refer to "[Scanning Books \(SV600\)](#)" (page 355).

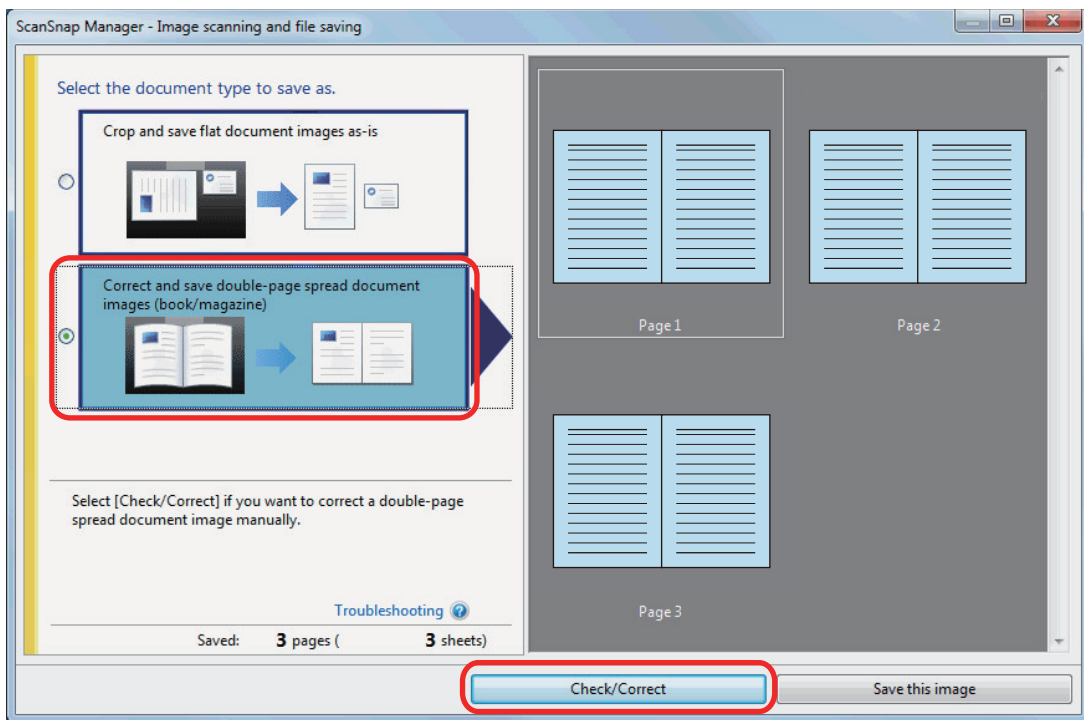

⇒ The [ScanSnap Manager - Book Image Viewer] window appears.

2. Select the page to be split in [Final image].



3. Click , and then click or .

⇒ The split line is indicated with a green dashed line.

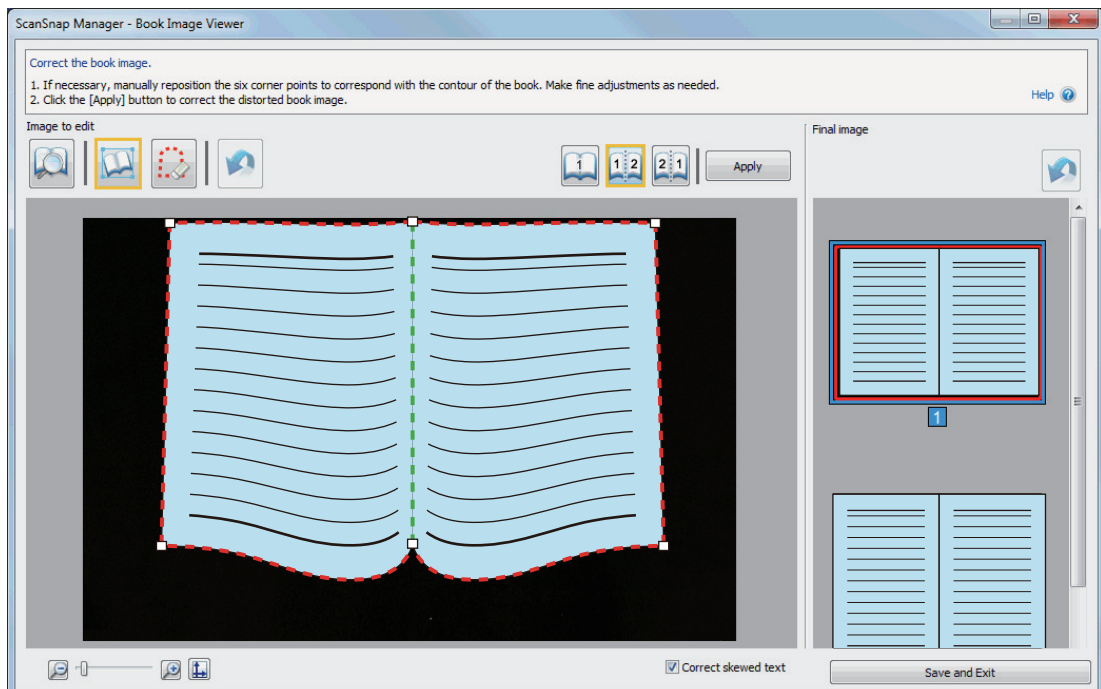

If the split line is not aligned with the gutter of the book, drag the corner points to correct the position.

4. Click the [Apply] button.

⇒ A message for confirming the split target appears.

5. Click the [Selected Pages] button.

⇒ The page is split.

When you have completed splitting the page, click the [Save and Exit] button.

Filling in Fingers Captured in a Scanned Image (When a Book Is Scanned)(SV600)

Fingers that are captured when a book is scanned can be filled in.

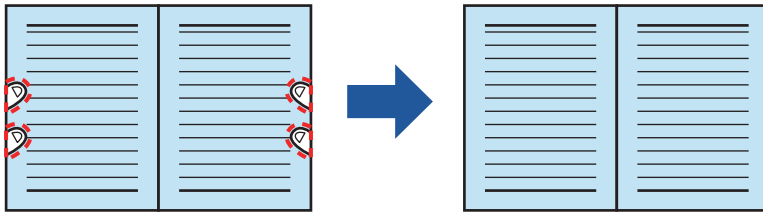

ATTENTION

- To fill in fingers captured in the scanned image, the fingers need to be detected.
- If a book is scanned in the following ways, captured fingers may not be detected correctly.
- When two or more fingers that are used to hold down a book to be scanned are touching each other (Figure 1)
 - When you hold down a book to be scanned with manicured fingers or fingers with artificial nails (Figure 2)
 - When you hold down a book to be scanned with your fingers bent (Figure 3)
 - When fingers that are used to hold down a book to be scanned are captured 1 cm (0.39 in.) or more (Figure 4)
 - When there is text or an image within 5 mm (0.2 in.) around the fingers that are used to hold down a book to be scanned (Figure 5)
 - When a book that has a background color other than white (such as a comic magazine) is scanned (Figure 6)
 - When a book is scanned after [Gray], [B&W], or [Color high compression] is selected from the [Color mode] drop-down list in the [Scanning] tab of the "ScanSnap Setup Window" (page 102)

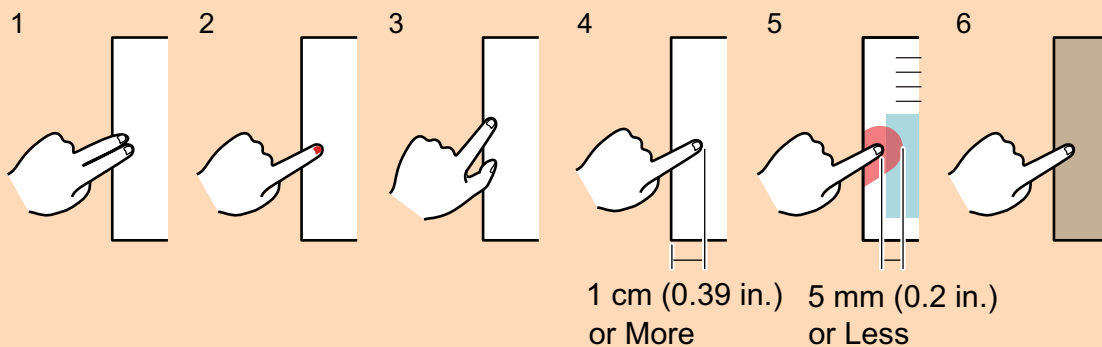

- Follow the procedure below to perform multiple book image correction for one page.



1. Edit in book image correction mode ().
 - Correcting a distorted book image
 - Splitting a double-page spread image



2. Edit in point retouch mode ().
 - Filling in the captured fingers in image

If you edit in the book image correction mode after editing in the point retouch mode, the edited results in point retouch mode are overridden.

HINT

- Up to five fingers on each side (right/left) can be filled in.
- To prevent image deterioration, select and fill in as many fingers as possible in one go.

1. On the window that appears after a book is scanned, select **[Correct and save double-page spread document images (book/magazine)]** and click the **[Check/Correct]** button.

For details about how to perform a scan, refer to "[Scanning Books \(SV600\)](#)" (page 355).

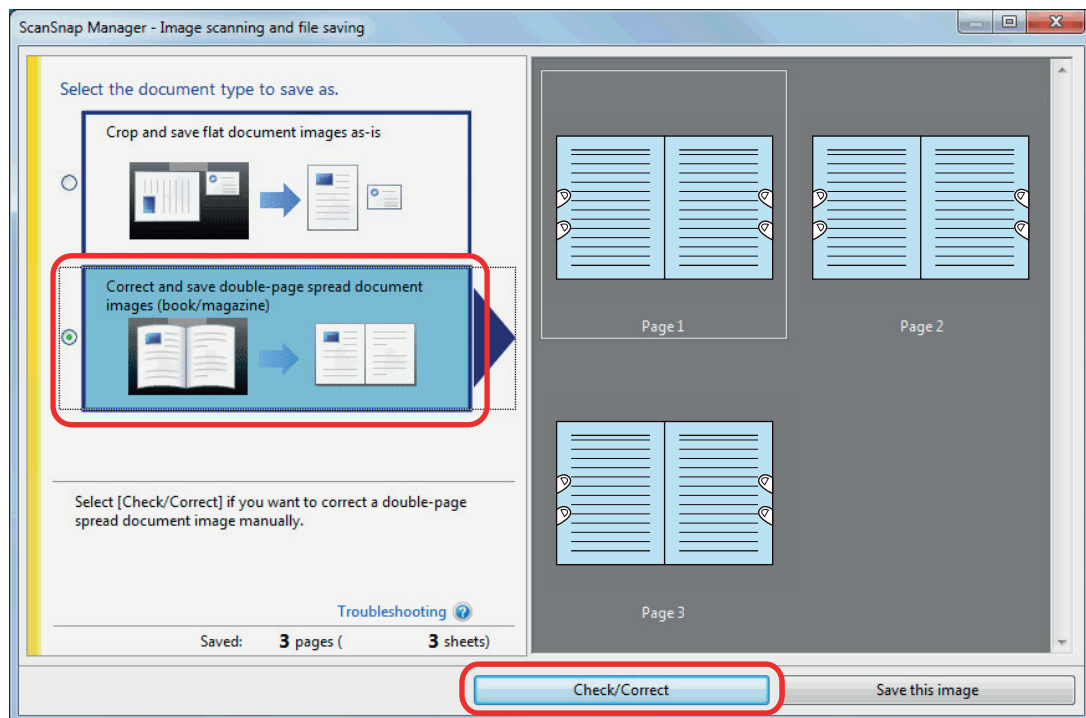

⇒ The [ScanSnap Manager - Book Image Viewer] window appears.

2. Select the page for filling in captured fingers in [Final image].



3. Click .

4. Click on a finger captured in a scanned image with the mouse.

⇒ When a finger is detected, it is indicated with a red dashed outline.

To change a range of the outline, drag the white dot on the outline.

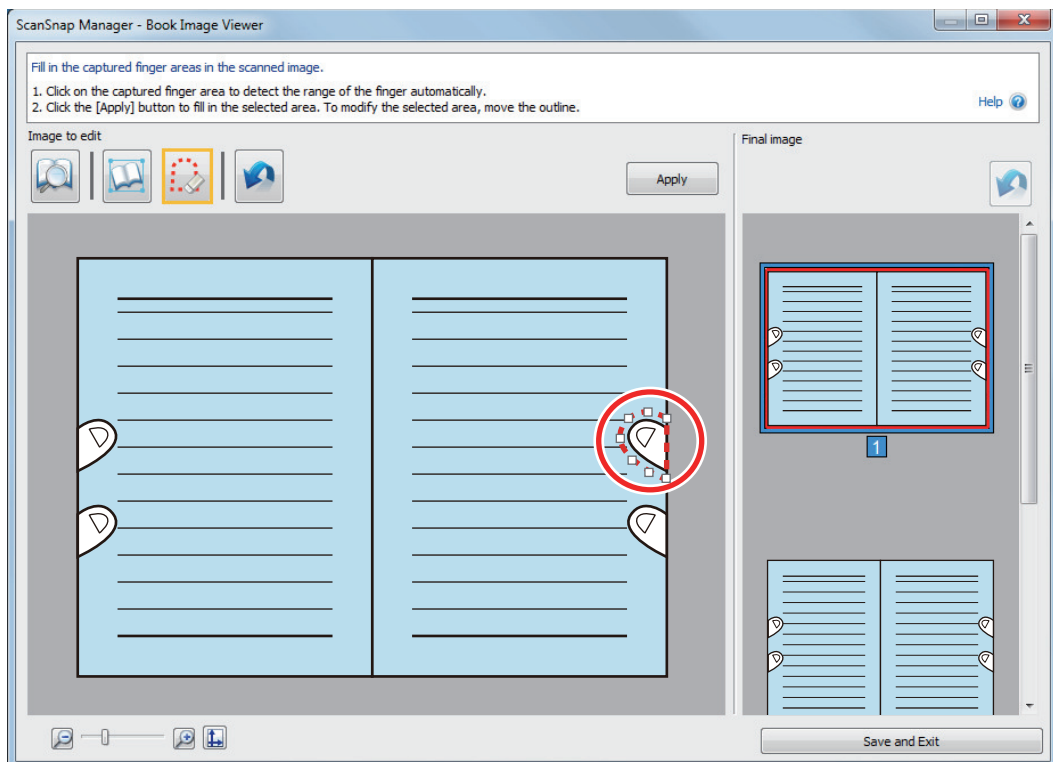

HINT

When a finger captured in a scanned image is not detected, a default outline is displayed around the finger.

In that case, drag the white dot on the outline to align the outline with the shape of the finger.

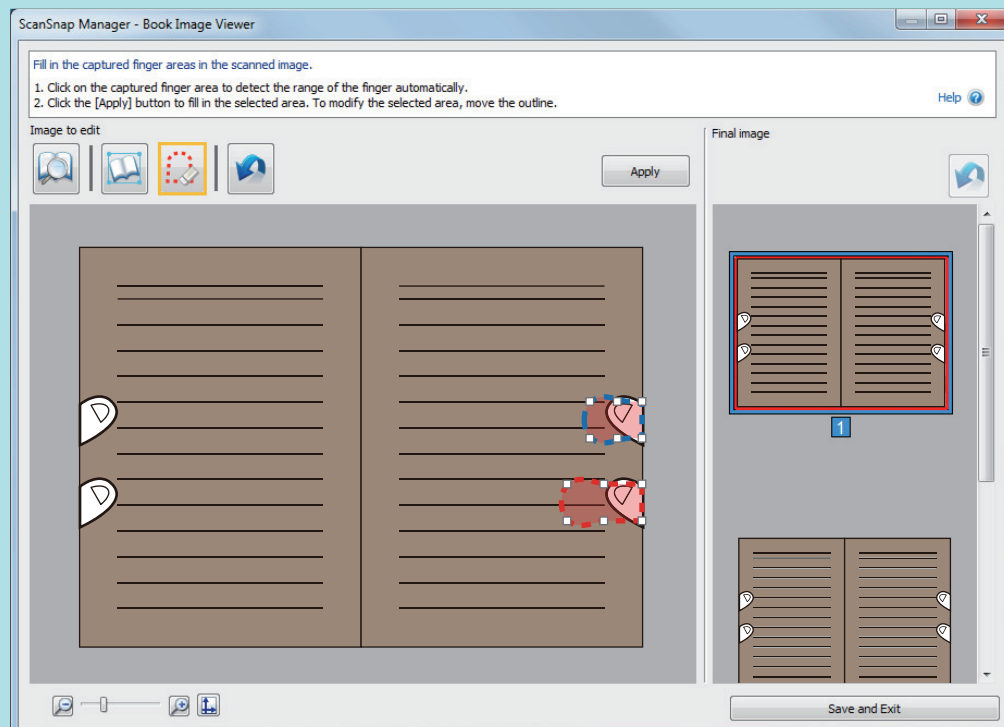

5. Click the [Apply] button.

⇒ The finger captured in a scanned image is filled in.

When you have completed filling in the captured finger, click the [Save and Exit] button.

When Multiple Documents Are Scanned at Once (SV600)

When multiple documents are scanned at once with the ScanSnap, the following corrections can be made on the scanned images:

- ["Correcting the Scanned Image Orientation \(SV600\)" \(page 477\)](#)
- ["Modifying the Crop Area \(SV600\)" \(page 480\)](#)
- ["Adding the Necessary Scanned Images \(SV600\)" \(page 482\)](#)
- ["Deleting Unnecessary Scanned Images \(SV600\)" \(page 484\)](#)

Correcting the Scanned Image Orientation (SV600)

The orientation of scanned images that are skewed or upside-down can be corrected.

- 1. On the window that appears after multiple documents are scanned at once, select [Crop and save flat document images as-is] and click the [Check/Correct] button.**

For details about how to perform a scan, refer to "[Scanning Multiple Documents at Once \(SV600\)](#)" (page 360).

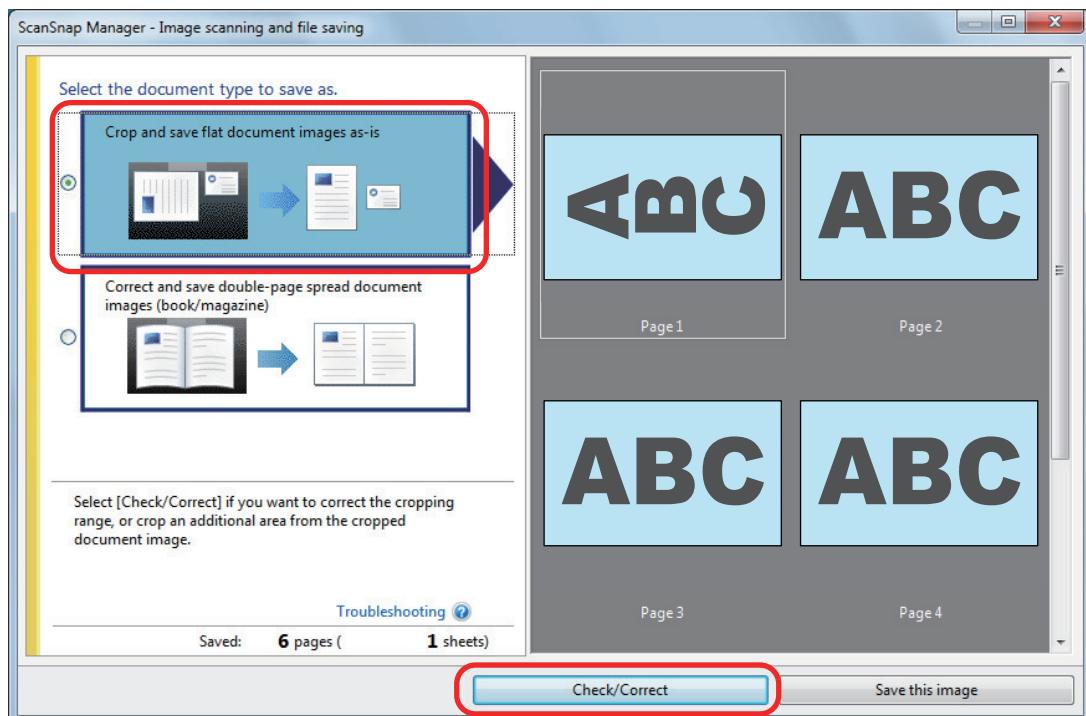

⇒ The [ScanSnap Manager - View cropped images] window is displayed.

- 2. Select which scanned image to correct the orientation for.**

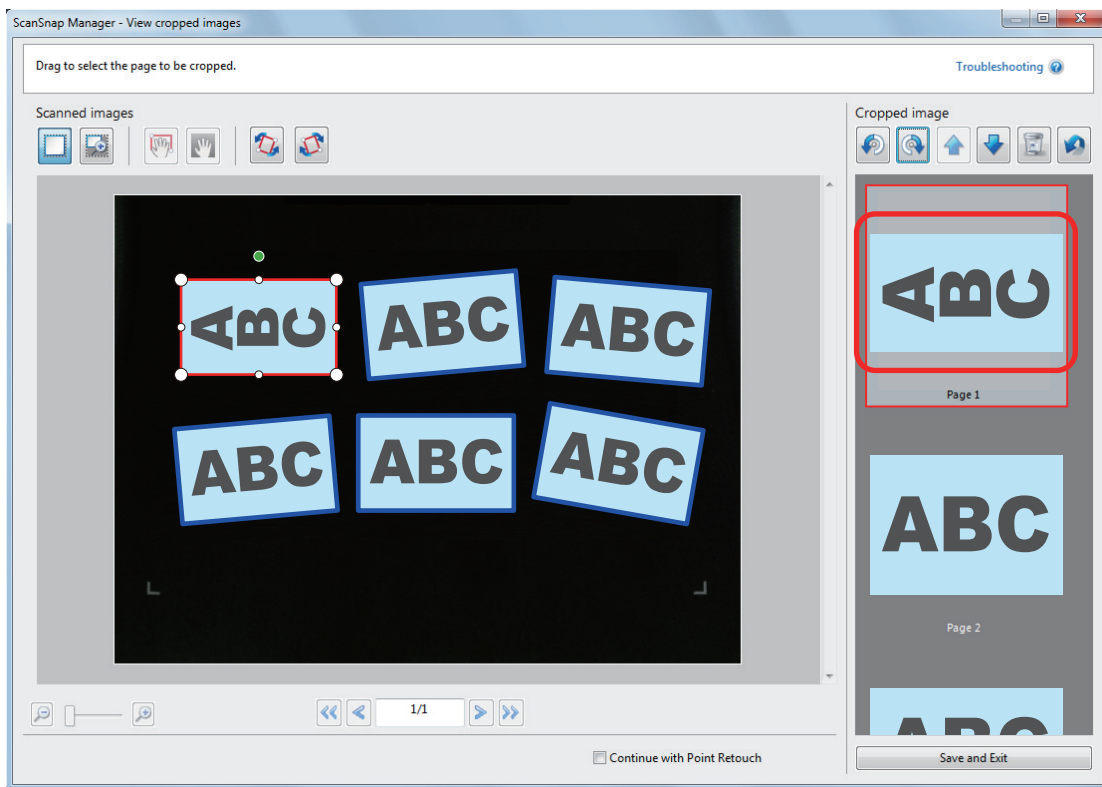

3. Click  or .

⇒ The scanned image is rotated by 90 degrees.

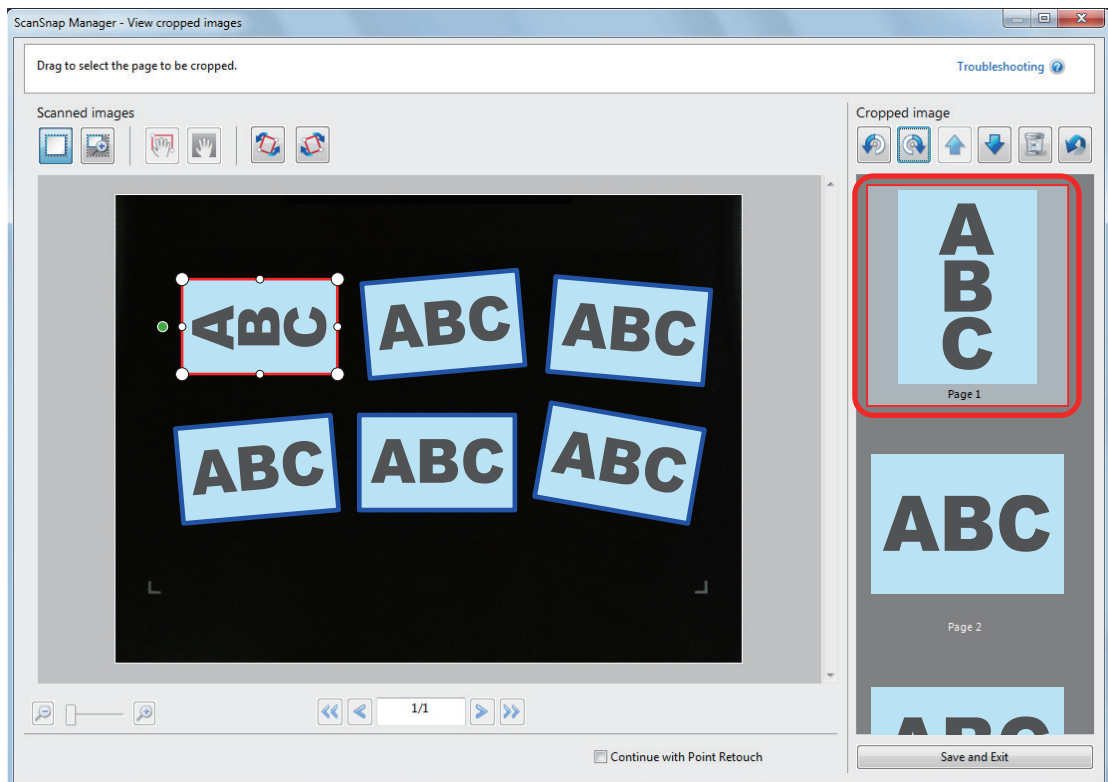



When you have completed correcting the orientation, click the [Save and Exit] button.

HINT

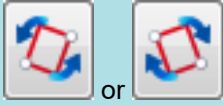
- To fine-tune the orientation of the crop frame, select which scanned image you want to rotate and then perform one of the following operations:
 - Drag the green operating point that appears at the top of the crop frame by as little or as much as you want.



- Click  or .
- If the [Next] button is displayed, clear the [Continue with Point Retouch] checkbox. The [Next] button changes to the [Save and Exit] button.

Modifying the Crop Area (SV600)

The size of the crop frame that is used to crop the scanned image can be modified.

- 1. On the window that appears after multiple documents are scanned at once, select [Crop and save flat document images as-is] and click the [Check/Correct] button.**

For details about how to perform a scan, refer to "[Scanning Multiple Documents at Once \(SV600\)](#)" (page 360).

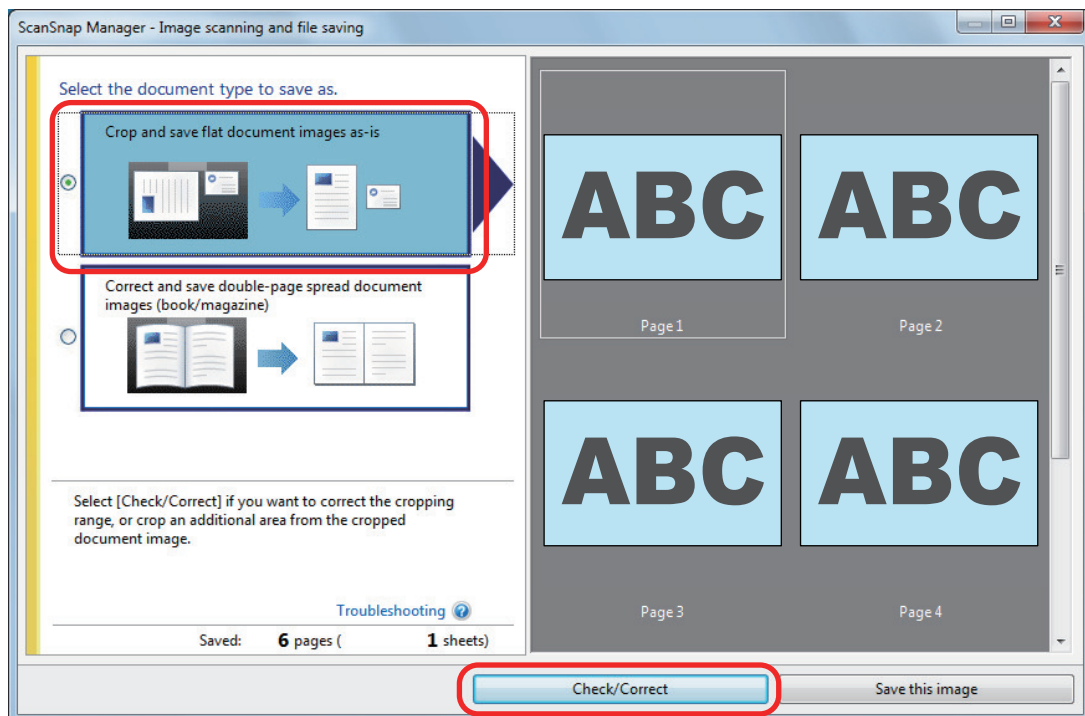

⇒ The [ScanSnap Manager - View cropped images] window is displayed.

- 2. Select the crop area of the scanned image to change the crop area.**
- 3. Drag the operating points of the crop frame to change the crop area.**

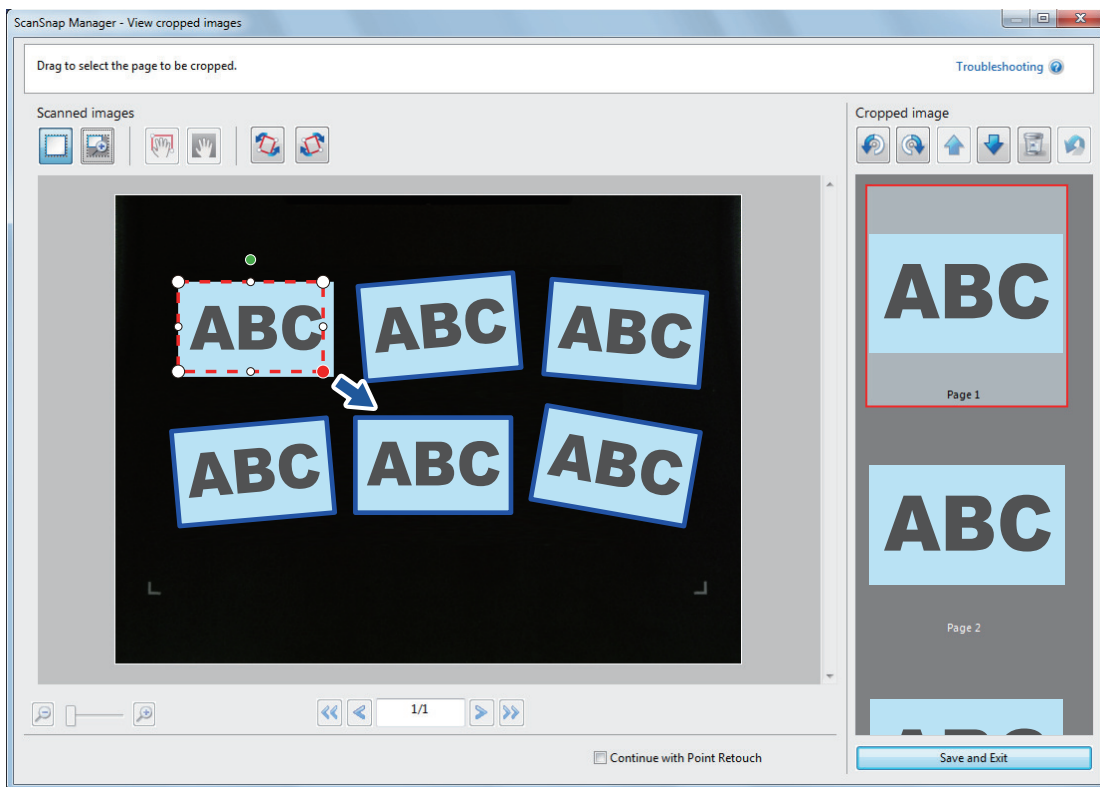

4. Click any position on the window.

⇒ The crop area is fixed.

When you have completed changing the crop area, click the [Save and Exit] button.

HINT

- To move a crop frame, place the mouse inside the crop frame and drag it when all the operating points have turned red.
- If the [Next] button is displayed, clear the [Continue with Point Retouch] checkbox. The [Next] button changes to the [Save and Exit] button.

Adding the Necessary Scanned Images (SV600)

If the necessary scanned images do not become the targets to be cropped, you can manually add them to the targets.

Up to 20 crop frames can be added for one scanned image.

- 1. On the window that appears after multiple documents are scanned at once, select [Crop and save flat document images as-is] and click the [Check/Correct] button.**

For details about how to perform a scan, refer to ["Scanning Multiple Documents at Once \(SV600\)" \(page 360\)](#).

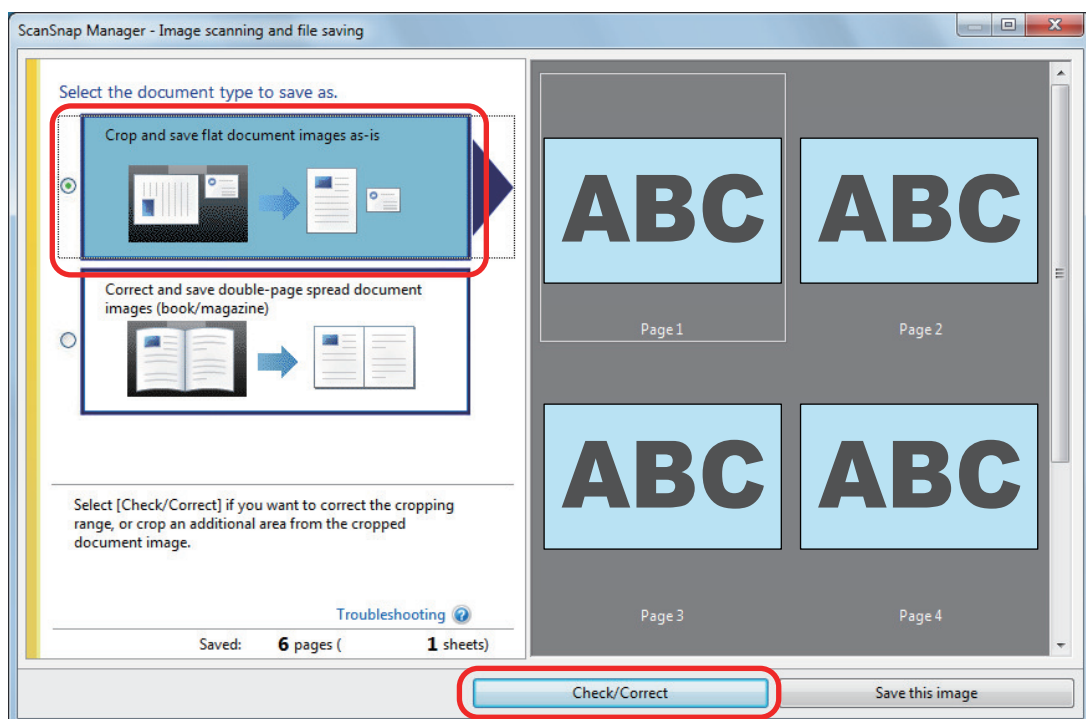

⇒ The [ScanSnap Manager - View cropped images] window is displayed.

- 2. Frame the scanned image to be cropped by dragging the mouse.**

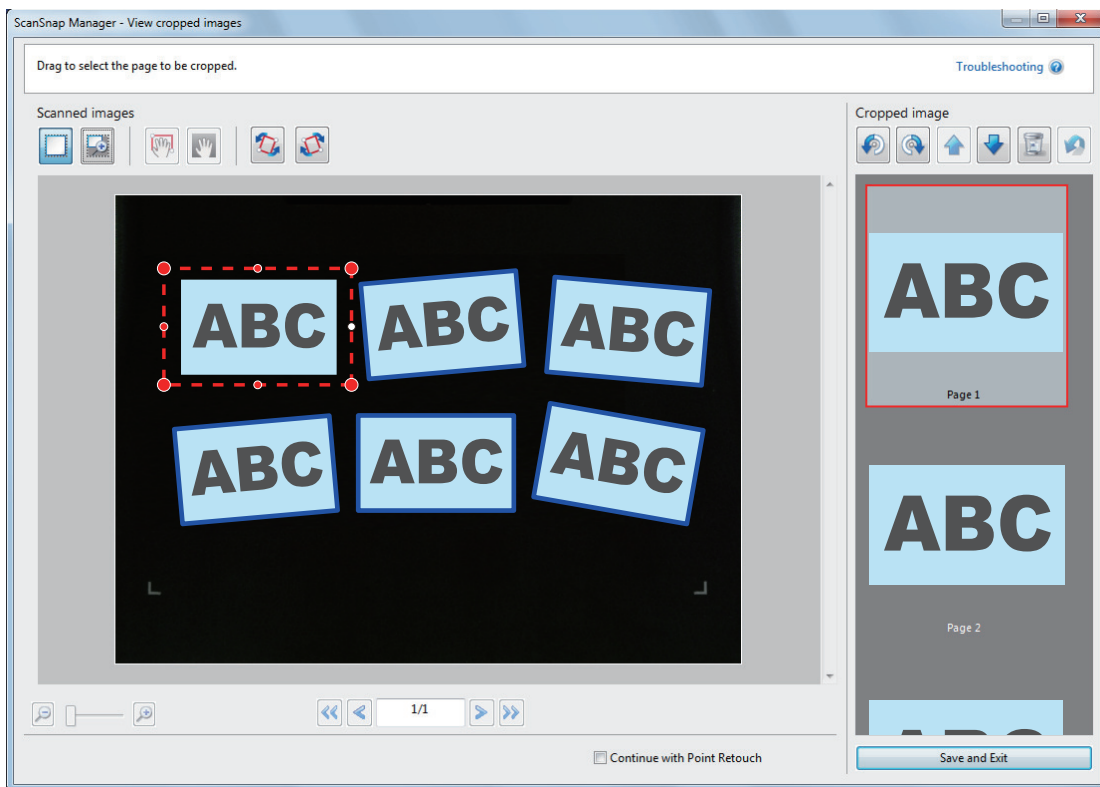

⇒ A crop frame is added to the scanned image that is automatically recognized, and the scanned image that was cropped by dragging the mouse is added to the end of [Cropped image].

After you have added a crop frame, click the [Save and Exit] button.

HINT

If the [Next] button is displayed, clear the [Continue with Point Retouch] checkbox. The [Next] button changes to the [Save and Exit] button.

Deleting Unnecessary Scanned Images (SV600)

When there are multiple scanned images, unnecessary crop frames can be deleted.

Scanned images without crop frames are not output and cannot be linked with an application.

- 1. On the window that appears after multiple documents are scanned at once, select [Crop and save flat document images as-is] and click the [Check/Correct] button.**

For details about how to perform a scan, refer to "[Scanning Multiple Documents at Once \(SV600\)](#)" (page 360).

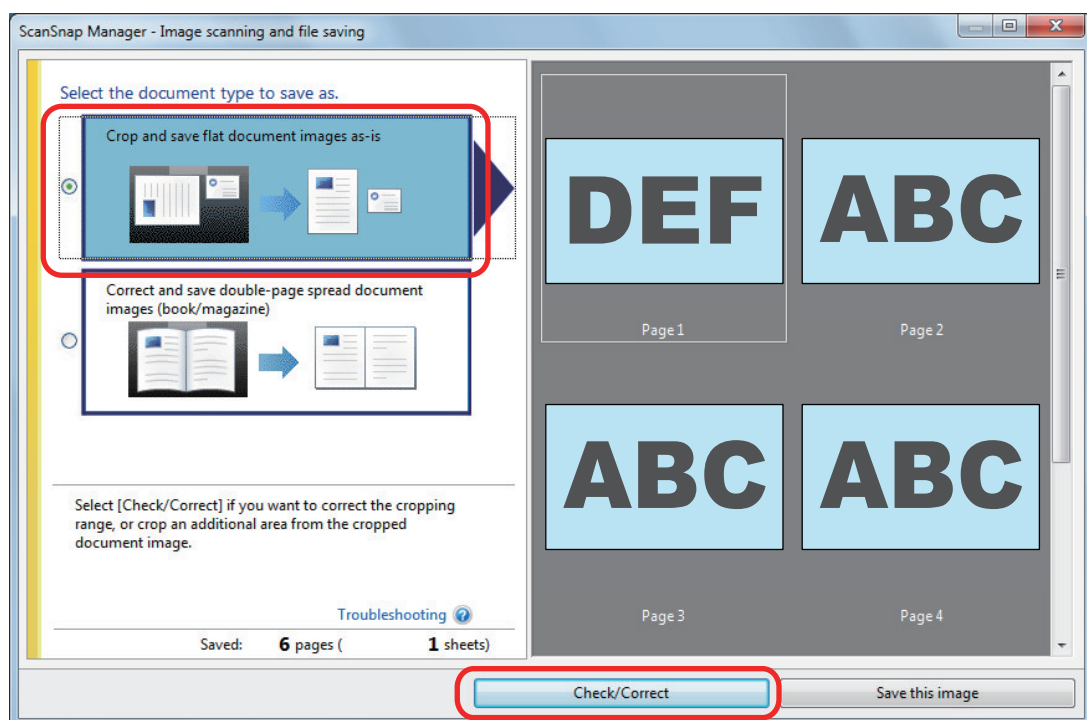

⇒ The [ScanSnap Manager - View cropped images] window is displayed.

- 2. Select a scanned image to remove the crop frame.**

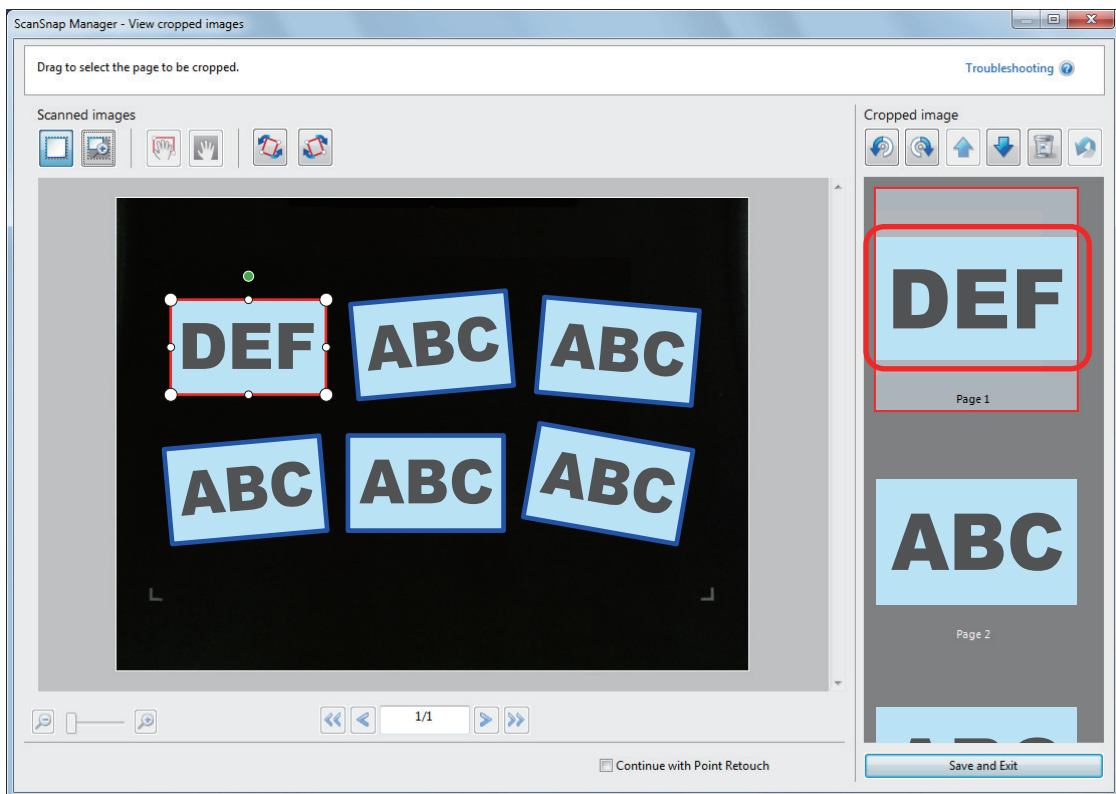

3. Click .

⇒ A confirmation message appears.

4. Click the [Yes] button.

⇒ The crop frame is removed from the selected scanned image, and the scanned image disappears from [Cropped image].

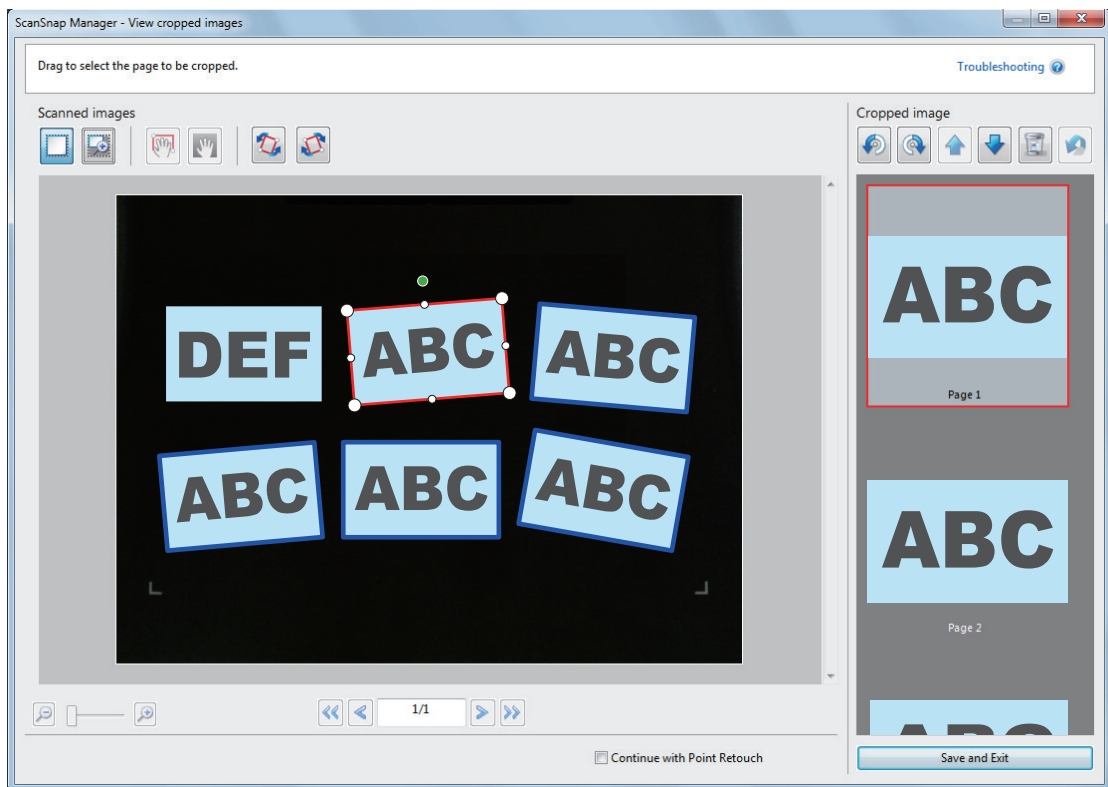

After you have removed the crop frame from the unnecessary scanned image, click the [Save and Exit] button.

HINT

If the [Next] button is displayed, clear the [Continue with Point Retouch] checkbox. The [Next] button changes to the [Save and Exit] button.

Uninstalling Software/Troubleshooting during Uninstallation

This section explains how to solve troubles you may encounter upon installing or uninstalling the following software related to the ScanSnap.

- ScanSnap Manager
- ScanSnap Organizer
- CardMinder

For ScanSnap Home, refer to "Troubleshooting" in the [ScanSnap Manager Help](#).

For details about the troubles you may encounter and the solutions while using the ScanSnap, refer to the following:

- "Troubleshooting" in the ScanSnap Manager Help

To display this section, right-click the ScanSnap Manager icon  in the notification area, and select [Help] → [Troubleshooting] from the "Right-Click Menu" (page 100).

- ScanSnap Support Site (<https://scansnap.fujitsu.com/g-support/en/>)

If you cannot solve the problem after referring to the above section, contact your FUJITSU scanner dealer or an authorized FUJITSU scanner service provider.

- "How to Find Your Solution" (page 488)
- "If Your First Attempt to Install Failed" (page 489)
- "If You Have Installed the Software Before" (page 490)
- "Cannot Connect to the ScanSnap even after the Installation Has Been Complete (iX1600 / iX1500)" (page 494)
- "When the ScanSnap Manager Icon Does Not Appear" (page 495)
- "When ScanSnap Manager Does Not Operate Normally" (page 497)
- "When You Cannot Uninstall the Software" (page 505)

How to Find Your Solution

When software installation fails, or the ScanSnap does not operate normally after installation is complete, refer to the flow chart below for troubleshooting.

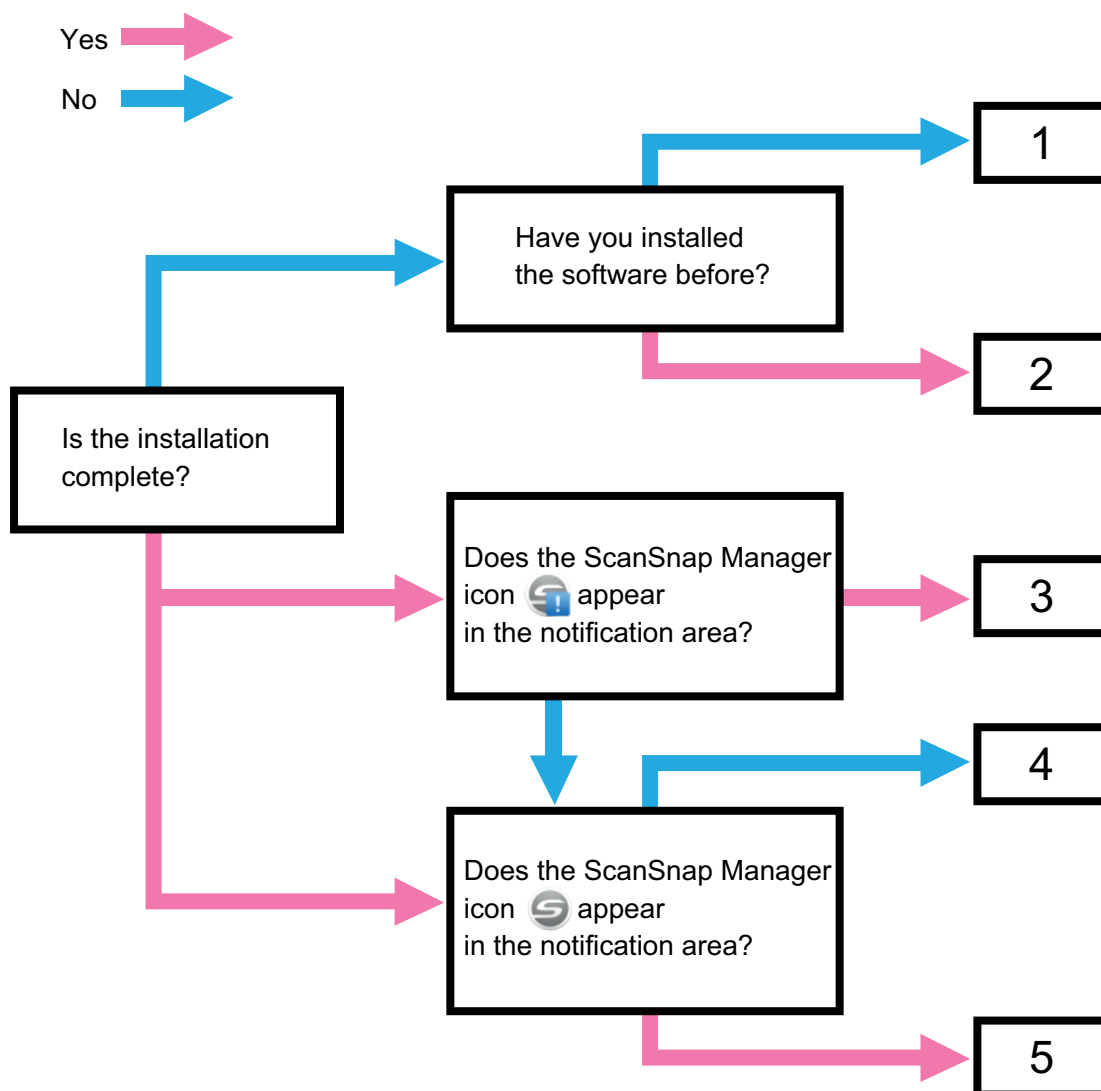

No.	Topic to Be Referred to
1	"If Your First Attempt to Install Failed" (page 489)
2	"If You Have Installed the Software Before" (page 490)
3	"Cannot Connect to the ScanSnap even after the Installation Has Been Complete (iX1600 / iX1500)" (page 494)
4	"When the ScanSnap Manager Icon Does Not Appear" (page 495)
5	"When ScanSnap Manager Does Not Operate Normally" (page 497)

If Your First Attempt to Install Failed

This section explains how to troubleshoot when the first attempt to install the software related to the ScanSnap failed.

If any software related to the ScanSnap has been installed before, refer to ["If You Have Installed the Software Before"](#) (page 490).

- 1. Restart the computer and log on as a user with Administrator privileges.**
- 2. Reinstall the software.**

For details, refer to ["Reinstalling the Software"](#) (page 493).

If You Have Installed the Software Before

This section explains how to troubleshoot if your attempt to reinstall the software related to the ScanSnap failed.

- ["Uninstalling the Software" \(page 491\)](#)
- ["Removing the Installation Information" \(page 492\)](#)
- ["Reinstalling the Software" \(page 493\)](#)

Uninstalling the Software

Uninstall the software that is already installed.

The uninstallation procedure is as follows.

- 1. If the ScanSnap is connected to the computer, unplug the USB cable from the computer.**
- 2. Log on as a user with Administrator privileges.**
- 3. If security software is running, stop it temporarily.**

ATTENTION

If you cannot stop the security software, make sure that the setting on the security software is not set to lock an application.

- 4. Uninstall the software.**

The following software programs must be uninstalled:

- ScanSnap Manager
- ScanSnap Home
- ScanSnap Organizer
- CardMinder

For details, refer to "[Uninstalling the Software](#)" (page 587).

- If the software was successfully uninstalled, proceed to "[Reinstalling the Software](#)" (page 493).
- If the software still remains in the list, proceed to the next topic "[Removing the Installation Information](#)" (page 492).

Removing the Installation Information

If the name of the software that you tried to uninstall still remains in the list in [Programs and Features] of the Control Panel, or if the software cannot be uninstalled for some reason, use the uninstall tool (SSHomeClean.exe) to remove the installation information.

For details on how to use the uninstall tool and details on the existing software which is to be uninstalled, run a search for "SSHomeClean.exe" in [ScanSnap FAQ](#), click the appropriate link that is listed in the search results, and refer to the webpage.

Before you run the uninstall tool, read "Installation Information Cleanup Guide for ScanSnap Home" that is on the displayed webpage.

Reinstalling the Software

Once the software is uninstalled or the installation information is removed, reinstall the software. Install the software in the following procedure.

- 1. Restart the computer.**
- 2. Log on as a user with Administrator privileges.**
- 3. If security software is running, stop it temporarily.**

ATTENTION

If you cannot stop the security software, make sure that the setting on the security software is not set to lock an application.

- 4. Access the download web pages of the software programs.**
ScanSnap Software Downloads
<https://scansnap.fujitsu.com/global/dl/>
- 5. Select your model and operating system and click [Display software list] to display the list of software programs to be installed.**
- 6. Download a software program from the software list that is displayed in [Those using ScanSnap Manager] in [Setup Programs] and install it.**

If you did not perform the procedure in "Removing the Installation Information" (page 492) and then failed to install the software, perform the following procedures again:



- "Uninstalling the Software" (page 491)
- "Removing the Installation Information" (page 492)
- "Reinstalling the Software" (page 493)

Cannot Connect to the ScanSnap even after the Installation Has Been Complete (iX1600 / iX1500)

If the ScanSnap Manager icon in the notification area is , configuring the settings of the ScanSnap on the touch panel may not be complete.

Configure the settings of the ScanSnap by following the instructions on the touch panel.

- 1. Select a display language for the touch panel and press the [Next] button.**
- 2. Select a startup mode on the [Startup Mode] screen and press the [Next] button.**

⇒ The ScanSnap is connected to a computer and the ScanSnap Manager icon in the notification area located at the far right of the taskbar changes from  to .

When the ScanSnap Manager Icon Does Not Appear

This section explains how to troubleshoot when the ScanSnap Manager icon  does not appear in the notification area even though the software is installed and the ScanSnap is connected to the computer.

- ["Displaying the ScanSnap Manager Icon" \(page 496\)](#)

Displaying the ScanSnap Manager Icon

1. Start ScanSnap Manager.

- Windows 10
Select [Start] menu → [ScanSnap Manager] → [ScanSnap Manager].
- Windows 8.1
Click  on the lower left side of the Start screen, and select [ScanSnap Manager] under [ScanSnap Manager] on the All apps screen.
- Windows 7
Select [Start] menu → [All Programs] → [ScanSnap Manager] → [ScanSnap Manager].

HINT

If the problem is solved, you can change the setting so that ScanSnap Manager will start up automatically from the next time you log on to the computer. The procedure is as follows.

1. Right-click the ScanSnap Manager icon  in the notification area located at the far right of the task bar and select [Preferences] from the "Right-Click Menu" (page 100).
⇒ The [ScanSnap Manager - Preferences] window appears.
2. In the [Auto Startup] list, select the [Start up ScanSnap Manager when you log on] checkbox.

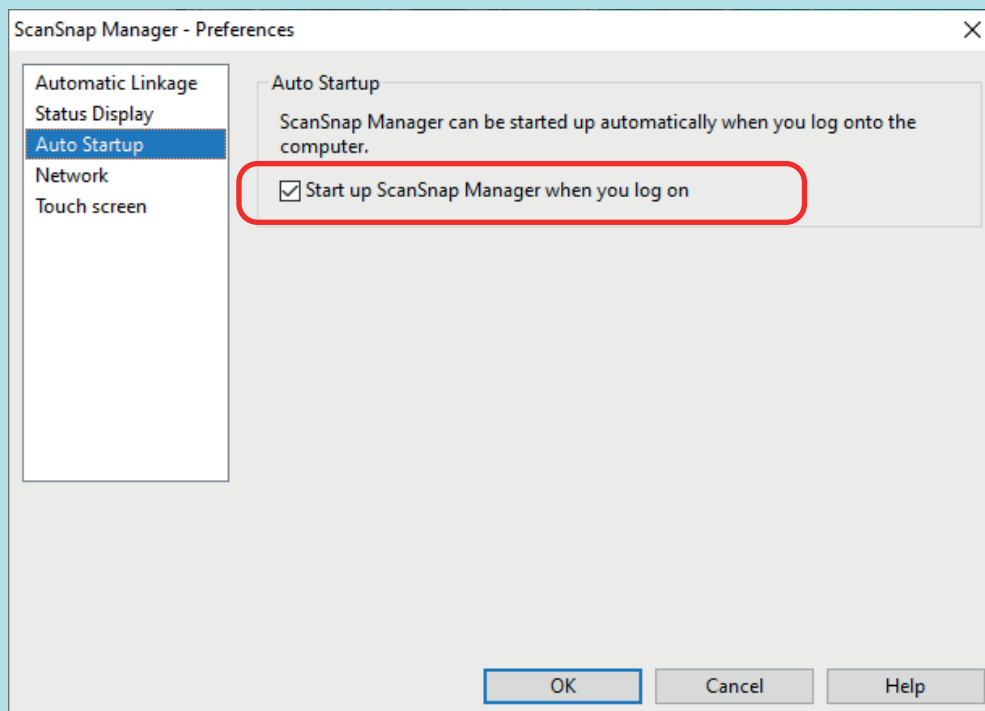

Example: iX1600

If the problem persists, refer to "When ScanSnap Manager Does Not Operate Normally" (page 497).

When ScanSnap Manager Does Not Operate Normally

If the ScanSnap Manager icon in the notification area located at the far right of the taskbar is

displayed as  even though the software is installed and the ScanSnap is connected to the computer, perform the following procedures.

- ["Removing Unnecessary Icons from the Notification Area" \(page 498\)](#)
- ["Checking the Connection between the ScanSnap and the Computer" \(page 499\)](#)
- ["Checking If ScanSnap Manager Is Operating Normally" \(page 500\)](#)
- ["Removing the ScanSnap's Connection Information" \(page 503\)](#)

Removing Unnecessary Icons from the Notification Area

1. Check the software icons in the notification area, and exit the software that you are not using.

⇒ The icon is removed from the notification area.

2. Right-click the ScanSnap Manager icon in the notification area and select [Exit] from the "Right-Click Menu" (page 100).

3. Start ScanSnap Manager.

- Windows 10

Select [Start] menu → [ScanSnap Manager] → [ScanSnap Manager].

- Windows 8.1

Click  on the lower left side of the Start screen, and select [ScanSnap Manager] under [ScanSnap Manager] on the All apps screen.

- Windows 7

Select [Start] menu → [All Programs] → [ScanSnap Manager] → [ScanSnap Manager].

If the problem persists, refer to "[Checking the Connection between the ScanSnap and the Computer](#)" (page 499).

Checking the Connection between the ScanSnap and the Computer

- 1. Unplug the USB cable from the computer and the ScanSnap, then plug it back in.**

Make sure to leave at least 5 seconds between unplugging and plugging the cable.

If you are using a USB hub, connect the USB cable to the computer directly.

If the problem persists, refer to "[Checking If ScanSnap Manager Is Operating Normally](#)" (page 500).

Checking If ScanSnap Manager Is Operating Normally

1. Turn off the ScanSnap and then turn it on again.

Make sure to leave at least 5 seconds between turning off and on the ScanSnap.

If the problem persists, proceed to step 2.

2. If you are using a USB hub, connect the ScanSnap to the computer directly with a USB cable.

If the problem persists, proceed to step 3.

3. If there is more than one USB port on the computer, connect the USB cable to a different USB port.

If the problem persists, proceed to step 4.

4. If a USB device other than the ScanSnap is connected to the computer, disconnect it.

If the problem persists, proceed to step 5.

5. If security software is running, stop it temporarily.

ATTENTION

If you cannot stop the security software, make sure that the setting on the security software is not set to lock an application.

If the problem persists, proceed to step 6.

6. Check the privileges to access the installation files.

1. Start the ScanSnap Support Tool.

- Windows 10

Select [Start] menu → [ScanSnap Manager] → [ScanSnap Support Tool].

- Windows 8.1

Click  on the lower left side of the Start screen, and select [ScanSnap Support Tool] under [ScanSnap Manager] on the All apps screen.

- Windows 7

Select [Start] menu → [All Programs] → [ScanSnap Manager] → [ScanSnap Support Tool].

⇒ The [ScanSnap Support Tool] window appears.

2. Click the [Check] button on the [Recover] tab, and proceed by following the instructions displayed on the screen.

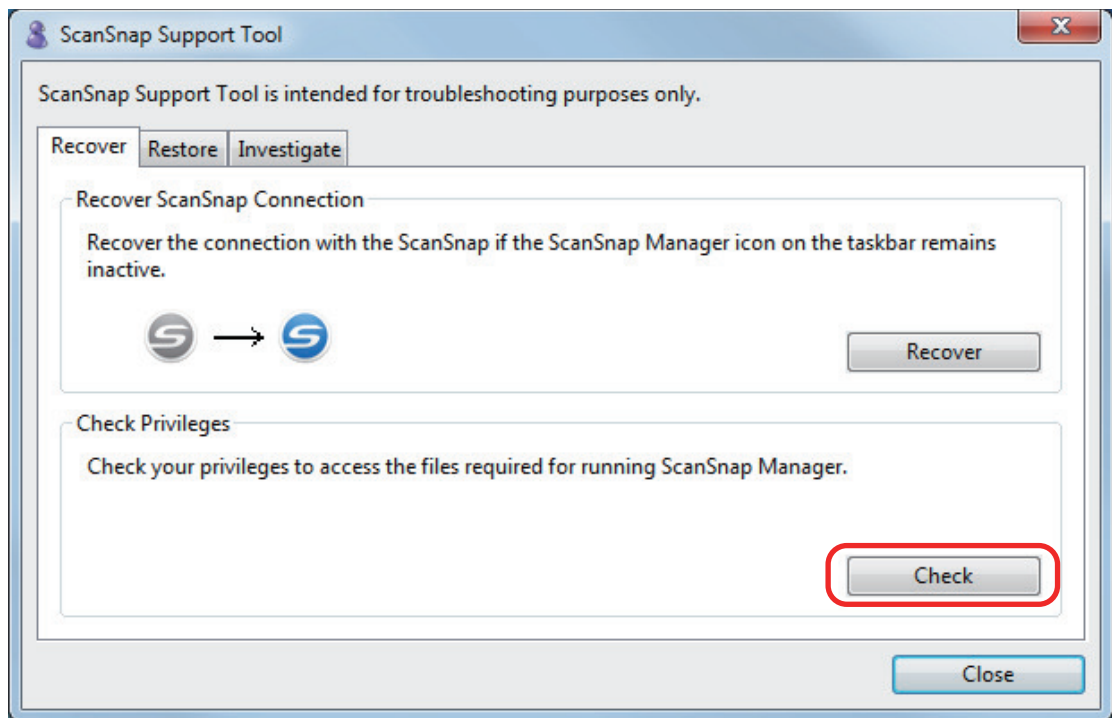

⇒ If the message "The recommended privileges have been applied." appears, turn off the ScanSnap and then turn it on again. Make sure to leave at least 5 seconds between turning off and on the ScanSnap.

If the message "Failed to change the privileges. Uninstall ScanSnap Manager then install it again." appears or the problem still persists, proceed to step 7.

7. Recover the connection with the ScanSnap.

1. Start the ScanSnap Support Tool.

- Windows 10

Select [Start] menu → [ScanSnap Manager] → [ScanSnap Support Tool].

- Windows 8.1

Click  on the lower left side of the Start screen, and select [ScanSnap Support Tool] under [ScanSnap Manager] on the All apps screen.

- Windows 7

Select [Start] menu → [All Programs] → [ScanSnap Manager] → [ScanSnap Support Tool].

⇒ The [ScanSnap Support Tool] window appears.

2. Click the [Recover] button on the [Recover] tab, and proceed by following the instructions displayed on the screen.

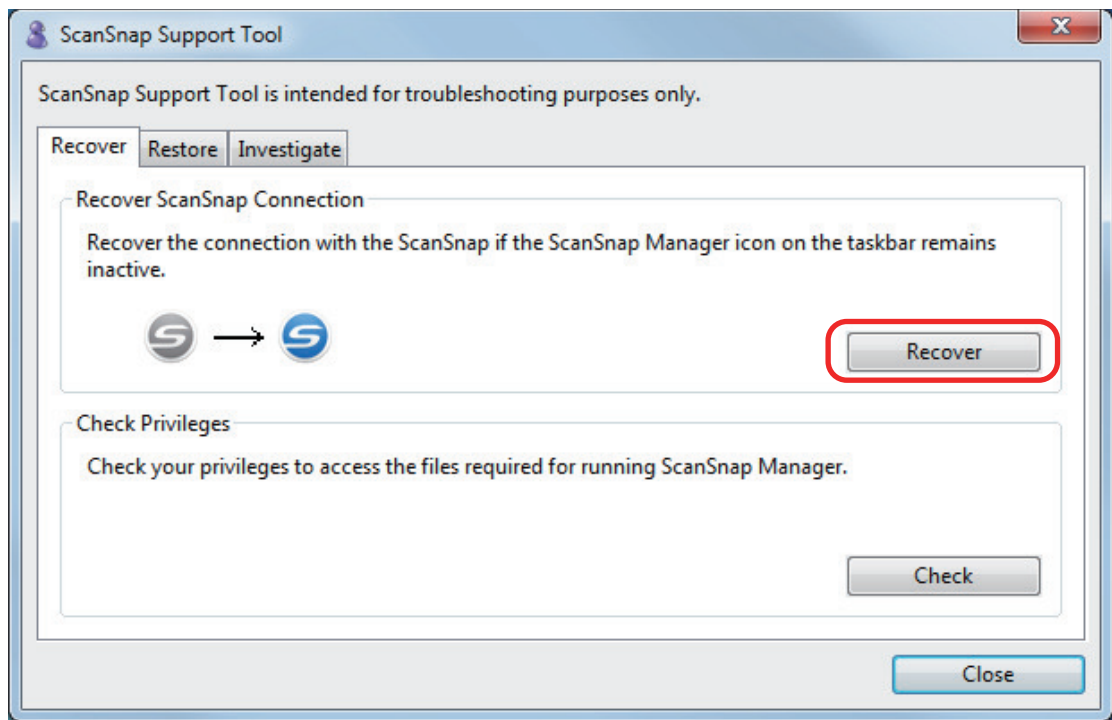

8. Turn off the ScanSnap and restart the computer.

If the problem persists, refer to ["Removing the ScanSnap's Connection Information"](#) (page 503).

Removing the ScanSnap's Connection Information

The ScanSnap might have been connected to the computer before the software was installed. In this case, the ScanSnap's connection information needs to be removed. Remove the ScanSnap's connection information in the following procedure.

1. Connect the ScanSnap to the computer, and turn on the ScanSnap.

2. Open Device Manager.

- Windows 10

Right-click the [Start] menu and select [Device Manager].

- Windows 8.1

Click  on the lower left side of the Start screen → [Control Panel] under [Windows System] → [Hardware and Sound] → [Device Manager].

- Windows 7

Select [Start] menu → [Control Panel] → [Hardware and Sound] → [Device Manager].

3. Remove the connection information.

- iX1600

Select [Imaging devices] and right-click on [ScanSnap iX1600] (or [Other devices] → [ScanSnap iX1600]), and then select [Uninstall] from the displayed menu.

- iX1500

Select [Imaging devices] and right-click on [ScanSnap iX1500] (or [Other devices] → [ScanSnap iX1500]), and then select [Uninstall] from the displayed menu.

- iX1400

Select [Imaging devices] and right-click on [ScanSnap iX1400] (or [Other devices] → [ScanSnap iX1400]), and then select [Uninstall] from the displayed menu.

- iX1300

Select [Imaging devices] and right-click on [ScanSnap iX1300] (or [Other devices] → [ScanSnap iX1300]), and then select [Uninstall] from the displayed menu.

- iX500

Select [Imaging devices] and right-click on [ScanSnap iX500] (or [Other devices] → [ScanSnap iX500]), and then select [Uninstall] from the displayed menu.

- iX100

Select [Imaging devices] and right-click on [ScanSnap iX100] (or [Other devices] → [ScanSnap iX100]), and then select [Uninstall] from the displayed menu.

- SV600

Select [Imaging devices] and right-click on [ScanSnap SV600] (or [Other devices] → [ScanSnap SV600]), and then select [Uninstall] from the displayed menu.

- S1300i

Select [Imaging devices] and right-click on [ScanSnap S1300i] (or [Other devices] → [ScanSnap S1300i]), and then select [Uninstall] from the displayed menu.

- S1100i

Select [Imaging devices] and right-click on [ScanSnap S1100i] (or [Other devices] → [ScanSnap S1100i]), and then select [Uninstall] from the displayed menu.

4. If other USB ports have been used to connect to the ScanSnap, perform steps 1 to 3 for each of the ports.

5. Turn off the ScanSnap.

6. Unplug the USB cable from the computer.

7. Restart the computer.

8. Connect the USB cable to the computer.

9. Turn on the ScanSnap.

⇒ The ScanSnap Manager icon appears in the notification area. Make sure that the displayed

icon is .

If the problem persists, refer to ["If You Have Installed the Software Before"](#) (page 490).

If the problem still persists, perform the procedures described in ["When ScanSnap Manager Does Not Operate Normally"](#) (page 497) once again.

If the above procedures do not solve the problem, please attach the data of your system information to an email and send it to your FUJITSU scanner dealer or an authorized FUJITSU scanner service provider. For details about how to collect system information, refer to "Troubleshooting" in the ScanSnap Manager Help.

When You Cannot Uninstall the Software

This section explains how to troubleshoot when you cannot uninstall the following software programs:

- ScanSnap Manager
- ScanSnap Home
- ScanSnap Organizer
- CardMinder
- ScanSnap Online Update

1. Restart the computer and log on as a user with Administrator privileges.

2. Remove the installation information.

⇒ For details, refer to "[Removing the Installation Information](#)" (page 492).

3. Install the software.

⇒ For details, refer to "[Reinstalling the Software](#)" (page 493).

4. Uninstall the software.



⇒ For details, refer to "[Uninstalling the Software](#)" (page 587).

Cleaning the ScanSnap

- "Cleaning Materials" (page 507)
- "Cleaning iX1600 / iX1500 / iX1400" (page 508)
- "Cleaning iX1300" (page 517)
- "Cleaning iX500" (page 524)
- "Cleaning iX100" (page 530)
- "Cleaning SV600" (page 535)
- "Cleaning S1300i" (page 536)
- "Cleaning S1100i" (page 542)
- "Cleaning the Carrier Sheet (iX1600 / iX1500 / iX1400 / iX1300 / iX500/ iX100 / S1100i)" (page 547)
- "Cleaning the Background Pad (SV600)" (page 548)

Cleaning Materials

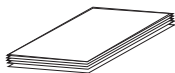
Cleaning materials and their part numbers are as below.

Product Name	Part No.	Unit	Note
Cleaner F1 	PA03950-0352	1 bottle	Size: 100 ml
Cleaning Paper (*1) 	CA99501-0012	1 pack	10 sheets
Cleaning Wipe (*2) 	PA03950-0419	1 pack	24 packets
Lint-free dry cloth (*3)	Commercially available	-	-
Cotton swabs	Commercially available	-	Used to clean small parts such as the camera or infrared LED on SV600.

*1: Used with Cleaner F1.

*2: The cleaning wipes are wet tissues that have been soaked with Cleaner F1. In place of this product, you can use a cloth soaked with Cleaner F1.

*3: Any lint-free cloth can be used.

For details about purchasing the cleaning materials, refer to "Suppliers of Consumables/Optional Parts" in ["About Customer Support and Maintenance"](#) (page 606).

Cleaning iX1600 / iX1500 / iX1400

This section explains about the cleaning materials and how to clean the ScanSnap.

ATTENTION

The bottom part of the ScanSnap may become hot when the ScanSnap is being used but this does not affect ScanSnap operation or cause any physical harm. Be careful not to drop the ScanSnap when carrying it.

- ["Cleaning the Outside of iX1600 / iX1500 / iX1400" \(page 509\)](#)
- ["Cleaning the Inside of iX1600 / iX1500 / iX1400" \(page 510\)](#)

Cleaning the Outside of iX1600 / iX1500 / iX1400

ScanSnap

Clean the outside of the ScanSnap, the ADF paper chute (cover), the ADF top section, and the stacker in the following procedure.

Disconnect the cables from the ScanSnap and then clean the outside of the ScanSnap with a dry cloth, or a cloth moistened with Cleaner F1/mild detergent.

ATTENTION

- Never use paint thinner or any other organic solvents. The shape or color may be changed.
- When cleaning the ScanSnap, prevent liquids from entering the ScanSnap.
- It may take a long time for Cleaner F1 to dry if an excessive amount is used. Moisten the cloth with moderate quantity. Wipe off the cleaner completely with a soft cloth to leave no residue on the cleaned parts.

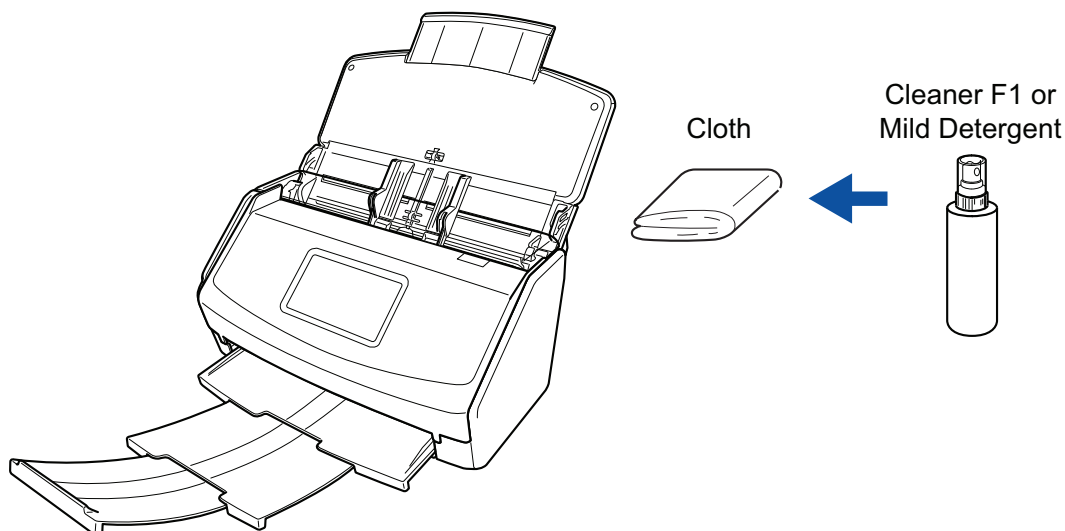

Example: iX1600

Touch Panel

To avoid the surface of the touch panel of iX1600/iX1500 becoming dirty, clean it regularly by gently wiping dirt and dust off with a soft, dry cloth.

Do not rub or tap the surface with hard objects as doing so may damage the surface.

ATTENTION

Do not wipe the touch panel with a damp cloth.

Dust on the surface may become stuck between the touch panel and the ScanSnap, causing the touch panel to malfunction.

Cleaning the Inside of iX1600 / iX1500 / iX1400

Scanning repeatedly may cause dust and paper dust to accumulate inside the ScanSnap resulting in a scanning error.

As a guideline, the inside of the ScanSnap should be cleaned every 1,000 sheets scanned. Note that this guideline varies depending on the types of documents you scan. For instance, it may be necessary to clean the scanner more frequently when you scan documents on which the toner is not sufficiently fused.



- Before cleaning the ScanSnap, you must turn off the ScanSnap and unplug the power cable from the AC outlet. Not doing so may cause fire or electrical shock.
- Do not place internal parts such as the brake roller and the pick roller within reach of small children. Doing so may cause injury.
- The glass inside becomes very hot while the ScanSnap is being used.
Before you clean the inside of the ScanSnap, you must unplug the power cable from the AC outlet and leave the ScanSnap for 15 minutes or more.



Do not use aerosol spray or spray that contains alcohol to clean the scanner. Paper dust and other dust blown up by strong air from the spray may enter the inside of the scanner which may cause scanner failure or malfunction.

Also note that sparks generated by static electricity may cause a fire.

ATTENTION

- Do not use water or mild detergent to clean the inside of the ScanSnap.
- It may take a long time for Cleaner F1 to dry if an excessive amount is used. Moisten the cloth with moderate quantity.

Wipe off the cleaner completely to leave no residue on the cleaned parts.

- 1. Unplug the power cable of the ScanSnap from the AC outlet.**
- 2. Remove any documents from the ADF paper chute (cover).**
- 3. Remove the Receipt Guide if it is attached.**

You can remove the Receipt Guide by holding it with one hand and pulling it.

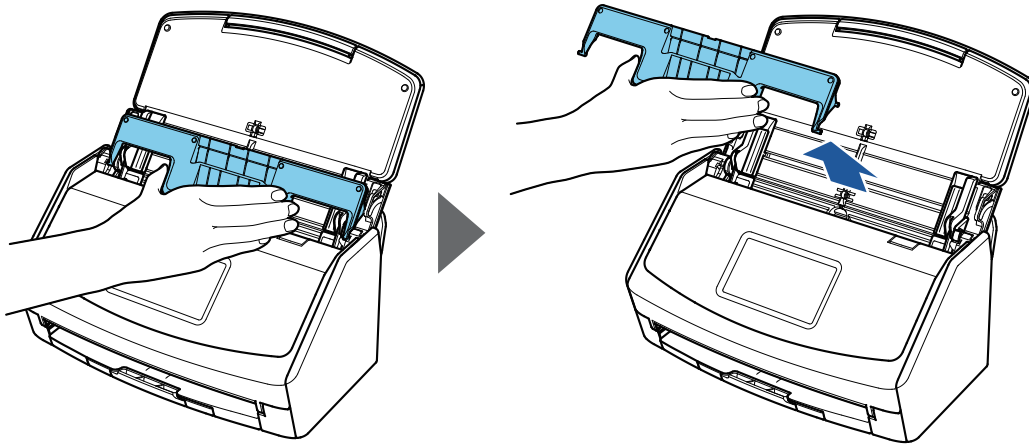

Example: iX1600

4. Pull the ADF release tab towards you to open the ADF top section.

The body of the ScanSnap may vary in color depending on the region where you purchased the ScanSnap.



Example: iX1600

5. Clean the following locations with a cloth moistened with Cleaner F1.

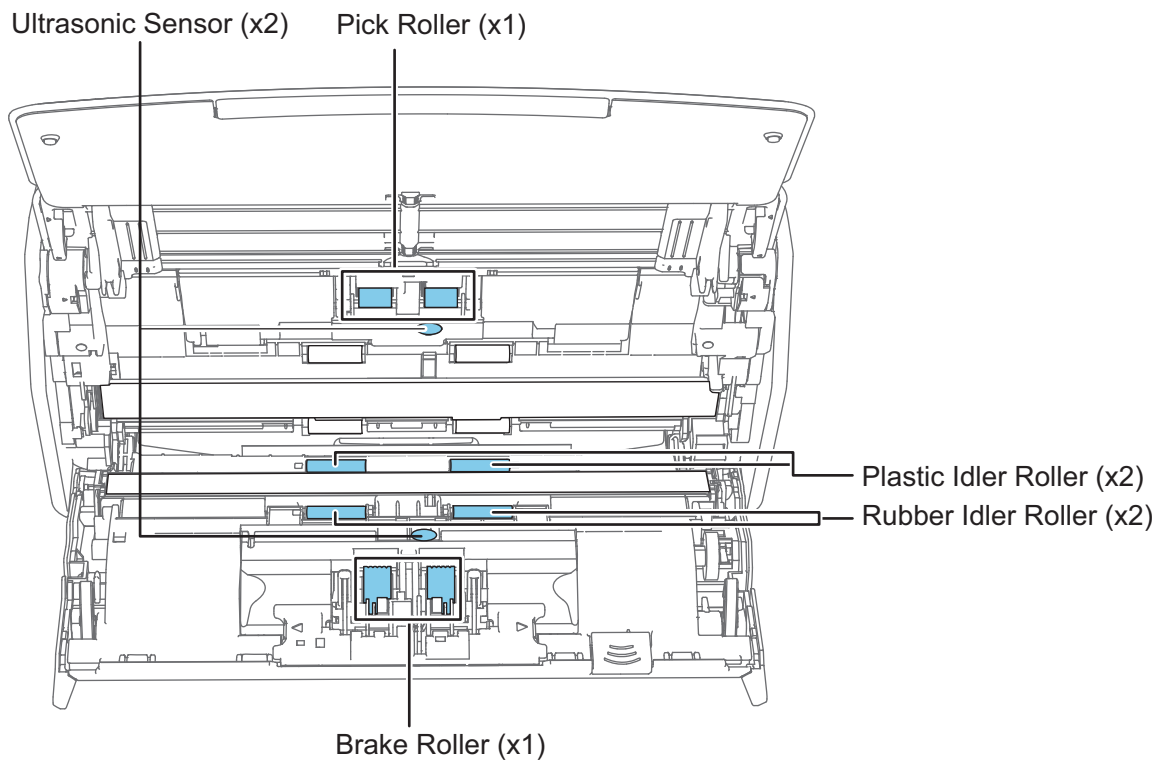

When cleaning, be careful not to damage the document sensor with a cloth.

The body of the ScanSnap may vary in color depending on the region where you purchased the ScanSnap.



- Brake roller (× 1)

Remove the brake roller from the ScanSnap to clean them.

For details about how to remove the brake roller, refer to "[Replacing Consumables for iX1600 / iX1500 / iX1400](#)" (page 553).

Gently wipe off the dirt and dust along the grooves on the roller surface.

Be careful not to damage the surface of the rollers.

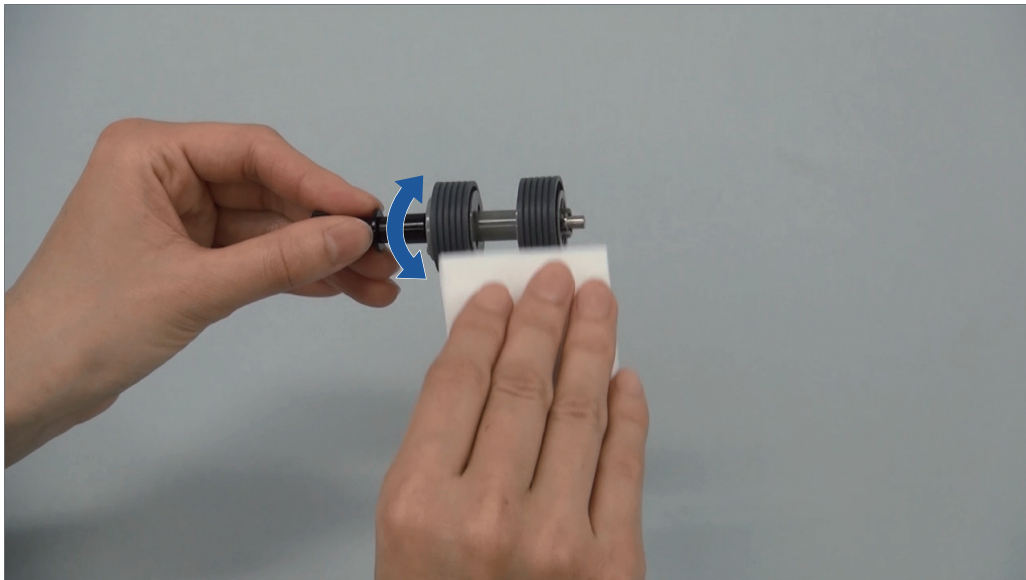

- Rubber idler roller (× 2), plastic idler roller (× 2)
Gently wipe the dirt and dust off the rollers as you rotate them manually.
Be careful not to damage the surface of the rollers.
Make sure that they are cleaned properly because residue on the rollers will affect the feeding performance.
- Pick roller (× 1)
Remove the pick roller from the ScanSnap to clean them.
For details about how to remove the pick roller, refer to ["Replacing Consumables for iX1600 / iX1500 / iX1400" \(page 553\)](#).
Gently wipe off the dirt and dust along the grooves on the roller surface.
Be careful not to damage the surface of the rollers.
Make sure that they are cleaned properly because residue on the rollers will affect the feeding performance.

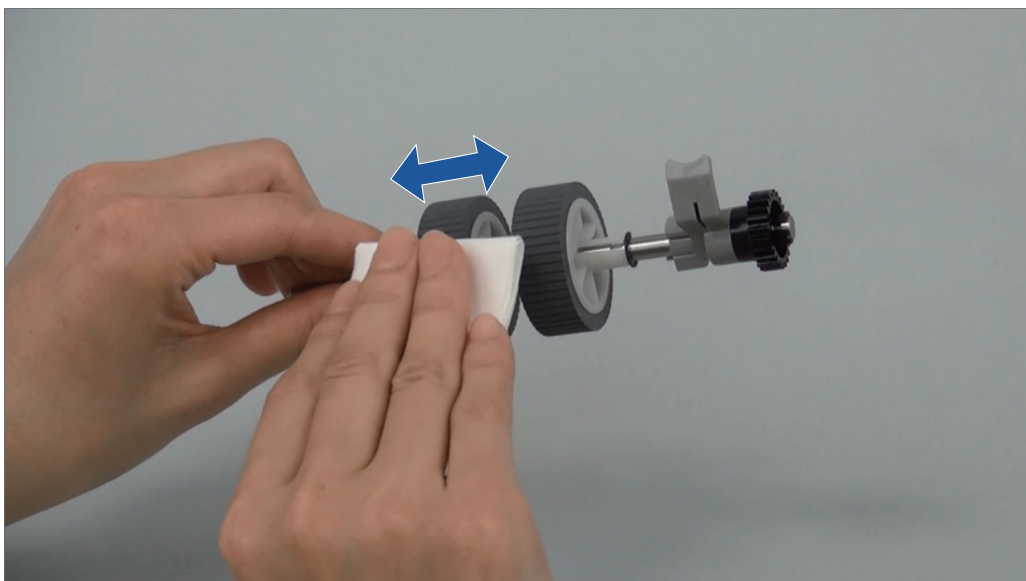

- Ultrasonic sensor (× 2)
Gently wipe the dirt and dust off the surface of the ultrasonic sensors. If it is difficult to clean the ultrasonic sensors, use cotton swabs.

6. Clean the feed rollers and the eject rollers with the ScanSnap turned on.

iX1600/iX1500

1. Connect the power cable of the ScanSnap to the AC outlet.
2. Press  in the [home screen](#) on the touch panel to display the [Settings] screen.



3. Press  to display the [Maintenance] screen.
4. Press [Roller cleaning] to display the [Roller cleaning] screen.
5. Keep pressing the [Run] button to rotate the feed rollers and the eject rollers.

HINT

When you let go of the [Run] button, the feed rollers and the eject rollers stop rotating.

6. Clean the following locations while rotating the rollers.

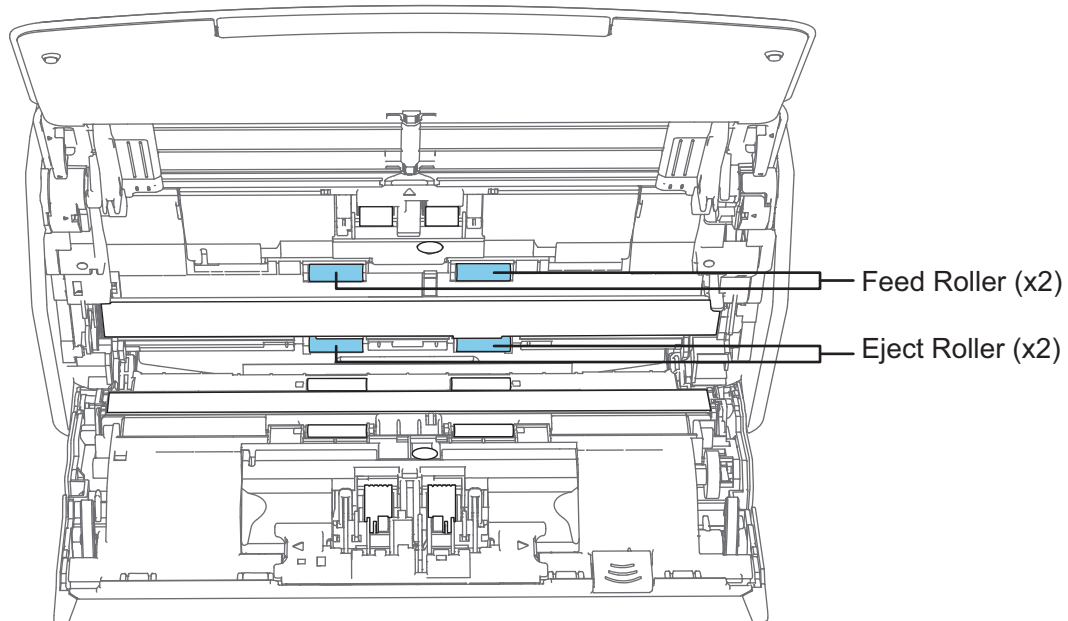

- Feed roller (× 2)/eject roller (× 2)

Gently wipe the dirt and dust off while taking care not to damage the surface of the roller.

Make sure that they are cleaned properly because residue on the rollers will affect the feeding performance.

iX1400

1. Connect the power cable to the AC outlet and press the [Scan] button for three seconds with the ADF top section open.

ATTENTION

Connect the power cable to the AC outlet only when cleaning the feed rollers and eject rollers.

2. Clean the following locations with a cloth moistened with Cleaner F1.

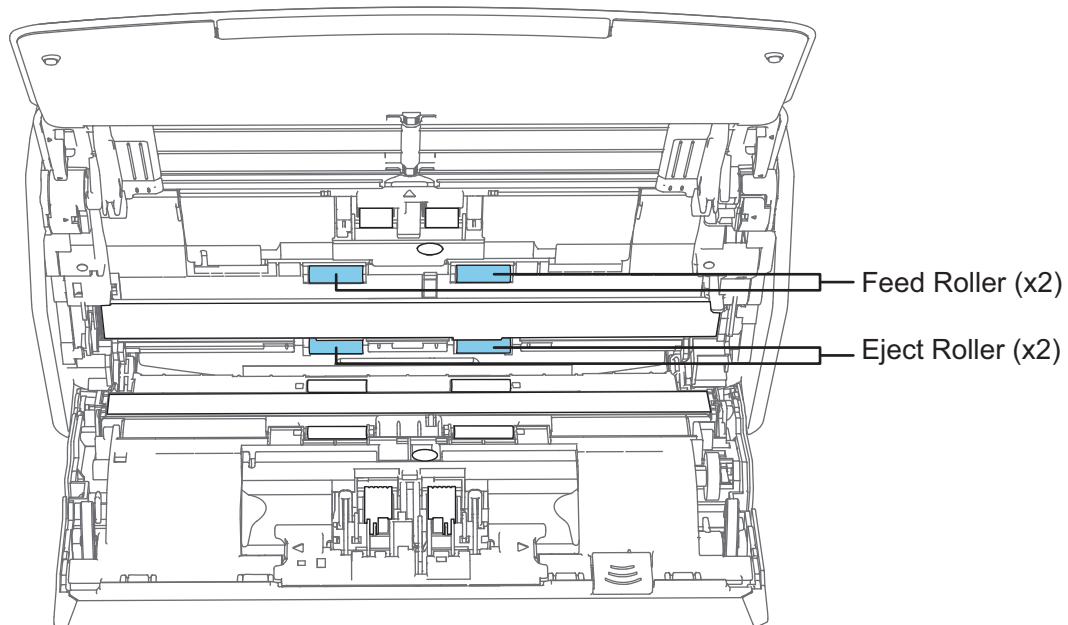

- Feed roller (× 2)/eject roller (× 2)

Press the [Scan] button to rotate the rollers. Gently wipe the dirt and dust off while taking care not to damage the surface of the roller. Make sure that they are cleaned properly because residue on the rollers will affect the feeding performance.

HINT

Pressing the [Scan] button seven times will rotate the feed rollers and the eject rollers one revolution.

7. Close the ADF top section.

Close the ADF top section until it locks in place.

The body of the ScanSnap may vary in color depending on the region where you purchased the ScanSnap.

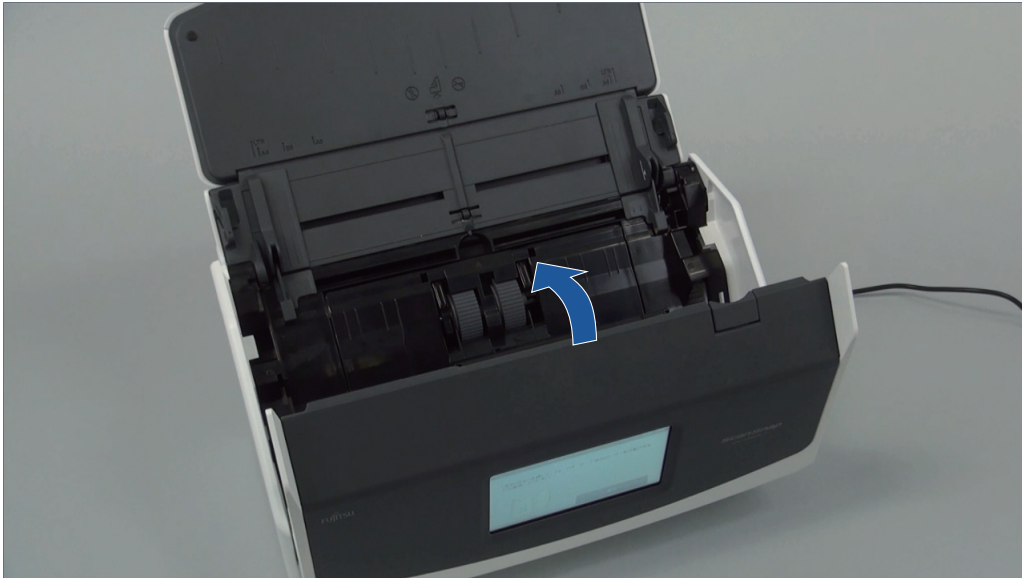

Example: iX1600



Make sure that the ADF top section is completely closed.
Otherwise, paper jams or other feeding errors, or image faults may occur.

Cleaning iX1300

This section explains about the cleaning materials and how to clean the ScanSnap.

ATTENTION

The bottom part of the ScanSnap may become hot when the ScanSnap is being used but this does not affect ScanSnap operation or cause any physical harm. Be careful not to drop the ScanSnap when carrying it.

- ["Cleaning the Outside of iX1300" \(page 518\)](#)
- ["Cleaning the Inside of iX1300" \(page 519\)](#)

Cleaning the Outside of iX1300

Clean the outside of the ScanSnap, the ADF paper chute (cover), and the ADF top section in the following procedure.

- 1. Unplug the cables from the ScanSnap.**
- 2. Clean the outside of the ScanSnap with a dry cloth, or a cloth moistened with Cleaner F1/mild detergent.**

ATTENTION

- Never use paint thinner or any other organic solvents. The shape or color may be changed.
- When cleaning the ScanSnap, prevent liquids from entering the ScanSnap.
- It may take a long time for Cleaner F1 to dry if an excessive amount is used. Moisten the cloth with moderate quantity. Wipe off the cleaner completely with a soft cloth to leave no residue on the cleaned parts.

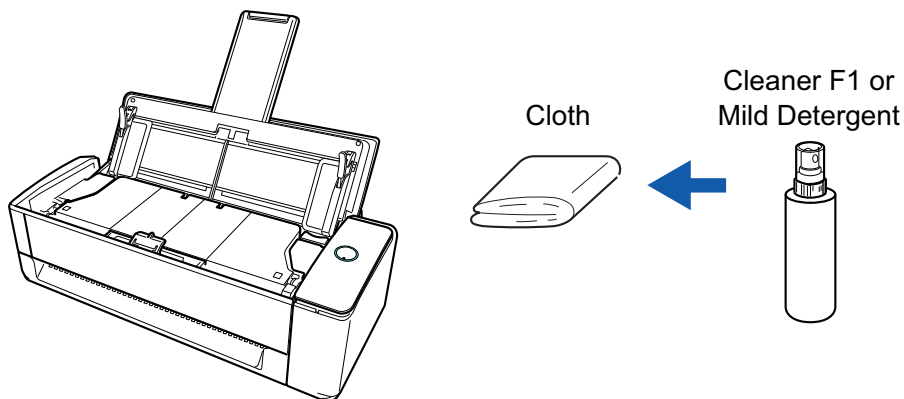

Cleaning the Inside of iX1300

Scanning repeatedly may cause dust and paper dust to accumulate inside the ScanSnap resulting in a scanning error.

As a guideline, the inside of the ScanSnap should be cleaned every 1,000 sheets scanned. Note that this guideline varies depending on the types of documents you scan. For instance, it may be necessary to clean the scanner more frequently when you scan documents on which the toner is not sufficiently fused.



- Before cleaning the ScanSnap, you must turn off the ScanSnap and unplug the power cable from the AC outlet. Not doing so may cause fire or electrical shock.
- Do not place internal parts such as the pad unit and the pick roller within reach of small children. Doing so may cause injury.
- The glass inside becomes very hot while the ScanSnap is being used.
Before you clean the inside of the ScanSnap, you must unplug the power cable from the AC outlet and leave the ScanSnap for 15 minutes or more.



- Do not use aerosol spray or spray that contains alcohol to clean the scanner. Paper dust and other dust blown up by strong air from the spray may enter the inside of the scanner which may cause scanner failure or malfunction.
Also note that sparks generated by static electricity may cause a fire.
- While cleaning the ScanSnap, pay attention to the inside structure of the ScanSnap and avoid accidentally getting your hand or a cloth caught on the pick spring (metal part). Otherwise, the pick spring (metal part) may be deformed, which causes injury.

ATTENTION

- Do not use water or mild detergent to clean the inside of the ScanSnap.
- It may take a long time for Cleaner F1 to dry if an excessive amount is used. Moisten the cloth with moderate quantity.
Wipe off the cleaner completely to leave no residue on the cleaned parts.
- The bottom part of the ScanSnap may become hot when the ScanSnap is being used, but this does not affect ScanSnap operation or cause any physical harm. Be careful not to drop the ScanSnap when carrying it.

HINT

- To check the number of sheets scanned with the ScanSnap, see [Total Page Count] in the [ScanSnap Manager - Check consumable status] window.
To open the [ScanSnap Manager - Check consumable status] window, right-click the ScanSnap Manager icon  in the notification area located at the far right of the taskbar, and select [Check consumable status] from the "Right-Click Menu" (page 100).
- If the message "The document sensor(s) are dirty." appears, clean the the document sensors inside the ScanSnap.

1. Unplug the power cable from the AC outlet.
2. Remove any documents from the ADF paper chute (cover).
3. Clean the eject rollers in four places that are located outside the ADF top section .



Gently wipe the dirt and dust off the rollers as you rotate them manually with a cloth moistened with Cleaner F1.

Be careful not to damage the surface of the rollers.

Make sure that they are cleaned properly because residue on the rollers will affect the feeding performance.

ATTENTION

- Make sure that the document support tab is open. Otherwise, a paper jam may occur. If the document support tab is closed, pull it up with your fingers.

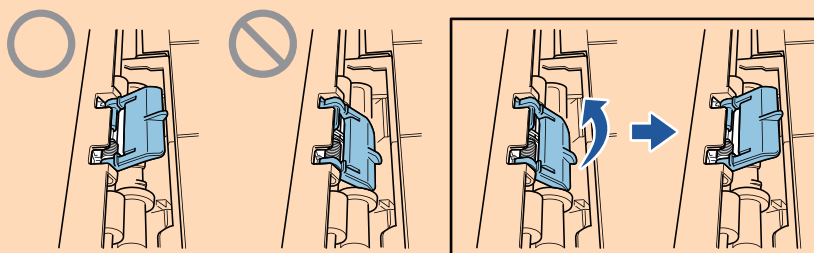

- If the document support tab comes off, refer to "Customer Support" in "[About Customer Support and Maintenance](#)" (page 606) to inquire about the problem.

4. Pull the ADF release tab towards you to open the ADF top section.

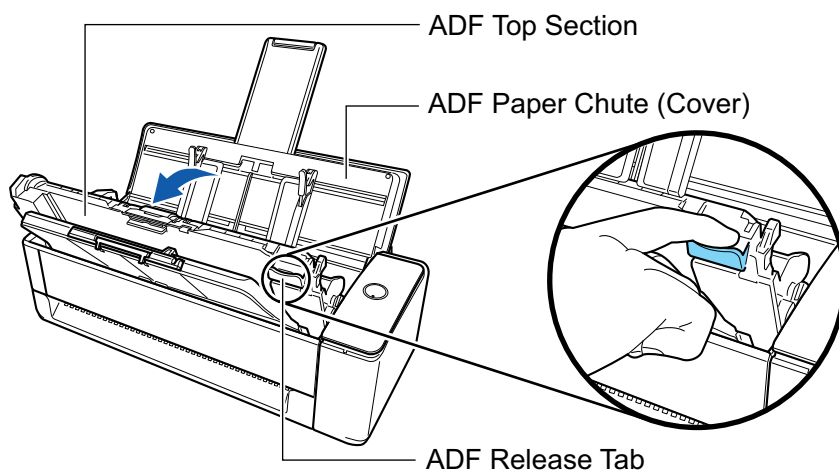

5. Clean the following locations with a cloth moistened with Cleaner F1.

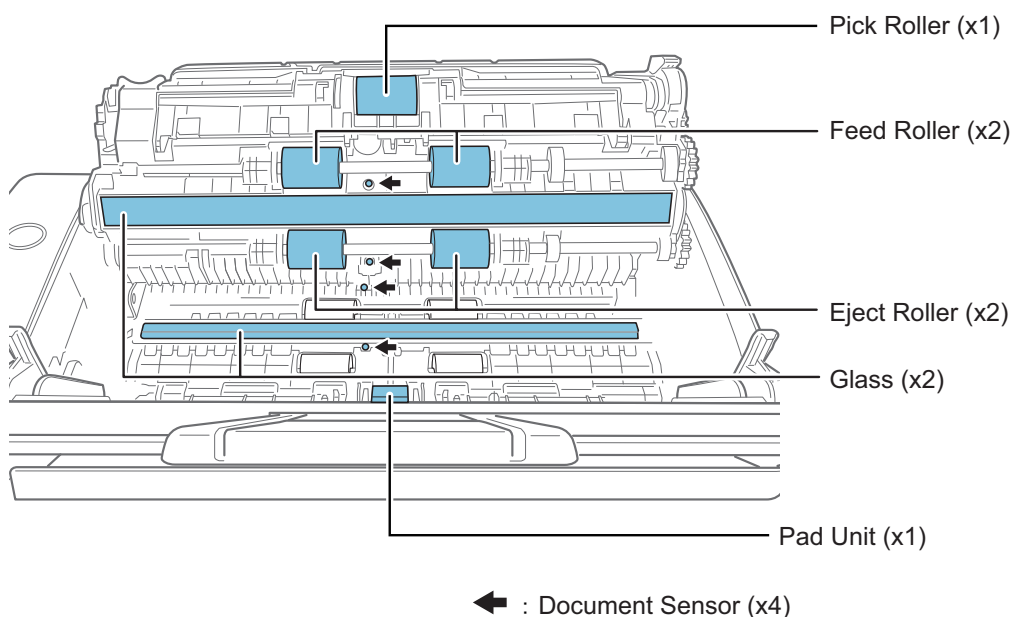

ATTENTION

When cleaning, be careful not to damage the document sensor with a cloth.

- Pick roller (× 1)/feed roller (× 2)/eject roller (× 2)
Gently wipe the dirt and dust off the surface of the rollers as you rotate them with your fingers.
Make sure that they are cleaned properly because residue on the rollers will affect the feeding performance.
- Glass (× 2)
Gently wipe the dirt and dust off the surface of the glass sections. Dirt on the surface of the glass sections may cause vertical lines on scanned images.
- Pad unit (× 1)
Wipe the rubber surface of the pad downward to remove any dirt and dust. Be careful not to accidentally get your hand or a cloth on the pick spring (metal part). Keep the pick arm down during cleaning.
- Document sensor (× 4)

Gently wipe the dirt and dust off the surface of the document sensors. If it is difficult to clean the ultrasonic sensors, use cotton swabs.

6. Clean the feed rollers and eject rollers on the scanner side.

1. Connect the power cable to the AC outlet and press the [Scan] button for three seconds with the ADF top section open.

ATTENTION

Connect the power cable to the AC outlet only when cleaning the feed rollers and eject rollers.

2. Clean the following locations with a cloth moistened with Cleaner F1.

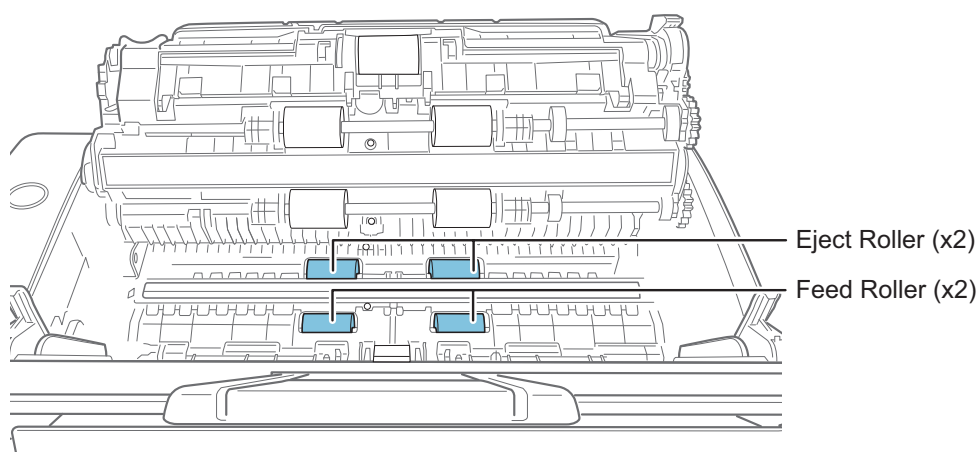

- Feed roller (× 2)/eject roller (× 2)

Press the [Scan] button to rotate the rollers. Gently wipe the dirt and dust off while taking care not to damage the surface of each roller. Make sure that they are cleaned properly because residue on the rollers will affect the feeding performance.

HINT

Pressing the [Scan] button seven times will rotate the feed rollers and the eject rollers one revolution.

7. Close the ADF top section.

Close the ADF top section together with the stacker until it locks into position, indicated by a clicking sound.

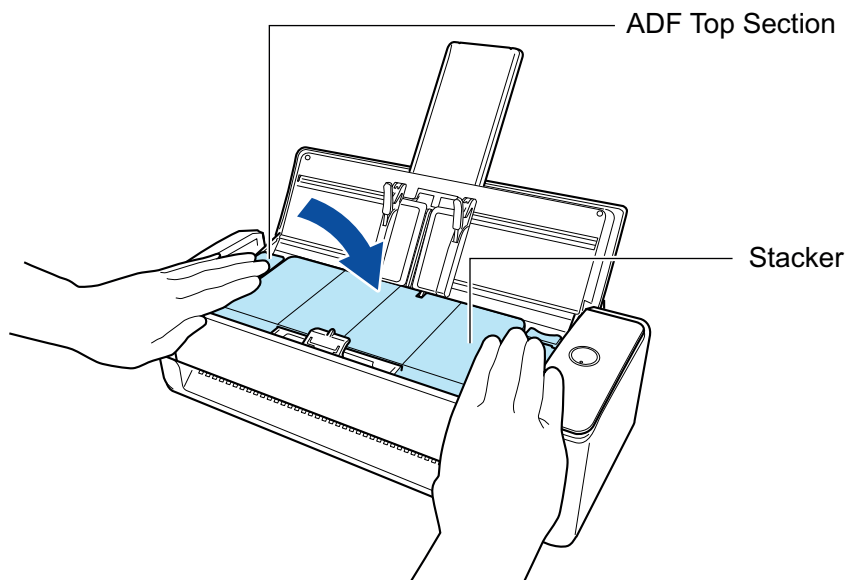

ATTENTION

Make sure that the ADF top section is completely closed.
Otherwise, paper jams or other feeding errors, or image faults may occur.

Cleaning iX500

This section explains about the cleaning materials and how to clean the ScanSnap.

ATTENTION

The bottom part of the ScanSnap may become hot when the ScanSnap is being used but this does not affect ScanSnap operation or cause any physical harm. Be careful not to drop the ScanSnap when carrying it.

- ["Cleaning the Outside of iX500" \(page 525\)](#)
- ["Cleaning the Inside of iX500" \(page 526\)](#)

Cleaning the Outside of iX500

Clean the outside of the ScanSnap, the ADF paper chute (cover), the ADF top section, and the stacker in the following procedure.

- 1. Unplug the cables from the ScanSnap.**
- 2. Clean the outside of the ScanSnap with a dry cloth, or a cloth moistened with Cleaner F1/mild detergent.**

ATTENTION

- Never use paint thinner or any other organic solvents. The shape or color may be changed.
- When cleaning the ScanSnap, prevent liquids from entering the ScanSnap.
- It may take a long time for Cleaner F1 to dry if an excessive amount is used. Moisten the cloth with moderate quantity. Wipe off the cleaner completely with a soft cloth to leave no residue on the cleaned parts.

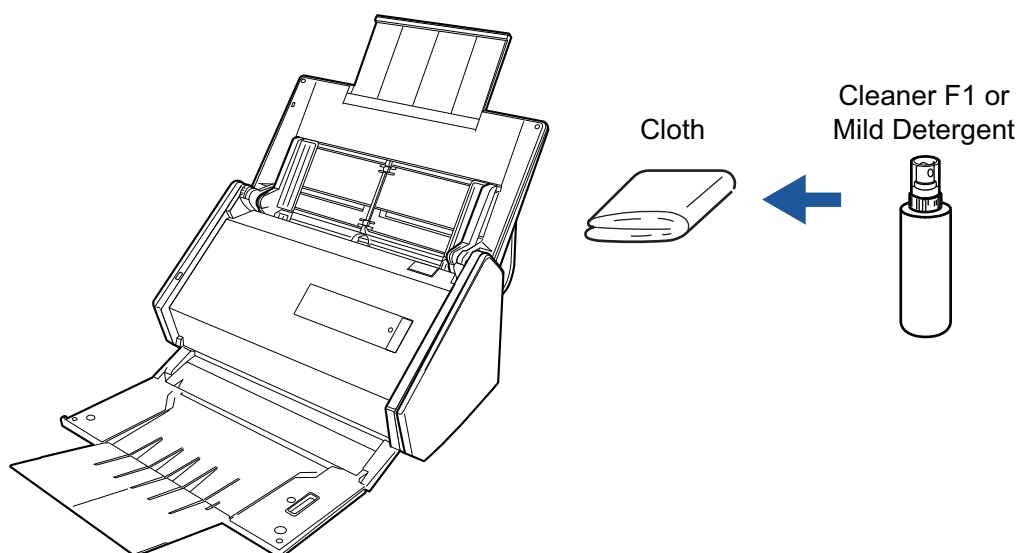

Cleaning the Inside of iX500

Scanning repeatedly may cause dust and paper dust to accumulate inside the ScanSnap resulting in a scanning error.

As a guideline, the inside of the ScanSnap should be cleaned every 1,000 sheets scanned. Note that this guideline varies depending on the types of documents you scan. For instance, it may be necessary to clean the scanner more frequently when you scan documents on which the toner is not sufficiently fused.



- Before cleaning the ScanSnap, you must turn off the ScanSnap and unplug the power cable from the AC outlet. Not doing so may cause fire or electrical shock.
- Do not place internal parts such as the brake roller and the pick roller within reach of small children. Doing so may cause injury.
- The glass inside becomes very hot while the ScanSnap is being used.
Before you clean the inside of the ScanSnap, you must unplug the power cable from the AC outlet and leave the ScanSnap for 15 minutes or more.



Do not use aerosol spray or spray that contains alcohol to clean the scanner. Paper dust and other dust blown up by strong air from the spray may enter the inside of the scanner which may cause scanner failure or malfunction.

Also note that sparks generated by static electricity may cause a fire.

ATTENTION

- Do not use water or mild detergent to clean the inside of the ScanSnap.
- It may take a long time for Cleaner F1 to dry if an excessive amount is used. Moisten the cloth with moderate quantity.

Wipe off the cleaner completely to leave no residue on the cleaned parts.

HINT

To check the number of sheets scanned with the ScanSnap, see [Total Page Count] in the [ScanSnap Manager - Check consumable status] window.

To open the [ScanSnap Manager - Check consumable status] window, right-click the ScanSnap



Manager icon in the notification area located at the far right of the taskbar, and select [Check consumable status] from the "Right-Click Menu" (page 100).

1. Clean the following items:

- Brake roller
- Idler roller
- Glass
- Pick roller
- Ultrasonic sensor

1. Unplug the power cable from the AC outlet.
2. Pull the ADF release tab towards you to open the ADF top section.

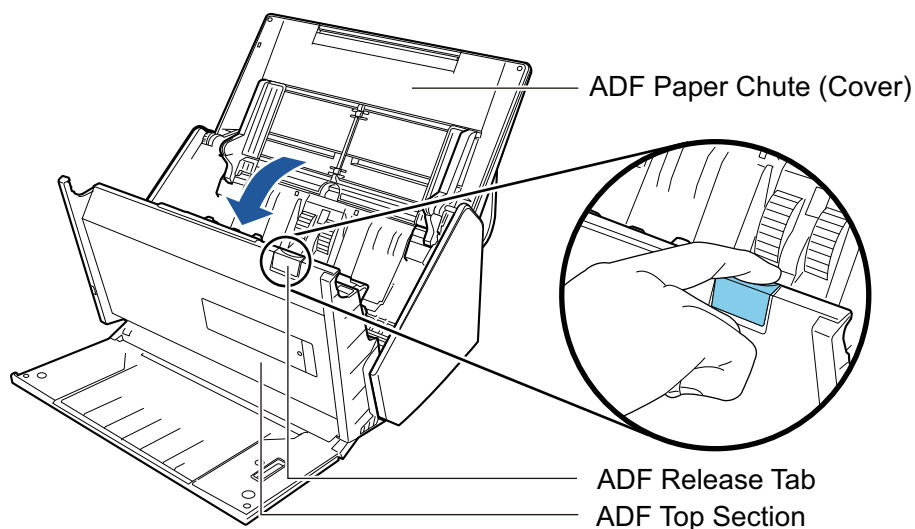

3. Clean the following locations with a cloth moistened with Cleaner F1.

ATTENTION

When cleaning, be careful not to damage the document sensor with a cloth.

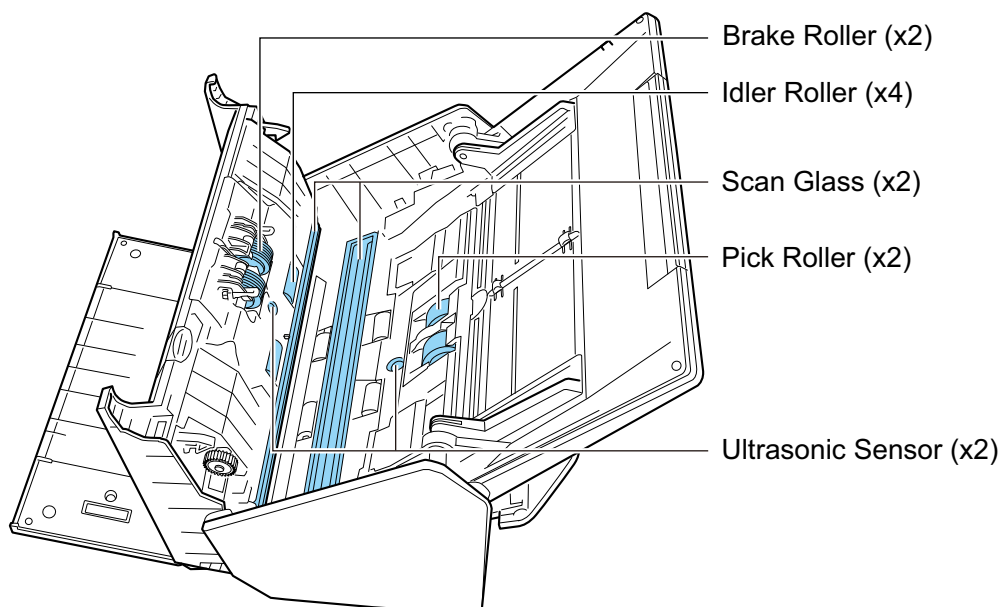
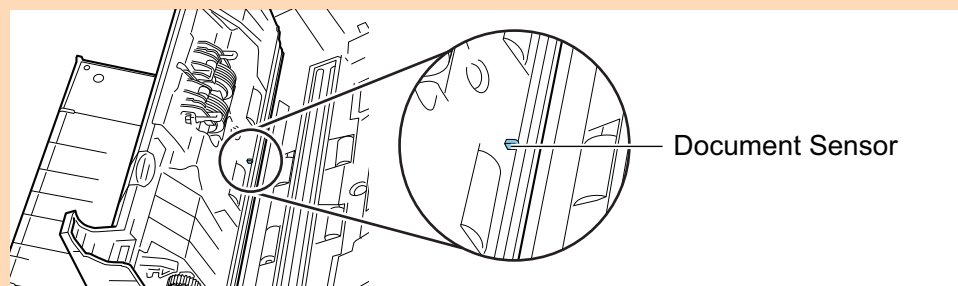

- Brake roller (× 2)

Remove the brake rollers from the ScanSnap to clean them.

For details about how to remove the brake rollers, refer to ["Replacing Consumables for iX500" \(page 568\)](#).

Gently wipe off the dirt and dust along the grooves on the roller surface. Be careful not to damage the surface of the rollers.

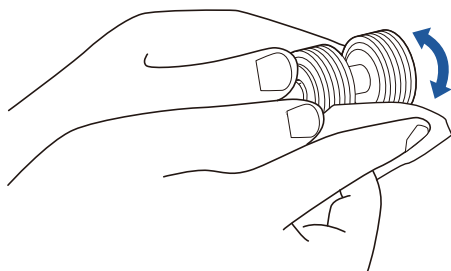

- Idler roller (× 4)

Gently wipe the dirt and dust off the rollers as you rotate them manually. Be careful not to damage the surface of the rollers. Make sure that they are cleaned properly because residue on the rollers will affect the feeding performance.

- Glass (× 2)

Gently wipe the dirt and dust off the surface of the glass sections. Make sure that they are cleaned properly because dirty glass sections may cause vertical lines on scanned images.

- Pick roller (× 2)

Gently wipe off the dirt and dust along the grooves on the surface of rollers as you manually rotate them downward. Be careful not to damage the surface of the rollers. Make sure that they are cleaned properly because residue on the rollers will affect the feeding performance.

- Ultrasonic sensor (× 2)

Gently wipe the dirt and dust off the surface of the ultrasonic sensors. If it is difficult to clean the ultrasonic sensors, use cotton swabs.

2. Clean the feed rollers and eject rollers.

1. Connect the power cable to the AC outlet and press the [Scan] button for three seconds with the ADF top section open.

ATTENTION

Connect the power cable to the AC outlet only when cleaning the feed rollers and eject rollers.

2. Clean the following locations with a cloth moistened with Cleaner F1.

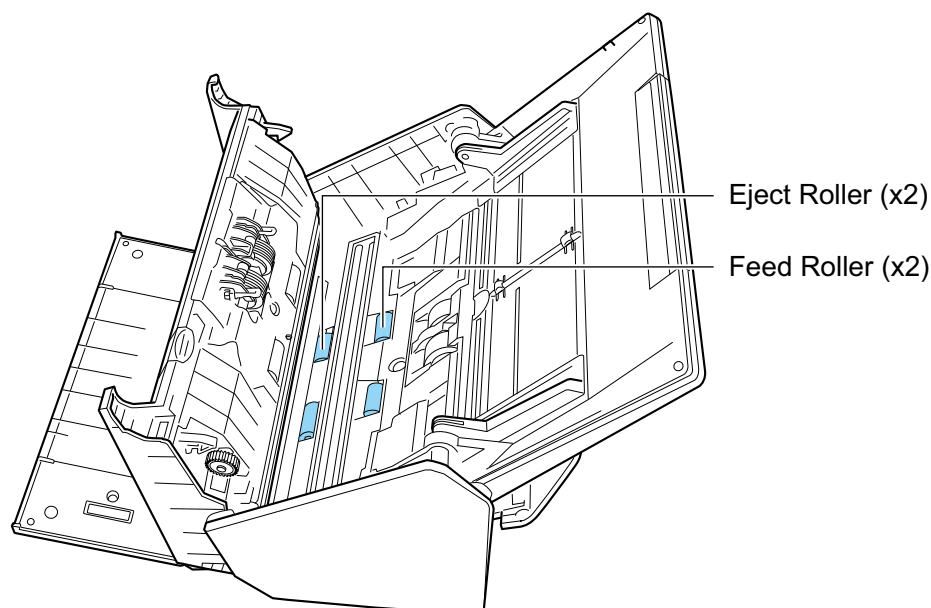

- Feed roller (× 2)/eject roller (× 2)

Press the [Scan] button to rotate the rollers. Gently wipe the dirt and dust off while taking care not to damage the surface of the roller. Make sure that they are cleaned properly because residue on the rollers will affect the feeding performance.

HINT

Pressing the [Scan] button seven times will rotate the feed rollers and the eject rollers one revolution.

3. Close the ADF top section.

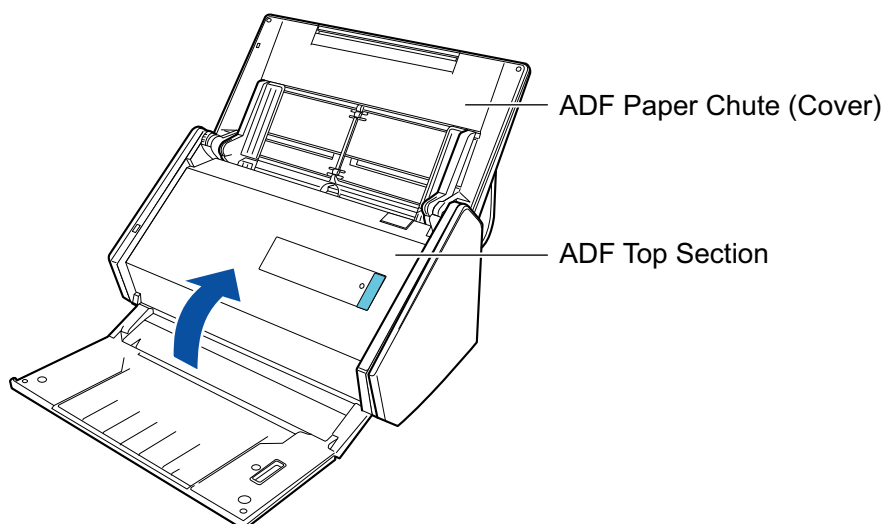

⇒ It clicks when it returns to its original position.

ATTENTION

Make sure that the ADF top section is completely closed. Otherwise, paper jams or other feeding errors, or image faults may occur.

Cleaning iX100

This section explains about the cleaning materials and how to clean the ScanSnap.

- ["Cleaning the Outside of iX100" \(page 531\)](#)
- ["Cleaning the Inside of iX100" \(page 532\)](#)

Cleaning the Outside of iX100

Clean the outside of the ScanSnap in the following procedure.

- 1. Unplug the cables from the ScanSnap.**
- 2. Clean the outside of the ScanSnap with a dry cloth, or a cloth moistened with Cleaner F1/mild detergent.**

ATTENTION

- Never use paint thinner or any other organic solvents. The shape or color may be changed.
- When cleaning the ScanSnap, prevent liquids from entering the ScanSnap.
- It may take a long time for Cleaner F1 to dry if an excessive amount is used. Moisten the cloth with moderate quantity. Wipe off the cleaner completely with a soft cloth to leave no residue on the cleaned parts.

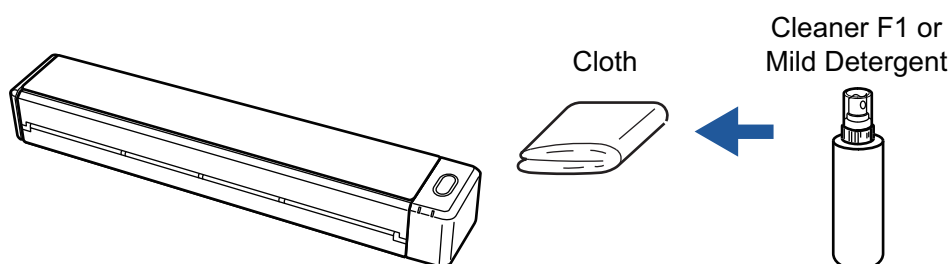

Cleaning the Inside of iX100

Scanning repeatedly may cause dust and paper dust to accumulate inside the ScanSnap resulting in a scanning error.

As a guideline, the inside of the ScanSnap should be cleaned every 100 sheets scanned. Note that this guideline varies depending on the types of documents you scan. For instance, it may be necessary to clean the scanner more frequently when you scan documents on which the toner is not sufficiently fused.



Do not use aerosol spray or spray that contains alcohol to clean the scanner. Paper dust and other dust blown up by strong air from the spray may enter the inside of the scanner which may cause scanner failure or malfunction.

Also note that sparks generated by static electricity may cause a fire.

ATTENTION

- Do not use water or mild detergent to clean the inside of the ScanSnap.
- It may take a long time for Cleaner F1 to dry if an excessive amount is used. Moisten the cloth with moderate quantity.

Wipe off the cleaner completely to leave no residue on the cleaned parts.

HINT

To check the number of sheets scanned with the ScanSnap, see [Total Page Count] in the [ScanSnap Manager - Scanner and driver information] window.

To open the [ScanSnap Manager - Scanner and driver information] window, right-click the ScanSnap



Manager icon in the notification area located at the far right of the taskbar, and click [Help] → [ScanSnap information] from the "Right-Click Menu" (page 100).

1. Clean the glass and idler rollers.

1. Open the feed guide.

The ScanSnap is turned on and a roller rotation sound comes out of the ScanSnap.

After the sound stops, proceed to the next step.

2. Open the top cover and output guide.

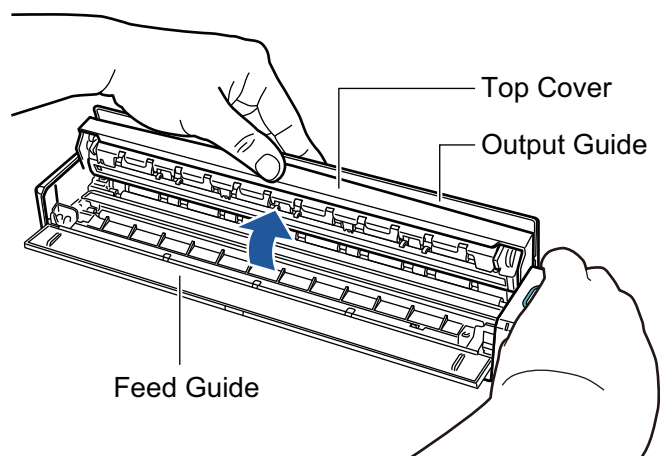

3. Clean the following locations with a cloth moistened with Cleaner F1.

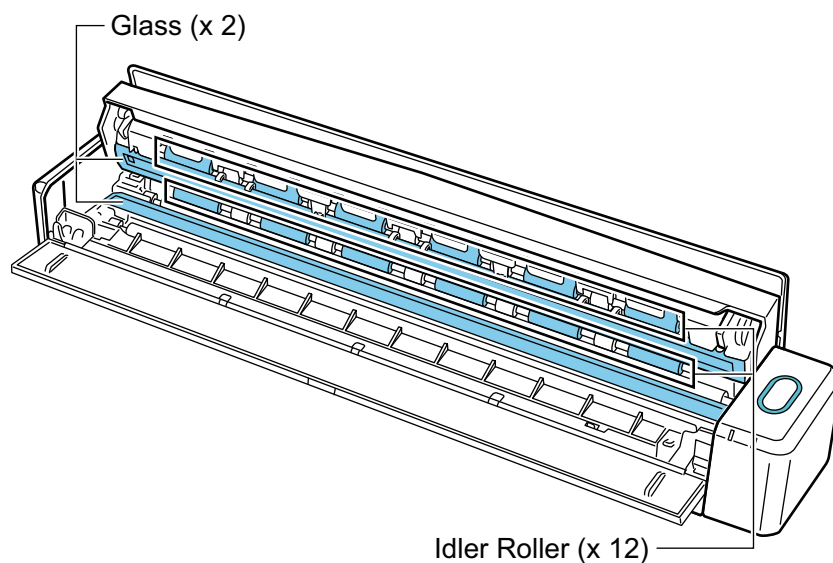

- Glass (× 2, one on the top cover and one on the opposite side)
Gently wipe the dirt and dust off the surface of the glass sections.
- Idler roller (× 12, located on the top cover)
Gently wipe the dirt and dust off the rollers as you rotate them manually. Be careful not to damage the surface of the rollers. Make sure that they are cleaned properly because residue on the rollers will affect the feeding performance.

2. Clean the feed rollers and eject rollers.

1. Press the [Scan/Stop] button for 3 seconds with the top cover open.
2. Clean the following locations with a cloth moistened with Cleaner F1.

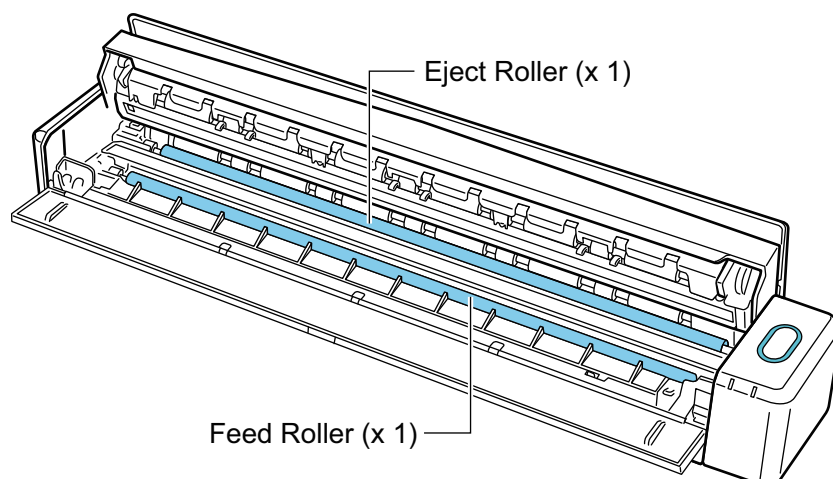

- Feed roller (× 1, located on the scanner side)
Press the [Scan/Stop] button to rotate the roller. Gently wipe the dirt and dust off while taking care not to damage the surface of the roller. Make sure that they are cleaned properly because residue on the roller will affect the feeding performance.
- Eject roller (× 1, located on the scanner side)
Press the [Scan/Stop] button to rotate the roller. Gently wipe the dirt and dust off while taking care not to damage the surface of the roller. Make sure that they are cleaned properly because residue on the roller will affect the feeding performance.
If the eject roller is difficult to clean, try cleaning it from the back of the ScanSnap while you keep the top cover slightly open.

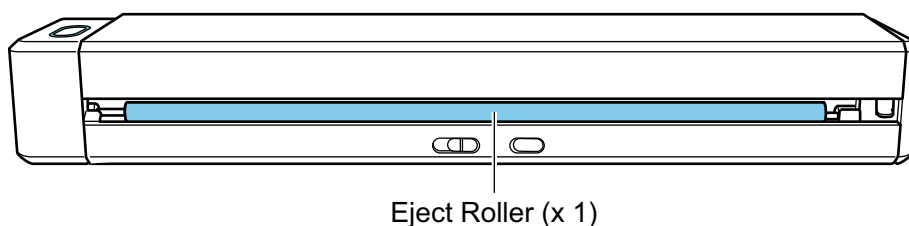
**HINT**

Pressing the [Scan/Stop] button seven times will rotate the feed roller and the eject roller one revolution.

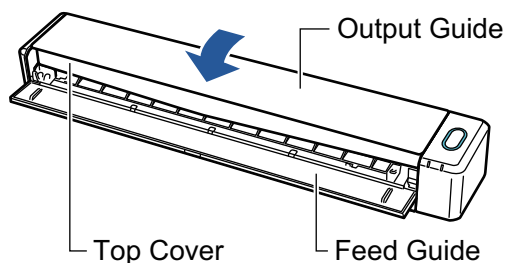
3. Close the top cover and the output guide.

⇒ It clicks when it returns to its original position.

ATTENTION

Make sure that the top cover is completely closed.

Otherwise, paper jams or other feeding errors, or image faults may occur.

Cleaning SV600

This section explains how to clean the outside of the ScanSnap.

If the white sheet, glass, camera, lamp, or infrared LED is dirty, errors may appear in the scanned images. Whenever an error appears in a scanned image, clean the ScanSnap.

1. **Unplug the cables from the ScanSnap.**
2. **Clean the outside of the ScanSnap with a dry cloth, or a cloth moistened with Cleaner F1/mild detergent.**

Use a cotton swab to clean small parts such as the camera or infrared LED of the ScanSnap.

ATTENTION

- Never use paint thinner or any other organic solvents. The shape or color may be changed.
- When cleaning the ScanSnap, prevent liquids from entering the ScanSnap.
- It may take a long time for Cleaner F1 to dry if an excessive amount is used. Moisten the cloth with moderate quantity. Wipe off the cleaner completely with a soft cloth to leave no residue on the cleaned parts.
- When cleaning the ScanSnap, hold the neck of the ScanSnap with your hand to prevent it from falling over.

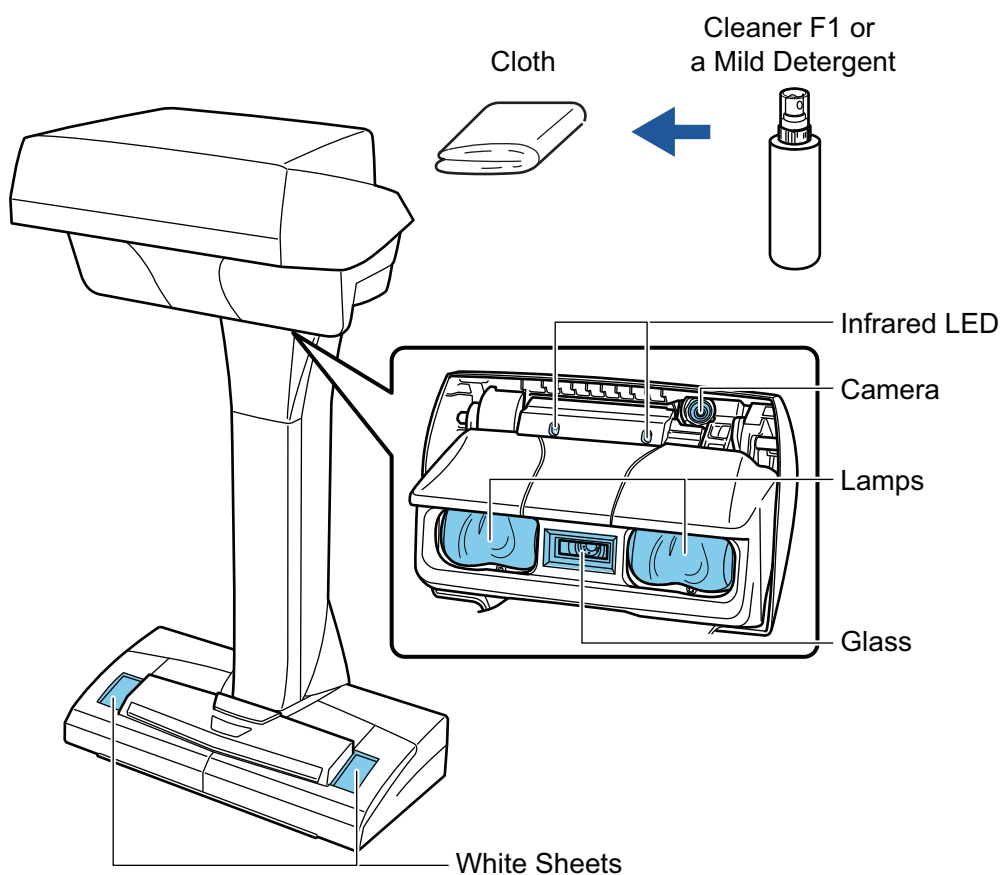

Cleaning S1300i

This section explains about the cleaning materials and how to clean the ScanSnap.

- ["Cleaning the Outside of S1300i" \(page 537\)](#)
- ["Cleaning the Inside of S1300i" \(page 538\)](#)

Cleaning the Outside of S1300i

Clean the outside of the ScanSnap, the ADF paper chute (cover), and the ADF top section in the following procedure.

- 1. Unplug the cables from the ScanSnap.**
- 2. Clean the outside of the ScanSnap with a dry cloth, or a cloth moistened with Cleaner F1/mild detergent.**

ATTENTION

- Never use paint thinner or any other organic solvents. The shape or color may be changed.
- When cleaning the ScanSnap, prevent liquids from entering the ScanSnap.
- It may take a long time for Cleaner F1 to dry if an excessive amount is used. Moisten the cloth with moderate quantity. Wipe off the cleaner completely with a soft cloth to leave no residue on the cleaned parts.

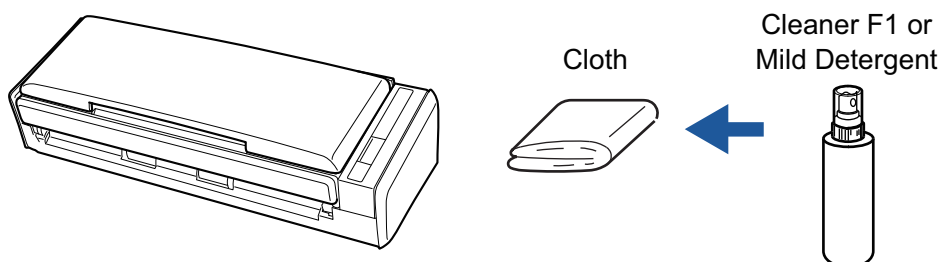

Cleaning the Inside of S1300i

Scanning repeatedly may cause dust and paper dust to accumulate inside the ScanSnap resulting in a scanning error.

As a guideline, the inside of the ScanSnap should be cleaned every 200 sheets scanned. Note that this guideline varies depending on the types of documents you scan. For instance, it may be necessary to clean the scanner more frequently when you scan documents on which the toner is not sufficiently fused.



- Before cleaning the ScanSnap, you must turn off the ScanSnap and unplug the power connection cable (power cable or USB bus power cable) from the power supply source (AC outlet or computer). Not doing so may cause fire or electrical shock.
- Do not place internal parts such as the pad assy and the pick roller assembly within reach of small children. Doing so may cause injury.
- When the ScanSnap is operating, the internal glass surface will be hot. Before you clean the inside of the ScanSnap, you must unplug the power connection cable (power cable or USB bus power cable) from the power supply source (AC outlet or computer) and leave the ScanSnap for 15 minutes or more.



- Do not use aerosol spray or spray that contains alcohol to clean the scanner. Paper dust and other dust blown up by strong air from the spray may enter the inside of the scanner which may cause scanner failure or malfunction. Also note that sparks generated by static electricity may cause a fire.
- While cleaning the ScanSnap, pay attention to the inside structure of the ScanSnap and avoid accidentally getting your hand or a cloth caught on the pick spring (metal part). Otherwise, the pick spring (metal part) may be deformed, which causes injury.

ATTENTION

- Do not use water or mild detergent to clean the inside of the ScanSnap.
- It may take a long time for Cleaner F1 to dry if an excessive amount is used. Moisten the cloth with moderate quantity.

Wipe off the cleaner completely to leave no residue on the cleaned parts.

HINT

To check the number of sheets scanned with the ScanSnap, see [Total Page Count] in the [ScanSnap Manager - Check consumable status] window.

To open the [ScanSnap Manager - Check consumable status] window, right-click the ScanSnap

Manager icon  in the notification area located at the far right of the taskbar, and select [Check consumable status] from the "Right-Click Menu" (page 100).

1. Clean the following items:

- Pad assy
 - Idler roller
 - Glass
 - Pick roller
 - White backing strip
1. Unplug the power connection cable (power cable or USB bus power cable) from the power supply source (AC outlet or computer).
 2. Pull the ADF release tab towards you to open the ADF top section.

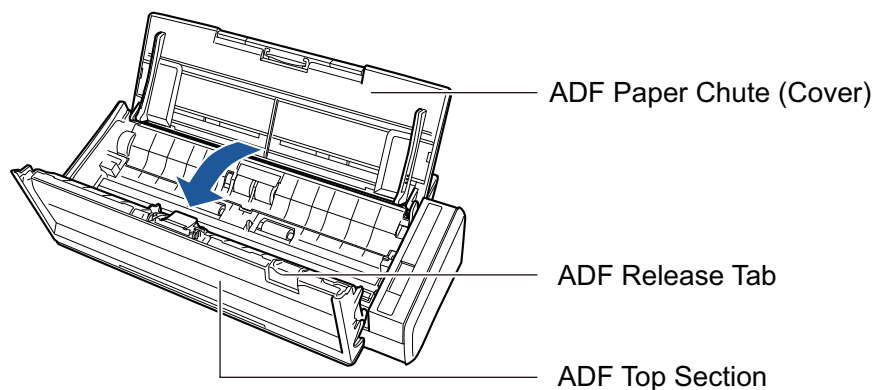

3. Clean the following locations with a cloth moistened with Cleaner F1.

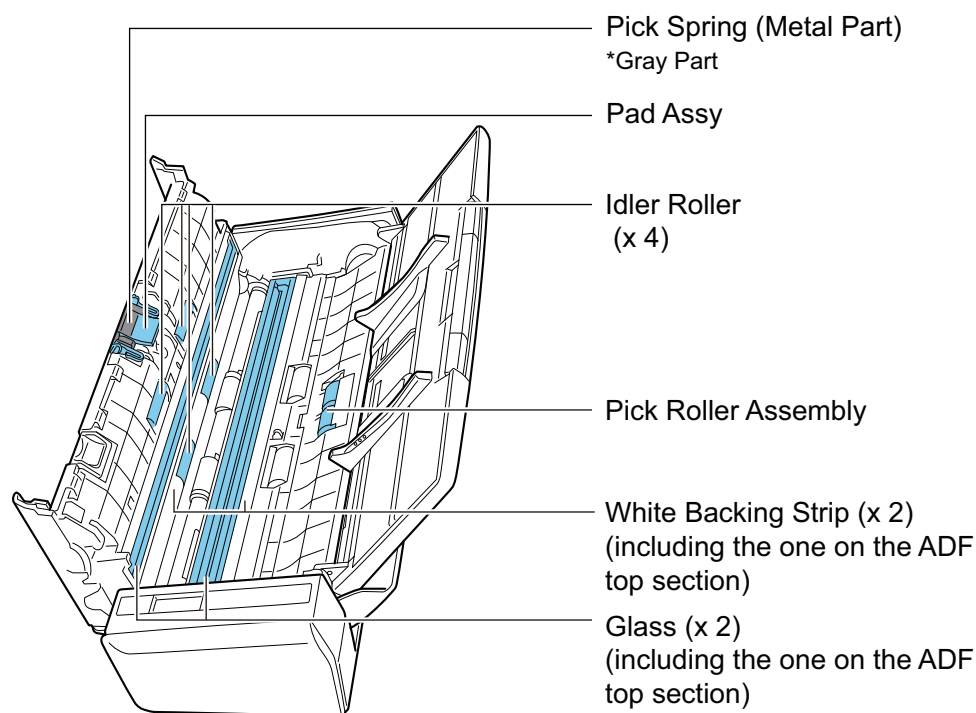

- Idler roller (× 4, located on the ADF top section)
Gently wipe the dirt and dust off the rollers as you rotate them manually. Be careful not to damage the surface of the rollers. Make sure that they are cleaned properly because residue on the rollers will affect the feeding performance.
- Pad assy (× 1, located on the ADF top section)
Wipe the rubber surface of the pad downward to remove any dirt and dust. Be careful not to accidentally get your hand or a cloth on the pick spring (metal part).

- Pick roller assembly (× 1, located on the scanner side)

Gently wipe the dirt and dust off the rollers as you manually rotate them downward. Be careful not to damage the surface of the rollers. Make sure that they are cleaned properly because residue on the rollers will affect the feeding performance.

- Glass (× 2, one on the ADF top section and one on the opposite side)

Gently wipe the dirt and dust off the surface of the glass sections. Make sure that they are cleaned properly because dirty glass sections may cause vertical lines on scanned images.

- White backing strip (× 2, one on the ADF top section and one on the opposite side)

The white sections at the edge of the glass sections. Gently wipe the dirt and dust off the surface.

2. Clean the feed rollers and eject rollers.

1. Connect the power connection cable (power cable or USB bus power cable) to the power supply source (AC outlet or computer), and press the [Scan] button for three seconds with the ADF top section open.

ATTENTION

Connect the power connection cable (power cable or USB bus power cable) to the power supply source (AC outlet or computer) only when cleaning the feed rollers and eject rollers.

2. Clean the following locations with a cloth moistened with Cleaner F1.

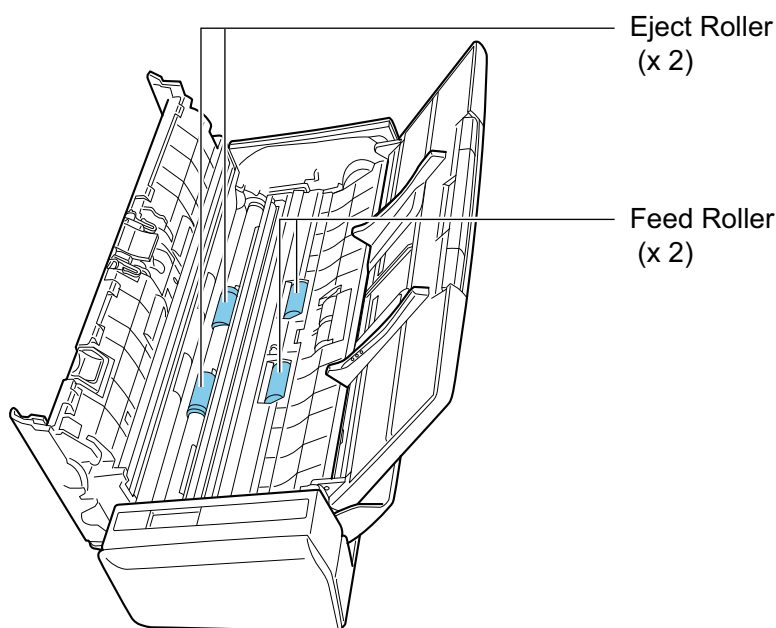

- Feed roller (× 2)/eject roller (× 2)

Press the [Scan] button to rotate the rollers. Gently wipe the dirt and dust off while taking care not to damage the surface of the roller. Make sure that they are cleaned properly because residue on the rollers will affect the feeding performance.

HINT

Pressing the [Scan] button seven times will rotate the feed rollers and the eject rollers one revolution.

3. Close the ADF top section.

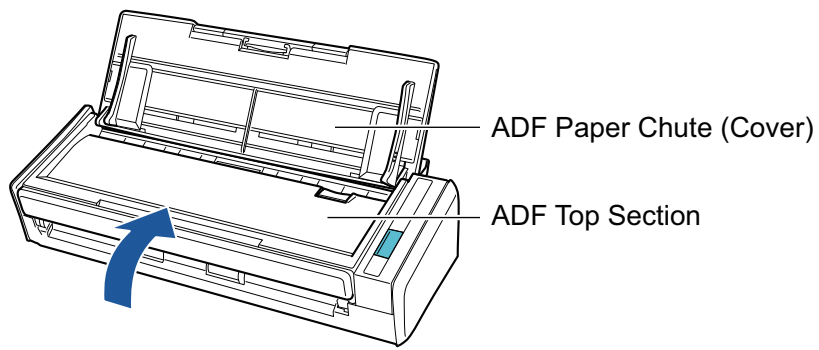

⇒ It clicks when it returns to its original position.

ATTENTION

Make sure that the ADF top section is completely closed.
Otherwise, paper jams or other feeding errors, or image faults may occur.

Cleaning S1100i

This section explains about the cleaning materials and how to clean the ScanSnap.

- ["Cleaning the Outside of S1100i" \(page 543\)](#)
- ["Cleaning the Inside of S1100i" \(page 544\)](#)

Cleaning the Outside of S1100i

Clean the outside of the ScanSnap in the following procedure.

- 1. Unplug the cables from the ScanSnap.**
- 2. Clean the outside of the ScanSnap with a dry cloth, or a cloth moistened with Cleaner F1/mild detergent.**

ATTENTION

- Never use paint thinner or any other organic solvents. The shape or color may be changed.
- When cleaning the ScanSnap, prevent liquids from entering the ScanSnap.
- It may take a long time for Cleaner F1 to dry if an excessive amount is used. Moisten the cloth with moderate quantity. Wipe off the cleaner completely with a soft cloth to leave no residue on the cleaned parts.

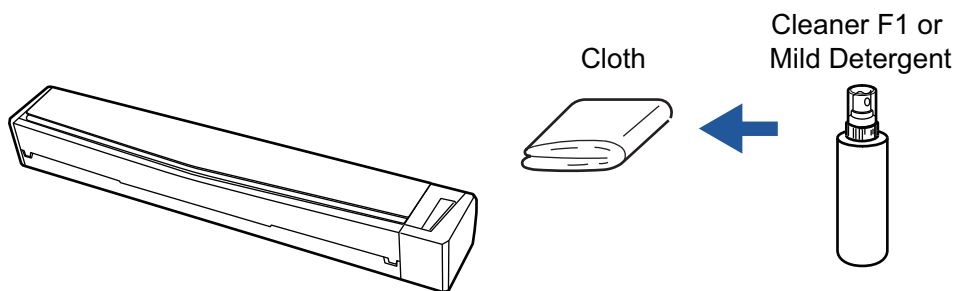

Cleaning the Inside of S1100i

Scanning repeatedly may cause dust and paper dust to accumulate inside the ScanSnap resulting in a scanning error.

As a guideline, the inside of the ScanSnap should be cleaned every 100 sheets scanned. Note that this guideline varies depending on the types of documents you scan. For instance, it may be necessary to clean the scanner more frequently when you scan documents on which the toner is not sufficiently fused.



- Before you clean the ScanSnap, you must close the feed guide, turn off the ScanSnap, and unplug the USB cable. Not doing so may cause fire or electrical shock.
- Do not use aerosol spray or spray that contains alcohol to clean the scanner. Paper dust and other dust blown up by strong air from the spray may enter the inside of the scanner which may cause scanner failure or malfunction.

Also note that sparks generated by static electricity may cause a fire.

ATTENTION

- Do not use water or mild detergent to clean the inside of the ScanSnap.
- It may take a long time for Cleaner F1 to dry if an excessive amount is used. Moisten the cloth with moderate quantity.

Wipe off the cleaner completely to leave no residue on the cleaned parts.

HINT

To check the number of sheets scanned with the ScanSnap, see [Total Page Count] in the [ScanSnap Manager - Scanner and driver information] window.

To open the [ScanSnap Manager - Scanner and driver information] window, right-click the ScanSnap

Manager icon  in the notification area located at the far right of the taskbar, and click [Help] → [ScanSnap information] from the "Right-Click Menu" (page 100).

1. Clean the glass and idler rollers.

1. Unplug the cables from the ScanSnap.
2. Open the top cover and output guide.

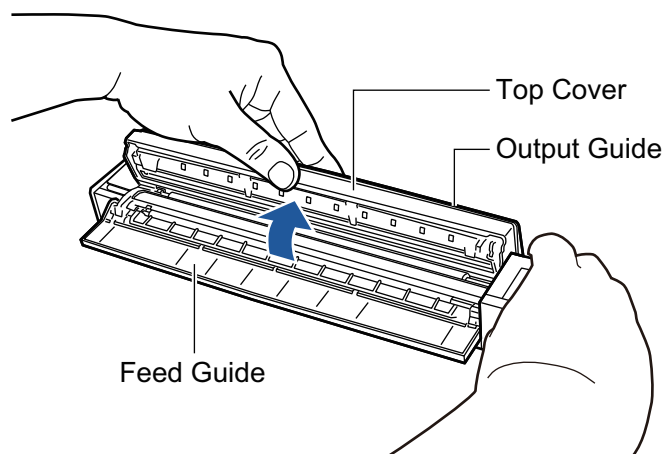

3. Clean the following locations with a cloth moistened with Cleaner F1.

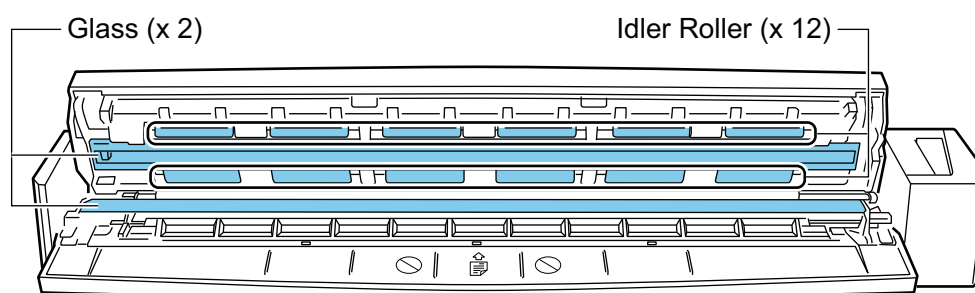

- Glass (× 2, one on the top cover and one on the opposite side)
Gently wipe the dirt and dust off the surface of the glass sections.
- Idler roller (× 12, located on the top cover)
Gently wipe the dirt and dust off the rollers as you rotate them manually. Be careful not to damage the surface of the rollers. Make sure that they are cleaned properly because residue on the rollers will affect the feeding performance.

2. Clean the feed rollers and eject rollers.

1. Connect the USB cable to the USB connector on the ScanSnap and the USB port on the computer, and press the [Scan/Stop] button for three seconds with the top cover open.

ATTENTION

Connect the USB cable to the USB port on the computer only when cleaning the feed rollers and eject rollers.

2. Clean the following locations with a cloth moistened with Cleaner F1.

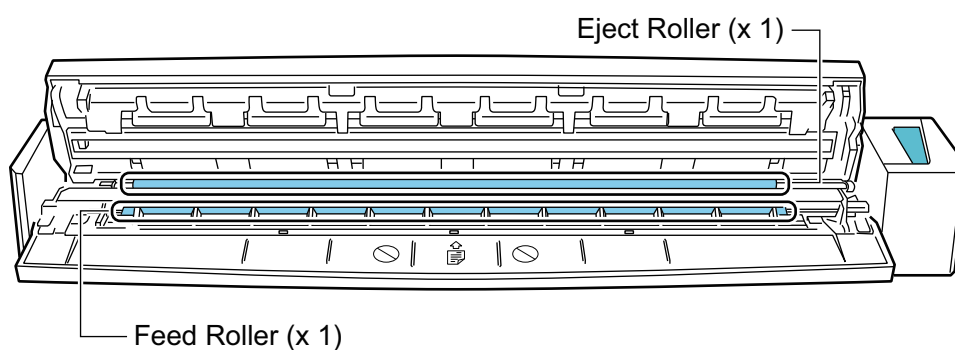

- Feed roller (× 1, located on the scanner side)

Press the [Scan/Stop] button to rotate the roller. Gently wipe the dirt and dust off while taking care not to damage the surface of the roller. Make sure that they are cleaned properly because residue on the roller will affect the feeding performance.

- Eject roller (× 1, located on the scanner side)

Press the [Scan/Stop] button to rotate the roller. Gently wipe the dirt and dust off while taking care not to damage the surface of the roller. Make sure that they are cleaned properly because residue on the roller will affect the feeding performance.

If the eject roller is difficult to clean, try cleaning it from the back of the ScanSnap while you keep the top cover slightly open.

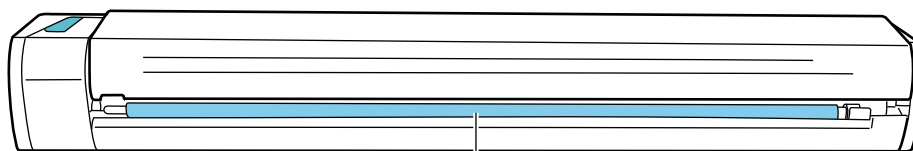

Eject Roller (x 1)

HINT

Pressing the [Scan/Stop] button seven times will rotate the feed roller and the eject roller one revolution.

3. Close the top cover and the output guide.

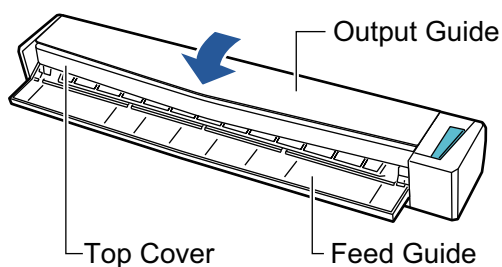

⇒ It clicks when it returns to its original position.

ATTENTION

Make sure that the top cover is completely closed.

Otherwise, paper jams or other feeding errors, or image faults may occur.

Cleaning the Carrier Sheet (iX1600 / iX1500 / iX1400 / iX1300 / iX500/ iX100 / S1100i)

As you keep using the Carrier Sheet, dirt and dust will accumulate on the surface and the inside.

Clean the Carrier Sheet regularly because it may result in scanning errors.

The procedure for cleaning the Carrier Sheet is as follows.

Cleaning

Gently wipe the dirt and dust off the surface and the inside of the Carrier Sheet with a dry cloth, or a cloth moistened with Cleaner F1/mild detergent.

ATTENTION

- Do not use paint thinner or any other organic solvents.
- Do not apply too much force when rubbing. Doing so may damage or deform the Carrier Sheet.
- Be careful not to leave any crease on the Carrier Sheet.
- Make sure that the part that holds the front and back sides of the Carrier Sheet does not come off when cleaning the inside of the Carrier Sheet.
- After cleaning the inside of the Carrier Sheet with a cloth moistened with Cleaner F1/mild detergent, make sure that it is completely dry before closing the Carrier Sheet.
- The Carrier Sheet should be replaced approximately every 500 scans.

Cleaning the Background Pad (SV600)

As you keep using the Background Pad, dirt and dust will accumulate on the surface.

Clean the Background Pad in the following procedure.

Cleaning

Clean the Background Pad with a dry or damp cloth.

ATTENTION

- Do not use any detergent.
- Keep the Background Pad away from fire or high-temperature objects.
- Do not wrinkle or fold the Background Pad.
- It is recommended that you store the Background Pad in the tube and bag in which the Background Pad was packaged.
- Keep the Background Pad out of direct sunlight when storing it.

Consumables for the ScanSnap (iX1600 / iX1500 / iX1400 / iX1300 / iX500 / S1300i)

- "Part Numbers and Replacement Cycle of Consumables (iX1600 / iX1500 / iX1400 / iX1300 / iX500 / S1300i)" (page 550)
- "Checking the Status of Consumables (iX1400 / iX1300 / iX500 / S1300i)" (page 552)
- "Replacing Consumables for iX1600 / iX1500 / iX1400" (page 553)
- "Replacing Consumables for iX1300" (page 560)
- "Replacing Consumables for iX500" (page 568)
- "Replacing Consumables for S1300i" (page 575)

Part Numbers and Replacement Cycle of Consumables (iX1600 / iX1500 / iX1400 / iX1300 / iX500 / S1300i)

The following table shows the part number of the consumables and the suggested replacement cycles.

Note that the suggested replacement cycles are guidelines for using A4 (80 g/m² [20 lb]) wood-free paper, as these cycles vary depending on the type of documents scanned.

Only use the specified consumables.

For details about purchasing the consumables, refer to "Suppliers of Consumables/Optional Parts" in "About Customer Support and Maintenance" (page 606).

Consumables for iX1600/iX1500/iX1400/iX500

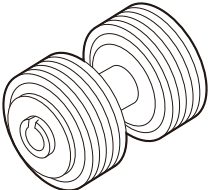
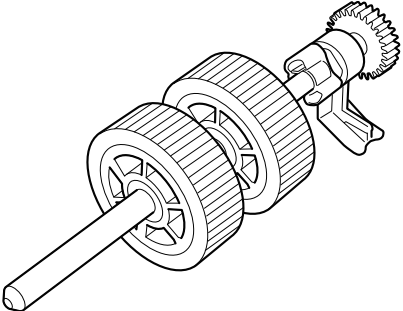
Product name	Part No.	Suggested replacement cycle
Roller Set ● Brake roller  ● Pick roller 	PA03656-0001	200,000 sheets or one year

Consumables for iX1300

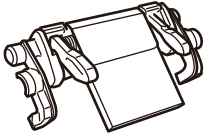
Product name	Part No.	Suggested replacement cycle
PAD UNIT 	PA03805-0022	30,000 sheets or one year

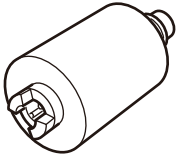
Product name	Part No.	Suggested replacement cycle
PICK ROLLER 	PA03805-0021	100,000 sheets or one year

Consumables for S1300i

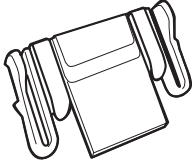
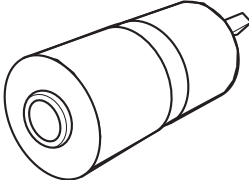
Product name	Part No.	Suggested replacement cycle
PAD ASSY 	PA03541-0002	10,000 sheets or one year
PICK ROLLER 	PA03541-0001	100,000 sheets or one year

Checking the Status of Consumables (iX1400 / iX1300 / iX500 / S1300i)

You can check the status of each consumable in the following procedure.

1. **Right-click the ScanSnap Manager icon  in the notification area located at the far right of the taskbar and select [Check consumable status] from the "Right-Click Menu" (page 100).**

⇒ The [ScanSnap Manager - Check consumable status] window appears.

2. **Check the status of each consumable.**

Refer to [Suggested replacement cycle] as a guideline and replace the consumables.

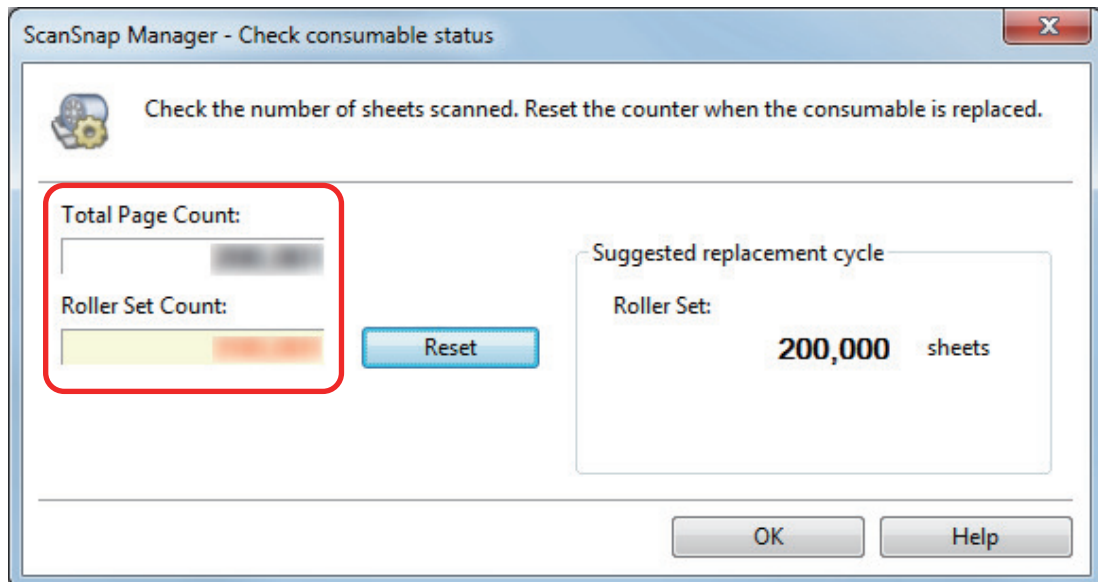

Example: The [ScanSnap Manager - Check consumable status] window for iX1400

Replacing Consumables for iX1600 / iX1500 / iX1400

The Roller Set consists of the brake roller and pick roller.

Replace the consumable (Roller Set) of the ScanSnap when the replacement cycle is reached.

The following shows the suggested replacement cycles.

- Every 200,000 sheets scanned

For iX1600/iX1500, note that a notification () appears on the touch panel when the number of sheets scanned reaches 200,000.

- Every one year of use

Replace the consumable when either the number of sheets scanned or the period of use reaches the suggested replacement cycle.

Replace each roller in the following procedure:



- Before replacing consumables, you must turn off the ScanSnap and unplug the power cable from the AC outlet. Not doing so may cause fire or electrical shock.
- Do not place internal parts such as the brake roller and the pick roller within reach of small children. Doing so may cause injury.

ATTENTION

The bottom part of the ScanSnap may become hot when the ScanSnap is being used but this does not affect ScanSnap operation or cause any physical harm. Be careful not to drop the ScanSnap when carrying it.

- 1. Unplug the power cable from the AC outlet.**
- 2. Remove any documents from the ADF paper chute (cover).**
- 3. Remove the Receipt Guide if it is attached.**

You can remove the Receipt Guide by holding it with one hand and pulling it.

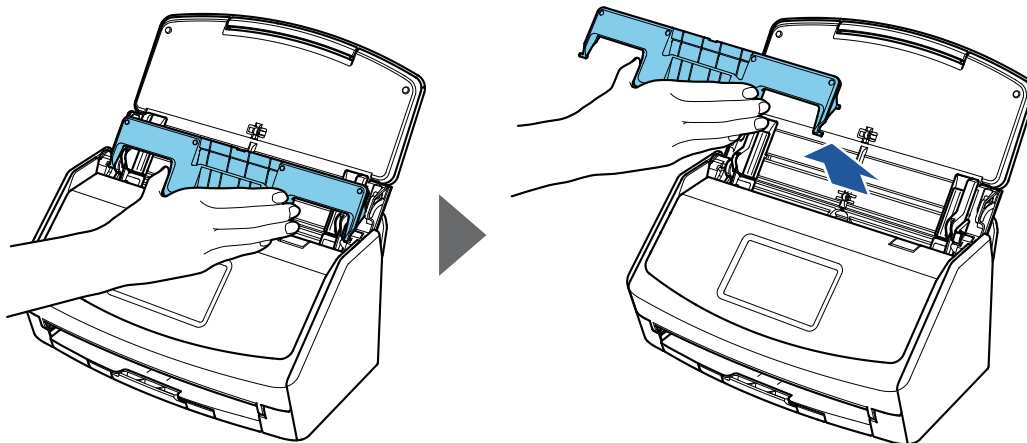

Example: iX1600

4. Pull the ADF release tab towards you to open the ADF top section.

The body of the ScanSnap may vary in color depending on the region where you purchased the ScanSnap.



Example: iX1600

5. Replace the brake roller.

1. Open the brake roller cover.

Hold both ends of the cover, and open it in the direction of the arrow.

The body of the ScanSnap may vary in color depending on the region where you purchased the ScanSnap.



2. Remove the shaft of the brake roller from the ScanSnap.

Lift the brake roller to remove the right side of the shaft, and then pull out the shaft from the hole on the left.

The body of the ScanSnap may vary in color depending on the region where you purchased the ScanSnap.

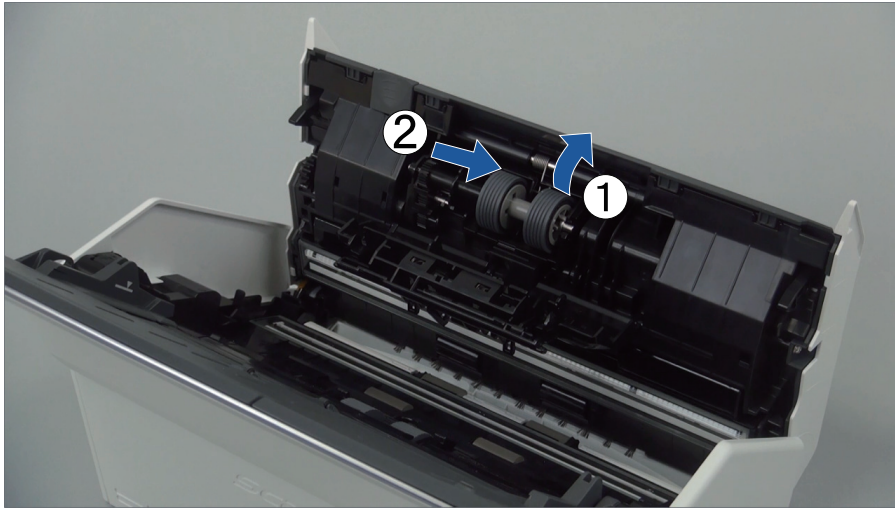

3. Remove the brake roller from the shaft.

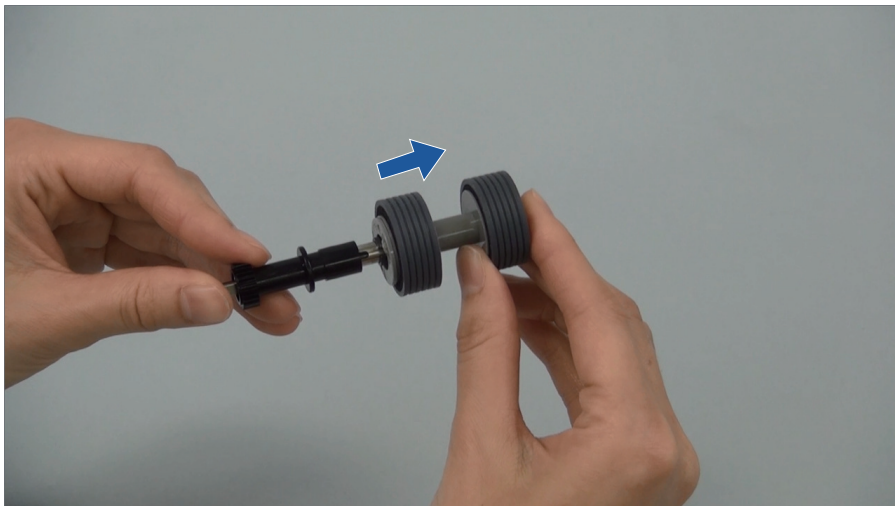

4. Attach the new brake roller to the shaft.

Insert the shaft to the brake roller by aligning the protrusion on the shaft with the slot on the brake roller.

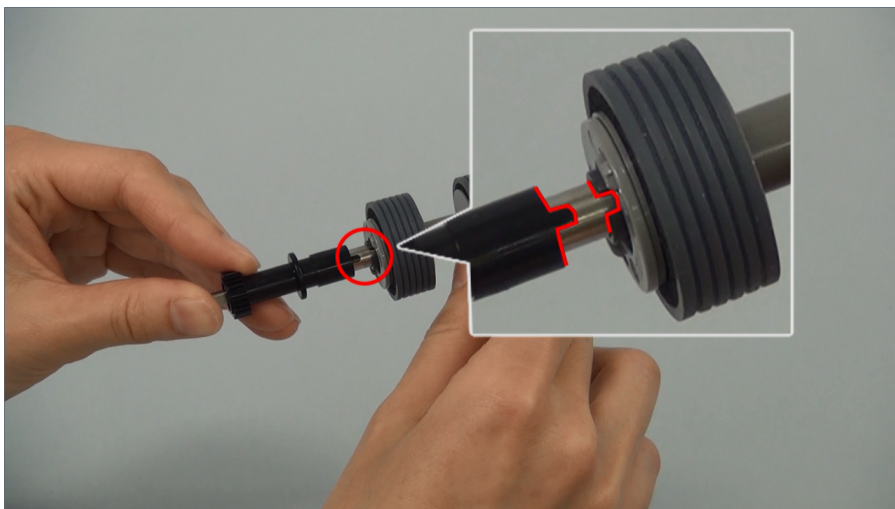

5. Attach the shaft to the ScanSnap.

Insert the left end of the shaft in the hole properly, and then attach the right side of the shaft into place.

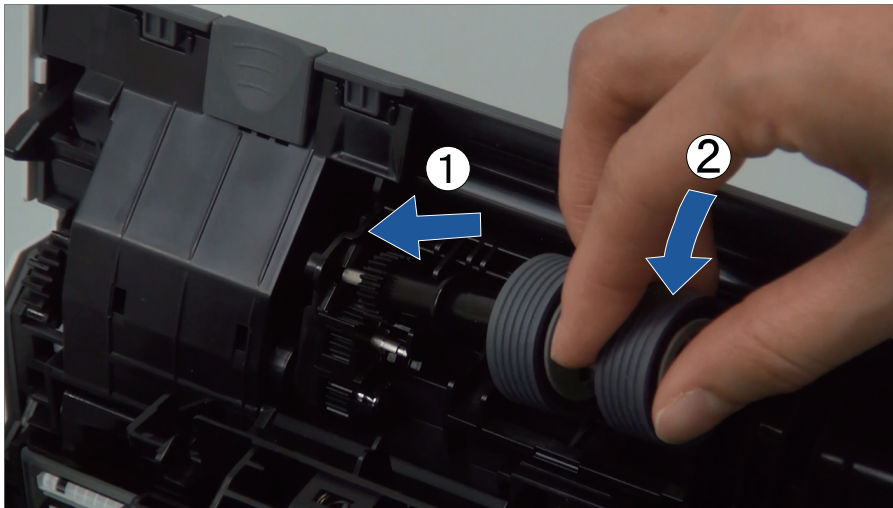

6. Close the brake roller cover.

ATTENTION

Make sure that the shaft is attached firmly. Otherwise, paper jams or other feeding errors may occur.

6. Replace the pick roller.

1. Open the sheet guide.

Slide the side guides all the way. Open the sheet guide by hooking your finger in the dip of the sheet guide.

The body of the ScanSnap may vary in color depending on the region where you purchased the ScanSnap.

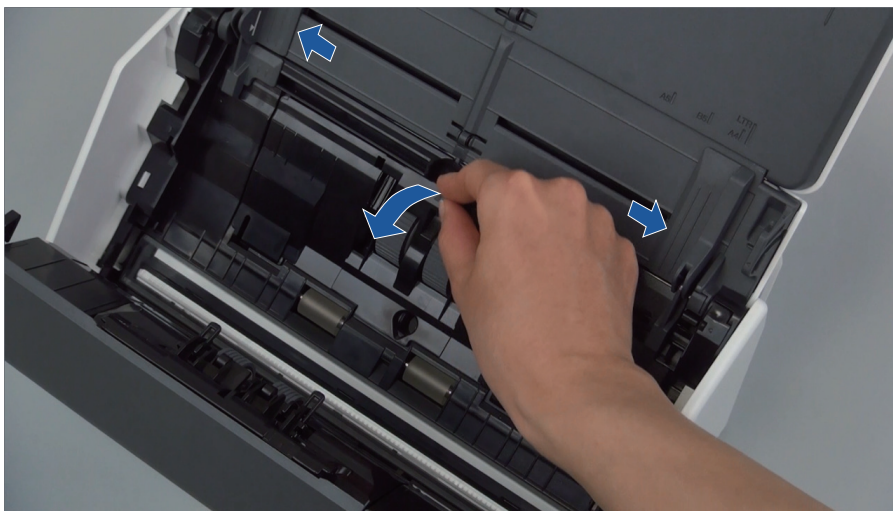

2. Rotate the bushing in the direction of the arrow.

The body of the ScanSnap may vary in color depending on the region where you purchased the ScanSnap.

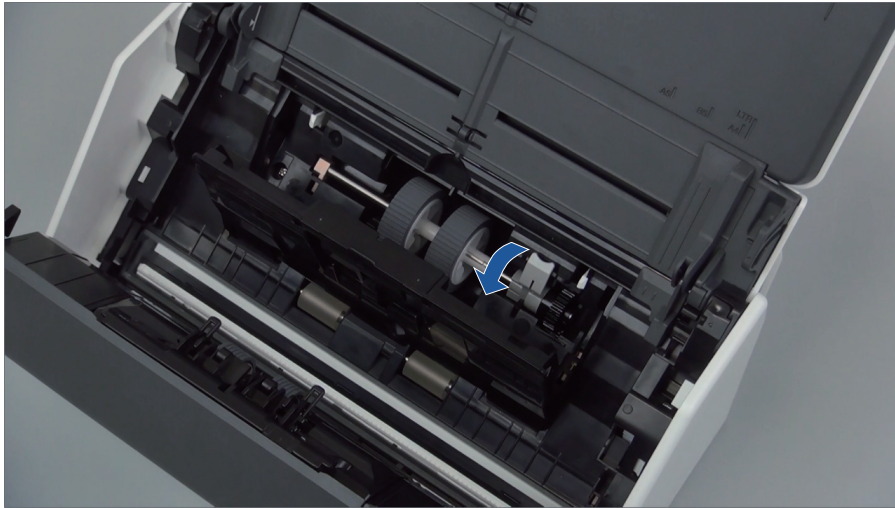

3. Remove the pick roller.

Lift the right side of the bushing slightly (about 5 mm), move it toward the right, and then lift it upward to pull out the pick roller.

The body of the ScanSnap may vary in color depending on the region where you purchased the ScanSnap.

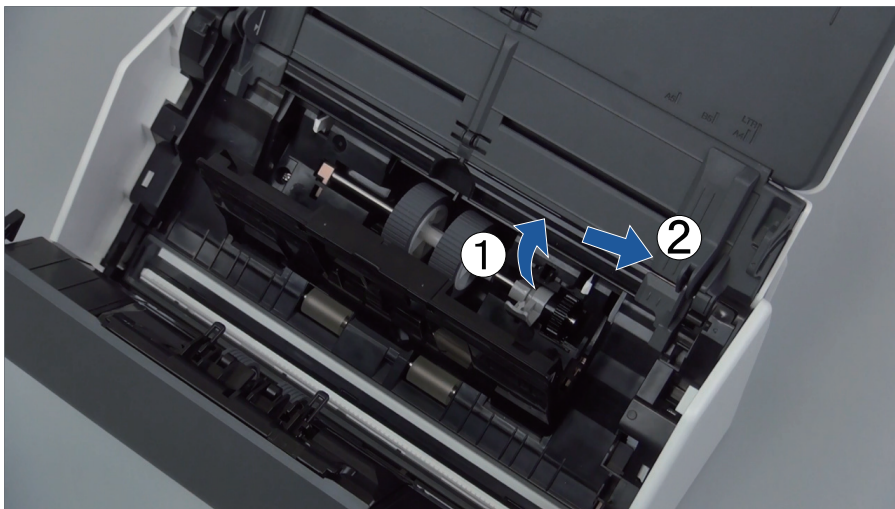

ATTENTION

Be careful not to touch the grease on the gear near the bushing.

4. Attach a new pick roller to the ScanSnap.

Insert the left end of the shaft into the left-side hole, and then slowly attach the right end of the shaft into place.

The body of the ScanSnap may vary in color depending on the region where you purchased the ScanSnap.

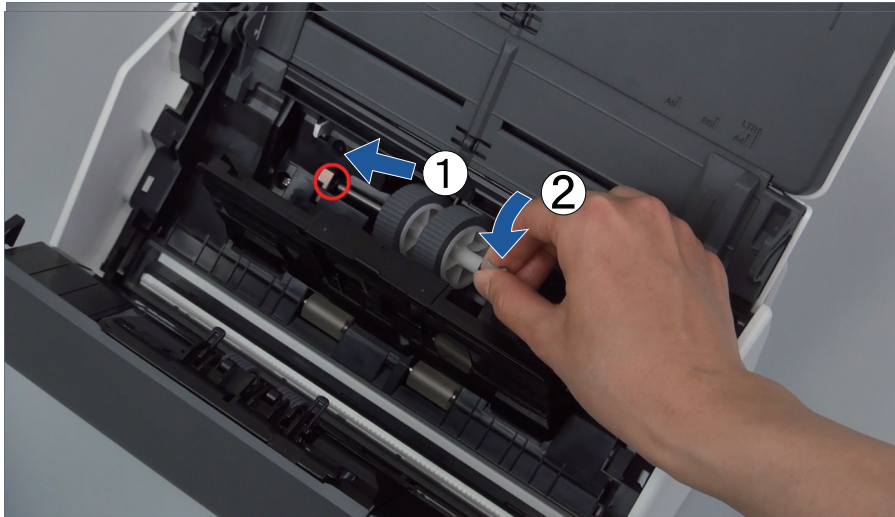

5. Rotate the bushing in the direction of the arrow.

The body of the ScanSnap may vary in color depending on the region where you purchased the ScanSnap.

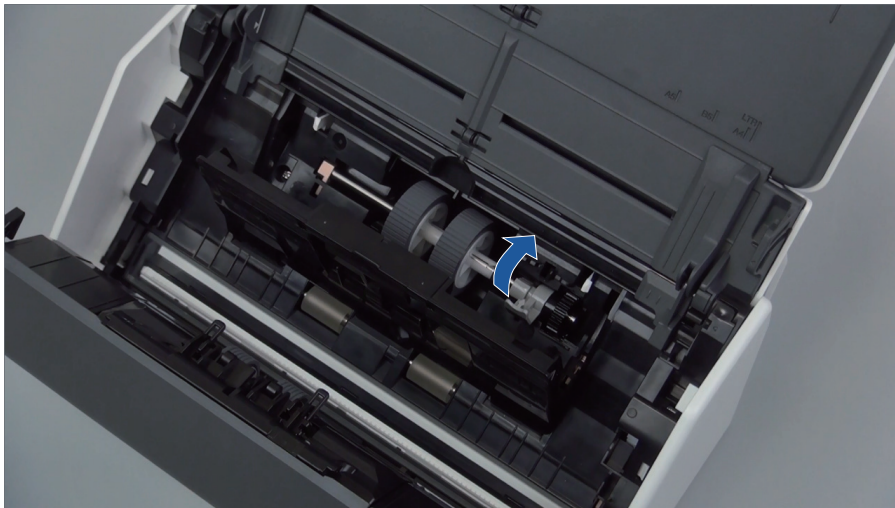

ATTENTION

Make sure that the pick roller is attached firmly. Otherwise, paper jams or other feeding errors may occur.

6. Close the sheet guide.
Make sure that both sides of the sheet guide are locked firmly.

7. Close the ADF top section.

The body of the ScanSnap may vary in color depending on the region where you purchased the ScanSnap.

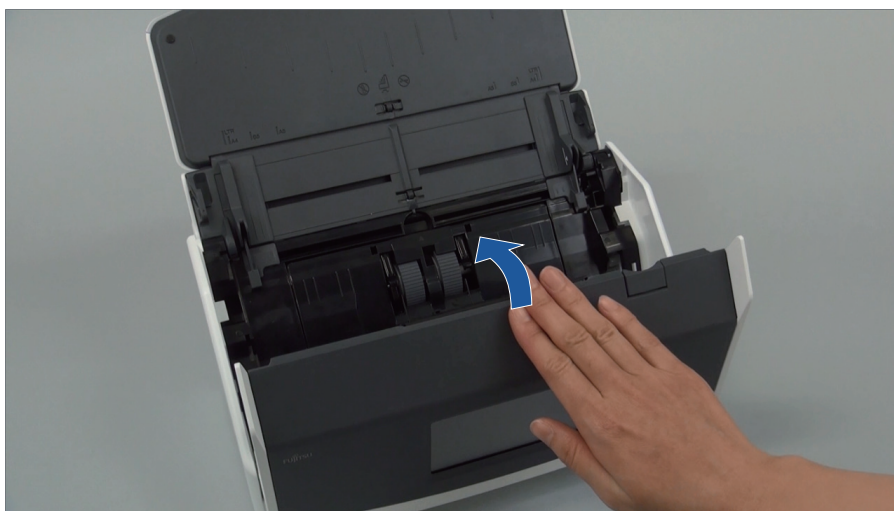

Example: iX1600

⇒ It clicks when it returns to its original position.

8. Connect the power cable to the AC outlet, and turn on the ScanSnap.

9. Reset the Roller Set counter.

iX1600/iX1500

1. Press  in the [home screen](#) on the touch panel to display the [Settings] screen.



2. Press  to display the [Maintenance] screen.
3. Press [Check consumable status] to display the [Check consumable status] screen.
4. Press the [Reset] button.
5. When a message is displayed, press the [OK] button.
 - ⇒ The value of the current count for the [Current Count / Replacement Cycle] is set to "0".

iX1400

1. Right-click the ScanSnap Manager icon  in the notification area located at the far right of the taskbar and select [Check consumable status] from the "[Right-Click Menu](#)" (page 100).
 - ⇒ The [ScanSnap Manager - Check consumable status] window appears.
2. Click the [Reset] button for [Roller Set Count].
 - ⇒ A confirmation window appears.
3. Click the [Yes] button.
 - ⇒ [Roller Set Count] is reset to 0.

Replacing Consumables for iX1300

This section explains how to replace the pad unit and the pick roller.



- Before replacing consumables, you must turn off the ScanSnap and unplug the power cable from the AC outlet. Not doing so may cause fire or electrical shock.
- Do not place internal parts such as the pad unit and the pick roller within reach of small children. Doing so may cause injury.

ATTENTION

The bottom part of the ScanSnap may become hot when the ScanSnap is being used, but this does not affect ScanSnap operation or cause any physical harm. Be careful not to drop the ScanSnap when carrying it.

- ["Replacing the Pad Unit \(iX1300\)" \(page 561\)](#)
- ["Replacing the Pick Roller \(iX1300\)" \(page 564\)](#)

Replacing the Pad Unit (iX1300)

Replace the pad unit in the following procedure:

1. **Unplug the power cable from the AC outlet.**
2. **Remove any documents from the ADF paper chute (cover).**
3. **Pull the ADF release tab towards you to open the ADF top section.**

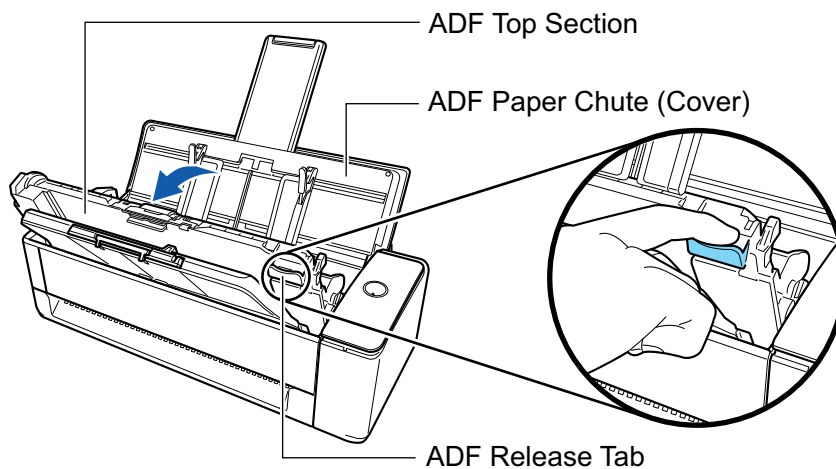

4. **Remove the pad unit.**

Squeeze both ends of the pad unit (the gray parts protruding outwards) and pull it out.



ATTENTION

Do not hold any parts other than both ends of the pad unit (the gray parts protruding outwards).

5. **Attach the new pad unit.**

Fit the protrusions of the pad unit in the slots.

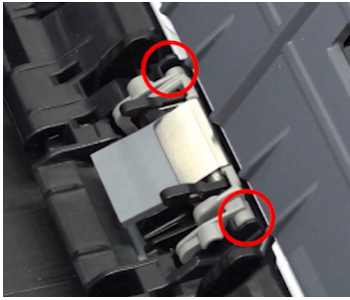

ATTENTION

- Attach the pad unit with the front side up. If the pad unit is attached upside down, paper jams or other feeding errors may occur.

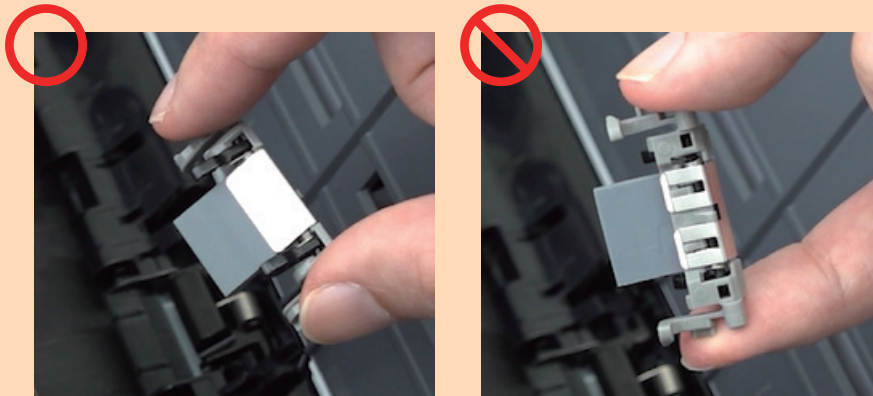

- Make sure that the pad unit is attached firmly. Otherwise, paper jams or other feeding errors may occur.

6. Make sure that the arms of the pad unit are not raised.

If the arms of the pad unit are raised, push them down.



7. Close the ADF top section.

Close the ADF top section together with the stacker until it locks into position, indicated by a clicking sound.

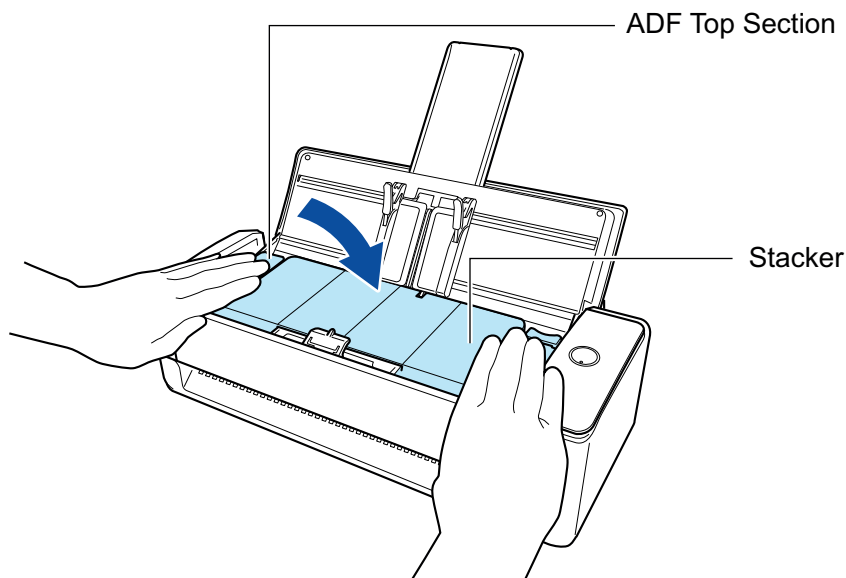
**ATTENTION**

Make sure that the ADF top section is completely closed.
Otherwise, paper jams or other feeding errors, or image faults may occur.

8. Connect the power cable to the AC outlet, and turn on the ScanSnap.**9. Reset the pad unit count.**

1. Click the ScanSnap Manager icon  in the notification area located at the far right of the taskbar and select [Check consumable status] from the "Right-Click Menu" (page 100).
⇒ The [ScanSnap Manager - Check consumable status] window appears.
2. Click the [Reset] button for [PAD ASSY Count].
⇒ A confirmation window appears.
3. Click the [Yes] button.
⇒ [PAD ASSY Count] is reset to 0.

Replacing the Pick Roller (iX1300)

Replace the pick roller in the following procedure:

- 1. Unplug the power cable from the AC outlet.**
- 2. Remove any documents from the ADF paper chute (cover).**
- 3. Pull the ADF release tab towards you to open the ADF top section.**

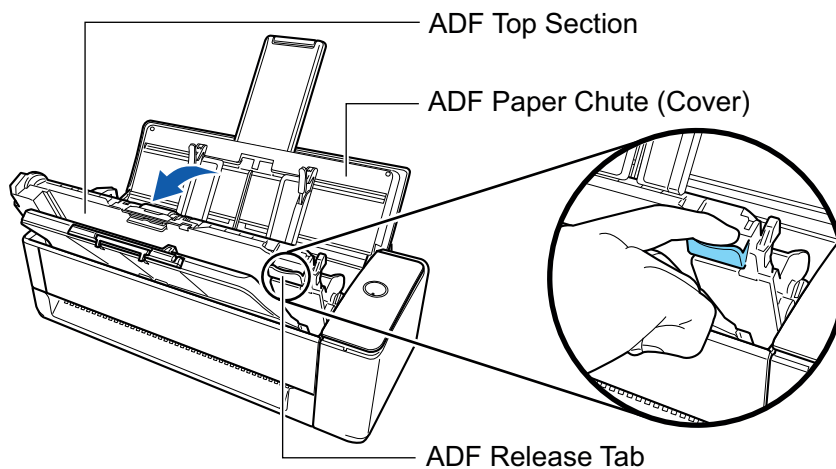

- 4. Open the sheet guide.**



- 5. Remove the pick roller.**

Pull out the pick roller from the shaft, and then lift it upward to remove it.

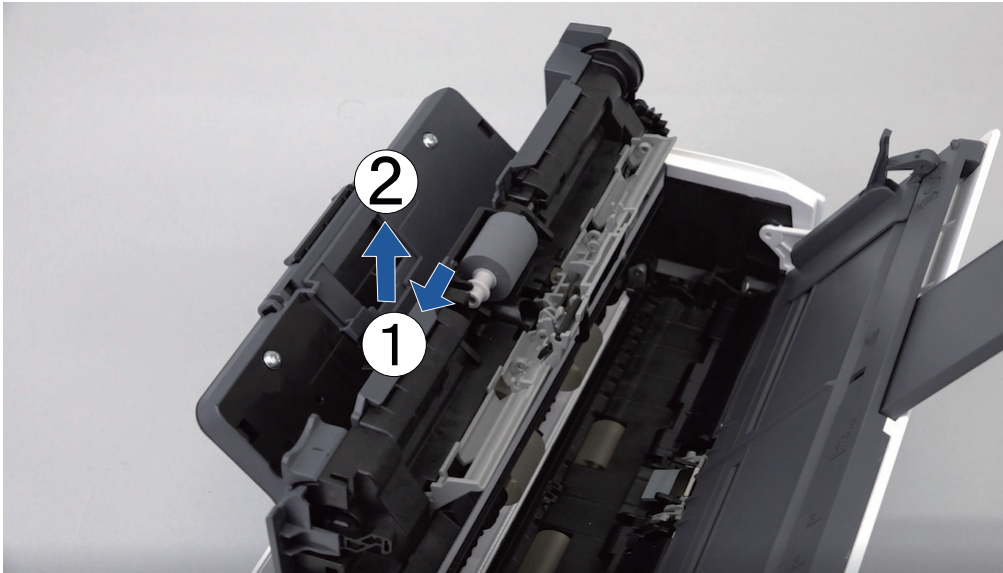
**ATTENTION**

There may be paper dust around the pick roller.

Wipe off the paper dust with a cloth moistened with Cleaner F1. Not doing so may cause image faults.

Do not use water, mild detergent, or aerosol spray.

6. Attach a new pick roller.

Insert the protrusion of the shaft into the slot of the pick roller.

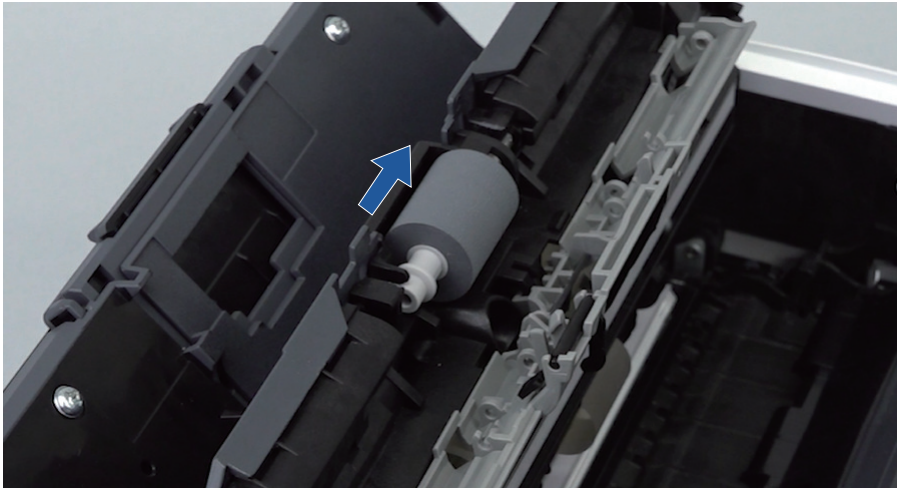

**ATTENTION**

Make sure that the pick roller is attached firmly. Otherwise, paper jams or other feeding errors may occur.

7. Close the sheet guide.

Make sure that both sides of the sheet guide are firmly in place.

8. Close the ADF top section.

Close the ADF top section together with the stacker until it locks into position, indicated by a clicking sound.

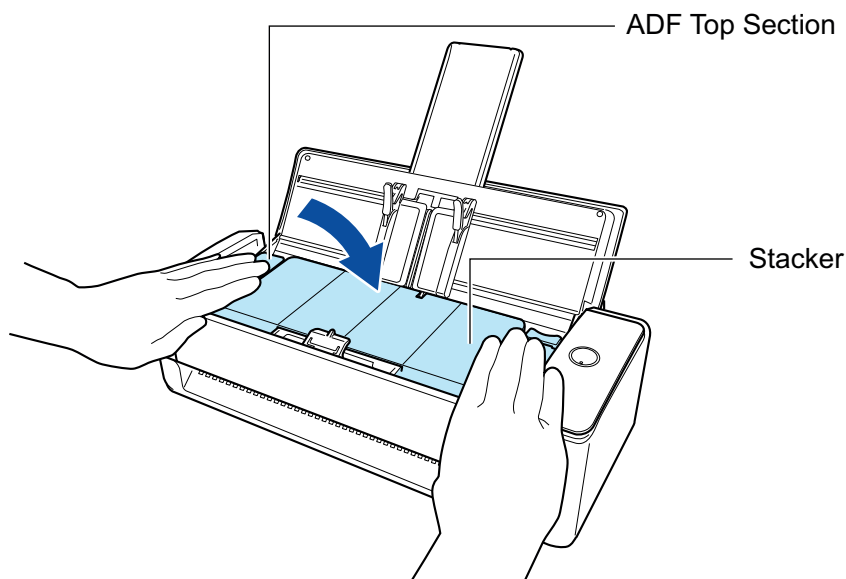
**ATTENTION**

Make sure that the ADF top section is completely closed.
Otherwise, paper jams or other feeding errors, or image faults may occur.

9. Connect the power cable to the AC outlet, and turn on the ScanSnap.**10. Reset the pick roller count.**

1. Click the ScanSnap Manager icon  in the notification area located at the far right of the taskbar and select [Check consumable status] from the "Right-Click Menu" (page 100).
→ The [ScanSnap Manager - Check consumable status] window appears.
2. Click the [Reset] button for [PICK ROLLER Count].
⇒ A confirmation window appears.
3. Click the [Yes] button.
⇒ [PICK ROLLER Count] is reset to 0.

Replacing Consumables for iX500

The Roller Set consists of the brake roller and pick roller.

Replace each roller in the following procedure:



- Before replacing consumables, you must turn off the ScanSnap and unplug the power cable from the AC outlet. Not doing so may cause fire or electrical shock.
- Do not place internal parts such as the brake roller and the pick roller within reach of small children. Doing so may cause injury.

ATTENTION

The bottom part of the ScanSnap may become hot when the ScanSnap is being used but this does not affect ScanSnap operation or cause any physical harm. Be careful not to drop the ScanSnap when carrying it.

- 1. Unplug the power cable from the AC outlet.**
- 2. Remove any documents from the ADF paper chute (cover).**
- 3. Pull the ADF release tab towards you to open the ADF top section.**

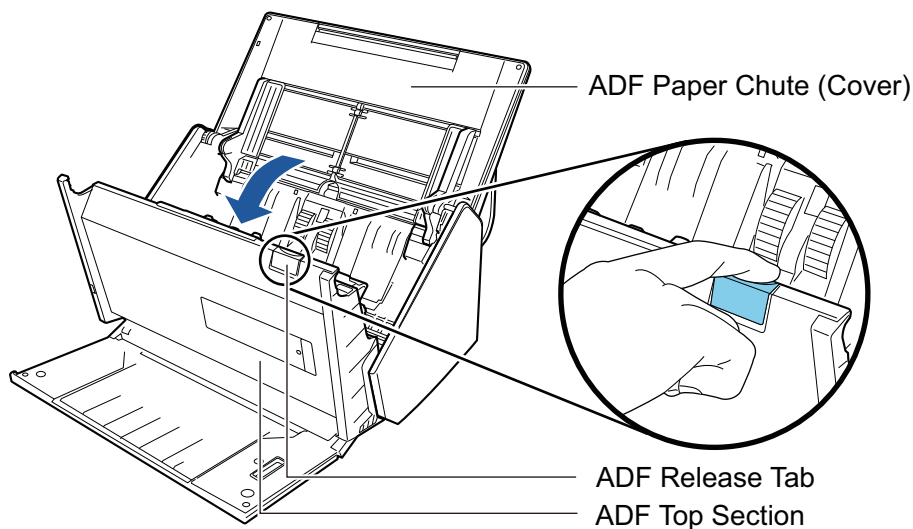

4. Replace the brake roller.

1. Open the brake roller cover.

Hold both ends of the cover, and open it in the direction of the arrow.

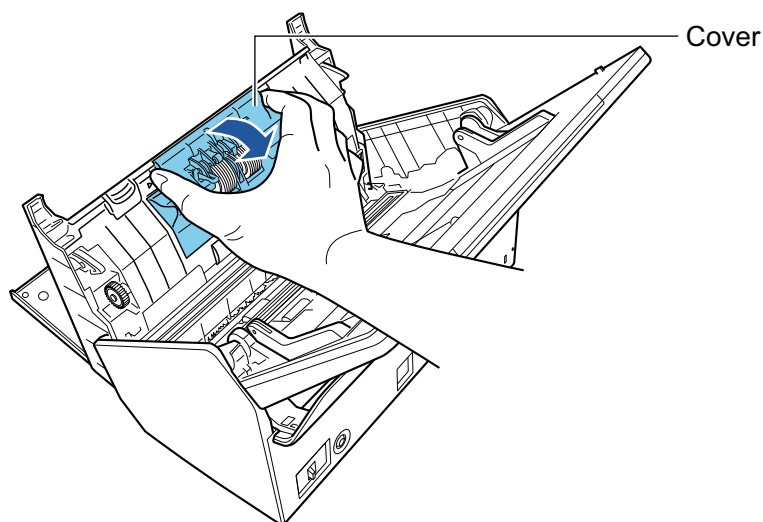

2. Remove the shaft of the brake roller from the ScanSnap.

Lift the brake roller to remove the right side of the shaft, and then pull out the shaft from the hole on the left.

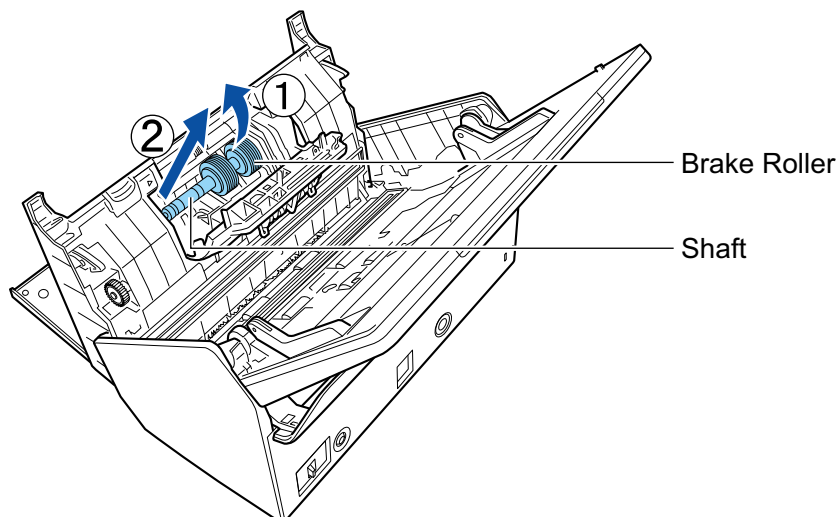

3. Remove the brake roller from the shaft.

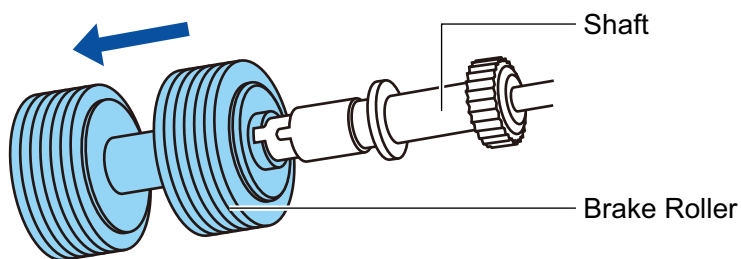

4. Attach the new brake roller to the shaft.

Insert the shaft to the brake roller by aligning the protrusion on the shaft with the slot on the brake roller.

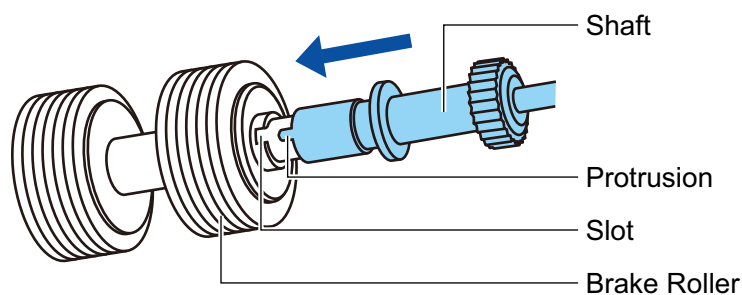

5. Attach the shaft to the ScanSnap.

Insert the left end of the shaft in the hole properly, and then attach the right side of the shaft into place.

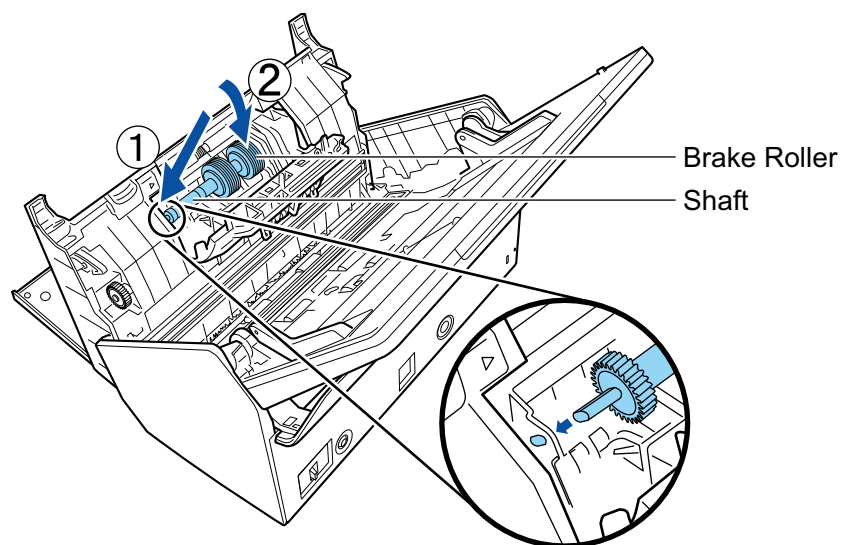

6. Close the brake roller cover.

ATTENTION

Make sure that the shaft is attached firmly. Otherwise, paper jams or other feeding errors may occur.

5. Replace the pick roller.

1. Open the sheet guide.

Slide the side guides all the way. Open the sheet guide by hooking your finger in the dip of the sheet guide.

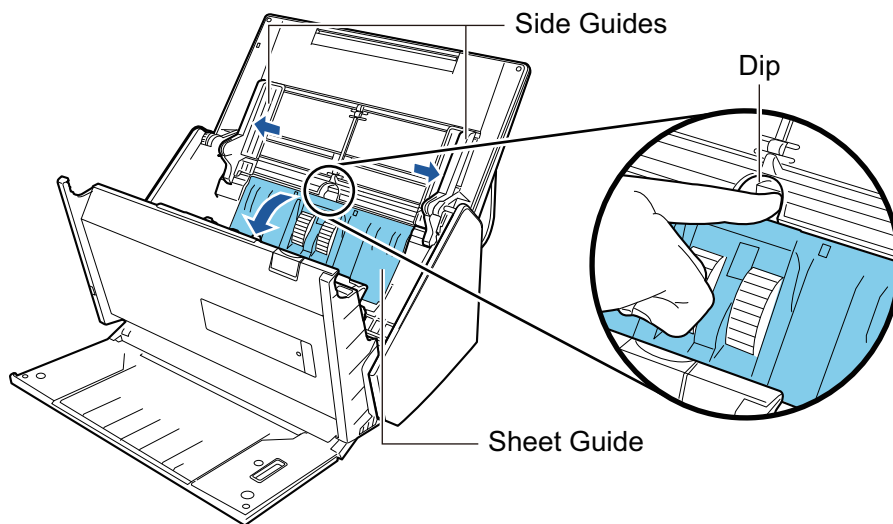

2. Rotate the bushing in the direction of the arrow.

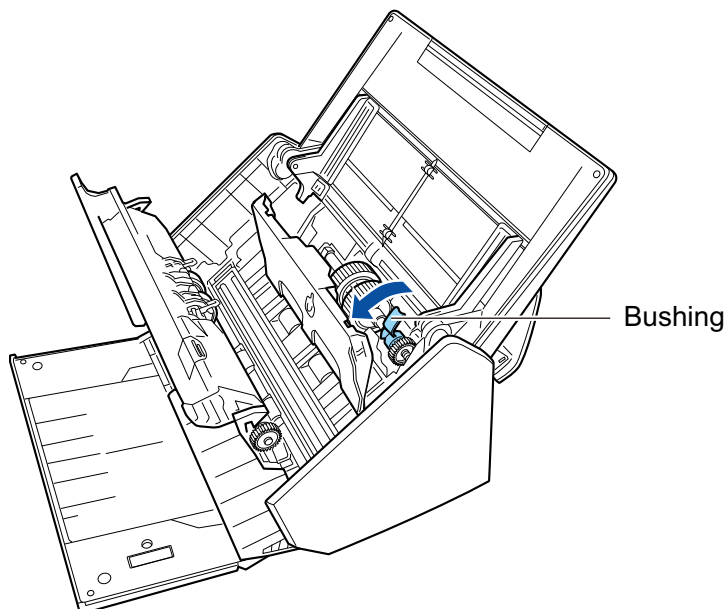

3. Remove the pick roller.

Lift the right side of the bushing slightly (about 5 mm), move it toward the right, and then lift it upward to pull out the pick roller.

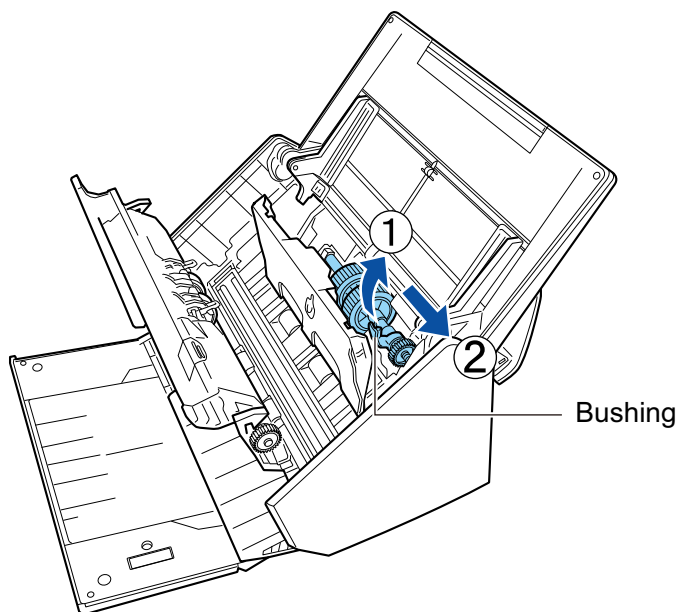

ATTENTION

Be careful not to touch the grease on the gear near the bushing.

4. Attach a new pick roller to the ScanSnap.

Insert the left end of the shaft into the left-side hole, and then slowly attach the right end of the shaft into place.

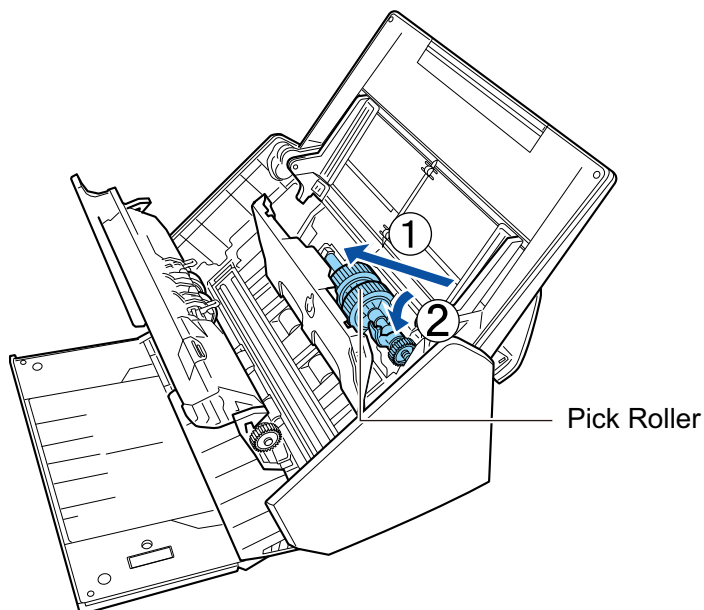

5. Rotate the bushing in the direction of the arrow.

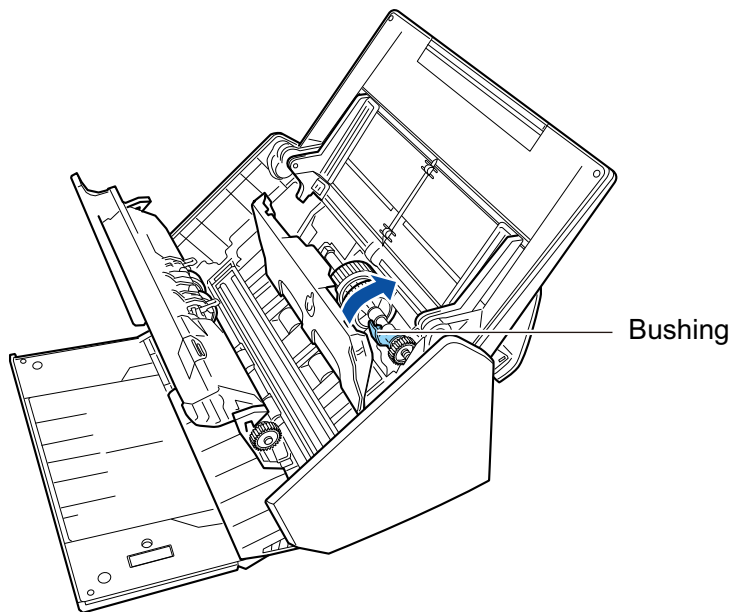

ATTENTION

Make sure that the pick roller is attached firmly. Otherwise, paper jams or other feeding errors may occur.

6. Close the sheet guide.
Make sure that both sides of the sheet guide are locked firmly.

6. Close the ADF top section.

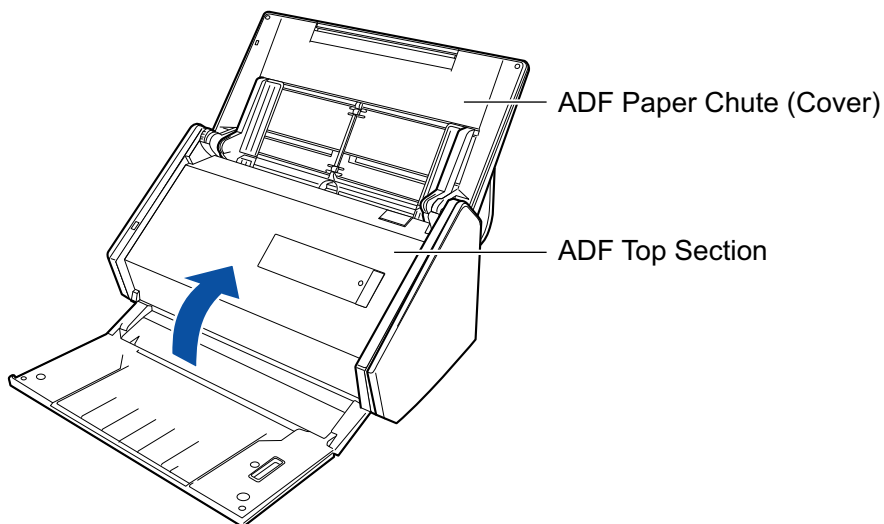

⇒ It clicks when it returns to its original position.

7. Connect the power cable to the AC outlet, and turn on the ScanSnap.

8. Reset the roller set count.

1. Right-click the ScanSnap Manager icon  in the notification area located at the far right of the taskbar and select [Check consumable status] from the "Right-Click Menu" (page 100).
⇒ The [ScanSnap Manager - Check consumable status] window appears.

2. Click the [Reset] button for [Roller Set Count].
 - ⇒ A confirmation window appears.
3. Click the [Yes] button.
 - ⇒ [Roller Set Count] is reset to 0.

Replacing Consumables for S1300i

This section explains how to replace the pad assy and the pick roller assembly.



- Before replacing consumables, you must turn off the ScanSnap and unplug the power connection cable (power cable or USB bus power cable) from the power supply source (AC outlet or computer). Not doing so may cause fire or electrical shock.
- Do not place internal parts such as the pad assy and the pick roller assembly within reach of small children. Doing so may cause injury.

ATTENTION

The bottom part of the ScanSnap may become hot when the ScanSnap is being used but this does not affect ScanSnap operation or cause any physical harm. Be careful not to drop the ScanSnap when carrying it.

- ["Replacing the Pad Assy \(S1300i\)" \(page 576\)](#)
- ["Replacing the Pick Roller Assembly \(S1300i\)" \(page 579\)](#)

Replacing the Pad Assy (S1300i)

Replace the pad assy in the following procedure:

- 1. Unplug the power connection cable (power cable or USB bus power cable) from the power supply source (AC outlet or computer).**
- 2. Remove any documents from the ADF paper chute (cover).**
- 3. Pull the ADF release tab towards you to open the ADF top section.**

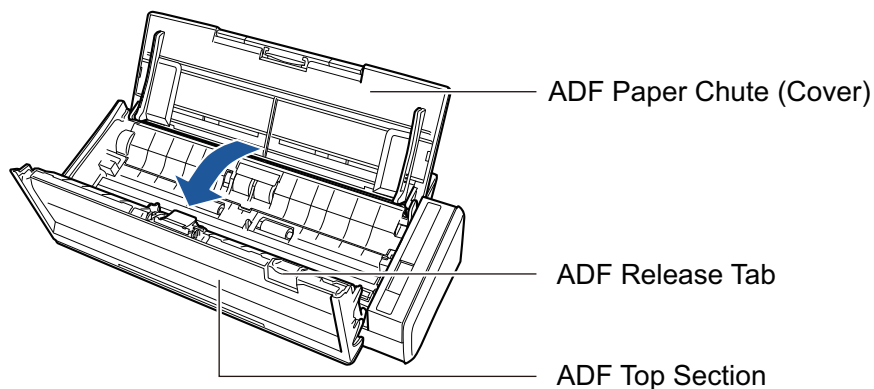

- 4. Remove the pad assy.**

Hold the both ends of the pad assy and remove it in the direction of the arrow.

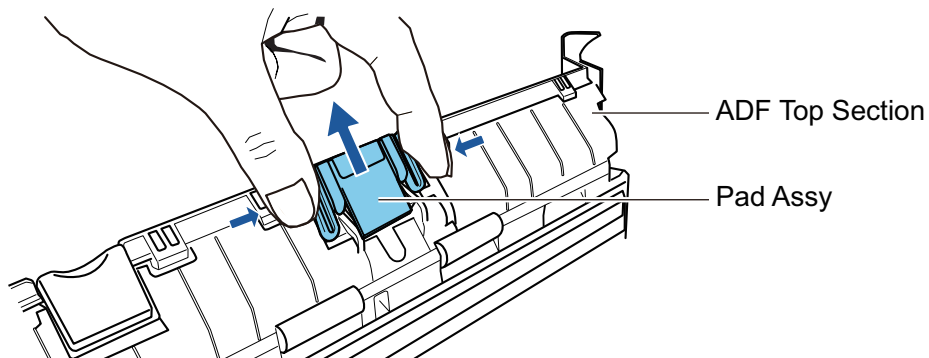

- 5. Attach the new pad assy while pressing the pad plate.**

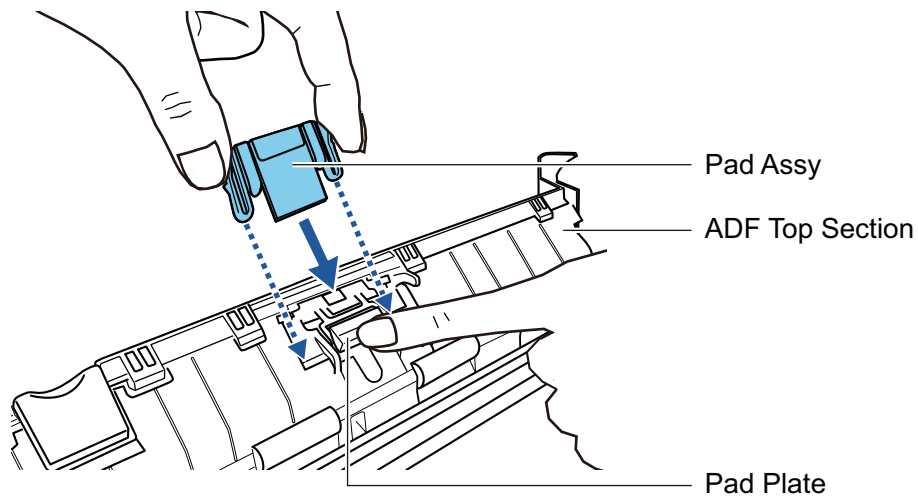
**ATTENTION**

Attach the pad assy with the front side up.

If the pad assy is attached upside down, paper jams or other feeding errors may occur.

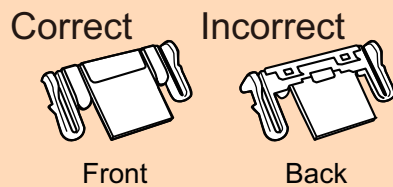
**6. Make sure that the pad assy is attached to the retaining hook firmly.****ATTENTION**

Make sure that the pad assy is attached firmly. Otherwise, paper jams or other feeding errors may occur.

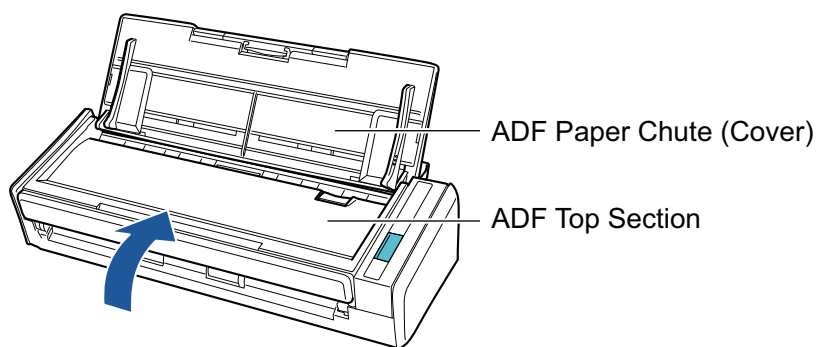
7. Close the ADF top section.

→ It clicks when it returns to its original position.

8. Connect the power connection cable (power cable or USB bus power cable) to the power supply source (AC outlet or computer), and turn on the ScanSnap.**9. Reset the pad assy count.**

1. Click the ScanSnap Manager icon  in the notification area located at the far right of the taskbar and select [Check consumable status] from the "Right-Click Menu" (page 100).
→ The [ScanSnap Manager - Check consumable status] window appears.
2. Click the [Reset] button for [PAD ASSY Count].
→ A confirmation window appears.
3. Click the [Yes] button.
→ [PAD ASSY Count] is reset to 0.

Replacing the Pick Roller Assembly (S1300i)

Replace the pick roller assembly in the following procedure:

- 1. Unplug the power connection cable (power cable or USB bus power cable) from the power supply source (AC outlet or computer).**
- 2. Remove any documents from the ADF paper chute (cover).**
- 3. Pull the ADF release tab towards you to open the ADF top section.**

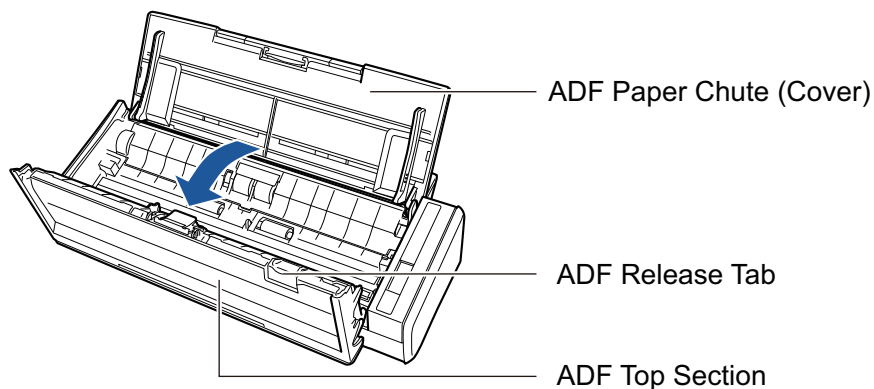

- 4. Remove the sheet guide.**

While holding the squeeze clip on the right end and pressing it inward, lift the sheet guide to remove it.

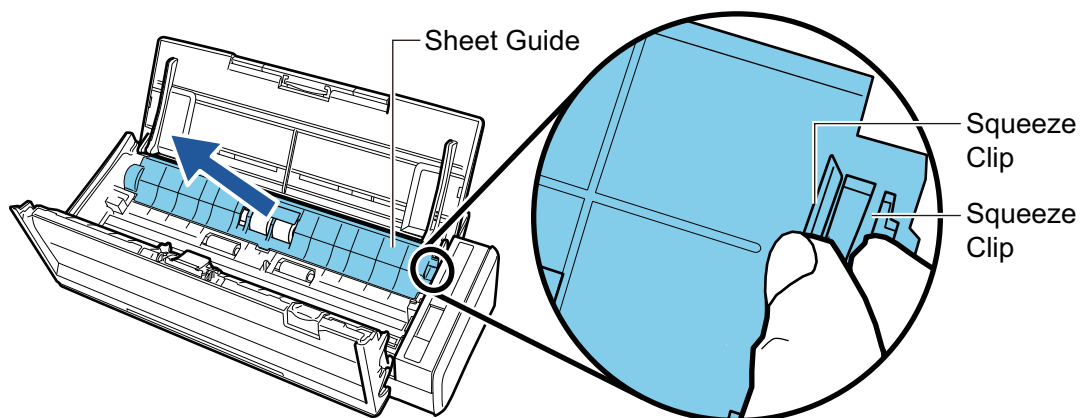

- 5. Turn the bushing that is on the left.**

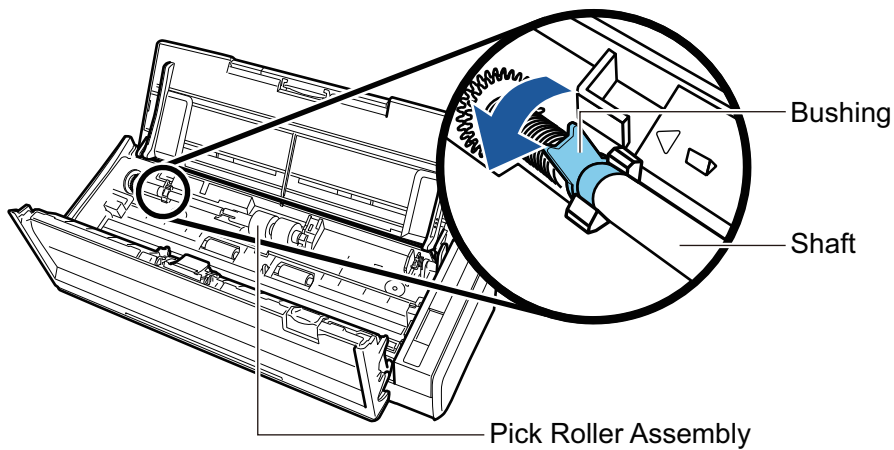

6. Remove the shaft of the pick roller from the ScanSnap.

Lift the left side of the shaft slightly (about 5 mm), move it toward the left, and then lift it upward to pull it out.

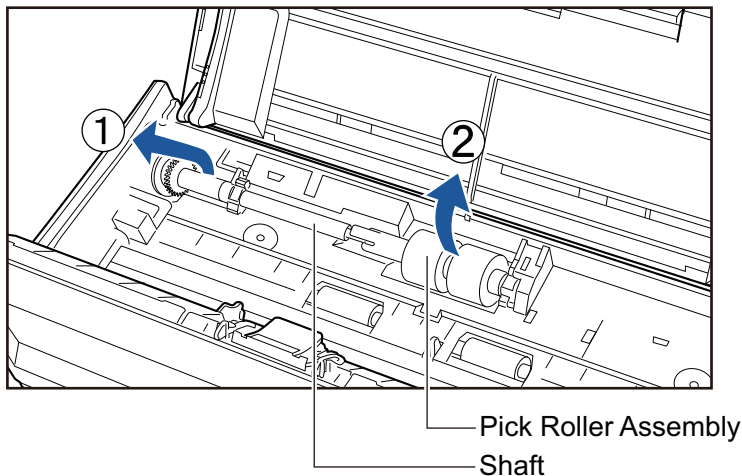

ATTENTION

There may be paper dust around the pick roller assembly.

Wipe off the paper dust with a cloth moistened with Cleaner F1. Not doing so may cause image faults.

Do not use water, mild detergent, or aerosol spray.

7. Remove the pick roller assembly from the shaft.

→ While lifting the retaining clip of the pick roller assembly, pull out the shaft.

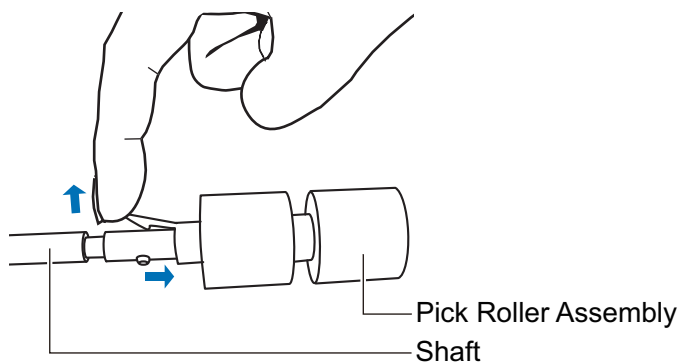

ATTENTION

Lifting the retaining clip with your fingernail may hurt or damage your fingernail.
Use a paper clip or something alike if you have trouble lifting it up.

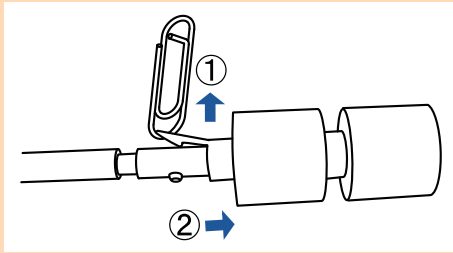
**8. Attach the new pick roller assembly to the shaft.**

Insert the drive pin of the shaft into the slot of the pick roller assembly.

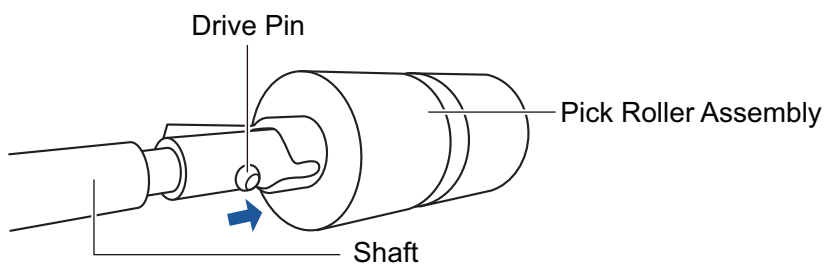
**9. Attach the shaft to the ScanSnap.**

Insert the right end of the shaft into the bushing on the right side, and then slowly attach the left end of the shaft into place.

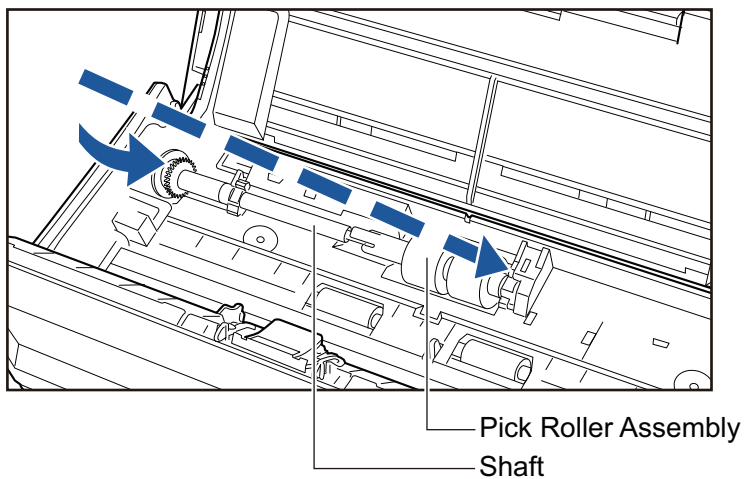
**10. Secure the bushing on the left.**

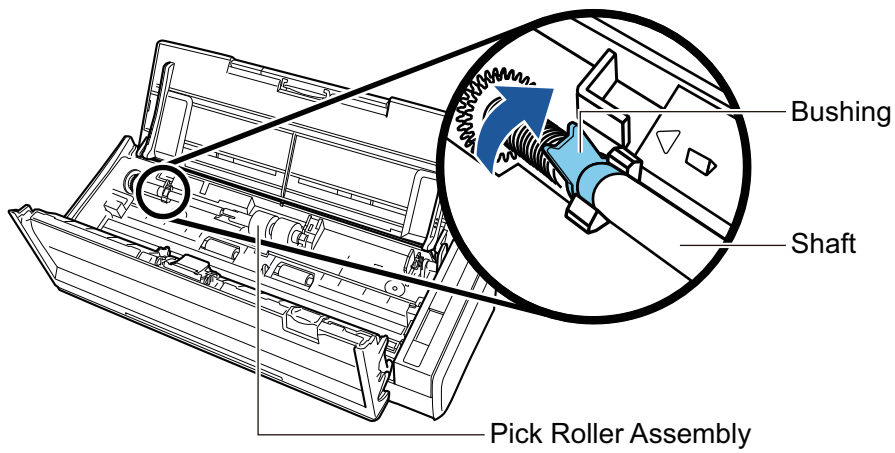

ATTENTION

Make sure that the shaft is attached firmly. Otherwise, paper jams or other feeding errors may occur.

11. Attach the sheet guide.

While holding the squeeze clip on the right end, attach the sheet guide to its original position.

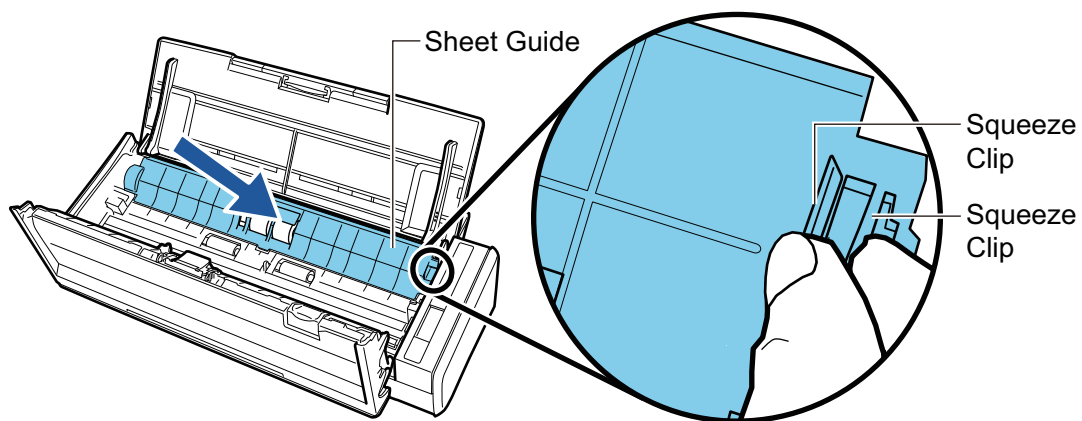

→ It clicks when the squeeze clip is locked in place.

ATTENTION

Make sure that the sheet guide is attached firmly. Otherwise, paper jams or other feeding errors may occur.

12. Close the ADF top section.

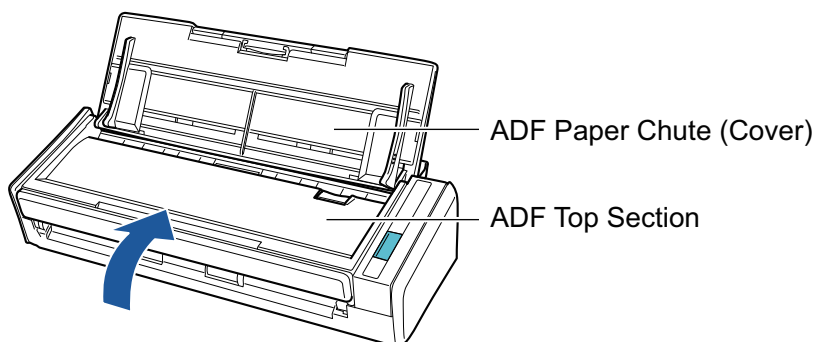

→ It clicks when it returns to its original position.

13. Connect the power connection cable (power cable or USB bus power cable) to the power supply source (AC outlet or computer), and turn on the ScanSnap.

14. Reset the pick roller count.

1. Click the ScanSnap Manager icon  in the notification area located at the far right of the taskbar and select [Check consumable status] from the "Right-Click Menu" (page 100).
→ The [ScanSnap Manager - Check consumable status] window appears.
2. Click the [Reset] button for [PICK ROLLER Count].
→ A confirmation window appears.
3. Click the [Yes] button.
→ [PICK ROLLER Count] is reset to 0.

Appendix

- "Updating the Software" (page 585)
- "Updating the Firmware (iX1600 / iX1500)" (page 586)
- "Uninstalling the Software" (page 587)
- "Part Number of the Background Pad (SV600)" (page 589)
- "Part Number of the Carrier Sheet (iX1600 / iX1500 / iX1400 / iX1300 / iX500 / iX100 / S1100i)" (page 590)
- "Specifications of the ScanSnap" (page 591)

Updating the Software

Latest updates for ScanSnap related software are available for free from our download server. This is called ScanSnap Online Update.

It is recommended that you apply latest updates to enhance security, operability and functions.

For the software programs that can be updated, refer to the following:

<https://scansnap.fujitsu.com/jp/downloads/online-setup-help-ww.html>

ScanSnap Online Update checks the download server periodically.

When the latest version of ScanSnap is available, a notification appears.

To install the update, click on the notification and follow the instructions on the window that appears.

For details, refer to the ScanSnap Online Update Help.

You can also manually check from ScanSnap Manager whether a newer version of the program is available and run the update.

- 1. Right-click the ScanSnap Manager icon  in the notification area located at the far right of the task bar and click [Help] → [Online Update] from the "Right-Click Menu" (page 100).**

⇒ ScanSnap Online Update checks whether a newer version of ScanSnap Manager is available. Proceed with the update as you follow the instructions.

For details, refer to the ScanSnap Online Update Help.

ATTENTION

- To run the online update for ScanSnap Manager, you need to have access to the Internet.
- Log on as a user with Administrator privileges.

HINT

For details about updates of ScanSnap Manager, visit the following web pages:

<https://scansnap.fujitsu.com/global/dl/>

Updating the Firmware (iX1600 / iX1500)

Update the ScanSnap firmware to add new features or improve features and operational performance.

If the ScanSnap is connected to the Internet, the firmware can be updated on the touch panel of the ScanSnap.

- "To check the latest information on the firmware" (page 586)
- "To update the firmware" (page 586)

To check the latest information on the firmware

Checking the latest information on the firmware in advance allows you to decide whether or not the firmware needs to be updated.

- iX1600
For the latest information on the firmware, refer to [here](#).
- iX1500
For the latest information on the firmware, refer to [here](#).

To update the firmware

ATTENTION

- Do not perform the following operations while updating the firmware. Otherwise, the firmware data may be corrupted.
 - Turning off the ScanSnap
 - Disconnecting the ScanSnap from the Internet by turning off the wireless access point or changing the settings

HINT

- If you use the software related to the ScanSnap, apply the latest updates to the software as well. For details, refer to "Updating the Software" (page 585).

1. Press  in the [home screen](#) on the touch panel of the ScanSnap to display the [Settings] screen.



2. Press  to display the [Maintenance] screen.
3. Press [Update firmware] to display the [Update firmware] screen.
If [Unknown] is displayed for the latest version for [Latest version/Current version], check whether the ScanSnap is connected to the Internet.
4. Press the [Update] button.
⇒ Updating the firmware starts.

Uninstalling the Software

This section explains how to uninstall the following software programs:

- ScanSnap Manager
- ScanSnap Organizer
- CardMinder
- ABBYY FineReader for ScanSnap

HINT

- If all of the following software programs are uninstalled, ScanSnap Online Update is also uninstalled at the same time:
 - ScanSnap Manager
 - ScanSnap Organizer
 - CardMinder
- For details about how to uninstall ScanSnap Home, refer to the [ScanSnap Home Help](#).

The procedure is as follows.

- 1. Turn on the computer and log on as a user with Administrator privileges.**
- 2. Exit all running software programs.**
- 3. Show the [Programs and Features] window.**
 - Windows 10
Select [Start] menu → [Control Panel] under [Windows System] → [Programs and Features] under [Programs].
 - Windows 8.1
Click  on the lower left side of the Start screen → [Control Panel] under [Windows System] → [Uninstall a program] under [Programs].
 - Windows 7
Select [Start] menu → [Control Panel] → [Uninstall a program] under [Programs].

⇒ The [Programs and Features] window appears with a list of currently installed software programs.
- 4. Select a software program to uninstall.**
- 5. Click the [Uninstall] button.**

⇒ A confirmation message appears.
- 6. Click the [Yes] button.**

⇒ The software program is uninstalled.

ATTENTION

If you cannot successfully uninstall the following software programs, refer to "[When You Cannot Uninstall the Software](#)" (page 505):

- ScanSnap Manager
- ScanSnap Organizer
- CardMinder
- ScanSnap Online Update

HINT

To uninstall more than one software program, repeat steps 4 to 6 for each software program.

Part Number of the Background Pad (SV600)

The product name and part number of the Background Pad are as follows.

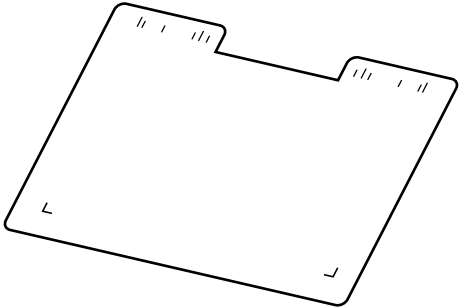
Product Name	Qty.	Part No.
Background Pad 	1 sheet	PA03641-0052

For details about purchasing the Background Pad, refer to "Suppliers of Consumables/Optional Parts" in ["About Customer Support and Maintenance"](#) (page 606).

Part Number of the Carrier Sheet (iX1600 / iX1500 / iX1400 / iX1300 / iX500 / iX100 / S1100i)

The product name and part number of the Carrier Sheet are as follows.

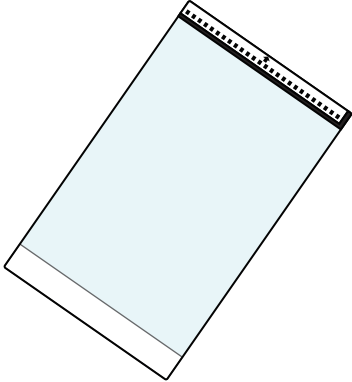
Product Name	Qty.	Part No.
Carrier Sheets 	5 sheets	PA03360-0013

The Carrier Sheet should be replaced approximately every 500 scans.

However, replace it if damage or dirt is noticeable.

For details about purchasing the Carrier Sheet, refer to "Suppliers of Consumables/Optional Parts" in ["About Customer Support and Maintenance"](#) (page 606).

Specifications of the ScanSnap

- ["Specifications for iX1600 / iX1500 / iX1400" \(page 592\)](#)
- ["Specifications for iX1300" \(page 594\)](#)
- ["Specifications for iX500" \(page 596\)](#)
- ["Specifications of iX100" \(page 598\)](#)
- ["Specifications of SV600" \(page 600\)](#)
- ["Specifications of S1300i" \(page 602\)](#)
- ["Specifications for S1100i" \(page 604\)](#)

Specifications for iX1600 / iX1500 / iX1400

The following table summarizes the specifications of the ScanSnap.

Item	Specification	
Product name	ScanSnap iX1600 ScanSnap iX1500 ScanSnap iX1400	
Scanning method	Automatic Document Feeder (ADF), simultaneous duplex scanning	
Scanning color mode	Simplex/duplex, color/gray/black and white/auto (automatic color, gray, and B&W detection)	
Optical system/image sensor	Equal-magnification optics/CIS × 2 (front × 1, back × 1)	
Light source	3 color LED (Red/Green/Blue)	
Touch panel (*1)	4.3 inch color display (pressure-sensitive touch panel)	
Scanning speed (A4 portrait)	<p>Automatic resolution/normal/better/best</p> <p>iX1600/iX1400: 40 sheets/minute iX1500: 30 sheets/minute</p> <p>Excellent</p> <p>iX1600/iX1400: 10 sheets/minute iX1500: 8 sheets/minute</p>	
Scan area	Refer to " Documents to Scan (iX1600 / iX1500 / iX1400) " (page 198)	
Document thickness		
Number of sheets allowed to be loaded	Up to 50 sheets A4: 80 g/m ² (20 lb)	
Interface	USB	USB 3.2 Gen1 (*2)/USB 3.1 Gen1 (*2)/USB 3.0 (*2)/USB 2.0/USB 1.1 (connector: B Type)
	Wireless LAN (*3)	IEEE802.11 a/b/g/n/ac (2.4 GHz/5 GHz) (*4)
Input power	Voltage	100 to 240 V ±10%
	Phase	Single phase
	Frequency range	50/60 Hz
Power consumption	USB connection	During operation: 17 W or less During sleep mode: 1.5 W or less
	Wireless LAN connection	During operation: 17 W or less During sleep mode: 1.6 W or less
Temperature/humidity allowable ranges	Temperature	During operation: 5 to 35 degrees C/41 to 95 degrees F During standby: -20 to 60 degrees C/-4 to 140 degrees F During storage/transportation: -20 to 60 degrees C/-4 to 140 degrees F
	Humidity	During operation: 20 to 80% During standby: 8 to 95% During storage/transportation: 8 to 95%

Item	Specification	
Outer dimensions (Width × Depth × Height)	Min.: 292 × 161 × 152 mm/11.50 × 6.34 × 5.98 in. (when the ADF paper chute (cover) is closed) Max.: 292 × 494 × 293 mm/11.50 × 19.45 × 11.54 in. (when the ADF paper chute (cover) is open and the extension is extended)	
Weight	iX1600/iX1500: 3.4 kg (approx. 7.5 lb) iX1400: 3.2 kg (approx. 7.1 lb)	
Environmental specification	Compliant with the International Energy Star Program, and RoHS Directive	
Related software	Scanner driver	ScanSnap Manager
	File management	<ul style="list-style-type: none"> ● ScanSnap Home ● ScanSnap Organizer
	Business card management	CardMinder
	Text recognition	ABBYY FineReader for ScanSnap
	Update management and application	ScanSnap Online Update
	ECM linkage	Scan to Microsoft SharePoint
	PDF editing	iX1600: Kofax Power PDF Standard iX1500: Kofax Power PDF Standard or Nuance Power PDF Standard

*1: Not featured on iX1400.

*2: When the ScanSnap is connected to a USB 3.2 Gen1 port, a USB 3.1 Gen1 port, or a USB 3.0 port, the ScanSnap may not be recognized by some computers. In this case, connect the ScanSnap to a USB 2.0 port.

*3: Available for iX1600/iX1500. However, IPv6 is not supported.

*4: Depending on the country where the ScanSnap is purchased, the ScanSnap may not support the 5 GHz SSID.

Change the settings of the wireless access point so that the 2.4 GHz SSID is used.

Specifications for iX1300

The following table summarizes the specifications of the ScanSnap.

Item	Specification	
Product name	ScanSnap iX1300	
Scanning method	Automatic Document Feeder (ADF), single return scanning feeder (Return Scan), simultaneous duplex scanning	
Scanning color mode	Simplex/duplex, color/gray/black and white/auto (automatic color, gray, and B&W detection)	
Optical system/image sensor	Equal-magnification optics/CIS × 2 (front × 1, back × 1)	
Light source	3 color LED (Red/Green/Blue)	
Scanning speed (A4 portrait)	<p>Automatic resolution/normal/better/best 30 sheets/minute</p> <p>Excellent 9 sheets/minute</p>	
Scan area	Refer to " Documents to Scan (iX1300) " (page 231)	
Document thickness		
Number of sheets allowed to be loaded	Up to 20 sheets A4: 80 g/m ² (20 lb)	
Interface	USB	USB 3.2 Gen1x1 (*1)/USB 3.1 Gen1 (*1)/USB 3.0 (*1)/USB 2.0/USB 1.1 (connector: B type)
	Wireless LAN (*2)	IEEE802.11a/b/g/n/ac compliant
Input power	Voltage	100 to 240 V ±10%
	Phase	Single phase
	Frequency range	50/60 Hz
Power consumption	USB connection	During operation: 17 W or less During sleep mode: 1.7 W or less
	Wireless LAN connection	During operation: 17 W or less During sleep mode: 2.0 W or less
Temperature/humidity allowable ranges	Temperature	During operation: 5 to 35 degrees C/41 to 95 degrees F During standby: -20 to 60 degrees C/-4 to 140 degrees F During storage/transportation: -20 to 60 degrees C/-4 to 140 degrees F
	Humidity	During operation: 20 to 80% During standby: 8 to 95% During storage/transportation: 8 to 95%
Outer dimensions (Width × Depth × Height)	Min.: 296 × 114 × 87 mm/11.7 × 4.5 × 3.3 in. (when the ADF paper chute (cover) is closed) Max.: 296 × 247 × 242 mm/11.7 × 9.7 × 9.5 in. (when the ADF paper chute (cover) is open and the extension is extended)	
Weight	2.0 kg (approx. 4.41 lb) or less	
Environmental specification	Compliant with the International Energy Star Program, and RoHS Directive	

Item		Specification
Related software	Scanner driver	ScanSnap Manager
	File management	<ul style="list-style-type: none"> ● ScanSnap Home ● ScanSnap Organizer
	Business card management	CardMinder
	Text recognition	ABBYY FineReader for ScanSnap
	Update management and application	ScanSnap Online Update
	ECM linkage	Scan to Microsoft SharePoint

*1: When the ScanSnap is connected to a USB 3.2 Gen1x1 port, a USB 3.1 Gen1 port, or a USB 3.0 port, the ScanSnap may not be recognized by some computers. In this case, connect the ScanSnap to a USB 2.0 port.

*2: IPv6 is not supported.

Specifications for iX500

The following table summarizes the specifications of the ScanSnap.

Item	Specification	
Product name	ScanSnap iX500	
Scanning method	Automatic Document Feeder (ADF), simultaneous duplex scanning	
Scanning color mode	Simplex/duplex, color/gray/black and white/auto (automatic color, gray, and B&W detection)	
Optical system/image sensor	Equal-magnification optics/CIS × 2 (front × 1, back × 1)	
Light source	3 color LED (Red/Green/Blue)	
Scanning speed (A4 portrait)	<p>Automatic resolution/normal/better/best 25 sheets/minute</p> <p>Excellent 7 sheets/minute</p>	
Scan area	Refer to " Documents to Scan (iX500) " (page 287)	
Document thickness		
Number of sheets allowed to be loaded	Up to 50 sheets A4: 80 g/m ² (20 lb)	
Interface	USB	USB 3.0 (*1)/USB 2.0/USB 1.1 (connector: B type)
	Wireless LAN (*2)	IEEE802.11b/g/n compliant
Input power	Voltage	100 to 240 V ±10%
	Phase	Single phase
	Frequency range	50/60 Hz
Power consumption	USB connection	During operation: 20 W or less During sleep mode: 1.6 W or less
	Wireless LAN connection	During operation: 20 W or less During sleep mode: 2.5 W or less
Temperature/humidity allowable ranges	Temperature	During operation: 5 to 35 degrees C/41 to 95 degrees F During standby: -20 to 60 degrees C/-4 to 140 degrees F During storage/transportation: -20 to 60 degrees C/-4 to 140 degrees F
	Humidity	During operation: 20 to 80% During standby: 8 to 95% During storage/transportation: 8 to 95%
Outer dimensions (Width × Depth × Height)	Min.: 292 × 159 × 168 mm/11.50 × 6.26 × 6.61 in. (when the ADF paper chute (cover) is closed) Max.: 292 × 484 × 293 mm/11.50 × 19.06 × 11.54 in. (when the ADF paper chute (cover) is open and the extension is extended)	
Weight	3.0 kg (approx. 6.62 lb)	
Environmental specification	Compliant with the International Energy Star Program, and RoHS Directive	

Item		Specification
Related software	Scanner driver	ScanSnap Manager
	File management	<ul style="list-style-type: none"> ● ScanSnap Home ● ScanSnap Organizer
	Business card management	CardMinder
	Text recognition	ABBYY FineReader for ScanSnap
	Update management and application	ScanSnap Online Update
	ECM linkage	Scan to Microsoft SharePoint
	PDF editing	Nuance Power PDF Standard

*1: When the ScanSnap is connected to a USB 3.0 port, the ScanSnap may not be recognized by some computers. In this case, connect the ScanSnap to a USB 2.0 port.

*2: IPv6 is not supported.

Specifications of iX100

The following table summarizes the specifications of the ScanSnap.

Item	Specification	
Product name	ScanSnap iX100	
Scanning method	Manual feed (Continuous Document Feeding (CDF) function supported), simplex scanning, two selectable paper paths (U-turn path (*1), straight path (*2))	
Scanning color mode	Simplex, color/gray/black and white/auto (automatic color, gray, and B&W detection)	
Optical system/image sensor	Equal-magnification optics/CIS × 1	
Light source	3 color LED (Red/Green/Blue)	
Scanning speed (A4 portrait)	<p>Automatic resolution/normal/better/best 5.2 sec/sheet</p> <p>Excellent 20.4 sec/sheet</p>	
Scan area	Refer to " Documents to Scan (iX100) " (page 316)	
Document thickness		
Interface	USB	USB 2.0/USB 1.1 (connector: USB Micro-B type) (*3)
	Wireless LAN (*4)	IEEE802.11b/g/n compliant
Input power	Voltage	5 V (USB bus power)
Power consumption	During operation: 4.7 W or less During sleep mode: 2.2 W or less	
Temperature/humidity allowable ranges	Temperature	During operation: 5 to 35 degrees C/41 to 95 degrees F During standby: -20 to 60 degrees C/-4 to 140 degrees F During storage/transportation: -20 to 60 degrees C/-4 to 140 degrees F
	Humidity	During operation: 20 to 80% During standby: 8 to 95% During storage/transportation: 8 to 95%
Outer dimensions (Width × Depth × Height)	Min.: 273 × 47.5 × 36 mm/10.75 × 1.87 × 1.42 in. (when the feed guide and output guide are closed) Max.: 273 × 80 × 59 mm/10.75 × 3.15 × 2.32 in. (when the feed guide and output guide are open)	
Weight	400 g (approx. 0.88 lb)	
Environmental specification	Compliant with the International Energy Star Program, and RoHS Directive	

Item		Specification
Related software	Scanner driver	ScanSnap Manager
	File management	<ul style="list-style-type: none"> ● ScanSnap Home ● ScanSnap Organizer
	Business card management	CardMinder
	Text recognition	ABBYY FineReader for ScanSnap
	Update management and application	ScanSnap Online Update
	ECM linkage	Scan to Microsoft SharePoint

*1: When the output guide is open.

*2: When the output guide is closed.

*3: When the ScanSnap is connected to a USB 3.0 port, the port operates as a USB 2.0 port.

*4: IPv6 is not supported.

Specifications of SV600

The following table summarizes the specifications of the ScanSnap.

Item		Specification
Product name		ScanSnap SV600
Scanning method		Overhead scanning
Scanning color mode		Color/gray/black and white/auto (automatic color, gray, and B&W detection)
Optical system/image sensor		Lens reduction optics/CCD × 1
Light source		(White LED + lens illumination) × 2
Scanning speed (A3 landscape)		3 sec/sheet
Scan area		Automatic detection (maximum), automatic detection (A4 landscape/letter landscape), A3 landscape, A4 landscape, A5 landscape, A6 landscape, B4 landscape, B5 landscape, B6 landscape, Post card landscape, Business card, Letter landscape, Legal landscape, 11 × 17 in. landscape, custom size (maximum: 432 × 300 mm/17.01 × 11.81 in., minimum: 25.4 × 25.4 mm/1.00 × 1.00 in.)
Magnification in vertical scanning (length)		±1.5%
Document thickness		30 mm (1.18 in.) or less
Interface		USB 2.0/USB 1.1 (connector: B type) (*1)
Input power	Voltage	100 to 240 V ±10%
	Phase	Single phase
	Frequency range	50/60 Hz
Power consumption		During operation: 20 W or less During sleep mode: 2.6 W or less
Temperature/humidity allowable ranges	Temperature	During operation: 5 to 35 degrees C/41 to 95 degrees F During standby: -20 to 60 degrees C/-4 to 140 degrees F During storage/transportation: -20 to 60 degrees C/-4 to 140 degrees F
	Humidity	During operation: 20 to 80% During standby: 8 to 95% During storage/transportation: 8 to 95%
Outer dimensions (Width × Depth × Height)		210 × 156 × 383 mm/8.27 × 6.14 × 15.08 in.
Weight		3.0 kg (approx. 6.62 lb)
Environmental specification		Compliant with the International Energy Star Program, and RoHS Directive

Item		Specification
Related software	Scanner driver	ScanSnap Manager
	File management	<ul style="list-style-type: none">● ScanSnap Home● ScanSnap Organizer
	Business card management	CardMinder
	Text recognition	ABBYY FineReader for ScanSnap
	Update management and application	ScanSnap Online Update
	ECM linkage	Scan to Microsoft SharePoint
	PDF editing	Kofax Power PDF Standard or Nuance Power PDF Standard

*1: When the ScanSnap is connected to a USB 3.0 port, the port operates as a USB 2.0 port.

Specifications of S1300i

The following table summarizes the specifications of the ScanSnap.

Item		Specification
Product name		ScanSnap S1300i
Scanning method		Automatic Document Feeder (ADF), simultaneous duplex scanning
Scanning color mode		Simplex/duplex, color/gray/black and white/auto (automatic color, gray, and B&W detection)
Optical system/image sensor		Equal-magnification optics/CIS × 2 (front × 1, back × 1)
Light source		3 color LED (Red/Green/Blue)
Scanning speed (A4 portrait)	Power cable connection	Automatic resolution: 6 sheets/minute Normal: 12 sheets/minute Better: 9 sheets/minute Best: 6 sheets/minute Excellent: 1 sheet/minute
	USB bus power cable connection	Automatic resolution: 2 sheets/minute Normal: 4 sheets/minute Better: 3 sheets/minute Best: 2 sheets/minute Excellent: 1 sheet/minute
Scan area		Refer to " Documents to Scan (S1300i) " (page 374)
Document thickness		
Number of sheets allowed to be loaded		Up to 10 sheets A4: 80 g/m ² (20 lb)
Interface	USB	USB 2.0/USB 1.1 (connector: USB Mini-B type) (*1)
Input power	Voltage	100 to 240 V ±10% or 5 V (USB bus power)
	Phase	Single phase
	Frequency range	50/60 Hz
Power consumption	Power cable connection	During operation: 9 W or less During sleep mode: 2.6 W or less
	USB bus power cable connection	During operation: 5 W or less During sleep mode: 2 W or less
Temperature/humidity allowable ranges	Temperature	During operation: 5 to 35 degrees C/41 to 95 degrees F During standby: -20 to 60 degrees C/-4 to 140 degrees F During storage/transportation: -20 to 60 degrees C/-4 to 140 degrees F
	Humidity	During operation: 20 to 80% During standby: 8 to 95% During storage/transportation: 8 to 95%
Outer dimensions (Width × Depth × Height)		Min.: 284 × 99 × 77 mm/11.18 × 3.90 × 3.03 in. (when the ADF paper chute (cover) is closed) Max.: 284 × 231 × 240 mm/11.18 × 9.09 × 9.45 in. (when the ADF paper chute (cover) is open and the extension is extended)
Weight		1.4 kg (approx. 3.09 lb)

Item	Specification	
Environmental specification	Compliant with the International Energy Star Program, and RoHS Directive	
Related software	Scanner driver	ScanSnap Manager
	File management	<ul style="list-style-type: none"> ● ScanSnap Home ● ScanSnap Organizer
	Business card management	CardMinder
	Text recognition	ABBYY FineReader for ScanSnap
	Update management and application	ScanSnap Online Update
	ECM linkage	Scan to Microsoft SharePoint

*1: When the ScanSnap is connected to a USB 3.0 port, the port operates as a USB 2.0 port.

Specifications for S1100i

The following table summarizes the specifications of the ScanSnap.

Item		Specification
Product name		ScanSnap S1100i
Scanning method		Manual feed (Continuous Document Feeding (CDF) function supported), simplex scanning, two selectable paper paths (U-turn path (*1), straight path (*2))
Scanning color mode		Simplex, color/gray/black and white/auto (automatic color, gray, and B&W detection)
Optical system/image sensor		Equal-magnification optics/CIS × 1
Light source		3 color LED (Red/Green/Blue)
Scanning speed (A4 portrait)		Automatic resolution/normal/better/best 7.5 sec/sheet Excellent 35 sec/sheet
Scan area		Refer to " Documents to Scan (S1100i) " (page 391)
Document thickness		
Interface		USB 2.0/USB 1.1 (connector: USB Mini-B type) (*3)
Input power	Voltage	5 V (USB bus power)
Power consumption		During operation: 2.5 W or less During sleep mode: 1.0 W or less
Temperature/humidity allowable ranges	Temperature	During operation: 5 to 35 degrees C/41 to 95 degrees F During standby: -20 to 60 degrees C/-4 to 140 degrees F During storage/transportation: -20 to 60 degrees C/-4 to 140 degrees F
	Humidity	During operation: 20 to 80% During standby: 8 to 95% During storage/transportation: 8 to 95%
Outer dimensions (Width × Depth × Height)		Min.: 273 × 47.5 × 34 mm/10.75 × 1.87 × 1.34 in. (when the feed guide and output guide are closed) Max.: 273 × 77 × 52 mm/10.75 × 3.03 × 2.05 in. (when the feed guide and output guide are open)
Weight		350 g (approx. 0.77 lb)
Environmental specification		Compliant with the International Energy Star Program, and RoHS Directive

Item		Specification
Related software	Scanner driver	ScanSnap Manager
	File management	<ul style="list-style-type: none">● ScanSnap Home● ScanSnap Organizer
	Business card management	CardMinder
	Text recognition	ABBYY FineReader for ScanSnap
	Update management and application	ScanSnap Online Update
	ECM linkage	Scan to Microsoft SharePoint

*1: When the output guide is open.

*2: When the output guide is closed.

*3: When the ScanSnap is connected to a USB 3.0 port, the port operates as a USB 2.0 port.

About Customer Support and Maintenance

Customer Support

- ScanSnap

For other inquiries on the ScanSnap, refer to the ScanSnap Support Site.

<https://scansnap.fujitsu.com/g-support/en/>

If your problem cannot be solved after referring to the above web pages, visit the following web page to check the contact information of a suitable Fujitsu office and contact the Fujitsu office.

<https://www.fujitsu.com/global/about/resources/shop/computing/peripheral/scanners/index.html>

- ABBYY FineReader for ScanSnap

- Windows 10

From the [Start] menu, select [ABBYY FineReader for ScanSnap(TM)] → [User's Guide] → [Technical Support].

- Windows 8.1

Click  on the lower left side of the Start screen, and select [User's Guide] under [ABBYY FineReader for ScanSnap(TM)] on the All apps screen → [Technical Support].

- Windows 7

Select [Start] menu → [All Programs] → [ABBYY FineReader for ScanSnap(TM)] → [User's Guide] → [Technical Support].

Suppliers of Consumables/Optional Parts

<https://scansnap.fujitsu.com/>

Maintenance

Contact the distributor/dealer where you purchased this product. Refer to the contact information in the Contact List if supplied with this product, or refer to the contact information in the Contact for Inquiries section if provided in Safety Precautions supplied with this product, and then make an inquiry.

For details, refer to the following portal site:

<https://www.fujitsu.com/global/about/resources/shop/computing/peripheral/scanners/index.html>

ATTENTION

For safety reasons, never attempt repairs by yourself.