

fi-7140/fi-7240 Image Scanner

Getting Started

Thank you for purchasing the fi-7140/fi-7240 color image scanner. This manual describes the preparation required to use this product. Follow the procedures in this manual. Make sure to read the attached "Safety Precautions" manual before using the scanner. For details about scanner functions and features, basic operation, daily care, consumable replacement and troubleshooting, refer to the Operator's Guide (PDF). The Operator's Guide is included in the Setup DVD-ROM.

Microsoft product screenshots in this manual are reprinted with permission from Microsoft Corporation.

Microsoft, Windows, Windows Server, Windows Vista, Excel, and SharePoint are either registered trademarks or trademarks of Microsoft Corporation in the United States and/or other countries.

Word is the product of Microsoft Corporation in the United States.

ISIS is a registered trademark of EMC Corporation in the United States.

Intel, Pentium, and Intel Core are registered trademarks or trademarks of Intel Corporation in the United States and other countries.

ABBYY™ FineReader™ Engine © ABBYY. OCR by ABBYY

ABBYY and FineReader are trademarks of ABBYY Software, Ltd. which may be registered in some jurisdictions.

ScanSnap, ScanSnap Manager, and PaperStream are registered trademarks of PFU Limited in Japan.





Other company names and product names are the registered trademarks or trademarks of the respective companies.

March, 2017
© PFU Limited 2015-2017

Checking the Components

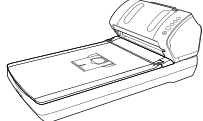
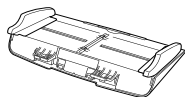
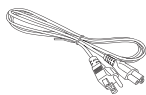
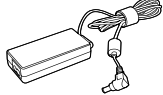
Make sure that all items shown below are included in the package. If any other packaging is provided, make sure to keep it as well. The components must be handled with care.

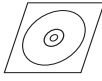
The box and packaging materials are required for storage and transportation of the scanner. Do not throw them away. If anything is missing or damaged, contact your FUJITSU scanner dealer or an authorized FUJITSU scanner service provider.

<p>[fi-7140]</p>  <p>Scanner (x1)</p>	<p>[fi-7240]</p>  <p>Scanner (x1)</p>	 <p>ADF Paper Chute (Feeder) (x1)</p>
 <p>AC Cable (x1)</p>	 <p>AC Adapter (x1)</p>	 <p>USB Cable (x1)</p>
 <p>Setup DVD-ROM (x1)</p>	 <p>Safety Precautions (x1)</p>	



Note: The contents may vary depending on the country.

Safety Information

The attached Safety Precautions manual contains important information about the safe and correct use of this product. Make sure that you read and understand it before using the scanner.

Symbols Used in This Manual

The following symbols are used in this manual.

Symbol	Description
	This indication alerts operators of an operation that, if not strictly observed, may result in severe injury or death.
	This indication alerts operators of an operation that, if not strictly observed, may result in safety hazards to personnel or damage to the product.

Removing the Protective Packaging

The scanner is secured with orange protective tape. Peel off the tape before using the scanner.

Installing the Software

Bundled Software

The following software are bundled with the scanner:

- **PaperStream IP (TWAIN)**
Conforms to the TWAIN standard. Used when you operate the scanner using TWAIN-compliant 32-bit applications.
- **PaperStream IP (TWAIN x64)**
Conforms to the TWAIN standard. Used when you operate the scanner using TWAIN-compliant 64-bit applications.
Can be installed on 64-bit operating systems.
- **PaperStream IP (ISIS) for fi-71xx/72xx**
Conforms to the ISIS standard. Used when you operate the scanner using ISIS-compliant applications.

- **Software Operation Panel**
Configure various settings such as the operation of the scanner and managing the consumables. Installed together with PaperStream IP (TWAIN), the PaperStream IP (TWAIN x64), or the PaperStream IP (ISIS) for fi-71xx/72xx.
- **Error Recovery Guide**
Shows the error status and countermeasures when an error occurs. Installed together with PaperStream IP (TWAIN), PaperStream IP (TWAIN x64), or PaperStream IP (ISIS) for fi-71xx/72xx.
- **PaperStream Capture**
An image scanning application that supports PaperStream IP (TWAIN) and PaperStream IP (ISIS) for fi-71xx/72xx. By defining scan settings as document profiles, you can customize the settings according to your preference.
- **ScanSnap Manager for fi Series**
An application that scans images with the scan settings that are used exclusively for ScanSnap Manager for fi Series. PaperStream IP (TWAIN) is required to use this application. A PDF, JPEG, or searchable PDF image file can be created with a single button.
You can download and install this application from the download web page.
- **Scan to Microsoft SharePoint**
An application that allows you to upload your files easily from ScanSnap Manager for fi Series to a SharePoint site. Can be used to scan images with ScanSnap Manager for fi Series.
You can download and install this application from the download web page.
- **ABBYY FineReader for ScanSnap™**
Bundled for use with ScanSnap Manager for fi Series, this application converts scanned images into Microsoft® Office (Word/Excel®/PowerPoint®) files. Can be used to scan images with ScanSnap Manager for fi Series. You can download and install this application from the download web page.
- **Manual**
Includes Safety Precautions, Getting Started, Operator's Guide, and fi-718PR Imprinter Operator's Guide.

● **Scanner Central Admin Agent**

Used to centralize the management of multiple scanners, by allowing you to apply firmware updates simultaneously, monitor the operating status, and check the scanner information. Note that required applications will differ depending on the form of operation. For details, refer to the Scanner Central Admin User's Guide.

● **fi Series Online Update**

An application that is used to check the latest update program of the software and firmware related to the fi series and update them. For details, refer to the fi Series Online Update Help.

● **Other Software (Legacy)**

Software that were bundled with older versions of scanners are also included.

● **ScandAll PRO**

A TWAIN/ISIS-compliant image scanning application. You can define scan settings as batch profiles, and perform a scan with a single button by selecting a batch profile based on your intended use. You can download and install this application from the download web page.

● **Scan to Microsoft SharePoint**

An application that allows you to upload your files easily from ScandAll PRO to a SharePoint site. You can download and install this application from the download web page.

System Requirements

The system requirements are as follows.

Operating System	<ul style="list-style-type: none"> ● Windows Vista® Home Basic (32-bit/64-bit) (Service Pack 1 or later) ● Windows Vista® Home Premium (32-bit/64-bit) (Service Pack 1 or later) ● Windows Vista® Business (32-bit/64-bit) (Service Pack 1 or later) ● Windows Vista® Enterprise (32-bit/64-bit) (Service Pack 1 or later) ● Windows Vista® Ultimate (32-bit/64-bit) (Service Pack 1 or later) ● Windows Server® 2008 Standard (32-bit/64-bit) ● Windows Server® 2008 R2 Standard (64-bit) ● Windows® 7 Home Premium (32-bit/64-bit) ● Windows® 7 Professional (32-bit/64-bit) ● Windows® 7 Enterprise (32-bit/64-bit) ● Windows® 7 Ultimate (32-bit/64-bit) ● Windows Server® 2012 Standard (64-bit) (*1) ● Windows Server® 2012 R2 Standard (64-bit) (*1) ● Windows® 8 (32-bit/64-bit) (*1) ● Windows® 8 Pro (32-bit/64-bit) (*1) ● Windows® 8 Enterprise (32-bit/64-bit) (*1) ● Windows® 8.1 (32-bit/64-bit) (*1) ● Windows® 8.1 Pro (32-bit/64-bit) (*1) ● Windows® 8.1 Enterprise (*1) ● Windows® 10 Home (32-bit/64-bit) (*1) ● Windows® 10 Pro (32-bit/64-bit) (*1) ● Windows® 10 Enterprise (32-bit/64-bit) (*1) ● Windows® 10 Education (32-bit/64-bit) (*1) ● Windows Server® 2016 Standard (64-bit) (*1)
CPU	Intel® Pentium® 4 1.8 GHz or higher (Recommended: Intel® Core™ i5 2.5 GHz or higher, except mobile device processors)
Hard Disk Drive	5,400 rpm or more (Recommended: 7,200 rpm or more)
Memory	1 GB or more (Recommended: 4 GB or more)
Display Resolution	1024 × 768 pixels or more, 65,536 colors or more

Hard Disk Space	11 GB or more of free hard disk space (*2)
DVD Drive	Required for installing the software
Interface	USB 2.0/1.1

*1: The software operates as a desktop application.

*2: Required disk space varies according to the file size of the scanned images.

ATTENTION

- If the system requirements above are not satisfied, the scanner may not operate.
- Scanning speed will slow down in the following cases:
 - The CPU or the memory does not meet the required specifications
 - The version of the USB port or the USB hub is USB 1.1

HINT

The screenshots used in this manual are of Windows® 7. The actual windows and operations may differ depending on the operating system.

Where there is no distinction between the different versions of the operating system shown in the table of system requirements, the general term Windows® is used.

Installing the Bundled Software

Install the bundled software from the Setup DVD-ROM in the following procedure. Note that there are two ways to install the bundled software: select [Installation (Recommended)] to install all the software required to operate the scanner, or [Installation (Custom)] to select and install the software as needed.

ATTENTION

If an old version of the software is installed already, uninstall it first. For details about the uninstallation procedures, refer to "A.5 Uninstalling the Software" in the Operator's Guide.

■ Installation (Recommended)

The following software are installed:

- PaperStream IP (TWAIN)
- PaperStream IP (TWAIN x64)
- Software Operation Panel
- Error Recovery Guide
- PaperStream Capture
- Manual
- Scanner Central Admin Agent
- fi Series Online Update

1. Turn on the computer and log onto Windows® as a user with Administrator privileges.
2. Insert the Setup DVD-ROM into the DVD drive.
 - ⇒ The [fi Series Setup] screen appears.

HINT

If the [fi Series Setup] screen does not appear, double-click "Setup.exe" in the Setup DVD-ROM via Windows Explorer or [Computer].

3. Click the [Installation (Recommended)] button.



4. Follow the instructions on the screen to proceed with the installation.

■ Installation (Custom)

1. Perform steps 1. to 2. in "Installation (Recommended) (page 4)".
2. Click the [Installation (Custom)] button.



3. Select the check box for the software to install and click the [Next] button.
4. Follow the instructions on the screen to proceed with the installation.

Installing the Scanner

Install the scanner in the following procedure.

1. Place the scanner at its installation site.

ATTENTION

Carry the scanner by supporting it from the bottom.

●fi-7140

- Outer Dimensions
- Installation Space

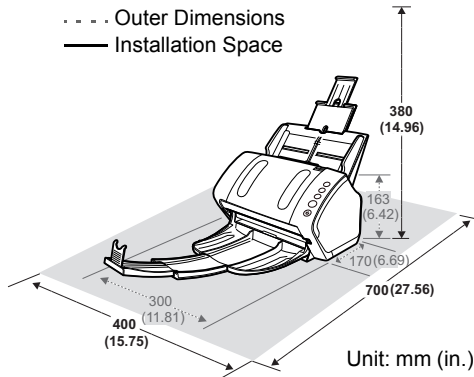

●fi-7240

- Outer Dimensions
- Installation Space

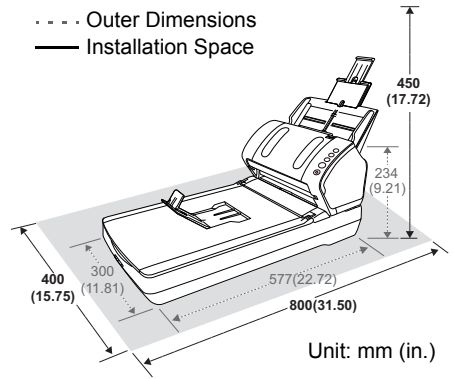

2. Unlock the transport lock switch.

For fi-7240, there is a carrier unit inside the flatbed which is fixed in place to prevent damage during transportation. Slide the transport lock switch on the front.

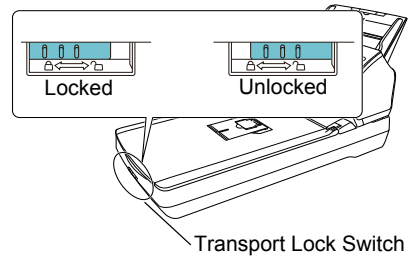

3. Attach the ADF paper chute (Feeder).

Insert the tabs into the slots on the back of the scanner in the direction indicated by the arrow ①, and tilt the ADF paper chute backwards in the direction indicated by the arrow ② until it locks in place.

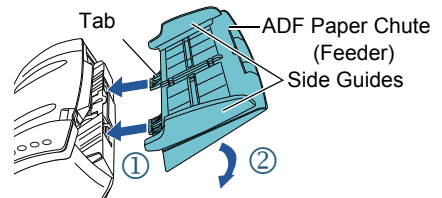

ATTENTION

Insert the ADF paper chute (Feeder) firmly so that there is no space between the scanner.

Connecting the Cables

Connect each cable in the following procedure.

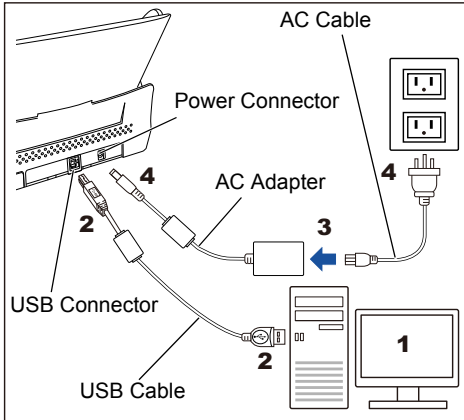

3. Connect the AC cable to the AC adapter (hereinafter called the "power cable").



Only use the supplied power cable. To prevent electrical shock or scanner malfunction, do not perform the following:

- Use a different power cable
- Use the supplied power cable for other devices

4. Connect the power cable to the power connector of the scanner and the power outlet.

HINT

When you plug the cable into the outlet, the [Power] button on the scanner's operator panel will flash once. Note that this is an initial diagnosis and not a malfunction.



Only use the supplied AC adapter. Not doing so may cause the scanner to malfunction. Furthermore, do not use the supplied AC adaptor for other products.

1. Confirm that the computer is turned off.
2. Connect the USB cable to the USB connector of the scanner and USB port of the computer.

ATTENTION

- Use the supplied USB cable.
- If you connect the scanner with USB 2.0, it is required that the USB port and the hub be compliant with USB 2.0. The scanning speed slows down when you connect the scanner with USB 1.1.
- Connect it with the USB mark facing up.

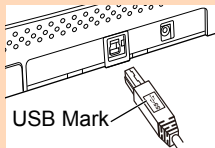

Test-Scan

Follow the procedure described below to check that documents can be scanned correctly by using PaperStream Capture and PaperStream IP (TWAIN).

1. Press the [Power] button on the operator panel.

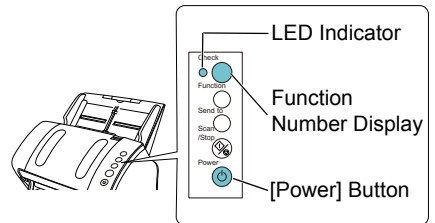

- ⇒ The scanner is turned on, and the [Power] button lights in green. During initialization, the Function Number Display changes as follows: "8" → "P" → "0" → "1". The scanner is ready when "1" is displayed.

ATTENTION

If "1" is not displayed on the Function Number Display, refer to "Chapter 7 Troubleshooting" in the Operator's Guide.

HINT

When you press the [Power] button, the LED indicator will flash once. Note that this is an initial diagnosis and not a malfunction.

2. Turn on the computer.
⇒ The scanner is automatically detected.

ATTENTION

If the [Found New Hardware] dialog box appears, select [Locate and install driver software (recommended)], and follow the instructions on the screen to install the driver.

3. Load a document in the scanner.
 1. Pull out the chute extensions according to the length of the document.
 2. Pull the stacker out, slide stacker extension 1 and stacker extension 2 toward you according to the length of the document, and lift the stopper up.
 3. Load the document face-down in the ADF paper chute (Feeder).
 4. Adjust the side guides to the width of the document.

● fi-7140

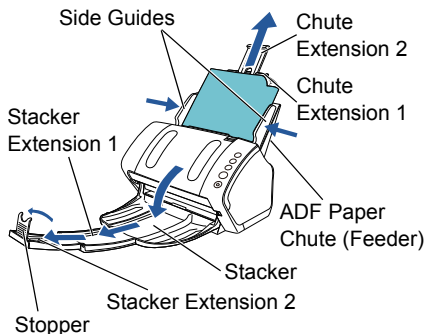

● fi-7240

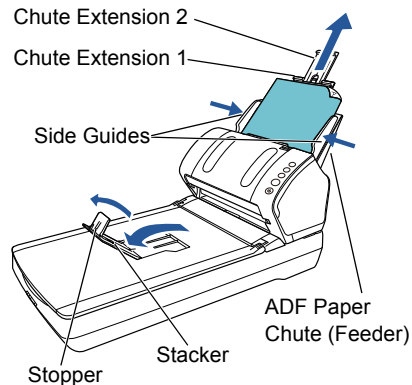

4. Start up PaperStream Capture.

● Windows Vista®/Windows Server® 2008/Windows® 7

Select the [Start] menu → [All Programs] → [PaperStream Capture] → [PaperStream Capture].

● Windows Server® 2012/Windows® 8

Right-click the Start screen, select [All apps] on the app bar, and then select [PaperStream Capture] under [PaperStream Capture].

● Windows Server® 2012 R2/Windows® 8.1

Click [↓] on the lower left side of the Start screen, and then select [PaperStream Capture] under [PaperStream Capture]. To display [↓], move the mouse cursor.

● Windows® 10/Windows Server® 2016

Select the [Start] menu → [PaperStream Capture] → [PaperStream Capture].

5. Click the [Scan] button in the Menu Area.

6. Click one of the three types of document profiles that are prepared beforehand.
Below is an example of when the document profile [Black and White] is clicked.

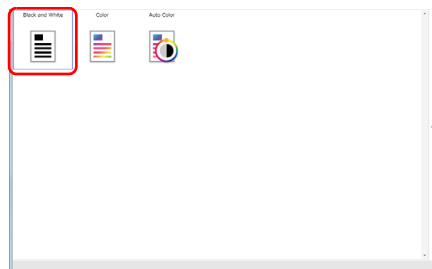

⇒ The document is scanned, and the scanned image is displayed.

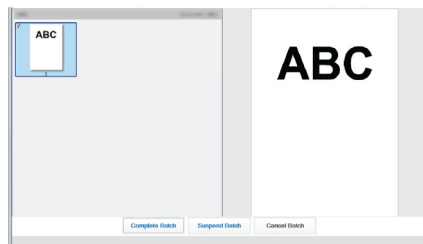

ATTENTION

When an error occurs with the scanner, the indication on the Function Number Display changes as follows:

- For temporary errors
The letter "J" or "U" and an "error code" appear alternately.
- For device errors
The letter "E", "F", "C", "H", "A" or "L" and an "alarm number" appear alternately.
In that case, refer to "Chapter 7 Troubleshooting" in the Operator's Guide.

For details about other scanning features, refer to "Chapter 4 Various Ways to Scan" in the Operator's Guide.

Contact for Inquiries

Refer to the contact list on the last page of the Safety Precautions manual.

- ABBYY FineReader for ScanSnap™
 - Windows Vista®/Windows Server® 2008/Windows® 7
Select the [Start] menu → [All Programs] → [ABBYY FineReader for ScanSnap(TM)] → [User's Guide] → [Technical Support].
 - Windows Server® 2012/Windows® 8
Right-click the Start screen, select [All apps] on the app bar, and then select [User's Guide] under [ABBYY FineReader for ScanSnap(TM)] → [Technical Support].
 - Windows Server® 2012 R2/Windows® 8.1
Click [↓] on the lower left side of the Start screen, and then select [User's Guide] under [ABBYY FineReader for ScanSnap(TM)] → [Technical Support].
To display [↓], move the mouse cursor.
 - Windows® 10/Windows Server® 2016
Select the [Start] menu → [ABBYY FineReader for ScanSnap(TM)] → [User's Guide] → [Technical Support].
- Color Image Scanner fi Series
For other inquiries regarding the scanner, refer to the following web page:
<http://imagescanner.fujitsu.com/g-support.html>

If the solution to your problem cannot be found on the above web page, refer to the contact information for your Fujitsu office on the following web page:
<http://imagescanner.fujitsu.com/warranty.html>

Contact for Purchasing Consumables or Cleaning Materials

http://www.fujitsu.com/global/shop/computing/IMAGE_index.html

Notice

- Copying of the contents of this document in whole or in part and copying of the scanner application is prohibited under the copyright law.
- The contents of this document are subject to change without notice.

Regulatory Model P3670A/P3670C