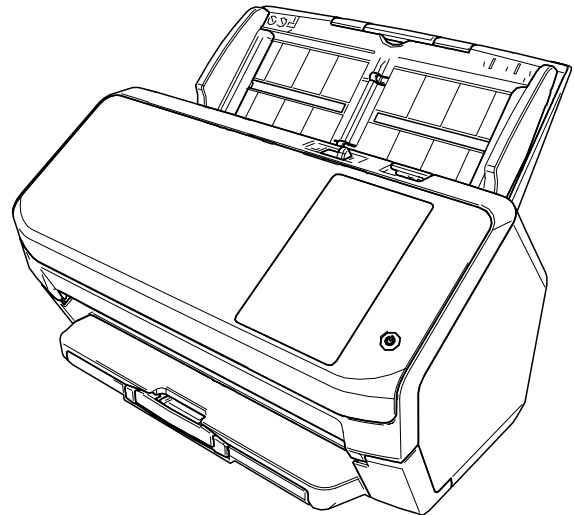

**Image Scanner**  
**fi-7300NX**

---

**Operator's Guide**



# Contents

<b>Introduction</b>	<b>9</b>
Manuals .....	9
Trademarks .....	15
Manufacturer.....	15
Issue Date/Issuer .....	15
Safety Information.....	15
Symbols Used in This Manual .....	16
Abbreviations Used in This Manual.....	17
Arrow Symbols in This Manual .....	17
Screen Examples in This Manual.....	18
Notice .....	18
<b>Scanner Overview</b>	<b>19</b>
Main Features.....	19
Operating Methods.....	22
Parts and Functions.....	25
Icons on the Touch Screen.....	30
<b>Scanner Setup</b>	<b>35</b>
<b>When Connecting the Scanner via Wi-Fi</b> .....	<b>38</b>
Connecting to a Wireless Access Point by Selecting One from the List of Wireless Access Points.....	41
Connecting to a Wireless Access Point by Pressing the WPS Button.....	42
Connecting to a Wireless Access Point by Entering the PIN for WPS.....	43
When Establishing a Connection by Entering the Information for the Wireless Access Point.....	44
When Connecting to a Network Which Requires a Certificate .....	45
<b>When Connecting the Scanner via a Wired LAN</b> .....	<b>47</b>
<b>When Connecting the Scanner to EdgeXperience Capture Service</b> .....	<b>50</b>
<b>When Connecting the Scanner to the Computer via a USB Cable</b> .....	<b>52</b>
<b>Checking the Network Connection for the Scanner</b> .....	<b>54</b>
<b>Installing Software</b> .....	<b>55</b>
Overview of the Bundled Software .....	55
System Requirements.....	57
Installation (Recommended) .....	58
Installation (Custom).....	59

## **Basic Operations** **60**

---

<b>Turning the Power ON/OFF</b> .....	<b>60</b>
How to Turn the Power ON .....	60
How to Turn the Power OFF .....	61
<b>Login/Logout (Using PaperStream NX Manager)</b> .....	<b>62</b>
<b>Entering and Resuming from Power Saving Mode</b> .....	<b>65</b>
<b>Opening/Closing the ADF</b> .....	<b>67</b>
How to Open the ADF .....	67
How to Close the ADF .....	68
<b>Setting Up the ADF Paper Chute (Feeder)</b> .....	<b>69</b>
<b>Setting Up the Stacker</b> .....	<b>70</b>
Document Length Is A6 (Landscape) or Longer .....	70
Document Length Is Shorter than A6 (Landscape) .....	71

## **How to Perform a Basic Scan** **72**

---

<b>Using an Image Scanning Application on the Computer</b> .....	<b>73</b>
<b>Using an Image Scanning Application Started on the Touch Screen</b> .....	<b>75</b>
Button Settings .....	77
Operations on the Scanner .....	80
<b>Using a Job (With PaperStream NX Manager)</b> .....	<b>82</b>

## **How to Load Documents** **83**

---

<b>Loading Documents</b> .....	<b>83</b>
Preparation .....	83
How to Load Documents .....	85
<b>Documents for Scanning</b> .....	<b>87</b>
Paper Size .....	87
Paper Type .....	87
Paper Weight (Thickness) .....	87
Documents That May Not Be Scanned Successfully .....	88
Documents That Must Not Be Scanned .....	88
Precautions .....	89
Loading Capacity .....	91
Area Not to Be Perforated .....	92
Conditions Required to Accurately Detect Overlapped Documents (Multifeed) .....	93
Conditions for Mixed Batch Scanning .....	95
Conditions for Automatic Page Size Detection .....	98

Conditions for Using the Carrier Sheet.....	99
<b>Various Ways to Scan</b>	<b>101</b>
Scanning Documents with Different Widths .....	102
Scanning Documents Folded in Half.....	104
Scanning Documents such as Envelopes or Multi-Layered Transfer Paper .....	107
Scanning Photographs and Clippings.....	109
Scanning Long Page Documents.....	111
Feeding Documents Manually.....	113
Configuring Not to Detect Certain Overlap Patterns .....	115
Operational Procedure .....	116
Disabling the Paper Protection Function.....	118
Operational Procedure .....	118
Counting the Number of Documents .....	119
<b>Daily Care</b>	<b>120</b>
Cleaning Materials .....	120
Location and Frequency.....	122
Cleaning the Outside of the Scanner.....	124
Cleaning the Inside of the Scanner (ADF) with Cleaning Paper .....	125
Cleaning the Inside of the Scanner (ADF) with a Cloth.....	127
Cleaning the Carrier Sheet .....	132
<b>Replacing the Consumables</b>	<b>133</b>
Consumables and Replacement Cycles.....	133
Replacing the Brake Roller .....	135
Replacing the Pick Roller .....	140
<b>Troubleshooting</b>	<b>148</b>
When a Paper Jam Occurs .....	148
Errors.....	150
Paper Feeding Error .....	153
Paper Protection.....	153
Paper Jam .....	153

Multifeed .....	154
Feed Mode Switched.....	154
Sensor(s) dirty .....	154
<b>Cover Open Error .....</b>	<b>156</b>
Cover Open .....	156
<b>Internal and Optical Errors .....</b>	<b>157</b>
Optical Error .....	157
Operator Panel error.....	157
EEPROM Error .....	157
Image Memory Read-Write Error .....	158
<b>Overrun Error .....</b>	<b>159</b>
Background Switching Mechanism Error.....	159
<b>Chip Error.....</b>	<b>160</b>
Memory Error .....	160
<b>Motor Circuit Error .....</b>	<b>161</b>
Motor Circuit Error .....	161
Lamp Circuit Error .....	161
<b>Sensor Error .....</b>	<b>162</b>
Sensor Error .....	162
<b>Communication Related Errors .....</b>	<b>163</b>
Module Error .....	163
Network Setting Error.....	163
Server Setting Error .....	164
Scanner Central Admin Server Setting Error .....	165
Authentication Failed .....	165
<b>Other Errors .....</b>	<b>167</b>
Being used by others.....	167
The scanner is in Doc Counting mode. ....	167
Scanning has been paused by the user.....	167
Outside designated scan area error .....	167
Invalid Command .....	168
<b>Connection Test Result .....</b>	<b>169</b>
<b>Troubleshooting .....</b>	<b>171</b>
The Scanner Cannot Be Powered ON.....	173
The Touch Screen or the [Power] Button Light or Both Switch Off.....	174
The Touch Screen Does Not Function .....	175
A Malfunction Occurs in the Touch Screen/The Display on the Touch Screen Is in an Incorrect Position .....	176
The Display on the Touch Screen Is Distorted .....	177

Cannot Connect the Scanner and a Computer via Wi-Fi .....	178
A Wireless Access Point Is Not Displayed in the Access Point List .....	185
Wi-Fi Setting for WPS Fails .....	187
Failed to Establish a Wi-Fi Connection by Configuring the Settings Manually .....	191
The Connection Between the Scanner and Computer Frequently Cuts Off.....	194
Cannot Connect the Scanner and a Computer via a Wired LAN.....	195
Cannot Connect the Scanner and a Computer via a USB Cable .....	200
Cannot Connect the Scanner to a Destination by Specifying an IP Address .....	201
Cannot Connect the Scanner to a Destination by Specifying a Host Name .....	203
Scanning Does Not Start .....	206
Scanning Takes a Long Time .....	207
Image Quality Is Poor .....	208
Quality of Scanned Text or Lines Is Unsatisfactory .....	209
Images Are Distorted or Not Clear .....	210
Vertical Streaks Appear on the Images.....	211
Error Code "U4:40" Is Displayed on the Touch Screen While Scanning .....	212
Overlapped Documents Are Frequently Fed into the Scanner .....	213
Situation in Which the Document Is not Fed into the ADF Occurs Frequently .....	216
Paper Protection Is Set Off Frequently .....	218
Paper Jams/Pick Errors Occur Frequently .....	220
Images Turn Out Elongated .....	222
A Shadow Appears at the Top or the Bottom of the Image .....	223
There Are Black Traces on the Document .....	224
The Carrier Sheet Is Not Fed Smoothly/Paper Jams Occur .....	225
Part of the Image Appears Missing in the Case Where the Carrier Sheet Is Used .....	227
An Error Occurs When Entering the Default Administrator Password .....	228
<b>Before You Contact the Scanner Service Provider.....</b>	<b>229</b>
General .....	229
Error Status .....	229
<b>Checking the Product Label.....</b>	<b>231</b>
<b>Scanner Settings (Touch Screen) .....</b>	<b>232</b>
<b>Setting Items .....</b>	<b>232</b>
<b>How to connect .....</b>	<b>235</b>
<b>Power Management .....</b>	<b>236</b>
<b>Scanner Name.....</b>	<b>238</b>
<b>Scanner Code.....</b>	<b>238</b>
<b>Network .....</b>	<b>239</b>
<b>Paper Source/Feeding .....</b>	<b>246</b>

<b>Paper Protection</b> .....	<b>252</b>
<b>Image</b> .....	<b>255</b>
<b>Cleaning &amp; Maintenance</b> .....	<b>259</b>
<b>USB</b> .....	<b>260</b>
<b>Admin Password</b> .....	<b>260</b>
<b>Restore Factory Defaults</b> .....	<b>261</b>
<b>Scanner Settings (Software Operation Panel)</b> .....	<b>262</b>
<b>Starting Up the Software Operation Panel</b> .....	<b>262</b>
<b>Password Setting for the Software Operation Panel</b> .....	<b>264</b>
Setting a Password .....	265
Setting [View Only mode] .....	266
Exiting [View Only mode].....	268
Changing the Password .....	270
Clearing the Password .....	272
Resetting the Password.....	273
<b>Setting Items</b> .....	<b>275</b>
Device Setting.....	275
Device Setting 2.....	277
<b>Settings Related to Sheet Counters</b> .....	<b>280</b>
Checking the Sheet Counter.....	280
Clearing the Sheet Counters.....	282
Messages for Cleaning or Replacing Consumables .....	283
Scanner Cleaning Cycle [Cleaning Cycle] .....	284
Replacement Cycle of Consumables [Life Counter Alarm Setting] .....	285
<b>Settings Related to Scanning</b> .....	<b>286</b>
Adjusting the Position to Start the Scan [Offset Setting/Vertical magnification Adjustment] .....	286
Removing Shadows/Streaks that Appear around Edges of Images [Page Edge Filler (ADF)].....	289
Configuring the Scan Setting to Drop Out Specified Colors When Scanning [Dropout color] .....	291
Shortening the Scanning Intervals [Pre-Pick] .....	293
Specifying the Number of Retries for Paper Feeding [Number of Paper Feeding Retries] .....	294
Feeding [Pick Speed] .....	295
Cropping the Image Boundary [AutoCrop Boundary] .....	296
Protecting the Documents from Being Damaged [Paper Protection].....	298
Specifying the Sensitivity Level for Paper Protection [Paper Protection Sensitivity] .....	300
Scanning at High Altitude [High Altitude Mode] .....	302
Specifying the Image Quality for Scanning [Image Quality Mode] .....	303
<b>Settings Related to the Detection for Overlapped Documents (Multifeed)</b> .....	<b>304</b>

Specifying a Method to Detect Overlapped Documents [Multifeed] .....	304
Specifying the Area to Detect Overlapped Documents [Document check area specification for Multifeed Detection] .....	307
Setting to Ignore Certain Overlap Patterns [Intelligent Multifeed Function] .....	313
<b>Settings Related to Waiting Time .....</b>	<b>315</b>
Waiting Time in Manual Feeding [Manual Feeding] .....	315
Waiting Time for the Scanner to Enter Power Saving Mode [Power saving].....	317
<b>Settings Related to Power On/Off and Start up of the Scanner .....</b>	<b>319</b>
Method of Turning the Scanner ON/OFF [Power Switch Control] .....	319
Startup Mode Setting for the Scanner [Startup mode] .....	321
<b>Settings Related to Scanner Maintenance .....</b>	<b>322</b>
Detecting Vertical Streaks [Vertical Streak Detection] .....	322
Specifying the Sensitivity Level for Vertical Streak Detection [Vertical Streak Sensitivity] .....	323
Settings Related to Scanner Maintenance and Inspection Cycle [Maintenance and Inspection Cycle] .....	324
<b>Appendix .....</b>	<b>325</b>
<b>Basic Specification.....</b>	<b>325</b>
<b>Installation Specification .....</b>	<b>328</b>
<b>Outer Dimensions .....</b>	<b>329</b>
<b>Scanner Options .....</b>	<b>330</b>
<b>Starting Up Scanner Selection Tool for fi Series.....</b>	<b>331</b>
<b>Uninstalling the Software .....</b>	<b>332</b>
<b>Exporting the Scanner Settings (Using PaperStream NX Manager).....</b>	<b>334</b>
<b>Notes for Distributing Update Modules with the Scanner Central Admin Server .....</b>	<b>335</b>
<b>Contact for Inquiries .....</b>	<b>337</b>

# Introduction

Thank you for purchasing this product.

---

## Manuals

The following manuals are included for this product.

Read them as needed.

Manuals	Description
Safety Precautions (paper, PDF)	Contains important information about the safe use of this product. Make sure to read this manual before using the scanner. The PDF version is included in the Setup DVD-ROM.
Getting Started (paper)	Explains the operations from setting up the scanner to turning it on.
Operator's Guide (this manual) (HTML)	Provides detailed information on how to set up the scanner, how to operate and maintain the scanner daily, how to replace the consumables, and how to troubleshoot problems. Included in the Setup DVD-ROM.
Touch Screen Help (HTML)	Explains about how to troubleshoot errors and how to clean the scanner. Can be referenced from the touch screen on the scanner.
PaperStream Capture User's Guide (HTML)	Provides an overview of PaperStream Capture, as well as detailed information on installation, configuration, document scanning procedures, useful settings, and window items. Included in the Setup DVD-ROM.
PaperStream NX Manager User's Guide	Explains about the overview, installation, setup, operation, maintenance and items on the windows of PaperStream NX Manager. This guide can be downloaded from the following web page: <a href="https://www.pfu.ricoh.com/global/scanners/fi/support/manuals/">https://www.pfu.ricoh.com/global/scanners/fi/support/manuals/</a>
Help (scanner driver)	Explains how to use and configure the settings for the scanner drivers. Can be referenced from each scanner driver.
Help (application)	Explains how to use and configure the settings for the application software.

Manuals	Description
	Read them as needed. Can be referenced from each application.





- **Manuals to refer to when setting up the scanner**

Actions to take and manuals to refer to for each operating method when setting up the scanner are as follows. Read them as needed.

For details about operating methods, refer to [Operating Methods \(page 22\)](#).



Operating with a Computer



Action		Refer to
From unpackaging to turning the power on		Getting Started
Setting up the scanner	Setting a connection method	Operator's Guide  <a href="#">When Connecting the Scanner via Wi-Fi (page 38)</a>
		 <a href="#">When Connecting the Scanner via a Wired LAN (page 47)</a>
		 <a href="#">When Connecting the Scanner to the Computer via a USB Cable (page 52)</a>
	Setting for a network which requires a certificate	Operator's Guide  <a href="#">When Connecting to a Network Which Requires a Certificate (page 45)</a>
Structuring a server	Configuring preferences for a DNS server (when using a DNS server)	Manual for the DNS server
	Configuring preferences for a proxy server (when using a proxy server)	Manual for the proxy server

Action		Refer to
	From the installation to operations of Scanner Central Admin (when using Scanner Central Admin Agent)	Scanner Central Admin User's Guide <ul style="list-style-type: none"> <li>• Chapter 2 Installation of Scanner Central Admin</li> <li>• Chapter 3 Using the Scanner Central Admin Server</li> <li>• Chapter 4 Using e-Mail Alerts</li> <li>• Chapter 5 Linking with the Integrated Management System</li> </ul>
Scanning	Scanning procedure	Operator's Guide <ul style="list-style-type: none"> <li>• <a href="#">Using an Image Scanning Application on the Computer (page 73)</a></li> <li>• <a href="#">Using an Image Scanning Application Started on the Touch Screen (page 75)</a></li> </ul>
	Scan settings	<ul style="list-style-type: none"> <li>• Help for the scanner driver</li> <li>• Help for the image scanning application</li> </ul>
	Operational settings for the scanner	Operator's Guide <ul style="list-style-type: none"> <li>• <a href="#">Scanner Settings (Touch Screen) (page 232)</a></li> <li>• <a href="#">Scanner Settings (Software Operation Panel) (page 262)</a></li> </ul>



Operating with PaperStream NX Manager

Action		Refer to
	From unpackaging to turning the power on	Getting Started
Setting up the scanner	Setting a connection method	Operator's Guide <div style="text-align: center;">  </div> <p style="text-align: center;"><a href="#">When Connecting the Scanner via Wi-Fi (page 38)</a></p>

Action		Refer to
		 <p><a href="#">When Connecting the Scanner via a Wired LAN (page 47)</a></p>
	Setting for a network which requires a certificate	Operator's Guide  <p><a href="#">When Connecting to a Network Which Requires a Certificate (page 45)</a></p>
Structuring a server	Configuring preferences for a DNS server (when using a DNS server)	Manual for the DNS server
	Configuring preferences for a proxy server (when using a proxy server)	Manual for the proxy server
	From the installation to operations of PaperStream NX Manager	PaperStream NX Manager User's Guide <ul style="list-style-type: none"> <li>• Flow from the Installation to the Operations</li> <li>• Installation</li> <li>• Setup</li> <li>• Operations</li> </ul>
	From the installation to operations of Scanner Central Admin (when using Scanner Central Admin Server)	Scanner Central Admin User's Guide <ul style="list-style-type: none"> <li>• Chapter 2 Installation of Scanner Central Admin</li> <li>• Chapter 3 Using the Scanner Central Admin Server</li> </ul>
Scanning	Scanning procedure	Operator's Guide <ul style="list-style-type: none"> <li>• <a href="#">Using a Job (With PaperStream NX Manager) (page 82)</a></li> </ul>
	Scan settings	PaperStream NX Manager User's Guide <ul style="list-style-type: none"> <li>• Settings</li> </ul>
	Operational settings for the scanner	Operator's Guide <ul style="list-style-type: none"> <li>• <a href="#">Scanner Settings (Touch Screen) (page 232)</a></li> </ul>



Operating with EdgeXperience Capture Service

Action		Refer to
From unpackaging to turning the power on		Getting Started
Setting up the scanner	Setting a connection method	Operator's Guide <ul style="list-style-type: none"> <li>• <a href="#">When Connecting the Scanner to EdgeXperience Capture Service (page 50)</a></li> </ul>
Scanning	Scanning procedure	EdgeXperience Capture Service User's Guide
	Operational settings for the scanner	Operator's Guide <ul style="list-style-type: none"> <li>• <a href="#">Scanner Settings (Touch Screen) (page 232)</a></li> </ul>

---

## Trademarks

ISIS is a trademark of Open Text.

Intel and Intel Core are trademarks of Intel Corporation or its subsidiaries in the U.S. and/or other countries.

Google and Google Chrome are trademarks or registered trademarks of Google LLC.

Wi-Fi, Wi-Fi Protected Setup, and the Wi-Fi Protected Setup Logo are trademarks of Wi-Fi Alliance.

The N-Mark is a trademark or registered trademark of NFC Forum, Inc. in the United States and in other countries.

Besides the software authored by the product developer (PFU Limited), this scanner contains other free software, such as software copyrighted under the GNU General Public License (GPL) or the GNU Lesser General Public License (LGPL). For details concerning the conditions of the licenses for

Open Source Software (OSS), refer to the screen that appears when you press  in the lower right of the home screen on the touch screen of this scanner and then [Authentication/License].

Microsoft, Excel, Windows, and Windows Server are trademarks of the Microsoft group of companies.

PaperStream is a registered trademark of PFU Limited in Japan.

Other company names and product names are the registered trademarks or trademarks of the respective companies.

---

## Manufacturer

PFU Limited

YOKOHAMA i-MARK PLACE, 4-5 Minatomirai 4-chome, Nishi-ku, Yokohama-shi, Kanagawa  
220-8567 Japan.

---

## Issue Date/Issuer

Issue date: March 2026

Issued by: PFU Limited

Regulatory Model: P3768A

© PFU Limited 2018-2026

---

## Safety Information

The attached "Safety Precautions" manual contains important information about the safe and correct use of this product.

Make sure that you read and understand it before using the scanner.

---

## Symbols Used in This Manual

The following indications are used in this manual to obviate any chance of accident or damage to you, people near you, and your property.

Warning labels consist of a symbol indicating the severity and a warning statement.

The symbols and their meanings are as follows.

**WARNING**

This indication alerts operators of an operation that, if not strictly observed, may result in severe injury or death.

**CAUTION**

This indication alerts operators of an operation that, if not strictly observed, may result in safety hazards to personnel or damage to the product.

## Abbreviations Used in This Manual

The following abbreviations are used in this manual.

Name	Indication
Windows® 10 Home (32-bit/64-bit) Windows® 10 Pro (32-bit/64-bit) Windows® 10 Enterprise (32-bit/64-bit) Windows® 10 Education (32-bit/64-bit)	Windows 10 (*1)
Windows Server® 2016 Standard (64-bit)	Windows Server 2016 (*1)
Windows Server® 2019 Standard (64-bit)	Windows Server 2019 (*1)
Windows Server® 2022 Standard (64-bit)	Windows Server 2022 (*1)
Windows Server® 2025 Standard (64-bit)	Windows Server 2025 (*1)
Windows® 11 Home (64-bit) Windows® 11 Pro (64-bit) Windows® 11 Enterprise (64-bit) Windows® 11 Education (64-bit)	Windows 11 (*1)
Google Chrome™	Google Chrome
Microsoft® Word	Word
Microsoft® Excel®	Excel
Wi-Fi Protected Setup™	WPS
PaperStream IP (TWAIN) PaperStream IP (TWAIN x64) PaperStream IP (ISIS) Bundle	PaperStream IP driver
Wireless access point Wireless router	Wireless access point

\*1:Where there is no distinction between the different versions of the above operating system, the general term "Windows" is used.

## Arrow Symbols in This Manual

Right-arrow symbols (→) are used to separate icons or menu options which should be selected in succession.

**Example:**Click [Start] menu → [Control Panel].

---

## Screen Examples in This Manual

Microsoft product screenshots are reprinted with permission from Microsoft Corporation.

The screen examples in this manual are subject to change without notice in the interest of product development.

If the actual displayed screen differs from the screen examples in this manual, operate by following the actual displayed screen while referring to the user's manual of the scanner application that you are using.

The actual windows and operations may differ depending on the operating system. Also note that the screens and operations may differ from this manual after the scanner application software is updated. In that case, refer to the manual provided upon updating the software.

---

## Notice

- The contents of this manual are subject to change without notice.
- PFU Limited assumes no liability for incidental or consequential damages arising from the use of this product, and any claims by a third party.
- Copying of the contents of this manual, in whole or in part, as well as the scanner applications is prohibited under the copyright law.

# Scanner Overview

This section explains the main features of this product, the names of parts and their functions.

---

## Main Features

The scanner is equipped with the following features:

- **High speed scanning**

The scanner has achieved a scanning speed of 60 ppm/120 ipm (\*1). Furthermore, up to 80 sheets of documents (\*2) can be loaded for continuous scanning which enables you to quickly digitize a large volume of documents.

- **Network connection**

The scanner can be connected via Wi-Fi or a wired LAN. Even with a network connection, a scanning speed of 60 ppm/120 ipm (\*1) is possible. A USB cable is not required to connect the scanner and a computer so that the scanner can be placed anywhere.

- **Touch screen**

The scanner has a 4.3-inch TFT color touch screen which enables you to operate the scanner with simple actions such as seeing and touching. The touch screen also enables you to specify various operational settings for scanning documents and check the number of sheets scanned or the error status with ease.

- **Contactless smart card reader**

The scanner has a contactless smart card reader which enables you to easily log into the scanner by holding a smart card over the scanner.

- **Capable of scanning documents folded in half, envelopes, multi-layered transfer paper**

In order to scan documents folded in half, envelopes, and multi-layered transfer paper, the scanner is equipped with a feed mode switch that is used to switch the mode to Manual Single Mode. Manual Single Mode reduces the load on documents being fed so that documents are fed and scanned successfully.

- **Improved efficiency for pre-scan work**

The scanner can perform "mixed batch scanning" which allows you to scan documents with different paper weights and sizes at once. This simplifies the process of sorting the documents before scanning.

- **Reduced work loss caused by multifeeds**

The scanner has ultrasonic multifeed sensors that accurately detect "multifeed" errors where two or more sheets are fed through the scanner at once.

This detection for overlapped documents is reliable even when scanning a mixed batch of documents with different paper weights and sizes, avoiding potential work loss.

- **Intelligent multifeed detection function**

When there is paper of the same size attached to a designated location on the page, the intelligent multifeed detection function enables the scanner to recognize the location of the attachment.

The scanner does not detect the recognized area where the attachment is on as overlapping of documents so that scanning can continue.

- **Paper protection function by detecting paper jam noise**

This function reduces the risk of having the valuable documents damaged by stopping the scan when the scanner detects paper jam noise.

- **Advanced image processing function**

The automatic color detection function outputs images in color or monochrome depending on the document content.

- **Capable of scanning photographs and clippings**

The Carrier Sheet is available as an option in order to scan photographs and clippings. Multiple Carrier Sheets can be scanned in one go, and can be mixed with regular documents in the same batch.

- **Centralized operation of multiple scanners**

With PaperStream NX Manager, multiple scanners can be operated together.

For example, you can specify users who can use the scanners and specify scanning menus that are customized for each user, and distribute them to the scanners.

You can also save images in a specified linked destination, and monitor the processing status of images.

For details, refer to the PaperStream NX Manager User's Guide.

The PaperStream NX Manager User's Guide can be downloaded from the following web page:

<https://www.pfu.rioh.com/global/scanners/fi/support/manuals/>

- **Centralized management of multiple scanners**

**ATTENTION**

Scanner Central Admin Server and Scanner Central Admin Desktop have been replaced by the successor product, PaperStream Central Admin.

If you are using PaperStream Central Admin, interpret "Scanner Central Admin Server" and "Scanner Central Admin Desktop" in this manual as referring to "PaperStream Central Admin".

With Scanner Central Admin Server, multiple scanners can be managed together.

For example, the application can be used to update the setting information and the firmware update module for all scanners at once, and check the operating status of each scanner.

When PaperStream NX Manager is not used, you can use Scanner Central Admin Agent to link with Scanner Central Admin Server.

For details, refer to the Scanner Central Admin User's Guide.

**\*1:**When A4 size documents are scanned at 200/300 dpi using JPEG compression.

**\*2:**When the paper weight is 80 g/m<sup>2</sup> (20 lb).

---

## Operating Methods

This section shows the operating methods of the scanner.

- **Operating with a Computer**

This operating method is a method that uses a USB cable or network to connect the scanner and the computer to manage images on the computer.



- **Operating with PaperStream NX Manager**

This operating method is a method that uses a network to connect the scanner to PaperStream NX Manager, and uses PaperStream NX Manager to process images sent from the scanner.

You can monitor the processing status of images and save images in a specified linked destination.

This manual provides operating instruction examples using PaperStream NX Manager (with a private server).

For details about the operation with PaperStream NX Manager, refer to the PaperStream NX Manager User's Guide.

The PaperStream NX Manager User's Guide can be downloaded from the following web page:

<https://www.pfu.ricoh.com/global/scanners/fi/support/manuals/>

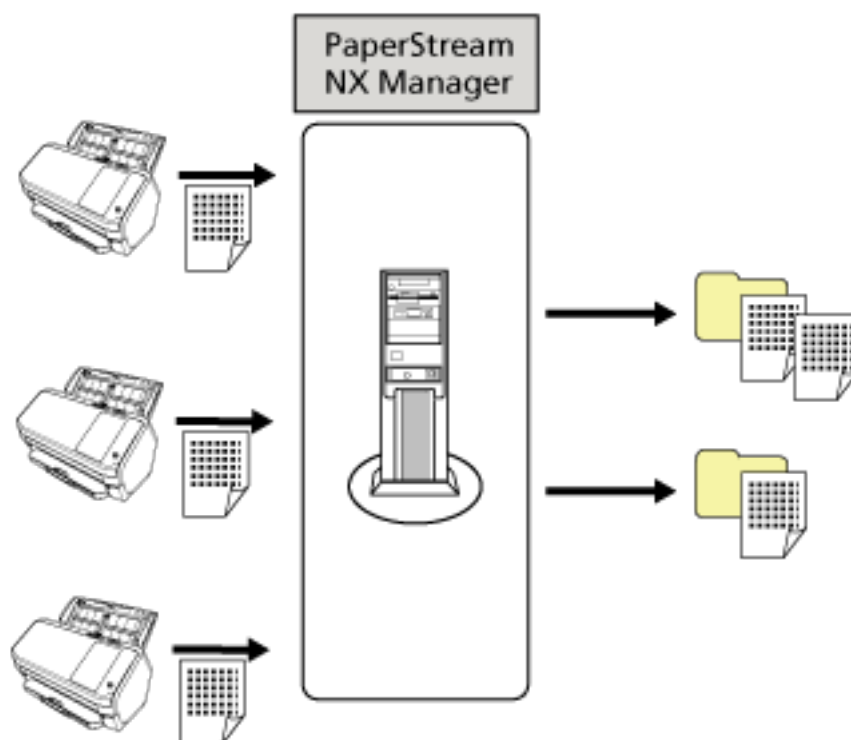

- **Operating with EdgeXperience Capture Service**

This operating method is a method that uses EdgeXperience Capture Service to process images sent from the scanner.

You can monitor the processing status of images and save images in a specified linked destination. For details about operating with EdgeXperience Capture Service, refer to the EdgeXperience Capture Service User's Guide.

Note that a contract is required to use EdgeXperience Capture Service. For information about the contract, contact the distributor/dealer where you purchased this product. Refer to the contact information in the Contact List if supplied with this product, or refer to the contact information in

the Contact for Inquiries section if provided in Safety Precautions supplied with this product, and then make an inquiry.

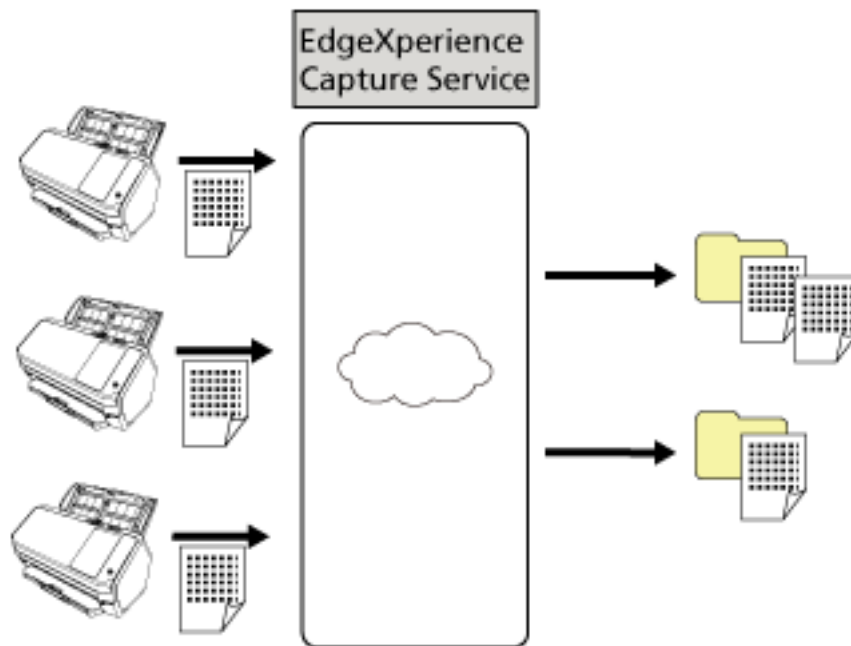

## Parts and Functions

This section shows the names of the scanner parts.

- Front

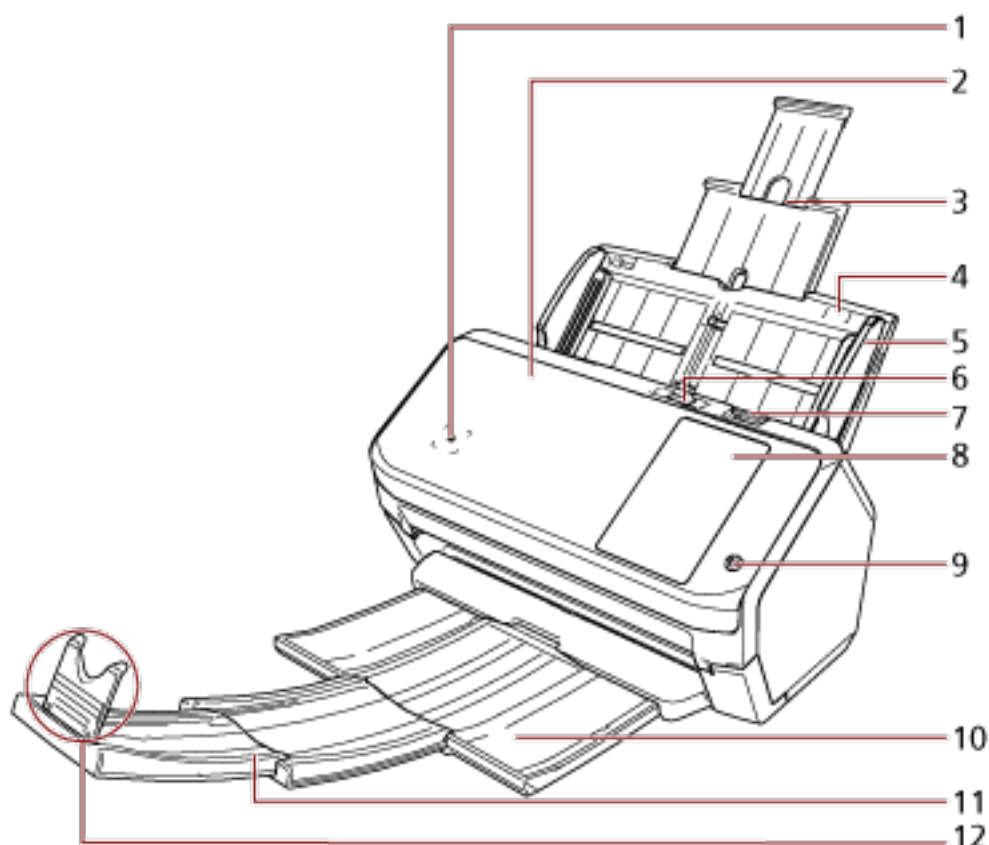

No.	Name	Function
1	Contactless Smart Card Reader	Reads the information of the smart card.
2	ADF (Automatic Document Feeder)	Pulls and feeds the documents one sheet at a time from the ADF paper chute (feeder). Open this to replace consumables or to clean the inside of the scanner.
3	Chute extension	Pull out to adjust to the document length.
4	ADF paper chute (feeder)	Holds the documents to be scanned.
5	Side guide	Positions the documents in place when the documents are loaded in the ADF paper chute (feeder) as they are fed into the scanner.
6	Feed mode switch	Slide the feed mode switch to the left to switch the feed mode to Manual Single Mode.

No.	Name	Function
7	ADF release tab	Pull this tab to open the ADF.
8	Touch screen	Used to operate the scanner or check the status.
9	[Power] button	Turns on or off the scanner.
10	Stacker	Stacks up the ejected documents.
11	Stacker extension	Slide out to adjust to the document length.
12	Stopper	Lift up to adjust to the document length.

- **Back**

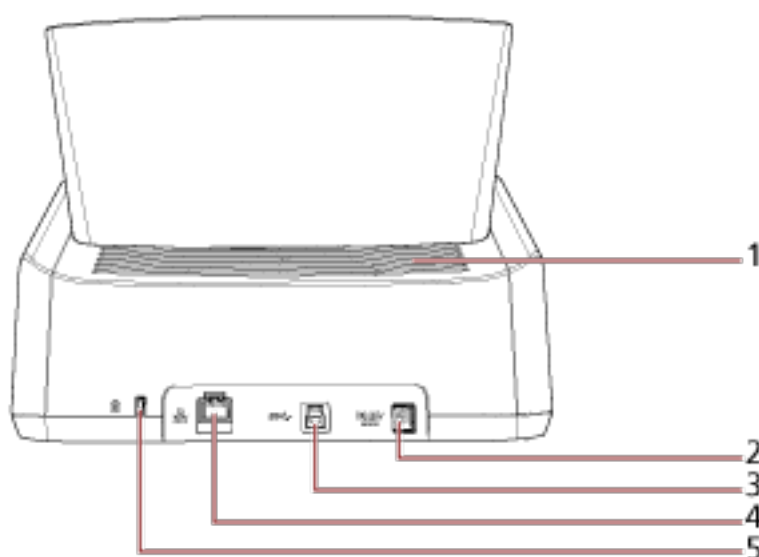

No.	Name	Function
1	Ventilation port	Holes for ventilating hot air from inside the scanner.
2	Power connector	Used to connect a power cable. "Power cable" refers to the AC cable and AC adapter connected together.
3	USB connector	Used to connect a USB cable.
4	LAN connector	Used to connect a LAN cable.
5	Security cable slot	Used to connect an anti-theft security cable (commercially available).

- Removable Parts

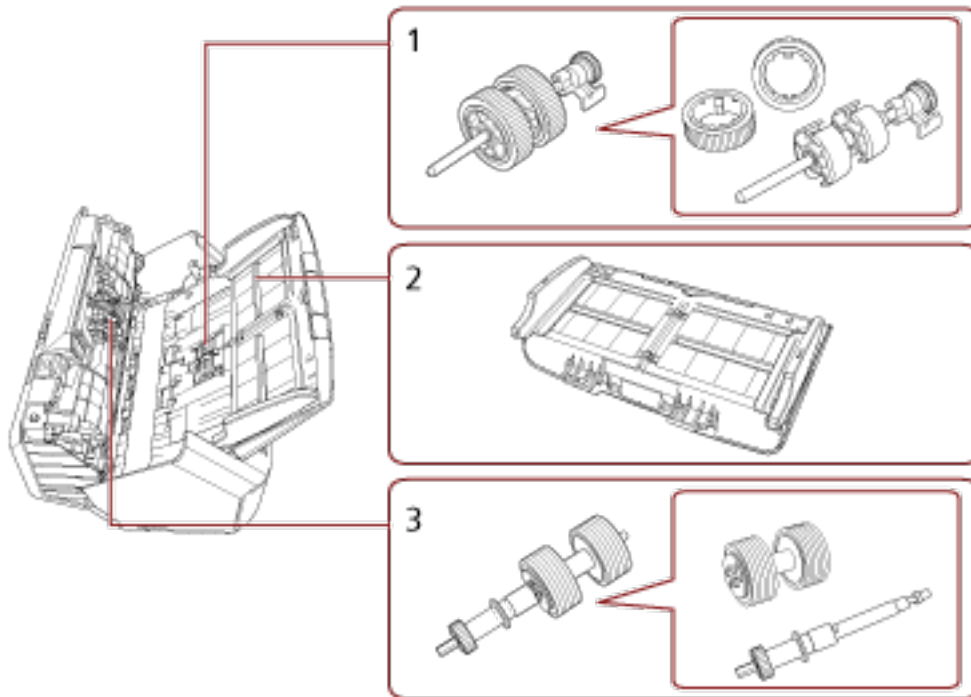

No.	Name	Function
1	Pick roller	A set of rollers which feeds documents on the ADF paper chute (feeder) into the ADF.
2	ADF paper chute (feeder)	Holds the documents to be scanned.
3	Brake roller	A roller that prevents more than one sheet of documents to be fed into the ADF at once.

● Inside (ADF)

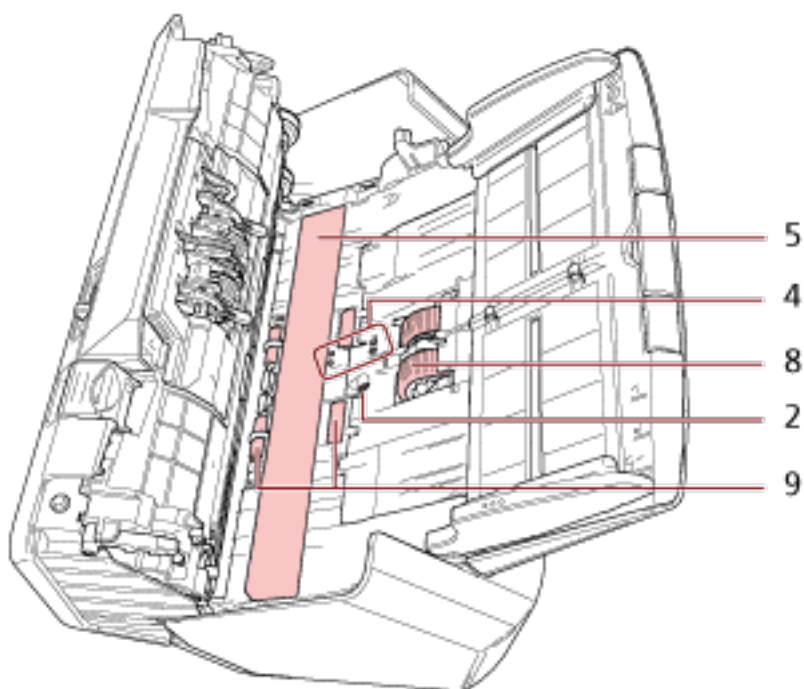
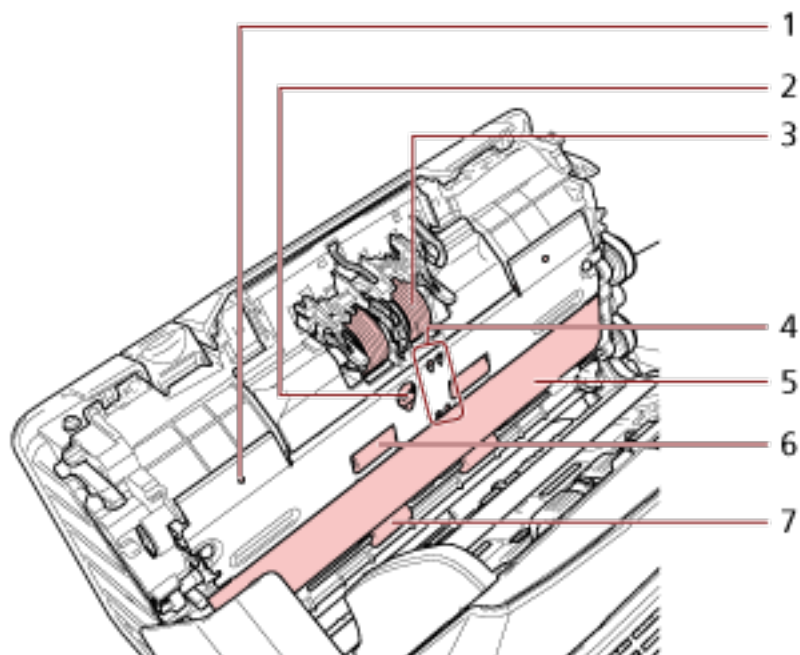

No.	Name	Function
1	Microphone (× 2)	Detects paper jam noises.
2	Ultrasonic sensor (× 2)	A sensor that detects overlapped documents by ultrasonic soundwave.

No.	Name	Function
		It detects overlapped documents by monitoring the difference in the amount of ultrasonic waves transmitted through the documents.
3	Brake roller (× 2)	A roller that prevents more than one sheet of documents to be fed into the ADF at once.
4	Document sensor (× 8)	A sensor which detects whether there is a document.
5	Glass (× 2)	The surface which scans documents.
6	Feed roller (× 2)	A roller that feeds the document through the ADF.
7	Eject roller (× 2)	Rollers that feed documents from the ADF onto the stacker.
8	Pick roller (× 2)	A set of rollers which separates one sheet off the documents loaded in the ADF paper chute (feeder), and feeds the document into the ADF.
9	Plastic idler roller (× 4)	A roller that feeds the document through the ADF.

## Icons on the Touch Screen

In the lower part of the touch screen, the following icons are displayed:

The following is an example screen when the scanner is connected via a USB cable.

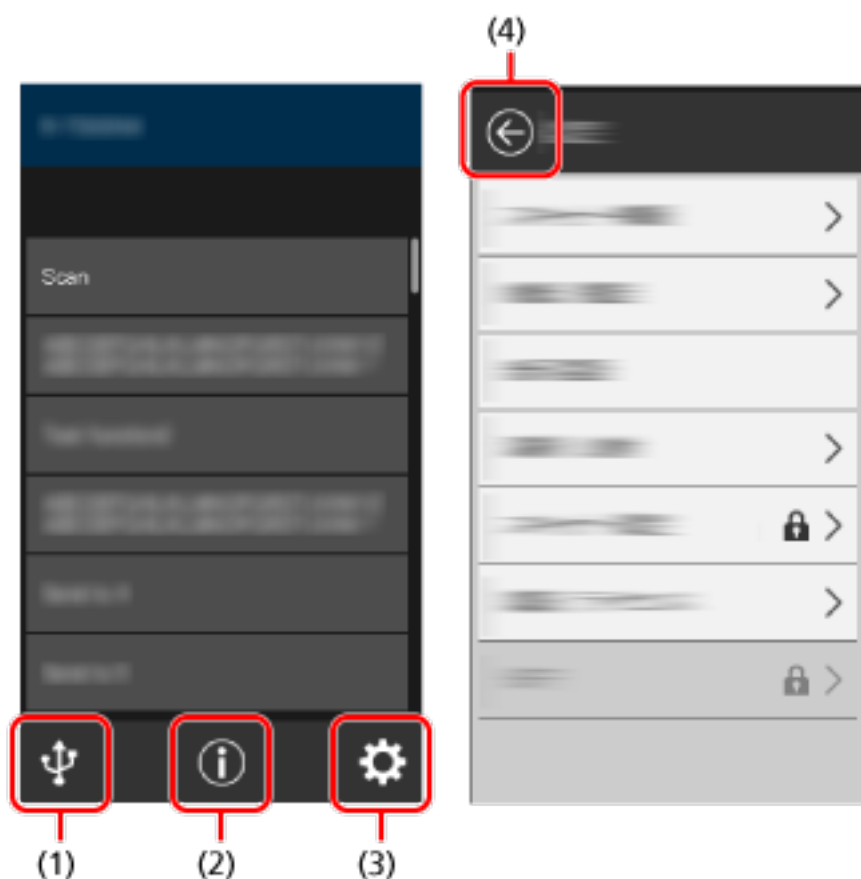

You can check the connection method of the scanner.

For details, refer to [Connection Method \(page 31\)](#).

When the scanner is connected via Wi-Fi, press the icon to display the [Wi-Fi Diagnosis] screen, and check the Wi-Fi connection status.



You can check the settings, messages and Help for the scanner.

When there is a message,  is displayed.

Press the icon to display the message.

For details, refer to [Notification \(page 31\)](#).











You can check or change the settings for the scanner.  
Press the icon to display a list of setting items.  
For details, refer to [Settings \(page 32\)](#).



Go back to the previous screen.  
Press and hold this to go back to the main screen in accordance with the connection method.

#### ● Connection Method

Connection Method	Icon	Connection Status
Wi-Fi	 (Strong)	The scanner is connected via Wi-Fi. The signal strength is displayed in three levels.
	 (Medium)	
	 (Weak)	
		The scanner is not connected via Wi-Fi.
Wired LAN		The scanner is connected via a wired LAN.
		The scanner is not connected via a wired LAN.
USB		The scanner is connected via a USB cable.
		The scanner is not connected via a USB cable.

#### ● Notification

Tab	Overview
Information	You can check the following settings. <ul style="list-style-type: none"> <li>● Number of sheets scanned</li> </ul>

Tab	Overview
	<ul style="list-style-type: none"> <li>● Operation mode for the intelligent multifeed detection function, and the number of sheets for which overlap patterns are memorized (only the overlap patterns for the last eight sheets can be memorized)</li> <li>● Whether or not to prioritize or disable the settings for [<a href="#">Paper Protection (Touch Screen Settings) (page 253)</a>] in the function for protecting documents.</li> <li>● Error information which occurred most recently</li> </ul>
Message	You can check messages for consumable replacement, cleaning, glass cleaning, and maintenance.
Help	You can check how to load documents and how to clean the scanner.

- **Settings**

Item	Overview
Scanner Information	<p>You can check the settings for the scanner.</p> <ul style="list-style-type: none"> <li>● Standard Information</li> <li>● Scanner name</li> <li>● Power Management</li> <li>● Display language</li> <li>● How to connect</li> <li>● Network</li> <li>● Network (Access Point)</li> <li>● Scanning Area</li> <li>● Video Output</li> <li>● Physical Function</li> <li>● Imaging</li> <li>● On Board IPC</li> <li>● Compression Function</li> <li>● Miscellaneous</li> <li>● Error Code Information</li> </ul>
Paper Source/ Feeding	<p><b>Paper Feeding</b></p> <p>You can specify the timing of when document feeding is started. Change this setting when overlapped documents and paper jams occur frequently.</p> <ul style="list-style-type: none"> <li>● See Also</li> </ul>

Item	Overview	
		- <a href="#">Feeding [Pick Speed] (page 295)</a>
	Document Count	<p>The number of documents can be counted without outputting images of the documents.</p> <ul style="list-style-type: none"> <li>• See Also <ul style="list-style-type: none"> <li>- <a href="#">Counting the Number of Documents (page 119)</a></li> </ul> </li> </ul>
Display language		<p>You can configure the language setting for the touch screen.</p>
Cleaning & Maintenance	Vertical Streak Detection	<p>You can configure the settings for detecting dirt on the glass.</p> <p>If the scanner detects dirt on the glass, the touch screen displays a notification on  when you receive a [Clean glass!] message. Clean the glass when you receive a message.</p> <ul style="list-style-type: none"> <li>• See Also <ul style="list-style-type: none"> <li>- <a href="#">Detecting Vertical Streaks [Vertical Streak Detection] (page 322)</a></li> <li>- <a href="#">Specifying the Sensitivity Level for Vertical Streak Detection [Vertical Streak Sensitivity] (page 323)</a></li> </ul> </li> </ul>
	Cleaning	<p>Use this setting when you clean the inside of the scanner.</p> <ul style="list-style-type: none"> <li>• See Also <ul style="list-style-type: none"> <li>- <a href="#">Daily Care (page 120)</a></li> </ul> </li> </ul>
	Consumable counters	<p>You can check the number of sheets scanned. After you replace a consumable or clean the scanner, you can clear the counter.</p> <ul style="list-style-type: none"> <li>• See Also <ul style="list-style-type: none"> <li>- <a href="#">Location and Frequency (page 122)</a></li> <li>- <a href="#">Consumables and Replacement Cycles (page 133)</a></li> </ul> </li> </ul>
Scanner Settings		<p>An administrator of the scanner uses this to configure the settings for the scanner.</p> <ul style="list-style-type: none"> <li>• See Also <ul style="list-style-type: none"> <li>- <a href="#">Scanner Settings (Touch Screen) (page 232)</a></li> </ul> </li> </ul>

Item	Overview
Authentication/License	You can check the conditions of the licenses for the authentication label and open source software.
Limited Warranty Guide/Warranty Information	The limited warranty guide or warranty information can be checked. Note that this is not displayed depending on the country or region where the scanner is purchased.
Maintenance	Service engineers use this for maintenance of the scanner.

# Scanner Setup

This section explains about setting up the scanner.

The scanner setup procedure depends on the connection method of the scanner.

Check the reference page for each method to set up the scanner.

For details about required actions to set up the scanner, refer to [Manuals to refer to when setting up the scanner \(page 10\)](#).



## ● Operating with a Computer



## When Connecting the Scanner via Wi-Fi (page 38)

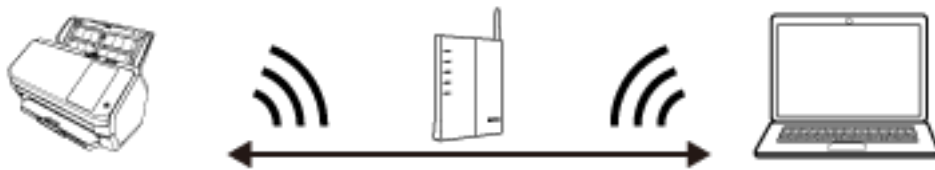

### TIP

If the network environment requires a certificate, refer to [When Connecting to a Network Which Requires a Certificate \(page 45\)](#).



## When Connecting the Scanner via a Wired LAN (page 47)

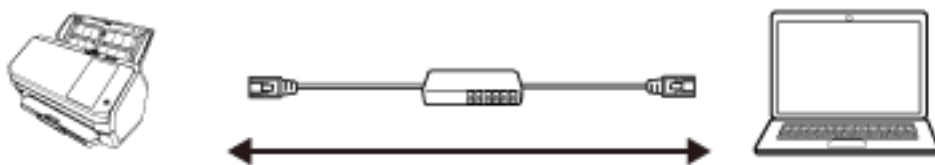



**When Connecting the Scanner to the Computer via a USB Cable (page 52)**

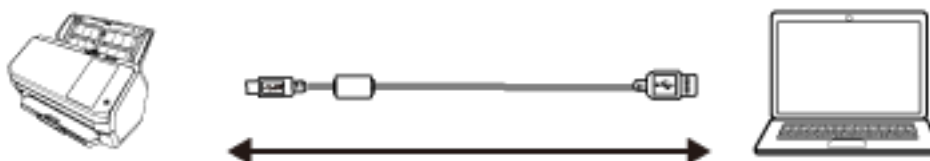

- **Operating with PaperStream NX Manager**



**When Connecting the Scanner via Wi-Fi (page 38)**

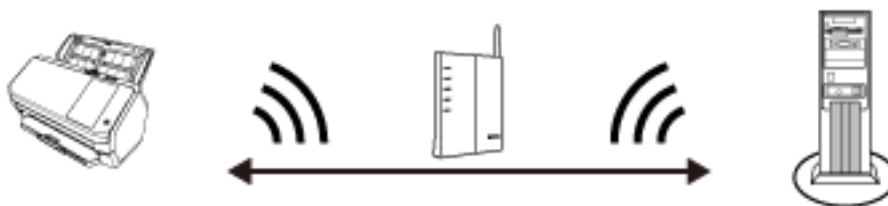

**TIP**

If the network environment requires a certificate, refer to [When Connecting to a Network Which Requires a Certificate \(page 45\)](#).



**When Connecting the Scanner via a Wired LAN (page 47)**

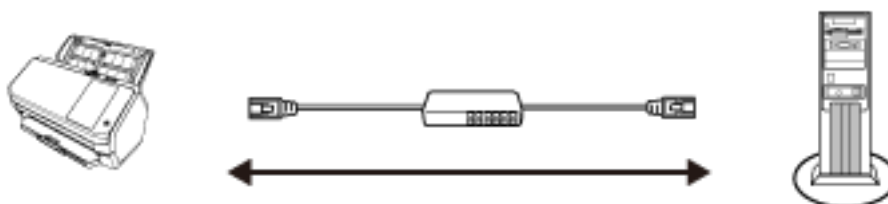

**TIP**

When centralizing the operation of multiple scanners with PaperStream NX Manager, you need to set up an environment and configure settings for PaperStream NX Manager.

For details, refer to the PaperStream NX Manager User's Guide.

The PaperStream NX Manager User's Guide can be downloaded from the following web page:

<https://www.pfu.ricoh.com/global/scanners/fi/support/manuals/>



- **Operating with EdgeXperience Capture Service**

[When Connecting the Scanner to EdgeXperience Capture Service \(page 50\)](#)

---

## When Connecting the Scanner via Wi-Fi

About the procedure from unpackaging the scanner to turning the power on, refer to Getting Started.

### 1 Turn on the scanner.

For details, refer to [How to Turn the Power ON \(page 60\)](#).

### 2 In the screen which asks whether or not to connect via Wi-Fi, press the [Yes] button.

### 3 Select a configuration method, and press the [Next] button.

Configure the setting for a wireless access point in one of the following ways:

- Select an Access Point  
Select a wireless access point from a list of wireless access points to establish a connection.  
For details, refer to [Connecting to a Wireless Access Point by Selecting One from the List of Wireless Access Points \(page 41\)](#).
- Use WPS  
Establish a connection by using WPS of the wireless access point.
  - To establish a connection by pressing the WPS button  
For details, refer to [Connecting to a Wireless Access Point by Pressing the WPS Button \(page 42\)](#).
  - To establish a connection by entering the PIN for WPS  
For details, refer to [Connecting to a Wireless Access Point by Entering the PIN for WPS \(page 43\)](#).
- Configure manually  
Establish a connection by entering the information for the wireless access point.  
For details, refer to [When Establishing a Connection by Entering the Information for the Wireless Access Point \(page 44\)](#).

#### TIP

- If the network environment requires a certificate, the certificate needs to be registered with the scanner.
- Set up the scanner by referring to [When Connecting to a Network Which Requires a Certificate \(page 45\)](#).

### 4 Specify the following items:

- IP Address  
Set an IP address for the scanner.  
When you set an IP address manually, configure [Subnet Mask] and [Default Gateway].
- DNS Server  
Set this item to use a DNS server.  
Specify IP addresses for [Primary DNS] and [Secondary DNS].
- Dynamic DNS  
Set this item to obtain an IP address automatically.

Enable this option when you want to specify a scanner name (host name) and search for a scanner in Scanner Selection Tool for fi Series.

For details, refer to "Dynamic DNS" in [Network \(page 239\)](#).

- **Network Encryption**  
Select whether or not to encrypt network communications.
- **Proxy Server**  
Set this item to use a proxy server.  
Specify [Host Name/IP address] and [Port Number]. If an authentication is necessary, specify [Username] and [Password].
- **PaperStream NX Manager**  
Set this item to use PaperStream NX Manager.  
Specify [Host Name/IP address] and [Port Number].
- **Scanner Central Admin Server**  
You can set the Scanner Central Admin Server to use PaperStream NX Manager.  
Set this item to monitor the scanners or perform a single operation on them at the same time with Scanner Central Admin Server.  
Specify [Host Name/IP address] and [Port Number].
- **Scanner name**  
Set a scanner name.

When you finish setting the relevant items, the screen indicates that the setting process is complete.

**5 Check the items that are set and press the [Complete] button.**

**6 Connect the computer, on which the scanner is to be used, to the network.**

For details about how to connect the computer to the network, refer to the computer manual.

**7 Check the connection status of the network.**

For details, refer to [Checking the Network Connection for the Scanner \(page 54\)](#).

**8 Install necessary software to the computer which is to be connected to the scanner.**

For details about the software, refer to [Installing Software \(page 55\)](#).

Prepare the bundled Setup DVD-ROM.

**TIP**

When using PaperStream NX Manager, you do not need to install software from the bundled Setup DVD-ROM. Install a necessary software by referring to the PaperStream NX Manager User's Guide.

**a If an old version of the software is installed, uninstall it first.**

For details, refer to [Uninstalling the Software \(page 332\)](#).

**b Insert the bundled Setup DVD-ROM into the DVD drive.**

The [fi Series Setup] window appears.

- c **Start the installation by following the instructions displayed in the screen.**  
It is recommended that you select [Installation (Recommended)].
- d **Configure the settings to use the scanner on the computer.**  
Use Scanner Selection Tool for fi Series to select a scanner to be used.  
For details, refer to the Scanner Selection Tool for fi Series Help.  
Scanner Selection Tool for fi Series automatically starts up when the installation of Network Setup Tool for fi Series is complete. If Scanner Selection Tool for fi Series does not start up, refer to [Starting Up Scanner Selection Tool for fi Series \(page 331\)](#).

## 9 Check whether the scanner is ready to start scanning.

For details, refer to [How to Perform a Basic Scan \(page 72\)](#).

### ATTENTION

To change the scanner settings, the administrator password is required.

You can check the default administrator password by checking whether there is a label or not.

For details about the label, refer to [Checking the Product Label \(page 231\)](#).

Change the administrator password to prevent the settings from being changed by other users.

Also, change the administrator password regularly.

The administrator password can be changed in the screen that appears in the following procedure:



→ [Scanner Settings] → [Admin Password]

### TIP

The network settings can be changed in the menu that is displayed in the following procedure.



→ [Scanner Settings] → [Network]

## Connecting to a Wireless Access Point by Selecting One from the List of Wireless Access Points

- 1** In the screen for selecting a configuration method, select [Select an Access Point] and press the [Next] button.
- 2** Check the setting items and the order of them, and then press the [Start] button.  
A list of wireless access points is displayed.
- 3** Select the wireless access point that you want to connect to, and then press the [Next] button.
- 4** Enter the information for the wireless access point.  
Enter the following:
  - Security key
  - Authentication Method
  - User ID
  - Password
  - Other necessary information for connecting to a wireless access point
- 5** After you finish entering the necessary information, press the [Next] button.  
When the connecting process is complete, the connection result is displayed.
- 6** Press the [Next] button.  
Specify each item.  
Refer to step 4 in [When Connecting the Scanner via Wi-Fi \(page 38\)](#).

## Connecting to a Wireless Access Point by Pressing the WPS Button

- 1** In the screen for selecting a configuration method, select [Use WPS] and press the [Next] button.
- 2** Check the setting items and the order of them, and then press the [Start] button.  
The screen for selecting the method with the WPS function is displayed.
- 3** Select [Push-Button] and press the [Next] button.  
The operation guidance screen is displayed.
- 4** Press the WPS button on the wireless access point to have it ready to connect to the scanner.  
For details about WPS, refer to the manual of your wireless access point.
- 5** Go back to the touch screen and press the [Next] button within two minutes.  
When the connecting process is complete, the connection result is displayed.
- 6** Press the [Next] button.  
Specify each item.  
Refer to step 4 in [When Connecting the Scanner via Wi-Fi \(page 38\)](#).

## Connecting to a Wireless Access Point by Entering the PIN for WPS

- 1** In the screen for selecting a configuration method, select [Use WPS] and press the [Next] button.
- 2** Check the setting items and the order of them, and then press the [Start] button.  
The screen for selecting the method with the WPS function is displayed.
- 3** Select [PIN] and press the [Next] button.  
The operation guidance screen is displayed.
- 4** Note down the PIN that is displayed in the screen.
- 5** On the computer, open the setting window for WPS of the wireless access point.  
For details about WPS, refer to the manual of your wireless access point.
- 6** Specify the PIN which you noted down to have it ready to connect to the scanner.
- 7** Go back to the touch screen and press the [Next] button within two minutes.  
When the connecting process is complete, the connection result is displayed.
- 8** Press the [Next] button.  
Specify each item.  
Refer to step 4 in [When Connecting the Scanner via Wi-Fi \(page 38\)](#).

## When Establishing a Connection by Entering the Information for the Wireless Access Point

**1** In the screen for selecting a configuration method, select [Configure manually] and press the [Next] button.

**2** Check the setting items and the order of them, and then press the [Start] button.

The setting screen for a wireless access point is displayed.

**3** Enter the information for the wireless access point.

Enter the following:

The information that you enter varies depending on the wireless access point that you want to connect to.

- Network name (SSID)
- Security protocol
- Security key
- Encryption method
- Authentication Method
- User ID
- Password
- Other necessary information for connecting to a wireless access point

**4** After you finish entering the necessary information, press the [Next] button.

When the connecting process is complete, the connection result is displayed.

**5** Press the [Next] button.

Specify each item.

Refer to step 4 in [When Connecting the Scanner via Wi-Fi \(page 38\)](#).

## When Connecting to a Network Which Requires a Certificate

About the procedure from unpackaging the scanner to turning the power on, refer to Getting Started.

### 1 Turn on the scanner.

For details, refer to [How to Turn the Power ON \(page 60\)](#).

### 2 Install necessary software to the computer which is to be connected to the scanner.

For details about the software, refer to [Installing Software \(page 55\)](#).

Prepare the bundled Setup DVD-ROM.

#### TIP

When using PaperStream NX Manager, you do not need to install software from the bundled Setup DVD-ROM. Install a necessary software by referring to the PaperStream NX Manager User's Guide.

#### a If an old version of the software is installed, uninstall it first.

For details, refer to [Uninstalling the Software \(page 332\)](#).

#### b Insert the bundled Setup DVD-ROM into the DVD drive.

The [fi Series Setup] window appears.

#### c Start the installation by following the instructions displayed in the screen.

It is recommended that you select [Installation (Recommended)].

#### d Connect the scanner to the computer by using the bundled USB cable.

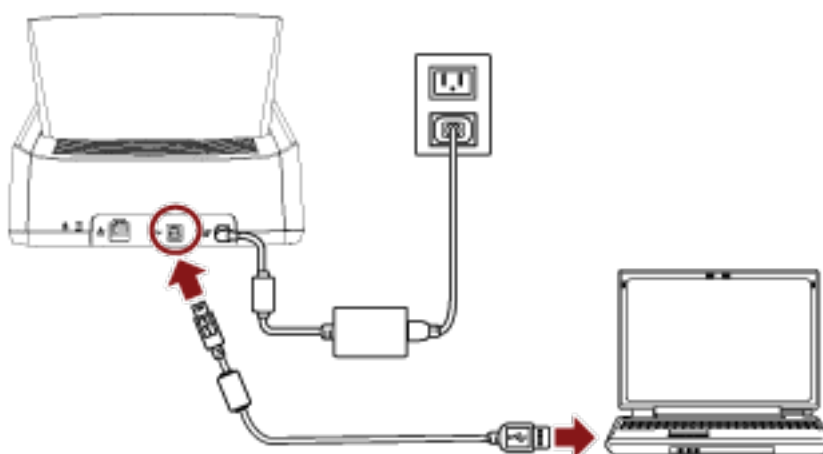

#### e Register a certificate with the scanner.

Use Certificate Registration Tool for fi Series to register a certificate with the scanner.

For details, refer to the Certificate Registration Tool for fi Series Help.

Certificate Registration Tool for fi Series can be started up in the following procedure:

- Windows 10/Windows Server 2016/Windows Server 2019/Windows Server 2022  
Click [Start] menu → [fi Series] → [Certificate Registration Tool for fi Series].
- Windows 11/Windows Server 2025

Click [Start] menu → [All apps] → [fi Series] → [Certificate Registration Tool for fi Series].

**f Remove the USB cable connecting the scanner and the computer.**

**3 Configure the settings to connect the scanner via Wi-Fi on the touch screen of the scanner.**

For details, refer to steps 2 to 7 in [When Connecting the Scanner via Wi-Fi \(page 38\)](#).

**4 Configure the settings to use the scanner on the computer.**

Use Scanner Selection Tool for fi Series to select a scanner to be used.

For details, refer to the Scanner Selection Tool for fi Series Help.

For details about how to start up Scanner Selection Tool for fi Series, refer to [Starting Up Scanner Selection Tool for fi Series \(page 331\)](#).

**5 Check whether the scanner is ready to start scanning.**

For details, refer to [How to Perform a Basic Scan \(page 72\)](#).

#### ATTENTION

To change the scanner settings, the administrator password is required.

You can check the default administrator password by checking whether there is a label or not.

For details about the label, refer to [Checking the Product Label \(page 231\)](#).

Change the administrator password to prevent the settings from being changed by other users.

Also, change the administrator password regularly.

The administrator password can be changed in the screen that appears in the following procedure:



→ [Scanner Settings] → [Admin Password]

#### TIP

The network settings can be changed in the menu that is displayed in the following procedure.



→ [Scanner Settings] → [Network]

## When Connecting the Scanner via a Wired LAN

About the procedure from unpackaging the scanner to turning the power on, refer to Getting Started.

- 1 **Turn on the scanner.**  
For details, refer to [How to Turn the Power ON \(page 60\)](#).
- 2 **In the screen which asks whether or not to connect via Wi-Fi, press the [No] button.**
- 3 **In the screen for selecting a connection method, select [Wired LAN] and press the [Next] button.**
- 4 **Check the setting items and the order of them on the window displayed.**
- 5 **Connect the scanner to a network device (such as a switch, a hub, or a router) via a LAN cable.**

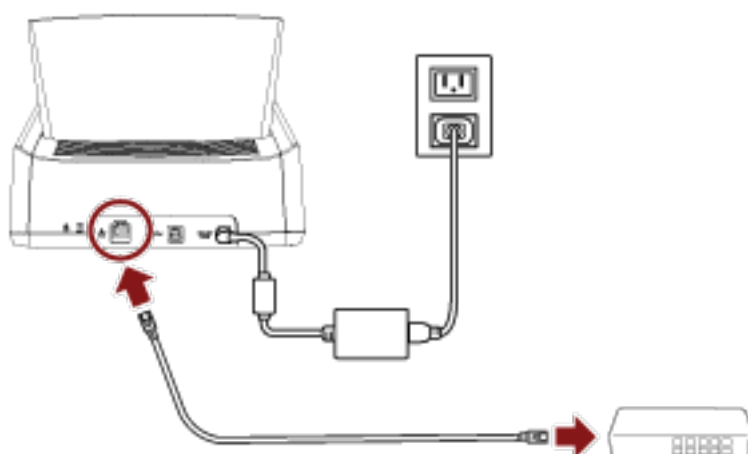

- 6 **On the window displayed in step 4, press the [Start] button.**

### 7 Specify the following items:

- **IP Address**  
Set an IP address for the scanner.  
When you set an IP address manually, configure [Subnet Mask] and [Default Gateway].
- **DNS Server**  
Set this item to use a DNS server.  
Specify IP addresses for [Primary DNS] and [Secondary DNS].
- **Dynamic DNS**  
Set this item to obtain an IP address automatically.  
Enable this option when you want to specify a scanner name (host name) and search for a scanner in Scanner Selection Tool for fi Series.  
For details, refer to "Dynamic DNS" in [Network \(page 239\)](#).
- **Network Encryption**  
Select whether or not to encrypt network communications.
- **Proxy Server**  
Set this item to use a proxy server.

Specify [Host Name/IP address] and [Port Number]. If an authentication is necessary, specify [Username] and [Password].

- PaperStream NX Manager

Set this item to use PaperStream NX Manager.

Specify [Host Name/IP address] and [Port Number].

- Scanner Central Admin Server

You can set the Scanner Central Admin Server to use PaperStream NX Manager.

Set this item to monitor the scanners or perform a single operation on them at the same time with Scanner Central Admin Server.

Specify [Host Name/IP address] and [Port Number].

- Scanner name

Set a scanner name.

When you finish setting the relevant items, the screen indicates that the setting process is complete.

**8 Check the items that are set and press the [Complete] button.**

**9 Connect the computer, on which the scanner is to be used, to the network.**

For details about how to connect the computer to the network, refer to the computer manual.

**10 Check the connection status of the network.**

For details, refer to [Checking the Network Connection for the Scanner \(page 54\)](#).

**11 Install necessary software to the computer which is to be connected to the scanner.**

For details about the software, refer to [Installing Software \(page 55\)](#).

Prepare the bundled Setup DVD-ROM.

**TIP**

When using PaperStream NX Manager, you do not need to install software from the bundled Setup DVD-ROM. Install a necessary software by referring to the PaperStream NX Manager User's Guide.

**a If an old version of the software is installed, uninstall it first.**

For details, refer to [Uninstalling the Software \(page 332\)](#).

**b Insert the bundled Setup DVD-ROM into the DVD drive.**

The [fi Series Setup] window appears.

**c Start the installation by following the instructions displayed in the screen.**

It is recommended that you select [Installation (Recommended)].

**d Configure the settings to use the scanner on the computer.**

Use Scanner Selection Tool for fi Series to select a scanner to be used.

For details, refer to the Scanner Selection Tool for fi Series Help.

Scanner Selection Tool for fi Series automatically starts up when the installation of Network Setup Tool for fi Series is complete. If Scanner Selection Tool for fi Series does not start up, refer to [Starting Up Scanner Selection Tool for fi Series \(page 331\)](#).

## 12 Check whether the scanner is ready to start scanning.

For details, refer to [How to Perform a Basic Scan \(page 72\)](#).

### ATTENTION

To change the scanner settings, the administrator password is required.

You can check the default administrator password by checking whether there is a label or not.

For details about the label, refer to [Checking the Product Label \(page 231\)](#).

Change the administrator password to prevent the settings from being changed by other users.

Also, change the administrator password regularly.

The administrator password can be changed in the screen that appears in the following procedure:



→ [Scanner Settings] → [Admin Password]

### TIP

The network settings can be changed in the menu that is displayed in the following procedure.



→ [Scanner Settings] → [Network]

---

## When Connecting the Scanner to EdgeXperience Capture Service

Note that a contract is required to use EdgeXperience Capture Service.

For information about the contract, contact the distributor/dealer where you purchased this product.

Refer to the contact information in the Contact List if supplied with this product, or refer to the contact information in the Contact for Inquiries section if provided in Safety Precautions supplied with this product, and then make an inquiry.

For details about operating with EdgeXperience Capture Service, refer to the EdgeXperience Capture Service User's Guide.

About the procedure from unpackaging the scanner to turning the power on, refer to Getting Started.

### 1 Connect the scanner using one of the following procedures.

- Steps 1 to 3 in [When Connecting the Scanner via Wi-Fi \(page 38\)](#)
- Steps 1 to 6 in [When Connecting the Scanner via a Wired LAN \(page 47\)](#)

### 2 Specify the following items:

- IP Address  
Set an IP address for the scanner.  
When you set an IP address manually, configure [Subnet Mask] and [Default Gateway].
- DNS Server  
Set this item to use a DNS server.  
Specify IP addresses for [Primary DNS] and [Secondary DNS].
- Proxy Server  
Set this item to use a proxy server.  
Specify [Host Name/IP address] and [Port Number]. If an authentication is necessary, specify [Username] and [Password].
- Network Encryption  
Select [Encryption On (HTTPS)].
- PaperStream NX Manager  
Select [EdgeXperience (Cloud)] for [Server Type] and specify [Region] and [Tenant Code].
- Startup mode  
Select a startup mode for the scanner.
- Scanner name  
Set a scanner name.

When you finish setting the relevant items, the screen indicates that the setting process is complete.

### 3 Check the items that are set and press the [Complete] button.

### 4 Check whether the scanner is ready to start scanning.

For details, refer to the EdgeXperience Capture Service User's Guide.

**ATTENTION**

To change the scanner settings, the administrator password is required.

You can check the default administrator password by checking whether there is a label or not. For details, refer to [Checking the Product Label \(page 231\)](#).

Change the administrator password to prevent the settings from being changed by other users.

Also, change the administrator password regularly.

The administrator password can be changed in the screen that appears in the following procedure:



→ [Scanner Settings] → [Admin Password]

**TIP**

The network settings can be changed in the menu that is displayed in the following procedure.



→ [Scanner Settings] → [Network]

## When Connecting the Scanner to the Computer via a USB Cable

About the procedure from unpackaging the scanner to turning the power on, refer to Getting Started.

**1 Turn on the scanner.**

For details, refer to [How to Turn the Power ON \(page 60\)](#).

**2 In the screen which asks whether or not to connect via Wi-Fi, press the [No] button.**

**3 In the screen for selecting a connection method, select [USB] and press the [Next] button.**

**4 Check the setting items and their order on the screen displayed, and press the [Start] button.**

**5 Specify the following items:**

- Scanner name  
Set a scanner name.

When you finish setting the relevant items, the screen indicates that the setting process is complete.

**6 Check the items that are set and press the [Complete] button.**

**7 Install necessary software to the computer which is to be connected to the scanner.**

For details about the software, refer to [Installing Software \(page 55\)](#).

Prepare the bundled Setup DVD-ROM.

**a If an old version of the software is installed, uninstall it first.**

For details, refer to [Uninstalling the Software \(page 332\)](#).

**b Insert the bundled Setup DVD-ROM into the DVD drive.**

The [fi Series Setup] window appears.

**c Start the installation by following the instructions displayed in the screen.**

It is recommended that you select [Installation (Recommended)].

**8 Connect the scanner to the computer by using the bundled USB cable.**

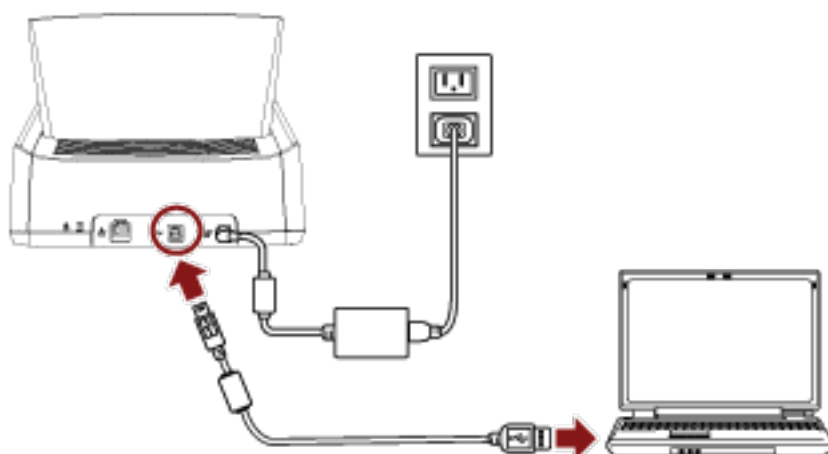

## 9 Check whether the scanner is ready to start scanning.

For details, refer to [How to Perform a Basic Scan \(page 72\)](#).

### ATTENTION

To change the scanner settings, the administrator password is required.

You can check the default administrator password by checking whether there is a label or not.

For details about the label, refer to [Checking the Product Label \(page 231\)](#).

Change the administrator password to prevent the settings from being changed by other users.

Also, change the administrator password regularly.

The administrator password can be changed in the screen that appears in the following procedure:



→ [Scanner Settings] → [Admin Password]

## Checking the Network Connection for the Scanner

When the scanner is connected to a network via Wi-Fi or a wired LAN, the network connection status can be checked.

- Connected via Wi-Fi

Use [Wi-Fi Diagnosis] to check the status of the connection with a wireless access point.

After confirming that the connection is established with a wireless access point, check the status of the connection with the computer or the server by using [Check connection (Ping)].

- Connected via a wired LAN

Use [Check connection (Ping)] to check the status of the connection with the computer or the server.

- Checking with [Wi-Fi Diagnosis]

- 1 Press  on the touch screen.
- 2 Press the [Diagnosis] button in the [Wi-Fi Diagnosis] screen.  
The diagnosis is displayed.  
Take measures according to the displayed message.

- Checking with [Check connection (Ping)]

- 1 On the touch screen, press  → [Scanner Settings] → [Network] → [Check connection (Ping)].
- 2 Enter a host name or an IP address for the destination in the [Check connection (Ping)] screen.

**TIP**

When you check the status of the connection with the computer or the server by entering a host name, the DNS server needs to be set on the scanner.

- 3 Press the [Run] button.  
The connection test result is displayed.  
For details, refer to [Connection Test Result \(page 169\)](#).

---

## Installing Software

This section describes the software that is required for the computer you want to connect the scanner to, the system requirements, and the installation method.

When using PaperStream NX Manager, refer to the PaperStream NX Manager User's Guide.

When using Scanner Central Admin, refer to the Scanner Central Admin User's Guide.

### TIP

The software can be installed from the bundled Setup DVD-ROM or downloaded from the download site and then installed.

## Overview of the Bundled Software

This product is bundled with the following software.

- PaperStream IP driver

The PaperStream IP driver is a scanner driver that conforms to the TWAIN/ISIS standard. It supports scanners connected to a network.

There are three types of PaperStream IP drivers.

- PaperStream IP (TWAIN)

Conforms to the TWAIN standard. Used when you operate the scanner using TWAIN-compliant 32-bit applications.

- PaperStream IP (TWAIN x64)

Conforms to the TWAIN standard. Used when you operate the scanner using TWAIN-compliant 64-bit applications.

It can be installed on 64-bit operating systems.

- PaperStream IP (ISIS) Bundle

Conforms to the ISIS standard. Used when you operate the scanner using ISIS-compliant applications.

For details, refer to the PaperStream IP driver Help.

- Network Setup Tool for fi Series

The following applications are included.

These applications are used to connect fi-7300NX to a network to make the scanner available.

- Scanner Selection Tool for fi Series

Use this application to set a computer to be able to use a scanner connected to a network.

For details, refer to the Scanner Selection Tool for fi Series Help.

- Certificate Registration Tool for fi Series

Use this application to register a certificate with the scanner if the network environment requires the certificate.

For details, refer to the Certificate Registration Tool for fi Series Help.

- Button Event Manager for fi Series

Use this application to configure the settings for an image scanning application which is started up from the touch screen of the scanner when it is connected to a network.

For details, refer to the help for Button Event Manager for fi Series.

- Software Operation Panel

You can configure settings that are related to scanning documents and managing consumable parts.

It is installed together with the PaperStream IP driver.

For details, refer to [Scanner Settings \(Software Operation Panel\) \(page 262\)](#).

- Error Recovery Guide

Displays the status of the scanner and a solution for a problem if an error occurs in the scanner.

It is installed together with the PaperStream IP driver.

Solutions for problems can also be checked in [Troubleshooting \(page 148\)](#).

- PaperStream ClickScan

A 32-bit image scanning application which supports PaperStream IP (TWAIN).

Scanning can be performed via simple settings and operations.

This program starts automatically when you log in to your computer and resides in the notification area located at the far right of the task bar.

For details, refer to the PaperStream ClickScan Help.

- PaperStream ClickScan Searchable PDF Option

An application to output images in a format such as searchable PDF, Word (\*1), or Excel (\*1).

It can be used with PaperStream ClickScan.

For details, refer to the PaperStream ClickScan Help.

- PaperStream Capture

A 32-bit image scanning application which supports PaperStream IP (TWAIN)/PaperStream IP (ISIS) Bundle.

By defining scan settings as jobs, you can customize the settings according to your preference.

PaperStream Capture has paid versions, namely PaperStream Capture Pro and PaperStream Capture Pro Premium. An evaluation version is available to experience the features of PaperStream Capture Pro Premium.

For details, refer to the PaperStream Capture User's Guide.

- Manuals

Safety Precautions and the Operator's Guide are installed.

- fi Series Online Update

This application checks for the latest software and firmware updates for fi Series and applies them.

For details, refer to the fi Series Online Update Help.

\*1:Microsoft® Office products need to be installed.

## System Requirements

The system requirements for the computer on which software is to be installed are as follows.

Operating system	<ul style="list-style-type: none"> <li>● Windows® 10 Home (32-bit/64-bit) (*1)</li> <li>● Windows® 10 Pro (32-bit/64-bit) (*1)</li> <li>● Windows® 10 Enterprise (32-bit/64-bit) (*1)</li> <li>● Windows® 10 Education (32-bit/64-bit) (*1)</li> <li>● Windows Server® 2016 Standard (64-bit) (*1)</li> <li>● Windows Server® 2019 Standard (64-bit) (*1)</li> <li>● Windows Server® 2022 Standard (64-bit) (*1)</li> <li>● Windows Server® 2025 Standard (64-bit) (*1)</li> <li>● Windows® 11 Home (64-bit) (*1)</li> <li>● Windows® 11 Pro (64-bit) (*1)</li> <li>● Windows® 11 Enterprise (64-bit) (*1)</li> <li>● Windows® 11 Education (64-bit) (*1)</li> </ul>
CPU	Intel or Intel-compatible processor
Display resolution	1024 × 768 pixels or higher, 65,536 or more colors (*2)
Hard disk space	11 GB or more of free hard disk space (*3)
DVD drive	Required for installing software
Interface	USB3.1 Gen1/USB3.0/USB2.0/USB1.1

\*1:The bundled software operates as a desktop application.

\*2:When using PaperStream Capture 4.0 or later, use a display with a resolution of 1280 × 800 pixels or higher and capable of displaying 65,536 or more colors.

\*3:Required disk space for scanning documents varies according to the file size of the scanned images.

## Installation (Recommended)

When [Installation (Recommended)] is selected, the following software is installed:  
Necessary software to use the scanner is installed all at once.

- PaperStream IP (TWAIN)
- Network Setup Tool for fi Series
- Software Operation Panel
- Error Recovery Guide
- PaperStream ClickScan
- PaperStream Capture
- Manuals
- fi Series Online Update

- 1 Turn on the computer and log onto Windows as a user with administrator privileges.**
- 2 Insert the Setup DVD-ROM into the DVD drive.**  
The [fi Series Setup] window appears.

### TIP

If the [fi Series Setup] window does not appear, double-click "Setup.exe" in the Setup DVD-ROM via [Explorer] or [Computer].

- 3 Click the scanner model name to be used (if the window for selecting a model name is displayed).**
- 4 Click the [Installation (Recommended)] button.**

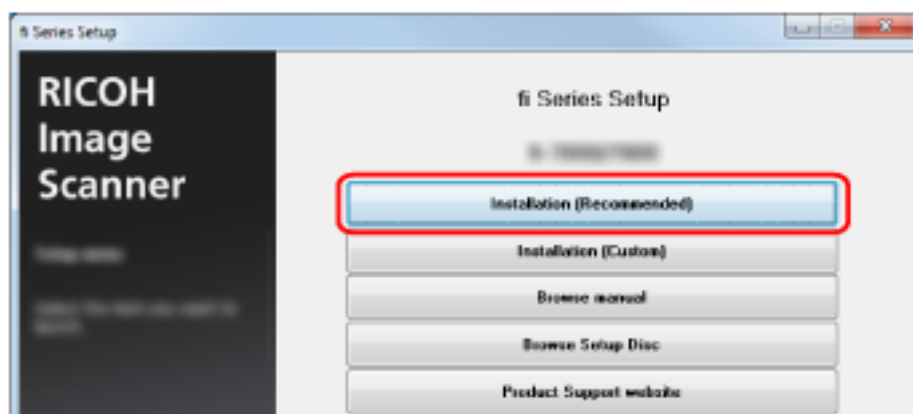

- 5 Install the software by following the instructions displayed in the window.**

## Installation (Custom)

With [Installation (Custom)], select and install necessary software.

- 1 In the same way as in [Installation \(Recommended\) \(page 58\)](#), perform steps 1 through 3.
- 2 Click the [Installation (Custom)] button.

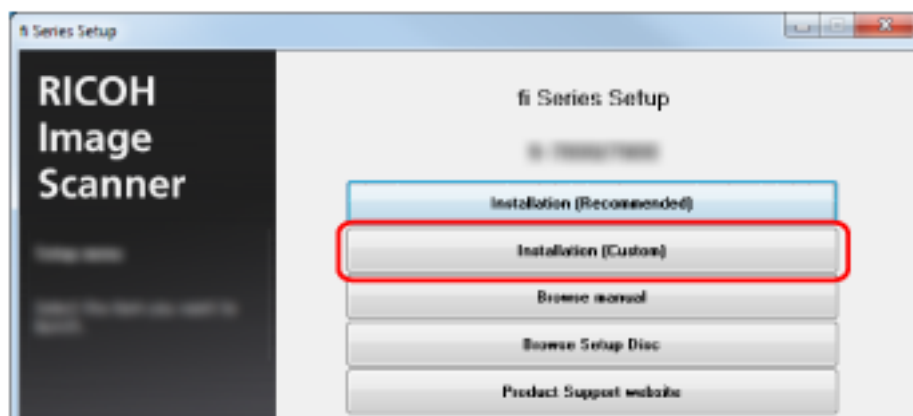

- 3 Check the displayed contents and click the [Next] button.
- 4 Select the check boxes for the software to be installed and click the [Next] button.
- 5 Install the software by following the instructions displayed in the window.

# Basic Operations

This section explains how to operate the scanner.

---

## Turning the Power ON/OFF

This section explains how to power on/off the scanner.

### TIP

The method by which the scanner is powered on/off can be specified from one of the following:

- Pressing the [Power] button on the scanner.
- Using an AC power strip to control power supply for peripherals such as a scanner in accordance with the computer's power.
- Turning on/off the scanner in accordance with the computer's power.

For details, refer to [Method of Turning the Scanner ON/OFF \[Power Switch Control\]](#) (page 319).

## How to Turn the Power ON

- 1 Press the [Power] button on the scanner.



The scanner is turned on, and the [Power] button lights in green.

The following screen is displayed on the touch screen while the scanner is in the startup process.



## How to Turn the Power OFF

- 1 Press the [Power] button on the scanner for 2 seconds or more.

The scanner is turned off, and the [Power] button switches off.

## Login/Logout (Using PaperStream NX Manager)

To establish a connection between the scanner and PaperStream NX Manager in order to use the scanner, logging in to PaperStream NX Manager is required.

Log in to PaperStream NX Manager with one of the following methods.

For details, refer to the PaperStream NX Manager User's Guide.

- Username/Password

In the login screen, enter a specific user name for logging in.

- Smart card

Log in with the user information that is stored on a smart card.

- Job Group Code

In the login screen, enter a specific job group code for logging in.

- Login

### Username/Password

- 1 The Login screen appears.

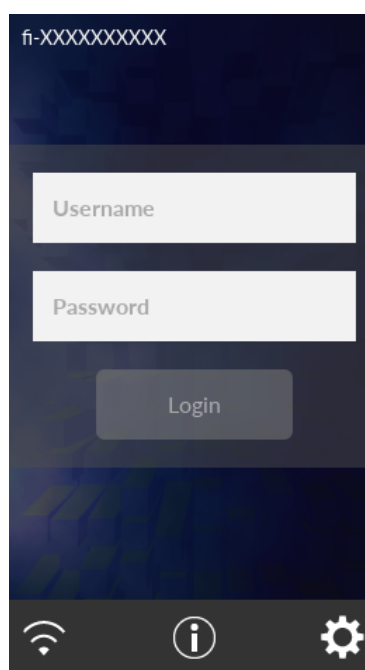

- 2 Enter Username and Password, and press the [Login] button.

## Smart card

- 1 The Login screen appears.

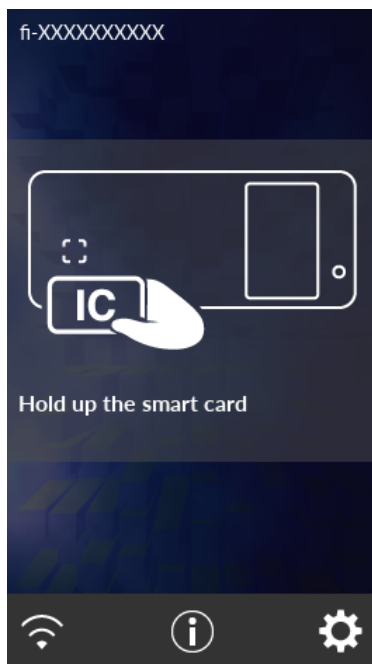

- 2 Hold a smart card over the contactless smart card reader.

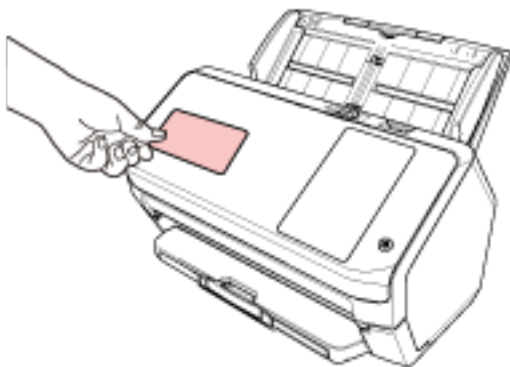

## Job Group Code

- 1 The Login screen appears.

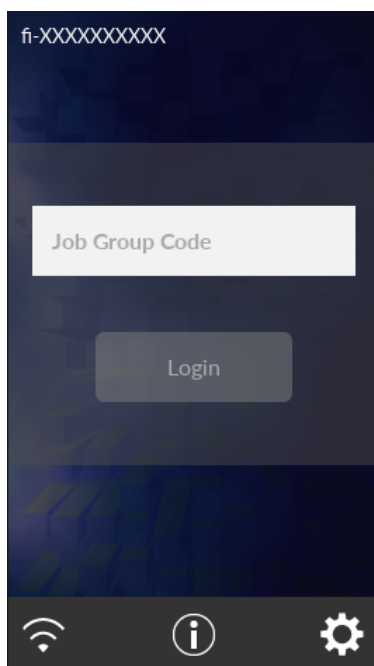

- 2 Enter Job Group Code and then press the [Login] button.  
For details about job group codes, refer to the PaperStream NX Manager User's Guide.

- **Logout**

Press the icon in the upper right of the touch screen.

## Entering and Resuming from Power Saving Mode

The scanner enters power saving mode when it is left on without being used for a certain period of time.

Power saving mode keeps the power consumption low when the scanner has not been used for a certain period of time.

Power saving mode has two types of settings.

- **Power Save**

If the scanner is left powered on for 15 minutes (factory default setting) or longer without being used, it automatically enters power saving mode.

When the scanner enters power saving mode, the touch screen switches off. The [Power] button flashes in green.

To resume from power saving mode, perform one of the following:

- Load a document in the ADF paper chute (feeder).
- Press the touch screen.
- Scans a document with the image scanning application.

- **Auto Shutdown**

The scanner is turned off automatically if it is left on without being used for a certain period of time (4 hours for the factory default setting).

To turn the power back on after the power is turned off automatically, press the [Power] button on the scanner. For details, refer to [How to Turn the Power ON \(page 60\)](#).

### ATTENTION

- If there is a document that remains on the paper path, the scanner may not enter power saving mode. Remove the documents by referring to [When a Paper Jam Occurs \(page 148\)](#).
- For some image scanning applications, the scanner may not be turned off even if [Auto Shutdown hours] is specified.
- If the scanner is automatically turned off while you are using the image scanning application, exit the application, and then turn the scanner back on.
- For the operation of the power saving mode when [Fast] is selected for [Startup Mode], refer to [Power Management \(page 236\)](#).

### TIP

- To change the waiting time for the scanner to enter power saving mode  
Specify [Power Save minutes] in the [Power Save Mode] screen on the touch screen.  
The [Power Save Mode] screen can be displayed in the following procedure:



→ [Scanner Settings] → [Power Management] → [Power Save Mode]

When using the Software Operation Panel, refer to [Waiting Time for the Scanner to Enter Power Saving Mode \[Power saving\] \(page 317\)](#).

- To prevent the scanner from being turned off automatically  
Select [Disabled] for [Auto Shutdown hours] in the [Power Save Mode] screen on the touch screen.

When [Disabled] is set, the scanner's energy consumption will increase.

The [Power Save Mode] screen can be displayed in the following procedure:



→ [Scanner Settings] → [Power Management] → [Power Save Mode]

When using the Software Operation Panel, refer to [Waiting Time for the Scanner to Enter Power Saving Mode \[Power saving\]](#) (page 317).

## Opening/Closing the ADF

This section describes how to open and close the ADF.

### How to Open the ADF

- 1 Remove all documents from the ADF paper chute (feeder).
- 2 Pull the ADF release tab towards you to open the ADF.

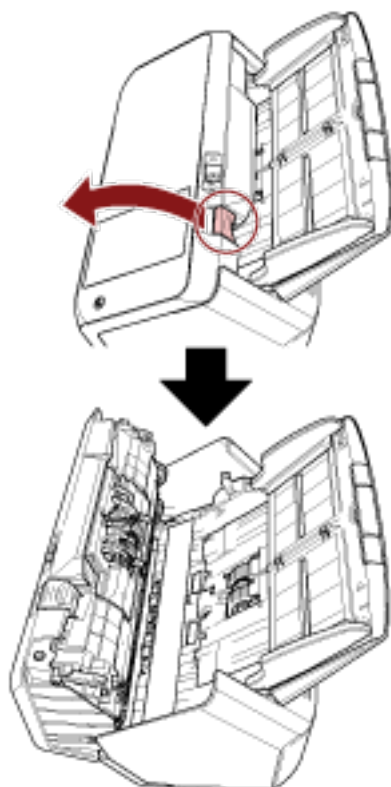
**CAUTION**

When the ADF is open, it might close accidentally. Be careful not to get your fingers caught.

## How to Close the ADF

### 1 Close the ADF.

Push the center of the ADF until it locks in place.

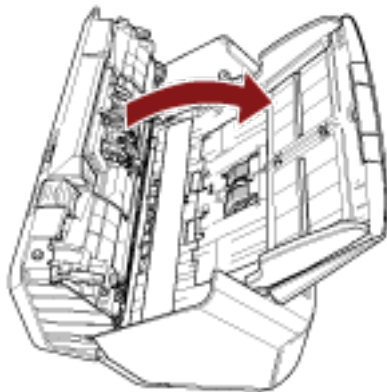

**CAUTION**

Be careful not to get your fingers caught when closing the ADF.

### **ATTENTION**

Make sure there is no foreign matter caught inside the ADF when closing the ADF.

---

## Setting Up the ADF Paper Chute (Feeder)

Documents loaded in the ADF paper chute (feeder) are fed into the ADF one by one when scanning starts.

Using the chute extension as described in the following procedure will feed documents smoothly.

- 1 Pull out the chute extension.

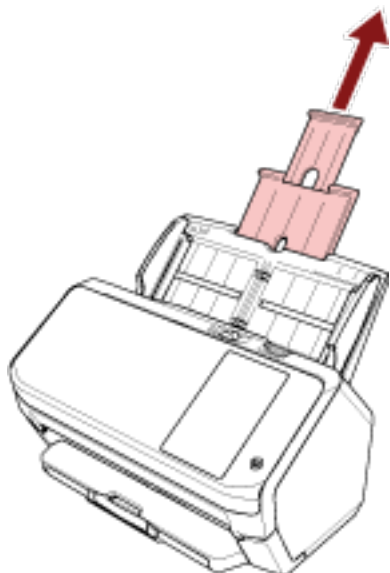
**TIP**

Make sure to hold the scanner while pulling out the chute extension.

## Setting Up the Stacker

Documents loaded in the ADF paper chute (feeder) are ejected onto the stacker one by one when scanning starts.

Using the stacker, stacker extension and stopper as described in the following procedure will keep the documents straight and feed them smoothly.

### Document Length Is A6 (Landscape) or Longer

**1 Pull out the stacker and stacker extension.**

Make sure to pull out the stacker extension all the way.

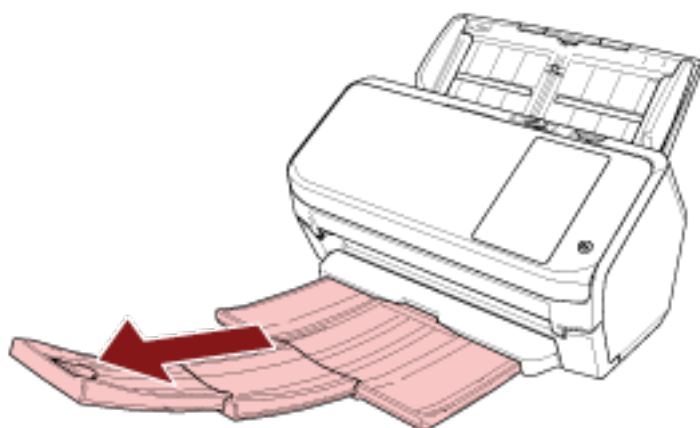

**2 Lift up the stopper.**

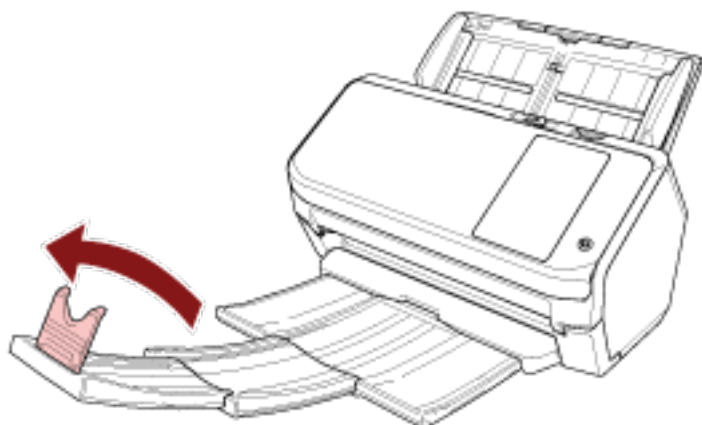

**ATTENTION**

Do not lift up the stopper more than 90 degrees, because it may break.

## Document Length Is Shorter than A6 (Landscape)

- 1 Pull out the stacker.

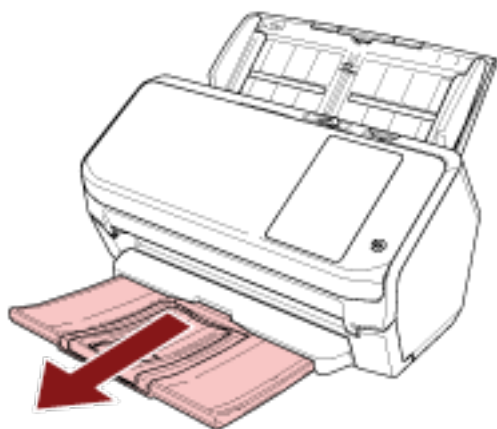

- 2 Lift up the stopper.

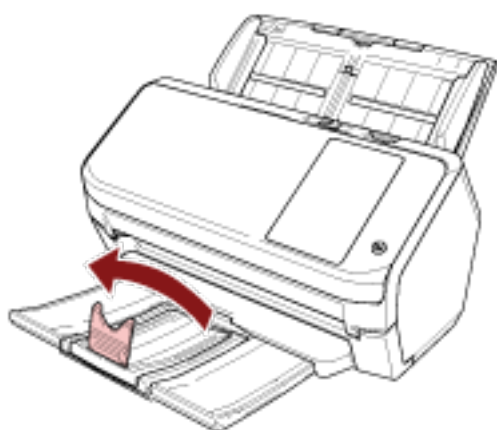

### ATTENTION

Do not lift up the stopper more than 90 degrees, because it may break.

### TIP

You can slide the stopper to adjust it to the length of documents.  
If the ejected documents are not neatly piled up, adjust the stopper to the length which is longer than the document length.

# How to Perform a Basic Scan

This section explains how to perform a basic scan.



- **Operating with a Computer**

Start scanning with one of the following methods.

- [Using an Image Scanning Application on the Computer \(page 73\)](#)
- [Using an Image Scanning Application Started on the Touch Screen \(page 75\)](#)



- **Operating with PaperStream NX Manager**

Start scanning with the following method.

- [Using a Job \(With PaperStream NX Manager\) \(page 82\)](#)

## TIP

When centralizing the operation of multiple scanners with PaperStream NX Manager, you need to set up an environment and configure settings for PaperStream NX Manager.

For details, refer to the PaperStream NX Manager User's Guide.

The PaperStream NX Manager User's Guide can be downloaded from the following web page:

<https://www.pfu.ricoh.com/global/scanners/fi/support/manuals/>

## Using an Image Scanning Application on the Computer

This section explains about the basic flow of performing a scan using an image scanning application on the computer.

In this case, a scanner driver and an image scanning application that supports the scanner driver must be installed on the computer.

The following scanner driver and image scanning applications are bundled with the scanner:

- Scanner driver
  - PaperStream IP driver
- Image scanning application
  - PaperStream ClickScan
  - PaperStream Capture

### TIP

For details about the scanner driver and image scanning applications, refer to [Overview of the Bundled Software \(page 55\)](#).

Scanning procedures, operations, and scan setting items slightly vary depending on the image scanning application and the scanner driver.

For details, refer to the help for the image scanning application and the scanner driver.

### 1 Turn on the scanner.

For details, refer to [How to Turn the Power ON \(page 60\)](#).

### 2 Load a document in the ADF paper chute (feeder).

Load the document face-down in the ADF paper chute (feeder).

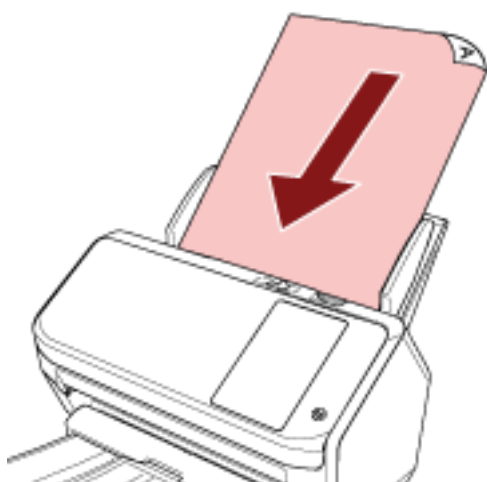

For details, refer to [How to Load Documents \(page 85\)](#).

### 3 Start an image scanning application.

### 4 Select a scanner driver to be used for scanning.

For some image scanning applications, selection of a scanner driver may not be needed.

**5 Select a scanner.**

To use a scanner connected to a network, select a scanner that is selected in Scanner Selection Tool for fi Series.

For some image scanning applications, selection of a scanner may not be needed.

**6 In the setup window for the scanner driver, configure the scan settings.**

For some image scanning applications, the setup window for the scanner driver may not appear.

**7 Scan documents with the image scanning application.****ATTENTION**

Do not perform an operation to disconnect the connection between the scanner and the computer such as the following:

**Example:**

- Disconnecting the USB cable
- Disconnecting the LAN cable
- Disconnecting the network
- Logging off

**TIP**

When an image scanning application such as PaperStream Capture that allows you to create jobs is installed on a computer, by setting a job for the scanner button in the scanning application setting, the job name is displayed on the touch screen button of the scanner.

When the scanning application on the computer is ready to scan a document, in some cases, it is possible to scan a document by pressing the [Scan Button] button on the touch screen of the scanner instead of operating the scanning application to scan a document.

When the [Scan Button] button is available for a scan, even if the name of the [Scan Button] button on the touch screen of the scanner changes to a job name, the job name button will still be recognized as if it were the [Scan Button] button when it is pressed and a scan will be performed accordingly.

## Using an Image Scanning Application Started on the Touch Screen

This section explains about the basic flow of performing a scan using an image scanning application on the computer started from the touch screen of the scanner.

In this case, there are necessary settings to be set in advance in order to perform a scan.

### 1 Button Settings (page 77)

Configure the settings for the touch screen buttons on the computer. Specify an application to be used for image scanning for each button.

The buttons set in this step correspond with the buttons displayed in the touch screen of the scanner.

The button setting procedure varies depending on the connection method of the scanner.

- When establishing a connection via a USB cable  
Display the [Devices and Printers] setting window for Windows, and set the buttons in [Scan properties] for the scanner. For details, refer to [Button Settings \(page 77\)](#).
- When establishing a connection via Wi-Fi or a wired LAN  
Set the buttons on Button Event Manager for fi Series. For details, refer to the help for Button Event Manager for fi Series.  
Access the help for Button Event Manager for fi Series in the following procedure.

#### a Start up Button Event Manager for fi Series.

- For Windows 10/Windows Server 2016/Windows Server 2019/Windows Server 2022  
Select [Start] menu → [fi Series] → [Button Event Manager for fi Series].
- For Windows 11/Windows Server 2025  
Select [Start] menu → [All apps] → [fi Series] → [Button Event Manager for fi Series].

When Button Event Manager for fi Series is started,  appears in the notification area located at the far right of the task bar.

#### b Right-click

Click [Help] on the menu that appears.

### 2 Settings on the Image Scanning Application

For some image scanning applications, settings on the image scanning application may be necessary.

For details, refer to the help for the image scanning application.

### 3 Operations on the Scanner (page 80)

Load documents on the scanner and press the touch screen button.

Pressing the button starts the image scanning application and starts scanning.

**TIP**

If PaperStream ClickScan and PaperStream Capture are installed, the image scanning application that is started up when the touch screen button for performing a scan is pressed differs depending on whether PaperStream ClickScan resides in the taskbar or not.

- When it resides in the taskbar  
PaperStream ClickScan will be started up.
- When it does not reside in the taskbar  
PaperStream Capture will be started up.

## Button Settings

When the scanner is connected via a USB cable, set the touch screen buttons in the following procedure.

- 1 Turn on the scanner and confirm that the scanner is connected to the computer.**  
For details about how to turn on the scanner, refer to [How to Turn the Power ON \(page 60\)](#).  
For details about how to connect the scanner to the computer, refer to [Icons on the Touch Screen \(page 30\)](#).
- 2 Open the [Control Panel] window.**
  - Windows 10/Windows Server 2016/Windows Server 2019/Windows Server 2022  
Click [Start] menu → [Windows System] → [Control Panel].
  - Windows 11/Windows Server 2025  
Click [Start] menu → [All apps] → [Windows Tools] and double-click [Control Panel].
- 3 Click [View devices and printers].**  
The [Devices and Printers] window appears.
- 4 Right-click on the scanner icon, and select [Scan properties] from the displayed menu.**  
The properties window of the scanner appears.

### ATTENTION

If PaperStream ClickScan resides in the taskbar, the properties window of the scanner does not appear.

When you want to display the properties window of the scanner, exit PaperStream ClickScan.

- 5 Click the [Events] tab and select a button to be set.**

From the [Select an event] drop-down list, select a button.

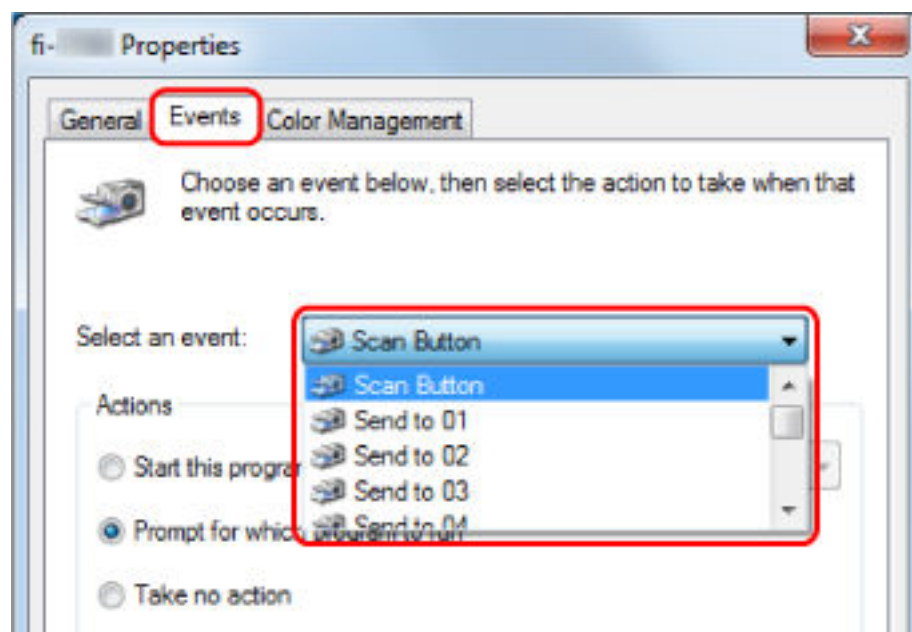

The following buttons can be selected:

- [Scan Button]/[Send to 01] to [Send to 50]

Select a button to use for scanning.

The buttons displayed in the button list are in the same order as the buttons displayed in the touch screen.

For details about the buttons displayed in the touch screen, refer to [Operations on the Scanner](#) (page 80).

## 6 Select an image scanning application to be launched when the button is pressed.

Click [Start this program] under [Actions], and select an image scanning application from the program list.

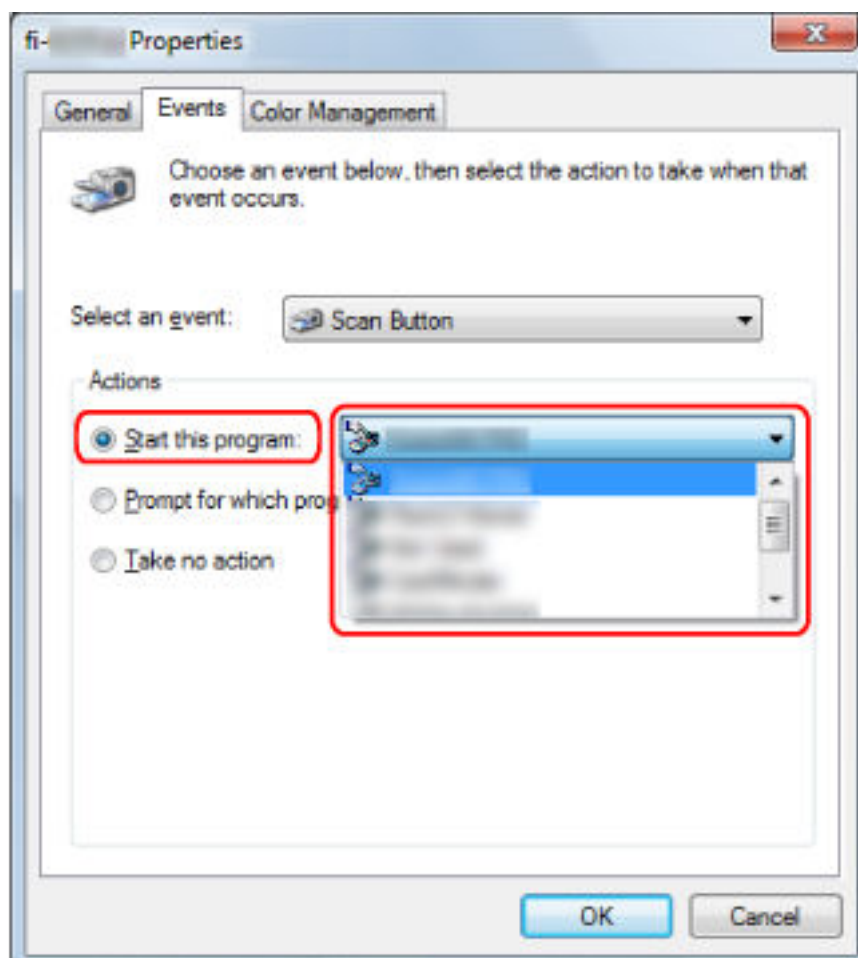

## 7 Click the [OK] button.

### TIP

- To set multiple buttons, repeat steps 5 to 6.
- When an image scanning application such as PaperStream Capture that allows you to create jobs is installed on a computer, by setting a job for the scanner button in the scanning application setting, the job name is displayed on the touch screen button of the scanner. When the scanning application on the computer is ready to scan a document, in some cases, it is possible to scan a document by pressing the [Scan Button] button on the touch screen of the scanner instead of operating the scanning application to scan a document. When the [Scan Button] button is available for a scan, even if the name of the [Scan Button] button on the touch screen of the scanner changes to a job name, the job name button will still be recognized as if it were the [Scan Button] button when it is pressed and a scan will be performed accordingly.

## Operations on the Scanner

### 1 Turn on the scanner.

For details, refer to [How to Turn the Power ON \(page 60\)](#).

### 2 Load a document in the ADF paper chute (feeder).

Load the document face-down in the ADF paper chute (feeder).

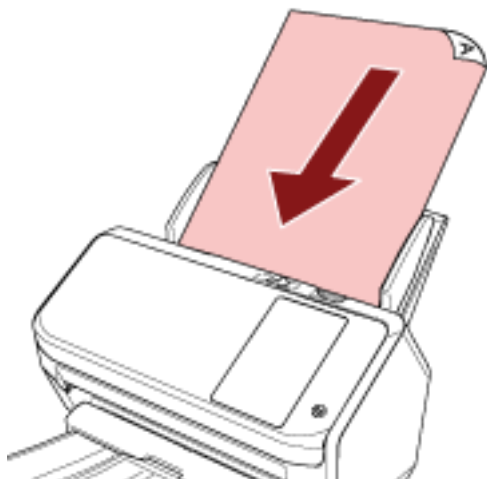

For details, refer to [How to Load Documents \(page 85\)](#).

### 3 Press the button which can perform your desired scan from the buttons displayed on the touch screen.

Pressing the button starts the image scanning application specified in [Button Settings \(page 77\)](#), and starts scanning.

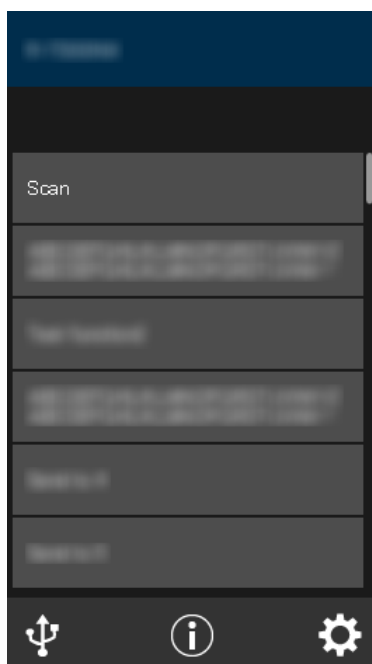

**ATTENTION**

When not using PaperStream ClickScan, do not keep PaperStream ClickScan residing in the taskbar.

If PaperStream ClickScan resides in the taskbar, the button settings may not be applied on the touch screen.

---

## Using a Job (With PaperStream NX Manager)

This section explains about the basic flow of performing a scan using a job released from PaperStream NX Manager.

To use a job for scanning documents, you need to set up an environment and configure the settings for PaperStream NX Manager.

Scanning procedures and operations slightly vary depending on the structured environment.

For details, refer to the PaperStream NX Manager User's Guide.

**1 Turn on the scanner.**

For details, refer to [How to Turn the Power ON \(page 60\)](#).

**2 When the login screen appears on the touch screen, authenticate and login.**

For details, refer to [Login/Logout \(Using PaperStream NX Manager\) \(page 62\)](#).

**3 Load a document in the ADF paper chute (feeder).**

Load the document face-down in the ADF paper chute (feeder).

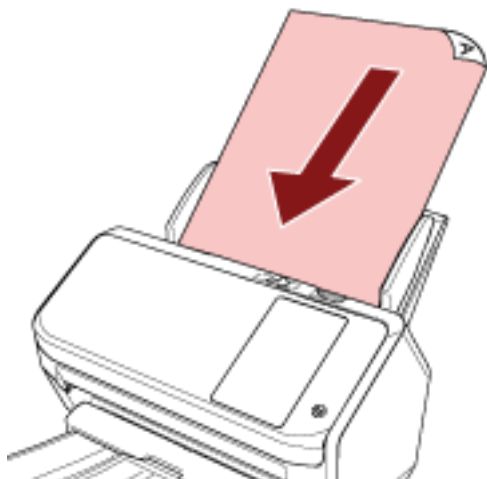

For details, refer to [How to Load Documents \(page 85\)](#).

**4 Select a job and start a scan by following the messages on the touch screen.**

For details about jobs and destinations where images are sent, refer to the PaperStream NX Manager User's Guide.

# How to Load Documents

This section explains how to load documents on the scanner.

---

## Loading Documents

This section explains how to load documents of normal paper.

## Preparation

### TIP

For details about the paper size and quality required for normal operations, refer to [Documents for Scanning \(page 87\)](#).

### 1 Check the documents.

#### a Check whether the documents to be loaded are of the same width or not.

Ways to load documents differ depending on whether the documents are of the same width or not.

If the documents are of different width, refer to [Conditions for Mixed Batch Scanning \(page 95\)](#) or [Scanning Documents with Different Widths \(page 102\)](#).

#### b Check the number of sheets.

Up to 80 sheets can be loaded (with paper weight of 80 g/m<sup>2</sup> [20 lb] and thickness of the document stack under 8 mm).

For details, refer to [Loading Capacity \(page 91\)](#).

### 2 Fan the documents.

#### a Grab a stack of documents, which should be 8 mm or less.

**b** Hold both ends of the documents and fan them a few times.

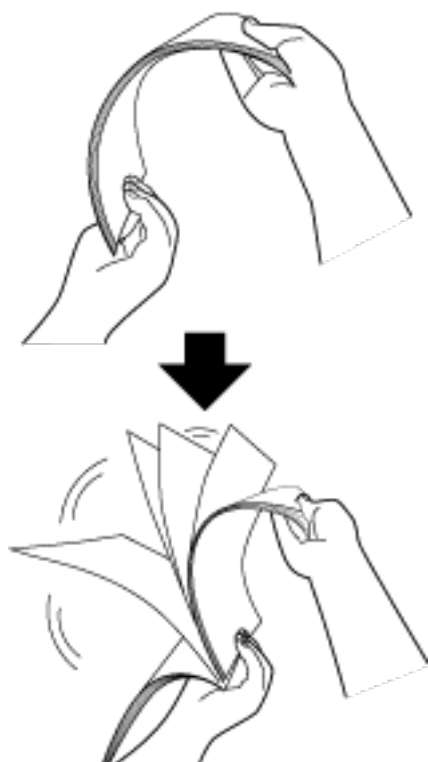

**c** Rotate the documents by 90 degrees and fan them in the same manner.

**d** Perform steps **a** to **c** for all documents.

**e** Align the top of the documents.

## How to Load Documents

- 1 Pull out the chute extension according to the length of the documents.**  
For details, refer to [Setting Up the ADF Paper Chute \(Feeder\) \(page 69\)](#).
- 2 Adjust the stacker according to the length of the documents.**  
For details, refer to [Setting Up the Stacker \(page 70\)](#).
- 3 Load a document in the ADF paper chute (feeder).**  
Load the document face-down in the ADF paper chute (feeder).

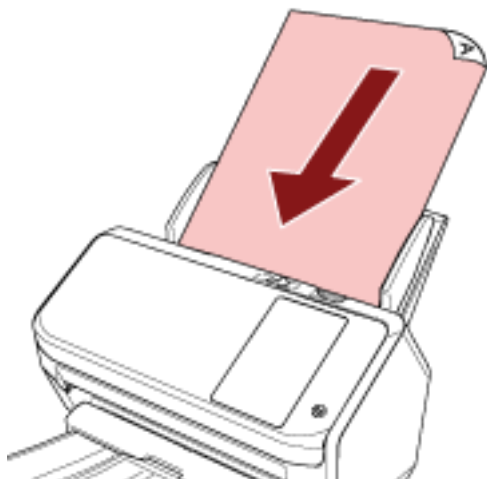

### ATTENTION

- Remove all paper clips and staples.
- Reduce the number of documents when documents are not fed into the scanner or overlapped documents are fed.

- 4 Adjust the side guides to the width of the documents.**  
Move the side guides so that there is no space between the side guides and the documents.

When there is a space between the side guides and the documents, the documents may be fed skewed.

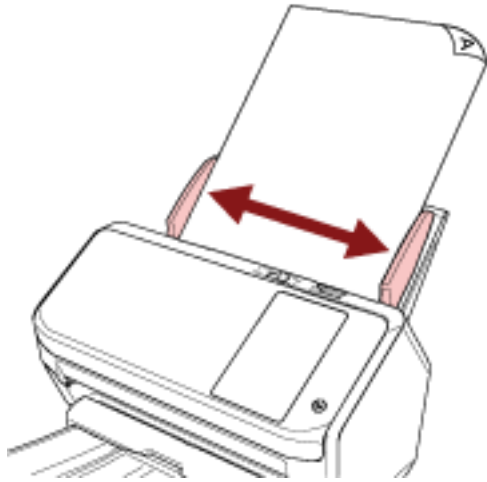

## Documents for Scanning

### Paper Size

The following paper sizes can be scanned:

Maximum size (width × length)	<ul style="list-style-type: none"> <li>● A4 (portrait) (210 × 297 mm/8.3 × 11.7 in.)</li> <li>● Legal (portrait) (8.5 × 14 in.)</li> <li>● Long page document (*1) (215.9 × 863 mm/8.5 × 34 in., 215.9 × 5,588 mm/8.5 × 220 in.)</li> </ul>
Minimum size (width × length)	<ul style="list-style-type: none"> <li>● 50.8 × 54.0 mm//2 × 2.1 in.</li> <li>● 54.0 × 50.8 mm/2.1 × 2 in.</li> </ul>

\*1: Depending on the image scanning application or the scan setting of the scanner driver, the memory may be insufficient to perform scanning.

Long page scanning supports documents with a length up to 5,588 mm (220 in.) when the resolution is set to 200 dpi or lower.

### Paper Type

The following paper types are recommended:

- Wood-free paper
- Wood-containing paper
- PPC paper (recycled)
- Plastic card

When using paper types other than the above, make sure you test with the same type of paper first to check if the document can be scanned.

### Paper Weight (Thickness)

Documents with the following paper weights can be scanned:

- 27 to 413 g/m<sup>2</sup> (7.2 to 110 lb)
- For A8 size or smaller, 128 to 209 g/m<sup>2</sup>(34 to 56 lb)
- For plastic cards, 1.4 mm or less

## Documents That May Not Be Scanned Successfully

The following types of documents may not be scanned successfully:

- Documents of non-uniform thickness (such as envelopes or documents with attachments)
- Wrinkled or curled documents
- Folded or torn documents
- Tracing paper
- Coated paper
- Carbon paper
- Photosensitive paper
- Perforated documents
- Documents that are not square or rectangular
- Very thin paper
- Very thick paper
- Photographs (photographic paper)

## Documents That Must Not Be Scanned

The following types of documents must not be scanned:

- Paper-clipped or stapled documents
- Documents on which the ink is still wet
- Documents smaller than the following size:
  - 50.8 × 54 mm/2 × 2.1 in. (width × length)
  - 54 × 50.8 mm/2.1 × 2 in. (width × length)
- Documents wider than 216 mm (8.5 in.)
- Documents other than paper/plastic card (such as fabric, metal foil and OHP film)
- Important documents that must not be damaged or smeared

## Precautions

### ● Notes on the documents to be scanned

Depending on the documents to be scanned, take note of the following.

- Since carbonless paper contains chemical substances that may harm the rollers such as the brake roller and pick roller, take note of the following:
  - Cleaning
    - If paper jams occur frequently, clean the brake roller and pick roller.
    - For details, refer to [Daily Care \(page 120\)](#).
  - Replacing the consumables
    - The life of the brake roller and pick roller may end sooner compared to scanning wood-free papers.
- When scanning wood containing papers, the life of the brake roller and pick roller may end sooner compared to scanning wood-free papers.
- The brake roller and pick roller may be damaged when a photo/sticky note on a document comes into contact with these parts during scanning.
- The surface of the document may be damaged when gloss papers such as photographs are scanned.
- The light of the LED may reflect brightly when gloss papers are scanned.
- When scanning semi-transparent documents, set [Brightness] higher in the scanner driver to avoid bleed-through.
- When you scan documents written in lead pencil, make sure you clean the rollers frequently. For details about cleaning, refer to [Daily Care \(page 120\)](#).
- If documents are not fed, or documents are fed overlapped or jammed frequently, refer to [Troubleshooting \(page 171\)](#).
- All documents must be flat on the leading edge.
  - Make sure that curls on the leading edge of the documents are kept within the following range.

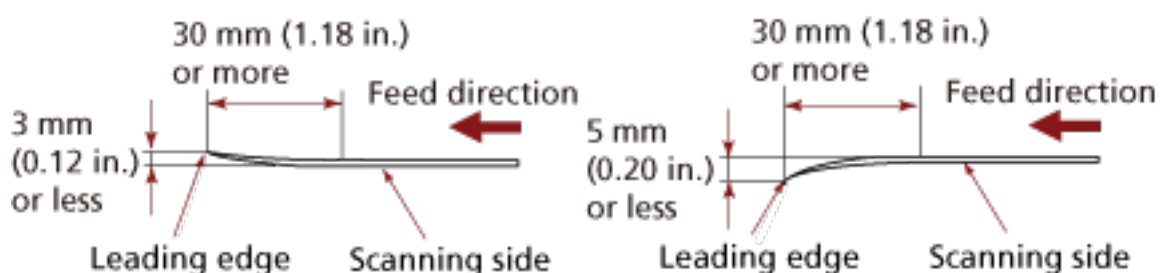

### ● Notes on plastic cards

When you scan plastic cards, take note of the following.

- Make sure you use a card that contains the following specifications, and check if the card can be fed before scanning it.

- Type: Compliant with the ISO7810 ID-1 type
- Size: 85.6 × 53.98 mm
- Thickness: 1.4 mm or less
- PVC (polyvinyl chloride) or PVCA (polyvinyl chloride acetate)
- Up to three plastic cards can be loaded in the ADF paper chute (feeder).  
Note that you can only load one card at a time if the plastic card is embossed.

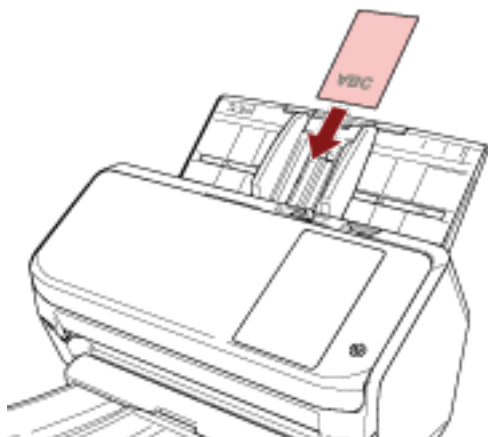

- It is recommended that the card should be placed face-down in the ADF paper chute.
- Thick or rigid cards that are difficult to bend may be fed skewed.
- If there is dirt on the surface of the card, such as grease marks (fingerprints), perform scanning after wiping the dirt off.
- Scanning a thick document such as a plastic card will always be falsely detected as overlapped documents.  
In that case, specify one of the following settings and try scanning again.
  - Use the intelligent multifeed detection function.
  - Disable the setting to detect overlapped documents by the ultrasonic sensor.
  - Scan with Manual Single Mode.

## Loading Capacity

The number of sheets that can be loaded in the ADF paper chute (feeder) is determined by the paper size and paper weight.

See the graph below.

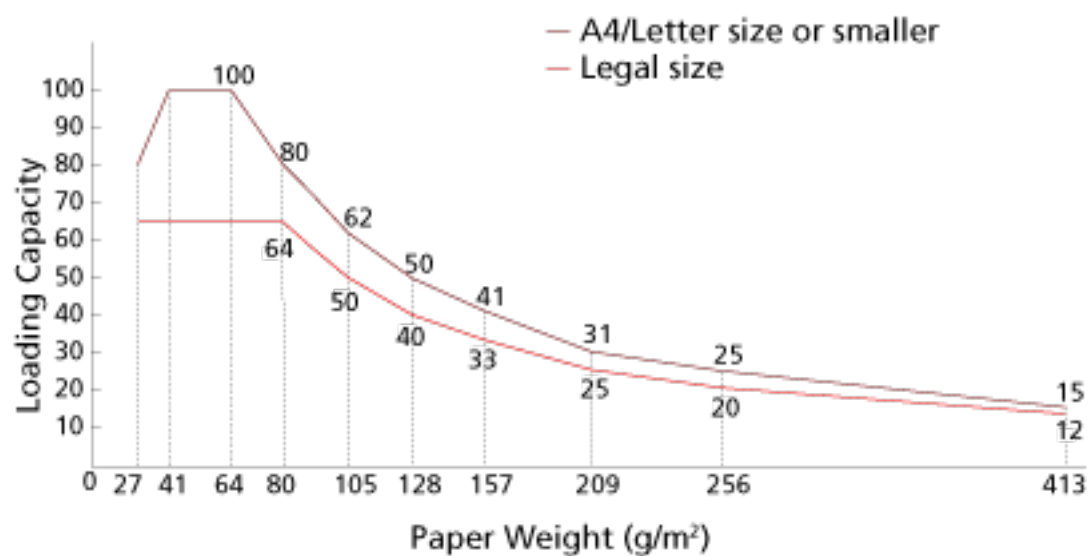

Unit	g/m <sup>2</sup>	lb	kg
Conversion	27	7.2	23
	41	11	35
	64	17	55
	80	21	69
	105	28	90
	128	34	110
	157	42	135
	209	56	180
	256	68	220
	413	110	355

## Area Not to Be Perforated

An error may occur when there are punched holes in the area colored in light pink in the Figure 1.  
Fig. 1

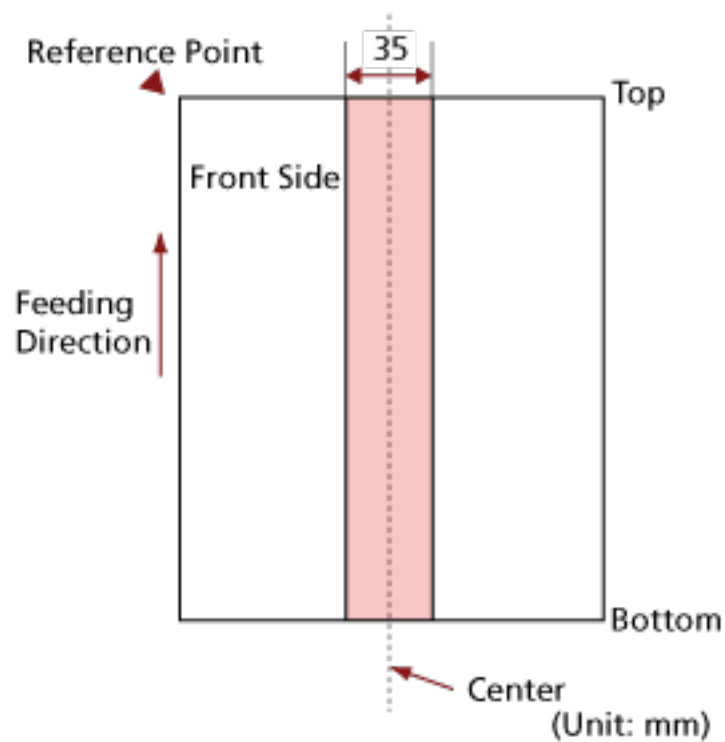

### ATTENTION

The above condition applies when the document is set to the center of the pick roller width.

### TIP

If there are any holes in the 35 mm-wide central column, you can move the document to the left or right to avoid an error.

## Conditions Required to Accurately Detect Overlapped Documents (Multifeed)

Multifeed is an error that occurs when two or more sheets are overlapped and fed at once. Overlapped documents are detected with the ultrasonic sensor or according to the difference in length of the documents.

The following conditions are required for an accurate detection.

### Detecting Overlapped Documents with the Ultrasonic Sensor

- Paper weight: 27 to 413 g/m<sup>2</sup> (7.2 to 110 lb)
- Do not punch holes within 35 mm (1.38 in.) over the center of the document. Refer to Fig. 1 in [Area Not to Be Perforated \(page 92\)](#).
- Do not attach other documents with glue or other adhesive within 35 mm (1.38 in.) over the center of the document. Refer to Fig. 1 in [Area Not to Be Perforated \(page 92\)](#).

### Detecting Overlapped Documents according to the Difference in Length

- Load the documents of the same length in the ADF paper chute (feeder).
- Variation in document lengths: 1% or less
- Do not punch holes within 35 mm (1.38 in.) over the center of the document. Refer to Fig. 1 in [Area Not to Be Perforated \(page 92\)](#).

### Detecting Overlapped Documents with the Ultrasonic Sensor and According to the Difference in Length

- Load the documents of the same length in the ADF paper chute (feeder).
- Paper weight: 27 to 413 g/m<sup>2</sup> (7.2 to 110 lb)
- Variation in document lengths: 1% or less
- Do not punch holes within 35 mm (1.38 in.) over the center of the document. Refer to Fig. 1 in [Area Not to Be Perforated \(page 92\)](#).
- Do not attach other documents with glue or other adhesive within 35 mm (1.38 in.) over the center of the document. Refer to Fig. 1 in [Area Not to Be Perforated \(page 92\)](#).

#### ATTENTION

- The above condition applies when the document is set to the center of the pick roller width.
- When an option to detect overlapping with the ultrasonic sensor is selected, scanning a thick document such as a plastic card will be falsely detected as overlapping of documents. In that case, specify one of the following settings and try scanning again.
  - Use the intelligent multifeed detection function.
  - Disable the setting to detect overlapped documents by the ultrasonic sensor.

- Scan with Manual Single Mode.

#### TIP

- The accuracy of detection for overlapped documents may drop depending on the document type.  
Overlapping cannot be detected for the top 30 mm (1.18 in.) of a document in the feeding direction.
- On the [Multifeed Detection Area] screen, you can specify an area not to detect overlapping of documents within the area described in Fig. 1 in [Area Not to Be Perforated \(page 92\)](#).  
The [Multifeed Detection Area] screen can be displayed in the following procedure:



→ [Scanner Settings] → [Paper Source/Feeding] → [Multifeed Detection Area]

When using the Software Operation Panel, refer to [Settings Related to the Detection for Overlapped Documents \(Multifeed\) \(page 304\)](#).

## Conditions for Mixed Batch Scanning

The following conditions apply when a mixed batch of documents with different paper weights/friction coefficients/sizes is scanned.

Make sure to test a few sheets first to check if the mixed batch of documents can be fed.

### Paper Direction

Align the direction of the paper fiber with the feed direction.

### Paper Weight (Thickness)

Documents with the following paper weights can be scanned when scanning a mixed batch of documents with different paper weights:

27 to 413 g/m<sup>2</sup> (7.2 to 110 lb)

### Friction Coefficient

It is recommended that the same paper brand from the same manufacturer is used for documents.

When different paper manufacturers/brands are mixed in documents to be scanned, it affects the feeding performance as the difference in friction coefficient increases.

The following friction coefficients are recommended:

0.35 to 0.60 (reference value for paper friction coefficient)

### Document Position

Load all documents covering the width of the pick roller.

For a guideline for mixed batch scanning, refer to [Combinations of Standard Paper Sizes in a Mixed Batch \(page 97\)](#) in [Paper Size \(page 96\)](#).

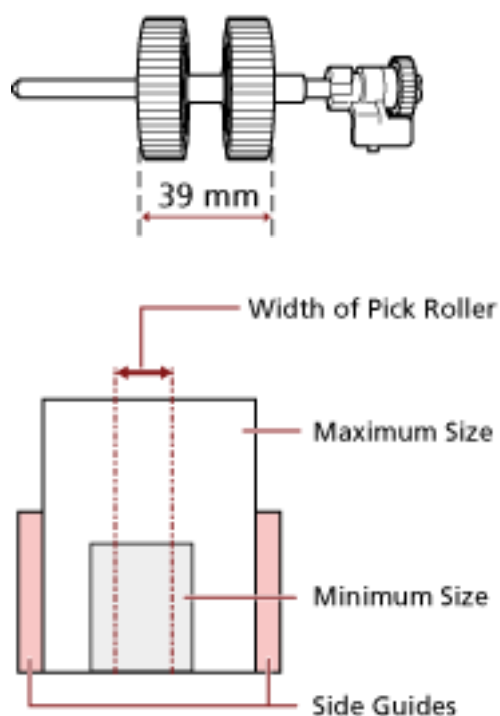

**TIP**

When the smallest document covers the width of the pick roller even when it is loaded towards one side as shown in the image below, load documents aligned on one side. So that it prevents documents from skewing when being fed.

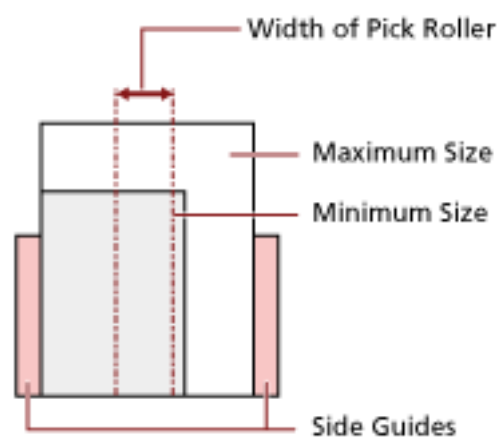
**Paper Size**

When a mixed batch with different sizes is scanned, not feeding the documents straight may cause troubles such as paper jams or part of the image to appear missing.

It is recommended that you check the scanned images if the documents were fed skewed.

**ATTENTION**

- When a mixed batch with different sizes is scanned, documents are more likely to skew because the side guides do not contact every sheet.
- Do not specify the detection method by document length when scanning a mixed batch of documents with different lengths and detecting overlapped documents.

### Combinations of Standard Paper Sizes in a Mixed Batch

Refer to the table below for a guideline of the range available for mixed batch scanning.

Document Size Width (mm)			Maximum Size											
			LTR (P) A3-CS	A4 (P) A5 (L)	B5 (P) B6 (L)	A5 (P) A6 (L)	B6 (P) B7 (L)	A6 (P) A7 (L)	B7 (P) B8 (L)	A7 (P) A8 (L)	B8 (P)	A8 (P)		
			216	210	182	149	129	105	91	74.3	64.3	52.5		
Minimum Size	LTR (P) A3-CS	216	■											
	A4 (P) A5 (L)	210	■	■										
	B5 (P) B6 (L)	182	■	■	■									
	A5 (P) A6 (L)	149			■	■								
	B6 (P) B7 (L)	129				■	■							
	A6 (P) A7 (L)	105					■	■						
	B7 (P) B8 (L)	91						■	■					
	A7 (P) A8 (L)	74.3							■	■				
	B8 (P)	64.3									■			
	A8 (P)	52.5											■	

■ Available Range

LTR: Letter size

A3-CS: Carrier Sheet

(P): Portrait

(L): Landscape

#### ATTENTION

B8 (portrait) and A8 (portrait) documents cannot be mixed with other sizes in the same batch.

#### Documents That Cannot Be Scanned in a Mixed Batch

The following types of documents cannot be mixed in the same batch:

- Carbonless paper
- Bond paper
- Perforated documents
- Thermal paper
- Carbon-backed paper

- OHP film
- Tracing paper

## Conditions for Automatic Page Size Detection

[Automatic Page Size Detection] does not work with the following type of documents:

- Non-rectangular documents

[Automatic Page Size Detection] may not work with the following types of documents:

- Thin paper (52 g/m<sup>2</sup> [14 lb] or less)
- White documents with glossy edges
- Documents with darkish (gray) edges

## Conditions for Using the Carrier Sheet

### ● Paper Size

The following paper sizes can be scanned:

- Carrier Sheet (216 × 297 mm)
- A3 (297 × 420 mm) (\*1)
- A4 (210 × 297 mm)
- A5 (148 × 210 mm)
- A6 (105 × 148 mm)
- B4 (257 × 364 mm) (\*1)
- B5 (182 × 257 mm)
- B6 (128 × 182 mm)
- Business card (51 × 89 mm) (\*2)
- Letter (8.5 × 11 in./216 × 279.4 mm)
- Double Letter (11 × 17 in./279.4 × 431.8 mm) (\*1)
- Custom size
  - Width  
25.4 to 216 mm (1 to 8.5 in.)
  - Length  
25.4 to 297 mm (1 to 11.69 in.)

\*1:Fold in half for scanning.

\*2:Available when scanning with PaperStream IP (ISIS) Bundle.

### ● Paper Conditions

#### Paper Type

The following paper type is recommended:

- Standard office paper

#### Paper Weight (Thickness)

Documents with the following paper weight can be scanned:

- Up to 209 g/m<sup>2</sup> (56 lb)

Documents with the following paper weight can be scanned when folded in half:

- Up to 105 g/m<sup>2</sup> (28 lb)

#### Precautions

Take note of the following:

- Up to three Carrier Sheets can be loaded at once.

- Depending on the image scanning application, there may be insufficient memory to perform a [Double-page spread] scan using the Carrier Sheet in high resolution. In that case, specify a lower resolution and try scanning again.
- Do not write on, color, stain, or cut the end with a black and white pattern on the Carrier Sheet. Otherwise, the Carrier Sheet may not be recognized correctly.
- Do not load the Carrier Sheet upside down. Otherwise, a paper jam may occur and damage the Carrier Sheet and the document inside.
- Do not leave a document inside the Carrier Sheet for a long time. Otherwise, the ink on the document may be transferred onto the Carrier Sheet.
- Do not leave the Carrier Sheet in high temperature places such as under direct sunlight or near a heating apparatus for a long time. Also, do not use the Carrier Sheet in such environments. Otherwise, the Carrier Sheet may deform.
- Do not fold or pull the Carrier Sheet.
- Do not use a damaged Carrier Sheet. Doing so may damage or cause the scanner to malfunction.
- To avoid deformation, keep the Carrier Sheet on a flat surface without any weight on it.
- Do not slide your finger on the edge of the Carrier Sheet. Doing so may cut your finger.
- If paper jams occur frequently, feed about 50 sheets of PPC paper (recycled paper) before scanning with the Carrier Sheet. The PPC paper can either be blank or printed.
- Paper jams may occur when several small documents (such as photos or postcards) are placed in the Carrier Sheet for scanning. It is recommended to place only one document at a time in the Carrier Sheet.

# Various Ways to Scan

This section explains how to configure the scanner settings and scan different types of documents with the image scanning application.

For information on other ways to scan which are not explained here, refer to the image scanning application or scanner driver's Help.

## Scanning Documents with Different Widths

### ATTENTION

When you scan a mixed batch with different widths, some of the narrower documents may be skewed or not fed into the ADF.

In that case, separate the documents by their widths, and scan them in different batches.

### TIP

For details about document requirements for scanning a mixed batch of documents, refer to [Conditions for Mixed Batch Scanning \(page 95\)](#).

- 1 Align the top of the documents.

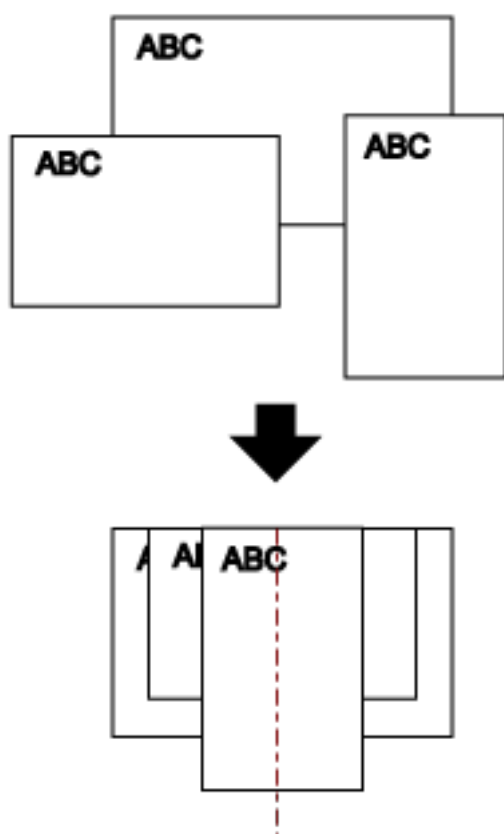

- 2 Place the documents at the center of the ADF paper chute (feeder), and adjust the side guides to the widest document in the batch.

**ATTENTION**

Load all documents above the center of the pick roller. If documents are loaded outside of the pick roller width, they may be fed skewed or not fed into the ADF.

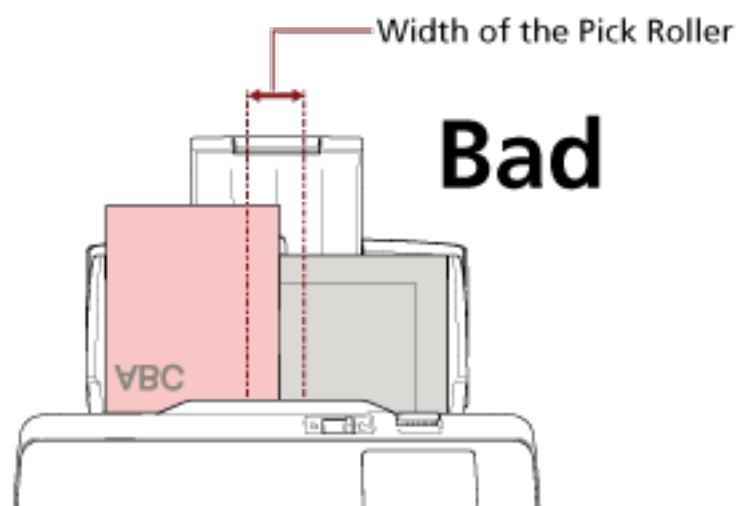
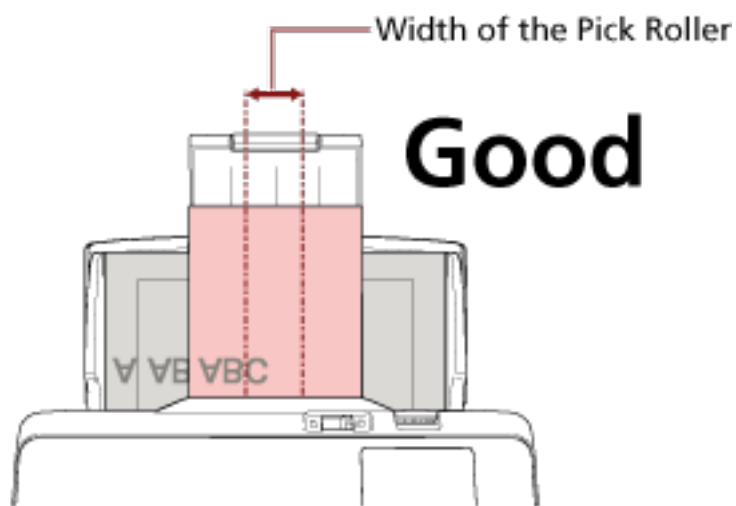

- 3 Adjust the stacker to fit the longest document.**  
For details, refer to [Setting Up the Stacker \(page 70\)](#).
- 4 In the scanner driver, configure the scan settings to detect the paper size automatically.**  
For details, refer to the help for the scanner driver.
- 5 Scan documents with the image scanning application.**  
For details, refer to the help for the image scanning application.

## Scanning Documents Folded in Half

Sliding the feed mode switch to the left to switch the feed mode to Manual Single Mode allows you to scan a document folded in half (a document of A3 or Double Letter size that is folded in half) as it is.

### ATTENTION

When a document folded in half is scanned, the document may be fed skewed if the folded part is too thick.

#### 1 Fold the document in half so that the sides to be scanned are facing out.

Fold it firmly and smooth out any creases.

Otherwise, it may cause the document to skew while feeding is in progress and result in a skewed image.

#### Example

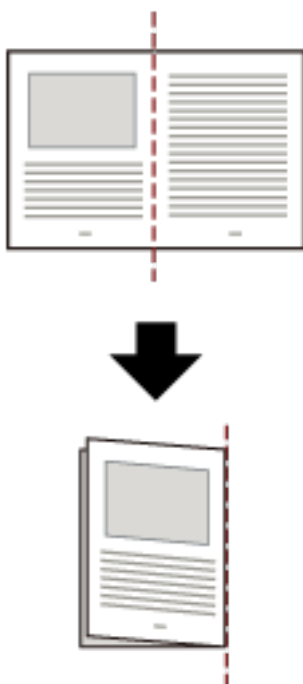

#### 2 Load the document folded in half in the ADF paper chute (feeder).

For details, refer to [How to Load Documents](#) (page 85).

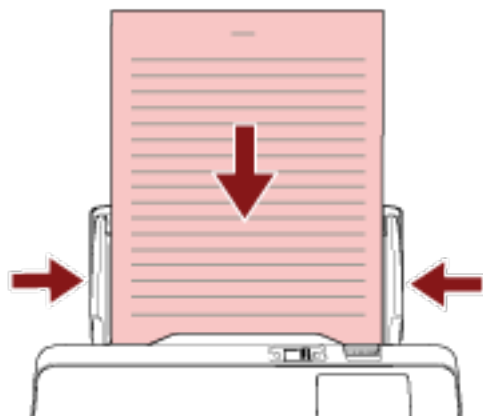

- 3** Slide the feed mode switch to the left to switch the feed mode to Manual Single Mode.

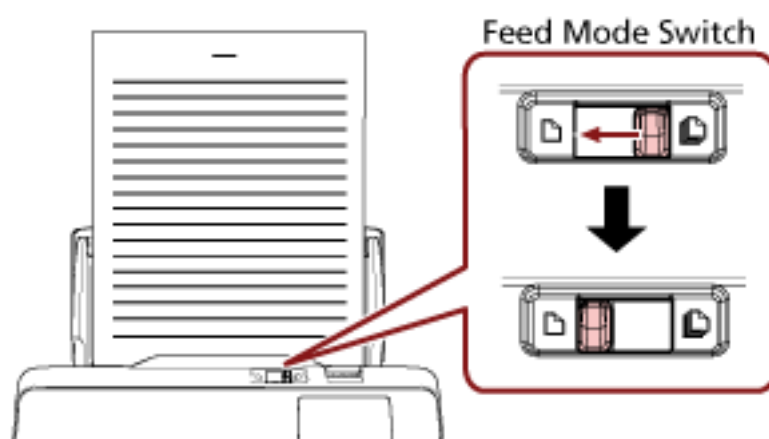

On the top of the touch screen, [Manual Single Mode] is displayed.

- 4** Scan documents with the image scanning application.

For details, refer to the help for the image scanning application.

#### ATTENTION

- Moving the feed mode switch during a scan causes an error.
- If the feed mode switch is in Manual Single Mode, overlapped documents cannot be detected by the ultrasonic sensor.

#### TIP

The scanner will wait for the next document to be loaded until the time specified for [Timeout seconds] in the [Manual Feeding] screen on the touch screen, even if there is no document in the ADF paper chute (feeder).

The [Manual Feeding] screen can be displayed in the following procedure:



→ [Scanner Settings] → [Paper Source/Feeding] → [Manual Feeding]

When using the Software Operation Panel, refer to [Waiting Time in Manual Feeding \[Manual Feeding\]](#) (page 315).

## Scanning Documents such as Envelopes or Multi-Layered Transfer Paper

Sliding the feed mode switch to the left to switch the feed mode to Manual Single Mode allows you to scan documents such as envelopes and multi-layered transfer paper.

### ATTENTION

For details about the paper weights of the documents that can be scanned, refer to [Documents for Scanning](#) (page 87).

#### 1 Load a document in the ADF paper chute (feeder).

To scan a multi-layered transfer paper, position the bound edge first when loading the paper. For details, refer to [How to Load Documents](#) (page 85).

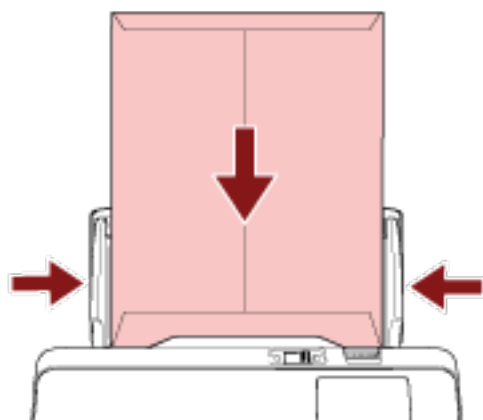

#### 2 Slide the feed mode switch to the left to switch the feed mode to Manual Single Mode.

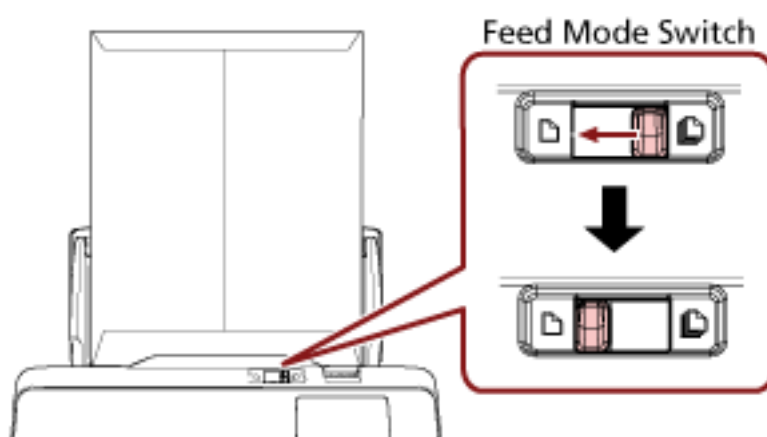

On the top of the touch screen, [Manual Single Mode] is displayed.

#### 3 Scan documents with the image scanning application.

For details, refer to the help for the image scanning application.

**ATTENTION**

- Moving the feed mode switch during a scan causes an error.
- If the feed mode switch is in Manual Single Mode, overlapped documents cannot be detected by the ultrasonic sensor.

**TIP**

The scanner will wait for the next document to be loaded until the time specified for [Timeout seconds] in the [Manual Feeding] screen on the touch screen, even if there is no document in the ADF paper chute (feeder).

The [Manual Feeding] screen can be displayed in the following procedure:



→ [Scanner Settings] → [Paper Source/Feeding] → [Manual Feeding]

When using the Software Operation Panel, refer to [Waiting Time in Manual Feeding \[Manual Feeding\]](#) (page 315).

## Scanning Photographs and Clippings

Using the Carrier Sheet allows you to scan documents that can be damaged quite easily such as photographs, or documents that are difficult to load directly such as newspaper clippings.

### 1 Place the document inside the Carrier Sheet.

Open the Carrier Sheet and place the document against the top center of the Carrier Sheet.



### 2 Load the Carrier Sheet with the end with the black and white pattern as the leading edge and with the scanning side facing the ADF paper chute (feeder) (face-down).

Secure the Carrier Sheet with the side guides to avoid skewing.

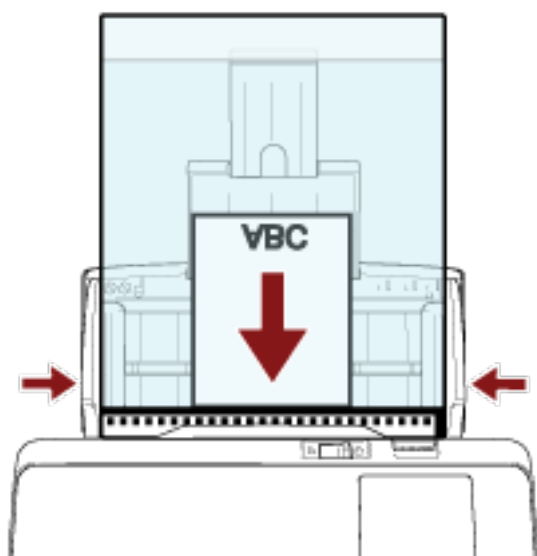

### 3 Configure the scan settings in the scanner driver to use the Carrier Sheet.

For details, refer to the help for the scanner driver.

### 4 Scan documents with the image scanning application.

For details, refer to the help for the image scanning application.

**ATTENTION**

- The image is output at the center of the page in the size specified for [Paper Size] in the scanner driver.
- When [Automatic] is specified for [Paper Size] in the scanner driver, the most suitable size is selected from standard sizes which can be specified for [Paper Size]. Note that the size of the image may become smaller than the original document depending on the document scanned, or part of the image may appear missing.

**Example**

When an A5 size image is printed in the center of an A4 size document

→ The image is output in A5 size.

To output the scanned image in the actual size of the document, specify the document size for [Paper size].

**TIP**

In the following cases, place a blank (white) sheet of paper behind the document when scanning.

- The scanned image is not output in the actual size of the document when [Automatic] is specified for [Paper size] in the scanner driver.
- Shadows appear around the edges of the scanned image.
- Black lines appear around the edges of a uniquely shaped cutting.
- Image outside the document appears on the scanned image.

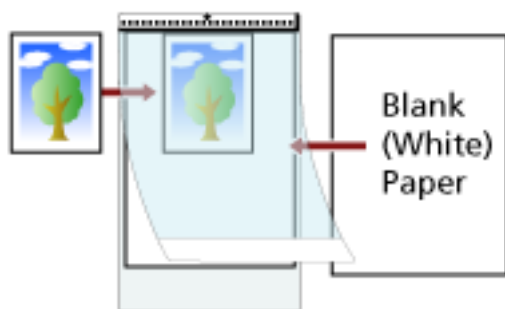

## Scanning Long Page Documents

Documents with a length up to 5,588 mm (220 in.) can be scanned by long page scanning.

Depending on the resolution setting or the image scanning application, the document sizes that can be scanned may differ.

For details, refer to the help for the scanner driver and the image scanning application.

### 1 Load a document in the ADF paper chute (feeder).

For details, refer to [How to Load Documents \(page 85\)](#).

#### ATTENTION

- Long page documents should be loaded one sheet at a time in the ADF paper chute (feeder).
- When you scan long pages, take note of the following:
  - When loading a document  
Hold the document down with your hand so it does not fall out of the ADF paper chute (feeder).



- When the document is ejected

Secure enough space around the stacker and catch the ejected sheet so that it does not fall off the stacker.

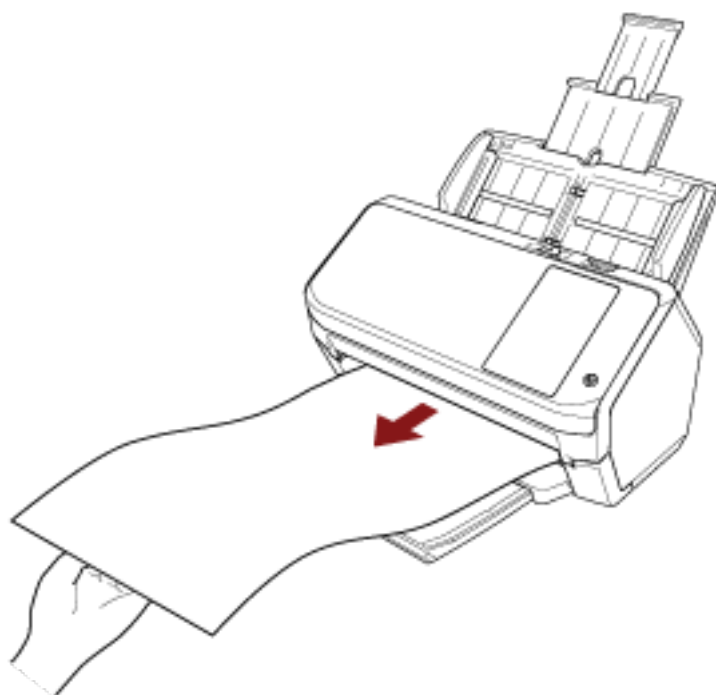
**TIP**

To scan long pages, perform the following:

- Pull out the chute extension.  
For details, refer to [Setting Up the ADF Paper Chute \(Feeder\)](#) (page 69).
- Pull out the stacker extension all the way.  
For details, refer to step 1 in [Document Length Is A6 \(Landscape\) or Longer](#) (page 70).

- 2 In the scanner driver, configure the scan settings to scan the paper size of the long page.**  
For details, refer to the help for the scanner driver.
- 3 Scan documents with the image scanning application.**  
For details, refer to the help for the image scanning application.

## Feeding Documents Manually

Documents can also be loaded manually one sheet at a time in the ADF paper chute (feeder).

The scanner waits for the next document to be loaded within a specified time. Scanning will continue as long as another document is loaded within the set time, and stops if no document is loaded.

By using this method, you can perform scanning as you check the documents one by one.

Manual feeding is effective in the following cases:

- To scan documents as you check the contents of each sheet
- To scan documents that are fed overlapped or jammed when the documents are loaded together in a batch
- To continue scanning documents such as magazines or newspaper clippings that cannot be loaded together, one at a time
- To scan a document folded in half, an envelope, or a multi-layered transfer paper one at a time

### 1 Configure the settings for the scanner.

- When scanning more than one document manually
  - a In the [Manual Feeding] screen on the touch screen, set [Continuous Feed Mode] to on and specify [Timeout seconds].

The [Manual Feeding] screen can be displayed in the following procedure:



→ [Scanner Settings] → [Paper Source/Feeding] → [Manual Feeding]

When using the Software Operation Panel, refer to [Waiting Time in Manual Feeding \[Manual Feeding\] \(page 315\)](#).

- When scanning a document folded in half, an envelope, or a multi-layered transfer paper manually
  - a Slide the feed mode switch to the left to switch the feed mode to Manual Single Mode.
  - b In the [Manual Feeding] screen on the touch screen, specify [Timeout seconds]. The [Continuous Feed Mode] setting is ignored, and the [Timeout seconds] setting is enabled.



→ [Scanner Settings] → [Paper Source/Feeding] → [Manual Feeding]

When using the Software Operation Panel, refer to [Waiting Time in Manual Feeding \[Manual Feeding\] \(page 315\)](#).

#### ATTENTION

For details about the paper weights of the documents that can be scanned, refer to [Documents for Scanning \(page 87\)](#).

When a document folded in half is scanned, the document may be fed skewed if the folded part is too thick.

**2 Load a document in the ADF paper chute (feeder).**

Load the document face-down in the ADF paper chute (feeder).

To scan a multi-layered transfer paper, position the bound edge first when loading the paper.

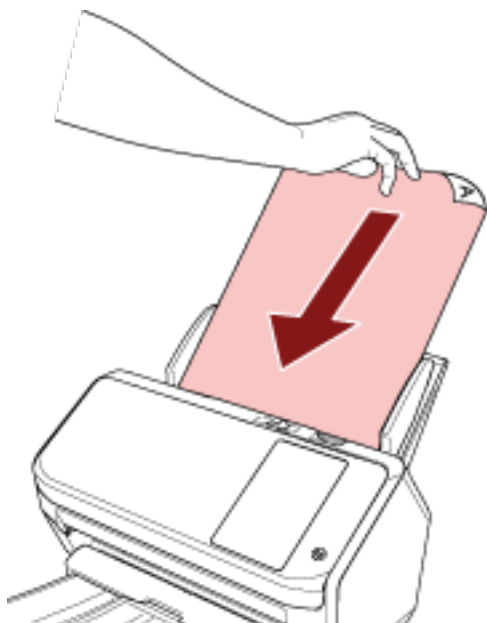
**3 Scan documents with the image scanning application.**

For details, refer to the help for the image scanning application.

After the document is scanned, the rollers inside the ADF keep rotating, waiting for the next document to be loaded until the timeout time specified in the touch screen or Software Operation Panel.

When the Scanner is in Manual Single Mode, it waits for the next document to be loaded without having the rollers inside the ADF rotate.

**4 Load the next document in the ADF paper chute (feeder).****5 Repeat step 4 until all documents are scanned.**

Scanning will stop if no document is loaded in the ADF paper chute (feeder) within the timeout time specified in the touch screen or Software Operation Panel.

**TIP**

- Pressing the [Stop] button on the touch screen while the scanner is waiting for the next document to be loaded will stop the scan immediately.
- The scanner will wait for documents to be loaded until the specified timeout time elapses even if you start scanning with no document in the ADF paper chute (feeder).
- If you use manual feeding frequently, the replacement cycle of the consumables may be shortened.

## Configuring Not to Detect Certain Overlap Patterns

If detecting overlapped documents during a scan is set, when you scan a document with a paper attachment such as a sticky note, receipt, or photo, it is detected as overlapped documents, and the scan may stop. Use the intelligent multifeed detection function not to detect these types of documents.

This function has two modes, a mode that is used to configure the settings manually by a user every time the scanner detects overlapped documents, and a mode that is used to configure the settings automatically by the scanner based on the overlap patterns (length and location) for paper attachments such as sticky notes, receipts, or photos that the scanner has memorized. To use this setting, detecting overlapped documents needs to be set in advance.

- [Multifeed Detection] in the scanner driver  
For details, refer to the help for the scanner driver.
- [Multifeed Detection] on the touch screen or [Multifeed] on the Software Operation Panel  
For details about the settings on the touch screen, refer to [Multifeed Detection \(page 246\)](#).  
For details about the settings on the Software Operation Panel, refer to [Specifying a Method to Detect Overlapped Documents \[Multifeed\] \(page 304\)](#).

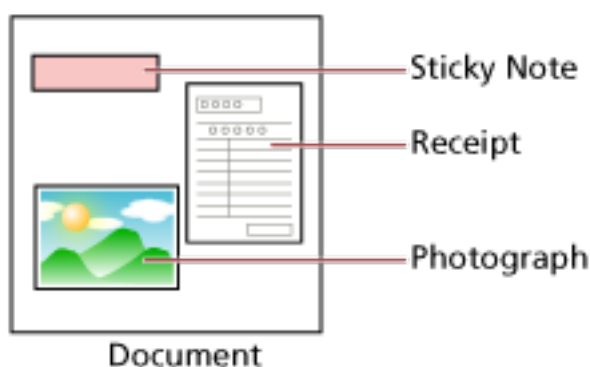

The following three operation modes are available.

Operation mode	Description
Manually Bypass	Specify whether or not to detect overlapped documents every time they are detected.
Automatically Bypass (combination of length and position)	Specify the setting not to automatically detect overlapped documents when the paper attachment is the same length and in the same location as memorized.
Automatically Bypass (length)	Specify the setting not to automatically detect overlapped documents when the paper attachment is the same length or shorter as memorized.

Select an operation mode in the [Intelligent Multifeed Detection] screen on the touch screen. The [Intelligent Multifeed Detection] screen can be displayed in the following procedure.



→ [Scanner Settings] → [Paper Source/Feeding] → [Intelligent Multifeed Detection]

When using the Software Operation Panel, refer to [Setting to Ignore Certain Overlap Patterns \[Intelligent Multifeed Function\]](#) (page 313).

## Operational Procedure

- 1 If [Multifeed detected (Overlap)] (error code: "J2:55") is displayed on the touch screen, either press the [Eject Document] button to eject the document from the paper path or open the ADF to remove the document.

For details, refer to [How to Open the ADF](#) (page 67).



### CAUTION

When the ADF is open, it might close accidentally. Be careful not to get your fingers caught.

- 2 If you open the ADF to remove the document, close it.

For details, refer to [How to Close the ADF](#) (page 68).



### CAUTION

Be careful not to get your fingers caught when closing the ADF.

### ATTENTION

Confirm that the ADF is closed properly. Otherwise, documents may not be fed into the ADF.

- 3 Load the removed document back in the ADF paper chute (feeder).

- 4 Respond to a message that is displayed in the touch screen.

The following settings can be configured depending on the operation mode that is set in the [Intelligent Multifeed Detection] screen.

- For [Manually Bypass]
  - [Disable the multifeed detection for the next document]  
Select whether to detect overlapped documents for the next scan.
  - [Keep Multifeed Images]  
Select whether to save the image when overlapped documents are detected.  
This may not be displayed depending on the scanner driver settings.
- For [Automatically Bypass (combination of length and position)]
  - [Memorize Patterns]  
Select whether you set the scanner to memorize the paper overlapping patterns.
  - [Keep Multifeed Images]  
Select whether to save the image when overlapped documents are detected.  
This may not be displayed depending on the scanner driver settings.

- For [Automatically Bypass (length)]
  - [Memorize Patterns]  
Select whether you set the scanner to memorize the paper overlapping patterns.
  - [Keep Multifeed Images]  
Select whether to save the image when overlapped documents are detected.  
This may not be displayed depending on the scanner driver settings.

With the above procedure complete, the scanner operates as follows depending on the operation mode that is set in the [Intelligent Multifeed Detection] screen.

- For [Manually Bypass]  
The scanner scans the next sheet without detecting overlapped documents, and from the second sheet onwards, detects overlapped documents based on the setting configured in the scanner driver, on the touch screen, or on the Software Operation Panel.
  - For [Automatically Bypass (combination of length and position)]  
The scanner memorizes the length and location of the paper attachment that was detected as overlapped documents, and continues scanning. After that, documents with the same overlap pattern are not detected as overlapped documents (\*1) (\*2).
  - For [Automatically Bypass (length)]  
The scanner memorizes the length of the longest paper attachment that was detected as overlapped documents, and continues scanning. After that, documents with the same overlap pattern or with a shorter overlap pattern are not detected as overlapped documents (\*2).
- \*1:When [When powering off] in [Memorize overlap pattern] is enabled, among the memorized overlap patterns, only the overlap patterns memorized for the last eight sheets will be memorized.
- \*2:The memorized overlap patterns can be erased in the [Intelligent Multifeed Detection] screen on the touch screen, or the Software Operation Panel. You can erase overlap patterns that were not supposed to be memorized, but be careful with this operation because all memorized patterns will be erased.

## Disabling the Paper Protection Function

If you attempt to scan a wrinkled document with the paper protection function set to enabled, the scanner may mistake it as a paper jam even though paper is fed normally, which causes paper protection to be performed and forces a scan to be stopped. In this case, you can disable paper protection only for the protected document to be scanned again.

### Operational Procedure

- 1 When [Paper protection (feeding noise)] (error code: "J0:37") or [Paper protection (feeding accuracy)] (error code: "J0:51") is displayed on the touch screen, open the ADF and remove the document.

For details, refer to [How to Open the ADF \(page 67\)](#).



#### CAUTION

When the ADF is open, it might close accidentally. Be careful not to get your fingers caught.

- 2 Close the ADF.

For details, refer to [How to Close the ADF \(page 68\)](#).



#### CAUTION

Be careful not to get your fingers caught when closing the ADF.

#### ATTENTION

Confirm that the ADF is closed properly. Otherwise, documents may not be fed into the ADF.

- 3 Load the removed document back in the ADF paper chute (feeder).
- 4 Respond to a message that is displayed in the touch screen.  
The following setting can be configured.

#### Disable the paper protection for the next document

Select whether to disable the paper protection to scan the protected document again.

- 5 Press the [Scan] button.

Starts scanning documents.

The paper protection function is disabled for the first sheet of documents. From the second sheet onwards, the paper protection function is enabled.

#### TIP

If errors to protect documents are frequently displayed on the touch screen, refer to [Paper Protection Is Set Off Frequently \(page 218\)](#).

---

## Counting the Number of Documents

The number of documents can be counted without outputting images of the documents. This operation is useful for checking the number of documents when you scan a large number of documents.

**1 Turn on the scanner.**

For details, refer to [How to Turn the Power ON \(page 60\)](#).

**2 Check that the feed mode switch is positioned to the right.**

The number cannot be counted when the feed mode switch is in Manual Single Mode.

**3 On the touch screen, press  → [Paper Source/Feeding] → [Document Count].**

The [Document Count] screen is displayed.

**4 Load documents in the ADF paper chute (feeder).**

For details, refer to [How to Load Documents \(page 85\)](#).

**5 Press the [Start] button on the touch screen.**

The number of documents that are loaded in the scanner is counted.

The number of documents is displayed in the [Document Count] screen.

**ATTENTION**

Documents may not be counted correctly if overlapped documents are fed.



# Daily Care

This section describes how to clean the scanner.



- Do not use aerosol spray or spray that contains alcohol. Paper dust blown up by strong air from the spray may enter inside the scanner which may cause the scanner to fail or malfunction.  
Also note that sparks generated by static electricity may cause a fire.
- The inside of the ADF becomes very hot when the scanner is being used. Before you start cleaning the inside of the ADF, make sure to turn off the power, unplug the power cable and wait for at least 15 minutes for the inside of the ADF to cool down.

## Cleaning Materials

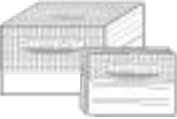
Name	Part No.	Notes
Cleaner F1 	PA03950-0352	100 ml Liquid cleaner to use for removing dirt and stains
Cleaning Paper 	CA99501-0012	10 sheets Used to clean the inside of the scanner with ease. Spray it with Cleaner F1 and scan it with the scanner in the same way as a document.
Cleaning Wipe 	PA03950-0419	24 packets Pre-moistened with Cleaner F1. It can be used instead of moistening a cloth with Cleaner F1.
Cotton swab	Commercially available	Used to clean a tiny part such as the ultrasonic sensor.
Dry cloth		Used to wipe off dirt and stains. Moisten it with Cleaner F1 for cleaning.

**ATTENTION**

In order to use the cleaning materials safely and correctly, read the precautions on each product thoroughly.

For more information about the cleaning materials, contact the distributor/dealer where you purchased this product. Refer to the contact information in the Contact List if supplied with this product, or refer to the contact information in the Contact for Inquiries section if provided in Safety Precautions supplied with this product, and then make an inquiry.

## Location and Frequency

Location		Frequency
Inside of the scanner (ADF)	Brake roller	Every 5,000 sheets
	Pick roller	
	Plastic idler roller	
	Glass	
	Ultrasonic sensor	
	Document sensor	
	Feed roller	
	Eject roller	
Outside of the scanner	Scanner	Clean when dust and dirt are noticeable.
	Touch screen	

The inside of the scanner (ADF) needs to be cleaned regularly for every certain number of sheets scanned. The scanner records the number of sheets scanned so that you can check the number of sheets scanned after you cleaned it last.

The procedure to check the number of sheets scanned is as follows.

- 1 On the touch screen, press  → [Cleaning & Maintenance] → [Consumable counters].
- 2 On the [Consumable counters] screen, check the value for [After cleaning].
  - When the background color of the counter is yellow  
It is about time to clean the scanner.
  - When the background color of the counter is red  
It is time to clean the scanner. Clean the scanner.

To use the Software Operation Panel in order to check the value, refer to [Settings Related to Sheet Counters \(page 280\)](#).

### ATTENTION

Cleaning cycles may vary depending on the condition of the documents. Also, cleaning must be performed more frequently when the following types of documents are scanned:

- Smooth-faced documents such as coated paper
- Documents with printed text/graphics that almost cover the entire surface
- Chemically-treated documents such as carbonless paper
- Documents containing a large amount of calcium carbonate
- Documents written in lead pencil

- Documents on which the toner is not sufficiently fused

## Cleaning the Outside of the Scanner

### ● Scanner

The scanner including the ADF paper chute (feeder) and the stacker should be cleaned with either a piece of dry cloth, a cloth moistened with Cleaner F1/mild detergent, or a sheet of Cleaning Wipe.

#### ATTENTION

- To avoid deformation and discoloration, never use paint thinner or any other organic solvents.
- Be careful not to let any moisture or water inside the scanner during cleaning.
- It may take a long time to dry if an excessive amount of Cleaner F1/mild detergent is used. Use only a small amount. Wipe off the cleaner completely to leave no residue on the cleaned parts.

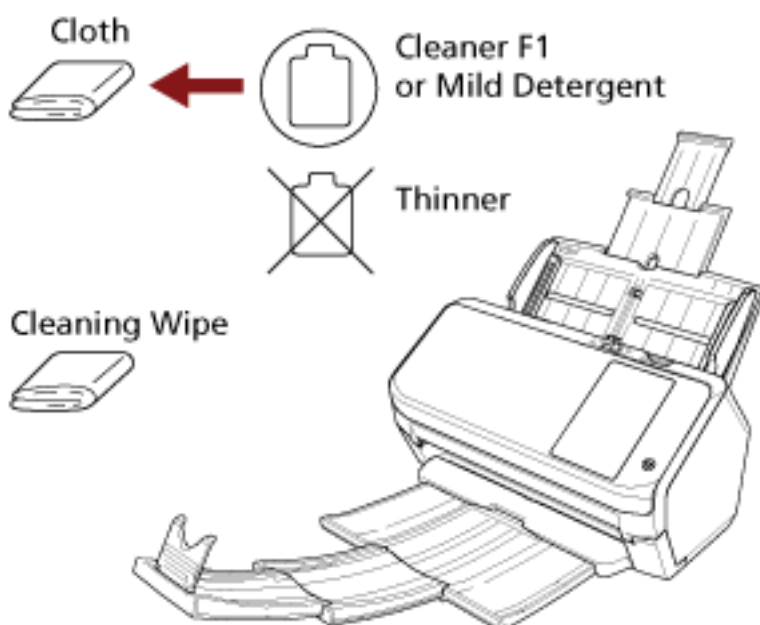

### ● Touch screen

To avoid the surface of the touch screen becoming dirty, clean it regularly by gently wiping dirt and dust off with a soft, dry cloth.

Clean the touch screen with care. Do not rub or tap the surface with hard objects as doing so may damage the surface.

#### ATTENTION

Do not wipe the touch screen with a damp cloth.

Dust on the surface may become stuck between the touch screen and the scanner, causing the touch screen to malfunction.

## Cleaning the Inside of the Scanner (ADF) with Cleaning Paper

The inside of the ADF can be cleaned with a sheet of Cleaning Paper moistened with Cleaner F1. As the scanner continues to feed the documents, paper dust will accumulate inside the ADF and it may cause scanning errors. Cleaning should be performed approximately every 5,000 sheets scanned. Note that this guideline varies depending on the types of documents you scan. For instance, it may be necessary to clean the scanner more frequently when you scan documents on which the toner is not sufficiently fused.

### ATTENTION

- Do not use water or mild detergent to clean the ADF.
- It may take a long time to dry if an excessive amount of Cleaner F1 is used. Use only a small amount.

#### 1 Turn on the scanner.

For details, refer to [How to Turn the Power ON \(page 60\)](#).

#### 2 On the touch screen, press → [Cleaning & Maintenance] → [Cleaning] → [Cleaning Paper].

The [Cleaning Paper] screen is displayed.

### ATTENTION

Do not start scanning with an image scanning application during cleaning.

#### 3 Spray the Cleaning Paper with Cleaner F1.

#### 4 Pull out the chute extension according to the length of the Cleaning Paper.

For details, refer to [Setting Up the ADF Paper Chute \(Feeder\) \(page 69\)](#).

#### 5 Adjust the stacker according to the length of the Cleaning Paper.

For details, refer to [Document Length Is A6 \(Landscape\) or Longer \(page 70\)](#).

**6 Load the Cleaning Paper in the ADF paper chute (feeder).**

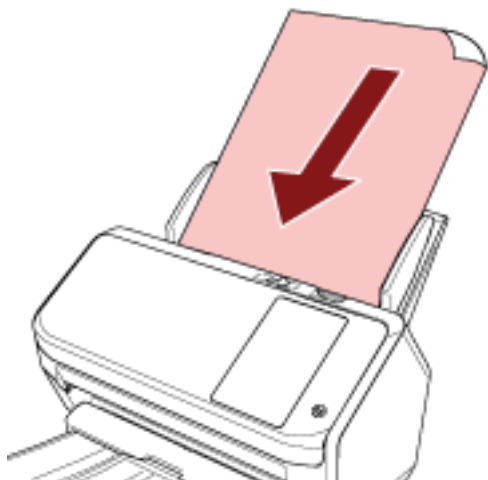

**7 Adjust the side guides to the width of the Cleaning Paper.**

Move the side guides so that there is no space between the side guides and the Cleaning Paper. Otherwise, the Cleaning Paper may be fed skewed.

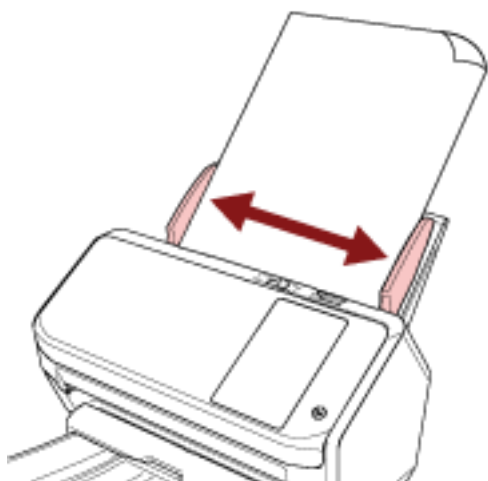

**8 On the touch screen, press the [Start] button on the [Cleaning Paper] screen.**

The Cleaning Paper is fed and ejected onto the stacker.

**9 Clear the sheet counter after cleaning.**

a On the touch screen, press  → [Cleaning & Maintenance] → [Consumable counters].

b On the [Consumable counters] screen, press the [Clear] button for [After cleaning].

When using the Software Operation Panel, refer to [Clearing the Sheet Counters \(page 282\)](#).

## Cleaning the Inside of the Scanner (ADF) with a Cloth

The inside of the ADF can be cleaned with a piece of cloth moistened with Cleaner F1, or a sheet of Cleaning Wipe.

As the scanner continues to feed the documents, paper dust will accumulate inside the ADF and it may cause scanning errors. Cleaning should be performed approximately every 5,000 sheets scanned. Note that this guideline varies depending on the types of documents you scan. For instance, it may be necessary to clean the scanner more frequently when you scan documents on which the toner is not sufficiently fused.

**CAUTION**

The inside of the ADF becomes very hot when the scanner is being used. Before you start cleaning the inside of the ADF, make sure to turn off the power, unplug the power cable and wait for at least 15 minutes for the inside of the ADF to cool down.

**ATTENTION**

- Do not use water or mild detergent to clean the ADF.
- It may take a long time to dry if an excessive amount of Cleaner F1 is used. Use only a small amount. Wipe off the cleaner completely to leave no residue on the cleaned parts.

**1 Turn off the scanner, unplug the power cable and wait for at least 15 minutes.**

For details, refer to [How to Turn the Power OFF \(page 61\)](#).

**2 Open the ADF.**

For details, refer to [How to Open the ADF \(page 67\)](#).

**CAUTION**

When the ADF is open, it might close accidentally. Be careful not to get your fingers caught.

- 3 Clean the following locations with a cloth moistened with Cleaner F1, or a sheet of Cleaning Wipe.

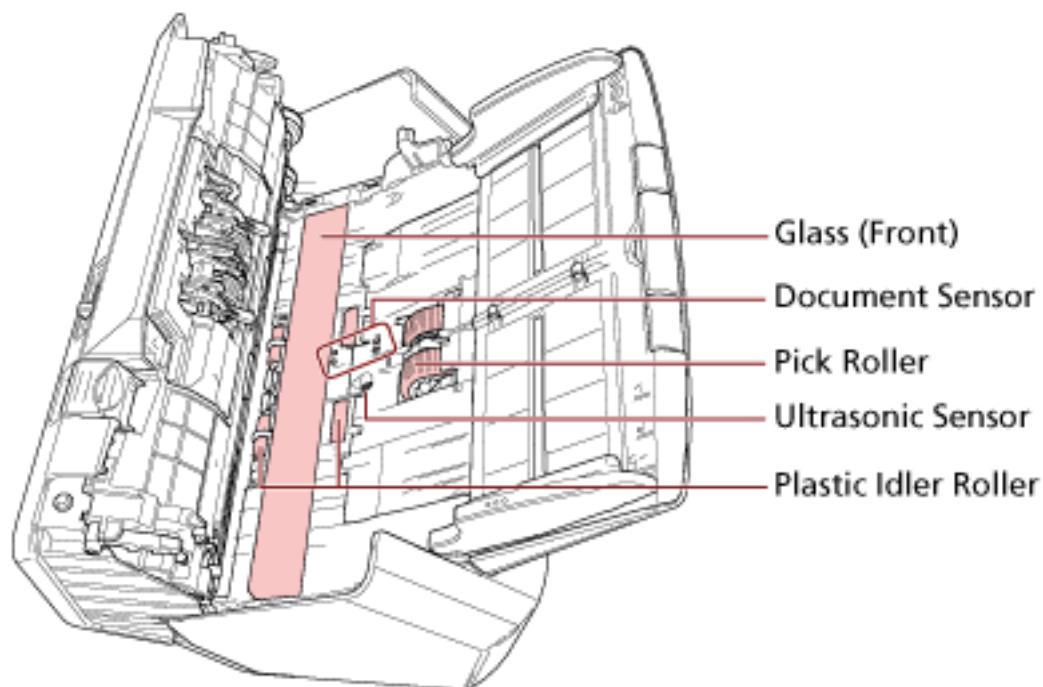
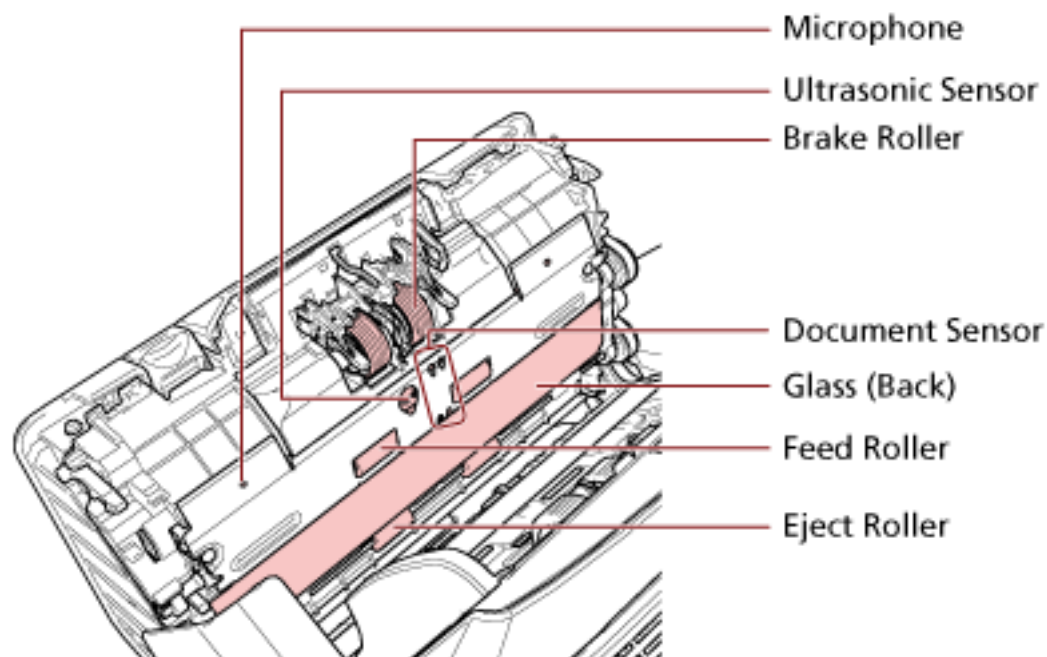

#### Brake Roller (× 2)

Remove the brake roller from the scanner.

For details about removing the brake roller, refer to [Replacing the Brake Roller \(page 135\)](#).

Gently wipe off any dirt or dust along the grooves, taking care not to damage the roller surface.

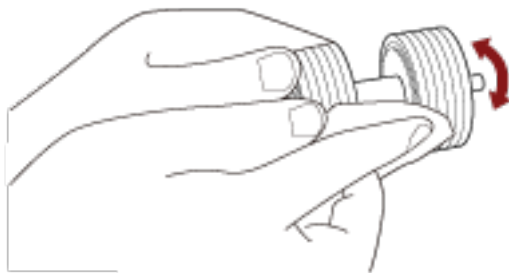

#### Pick Roller (× 2)

Gently wipe off any dirt or dust along the grooves as you rotate the roller manually, taking care not to damage the roller surface. Make sure that it is wiped properly because black residue on the rollers will affect the feeding performance.

#### Plastic Idler Roller (× 4)

Gently wipe dirt and dust off the roller, taking care not to damage the roller surface. Make sure that it is wiped properly because black residue on the rollers will affect the feeding performance.

Be careful not to damage the sponge that is attached to the plastic idler roller.

#### Glass (× 2)

Gently wipe dirt and dust off the glass sections.

#### ATTENTION

- Vertical streaks may appear on images if the glass section is dirty.
- When you receive a [Clean glass!] message from  on the touch screen, check which glass section is dirty and clean it. When a [Clean glass!] message shows that the glass section is dirty only on the one side, the message may not disappear even if you clean it. In that case, clean both glass sections.

#### Ultrasonic Sensor (× 2)/Document Sensor (× 8)

Gently wipe dirt and dust off the surface of the ultrasonic and document sensors.

**TIP**

If it is difficult to clean, use a cotton swab.

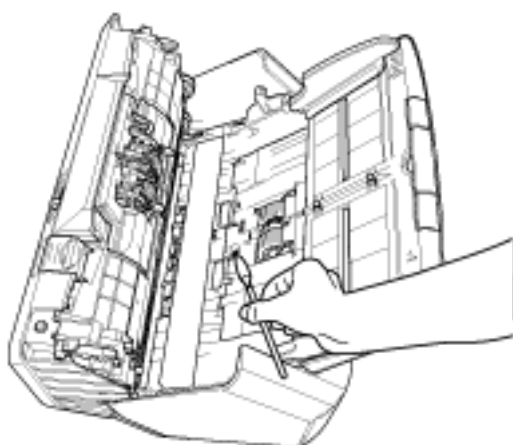
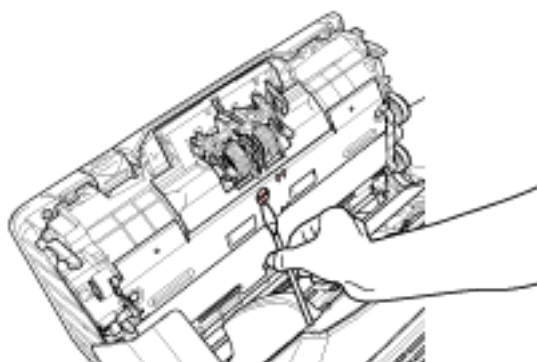
**Feed Roller (× 2)/Eject Roller (× 2)**

The power must be turned on to rotate the feed/eject rollers for cleaning.

- a Plug in the power cable and turn on the scanner.  
For details, refer to [How to Turn the Power ON \(page 60\)](#).
- b On the touch screen, press  → [Cleaning & Maintenance] → [Cleaning] → [Cleaning Wipe].  
The [Cleaning Wipe] screen is displayed.

**ATTENTION**

Do not start scanning with an image scanning application during cleaning.

- c Open the ADF.  
For details, refer to [How to Open the ADF \(page 67\)](#).



**CAUTION** When the ADF is open, it might close accidentally. Be careful not to get your fingers caught.

- d** On the touch screen, press the [Start] button on the [Cleaning Wipe] screen. The feed/eject rollers rotate a certain amount simultaneously. If you press and hold the [Start] button, the feed/eject rollers rotate continuously.



**CAUTION** Be careful not to touch the rollers with your hand while they are rotating.

- e** Put a piece of cloth moistened with Cleaner F1 or a sheet of Cleaning Wipe against the surface of the rotating feed/eject roller, and wipe horizontally to clean dirt and dust off the whole surface. Make sure that it is wiped properly because black residue on the rollers will affect the feeding performance.

#### 4 Close the ADF.

For details, refer to [How to Close the ADF \(page 68\)](#).



**CAUTION** Be careful not to get your fingers caught when closing the ADF.

#### ATTENTION

Confirm that the ADF is closed properly. Otherwise, documents may not be fed into the ADF.

#### 5 Clear the sheet counter after cleaning.



- a** On the touch screen, press  → [Cleaning & Maintenance] → [Consumable counters].
- b** On the [Consumable counters] screen, press the [Clear] button for [After cleaning].

When using the Software Operation Panel, refer to [Clearing the Sheet Counters \(page 282\)](#).

---

## Cleaning the Carrier Sheet

The Carrier Sheet should be cleaned with either a piece of dry cloth, a cloth moistened with Cleaner F1/mild detergent, or a sheet of Cleaning Wipe.

Gently wipe dirt and dust off the surface and the inside of the Carrier Sheet.

As you keep using the Carrier Sheet, dirt and dust will accumulate on the surface and the inside. Clean it regularly because it may result in scanning errors.

### ATTENTION

- Make sure that the Carrier Sheet is not creased.
- To avoid deformation and discoloration, never use paint thinner or any other organic solvents.
- Do not use force to rub against the Carrier Sheet because it may be damaged or deformed.
- After cleaning the inside of the Carrier Sheet with a cloth moistened with Cleaner F1/mild detergent or a sheet of Cleaning Wipe, do not close the Carrier Sheet until it is completely dry.
- The Carrier Sheet should be replaced approximately every 500 scans.

For information on purchasing the Carrier Sheets, contact the distributor/dealer where you purchased this product. Refer to the contact information in the Contact List if supplied with this product, or refer to the contact information in the Contact for Inquiries section if provided in Safety Precautions supplied with this product, and then make an inquiry.

# Replacing the Consumables

This section explains how to replace the consumables for the scanner.



## CAUTION

The inside of the ADF becomes very hot when the scanner is being used. Before you replace the consumables, make sure to turn off the power, unplug the power cable and wait for at least 15 minutes for the inside of the ADF to cool down.

## Consumables and Replacement Cycles

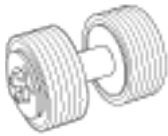
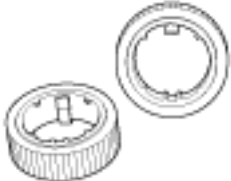
Name	Part No.	Suggested Replacement Cycle
 BRAKE ROLLER	PA03670-0001	Every 200,000 sheets
 PICK ROLLER	PA03670-0002 PA03670-0022 (*1)	Every 200,000 sheets

\*1:Applicable to scanners with the part number "PA03768-B005".

The scanner's part number can be found next to "PART NO." on the label on the back of the scanner.

For details, refer to [Checking the Product Label \(page 231\)](#).

Consumables need to be replaced periodically. It is recommended that you keep a stock of new consumables and replace them before it reaches the end of the consumable life. Also, the scanner records the number of sheets scanned for each consumable (brake roller and pick roller), which allows you to determine when to replace the consumables.

The procedure to check the number of sheets scanned is as follows.

- 1 On the touch screen, press  → [Cleaning & Maintenance] → [Consumable counters].
- 2 On the [Consumable counters] screen, check the [After Replacing the Brake Roller] and [After Replacing the Pick Roller] counters.
  - When the background color of the counter is yellow

It is about time to replace the brake roller or pick roller.

- When the background color of the counter is red

It is time to replace the brake roller or pick roller. Replace the brake roller or pick roller.

To use the Software Operation Panel in order to check the value, refer to [Settings Related to Sheet Counters \(page 280\)](#).

Note that the suggested replacement cycles are guidelines for using A4 (80 g/m<sup>2</sup> [20 lb]) wood-free or wood-containing paper, as these cycles vary depending on the type of documents scanned, how often the scanner is used and cleaned, and your operating environment.

**TIP**

Only use the specified consumables.

For information on purchasing the consumables, contact the distributor/dealer where you purchased this product. Refer to the contact information in the Contact List if supplied with this product, or refer to the contact information in the Contact for Inquiries section if provided in Safety Precautions supplied with this product, and then make an inquiry.

## Replacing the Brake Roller

Replace the brake roller in following procedure.

- 1 Turn off the scanner, unplug the power cable and wait for at least 15 minutes.**  
For details, refer to [How to Turn the Power OFF \(page 61\)](#).
- 2 Remove all documents from the ADF paper chute (feeder).**
- 3 Open the ADF.**  
For details, refer to [How to Open the ADF \(page 67\)](#).



### CAUTION

When the ADF is open, it might close accidentally. Be careful not to get your fingers caught.

- 4 Remove the brake roller.**
  - a Hold both ends of the cover, and open it in the direction of the arrow.**

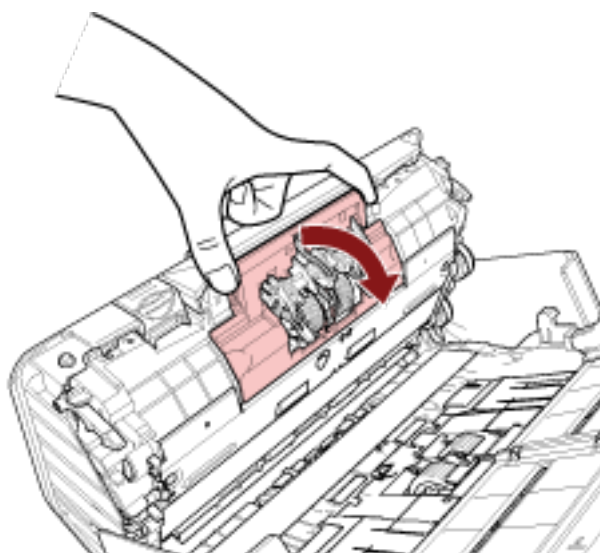

**b** Lift the right side of the roller first, then pull out the shaft from the slot on the left.

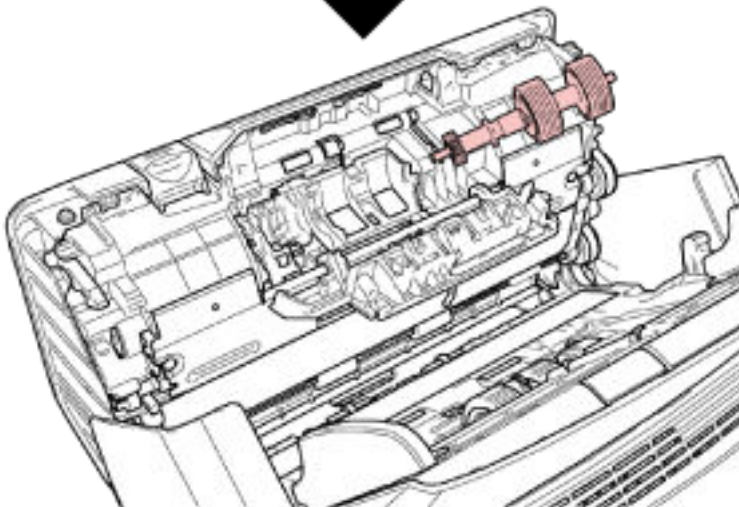
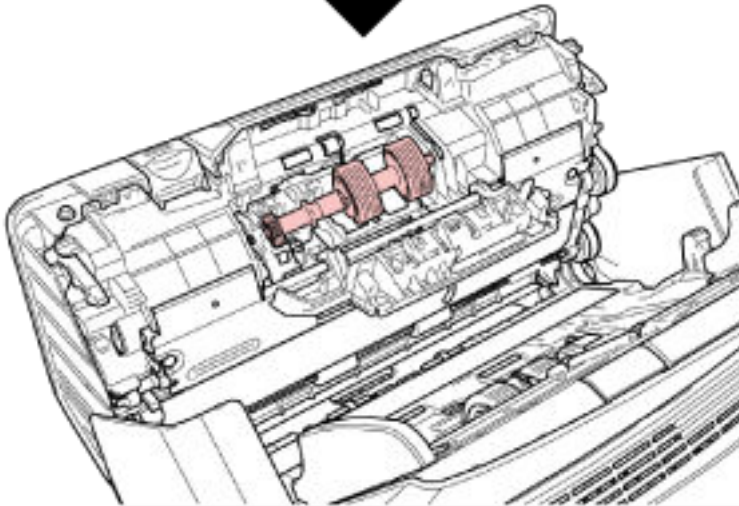
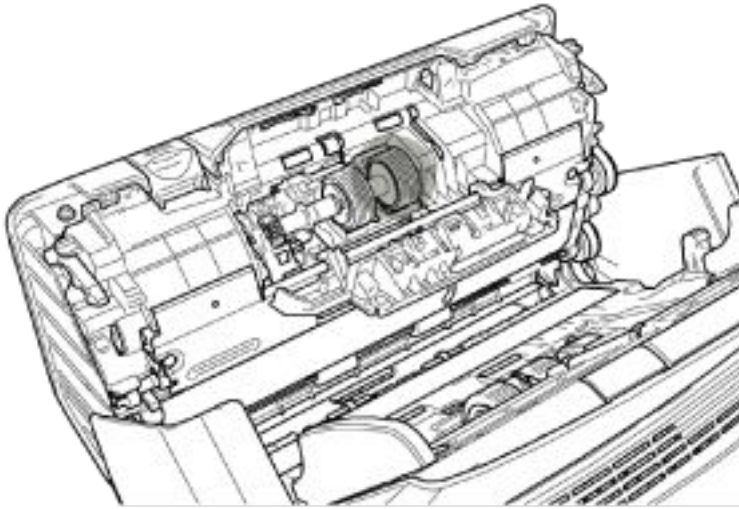

**5 Remove the brake roller from its shaft.**

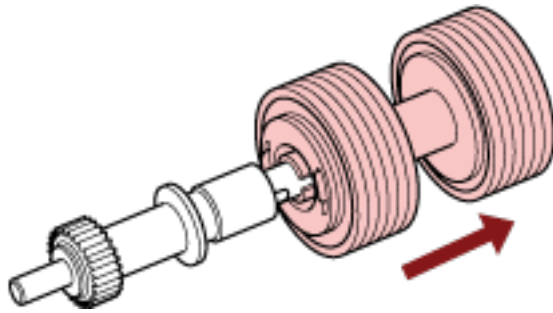

**6 Attach a new brake roller on the shaft.**  
Insert the protrusion on the shaft into the slot.

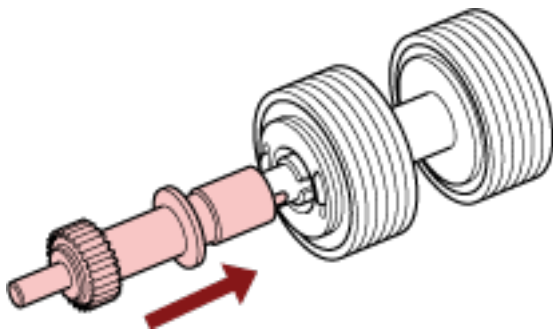

**7 Attach the shaft.**

- a Insert the left end of the shaft into the hole in accordance with the hole shape, and then attach the right side of the shaft.

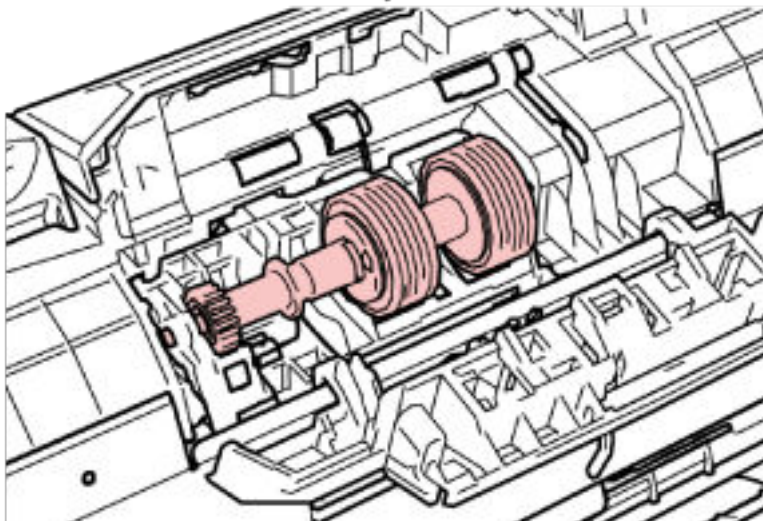
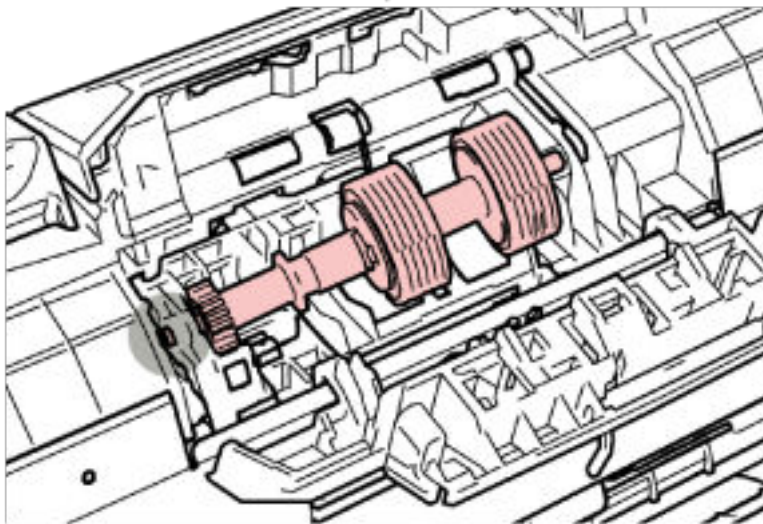
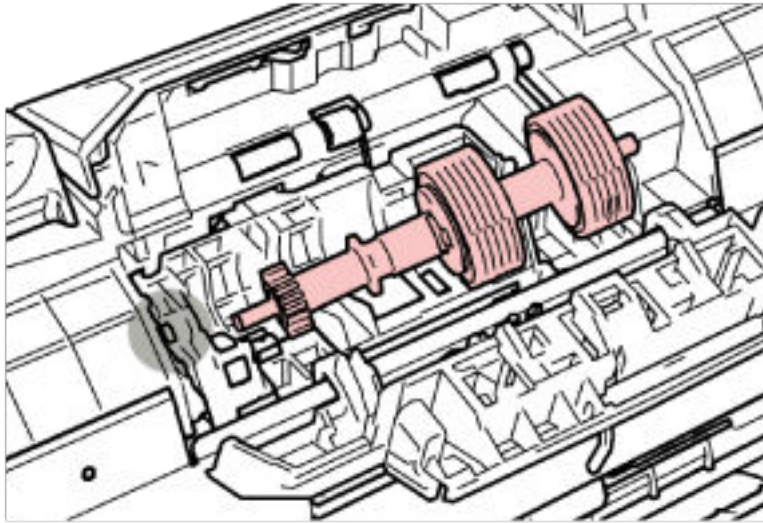

**b Close the brake roller cover.****ATTENTION**

Confirm that the brake roller is installed properly. Otherwise, paper jams or other feeding errors may occur.

**8 Close the ADF.**

For details, refer to [How to Close the ADF \(page 68\)](#).

**CAUTION**

Be careful not to get your fingers caught when closing the ADF.

**9 Plug in the power cable and turn on the scanner.**

For details, refer to [How to Turn the Power ON \(page 60\)](#).

**10 Clear the brake roller counter.**

**a** On the touch screen, press  → [Cleaning & Maintenance] → [Consumable counters].

**b** On the [Consumable counters] screen, press the [Clear] button for [After Replacing the Brake Roller].

To clear the counter in the Software Operation Panel, refer to [Clearing the Sheet Counters \(page 282\)](#).

## Replacing the Pick Roller

Replace the pick roller in following procedure.

- 1 Turn off the scanner, unplug the power cable and wait for at least 15 minutes.**

For details, refer to [How to Turn the Power OFF \(page 61\)](#).

- 2 Remove all documents from the ADF paper chute (feeder).**

- 3 Remove the ADF paper chute (feeder).**

Hold both ends of the ADF paper chute (feeder), then lift it in the direction of arrow 1 and pull it out in the direction of arrow 2.

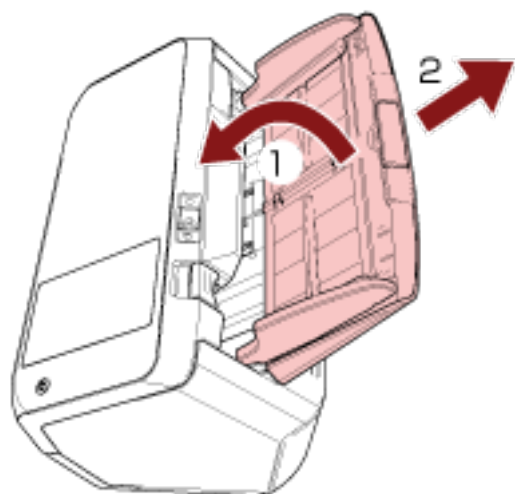

- 4 Open the ADF.**

For details, refer to [How to Open the ADF \(page 67\)](#).



### CAUTION

When the ADF is open, it might close accidentally. Be careful not to get your fingers caught.

- 5 Remove the pick roller.**

**a** Open the sheet guide by lifting the tab.

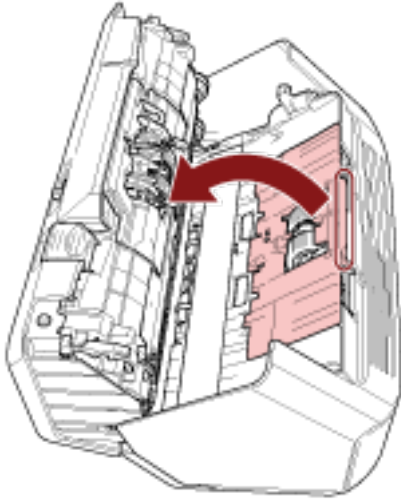

**b** Rotate the bushing on the shaft in the direction of the arrow.

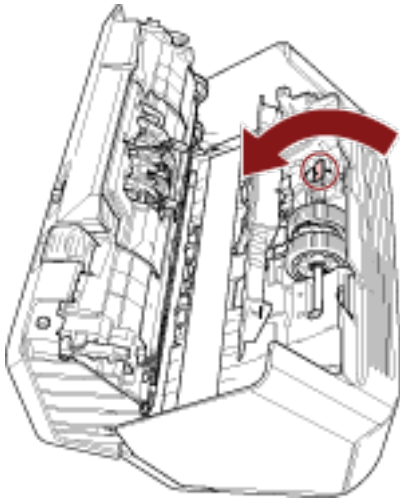

- c Hold the bushing on the shaft to lift up the shaft end, pull the other shaft end out of the slot, and then lift up the pick roller to remove it.

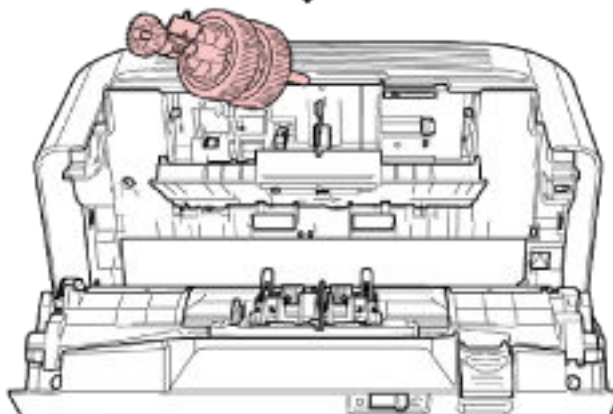
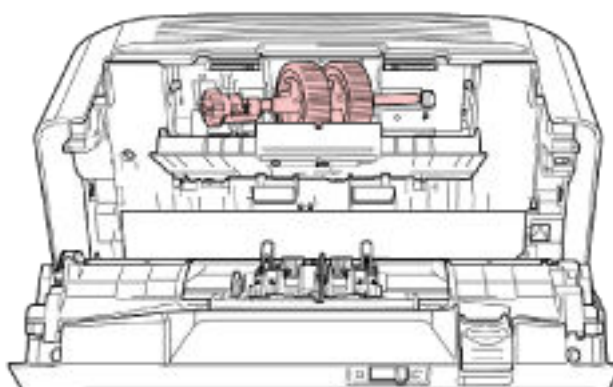
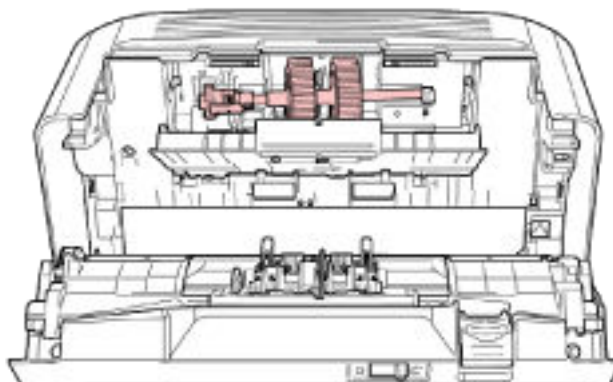
**ATTENTION**

Be careful not to touch the gear near the bushing on the shaft because it has grease over it.

**6 Remove the pick rollers (× 2) one by one from the shaft.**

- a Pull out the pick roller from the shaft as you lift the retaining clip.**

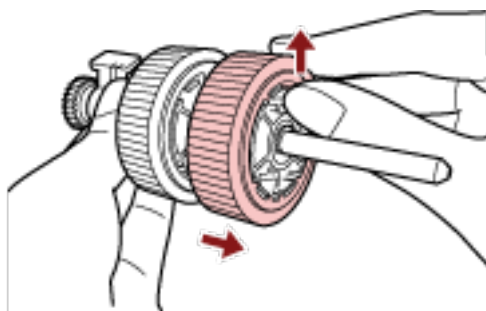

- b Pull out the other pick roller from the shaft as you lift the retaining clip.**

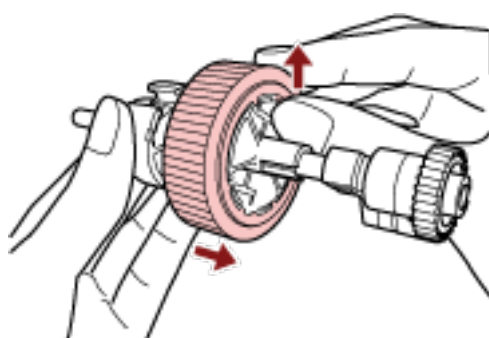

**7 Attach new pick rollers (× 2) on the shaft one by one.**

- a Insert the retaining clip of the pick roller into the slot.**

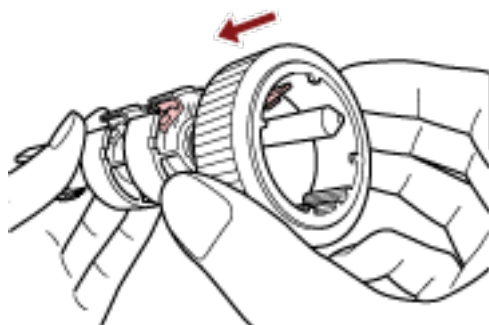

- b Insert the retaining clip of the other pick roller into the slot.**

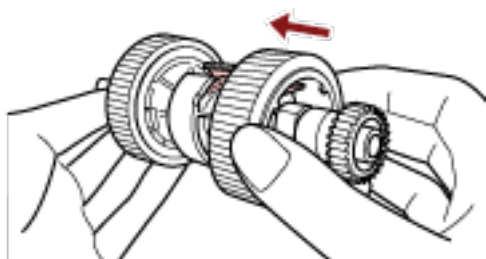

**ATTENTION**

Confirm that the pick rollers are attached properly. Otherwise, paper jams or other feeding errors may occur.

Make sure you insert the pick rollers until they lock in place.

**8 Attach the shaft.**

- a Hold the bushing on the shaft and insert the other shaft end into the slot on the right diagonally from the upper left. Lower the shaft end with the bushing to fit the entire shaft in and rotate the bushing backward until the shaft locks in place.

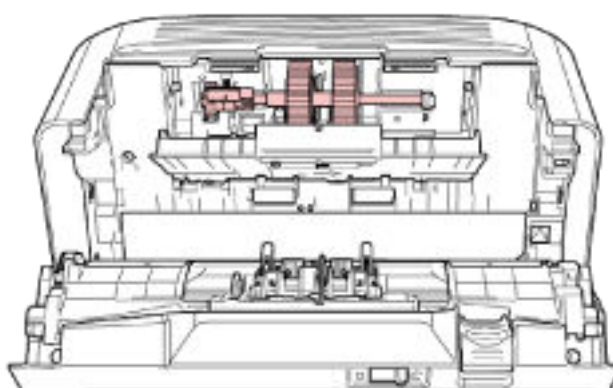
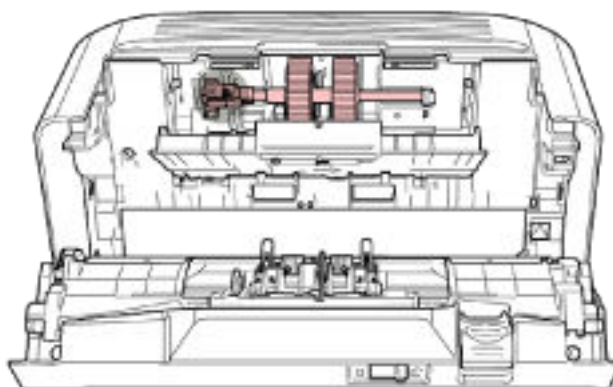
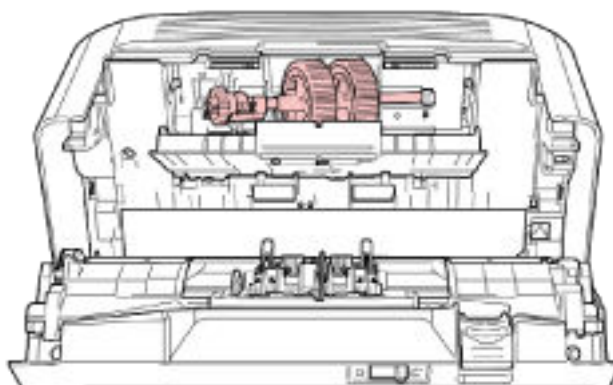

- b Close the sheet guide. Make sure that both ends of the sheet guide are locked firmly.

**ATTENTION**

Confirm that the pick rollers are installed properly. Otherwise, paper jams or other feeding errors may occur.

**9 Close the ADF.**

For details, refer to [How to Close the ADF \(page 68\)](#).

**CAUTION**

Be careful not to get your fingers caught when closing the ADF.

**10 Attach the ADF paper chute (feeder).**

Insert the tabs into the slots on the back of the scanner in the direction of arrow 1 and tilt the ADF paper chute (feeder) downwards in the direction of arrow 2 until it locks in place. Attach the ADF paper chute (feeder) with the side guides facing upwards.

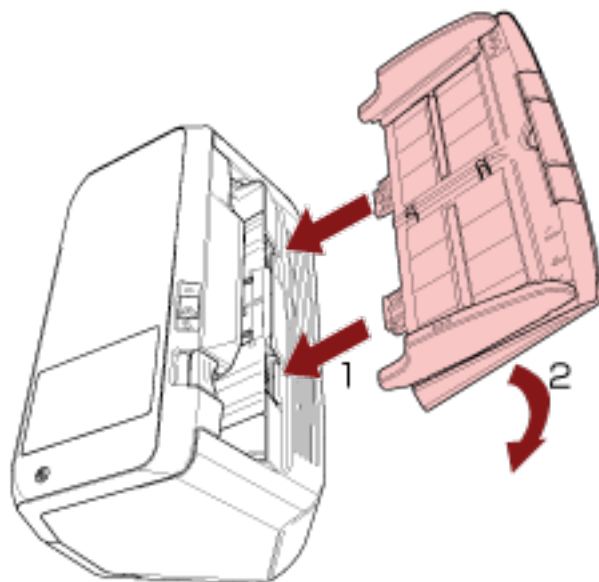
**ATTENTION**

Do not leave any space between the ADF paper chute (feeder) and the scanner.

**11 Plug in the power cable and turn on the scanner.**

For details, refer to [How to Turn the Power ON \(page 60\)](#).

**12 Clear the pick roller counter.**

- a On the touch screen, press  → [Cleaning & Maintenance] → [Consumable counters].
- b On the [Consumable counters] screen, press the [Clear] button for [After Replacing the Pick Roller].

To clear the counter in the Software Operation Panel, refer to [Clearing the Sheet Counters \(page 282\)](#).

# Troubleshooting

This section explains about the countermeasures against paper jams and other troubles, items to check before contacting your scanner service provider, and how to read the product label on the scanner.

## ATTENTION

For details about other errors/troubles that are not covered in this section, refer to the scanner driver's Help.

## When a Paper Jam Occurs

Remove the documents that are left in the ADF in the following procedure:



### CAUTION

- Do not use force to pull out jammed documents, and make sure to open the ADF first.
- Be careful not to touch any sharp parts upon removing jammed documents.
- Be careful not to get things such as hair, a tie or necklaces caught inside the scanner when removing jammed documents.
- The inside of the ADF may become extremely hot during operation. Be careful not to burn yourself.

**1 Remove all documents from the ADF paper chute (feeder).**

**2 Open the ADF.**

For details, refer to [How to Open the ADF \(page 67\)](#).



### CAUTION

When the ADF is open, it might close accidentally. Be careful not to get your fingers caught.

**3 Remove the jammed document.**

## ATTENTION

- Make sure to check the documents and the paper path thoroughly. Remove any metal objects such as staples or paper clips to prevent paper jams.
- Be careful not to damage the glass surface and the guides when removing documents with metal objects such as staples or paper clips.

**4 Close the ADF.**

For details, refer to [How to Close the ADF \(page 68\)](#).

**CAUTION**

Be careful not to get your fingers caught when closing the ADF.

**ATTENTION**

- Confirm that the ADF is closed properly. Otherwise, documents may not be fed into the ADF.
- Occasionally when scanning is complete or canceled, documents may remain in the ADF without any error message displayed. In that case, follow steps [1](#) through [4](#) above to remove the documents.
- To continue scanning, check which page you want to resume from, and load the document in the ADF paper chute (feeder) again.

## Errors

- [Error] Screen

When an error occurs on the scanner, the [Error] screen is displayed on the touch screen.

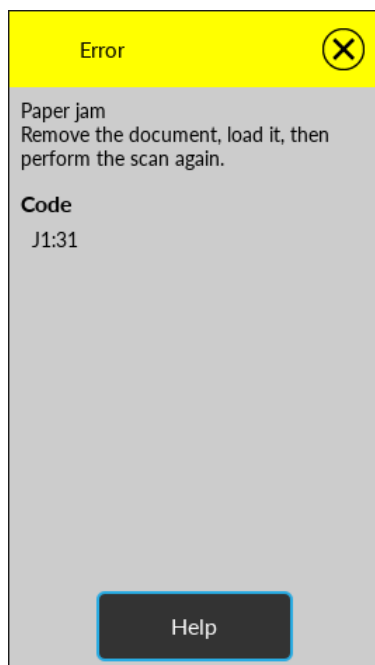

Check the solution for the error, press , and then close the [Error] screen.

### TIP

If the computer has Error Recovery Guide installed, Error Recovery Guide is started up when you logged onto Windows.

When an error occurs on the scanner, the error name and code number is displayed in the Error Recovery Guide window.

Take note of the displayed information and click the [More Info] button to check the troubleshooting procedure.

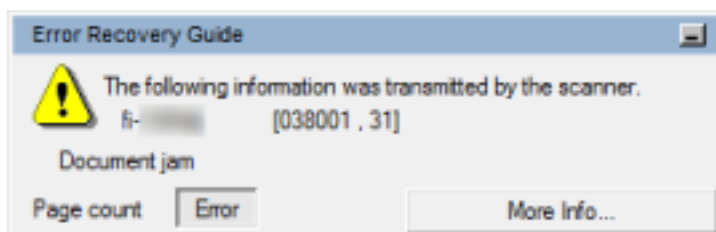

- Code List

Code	Error Description	Refer to
C0:E5	Memory error (Front)	<a href="#">Memory Error (page 160)</a>
C0:E6	Memory error (Back)	
C0:E9	LSI error (Front)	
C0:EA	LSI error (Back)	
E2:74	Optical error (ADF Front)	<a href="#">Optical Error (page 157)</a>
E3:75	Optical error (ADF Back)	
E6:D3	Operator Panel error	<a href="#">Operator Panel error (page 157)</a>
E7:D2	EEPROM error	<a href="#">EEPROM Error (page 157)</a>
E9:F5	Image memory read-write error (Front)	<a href="#">Image Memory Read-Write Error (page 158)</a>
E9:F6	Image memory read-write error (Back)	
F4:C2	Background switching mechanism error (ADF Front)	<a href="#">Background Switching Mechanism Error (page 159)</a>
F4:C3	Background switching mechanism error (ADF Back)	
H0:84	Motor circuit error	<a href="#">Motor Circuit Error (page 161)</a>
H1:80		
H2:81		
H7:84	Lamp circuit error	<a href="#">Lamp Circuit Error (page 161)</a>
H8:88	Motor circuit error	<a href="#">Motor Circuit Error (page 161)</a>
J0:37	Paper protection (feeding noise)	<a href="#">Paper Protection (page 153)</a>
J0:51	Paper protection (feeding accuracy)	
J1:31	Paper jam	<a href="#">Paper Jam (page 153)</a>
J1:50	Pick error	
J2:55	Multifeed detected (Overlap)	<a href="#">Multifeed (page 154)</a>
J2:56	Multifeed detected (Length)	
J7:5F	Feed mode switched	<a href="#">Feed Mode Switched (page 154)</a>
J8:01	Sensor(s) dirty	<a href="#">Sensor(s) dirty (page 154)</a>
J8:04		
L0:11	Sensor error	<a href="#">Sensor Error (page 162)</a>
L2:13		

Code	Error Description	Refer to		
L6:1B				
M0:D4	Wi-Fi error	<a href="#">Module Error (page 163)</a>		
M1:D5	Wired LAN error			
M2:D6	Contactless smart card reader error			
M4:A2	Network setting error	<a href="#">Network Setting Error (page 163)</a>		
M4:A3				
M4:A4				
M4:A5				
M4:A6				
M4:A7				
M4:A8				
M4:A9				
M4:AA				
M4:AB				
M4:AD				
M4:AA			Scanner Central Admin Server setting error	<a href="#">Scanner Central Admin Server Setting Error (page 165)</a>
M4:AC				
M5:A3				
M5:A4				
M5:A5				
M4:AA	Server setting error	<a href="#">Server Setting Error (page 164)</a>		
M5:A2				
M5:AC				
M5:AE				
M6:AF	Authentication failed	<a href="#">Authentication Failed (page 165)</a>		
U4:40	ADF open	<a href="#">Cover Open (page 156)</a>		

## Paper Feeding Error

### Paper Protection

When the function to protect documents (Paper protection) is activated, paper feeding stops, and the [Error] screen on the touch screen displays one of the following codes.

J0:37	Paper protection (feeding noise) Remove the document and check it. Load it carefully so that it does not get skewed and perform the scan again.
J0:51	Paper protection (feeding accuracy) Remove the document and check it. Load it carefully so that it does not get skewed and perform the scan again.

The function to protect documents (Paper protection) prevents documents from being damaged during scanning with the ADF by increasing the level of sensitivity to detect paper jams. Take the following measures.

- If this error occurs, check if the document meets the requirements described in [Documents for Scanning \(page 87\)](#).
- If this error occurs frequently even when the document meets the requirements for scanning, lower the paper protection sensitivity level.
- If documents remain in the ADF, remove the documents by referring to [When a Paper Jam Occurs \(page 148\)](#).

### Paper Jam

When a paper jam occurs, the [Error] screen on the touch screen displays one of the following codes.

J1:31	Paper jam Remove the document, load it, then perform the scan again.
J1:50	Pick error Remove the document, load it, then perform the scan again.

Remove jammed documents by referring to [When a Paper Jam Occurs \(page 148\)](#).

If paper jams occur frequently, take measures according to [Paper Jams/Pick Errors Occur Frequently \(page 220\)](#).

If the problem persists, write down the error code and contact the distributor/dealer where you purchased this product. Refer to the contact information in the Contact List if supplied with this product, or refer to the contact information in the Contact for Inquiries section if provided in Safety Precautions supplied with this product, and then make an inquiry.

## Multifeed

When documents are overlapped and fed into the scanner, the [Error] screen on the touch screen displays one of the following codes.

J2:55	Multifeed detected (Overlap) Press the [Eject Document] button to eject the document.
J2:56	Multifeed detected (Length) Press the [Eject Document] button to eject the document.

If documents remain in the scanner, remove the documents by referring to [When a Paper Jam Occurs \(page 148\)](#).

If documents are overlapped and fed into the scanner frequently, take measures according to [Overlapped Documents Are Frequently Fed into the Scanner \(page 213\)](#).

If the problem persists, write down the error code and contact the distributor/dealer where you purchased this product. Refer to the contact information in the Contact List if supplied with this product, or refer to the contact information in the Contact for Inquiries section if provided in Safety Precautions supplied with this product, and then make an inquiry.

## Feed Mode Switched

When the feed mode is switched during scanning, the [Error] screen on the touch screen displays the following code.

J7:5F	Feed mode switched Check the feed mode switch setting, reload the documents and try again.
-------	---

Check the position of the feed mode switch.

If documents remain in the ADF, remove the documents by referring to [When a Paper Jam Occurs \(page 148\)](#).

If the problem persists, write down the error code and contact the distributor/dealer where you purchased this product. Refer to the contact information in the Contact List if supplied with this product, or refer to the contact information in the Contact for Inquiries section if provided in Safety Precautions supplied with this product, and then make an inquiry.

## Sensor(s) dirty

If a sensor is dirty, the [Error] screen on the touch screen displays one of the following codes.

J8:01	Sensor(s) dirty Clean the Pick Sensor.
J8:04	Sensor(s) dirty Clean the READ-TOP Sensor.

Take the following measures.

- Clean the document sensors by referring to [Cleaning the Inside of the Scanner \(ADF\) with a Cloth \(page 127\)](#).

- Turn the scanner off then back on.

If the problem persists, write down the error code and contact the distributor/dealer where you purchased this product. Refer to the contact information in the Contact List if supplied with this product, or refer to the contact information in the Contact for Inquiries section if provided in Safety Precautions supplied with this product, and then make an inquiry.

---

## Cover Open Error

### Cover Open

If the ADF is opened during a scan, the [Error] screen on the touch screen displays the following code.

U4:40	ADF open
-------	----------

**TIP**

The [Error] screen does not display the code when the ADF is opened while the scanner is in standby.

Also, note that operations on the touch screen are disabled while the ADF is open.

Confirm that the ADF is closed properly.

To check whether or not they are closed completely, open the ADF and then close it again.

For more details about opening and closing the ADF, refer to [Opening/Closing the ADF \(page 67\)](#).

## Internal and Optical Errors

### Optical Error

When an optical error occurs in the ADF, the [Error] screen on the touch screen displays one of the following codes.

E2:74	Optical error (ADF Front) If the problem persists after turning the power back on, please inform your service provider of the error code below. Code E2:74
E3:75	Optical error (ADF Back) If the problem persists after turning the power back on, please inform your service provider of the error code below. Code E3:75

Take the following measures.

- Refer to [Cleaning the Inside of the Scanner \(ADF\) with a Cloth \(page 127\)](#) and clean the glass.
- Turn the scanner off then back on.

If the problem persists, write down the error code and contact the distributor/dealer where you purchased this product. Refer to the contact information in the Contact List if supplied with this product, or refer to the contact information in the Contact for Inquiries section if provided in Safety Precautions supplied with this product, and then make an inquiry.

### Operator Panel error

When a touch screen error occurs, the [Error] screen on the touch screen displays the following code.

E6:D3	Operator Panel error If the problem persists after turning the power back on, please inform your service provider of the error code below. Code E6:D3
-------	---

Turn the scanner off then back on.

If the problem persists, write down the error code and contact the distributor/dealer where you purchased this product. Refer to the contact information in the Contact List if supplied with this product, or refer to the contact information in the Contact for Inquiries section if provided in Safety Precautions supplied with this product, and then make an inquiry.

### EEPROM Error

If an EEPROM error occurs, the [Error] screen on the touch screen displays the following code.

E7:D2	EEPROM error
-------	--------------

	<p>If the problem persists after turning the power back on, please inform your service provider of the error code below. Code E7:D2</p>
--	---

Turn the scanner off then back on.

If the problem persists, write down the error code and contact the distributor/dealer where you purchased this product. Refer to the contact information in the Contact List if supplied with this product, or refer to the contact information in the Contact for Inquiries section if provided in Safety Precautions supplied with this product, and then make an inquiry.

## Image Memory Read-Write Error

If an error occurs when data is read from the image memory or written on the image memory, the [Error] screen on the touch screen displays one of the following codes.

E9:F5	<p>Image memory read-write error (Front) If the problem persists after turning the power back on, please inform your service provider of the error code below. Code E9:F5</p>
E9:F6	<p>Image memory read-write error (Back) If the problem persists after turning the power back on, please inform your service provider of the error code below. Code E9:F6</p>

Turn the scanner off then back on.

If the problem persists, write down the error code and contact the distributor/dealer where you purchased this product. Refer to the contact information in the Contact List if supplied with this product, or refer to the contact information in the Contact for Inquiries section if provided in Safety Precautions supplied with this product, and then make an inquiry.

## Overrun Error

### Background Switching Mechanism Error

When a background switching mechanism error occurs, the [Error] screen on the touch screen displays one of the following codes.

F4:C2	Background switching mechanism error (ADF Front) If the problem persists after turning the power back on, please inform your service provider of the error code below. Code F4:C2
F4:C3	Background switching mechanism error (ADF Back) If the problem persists after turning the power back on, please inform your service provider of the error code below. Code F4:C3

Open the ADF to check that there are no documents remaining, and then turn the scanner off then back on.

If the problem persists, write down the error code and contact the distributor/dealer where you purchased this product. Refer to the contact information in the Contact List if supplied with this product, or refer to the contact information in the Contact for Inquiries section if provided in Safety Precautions supplied with this product, and then make an inquiry.

## Chip Error

### Memory Error

When a memory error occurs, the [Error] screen on the touch screen displays one of the following codes.

C0:E5	Memory error (Front) If the problem persists after turning the power back on, please inform your service provider of the error code below. Code C0:E5
C0:E6	Memory error (Back) If the problem persists after turning the power back on, please inform your service provider of the error code below. Code C0:E6
C0:E9	LSI error (Front) If the problem persists after turning the power back on, please inform your service provider of the error code below. Code C0:E9
C0:EA	LSI error (Back) If the problem persists after turning the power back on, please inform your service provider of the error code below. Code C0:EA

Turn the scanner off then back on.

If the problem persists, write down the error code and contact the distributor/dealer where you purchased this product. Refer to the contact information in the Contact List if supplied with this product, or refer to the contact information in the Contact for Inquiries section if provided in Safety Precautions supplied with this product, and then make an inquiry.

## Motor Circuit Error

### Motor Circuit Error

When a motor circuit error occurs, the [Error] screen on the touch screen displays one of the following codes.

H0:84	Motor circuit error If the problem persists after turning the power back on, please inform your service provider of the error code below. Code H0:84
H1:80	Motor circuit error If the problem persists after turning the power back on, please inform your service provider of the error code below. Code H1:80
H2:81	Motor circuit error If the problem persists after turning the power back on, please inform your service provider of the error code below. Code H2:81
H8:88	Motor circuit error If the problem persists after turning the power back on, please inform your service provider of the error code below. Code H8:88

Turn the scanner off then back on.

If the problem persists, write down the error code and contact the distributor/dealer where you purchased this product. Refer to the contact information in the Contact List if supplied with this product, or refer to the contact information in the Contact for Inquiries section if provided in Safety Precautions supplied with this product, and then make an inquiry.

### Lamp Circuit Error

When a lamp circuit error occurs, the [Error] screen on the touch screen displays the following code.

H7:84	Lamp circuit error If the problem persists after turning the power back on, please inform your service provider of the error code below. Code H7:84
-------	---

Turn the scanner off then back on.

If the problem persists, write down the error code and contact the distributor/dealer where you purchased this product. Refer to the contact information in the Contact List if supplied with this product, or refer to the contact information in the Contact for Inquiries section if provided in Safety Precautions supplied with this product, and then make an inquiry.

## Sensor Error

### Sensor Error

If a sensor error occurs, the [Error] screen on the touch screen displays one of the following codes.

L0:11	Sensor error If the problem persists after turning the power back on, please inform your service provider of the error code below. Code L0:11
L2:13	Sensor error If the problem persists after turning the power back on, please inform your service provider of the error code below. Code L2:13
L6:1B	Sensor error If the problem persists after turning the power back on, please inform your service provider of the error code below. Code L6:1B

Take the following measures.

- Clean the ultrasonic sensors and the document sensors by referring to [Cleaning the Inside of the Scanner \(ADF\) with a Cloth \(page 127\)](#).
- Turn the scanner off then back on.

If the problem persists, write down the error code and contact the distributor/dealer where you purchased this product. Refer to the contact information in the Contact List if supplied with this product, or refer to the contact information in the Contact for Inquiries section if provided in Safety Precautions supplied with this product, and then make an inquiry.

## Communication Related Errors

### Module Error

When a module error occurs, the [Error] screen on the touch screen displays one of the following codes.

M0:D4	<p>Wi-Fi error</p> <p>If the problem persists after turning the power back on, please inform your service provider of the error code below.</p> <p>Code M0:D4</p>
M1:D5	<p>Wired LAN error</p> <p>If the problem persists after turning the power back on, please inform your service provider of the error code below.</p> <p>Code M1:D5</p>
M2:D6	<p>An error occurred with the smart card reader.</p> <p>If the problem persists after turning the power back on, please inform your service provider of the error code below.</p> <p>Code M2:D6</p>

Turn the scanner off then back on.

If the problem persists, write down the error code and contact the distributor/dealer where you purchased this product. Refer to the contact information in the Contact List if supplied with this product, or refer to the contact information in the Contact for Inquiries section if provided in Safety Precautions supplied with this product, and then make an inquiry.

### Network Setting Error

If a network settings error occurs, the [Error] screen on the touch screen displays one of the following codes.

M4:A2	The scanner is not connected to the network. Check the network settings.
M4:A3	Cannot connect to the proxy server. Check the network settings.
M4:A4	Cannot connect to PaperStream NX Manager. Check the network settings.
M4:A5	Cannot connect to PaperStream NX Manager or the proxy server. Check the network settings.
M4:A6	Network connection timed out. Make sure that PaperStream NX Manager is running, and check the network connection.
M4:A7	Invalid client certificate for the network connection. Check the network connection.
M4:A8	Failed to send data. Check the network status, reload the document, and try again.
M4:A9	Failed to receive data. Make sure that PaperStream NX Manager is running, and check the network connection.

M4:AA	A network connection error occurred. Check the network connection.
M4:AB	Failed to send data. Check the network status, reload the document, and try again.
M4:AD	Time-out occurred during the waiting process. Check whether files have been saved in PaperStream NX Manager.

Check the message displayed in the [Error] screen, and take measures accordingly.

To check the network settings for the scanner, press the [Set] button.

If the problem persists, write down the error code and contact the distributor/dealer where you purchased this product. Refer to the contact information in the Contact List if supplied with this product, or refer to the contact information in the Contact for Inquiries section if provided in Safety Precautions supplied with this product, and then make an inquiry.

## Server Setting Error

If an error occurs in the settings in PaperStream NX Manager, the [Error] screen on the touch screen displays one of the following codes.

M4:AA	A network connection error occurred. Check the network connection.
M5:A2	Failed to save the file. Check the PaperStream NX Manager settings.
M5:AC	An error occurred in the communication with PaperStream NX Manager. Check the PaperStream NX Manager settings.
M5:AE	The smart card reader settings are invalid. Check the smart card reader settings.

### For M4:AA

Check the message displayed in the [Error] screen, take the appropriate action, and then correct the following settings:

- Setting in PaperStream NX Manager

If [Validate server certificates] is enabled, check the imported server certificate.

For details about importing a server certificate, refer to the PaperStream NX Manager User's Guide.

### For M5:A2, M5:AC, or M5:AE

Check the message displayed in the [Error] screen, and correct the following settings:

- "PaperStream NX Manager" setting on the scanner
- Setting in PaperStream NX Manager

To check the network settings for the scanner, press the [Set] button.

If the problem persists, write down the error code and contact the distributor/dealer where you purchased this product. Refer to the contact information in the Contact List if supplied with this product, or refer to the contact information in the Contact for Inquiries section if provided in Safety Precautions supplied with this product, and then make an inquiry.

## Scanner Central Admin Server Setting Error

If an error occurs in the settings in the Scanner Central Admin Server, the [Error] screen on the touch screen displays one of the following codes.

M4:AA	A network connection error occurred. Check the network connection.
M4:AC	Scanner details could not be registered with the Scanner Central Admin Server. Check the Scanner Central Admin Server connection environment.
M5:A3	The Scanner Central Admin Server version which it is connected to is not supported.
M5:A4	You have attempted to register more than the maximum number of scanners that can be registered.
M5:A5	Maintenance work in progress. Try again later.

### For M4:AA

Check the message displayed in the [Error] screen, take the appropriate action, and then correct the following settings:

- Setting in the Scanner Central Admin Server

If [Validate server certificates] is enabled, check the imported server certificate.

For details about importing a server certificate, refer to the Scanner Central Admin User's Guide.

### For M4:AC, M5:A3, or M5:A4

Check the message displayed in the [Error] screen, and correct the following settings:

- The "Scanner Central Admin Server" setting on the scanner
- Setting in the Scanner Central Admin Server

To check the network settings for the scanner, press the [Set] button.

### For M5:A5

Try again later.

If the problem persists, write down the error code and contact the distributor/dealer where you purchased this product. Refer to the contact information in the Contact List if supplied with this product, or refer to the contact information in the Contact for Inquiries section if provided in Safety Precautions supplied with this product, and then make an inquiry.

## Authentication Failed

If the authentication for PaperStream NX Manager fails, the [Error] screen on the touch screen displays the following code.

M6:AF	Authentication failed in Auto Login mode. Check the Auto Login Setting.
-------	---

Check the message displayed in the [Error] screen, and correct the following settings:

- [Auto Login] setting on the scanner

- Authentication setting for PaperStream NX Manager

To check the network settings for the scanner, press the [Set] button.

If the problem persists, write down the error code and contact the distributor/dealer where you purchased this product. Refer to the contact information in the Contact List if supplied with this product, or refer to the contact information in the Contact for Inquiries section if provided in Safety Precautions supplied with this product, and then make an inquiry.

---

## Other Errors

### Being used by others

The scanner is already being used.

- Make sure that another application is not using the scanner.
- Make sure that the connection method of the scanner is correct.
- Make sure that no operations are being performed on the touch screen of the scanner.

### The scanner is in Doc Counting mode.

The Scanner is in "Doc Counting mode" and therefore scanning cannot be performed.

Close the [Document Count] screen on the touch screen of the scanner to exit the Doc Counting mode.

### Scanning has been paused by the user.

When the [Pause] button on the touch screen is pressed during scanning, scanning pauses.

To resume scanning, press the [Scan] button on the touch screen.

To stop scanning, press  on the touch screen.

### Outside designated scan area error

This error occurs when the bottom edge of the document is detected before the specified area is scanned with the ADF.

Example:

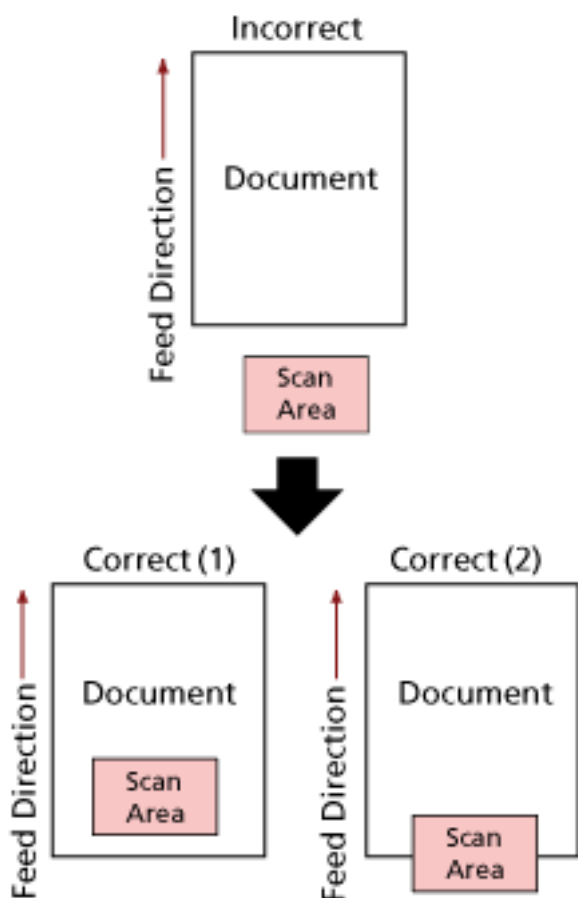

Outside of the document may have been scanned because the scanned document is shorter than the specified paper size. Take one of the following measures, and then scan again.

- Load a document of the specified paper size in the ADF paper chute (feeder).
- Change the scan settings so that the scanning area is set inside of the document.

#### ATTENTION

Ways to designate the scanning area differ depending on image scanning applications. For details, refer to the help for the image scanning application.

## Invalid Command

The command was ended abnormally.

There may be a problem with the USB cable connection.

- Make sure that the USB cable is connected properly.
- Turn the scanner off then back on.

If the problem persists, write down the error code and contact the distributor/dealer where you purchased this product. Refer to the contact information in the Contact List if supplied with this product, or refer to the contact information in the Contact for Inquiries section if provided in Safety Precautions supplied with this product, and then make an inquiry.

---

## Connection Test Result

- "0% packet loss" shown in the test result

### Meaning

The communication with the host specified in [Host Name/IP address] is normal.

- "100% packet loss" shown in the test result

### Meaning

Failed to communicate with the destination specified in [Host Name/IP address].

### Solution

[Host Name/IP address] may not be specified correctly. Make sure that the host name or the IP address is specified correctly.

If the problem persists, refer to the following section in [Troubleshooting \(page 171\)](#):

- [The Connection Between the Scanner and Computer Frequently Cuts Off \(page 194\)](#)
- [Cannot Connect the Scanner to a Destination by Specifying an IP Address \(page 201\)](#)
- [Cannot Connect the Scanner to a Destination by Specifying a Host Name \(page 203\)](#)

- "99% packet loss" shown in the test result

### Meaning

Communication with the destination specified in [Host Name/IP address] is unstable.

### Solution

Refer to [Cannot Connect the Scanner and a Computer via Wi-Fi \(page 178\)](#) and [Cannot Connect the Scanner and a Computer via a Wired LAN \(page 195\)](#), and take measures accordingly.

- "ping: bad address" shown in the test result

### Meaning

The name-resolution or address-resolution for the destination specified in [Host Name/IP address] may have failed.

### Solution

- Make sure that [Host Name/IP address] is specified correctly.
- Make sure that the DNS server settings are correct.
- If [Host Name/IP address] is specified correctly, refer to [Cannot Connect the Scanner to a Destination by Specifying a Host Name \(page 203\)](#) for further solutions.

- Refer to [Cannot Connect the Scanner and a Computer via Wi-Fi \(page 178\)](#) and [Cannot Connect the Scanner and a Computer via a Wired LAN \(page 195\)](#), and take measures accordingly.

---

## Troubleshooting

This section describes examples of troubles that you may encounter when using the scanner and also describes the solutions to them.

Before you request for a repair, take measures by looking through the examples of the troubles and solutions.

If the problem persists, check each item in [Before You Contact the Scanner Service Provider \(page 229\)](#), and then contact the distributor/dealer where you purchased this product. Refer to the contact information in the Contact List if supplied with this product, or refer to the contact information in the Contact for Inquiries section if provided in Safety Precautions supplied with this product, and then make an inquiry.

The following are examples of troubles that you may encounter.

- **Power of the scanner**

- [The Scanner Cannot Be Powered ON \(page 173\)](#)
- [The Touch Screen or the \[Power\] Button Light or Both Switch Off \(page 174\)](#)

- **Touch screen**

- [The Touch Screen Does Not Function \(page 175\)](#)
- [A Malfunction Occurs in the Touch Screen/The Display on the Touch Screen Is in an Incorrect Position \(page 176\)](#)
- [The Display on the Touch Screen Is Distorted \(page 177\)](#)

- **Connection of the scanner**

- Wi-Fi**

- [Cannot Connect the Scanner and a Computer via Wi-Fi \(page 178\)](#)
- [A Wireless Access Point Is Not Displayed in the Access Point List \(page 185\)](#)
- [Wi-Fi Setting for WPS Fails \(page 187\)](#)
- [Failed to Establish a Wi-Fi Connection by Configuring the Settings Manually \(page 191\)](#)
- [The Connection Between the Scanner and Computer Frequently Cuts Off \(page 194\)](#)

- Wired LAN**

- [Cannot Connect the Scanner and a Computer via a Wired LAN \(page 195\)](#)

- USB**

- [Cannot Connect the Scanner and a Computer via a USB Cable \(page 200\)](#)

- Server**

- [Cannot Connect the Scanner to a Destination by Specifying an IP Address \(page 201\)](#)
- [Cannot Connect the Scanner to a Destination by Specifying a Host Name \(page 203\)](#)

- **Scanning operations**
  - [Scanning Does Not Start \(page 206\)](#)
  - [Scanning Takes a Long Time \(page 207\)](#)
  - [Vertical Streaks Appear on the Images \(page 211\)](#)
  - [Error Code "U4:40" Is Displayed on the Touch Screen While Scanning \(page 212\)](#)
  - [Overlapped Documents Are Frequently Fed into the Scanner \(page 213\)](#)
  - [Situation in Which the Document Is not Fed into the ADF Occurs Frequently \(page 216\)](#)
  - [Paper Protection Is Set Off Frequently \(page 218\)](#)
  - [Paper Jams/Pick Errors Occur Frequently \(page 220\)](#)
  
- **Scanning results**
  - [Image Quality Is Poor \(page 208\)](#)
  - [Quality of Scanned Text or Lines Is Unsatisfactory \(page 209\)](#)
  - [Images Are Distorted or Not Clear \(page 210\)](#)
  - [Images Turn Out Elongated \(page 222\)](#)
  - [A Shadow Appears at the Top or the Bottom of the Image \(page 223\)](#)
  - [There Are Black Traces on the Document \(page 224\)](#)
  
- **Carrier Sheet**
  - [The Carrier Sheet Is Not Fed Smoothly/Paper Jams Occur \(page 225\)](#)
  - [Part of the Image Appears Missing in the Case Where the Carrier Sheet Is Used \(page 227\)](#)
  
- **Password**
  - [An Error Occurs When Entering the Default Administrator Password \(page 228\)](#)

## The Scanner Cannot Be Powered ON

### Check the following points

- [Is the power cable connected properly? \(page 173\)](#)
- [Did you press the \[Power\] button on the scanner? \(page 173\)](#)

If the problem persists, check the items in [Before You Contact the Scanner Service Provider \(page 229\)](#) first, then contact the distributor/dealer where you purchased this product. Refer to the contact information in the Contact List if supplied with this product, or refer to the contact information in the Contact for Inquiries section if provided in Safety Precautions supplied with this product, and then make an inquiry.

- **Is the power cable connected properly?**

#### Solution

Connect the power cable properly.  
For details, refer to Getting Started.

- **Did you press the [Power] button on the scanner?**

#### Solution

Press the [Power] button on the scanner.  
For details, refer to [How to Turn the Power ON \(page 60\)](#).

## The Touch Screen or the [Power] Button Light or Both Switch Off

### Check the following points

- [Has the scanner been left out of operation for a long time after being powered on? \(page 174\)](#)

If the problem persists, check the items in [Before You Contact the Scanner Service Provider \(page 229\)](#) first, then contact the distributor/dealer where you purchased this product. Refer to the contact information in the Contact List if supplied with this product, or refer to the contact information in the Contact for Inquiries section if provided in Safety Precautions supplied with this product, and then make an inquiry.

- **Has the scanner been left out of operation for a long time after being powered on?**

### Solution

The scanner has entered power saving mode or has been automatically turned off.

- If the scanner has entered power saving mode

The touch screen turns off and the [Power] button flashes in green.

Resume from power saving mode by one of the following methods:

- Load a document in the ADF paper chute (feeder).
- Press the touch screen.
- Scans a document with the image scanning application.

For details, refer to [Entering and Resuming from Power Saving Mode \(page 65\)](#).

- If the scanner has been automatically turned off

The touch screen and the [Power] button light are off.

Turn on the scanner.

For details, refer to [How to Turn the Power ON \(page 60\)](#).

## The Touch Screen Does Not Function

### Check the following points

- [Did you turn the scanner off then back on? \(page 175\)](#)

If the problem persists, check the items in [Before You Contact the Scanner Service Provider \(page 229\)](#) first, then contact the distributor/dealer where you purchased this product. Refer to the contact information in the Contact List if supplied with this product, or refer to the contact information in the Contact for Inquiries section if provided in Safety Precautions supplied with this product, and then make an inquiry.

- **Did you turn the scanner off then back on?**

### Solution

Turn the scanner off then back on.

Wait for at least 5 seconds after turning off the scanner before turning it back on.

For details, refer to [How to Turn the Power ON \(page 60\)](#).

## A Malfunction Occurs in the Touch Screen/The Display on the Touch Screen Is in an Incorrect Position

### Check the following points

- [Did you turn the scanner off then back on? \(page 176\)](#)

If the problem persists, check the items in [Before You Contact the Scanner Service Provider \(page 229\)](#) first, then contact the distributor/dealer where you purchased this product. Refer to the contact information in the Contact List if supplied with this product, or refer to the contact information in the Contact for Inquiries section if provided in Safety Precautions supplied with this product, and then make an inquiry.

- **Did you turn the scanner off then back on?**

### Solution

Turn the scanner off then back on.

Wait for at least 5 seconds after turning off the scanner before turning it back on.

For details, refer to [How to Turn the Power ON \(page 60\)](#).

## The Display on the Touch Screen Is Distorted

### Check the following points

- [Did you turn the scanner off then back on? \(page 177\)](#)

If the problem persists, check the items in [Before You Contact the Scanner Service Provider \(page 229\)](#) first, then contact the distributor/dealer where you purchased this product. Refer to the contact information in the Contact List if supplied with this product, or refer to the contact information in the Contact for Inquiries section if provided in Safety Precautions supplied with this product, and then make an inquiry.

- **Did you turn the scanner off then back on?**

### Solution

Turn the scanner off then back on.

Wait for at least 5 seconds after turning off the scanner before turning it back on.

For details, refer to [How to Turn the Power ON \(page 60\)](#).

## Cannot Connect the Scanner and a Computer via Wi-Fi

### Check the following points

- Is the scanner driver the latest version? (page 178)
- Is the wireless access point turned on? (page 178)
- Is the firmware for the wireless access point the latest version? (page 179)
- Is the scanner far away from the wireless access point? Is there anything that may block the signal (such as walls and metal boards), or an electromagnetic source? (page 179)
- Is [Wi-Fi] selected for the connection method? (page 180)
- Did you connect the scanner to a wireless access point? (page 180)
- Is the wireless connection environment on the computer enabled? (page 180)
- Did you connect the computer to a wireless access point? (page 180)
- Are the scanner and computer connected to the same network? (page 181)
- Is the setting that does not permit communication configured on the wireless access point? (page 181)
- Are there any security limitations in the network? (page 182)
- Are there any security restrictions on the computer? (page 182)
- Is the scanner connected to another computer? (page 182)
- Is the scanner's IP address correct? (page 182)
- Is the IP address of the scanner used for other communication devices? (page 183)
- Is the DNS server information configured correctly? (page 183)
- Does the DNS server function normally? (page 183)
- Did you perform a search using the scanner name (host name) and select the scanner in Scanner Selection Tool for fi Series? (page 183)

If the problem persists, check the items in [Before You Contact the Scanner Service Provider](#) (page 229) first, then contact the distributor/dealer where you purchased this product. Refer to the contact information in the Contact List if supplied with this product, or refer to the contact information in the Contact for Inquiries section if provided in Safety Precautions supplied with this product, and then make an inquiry.

- **Is the scanner driver the latest version?**

#### Solution

Update the scanner driver to the latest version.

- **Is the wireless access point turned on?**

#### Solution

Turn on the wireless access point.

Also check that there is no error or malfunction on the wireless access point.

For details about wireless access point errors, refer to the manual of your wireless access point.

● **Is the firmware for the wireless access point the latest version?**

**Solution**

If the firmware for the wireless access point is not the latest version, unexpected operations may occur.

Contact the network administrator to check the firmware version, and consider updating it to the latest version.





For details about how to update the firmware for your wireless access point, refer to the manual of your wireless access point.

● **Is the scanner far away from the wireless access point? Is there anything that may block the signal (such as walls and metal boards), or an electromagnetic source?**

**Solution**

The signal between the wireless access point and the scanner may be weak, or there may be some signal interference.

Check the icon on the lower left side of the touch screen for the signal status.

Icon	Signal Strength
	Strong
	Medium
	Weak
	Not connected

If the signal is weak, change the installation locations of the scanner and the wireless access point.

- Move the scanner closer to the wireless access point.
- Move the scanner and the wireless access point away from the following.
  - Objects that may block the signal (such as walls and metal boards)
  - Devices that may cause signal interference (such as microwaves and cordless phones) and wireless devices
- Change the direction that the scanner is facing.

Also, communication in certain wireless channels may become unstable due to signal interference such as noise.

Change the value of the wireless channel on the wireless access point.

- **Is [Wi-Fi] selected for the connection method?**

**Solution**



Check the connection method in the following procedure:

- 1 On the touch screen, press  → [Scanner Settings] → [How to connect].
- 2 On the [How to connect] screen, check that [Wi-Fi] is selected.

- **Did you connect the scanner to a wireless access point?**

**Solution**

Check that the scanner is connected to a wireless access point in the following procedure:

- 1 On the touch screen, press  → [Scanner Settings] → [How to connect].
- 2 On the [How to connect] screen, check that [Wi-Fi] is selected.
- 3 On the touch screen, press  → [Scanner Settings] → [Network] → [Wi-Fi] → [Wi-Fi Diagnosis].
- 4 In the [Wi-Fi Diagnosis] screen, check that the scanner is connected to the correct wireless access point.  
If the scanner is not connected to the correct wireless access point, reconnect the scanner to the correct wireless access point.
- 5 On the touch screen, press  → [Scanner Settings] → [Network] → [Wi-Fi] → [Access Point].
- 6 On the [Access Point] screen, select the configuration method.
- 7 By following the window displayed, connect the scanner to a wireless access point.

- **Is the wireless connection environment on the computer enabled?**

**Solution**

Enable the wireless connection environment on the computer that you use.  
For details, refer to the manual of your computer.

- **Did you connect the computer to a wireless access point?**

**Solution**

Connect the computer to a wireless access point.

For details, refer to the manual of your computer.

- **Are the scanner and computer connected to the same network?**

#### Solution

Check whether the scanner and computer are connected to the same network.



Check the network name that the scanner is connected to in the following procedure:

- 1 On the touch screen, press  → [Scanner Settings] → [Network] → [Wi-Fi] → [Wi-Fi Diagnosis].
- 2 On the [Wi-Fi Diagnosis] screen, check the display of [Network name (SSID)].

To check the network name that the computer is connected to, refer to the manual of your computer.

If the scanner and computer are connected to different networks, connect them to the same network.

Change the network that the scanner is connected to in the following procedure:

- 1 On the touch screen, press  → [Scanner Settings] → [How to connect].
- 2 On the [How to connect] screen, check that [Wi-Fi] is selected.
- 3 On the touch screen, press  → [Scanner Settings] → [Network] → [Wi-Fi] → [Access Point].
- 4 On the [Access Point] screen, select the configuration method.
- 5 By following the window displayed, connect the scanner and the computer to the same wireless access point.

- **Is the setting that does not permit communication configured on the wireless access point?**

#### Solution

When the following are set on the wireless access point, take measures accordingly.

- Communication between wireless devices is disabled (for example, because of a privacy separator function or a port separator function).  
Enable communication between wireless devices on the wireless access point.
- SSID broadcast (for example, ANY connect) is disabled.  
Enable SSID broadcast on the wireless access point. Or, configure the Wi-Fi settings manually.
- Protocol filter function is enabled.  
Set the protocol on the wireless access point.
- The stealth function is enabled.

Disable the stealth function, and then use WPS to configure the Wi-Fi settings again. Or, configure the Wi-Fi settings manually.

- MAC address filtering is enabled.

Set the MAC address of the scanner on the wireless access point, and then configure the Wi-Fi settings again.

In addition, the channel may overlap with another wireless access point.

In this case, change the value of the wireless channel on the wireless access point.

For details about wireless access point settings, refer to the manual of your wireless access point.

- **Are there any security limitations in the network?**

#### Solution

The access limitations for users with Wi-Fi may be configured.

For details, contact the network administrator.

- **Are there any security restrictions on the computer?**

#### Solution

In the Windows Firewall settings or in the firewall settings of your security software, unblock the communication of the port numbers which are used by the following software.

- Scanner Selection Tool for fi Series

Port number: 52217

- Button Event Manager for fi Series

Port number: 53218

For details about unblocking the communication, refer to the manual or help of your computer or security software.

- **Is the scanner connected to another computer?**

#### Solution

The scanner can be connected to only one computer at a time. Wait until the other computer is disconnected from the scanner, and then connect the computer to be used again.

- **Is the scanner's IP address correct?**

#### Solution

Check the scanner's IP address in the following procedure:

- 1 On the touch screen, press  → [Scanner Settings] → [Network] → [Wi-Fi] → [IP Address].
- 2 On the [IP Address] screen, check the setting items.  
When specifying an IP address manually, specify the correct IP address.

When setting the IP address automatically, check whether the DHCP server functions normally.

Even when the DHCP server functions normally, an IP address may not be assigned correctly depending on the settings for the DHCP server. Check the operation status and the settings for the DHCP server.

- **Is the IP address of the scanner used for other communication devices?**

**Solution**

If there are multiple communication devices using the same IP address on the same network, communication may fail. Avoid duplicates in IP addresses.

- **Is the DNS server information configured correctly?**

**Solution**

Check the DNS server settings for the scanner in the following procedure:

- 1 On the touch screen, press  → [Scanner Settings] → [Network] → [Wi-Fi] → [DNS Server].
- 2 On the [DNS Server] screen, check the setting items for the following.
  - Whether the DNS server settings is enabled
  - Whether the primary DNS and secondary DNS settings are correct

- **Does the DNS server function normally?**

**Solution**

Check whether the DNS server functions normally by following the procedure below.

- 1 On the touch screen, press  → [Scanner Settings] → [Network] → [Check connection (Ping)].
- 2 In the [Check connection (Ping)] screen, enter the IP address of the DNS server, and press the [Run] button.  
The result is displayed.  
Refer to [Connection Test Result \(page 169\)](#) and take measures accordingly.  
If the DNS server does not function normally, contact the DNS server administrator.

- **Did you perform a search using the scanner name (host name) and select the scanner in Scanner Selection Tool for fi Series?**

**Solution**

Make sure that the scanner is connected to the network and that the IP address displayed on the window of Scanner Selection Tool for fi Series is correct by following the procedure below.

- 1 Start up the command prompt on the computer where you ran Scanner Selection Tool for fi Series.  
For example, in Windows 10, you can start up the command prompt by clicking [Start] menu → [Windows System] → [Command Prompt].

- 2 Execute the following command.

```
ping ScannerName
```

- 3 In either of the following cases, turn the scanner off then back on.
  - There is no response.
  - The IP address that is returned is different from the IP address displayed on the window of Scanner Selection Tool for fi Series.

## A Wireless Access Point Is Not Displayed in the Access Point List

### Check the following points

- Is the wireless access point turned on? (page 185)
- Is the scanner far away from the wireless access point? Is there anything that may block the signal (such as walls and metal boards), or an electromagnetic source? (page 185)
- Is the setting that does not permit communication configured on the wireless access point? (page 186)

If the problem persists, check the items in [Before You Contact the Scanner Service Provider](#) (page 229) first, then contact the distributor/dealer where you purchased this product. Refer to the contact information in the Contact List if supplied with this product, or refer to the contact information in the Contact for Inquiries section if provided in Safety Precautions supplied with this product, and then make an inquiry.

- **Is the wireless access point turned on?**

#### Solution

Turn on the wireless access point.

Also check that there is no error or malfunction on the wireless access point.





For details about wireless access point errors, refer to the manual of your wireless access point.

- **Is the scanner far away from the wireless access point? Is there anything that may block the signal (such as walls and metal boards), or an electromagnetic source?**

#### Solution

The signal between the wireless access point and the scanner may be weak, or there may be some signal interference.

Check the icon on the lower left side of the touch screen for the signal status.

Icon	Signal Strength
	Strong
	Medium
	Weak
	Not connected

If the signal is weak, change the installation locations of the scanner and the wireless access point.

- Move the scanner closer to the wireless access point.
  - Move the scanner and the wireless access point away from the following.
    - Objects that may block the signal (such as walls and metal boards)
    - Devices that may cause signal interference (such as microwaves and cordless phones) and wireless devices
  - Change the direction that the scanner is facing.
- Also, communication in certain wireless channels may become unstable due to signal interference such as noise.
- Change the value of the wireless channel on the wireless access point.

● **Is the setting that does not permit communication configured on the wireless access point?**

**Solution**

When the following are set on the wireless access point, take measures accordingly.

- Communication between wireless devices is disabled (for example, because of a privacy separator function or a port separator function).  
Enable communication between wireless devices on the wireless access point.
- SSID broadcast (for example, ANY connect) is disabled.  
Enable SSID broadcast on the wireless access point. Or, configure the Wi-Fi settings manually.
- Protocol filter function is enabled.  
Set the protocol on the wireless access point.
- The stealth function is enabled.  
Disable the stealth function, and then use WPS to configure the Wi-Fi settings again. Or, configure the Wi-Fi settings manually.
- MAC address filtering is enabled.  
Set the MAC address of the scanner on the wireless access point, and then configure the Wi-Fi settings again.

In addition, the channel may overlap with another wireless access point.

In this case, change the value of the wireless channel on the wireless access point.

For details about wireless access point settings, refer to the manual of your wireless access point.

## Wi-Fi Setting for WPS Fails

### Check the following points

- Is the wireless access point turned on? (page 187)
- Is the scanner far away from the wireless access point? Is there anything that may block the signal (such as walls and metal boards), or an electromagnetic source? (page 187)
- Does a wireless access point support WPS (automatic configuration)? (page 188)
- Is WEP used as the encryption method for the wireless access point? (page 188)
- Did you enter the correct PIN when configuring the wireless settings for using WPS (PIN)? (page 188)
- Did you finish the WPS operation on time? (page 189)
- Is the setting that does not permit communication configured on the wireless access point? (page 189)

If the problem persists, check the items in [Before You Contact the Scanner Service Provider \(page 229\)](#) first, then contact the distributor/dealer where you purchased this product. Refer to the contact information in the Contact List if supplied with this product, or refer to the contact information in the Contact for Inquiries section if provided in Safety Precautions supplied with this product, and then make an inquiry.

- **Is the wireless access point turned on?**

#### Solution

Turn on the wireless access point.

Also check that there is no error or malfunction on the wireless access point.



For details about wireless access point errors, refer to the manual of your wireless access point.



- **Is the scanner far away from the wireless access point? Is there anything that may block the signal (such as walls and metal boards), or an electromagnetic source?**

#### Solution

The signal between the wireless access point and the scanner may be weak, or there may be some signal interference.

Check the icon on the lower left side of the touch screen for the signal status.

Icon	Signal Strength
	Strong
	Medium

Icon	Signal Strength
	Weak
	Not connected

If the signal is weak, change the installation locations of the scanner and the wireless access point.

- Move the scanner closer to the wireless access point.
- Move the scanner and the wireless access point away from the following.
  - Objects that may block the signal (such as walls and metal boards)
  - Devices that may cause signal interference (such as microwaves and cordless phones) and wireless devices
- Change the direction that the scanner is facing.

Also, communication in certain wireless channels may become unstable due to signal interference such as noise.

Change the value of the wireless channel on the wireless access point.

● **Does a wireless access point support WPS (automatic configuration)?**

**Solution**

When the wireless access point does not support WPS, manually configure the settings for Wi-Fi.

To check whether or not the wireless access point supports WPS, refer to the manual of your wireless access point.

● **Is WEP used as the encryption method for the wireless access point?**

**Solution**

If WEP is used as the encryption method for the wireless access point, change the encryption method, and then try again.

● **Did you enter the correct PIN when configuring the wireless settings for using WPS (PIN)?**

**Solution**

Check the PIN in the following procedure:

- 1 On the touch screen, press  → [Scanner Settings] → [Network] → [Wi-Fi] → [Access Point] → [Use WPS] → [PIN].
- 2 On your wireless access point, enter the PIN as shown in the [PIN] screen.  
To check how to enter the PIN, refer to the manual of your wireless access point.

- **Did you finish the WPS operation on time?**

**Solution**

Configure the wireless settings again with the WPS.

- For push-button

- 1 On the touch screen, press  → [Scanner Settings] → [Network] → [Wi-Fi] → [Access Point] → [Use WPS] → [Push-Button].
- 2 Push the WPS button on the wireless access point.
- 3 Within two minutes after step 2, press the [Next] button which is displayed on the touch screen in step 1.

- For PIN

- 1 On the touch screen, press  → [Scanner Settings] → [Network] → [Wi-Fi] → [Access Point] → [Use WPS] → [PIN].
- 2 On your wireless access point, enter the PIN as shown in the [PIN] screen.  
To check how to enter the PIN, refer to the manual of your wireless access point.
- 3 Within two minutes after step 2, press the [Next] button which is displayed on the touch screen in step 1.

Note that if multiple wireless access points are waiting to be connected by WPS, the connection may fail.

In that case, wait for a while, and then configure the Wi-Fi settings again by using WPS. Or, configure the Wi-Fi settings manually.

- **Is the setting that does not permit communication configured on the wireless access point?**

**Solution**

When the following are set on the wireless access point, take measures accordingly.

- Communication between wireless devices is disabled (for example, because of a privacy separator function or a port separator function).  
Enable communication between wireless devices on the wireless access point.
- SSID broadcast (for example, ANY connect) is disabled.  
Enable SSID broadcast on the wireless access point. Or, configure the Wi-Fi settings manually.
- Protocol filter function is enabled.  
Set the protocol on the wireless access point.
- The stealth function is enabled.  
Disable the stealth function, and then use WPS to configure the Wi-Fi settings again. Or, configure the Wi-Fi settings manually.

- MAC address filtering is enabled.

Set the MAC address of the scanner on the wireless access point, and then configure the Wi-Fi settings again.

In addition, the channel may overlap with another wireless access point.

In this case, change the value of the wireless channel on the wireless access point.

For details about wireless access point settings, refer to the manual of your wireless access point.

## Failed to Establish a Wi-Fi Connection by Configuring the Settings Manually

### Check the following points

- Is the wireless access point turned on? (page 191)
- Is the scanner far away from the wireless access point? Is there anything that may block the signal (such as walls and metal boards), or an electromagnetic source? (page 191)
- Are the network name (SSID), security protocol (authentication method), encryption method, and security key configured correctly? (page 192)
- Is the setting that does not permit communication configured on the wireless access point? (page 192)
- Is the message, [The encryption method does not match with the access point.] displayed? (page 193)

If the problem persists, check the items in [Before You Contact the Scanner Service Provider \(page 229\)](#) first, then contact the distributor/dealer where you purchased this product. Refer to the contact information in the Contact List if supplied with this product, or refer to the contact information in the Contact for Inquiries section if provided in Safety Precautions supplied with this product, and then make an inquiry.

- Is the wireless access point turned on?

### Solution

Turn on the wireless access point.

Also check that there is no error or malfunction on the wireless access point.



For details about wireless access point errors, refer to the manual of your wireless access point.

- Is the scanner far away from the wireless access point? Is there anything that may block the signal (such as walls and metal boards), or an electromagnetic source?

### Solution

The signal between the wireless access point and the scanner may be weak, or there may be some signal interference.

Check the icon on the lower left side of the touch screen for the signal status.

Icon	Signal Strength
	Strong
	Medium
	Weak

Icon	Signal Strength
	Not connected

If the signal is weak, change the installation locations of the scanner and the wireless access point.

- Move the scanner closer to the wireless access point.
- Move the scanner and the wireless access point away from the following.
  - Objects that may block the signal (such as walls and metal boards)
  - Devices that may cause signal interference (such as microwaves and cordless phones) and wireless devices
- Change the direction that the scanner is facing.

Also, communication in certain wireless channels may become unstable due to signal interference such as noise.

Change the value of the wireless channel on the wireless access point.

- **Are the network name (SSID), security protocol (authentication method), encryption method, and security key configured correctly?**

**Solution**

Use the same network name (SSID), security protocol (authentication method), encryption method, and security key as your wireless access point.

If you cannot find the network name (SSID) or the security key, either refer to the manual of your wireless access point or contact the manufacturer.

- **Is the setting that does not permit communication configured on the wireless access point?**

**Solution**

When the following are set on the wireless access point, take measures accordingly.

- Communication between wireless devices is disabled (for example, because of a privacy separator function or a port separator function).  
Enable communication between wireless devices on the wireless access point.
- SSID broadcast (for example, ANY connect) is disabled.  
Enable SSID broadcast on the wireless access point. Or, configure the Wi-Fi settings manually.
- Protocol filter function is enabled.  
Set the protocol on the wireless access point.
- The stealth function is enabled.  
Disable the stealth function, and then use WPS to configure the Wi-Fi settings again. Or, configure the Wi-Fi settings manually.
- MAC address filtering is enabled.  
Set the MAC address of the scanner on the wireless access point, and then configure the Wi-Fi settings again.

In addition, the channel may overlap with another wireless access point. In this case, change the value of the wireless channel on the wireless access point. For details about wireless access point settings, refer to the manual of your wireless access point.

- **Is the message, [The encryption method does not match with the access point.] displayed?**

#### **Solution**

Set the same encryption method as the one for the wireless access point. The scanner cannot be connected to the wireless access point in the following cases. Change to another encryption method or security protocol.

- "WEP" is set for the encryption method of the wireless access point
- "WEP (Transitional Security Network)" is set for the security protocol of the wireless access point.

## The Connection Between the Scanner and Computer Frequently Cuts Off

### Check the following points

- Is the scanner far away from the wireless access point? Is there anything that may block the signal (such as walls and metal boards), or an electromagnetic source? (page 194)





If the problem persists, check the items in [Before You Contact the Scanner Service Provider \(page 229\)](#) first, then contact the distributor/dealer where you purchased this product. Refer to the contact information in the Contact List if supplied with this product, or refer to the contact information in the Contact for Inquiries section if provided in Safety Precautions supplied with this product, and then make an inquiry.

- Is the scanner far away from the wireless access point? Is there anything that may block the signal (such as walls and metal boards), or an electromagnetic source?

### Solution

The signal between the wireless access point and the scanner may be weak, or there may be some signal interference.

Check the icon on the lower left side of the touch screen for the signal status.

Icon	Signal Strength
	Strong
	Medium
	Weak
	Not connected

If the signal is weak, change the installation locations of the scanner and the wireless access point.

- Move the scanner closer to the wireless access point.
- Move the scanner and the wireless access point away from the following.
  - Objects that may block the signal (such as walls and metal boards)
  - Devices that may cause signal interference (such as microwaves and cordless phones) and wireless devices
- Change the direction that the scanner is facing.

Also, communication in certain wireless channels may become unstable due to signal interference such as noise.

Change the value of the wireless channel on the wireless access point.

## Cannot Connect the Scanner and a Computer via a Wired LAN

### Check the following points

- Is the scanner connected to a network device (such as a switch, a hub, or a router) via a LAN cable? (page 195)
- Is [Wired LAN] selected for the connection setting? (page 196)
- Is the network device (such as a switch, a hub, or a router) turned on? (page 196)
- Is the firmware version for the network device the latest? (page 196)
- Is the computer connected to a network device (such as a switch, a hub, or a router)? (page 196)
- Did you configure the settings related to communication conditions on a network device (such as a switch, a hub, or a router)? (page 196)
- Are there any security limitations in the network? (page 197)
- Is the network stable? (page 197)
- Are there any security restrictions on the computer? (page 197)
- Is the computer connected to a wired LAN? (page 197)
- Is the scanner connected to another computer? (page 198)
- Is the scanner's IP address correct? (page 198)
- Is the IP address of the scanner used for other communication devices? (page 198)
- Is the DNS server information configured correctly? (page 198)
- Does the DNS server function normally? (page 199)
- Is the scanner driver the latest version? (page 199)
- Did you perform a search using the scanner name (host name) and select the scanner in Scanner Selection Tool for fi Series? (page 199)

If the problem persists, check the items in [Before You Contact the Scanner Service Provider \(page 229\)](#) first, then contact the distributor/dealer where you purchased this product. Refer to the contact information in the Contact List if supplied with this product, or refer to the contact information in the Contact for Inquiries section if provided in Safety Precautions supplied with this product, and then make an inquiry.

- **Is the scanner connected to a network device (such as a switch, a hub, or a router) via a LAN cable?**

### Solution

Connect the scanner to a network device (such as a switch, a hub, or a router) via a LAN cable. Also, connect the LAN cable properly.

When the LAN cable is connected properly, take the following measures:

- Replace the LAN cable.
- Change the port on the network device, which the LAN cable is connected to.
- Change the transmission method for the network device to "full-duplex" or "half-duplex".

- **Is [Wired LAN] selected for the connection setting?**

#### Solution

Check the connection method in the following procedure:

- 1 On the touch screen, press  → [Scanner Settings] → [How to connect].
- 2 On the [How to connect] screen, check that [Wired LAN] is selected.

- **Is the network device (such as a switch, a hub, or a router) turned on?**

#### Solution

Turn on the network device (such as a switch, a hub, or a router).

Also, check that there is no error or malfunction on the network device.

For errors that occur on the network device, refer to the manual of your network device.

- **Is the firmware version for the network device the latest?**

#### Solution

If the firmware version for the network device is not the latest, unexpected operations may occur.

Contact the network administrator to check the firmware version, and consider updating it to the latest version.

For details about how to update the firmware for the network device, refer to the manual of your network device.

- **Is the computer connected to a network device (such as a switch, a hub, or a router)?**

#### Solution

Connect the computer to a network device (such as a switch, a hub, or a router).

For details, refer to the manual of your computer.

- **Did you configure the settings related to communication conditions on a network device (such as a switch, a hub, or a router)?**

#### Solution

When the following are set on the network device (such as a switch, a hub, or a router), take measures accordingly.

- Protocol filter function is enabled.

Allow the protocol which is to be used for communication.

- MAC address filtering is enabled.

Configure the network device (such as a switch, a hub, or a router) with the MAC address of the scanner.

For the settings on the network device, refer to the manual of your network device.

- **Are there any security limitations in the network?**

**Solution**

The access limitations for users may be configured in the network.  
For details, contact the network administrator.

- **Is the network stable?**

**Solution**

Connect to the network after it becomes stable.  
A network can be unstable by the following events:

- A network monitoring program is running.
- A file is transferring.

If the network is unstable, restart the network devices. However, before restarting them, make sure that communications with other devices are not affected if the network devices are restarted. The network devices may become unstable.

- **Are there any security restrictions on the computer?**

**Solution**

In the Windows Firewall settings or in the firewall settings of your security software, unblock the communication of the port numbers which are used by the following software.

- Scanner Selection Tool for fi Series  
Port number: 52217
- Button Event Manager for fi Series  
Port number: 53218

For details about unblocking the communication, refer to the manual or help of your computer or security software.

- **Is the computer connected to a wired LAN?**

**Solution**

Check the connection status of the computer in the following procedure:

- 1 On the touch screen, press  → [Scanner Settings] → [Network] → [Check connection (Ping)].
- 2 In the [Check connection (Ping)] screen, enter the host name or the IP address of the computer, and press the [Run] button.  
The result is displayed.  
Refer to [Connection Test Result \(page 169\)](#) and take measures accordingly.

- **Is the scanner connected to another computer?**

**Solution**

The scanner can be connected to only one computer at a time. Wait until the other computer is disconnected from the scanner, and then connect the computer to be used again.

- **Is the scanner's IP address correct?**

**Solution**

Check the scanner's IP address in the following procedure:

- 1 On the touch screen, press  → [Scanner Settings] → [Network] → [Wired LAN] → [IP Address].
- 2 On the [IP Address] screen, check the setting items.  
When specifying an IP address manually, specify the correct IP address.  
When setting the IP address automatically, check whether the DHCP server functions normally.  
Even when the DHCP server functions normally, an IP address may not be assigned correctly depending on the settings for the DHCP server. Check the operation status and the settings for the DHCP server.

- **Is the IP address of the scanner used for other communication devices?**

**Solution**

If there are multiple communication devices using the same IP address on the same network, communication may fail. Avoid duplicates in IP addresses.

- **Is the DNS server information configured correctly?**

**Solution**

Check the DNS server settings for the scanner in the following procedure:

- 1 On the touch screen, press  → [Scanner Settings] → [Network] → [Wired LAN] → [DNS Server].
- 2 On the [DNS Server] screen, check the setting items for the following.
  - Whether the DNS server settings is enabled
  - Whether the primary DNS and secondary DNS settings are correct

- **Does the DNS server function normally?**

**Solution**

Check whether the DNS server functions normally by following the procedure below.

- 1 On the touch screen, press  → [Scanner Settings] → [Network] → [Check connection (Ping)].
- 2 In the [Check connection (Ping)] screen, enter the IP address of the DNS server, and press the [Run] button.  
The result is displayed.  
Refer to [Connection Test Result \(page 169\)](#) and take measures accordingly.  
If the DNS server does not function normally, contact the DNS server administrator.

- **Is the scanner driver the latest version?**

**Solution**

Update the scanner driver to the latest version.

- **Did you perform a search using the scanner name (host name) and select the scanner in Scanner Selection Tool for fi Series?**

**Solution**

Make sure that the scanner is connected to the network and that the IP address displayed on the window of Scanner Selection Tool for fi Series is correct by following the procedure below.

- 1 Start up the command prompt on the computer where you ran Scanner Selection Tool for fi Series.  
For example, in Windows 10, you can start up the command prompt by clicking [Start] menu → [Windows System] → [Command Prompt].
- 2 Execute the following command.

```
ping ScannerName
```

- 3 In either of the following cases, turn the scanner off then back on.
  - There is no response.
  - The IP address that is returned is different from the IP address displayed on the window of Scanner Selection Tool for fi Series.

## Cannot Connect the Scanner and a Computer via a USB Cable

### Check the following points

- [Is the scanner driver the latest version? \(page 199\)](#)
- [Did you select \[Automatic\] for the USB setting for the scanner? \(page 200\)](#)

If the problem persists, check the items in [Before You Contact the Scanner Service Provider \(page 229\)](#) first, then contact the distributor/dealer where you purchased this product. Refer to the contact information in the Contact List if supplied with this product, or refer to the contact information in the Contact for Inquiries section if provided in Safety Precautions supplied with this product, and then make an inquiry.

- **Is the scanner driver the latest version?**

#### Solution

Update the scanner driver to the latest version.

- **Did you select [Automatic] for the USB setting for the scanner?**

#### Solution

If you select [Automatic] for the USB setting for the scanner, the connection between the scanner and a computer may not be able to be established.

Change the USB setting for the scanner to [USB 2.0] in the following procedure:

- 1 On the touch screen, press  → [Scanner Settings] → [USB].
- 2 Select [USB 2.0].

## Cannot Connect the Scanner to a Destination by Specifying an IP Address

### Check the following points

- Are the scanner and server connected to the network? (page 201)
- Is the scanner's IP address correct? (page 201)
- Is the IP address of the scanner used for other communication devices? (page 202)
- Have you connected another communication device with the same IP address as the scanner to the server in the past? (page 202)
- Is there a firewall device on the same network as the scanner and the server? (page 202)
- Are the settings on the scanner that are related to the server specified correctly? (page 202)
- Are the settings on the server specified correctly? (page 202)

If the problem persists, check the items in [Before You Contact the Scanner Service Provider \(page 229\)](#) first, then contact the distributor/dealer where you purchased this product. Refer to the contact information in the Contact List if supplied with this product, or refer to the contact information in the Contact for Inquiries section if provided in Safety Precautions supplied with this product, and then make an inquiry.

- **Are the scanner and server connected to the network?**

#### Solution

Refer to the following and take measures according to the connection method.

- For Wi-Fi  
[Cannot Connect the Scanner and a Computer via Wi-Fi \(page 178\)](#)
- For a wired LAN  
[Cannot Connect the Scanner and a Computer via a Wired LAN \(page 195\)](#)

- **Is the scanner's IP address correct?**

#### Solution

Check the scanner's IP address in the following procedure:

- 1 On the touch screen, press  → [Scanner Settings] → [Network].
- 2 Perform one of the following according to the connection method.  
For Wi-Fi, press [Wi-Fi] → [IP Address].  
For a wired LAN, press [Wired LAN] → [IP Address].
- 3 On the [IP Address] screen, check the setting items.  
When specifying an IP address manually, specify the correct IP address.  
When setting the IP address automatically, check whether the DHCP server functions normally.

Even when the DHCP server functions normally, an IP address may not be assigned correctly depending on the settings for the DHCP server. Check the operation status and the settings for the DHCP server.

- **Is the IP address of the scanner used for other communication devices?**

**Solution**

If there are multiple communication devices using the same IP address on the same network, communication may fail. Avoid duplicates in IP addresses.

- **Have you connected another communication device with the same IP address as the scanner to the server in the past?**

**Solution**

Communication fails if you connect the scanner to the server and change the preferences settings without turning off the server after the server communicated with another host or communication device with the same IP address as the scanner. Restart the server.

- **Is there a firewall device on the same network as the scanner and the server?**

**Solution**

Check that the access from the scanner is not prohibited by the firewall device.

- **Are the settings on the scanner that are related to the server specified correctly?**

**Solution**

Check the server setting items in the following procedure:

- 1 On the touch screen, press  → [Scanner Settings] → [Network] → [Server].
- 2 Press the server to be connected to, and check the setting items.
  - Whether [Enable] is on.
  - Whether [Host Name/IP address] and [Port Number] are correct.
  - Whether the setting for [Authentication] for a proxy sever is correct.

- **Are the settings on the server specified correctly?**

**Solution**

Refer to the manual for the server and check the settings.

## Cannot Connect the Scanner to a Destination by Specifying a Host Name

### Check the following points

- [Is the DNS server information configured correctly? \(page 203\)](#)
- [Does the DNS server function normally? \(page 203\)](#)
- [Are the scanner and server connected to the network? \(page 204\)](#)
- [Is the scanner's IP address correct? \(page 204\)](#)
- [Is the IP address of the scanner used for other communication devices? \(page 204\)](#)
- [Have you connected another communication device with the same IP address as the scanner to the server in the past? \(page 205\)](#)
- [Is there a firewall device on the same network as the scanner and the server? \(page 205\)](#)
- [Are the settings on the scanner that are related to the server specified correctly? \(page 205\)](#)
- [Are the settings on the server specified correctly? \(page 205\)](#)

If the problem persists, check the items in [Before You Contact the Scanner Service Provider \(page 229\)](#) first, then contact the distributor/dealer where you purchased this product. Refer to the contact information in the Contact List if supplied with this product, or refer to the contact information in the Contact for Inquiries section if provided in Safety Precautions supplied with this product, and then make an inquiry.

- **Is the DNS server information configured correctly?**

### Solution

Check the DNS server settings for the scanner in the following procedure:

- 1 On the touch screen, press  → [Scanner Settings] → [Network].
- 2 Perform one of the following according to the connection method.  
For Wi-Fi, press [Wi-Fi] → [DNS Server].  
For Wired LAN, press [Wired LAN] → [DNS Server].
- 3 On the [DNS Server] screen, check the setting items for the following.
  - Whether the DNS server settings is enabled
  - Whether the primary DNS and secondary DNS settings are correct

- **Does the DNS server function normally?**

### Solution

Check whether the DNS server functions normally by following the procedure below.

- 1 On the touch screen, press  → [Scanner Settings] → [Network] → [Check connection (Ping)].

- 2 In the [Check connection (Ping)] screen, enter the IP address of the DNS server, and press the [Run] button.

The result is displayed.

Refer to [Connection Test Result \(page 169\)](#) and take measures accordingly.

If the DNS server does not function normally, contact the DNS server administrator.

- **Are the scanner and server connected to the network?**

**Solution**

Refer to the following and take measures according to the connection method.

- For Wi-Fi

[Cannot Connect the Scanner and a Computer via Wi-Fi \(page 178\)](#)

- For a wired LAN

[Cannot Connect the Scanner and a Computer via a Wired LAN \(page 195\)](#)

- **Is the scanner's IP address correct?**

**Solution**

Check the scanner's IP address in the following procedure:

- 1 On the touch screen, press  → [Scanner Settings] → [Network].
- 2 Perform one of the following according to the connection method.  
For Wi-Fi, press [Wi-Fi] → [IP Address].  
For a wired LAN, press [Wired LAN] → [IP Address].
- 3 On the [IP Address] screen, check the setting items.  
When specifying an IP address manually, specify the correct IP address.  
When setting the IP address automatically, check whether the DHCP server functions normally.  
Even when the DHCP server functions normally, an IP address may not be assigned correctly depending on the settings for the DHCP server. Check the operation status and the settings for the DHCP server.

- **Is the IP address of the scanner used for other communication devices?**

**Solution**

If there are multiple communication devices using the same IP address on the same network, communication may fail. Avoid duplicates in IP addresses.

- **Have you connected another communication device with the same IP address as the scanner to the server in the past?**

#### **Solution**

Communication fails if you connect the scanner to the server and change the preferences settings without turning off the server after the server communicated with another host or communication device with the same IP address as the scanner. Restart the server.

- **Is there a firewall device on the same network as the scanner and the server?**

#### **Solution**

Check that the access from the scanner is not prohibited by the firewall device.

- **Are the settings on the scanner that are related to the server specified correctly?**

#### **Solution**

Check the server setting items in the following procedure:

- 1 On the touch screen, press  → [Scanner Settings] → [Network] → [Server].
- 2 Press the server to be connected to, and check the setting items.
  - Whether [Enable] is on.
  - Whether [Host Name/IP address] and [Port Number] are correct.
  - Whether the setting for [Authentication] for a proxy sever is correct.

- **Are the settings on the server specified correctly?**

#### **Solution**

Refer to the manual for the server and check the settings.

## Scanning Does Not Start

### Check the following points

- [Is the document loaded in the ADF paper chute \(feeder\) correctly? \(page 206\)](#)
- [Is the ADF closed properly? \(page 206\)](#)
- [Are the scanner and the computer properly connected? \(page 206\)](#)

If the problem persists, check the items in [Before You Contact the Scanner Service Provider \(page 229\)](#) first, then contact the distributor/dealer where you purchased this product. Refer to the contact information in the Contact List if supplied with this product, or refer to the contact information in the Contact for Inquiries section if provided in Safety Precautions supplied with this product, and then make an inquiry.

- **Is the document loaded in the ADF paper chute (feeder) correctly?**

#### Solution

Reload the document in the ADF paper chute (feeder).

- **Is the ADF closed properly?**

#### Solution

Close the ADF firmly.

If the document is caught in the ADF, remove the document and close the ADF.

- **Are the scanner and the computer properly connected?**

#### Solution

- For Wi-Fi  
Connect the scanner and the computer via Wi-Fi. When you cannot connect them via Wi-Fi, refer to [Cannot Connect the Scanner and a Computer via Wi-Fi \(page 178\)](#).
- For a wired LAN  
Connect the scanner and the computer via a wired LAN. When you cannot connect them via a wired LAN, refer to [Cannot Connect the Scanner and a Computer via a Wired LAN \(page 195\)](#).
- For USB  
Connect the USB cable properly. For details, refer to [When Connecting the Scanner to the Computer via a USB Cable \(page 52\)](#).

## Scanning Takes a Long Time

### Check the following points

- If a USB connection is used, is the USB cable connected to the USB 1.1 port on the computer? (page 207)
- Did you start a scan while the computer was unstable (for example, immediately after computer start-up or logon)? (page 207)
- Are the rollers clean? (page 207)
- Does the computer meet the specifications for the system environment used for measuring scan speed? (page 207)

If the problem persists, check the items in [Before You Contact the Scanner Service Provider \(page 229\)](#) first, then contact the distributor/dealer where you purchased this product. Refer to the contact information in the Contact List if supplied with this product, or refer to the contact information in the Contact for Inquiries section if provided in Safety Precautions supplied with this product, and then make an inquiry.

- **If a USB connection is used, is the USB cable connected to the USB 1.1 port on the computer?**

#### Solution

If a USB connection is used, connect the USB cable to the USB 3.1 Gen1/USB 3.0/USB 2.0 port.

- **Did you start a scan while the computer was unstable (for example, immediately after computer start-up or logon)?**

#### Solution

When you start or log onto the computer, wait a while before starting a scan.

- **Are the rollers clean?**

#### Solution

Clean the rollers.

For details, refer to [Cleaning the Inside of the Scanner \(ADF\) with a Cloth \(page 127\)](#).

- **Does the computer meet the specifications for the system environment used for measuring scan speed?**

#### Solution

If the computer does not meet the specifications of the system environment used for measuring scan speed listed in [Basic Specification \(page 325\)](#) (such as CPU and memory), use on a computer that meets the specifications.

## Image Quality Is Poor

### Check the following points

- [Did you configure the settings in the scanner driver to scan in black & white mode? \(page 208\)](#)
- [Are the glass and rollers inside the ADF clean? \(page 208\)](#)

If the problem persists, check the items in [Before You Contact the Scanner Service Provider \(page 229\)](#) first, then contact the distributor/dealer where you purchased this product. Refer to the contact information in the Contact List if supplied with this product, or refer to the contact information in the Contact for Inquiries section if provided in Safety Precautions supplied with this product, and then make an inquiry.

- **Did you configure the settings in the scanner driver to scan in black & white mode?**

### Solution

Use a scanner driver to configure the scan settings that do not "binarize" (output in black and white), and then perform a scan.

The scanned image may differ from the original image significantly if you simply "binarize" (output in black & white) a picture or a photo.

- **Are the glass and rollers inside the ADF clean?**

### Solution

Clean the dirty parts.

For details, refer to [Cleaning the Inside of the Scanner \(ADF\) with a Cloth \(page 127\)](#).

## Quality of Scanned Text or Lines Is Unsatisfactory

### Check the following points

- [Are the glass and rollers inside the ADF clean? \(page 209\)](#)
- [Is the resolution appropriate? \(page 209\)](#)
- [Did you configure the settings in the scanner driver to scan in grayscale or color mode? \(page 209\)](#)
- [Is there any foreign matter \(such as dust or paper dust\) on the document? \(page 209\)](#)

If the problem persists, check the items in [Before You Contact the Scanner Service Provider \(page 229\)](#) first, then contact the distributor/dealer where you purchased this product. Refer to the contact information in the Contact List if supplied with this product, or refer to the contact information in the Contact for Inquiries section if provided in Safety Precautions supplied with this product, and then make an inquiry.

- **Are the glass and rollers inside the ADF clean?**

#### Solution

Clean the dirty parts.

For details, refer to [Cleaning the Inside of the Scanner \(ADF\) with a Cloth \(page 127\)](#).

- **Is the resolution appropriate?**

#### Solution

Specify a higher resolution in the scanner driver.

- **Did you configure the settings in the scanner driver to scan in grayscale or color mode?**

#### Solution

Configure the settings in the scanner driver to scan in black & white mode.

When you scan in grayscale or in color mode, the scanned image may not become sharp and clear.

- **Is there any foreign matter (such as dust or paper dust) on the document?**

#### Solution

Remove any foreign matter off the document.

Foreign matter may get on the glass that is inside the ADF, and cause the image to appear dirty.

## Images Are Distorted or Not Clear

### Check the following points

- Are the glass and rollers inside the ADF clean? (page 210)
- Is the ADF being pushed down during scanning? Or, is there a heavy object on top of the ADF? (page 210)
- Is a scan performed on a place that is unstable or vibrates? (page 210)
- Is the scanner placed on a flat, level surface? Are the rubber pads attached on the bottom of the scanner? (page 210)
- Are there any wrinkles or curls on the document? (page 210)

If the problem persists, check the items in [Before You Contact the Scanner Service Provider \(page 229\)](#) first, then contact the distributor/dealer where you purchased this product. Refer to the contact information in the Contact List if supplied with this product, or refer to the contact information in the Contact for Inquiries section if provided in Safety Precautions supplied with this product, and then make an inquiry.

- **Are the glass and rollers inside the ADF clean?**

#### Solution

Clean the dirty parts.

For details, refer to [Cleaning the Inside of the Scanner \(ADF\) with a Cloth \(page 127\)](#).

- **Is the ADF being pushed down during scanning? Or, is there a heavy object on top of the ADF?**

#### Solution

Do not push down the top of the ADF, or place any heavy objects on the ADF during scanning.

- **Is a scan performed on a place that is unstable or vibrates?**

#### Solution

Perform a scan on a place that is stable and does not vibrate.

- **Is the scanner placed on a flat, level surface? Are the rubber pads attached on the bottom of the scanner?**

#### Solution

Place the scanner on a flat and level surface.

Or, attach the rubber pads on the bottom of the scanner.

- **Are there any wrinkles or curls on the document?**

#### Solution

Smooth out the wrinkles or curls on the document.

## Vertical Streaks Appear on the Images

### Check the following points

- [Are the glass and rollers inside the ADF clean? \(page 211\)](#)
- [Is there any foreign matter \(such as dust or paper dust\) on the document? \(page 211\)](#)
- [Is \[Vertical Streaks Reduction\] enabled in the scanner driver for a scan? \(page 211\)](#)

If the problem persists, check the items in [Before You Contact the Scanner Service Provider \(page 229\)](#) first, then contact the distributor/dealer where you purchased this product. Refer to the contact information in the Contact List if supplied with this product, or refer to the contact information in the Contact for Inquiries section if provided in Safety Precautions supplied with this product, and then make an inquiry.

- **Are the glass and rollers inside the ADF clean?**

#### Solution

Clean the dirty parts.

For details, refer to [Cleaning the Inside of the Scanner \(ADF\) with a Cloth \(page 127\)](#).

- **Is there any foreign matter (such as dust or paper dust) on the document?**

#### Solution

Remove any foreign matter off the document.

Foreign matter may get on the glass that is inside the ADF, and cause the image to appear dirty.

- **Is [Vertical Streaks Reduction] enabled in the scanner driver for a scan?**

#### Solution

Enable [Vertical Streaks Reduction] in the scanner driver, and then perform a scan.

## Error Code "U4:40" Is Displayed on the Touch Screen While Scanning

### Check the following points

- [Is the ADF closed firmly? \(page 212\)](#)

If the problem persists, check the items in [Before You Contact the Scanner Service Provider \(page 229\)](#) first, then contact the distributor/dealer where you purchased this product. Refer to the contact information in the Contact List if supplied with this product, or refer to the contact information in the Contact for Inquiries section if provided in Safety Precautions supplied with this product, and then make an inquiry.

- **Is the ADF closed firmly?**

### Solution

Close the ADF firmly.

For details, refer to [How to Close the ADF \(page 68\)](#).

## Overlapped Documents Are Frequently Fed into the Scanner

### Check the following points

- Do the documents meet the paper requirements? (page 213)
- Are you using the Carrier Sheet? (page 213)
- If the setting to detect overlapped documents is enabled, do the documents fulfill the conditions to detect overlapped documents accurately? (page 213)
- Did you scan a thick document such as a plastic card? (page 214)
- Did you fan the documents before loading them? (page 214)
- Have the documents just been printed out from a copy machine or a laser printer? (page 214)
- Are the brake roller and pick roller installed correctly? (page 214)
- Are the brake roller and pick roller clean? (page 214)
- Are the brake roller and pick roller worn out? (page 214)
- Are you using the scanner at an altitude of 2,000 m or higher? (page 215)

If the problem persists, check the items in [Before You Contact the Scanner Service Provider \(page 229\)](#) first, then contact the distributor/dealer where you purchased this product. Refer to the contact information in the Contact List if supplied with this product, or refer to the contact information in the Contact for Inquiries section if provided in Safety Precautions supplied with this product, and then make an inquiry.

- **Do the documents meet the paper requirements?**

#### Solution

Use documents that meet the requirements.

For details, refer to [Documents for Scanning \(page 87\)](#).

- **Are you using the Carrier Sheet?**

#### Solution

Configure the scan settings in the scanner driver to use the Carrier Sheet.

For details, refer to [Scanning Photographs and Clippings \(page 109\)](#).

- **If the setting to detect overlapped documents is enabled, do the documents fulfill the conditions to detect overlapped documents accurately?**

#### Solution

Fulfill the conditions to detect overlapped documents accurately.

For details, refer to [Conditions Required to Accurately Detect Overlapped Documents \(Multifeed\) \(page 93\)](#).

If necessary, specify the area to detect overlapped documents.

For details, refer to [Specifying the Area to Detect Overlapped Documents \[Document check area specification for Multifeed Detection\] \(page 307\)](#).

- **Did you scan a thick document such as a plastic card?**

#### Solution

Perform one of the following for a scan:

- Use the intelligent multifeed detection function.
- Disable the setting to detect overlapped documents by the ultrasonic sensor.
- Scan with Manual Single Mode.

- **Did you fan the documents before loading them?**

#### Solution

Fan the documents.

For details, refer to [Preparation \(page 83\)](#).

- **Have the documents just been printed out from a copy machine or a laser printer?**

#### Solution

Fan the documents a few times to remove static electricity.

For details, refer to [Preparation \(page 83\)](#).

- **Are the brake roller and pick roller installed correctly?**

#### Solution

Install the brake roller and pick roller correctly.

For details, refer to [Replacing the Brake Roller \(page 135\)](#) and [Replacing the Pick Roller \(page 140\)](#).

- **Are the brake roller and pick roller clean?**

#### Solution

Clean the brake roller and pick roller.

For details, refer to [Cleaning the Inside of the Scanner \(ADF\) with a Cloth \(page 127\)](#).

- **Are the brake roller and pick roller worn out?**

#### Solution

Check the counters for the brake roller and pick roller in the [Consumable counters] screen on the touch screen, and replace the brake roller and pick roller if necessary.

The procedure to display the [Consumable counters] screen is as follows:



→ [Cleaning & Maintenance] → [Consumable counters]

When using the Software Operation Panel, refer to [Checking the Sheet Counter \(page 280\)](#).

For details about replacing the brake roller and pick roller, refer to [Replacing the Brake Roller \(page 135\)](#) and [Replacing the Pick Roller \(page 140\)](#).

- Are you using the scanner at an altitude of 2,000 m or higher?

#### Solution

In the [High Altitude Mode] screen on the touch screen, set [Enable] to on.

The [High Altitude Mode] screen can be displayed in the following procedure:



→ [Scanner Settings] → [Paper Source/Feeding] → [High Altitude Mode]

When using the Software Operation Panel, refer to [Scanning at High Altitude \[High Altitude Mode\] \(page 302\)](#).

If the scanner is being used on level ground lower than 2,000 m with [High Altitude Mode] enabled, overlapped documents may not be detected.

## Situation in Which the Document Is not Fed into the ADF Occurs Frequently

### Check the following points

- [Do the documents meet the paper requirements? \(page 216\)](#)
- [Did you fan the documents before loading them? \(page 216\)](#)
- [Are the brake roller and pick roller installed correctly? \(page 216\)](#)
- [Are the brake roller and pick roller clean? \(page 216\)](#)
- [Are the brake roller and pick roller worn out? \(page 217\)](#)

If the problem persists, check the items in [Before You Contact the Scanner Service Provider \(page 229\)](#) first, then contact the distributor/dealer where you purchased this product. Refer to the contact information in the Contact List if supplied with this product, or refer to the contact information in the Contact for Inquiries section if provided in Safety Precautions supplied with this product, and then make an inquiry.

- **Do the documents meet the paper requirements?**

#### Solution

Use documents that meet the requirements.

For details, refer to [Documents for Scanning \(page 87\)](#).

- **Did you fan the documents before loading them?**

#### Solution

Fan the documents.

For details, refer to [Preparation \(page 83\)](#).

- **Are the brake roller and pick roller installed correctly?**

#### Solution

Install the brake roller and pick roller correctly.

For details, refer to [Replacing the Brake Roller \(page 135\)](#) and [Replacing the Pick Roller \(page 140\)](#).

- **Are the brake roller and pick roller clean?**

#### Solution

Clean the brake roller and pick roller.

For details, refer to [Cleaning the Inside of the Scanner \(ADF\) with a Cloth \(page 127\)](#).

- Are the brake roller and pick roller worn out?

#### Solution

Check the counters for the brake roller and pick roller in the [Consumable counters] screen on the touch screen, and replace the brake roller and pick roller if necessary.

The procedure to display the [Consumable counters] screen is as follows:



→ [Cleaning & Maintenance] → [Consumable counters]

When using the Software Operation Panel, refer to [Checking the Sheet Counter \(page 280\)](#).

For details about replacing the brake roller and pick roller, refer to [Replacing the Brake Roller \(page 135\)](#) and [Replacing the Pick Roller \(page 140\)](#).

## Paper Protection Is Set Off Frequently

### Check the following points

- Do the documents meet the paper requirements? (page 218)
- Is there any foreign matter in the ADF? (page 218)
- Are the brake roller and pick roller installed correctly? (page 218)
- Are the brake roller and pick roller clean? (page 218)
- Are the brake roller and pick roller worn out? (page 219)
- Is the sensitivity level for the paper protection function set to high in the touch screen or the Software Operation Panel? (page 219)

If the problem persists, check the items in [Before You Contact the Scanner Service Provider \(page 229\)](#) first, then contact the distributor/dealer where you purchased this product. Refer to the contact information in the Contact List if supplied with this product, or refer to the contact information in the Contact for Inquiries section if provided in Safety Precautions supplied with this product, and then make an inquiry.

- **Do the documents meet the paper requirements?**

#### Solution

Use documents that meet the requirements.

For details, refer to [Documents for Scanning \(page 87\)](#).

- **Is there any foreign matter in the ADF?**

#### Solution

Clean the ADF.

Remove any foreign matter from the ADF.

For details, refer to [Cleaning the Inside of the Scanner \(ADF\) with a Cloth \(page 127\)](#).

- **Are the brake roller and pick roller installed correctly?**

#### Solution

Install the brake roller and pick roller correctly.

For details, refer to [Replacing the Brake Roller \(page 135\)](#) and [Replacing the Pick Roller \(page 140\)](#).

- **Are the brake roller and pick roller clean?**

#### Solution

Clean the brake roller and pick roller.

For details, refer to [Cleaning the Inside of the Scanner \(ADF\) with a Cloth \(page 127\)](#).

- **Are the brake roller and pick roller worn out?**

#### **Solution**

Check the counters for the brake roller and pick roller in the [Consumable counters] screen on the touch screen, and replace the brake roller and pick roller if necessary.

The procedure to display the [Consumable counters] screen is as follows:



→ [Cleaning & Maintenance] → [Consumable counters]

When using the Software Operation Panel, refer to [Checking the Sheet Counter \(page 280\)](#).

For details about replacing the brake roller and pick roller, refer to [Replacing the Brake Roller \(page 135\)](#) and [Replacing the Pick Roller \(page 140\)](#).

- **Is the sensitivity level for the paper protection function set to high in the touch screen or the Software Operation Panel?**

#### **Solution**

In the [Paper protection] screen on the touch screen, select [Low] for [Feeding Accuracy Sensitivity] and [Feeding Noise Sensitivity].

The [Paper protection] screen can be displayed in the following procedure:



→ [Scanner Settings] → [Paper Protection] → [Paper protection] or, [Paper Protection (Touch Screen Settings)].

When using the Software Operation Panel, refer to [Specifying the Sensitivity Level for Paper Protection \[Paper Protection Sensitivity\] \(page 300\)](#).

## Paper Jams/Pick Errors Occur Frequently

### Check the following points

- [Do the documents meet the paper requirements? \(page 220\)](#)
- [Is there any foreign matter in the ADF? \(page 220\)](#)
- [Are the brake roller and pick roller installed correctly? \(page 220\)](#)
- [Are the brake roller and pick roller clean? \(page 220\)](#)
- [Are the brake roller and pick roller worn out? \(page 221\)](#)

If the problem persists, check the items in [Before You Contact the Scanner Service Provider \(page 229\)](#) first, then contact the distributor/dealer where you purchased this product. Refer to the contact information in the Contact List if supplied with this product, or refer to the contact information in the Contact for Inquiries section if provided in Safety Precautions supplied with this product, and then make an inquiry.

- **Do the documents meet the paper requirements?**

#### Solution

Use documents that meet the requirements.

For details, refer to [Documents for Scanning \(page 87\)](#).

- **Is there any foreign matter in the ADF?**

#### Solution

Clean the ADF.

Remove any foreign matter from the ADF.

For details, refer to [Cleaning the Inside of the Scanner \(ADF\) with a Cloth \(page 127\)](#).

- **Are the brake roller and pick roller installed correctly?**

#### Solution

Install the brake roller and pick roller correctly.

For details, refer to [Replacing the Brake Roller \(page 135\)](#) and [Replacing the Pick Roller \(page 140\)](#).

- **Are the brake roller and pick roller clean?**

#### Solution

Clean the brake roller and pick roller.

For details, refer to [Cleaning the Inside of the Scanner \(ADF\) with a Cloth \(page 127\)](#).

- Are the brake roller and pick roller worn out?

#### Solution

Check the counters for the brake roller and pick roller in the [Consumable counters] screen on the touch screen, and replace the brake roller and pick roller if necessary.

The procedure to display the [Consumable counters] screen is as follows:



→ [Cleaning & Maintenance] → [Consumable counters]

When using the Software Operation Panel, refer to [Checking the Sheet Counter \(page 280\)](#).

For details about replacing the brake roller and pick roller, refer to [Replacing the Brake Roller \(page 135\)](#) and [Replacing the Pick Roller \(page 140\)](#).

## Images Turn Out Elongated

### Check the following points

- [Are the rollers clean? \(page 222\)](#)
- [Do the documents meet the paper requirements? \(page 222\)](#)
- [Are the brake roller and pick roller installed correctly? \(page 222\)](#)
- [Have you adjusted the magnification level? \(page 222\)](#)

If the problem persists, check the items in [Before You Contact the Scanner Service Provider \(page 229\)](#) first, then contact the distributor/dealer where you purchased this product. Refer to the contact information in the Contact List if supplied with this product, or refer to the contact information in the Contact for Inquiries section if provided in Safety Precautions supplied with this product, and then make an inquiry.

- **Are the rollers clean?**

#### Solution

Clean the rollers.

For details, refer to [Cleaning the Inside of the Scanner \(ADF\) with a Cloth \(page 127\)](#).

- **Do the documents meet the paper requirements?**

#### Solution

Use documents that meet the requirements.

For details, refer to [Documents for Scanning \(page 87\)](#).

- **Are the brake roller and pick roller installed correctly?**

#### Solution

Install the brake roller and pick roller correctly.

For details, refer to [Replacing the Brake Roller \(page 135\)](#) and [Replacing the Pick Roller \(page 140\)](#).

- **Have you adjusted the magnification level?**

#### Solution

In the [Magnification] screen on the touch screen, adjust the magnification level for feed direction.

The [Magnification] screen can be displayed in the following procedure:



→ [Scanner Settings] → [Image] → [Magnification]

When using the Software Operation Panel, refer to [Adjusting the Position to Start the Scan \[Offset Setting/Vertical magnification Adjustment\] \(page 286\)](#).

## A Shadow Appears at the Top or the Bottom of the Image

### Check the following points

- [Have you adjusted the offset \(position to start the scan\)? \(page 223\)](#)
- [Did you use the page edge filler function to fill in the shadow around the edge? \(page 223\)](#)

If the problem persists, check the items in [Before You Contact the Scanner Service Provider \(page 229\)](#) first, then contact the distributor/dealer where you purchased this product. Refer to the contact information in the Contact List if supplied with this product, or refer to the contact information in the Contact for Inquiries section if provided in Safety Precautions supplied with this product, and then make an inquiry.

- **Have you adjusted the offset (position to start the scan)?**

### Solution

In the [Offset] screen on the touch screen, adjust the offset for [Sub-scan ADF front] and [Sub-scan ADF back].

The [Offset] screen can be displayed in the following procedure:



→ [Scanner Settings] → [Image] → [Offset]

When using the Software Operation Panel, refer to [Adjusting the Position to Start the Scan \[Offset Setting/Vertical magnification Adjustment\] \(page 286\)](#).

- **Did you use the page edge filler function to fill in the shadow around the edge?**

### Solution

In the [Page Edge Filler Area] screen on the touch screen, fill in the shadow around the edge.

The [Page Edge Filler Area] screen can be displayed in the following procedure:



→ [Scanner Settings] → [Image] → [Page Edge Filler Area]

When using the Software Operation Panel, refer to [Removing Shadows/Streaks that Appear around Edges of Images \[Page Edge Filler \(ADF\)\] \(page 289\)](#).

For the settings in the scanner driver, refer to the scanner driver's Help.

## There Are Black Traces on the Document

### Check the following points

- [Are you scanning documents written in lead pencil or carbon paper? \(page 224\)](#)
- [Are the glass and rollers inside the ADF clean? \(page 224\)](#)

If the problem persists, check the items in [Before You Contact the Scanner Service Provider \(page 229\)](#) first, then contact the distributor/dealer where you purchased this product. Refer to the contact information in the Contact List if supplied with this product, or refer to the contact information in the Contact for Inquiries section if provided in Safety Precautions supplied with this product, and then make an inquiry.

- **Are you scanning documents written in lead pencil or carbon paper?**

### Solution

When you scan documents written in lead pencil, make sure you clean the rollers frequently. Otherwise, the rollers will be contaminated which may leave black traces on the document or cause feeding errors.

For details, refer to [Cleaning the Inside of the Scanner \(ADF\) with a Cloth \(page 127\)](#).

- **Are the glass and rollers inside the ADF clean?**

### Solution

Clean the dirty parts.

For details, refer to [Cleaning the Inside of the Scanner \(ADF\) with a Cloth \(page 127\)](#).

## The Carrier Sheet Is Not Fed Smoothly/Paper Jams Occur

### Check the following points

- Did you scan just the Carrier Sheet continuously? (page 225)
- Is the Carrier Sheet clean? (page 225)
- Did you start the scan after loading the Carrier Sheet in the ADF paper chute (feeder)? (page 225)
- Are the glass and rollers inside the ADF clean? (page 226)
- Are the brake roller and pick roller worn out? (page 226)
- Is there any foreign matter in the ADF? (page 226)
- Did you place a thick document inside the Carrier Sheet? (page 226)

If the problem persists, check the items in [Before You Contact the Scanner Service Provider \(page 229\)](#) first, then contact the distributor/dealer where you purchased this product. Refer to the contact information in the Contact List if supplied with this product, or refer to the contact information in the Contact for Inquiries section if provided in Safety Precautions supplied with this product, and then make an inquiry.

- **Did you scan just the Carrier Sheet continuously?**

#### Solution

Feed about 50 sheets of PPC paper (recycled paper) before scanning with the Carrier Sheet. The PPC paper can either be blank or printed.

- **Is the Carrier Sheet clean?**

#### Solution

Perform one of the following.

- Clean the Carrier Sheet.  
For details, refer to [Cleaning the Carrier Sheet \(page 132\)](#).
- Replace the Carrier Sheet.  
For information on purchasing the Carrier Sheets, contact the distributor/dealer where you purchased this product. Refer to the contact information in the Contact List if supplied with this product, or refer to the contact information in the Contact for Inquiries section if provided in Safety Precautions supplied with this product, and then make an inquiry.

- **Did you start the scan after loading the Carrier Sheet in the ADF paper chute (feeder)?**

#### Solution

Start the scan after loading the Carrier Sheet in the ADF paper chute (feeder).  
For details, refer to [Scanning Photographs and Clippings \(page 109\)](#).

- **Are the glass and rollers inside the ADF clean?**

**Solution**

Clean the dirty parts.

For details, refer to [Cleaning the Inside of the Scanner \(ADF\) with a Cloth \(page 127\)](#).

- **Are the brake roller and pick roller worn out?**

**Solution**

Check the counters for the brake roller and pick roller in the [Consumable counters] screen on the touch screen, and replace the brake roller and pick roller if necessary.

The procedure to display the [Consumable counters] screen is as follows:



→ [Cleaning & Maintenance] → [Consumable counters]

When using the Software Operation Panel, refer to [Checking the Sheet Counter \(page 280\)](#).

For details about replacing the brake roller and pick roller, refer to [Replacing the Brake Roller \(page 135\)](#) and [Replacing the Pick Roller \(page 140\)](#).

- **Is there any foreign matter in the ADF?**

**Solution**

Clean the ADF.

Remove any foreign matter from the ADF.

For details, refer to [Cleaning the Inside of the Scanner \(ADF\) with a Cloth \(page 127\)](#).

- **Did you place a thick document inside the Carrier Sheet?**

**Solution**

Some papers may be too thick to place inside the Carrier Sheet.

Use documents that meet the requirements.

For details, refer to [Conditions for Using the Carrier Sheet \(page 99\)](#).

## Part of the Image Appears Missing in the Case Where the Carrier Sheet Is Used

### Check the following points

- Did you place several small documents (such as photos or postcards) in the Carrier Sheet for scanning? (page 227)
- Does the fold line of the document hang off the Carrier Sheet? (page 227)

If the problem persists, check the items in [Before You Contact the Scanner Service Provider \(page 229\)](#) first, then contact the distributor/dealer where you purchased this product. Refer to the contact information in the Contact List if supplied with this product, or refer to the contact information in the Contact for Inquiries section if provided in Safety Precautions supplied with this product, and then make an inquiry.

- **Did you place several small documents (such as photos or postcards) in the Carrier Sheet for scanning?**

#### Solution

Place only one document (such as a photo or postcard) at a time in the Carrier Sheet.

- **Does the fold line of the document hang off the Carrier Sheet?**

#### Solution

Part of the image around where the document is folded may appear missing.

Place the document so its fold line is set about 1 mm inside from the edge of the Carrier Sheet.

## An Error Occurs When Entering the Default Administrator Password

### Check the following points

[Is the default administrator password that you entered correct? \(page 228\)](#)

If the problem persists, check the items in [Before You Contact the Scanner Service Provider \(page 229\)](#) first, then contact the distributor/dealer where you purchased this product. Refer to the contact information in the Contact List if supplied with this product, or refer to the contact information in the Contact for Inquiries section if provided in Safety Precautions supplied with this product, and then make an inquiry.

- **Is the default administrator password that you entered correct?**

### Solution

You can check the default administrator password by checking whether there is a label or not. For details about the label, refer to [Checking the Product Label \(page 231\)](#).

## Before You Contact the Scanner Service Provider

Please check the following items before contacting the distributor/dealer where you purchased this product.

- [General \(page 229\)](#)
- [Error Status \(page 229\)](#)

### General

Item	Findings
Scanner name	Example: fi-7300NX For details, refer to <a href="#">Checking the Product Label (page 231)</a> .
Serial No.	Example: XXXX000001 For details, refer to <a href="#">Checking the Product Label (page 231)</a> .
Date of manufacture	Example: 20XX-01 (January 20XX) For details, refer to <a href="#">Checking the Product Label (page 231)</a> .
Date of purchase	
Symptom	
Frequency of trouble	
Warranty	
Options used	

### Error Status

- **Computer Connection Issues**

Item	Findings
Operating system (Windows)	
Error message	
Interface	Example: USB interface
Interface controller	
Connection method	Example: Wi-Fi

● **Feeding Issues**

Item	Findings
Paper type	
Main purpose of use	
Date of last cleaning	
Date of consumable replacement	
Touch screen status	

● **Image Quality Issues**

Item	Findings
Scanner driver and version	
Interface controller	
Operating system (Windows)	
Application	Example: PaperStream ClickScan
Scanning sides	Example: front, back, both
Resolution	Example: 600 dpi, 75 dpi
Image mode	Example: color, grayscale, black & white

● **Other**

Item	Findings
Can you send the output image and a photo that shows the paper condition by e-mail or fax?	

## Checking the Product Label

This section explains about the product label on the scanner.

The label is located on the place indicated in the following figure:  
Remove the ADF paper chute (feeder) to check it.

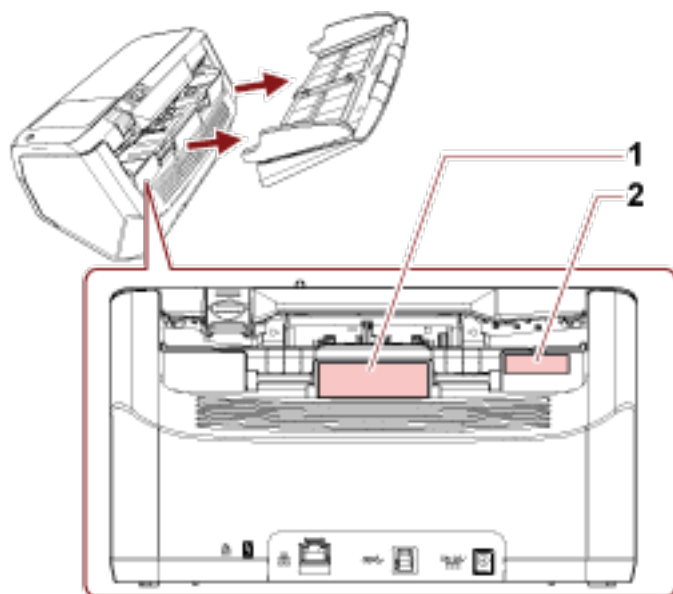

### Label 1 (example)

Shows the scanner information.



### Label 2 (example)

Shows the default administrator password. The xxxxxxxx (8-digit number) part is the password.

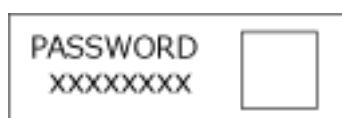

If there is no label, the default administrator password is "password".

# Scanner Settings (Touch Screen)

This section explains how to use the touch screen to configure the scanner settings.

## TIP

Some setting items can also be configured from the Software Operation Panel. For details, refer to [Scanner Settings \(Software Operation Panel\) \(page 262\)](#).

## Setting Items

The scanner settings can be changed in [Scanner Settings] on the screen that appears when you press



in the lower right of the touch screen.

This section shows a list of setting items that you can configure.

## ATTENTION

To change the scanner settings, the administrator password is required.

You can check the default administrator password by checking whether there is a label or not.

For details about the label, refer to [Checking the Product Label \(page 231\)](#).

Change the administrator password to prevent the settings from being changed by other users.

Also, change the administrator password regularly.

The administrator password can be changed in the screen that appears in the following procedure:



→ [Scanner Settings] → [Admin Password]

Setting Items		Description
<a href="#">How to connect (page 235)</a>		Specify a connection method for the scanner.
<a href="#">Power Management (page 236)</a>	<a href="#">Startup mode (page 236)</a>	Specify a startup mode for the scanner.
	<a href="#">Power Save Mode (page 236)</a>	You can specify the waiting time for the scanner to automatically enter power saving mode or to be automatically turned off if it is left on for a certain period of time without being used.
	<a href="#">Power Button (page 237)</a>	Specify whether or not to turn on/off the scanner by pressing the [Power] button on the scanner.
<a href="#">Scanner Name (page 238)</a>		Set a scanner name.
<a href="#">Scanner Code (page 238)</a>		Specify whether or not to issue a scanner code.

Setting Items		Description
		If the "PaperStream NX Manager" setting is enabled, a scanner code can be used when scanning with a user application on a computer or mobile device.
Network (page 239)	Wi-Fi (page 239)	Configure the settings for Wi-Fi.
	Wired LAN (page 240)	Configure the settings for wired LAN.
	Server (page 242)	Configure the settings for a server, which is to be connected to the scanner.
	Network Encryption (page 244)	Specify whether to encrypt network communications.
	Check connection (Ping) (page 245)	Check the communication status between the scanner and the connected computer.
Paper Source/Feeding (page 246)	Pre-Pick (page 246)	Enable this to shorten the scanning time when scanning continuously.
	Retry Paper Feeding (page 246)	Specify the number of feeding retries when a document is not fed from the ADF paper chute (feeder).
	Multifeed Detection (page 246)	Configure the settings to detect overlapped documents during a scan.
	Multifeed Detection Area (page 248)	Specify an area to detect overlapped documents.
	Intelligent Multifeed Detection (page 249)	Configure the setting to automatically ignore certain patterns of overlapped documents when the setting to detect overlapped documents is enabled.
	Manual Feeding (page 250)	Configure the settings when manually loading and scanning one sheet at a time.
	High Altitude Mode (page 251)	Enable this mode to use the scanner at an altitude of 2,000 m or higher.
Paper Protection (page 252)	Paper protection (page 252)	Configure the setting to detect feeding errors.
	Paper Protection (Touch Screen Settings) (page 253)	Enable this option when you want some settings to be prioritized over the settings for [Paper Protection] and the Software Operation Panel.
	Prioritize the touch screen settings (page 253)	

Setting Items		Description
Image (page 255)	Automatic Page Size Detection (page 255)	When the scanner is set to detect the paper size automatically, specify whether or not to optimize (round up/down) the fractional part of the scanned image.
	Page Edge Filler Area (page 255)	Configure the settings to fill in the shadow or streaks around the edge of the scanned image.
	Dropout Color (page 257)	You can exclude a color from being scanned by selecting either red, green, or blue (three primary colors).
	Offset (page 257)	Specify a starting position for scanning.
	Magnification (page 258)	Specify the magnification level for the feed direction.
	Image Quality Mode (page 258)	To obtain an image quality that is close to the image quality for scanning with fi-6130Z, set the image quality mode.
Cleaning & Maintenance (page 259)	Cleaning cycle (page 259)	Specify the cleaning cycle for the scanner inside.
	Replacement of the Pick Roller (page 259)	Specify the replacement cycle for the pick roller.
	Replacement of the Brake Roller (page 259)	Specify the replacement cycle for the brake roller
	Maintenance cycle (page 260)	Specify the maintenance and inspection cycle for the scanner that is performed by a service engineer.
USB (page 260)		Specify how the USB function operates.
Admin Password (page 260)		Change or disable the administrator password.
Restore Factory Defaults (page 261)		Restore the scanner settings to the factory default.

**ATTENTION**

You cannot back up or restore the scanner settings on the touch screen.

---

## How to connect

### How to connect

Specify a connection method for the scanner.

- Wi-Fi
- Wired LAN
- USB

### Continue with the Settings

When [Continue with the Settings] is set to on, you can configure the necessary information for the connection after this setting.

---

## Power Management

### Startup mode

Specify a startup mode for the scanner.

- **Fast**  
The scanner enters power saving mode by pressing the [Power] button for 2 seconds or more.  
The scanner can perform a scan immediately when it resumes from power saving mode.
- **Normal**  
The scanner is turned off by pressing the [Power] button for 2 seconds or more.  
This is the factory default setting.

#### **ATTENTION**

If you select [Fast], the scanner is not turned off regardless of the [Auto Shutdown hours] in [Power Save Mode].

The scanner's energy consumption will increase.

### Power Save Mode

You can specify the waiting time for the scanner to automatically enter power saving mode or to be automatically turned off if it is left on for a certain period of time without being used.

#### Power Save minutes

Specify the waiting time before the scanner enters power saving mode.  
The factory default setting is "15".

#### Auto Shutdown hours

Specify the waiting time before the scanner turns off automatically.

- Disabled (Never)
- 1
- 2
- 4  
This is the factory default setting.
- 8

#### **ATTENTION**

- If [Fast] is selected for [Startup mode], this setting will be ignored.
- If [Disable Power Button] is selected for [Power Button], this setting will be ignored.

**TIP**

When [Disabled] is set, the scanner's energy consumption will increase.

**Power Button**

Specify whether or not to turn on/off the scanner by pressing the [Power] button on the scanner.

- **Enable Power Button**

The [Power] button on the scanner is used to turn on/off the scanner.  
This is the factory default setting.

- **Disable Power Button**

Select this to use an AC power strip to control power supply for peripherals such as a scanner in accordance with the computer's power.  
The [Power] button on the scanner is not used to turn on/off the scanner.

**Enable USB Power**

You can configure the setting when selecting [Enable Power Button] and connecting the scanner and the computer via a USB cable.

Usually, the scanner turns on/off by pressing the [Power] button on the scanner. However, if you set [Enable USB Power] to on, turning on/off the computer simultaneously turns on/off the scanner.

Connecting/disconnecting a USB cable can turn on/off the scanner.

**ATTENTION**

Some types of computers and USB hubs keep supplying power to the USB bus even after the computer is turned off.

In that case, [Enable USB Power] may not work properly.

**TIP**

When [Disable Power Button] is set, the scanner's energy consumption will increase.

---

## Scanner Name

### Scanner name

Set a scanner name.

Enter a scanner name within 64 characters.

The following characters can be used for a scanner name:

- Alphanumerical characters
- Hyphen "-"
- Underscore "\_"
- Space

The space before or after the character string is ignored.

#### TIP

When [Dynamic DNS] is enabled, it is recommended that you do not use the following characters in a scanner name. For details, refer to [Dynamic DNS \(page 240\)](#).

- Underscore "\_"
- Space

---

## Scanner Code

### Scanner Code

Specify whether or not to issue a scanner code.

If the "PaperStream NX Manager" setting is enabled, a scanner code can be used when scanning with a user application on a computer or mobile device.

#### Enable

[Enable] is set to off as the factory default.

When [Enable] is set to on, make sure you enter characters for [Code].

#### Code

Enter a code within 64 characters.

All characters that are available on the touch screen on the scanner can be used.

The space before or after the character string is ignored.

---

## Network

You can configure the setting when selecting [Wi-Fi] or [Wired LAN] for [How to connect].

### Wi-Fi

Configure the settings for Wi-Fi.

You can configure the setting when selecting [Wi-Fi] for [How to connect].

### Access Point

Select a setting method when connecting via Wi-Fi.

The factory default setting is [Select an Access Point].

- Select an Access Point

Select a wireless access point from a list of access points to establish a connection.

Press the [Start] button to start specifying the Wi-Fi setting.

For details about the setting items after you select this, refer to [Connecting to a Wireless Access Point by Selecting One from the List of Wireless Access Points \(page 41\)](#).

- Use WPS

Specify the setting by using WPS of the wireless access point.

Press the [Start] button to start specifying the Wi-Fi setting.

For details about the setting items after you select this, refer to [Connecting to a Wireless Access Point by Pressing the WPS Button \(page 42\)](#) or [Connecting to a Wireless Access Point by Entering the PIN for WPS \(page 43\)](#).

- Configure manually

Manually configure the information for the wireless access point.

Press the [Start] button to start specifying the Wi-Fi setting.

For details about the setting items after you select this, refer to [When Establishing a Connection by Entering the Information for the Wireless Access Point \(page 44\)](#).

### IP Address

#### Obtain IP Address

Set an IP address for the scanner.

- Obtain automatically (DHCP)

This is the factory default setting.

- Configure manually

When [Configure manually] is selected, specify the following items:

- IP Address

- Subnet Mask

- Default Gateway

## DNS Server

### Enable

When you set an IP address manually, specify a DNS server.

[Enable] is set to off as the factory default.

When [Enable] is set to on, specify the following items:

- Primary DNS
- Secondary DNS

## Dynamic DNS

### Enable

Set this item to obtain an IP address automatically.

Enable this option when you want to specify a scanner name (host name) and search for a scanner in Scanner Selection Tool for fi Series.

[Enable] is set to off as the factory default.

When [Enable] is set to on and a scanner is connected to a network, a scanner name (host name) and an IP address will be automatically registered in a DNS server.

You can specify a scanner name (host name) to be registered in a DNS server for [Scanner name] in [Scanner Settings]. For details, refer to [Scanner Name \(page 238\)](#).

#### TIP

If you enter a blank space or "\_" for [Scanner name], it is converted to "-" and registered in a DNS server.

Even if the IP address assigned by the DHCP server has been changed, the scanner name (host name) registered in the DNS server can still be used to search for the scanner.

For details about searching for a scanner, refer to the Scanner Selection Tool for fi Series Help.

For details about how to start up Scanner Selection Tool for fi Series, refer to [Starting Up Scanner Selection Tool for fi Series \(page 331\)](#).

## Wi-Fi Diagnosis

Check the Wi-Fi connection status for the scanner.

### [Diagnosis] button

The diagnosis is displayed.

## Wired LAN

Configure the settings for wired LAN.

You can configure the setting when selecting [Wired LAN] for [How to connect].

## IP Address

### Obtain IP Address

Set an IP address for the scanner.

- Obtain automatically (DHCP)  
This is the factory default setting.

- Configure manually

When [Configure manually] is selected, specify the following items:

- IP Address
- Subnet Mask
- Default Gateway

## DNS Server

### Enable

When you set an IP address manually, specify a DNS server.

[Enable] is set to off as the factory default.

When [Enable] is set to on, specify the following items:

- Primary DNS
- Secondary DNS

## Dynamic DNS

### Enable

Set this item to obtain an IP address automatically.

Enable this option when you want to specify a scanner name (host name) and search for a scanner in Scanner Selection Tool for fi Series.

[Enable] is set to off as the factory default.

When [Enable] is set to on and a scanner is connected to a network, a scanner name (host name) and an IP address will be automatically registered in a DNS server.

You can specify a scanner name (host name) to be registered in a DNS server for [Scanner name] in [Scanner Settings]. For details, refer to [Scanner Name \(page 238\)](#).

#### TIP

If you enter a blank space or "\_" for [Scanner name], it is converted to "-" and registered in a DNS server.

Even if the IP address assigned by the DHCP server has been changed, the scanner name (host name) registered in the DNS server can still be used to search for the scanner.

For details about searching for a scanner, refer to the Scanner Selection Tool for fi Series Help.

For details about how to start up Scanner Selection Tool for fi Series, refer to [Starting Up Scanner Selection Tool for fi Series \(page 331\)](#).

## Server

Configure the settings for a server, which is to be connected to the scanner.

### Proxy Server

#### Enable

Set this item to use a proxy server.

[Enable] is set to off as the factory default.

When [Enable] is set to on, specify the following items:

- Host Name/IP address
- Port Number

The factory default setting is "8080".

#### Authentication

Specify whether or not authentication is necessary for a proxy server.

[Authentication] is set to off as the factory default.

When [Authentication] is set to on, specify the following items:

- Username
- Password

### PaperStream NX Manager

Configure the settings for PaperStream NX Manager.

#### PaperStream NX Manager

Specify whether to use PaperStream NX Manager.

When using PaperStream NX Manager, set the server type.

#### Server Type

##### Do not use

Select this when not using PaperStream NX Manager.

This is the factory default setting.

##### Private Server

Select this to use PaperStream NX Manager with a private server.

When selecting [Private Server], specify the following items:

- Host Name/IP address
- Port Number

The factory default setting is "20447".

- Validate server certificates

This item can be configured if [Encryption On (HTTPS)] is set for [Network Encryption].

A root certificate is registered with the scanner. Specify whether to validate server certificates using the root certificate.

For details about root certificates, refer to the PaperStream NX Manager User's Guide.

[Validate server certificates] is set to off as the factory default.

### **EdgeXperience (Cloud)**

Select this to use EdgeXperience Capture Service. Note that a contract is required to use EdgeXperience Capture Service. For information about the contract, contact the distributor/dealer where you purchased this product. Refer to the contact information in the Contact List if supplied with this product, or refer to the contact information in the Contact for Inquiries section if provided in Safety Precautions supplied with this product, and then make an inquiry.

When selecting [EdgeXperience (Cloud)], specify the following items:

- Region
- Tenant Code

### **[Check connection] button**

Check if the scanner is connected to PaperStream NX Manager.

### **Auto Login/Logout**

Specify an auto login method or set the auto logout time for PaperStream NX Manager.

#### **Auto Logout minutes**

Specify a time (minutes) to automatically log out from PaperStream NX Manager if the scanner is left on for a certain period of time without being used.

- Disabled (Never)  
This is the factory default setting.
- 1
- 2
- 3

#### **Auto Login**

Specify an auto login method for PaperStream NX Manager.

- Disabled  
This is the factory default setting.
- Username/Password
- Job Group Code

### **Application (Internet)**

Set this item when scanning with a user application on a computer or mobile device in an environment in which PaperStream NX Manager and a scanner are connected via the Internet.

**Enable**

[Enable] is set to off as the factory default.

**Scanner Central Admin Server**

Configure the settings for Scanner Central Admin Server to use PaperStream NX Manager. Set this item to monitor the scanners or perform a single operation on them at the same time with Scanner Central Admin Server.

**Enable**

Specify whether to use Scanner Central Admin Server.

[Enable] is set to off as the factory default.

When [Enable] is set to on, specify the following items:

- Host Name/IP address

- Port Number

The factory default setting is "20444".

- Validate server certificates

This item can be configured if [Encryption On (HTTPS)] is set for [Network Encryption].

A root certificate is registered with the scanner. Specify whether to validate server certificates using the root certificate.

For details about root certificates, refer to the Scanner Central Admin User's Guide.

[Validate server certificates] is set to off as the factory default.

**[Check connection] button**

Check if the scanner is connected to Scanner Central Admin Server.

**Network Encryption**

Specify whether to encrypt network communications.

- Encryption Off (HTTP)

This is a transmission method prioritizing the scanning speed.

- Encryption On (HTTPS)

This is a transmission method prioritizing the security. The scanning speed is slow with this setting.

When [Encryption On (HTTPS)] is selected, specify the following items:

- TLS 1.0/1.1 Communication

Specify whether to enable communication over TLS 1.0/1.1.

[TLS 1.0/1.1 Communication] is set to off as the factory default.

The factory default of [Network Encryption] varies depending on the scanner serial number, as shown below.

- If the scanner serial number begins with "AY9A" and the fifth character is "M" or any subsequent letter in the alphabet (for example, AY9AM00001, AY9AN00001, AY9AO00001, and so on)

The factory default setting is [Encryption On (HTTPS)].

- If the scanner serial number does not meet the above condition

The factory default setting is [Encryption Off (HTTP)].

To check the scanner serial number, remove the ADF paper chute (feeder) and refer to the label on the back of the scanner.

For details, refer to [Checking the Product Label \(page 231\)](#).

### **Check connection (Ping)**

Check the communication status between the scanner and the connected computer.

#### **Host Name/IP address**

Enter a host name or an IP address.

#### **[Run] button**

A ping test is performed.

---

## Paper Source/Feeding

### Pre-Pick

Enable this to shorten the scanning time when scanning continuously.

"Pre-pick" refers to feeding the next document into the ADF before ejecting the current document being scanned when scanning documents continuously.

### Enable

[Enable] is set to on as the factory default.

#### TIP

- If you cancel in the middle of scanning while pre-pick is enabled, you have to remove the pre-picked document, then load the document again.
- This setting can also be configured in the scanner driver.  
Note that priority is given to the scanner driver setting.

### Retry Paper Feeding

Specify the number of feeding retries when a document is not fed from the ADF paper chute (feeder).

#### Number of paper feeding retries

The factory default setting is "3".

### Multifeed Detection

Multifeed is an error that occurs when two or more sheets are overlapped and fed at once. Configure the settings to detect overlapped documents during a scan.

Overlapped documents are detected with the ultrasonic sensor or according to the difference in length of the documents.

When overlapped documents are detected, an error message is displayed on the touch screen and the scan stops. If documents are overlapped within 30 mm from the leading edge, they are not detected as overlapped.

#### Detection Method

Specify a method to detect overlapped documents.

- Does not detect  
Does not detect overlapped documents.  
This is the factory default setting.
- Check Overlapping (Ultrasonic)  
Detects overlapped documents with the ultrasonic sensor.  
When this is selected, you can specify the following two options:
  - Specify an area to detect overlapped documents by the length from the leading edge of the document in the feeding direction.

Set it in [Multifeed Detection Area].

- When a piece of paper is attached on a document, the length and position of the paper can be memorized, and set to ignore overlapping of documents.

Set it in [Intelligent Multifeed Detection].

- Check Length

Detects overlapped documents according to the difference in length.

Select this to scan documents of the same length.

Note that overlapped documents cannot be detected accurately when a mixed batch of different lengths are scanned.

- Check Overlapping and Length

Detects overlapped documents by the combination of [Check Overlapping (Ultrasonic)] and [Check Length].

When this is selected, you can specify the following two options:

- Specify an area to detect overlapped documents by the length from the leading edge of the document in the feeding direction.

Set it in [Multifeed Detection Area].

- When a piece of paper is attached on a document, the length and position of the paper can be memorized, and set to ignore overlapping of documents.

Set it in [Intelligent Multifeed Detection].

Note that overlapped documents cannot be detected accurately when a mixed batch of different lengths are scanned.

### Threshold (Length)

Specify the difference in length of documents to be detected as overlapped documents.

Overlapped documents are detected when the difference in length of documents is longer than the specified value.

Specify this item when [Check Length] or [Check Overlapping and Length] is selected for [Detection Method].

Any length under the specified value is tolerated as a slight error and not detected as overlapped documents.

- 10 mm or less is not detected

This is the factory default setting.

- 15 mm or less is not detected

- 20 mm or less is not detected

#### ATTENTION

- To scan documents with different lengths, select [Check Overlapping (Ultrasonic)].
- When an attachment such as a sticky note, receipt, or photo is attached on the document, the attachment part of the document may be detected as overlapping of documents if [Check Overlapping (Ultrasonic)] is selected. In that case, select [Check Length].

Otherwise, detect overlapping of documents by specifying an area on the document that does not include an area attached with paper in order to ignore the overlapping of documents for that area.

#### TIP

- This setting can also be configured in the scanner driver.  
Note that priority is given to the scanner driver setting.
- When the Carrier Sheet setting is enabled in the scanner driver, the touch screen does not display the error message. The scanner driver does.

### Multifeed Detection Area

Specify an area to detect overlapped documents.

Specify this item when [Check Overlapping (Ultrasonic)] or [Check Overlapping and Length] is selected for [Multifeed Detection].

#### Enable

Specify whether to set an area to detect overlapped documents.

[Enable] is set to off as the factory default.

#### How to set the detection area

Specify whether to set a disabled area or enabled area to detect overlapped documents.

- Set the disabled area  
This is the factory default setting.
- Set the enabled area

#### Start (mm)

Specify the start position of the detection area by the length from the leading edge of the document in the feeding direction.

The factory default setting is "0".

#### End (mm)

Specify the end position of the detection area by the length from the leading edge of the document in the feeding direction.

The factory default setting is "0".

#### TIP

- When the start and end positions are both "0", overlapped documents are detected in the whole document regardless of the setting for [How to set the detection area].
- To disable the detection of overlapped documents for the whole document, select [Set the disabled area] for [How to set the detection area], and set the start position to "0" and the end position to equal the document length or longer.

- If the start position is set at the length that is longer than the document length, overlapped documents are detected in the whole document when [Set the disabled area] is selected for [How to set the detection area], and overlapped documents are not detected anywhere in the whole document when [Set the enabled area] is selected for [How to set the detection area].
- To detect overlapped documents, the area must be at least 5 mm in length. Configure the setting so that the value of the end position minus the start position is 6 mm or more.
- For examples of the overlapping detection area settings, refer to [Examples of the Settings for the Area to Detect the Overlapping of Documents \(page 310\)](#).

### Intelligent Multifeed Detection

Configure the setting to automatically ignore certain patterns of overlapped documents when the setting to detect overlapped documents is enabled.

Note that you first need to specify [Check Overlapping (Ultrasonic)] or [Check Overlapping and Length] in the scanner driver and "[Multifeed Detection \(page 246\)](#)" on the touch screen before setting this item.

#### Operation mode

Set the operation mode.

#### Manually Bypass

Specify whether overlapped documents are detected when re-scanning documents detected as overlapped documents.

Does not memorize the size or location of the paper attachment.

This is the factory default setting.

#### Automatically Bypass (combination of length and position)

Specify whether the length and position of a piece of paper attached on a document detected as overlapped documents are memorized as an overlap pattern.

If the overlap pattern is memorized, documents with the same overlap pattern are not detected as overlapped documents from the next scan.

#### TIP

When [When powering off] in [Memorize overlap pattern] is enabled, the overlap patterns (only for the last eight sheets) will be memorized.

#### Automatically Bypass (length)

Specify whether the length of the longest piece of paper attached on a document detected as overlapped documents is memorized as an overlap pattern.

If the overlap pattern is memorized, a document with a piece of paper in the same length or shorter attached is not detected as overlapped documents from the next scan.

## Memorize overlap pattern

### When confirming image

Specify whether or not to memorize overlap patterns automatically when the window is displayed to check images for documents that were detected as overlapped documents.

[When confirming image] is set to off as the factory default.

### When powering off

Specify whether or not to keep overlap patterns upon turning the power off.

When [When powering off] is set to on, keep overlap patterns upon turning the power off. Set this to on to use the same overlap patterns after turning the power on again.

[When powering off] is set to off as the factory default.

## Overlap pattern

### [Clear] button

Delete all the overlap patterns that have been memorized in the scanner.

#### TIP

When the setting for using the Carrier Sheet is enabled in the scanner driver, [Intelligent Multifeed Detection] is disabled.

## Manual Feeding

Configure the settings when manually loading and scanning one sheet at a time.

When you scan by manually loading one sheet at a time, you can specify the waiting time (interval) for loading the next document in the ADF paper chute (feeder). This enables continuous scanning as long as you load a document within the specified time.

If the specified time is exceeded, the scan is finished automatically.

### Continuous Feed Mode

Specify whether or not to enable the continuous feed mode.

Set [Continuous Feed Mode] to on to scan more than one document in succession manually.

[Continuous Feed Mode] is set to off as the factory default.

When Manual Single Mode is used, the setting for [Continuous Feed Mode] is ignored.

### Timeout seconds

Specify the time period until which the scanner confirms that no documents are loaded in the ADF paper chute (feeder) (the interval between the last scan and the detection of whether the next document is loaded or not).

The factory default setting is "10".

**TIP**

- When [Continuous Feed Mode] is set to on, the scanner will wait for documents to be loaded until the specified timeout time elapses even if you start scanning with no document in the ADF paper chute (feeder).
- When the feed mode switch is set to Manual Single Mode, the scanner will wait for documents to be loaded until the specified timeout time elapses regardless of the setting for [Continuous Feed Mode].

**High Altitude Mode**

Enable this mode to use the scanner at an altitude of 2,000 m or higher.

Low atmospheric pressure at high altitudes may lower the accuracy in detections for overlapped documents with the ultrasonic sensor.

**Enable**

Setting [Enable] to on for this item improves the accuracy to detect overlapped documents.

[Enable] is set to off as the factory default.

---

## Paper Protection

### Paper protection

Configure the setting to detect feeding errors.

This function detects feeding errors in the following cases:

- When the scanner detects a warped document caused by a feeding error
- When the scanner detects paper jam noise

Paper jams due to feeding errors could damage or tear valuable documents.

Detecting a feeding error and stopping the scan can prevent damage to documents.

This function is effective when you scan documents which are difficult to feed such as thin paper documents.

### Detect

Specify a method to detect feeding errors.

- **Disable**  
Does not detect feeding errors.
- **Feeding Accuracy**  
Stops the scan when the scanner detects a warped document caused by a feeding error.  
This is the factory default setting.
- **Feeding Noise**  
Stops the scan when the scanner detects paper jam noise.
- **Feeding Accuracy & Noise**  
Stops the scan when the scanner detects a warped document caused by a feeding error,  
or when the scanner detects paper jam noise.

### Feeding Accuracy Sensitivity

Specify the sensitivity level for detecting warped documents.

- **Low**  
Decreases the sensitivity level to detect warped documents.  
Specify this to detect a warped document only if it is highly deformed.
- **Normal**  
Detects warped documents with the optimum sensitivity level.  
This is the factory default setting.
- **High**  
Increases the sensitivity level to detect warped documents.  
Specify this to detect a warped document even if it is slightly deformed.

### Feeding Noise Sensitivity

Specify the sensitivity level for detecting feeding noise.

- **Low**  
Decreases the sensitivity level to detect paper jam noise.

Specify this to detect only loud paper jam noise.

- Normal  
Detects paper jam noise with the optimum sensitivity level.  
This is the factory default setting.
- High  
Increases the sensitivity level to detect paper jam noise.  
Specify this to detect even slight paper jam noise.

#### ATTENTION

- Note that the paper protection function is to prevent damages to documents, but the protection of all documents is not guaranteed.
- When you use the paper protection function, make sure to load the documents with their top edges aligned (especially for a mixed batch of documents with different lengths).  
If the top edges are not aligned properly, the scan may stop even when the documents are being fed correctly.

#### TIP

- If you scan a wrinkled document, the scan may stop even when the document is being fed correctly.  
In that case, the paper protection function can be disabled only for the document on the touch screen.  
For details, refer to [Disabling the Paper Protection Function \(page 118\)](#).
- If the paper protection function stops scans frequently, refer to [Paper Protection Is Set Off Frequently \(page 218\)](#).

### Paper Protection (Touch Screen Settings)

Configure the setting to detect feeding errors.

Specify this when [Prioritize the touch screen settings] is set to on.

Specify the following items:

- Detect
- Feeding Accuracy Sensitivity
- Feeding Noise Sensitivity

For details about the setting items, refer to [Detect \(page 252\)](#).

### Prioritize the touch screen settings

Enable this option when you want some settings to be prioritized over the settings for [Paper Protection] and the Software Operation Panel.

[Prioritize the touch screen settings] is set to off as the factory default.

**TIP**

- This setting can also be configured in the scanner driver.  
When the paper protection setting is set to on in the scanner driver, [Feeding Accuracy & Noise] is enabled regardless of the setting on the scanner.
- For the paper protection setting, priority will be given in the following order:
  - 1 [Paper Protection] in the scanner driver
  - 2 [Paper Protection (Touch Screen Settings)] on the touch screen
  - 3 [Paper protection] on the touch screen or [Paper Protection] on the Software Operation Panel

## Image

### Automatic Page Size Detection

When the scanner is set to detect the paper size automatically, specify whether or not to optimize (round up/down) the fractional part of the scanned image.

When the paper size is detected, there may be a fractional part of the scanned image compared to the standard paper size.

Output image size varies depending on how the fractional part is processed.

- **Optimize**  
Prevents loss of information.  
However, a shadow may appear around the edges of images.  
This is the factory default setting.
- **Round Down**  
The image size becomes the standard paper size.  
However, when you scan a document with text around the edges, a part of the information may be missing in the output image.

#### **ATTENTION**

For details about setting automatic page size detection, refer to the help for the scanner driver.

#### **TIP**

This setting is effective only for scanning images in black & white.

### Page Edge Filler Area

Configure the settings to fill in the shadow or streaks around the edge of the scanned image. Depending on the condition of the documents that you scan, the shadow of a document may appear as black streaks on the edges of the scanned image.

In this case, remove the black streaks by filling in the edges of the scanned image.

The specified area is filled in white or black, according to the background color.

#### **Top (mm)**

Specify the width of the top margin to fill in. The factory default setting is "0".

#### **Bottom (mm)**

Specify the width of the bottom margin to fill in. The factory default setting is "0".

#### **Right (mm)**

Specify the width of the right margin to fill in. The factory default setting is "0".

**Left (mm)**

Specify the width of the left margin to fill in. The factory default setting is "0".

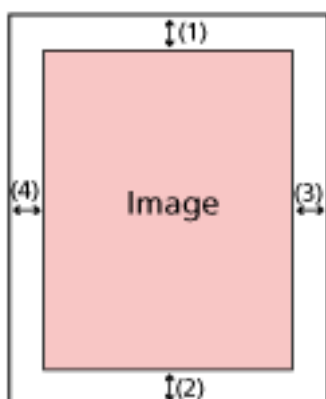

- (1): Top = 0 to 15 mm
  - (2): Bottom = -7 to 7 mm
  - (3): Right = 0 to 15 mm
  - (4): Left = 0 to 15 mm
- (in 1 mm increments)

**ATTENTION**

Note that if the target range of page edge filler is too wide, some characters near the edge may appear missing.

**TIP**

- You can change the background color to black or white in the scanner driver. For details, refer to the help for the scanner driver.
- Depending on the value you specify for the bottom margin of the page edge filler, the page edge filler function operates as follows:
  - 1 to 7 mm  
Fills in the specified area with the background color from the bottom edge of the image towards the inside.
  - -1 to -7 mm  
Outputs the image without filling in the specified area with the background color from the bottom edge of the image towards the outside. (Outputs the image with the specified area added when [Page End Detection] is set in the scanner driver.)
- This setting can also be configured in the scanner driver. In such a case, the page edge filler of the scanner driver is used on the image which the scanner already filled in the edges.

## Dropout Color

You can exclude a color from being scanned by selecting either red, green, or blue (three primary colors).

Documents can be scanned without excluding any colors.

For example, when scanning a document with black characters and a green frame, if you select green for the dropout color, only the black characters of the document are scanned.

- Red
- Green
  - This is the factory default setting.
- Blue
- None

### ATTENTION

- This function works the best with light (low intensity) colors, and dark colors may not be excluded.
- You cannot specify a color other than Red, Green, and Blue.
  - To drop out other colors, configure the setting in the scanner driver.
  - For details, refer to the help for the scanner driver.

### TIP

- This is only available in black & white or grayscale mode.
- This setting can also be configured in the scanner driver.
  - Note that priority is given to the scanner driver setting.

## Offset

Specify a starting position for scanning.

The specified value can range from -2 to +2 mm (in increments of 0.5).

The factory default setting is "0".

### Main-scan ADF front (mm)

Specify the horizontal position (widthways) for the ADF front.

### Sub-scan ADF front (mm)

Specify the vertical position (lengthways) for the ADF front.

### Main-scan ADF back (mm)

Specify the horizontal position (widthways) for the ADF back.

### Sub-scan ADF back (mm)

Specify the vertical position (lengthways) for the ADF back.

**ATTENTION**

Normally, you should not have to modify anything as the factory default settings already use adjusted values.

**Magnification****Magnification (%)**

Specify the magnification level for the feed direction.

The specified value can range from -3.1 to +3.1% (in increments of 0.1).

The factory default setting is "0.0".

**ATTENTION**

Normally, you should not have to modify anything as the factory default settings already use adjusted values.

**Image Quality Mode**

To obtain an image quality that is close to the image quality for scanning with fi-6130Z, set the image quality mode.

- Disable  
This is the factory default setting.
- fi-6130Z

---

## Cleaning & Maintenance

### Cleaning cycle

Specify the cleaning cycle for the scanner inside.

The background color of the [After cleaning] counter in the [Consumable counters] screen changes to yellow when the counter reaches 95% of the specified value for this item, and to red when the counter reaches 100%.

#### Cycle (x 1000 Sheets)

Specify the cleaning cycle in increments of 1000 sheets.

The factory default setting is "5".

### Issue a cleaning time notification

Specify whether or not to display the cleaning instruction message.

When [Issue a cleaning time notification] is set to on, a notification can be displayed on



on the touch screen when the time for cleaning approaches.

[Issue a cleaning time notification] is set to off as the factory default.

### Replacement of the Pick Roller

Specify the replacement cycle for the pick roller.

The background color of the [After Replacing the Pick Roller] counter in the [Consumable counters] screen changes to yellow when the sheet count after replacing the pick roller reaches 95% of the specified value for this item, and to red when the counter reaches 100%.

In addition, a notification can be displayed on  on the touch screen when the time for replacing the pick roller approaches.

#### Cycle (x 10000 Sheets)

Specify the replacement cycle for the pick roller in increments of 10,000 sheets.

The factory default setting is "20".

### Replacement of the Brake Roller

Specify the replacement cycle for the brake roller

The background color of the [After Replacing the Brake Roller] counter in the [Consumable counters] screen changes to yellow when the sheet count after replacing the brake roller reaches 95% of the specified value for this item, and to red when the counter reaches 100%.

In addition, a notification can be displayed on  on the touch screen when the time for replacing the brake roller approaches.

#### Cycle (x 10000 Sheets)

Specify the replacement cycle for the brake roller in increments of 10,000 sheets.

The factory default setting is "20".

### Maintenance cycle

Specify the maintenance and inspection cycle for the scanner that is performed by a service engineer.

If the specified period has passed after the last maintenance and inspection date, the touch

screen displays a notification on  when you receive a [Maintenance] message.

For regular maintenance and inspection on the scanner by a service engineer, contact the distributor/dealer where you purchased this product. Refer to the contact information in the Contact List if supplied with this product, or refer to the contact information in the Contact for Inquiries section if provided in Safety Precautions supplied with this product, and then make an inquiry.

### Enable

Specify whether or not to get a notification on the touch screen when the time for maintenance approaches.

[Enable] is set to off as the factory default.

### Cycle (months)

Specify a cycle for receiving notifications on maintenance.

The factory default setting is "12".

## USB

### USB

Specify how the USB function operates.

After the setting is changed, the scanner is restarted.

- Automatic  
Operates in accordance with the connection environment. This is the factory default setting.
- USB 2.0  
Operates with USB 2.0.

## Admin Password

### Admin Password

Change or disable the administrator password.

Specify whether or not to disable the administrator password depending on the operation.

Change the administrator password regularly.

**Enable**

If the scanner serial number begins with "AY9A" and the fifth character is "M" or any subsequent letter in the alphabet (for example, AY9AM00001, AY9AN00001, AY9AO00001, and so on), this item is not displayed.

To check the scanner serial number, remove the ADF paper chute (feeder) and refer to the label on the back of the scanner.

For details, refer to [Checking the Product Label \(page 231\)](#).

[Enable] is set to on as the factory default.

**Current Password**

Enter the current password.

You can check the default administrator password by checking whether there is a label or not.

For details about the label, refer to [Checking the Product Label \(page 231\)](#).

**New Password**

Enter a new password within 16 characters to change the current password.

All characters that are available on the touch screen on the scanner can be used.

The space before or after the character string is ignored.

**Confirm New Password**

Re-enter the password entered for [New Password] for confirmation to change the current password.

---

## Restore Factory Defaults

**Restore Factory Defaults**

Restore the scanner settings to the factory default.

**[Start] button**

Restore factory defaults.

The scanner is restarted and the setup window appears.

# Scanner Settings (Software Operation Panel)

This section explains how to use the Software Operation Panel to configure the scanner settings.

## TIP

The scanner settings can also be configured from the touch screen. For details, refer to [Scanner Settings \(Touch Screen\)](#) (page 232).

---

## Starting Up the Software Operation Panel

The Software Operation Panel is installed together with the PaperStream IP driver. With this application, you can configure settings for operations of the scanner and management of the consumable parts.

## ATTENTION

- Do not start up the Software Operation Panel during scanning.
- If you change the Software Operation Panel settings while the scanner driver window is displayed, the changes may not be applied immediately. In that case, close the scanner driver window and open it again.
- Do not use the touch screen while the Software Operation Panel is running.

### 1 Confirm that the scanner is connected to the computer, then turn on the scanner.

For details about how to connect the scanner to the computer, refer to [Getting Started and Scanner Setup](#) (page 35).

For details about how to turn on the scanner, refer to [How to Turn the Power ON](#) (page 60).

### 2 Display the [Software Operation Panel] window.

- Windows 10/Windows Server 2016/Windows Server 2019/Windows Server 2022  
Click [Start] menu → [fi Series] → [Software Operation Panel].
- Windows 11/Windows Server 2025

Click [Start] menu → [All apps] → [fi Series] → [Software Operation Panel].

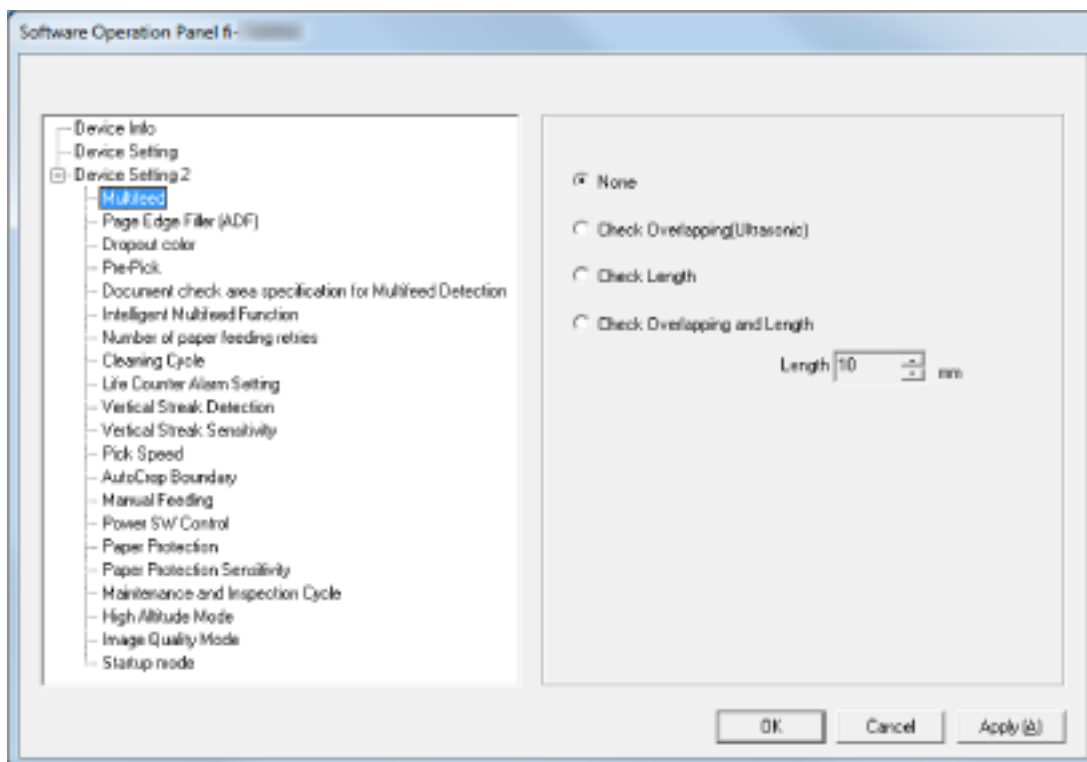

The Software Operation Panel icon is displayed in the menu that appears when you click  in the notification area.

To have the Software Operation Panel icon always displayed in the notification area, drag and drop the icon onto the notification area.

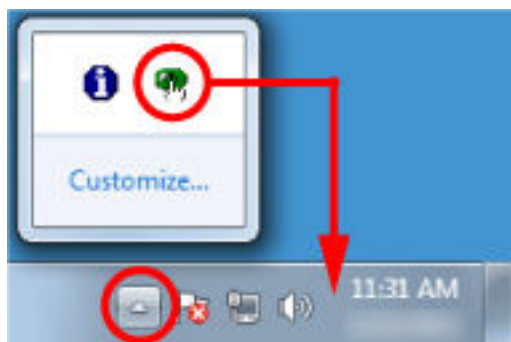

---

## Password Setting for the Software Operation Panel

By setting a password, the Software Operation Panel can run in [View Only mode] which allows users to only view the scanner settings.

The scanner settings can be configured if no password is set.

In order to prevent unnecessary changes to the settings, a password can be used to restrict user operations.

## Setting a Password

Set a password in the following procedure.

- 1 Right-click the Software Operation Panel icon in the notification area, and select [Password Setting] from the menu.

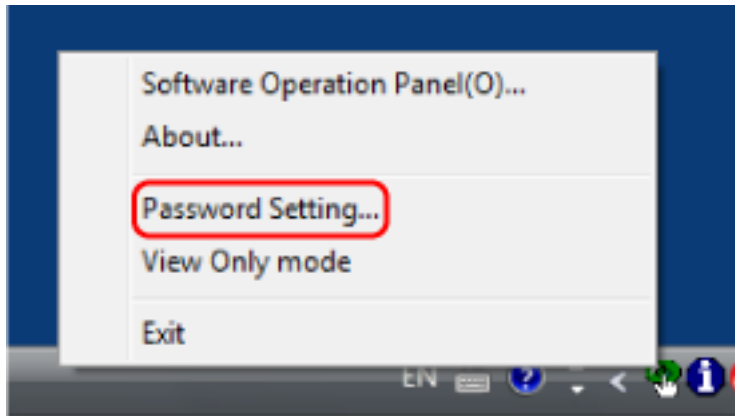

The [Password setting] window appears.

- 2 Enter a new password then again to confirm, and click the [OK] button.  
Up to 32 characters can be used for the password.  
Note that only alphanumeric characters (a to z, A to Z, 0 to 9) are allowed.

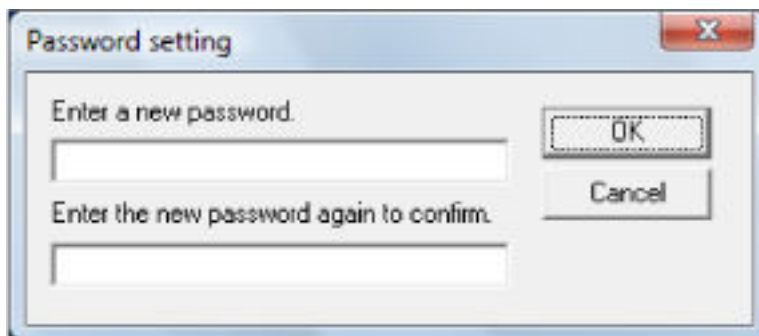

A message window appears.

- 3 Click the [OK] button.  
The password is set.

## Setting [View Only mode]

Set the Software Operation Panel to [View Only mode].

- 1 **Set a password.**  
For details, refer to [Setting a Password \(page 265\)](#).
- 2 **Right-click the Software Operation Panel icon in the notification area, and select [View Only mode] from the menu.**

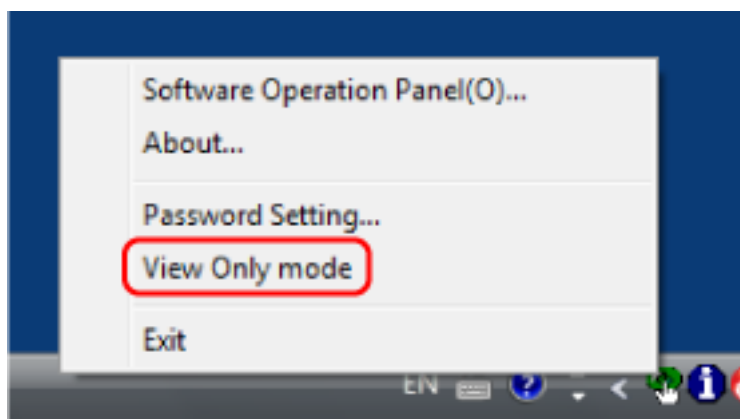

The Software Operation Panel enters [View Only mode].

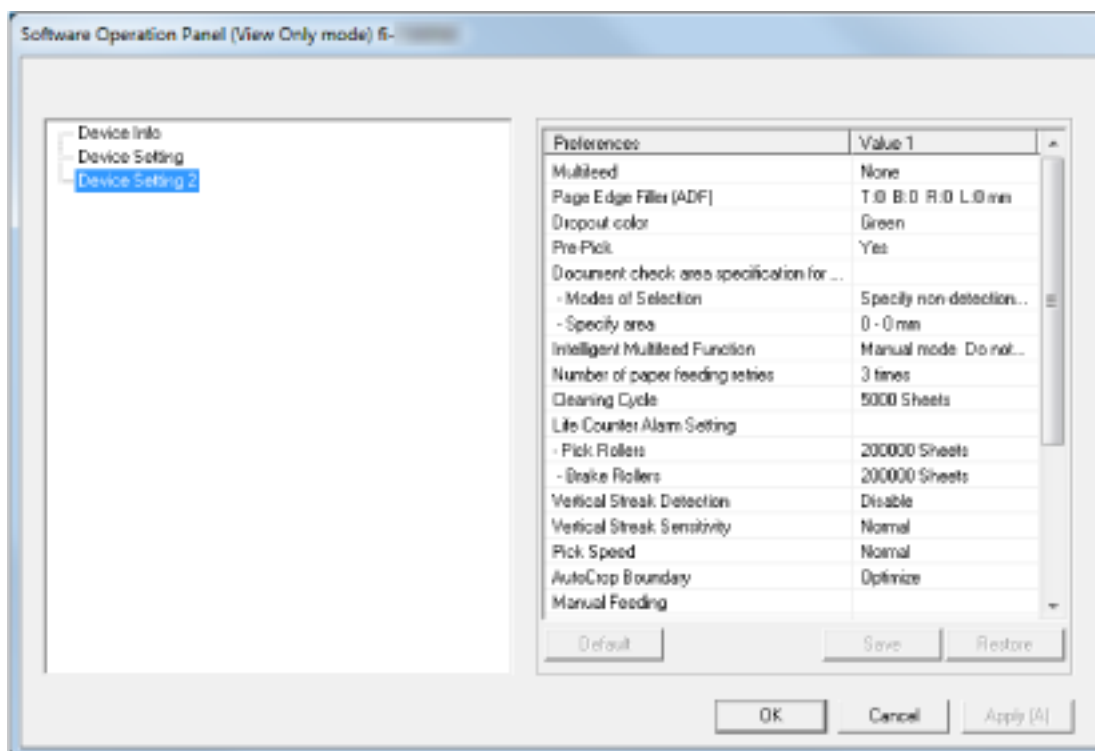

**TIP**

In [View Only mode], a check mark appears next to [View Only mode] in the menu that is displayed by right-clicking the Software Operation Panel icon in the notification area.

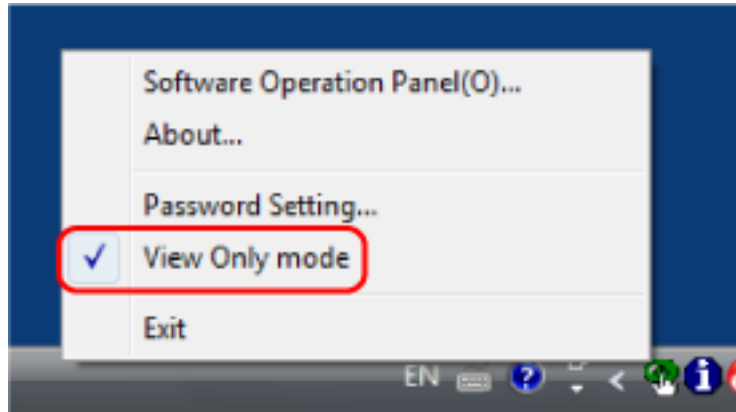

## Exiting [View Only mode]

Exit [View Only mode] on the Software Operation Panel in the following procedure.

- 1 Right-click the Software Operation Panel icon in the notification area, and select [View Only mode] from the menu.

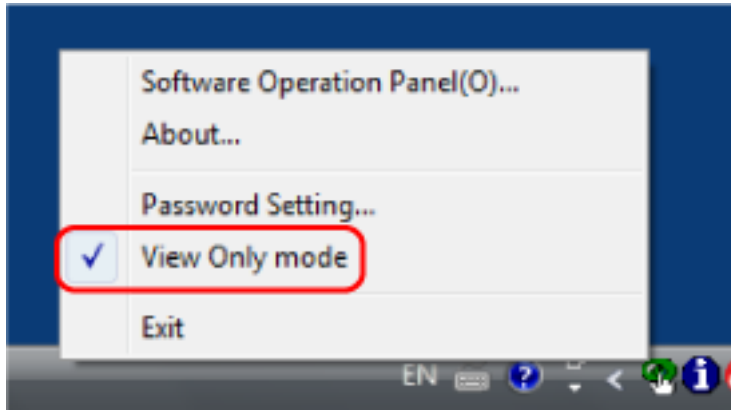

The [Password setting] window appears.

- 2 Enter the current password and click the [OK] button.

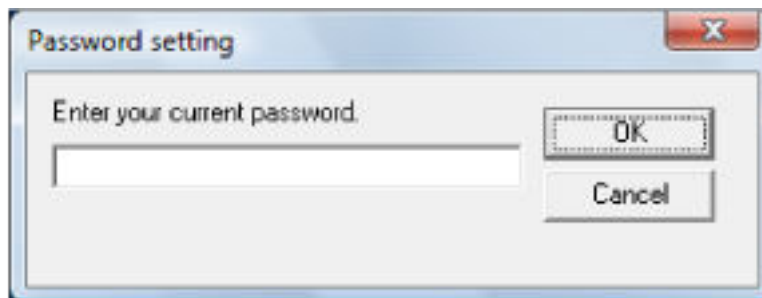

The Software Operation Panel exits [View Only mode], and the scanner settings can now be changed.

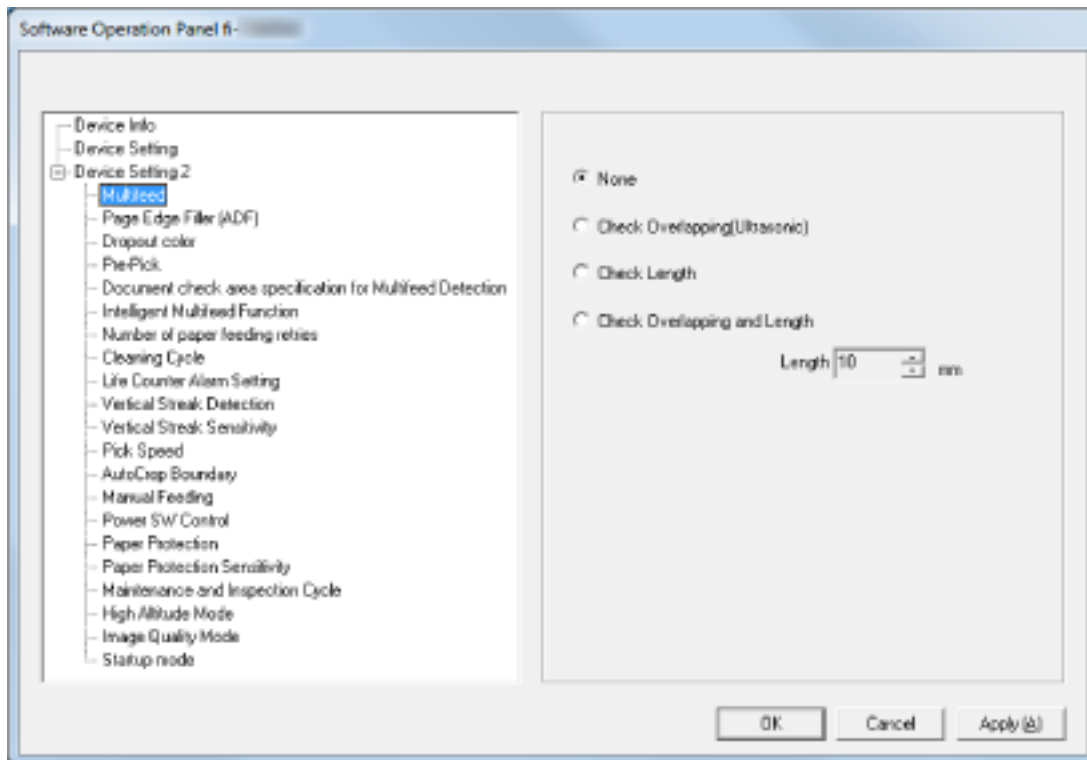

**TIP**

When the Software Operation Panel exits [View Only mode], the check mark next to [View Only mode] disappears from the menu that is displayed by right-clicking the Software Operation Panel icon in the notification area.

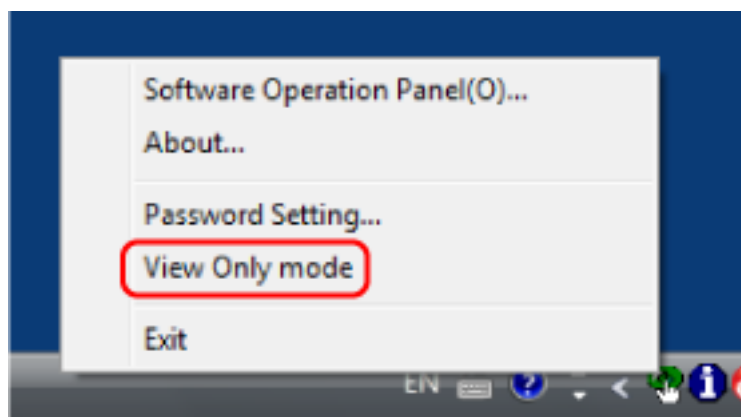

## Changing the Password

Change the password in the following procedure.

- 1 Right-click the Software Operation Panel icon in the notification area, and select [Password Setting] from the menu.

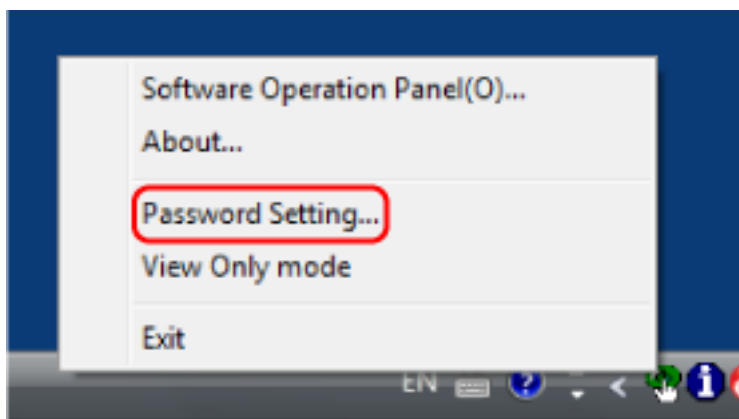

The [Password setting] window appears.

- 2 Enter the current password and click the [OK] button.



The [Password setting] window appears.

- 3 Enter a new password then again to confirm, and click the [OK] button.  
Up to 32 characters can be used for the password.  
Note that only alphanumeric characters (a to z, A to Z, 0 to 9) are allowed.

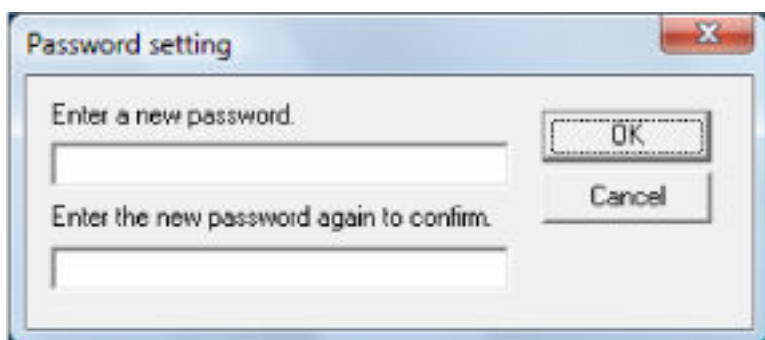

A message window appears.

- 4 Click the [OK] button.

The password is set.

## Clearing the Password

Clear the password in the following procedure.

- 1 Right-click the Software Operation Panel icon in the notification area, and select [Password Setting] from the menu.

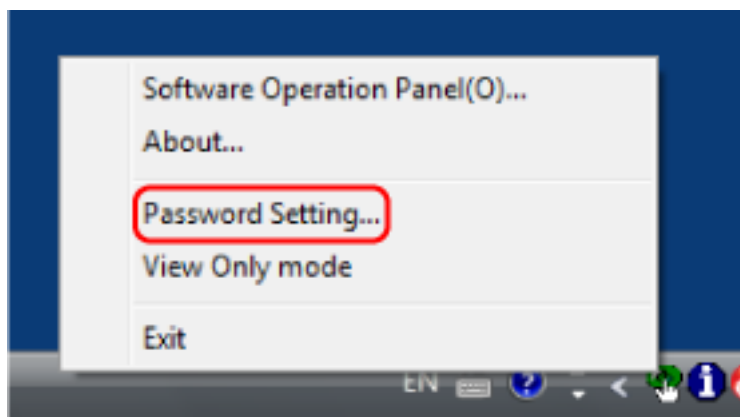

The [Password setting] window appears.

- 2 Enter the current password and click the [OK] button.

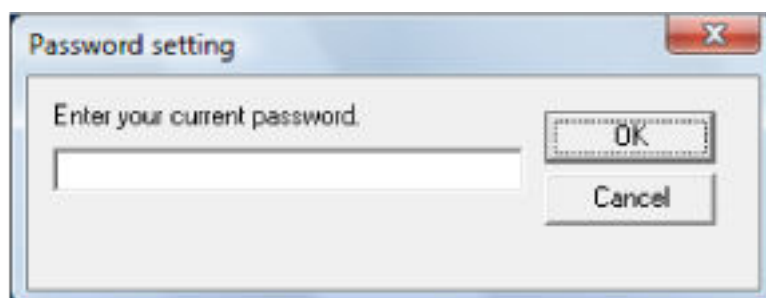

The [Password setting] window appears.

- 3 Leave both fields blank and click the [OK] button.

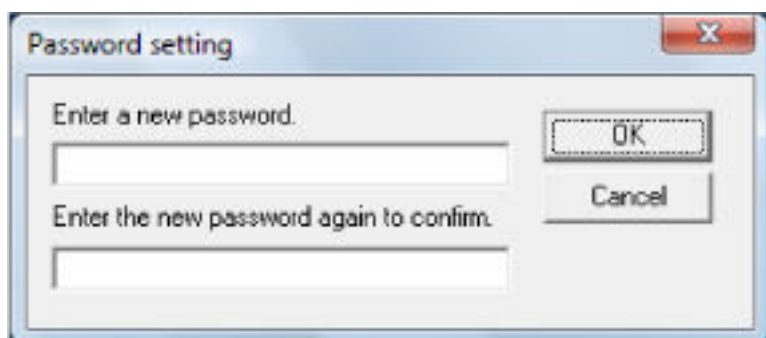

A message window appears.

- 4 Click the [OK] button.

The password is cleared.

## Resetting the Password

If you forgot your password, reset it.

- 1 Right-click the Software Operation Panel icon in the notification area, and select [Password Setting] from the menu.

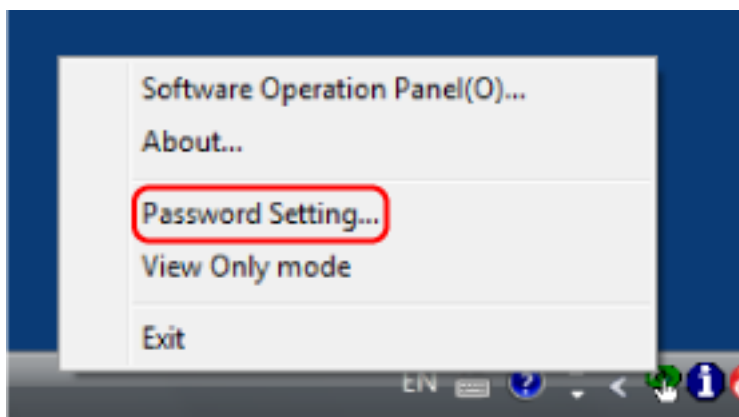

The [Password setting] window appears.

- 2 Enter the default password which is "fi-scanner", and click the [OK] button.



The [Password setting] window appears.

- 3 Enter a new password then again to confirm, and click the [OK] button.  
Up to 32 characters can be used for the password.  
Note that only alphanumeric characters (a to z, A to Z, 0 to 9) are allowed.

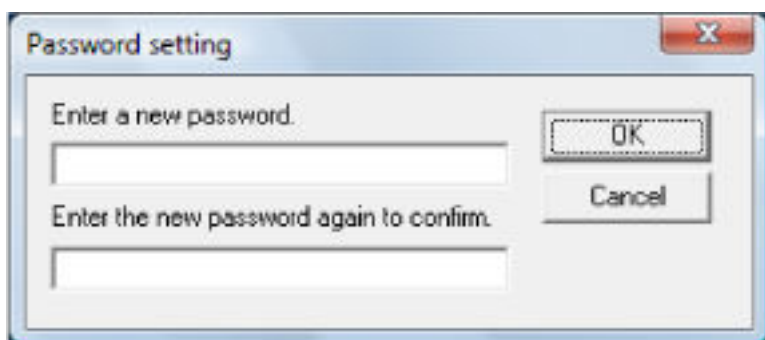

A message window appears.

- 4 Click the [OK] button.

The password is set.

## Setting Items

The Software Operation Panel allows the configuration of the settings that are related to scanning documents or managing consumable parts for the scanner that is connected to the computer. The following lists are used for configuration.

- [Device Setting]  
You can configure settings that are related to counting the number of sheets scanned and managing consumable parts. You can also configure settings that are related to managing the power of a scanner and adjusting the position to start the scan.
- [Device Setting 2]  
You can configure settings that are related to scanning documents.

## Device Setting

### 1 Start up the Software Operation Panel.

For details, refer to [Starting Up the Software Operation Panel \(page 262\)](#).

### 2 From the list on the left, select [Device Setting] and click the [Offset] button.

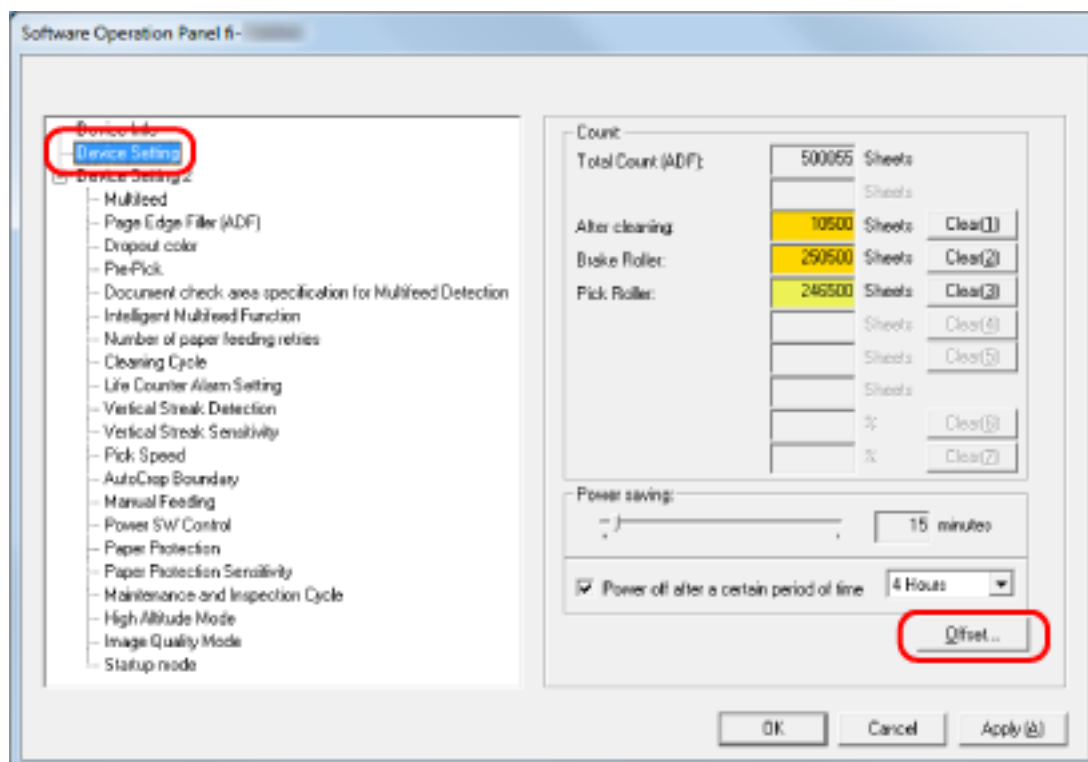

The [Offset] window appears.

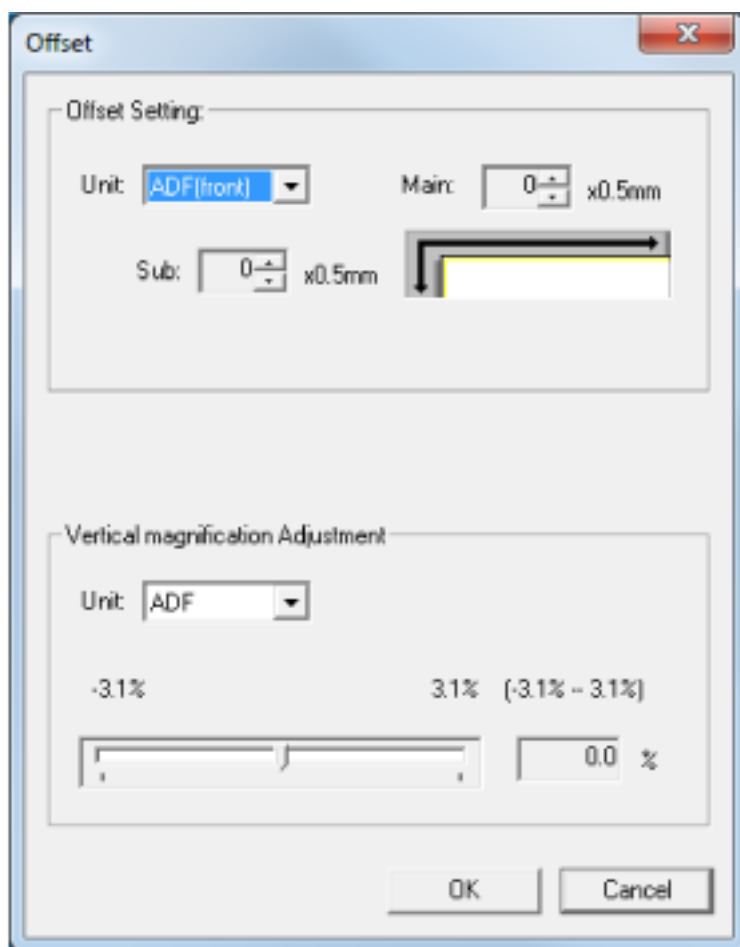

Items that can be configured in these windows are as follows:

Setting Item	Description
Count (Checking/Clearing)	The status of each consumable part can be viewed to determine when to replace or clean the consumables. When you have replaced or cleaned a consumable part, clear the corresponding counter.
Power saving	Specify the waiting time before the scanner enters power saving mode.
Offset Setting	Specify a starting position for scanning.
Vertical magnification Adjustment	Specify the magnification level for the feed direction.

## Device Setting 2

### 1 Start up the Software Operation Panel.

For details, refer to [Starting Up the Software Operation Panel](#) (page 262).

### 2 From the list on the left, select [Device Setting 2].

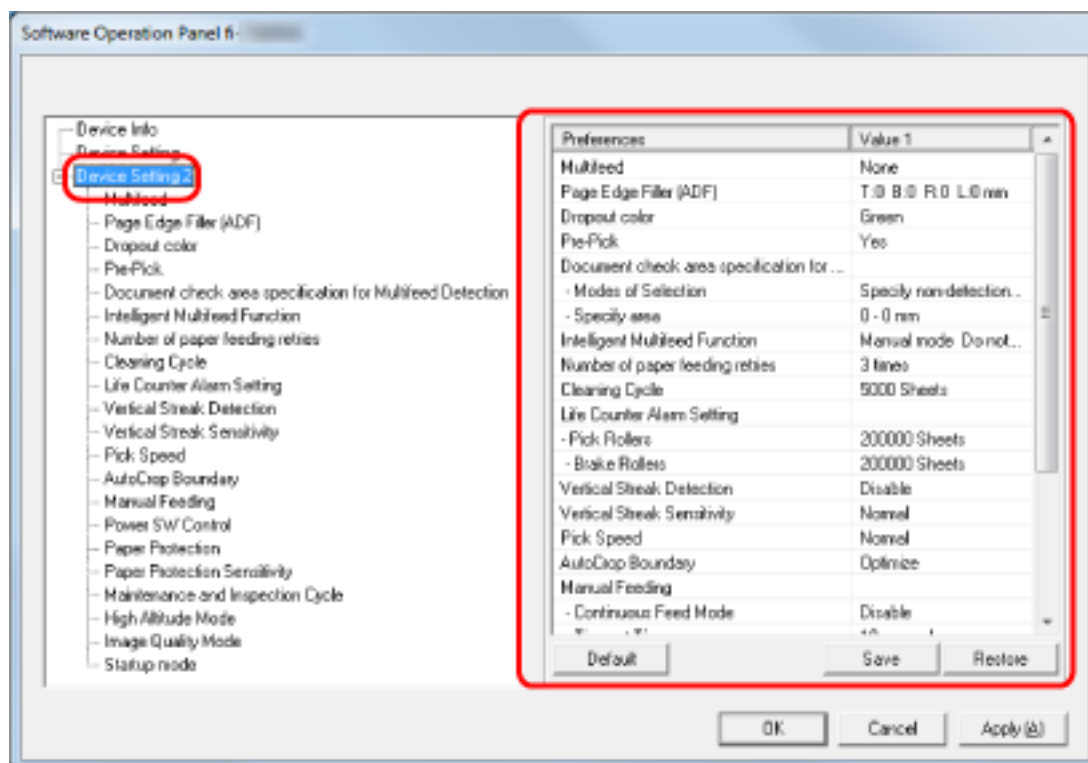

The settings that are currently configured in [Device Setting 2] are listed on the right of the window.

#### TIP

- The Software Operation Panel settings can be restored to the factory default.  
To restore the settings to the factory default, click the [Default] button. After a message is displayed, click the [OK] button.  
Note that the settings you have configured will be cleared.
- The Software Operation Panel settings can be backed up.  
To back up the settings, click the [Save] button, then specify the file name and click the [Save] button in the displayed window.
- You can use a backup file of the Software Operation Panel settings to restore the settings on other scanners only if the scanner type is the same.  
To restore the settings, click the [Restore] button, then specify the backup file and click the [Open] button in the displayed window. After a message is displayed, click the [OK] button.  
Note that restoration cannot be performed for other types of scanners.

Items that can be configured in [Device Setting 2] are as follows:

Setting Item	Description
Multifeed	Configure the settings to detect overlapped documents during a scan.
Page Edge Filler (ADF)	Configure the settings to fill in the shadow or streaks around the edge of the scanned image.
Dropout color	You can exclude a color from being scanned by selecting either red, green, or blue (three primary colors).
Pre-Pick	Enable this to shorten the scanning time when scanning continuously.
Document check area specification for Multifeed Detection	Specify an area to detect overlapped documents.
Intelligent Multifeed Function	Configure the setting to automatically ignore certain patterns of overlapped documents when the setting to detect overlapped documents is enabled.
Number of paper feeding retries	Specify the number of feeding retries when a document is not fed from the ADF paper chute (feeder).
Cleaning Cycle	Specify the cleaning cycle for the scanner inside.
Life Counter Alarm Setting	Specify the replacement cycle for the consumables.
Vertical Streak Detection	You can configure the settings for detecting dirt on the glass.
Vertical Streak Sensitivity	Specify the sensitivity level to detect vertical streaks (dirt on the glass) when [Enable] is selected for [Vertical Streak Detection].
Pick Speed	You can specify the timing of when document feeding is started.
AutoCrop Boundary	When the scanner is set to detect the paper size automatically, specify whether or not to optimize (round up/down) the fractional part of the scanned image.
Manual Feeding	Configure the settings when manually loading and scanning one sheet at a time.
Power Switch Control	Specify whether or not to turn on/off the scanner by pressing the [Power] button on the scanner.
Paper Protection	Configure the setting to detect feeding errors.
Paper Protection Sensitivity	Specify the sensitivity level for detecting feeding errors when the paper protection function is enabled.
Maintenance and Inspection Cycle	Specify the maintenance and inspection cycle for the scanner that is performed by a service engineer.

Setting Item	Description
High Altitude Mode	Enable this mode to use the scanner at an altitude of 2,000 m or higher.
Image Quality Mode	To obtain an image quality that is close to the image quality for scanning with fi-6130Z, set the image quality mode.
Startup mode	Specify a startup mode for the scanner.

## Settings Related to Sheet Counters

### Checking the Sheet Counter

The status of each consumable part can be viewed to determine when to replace or clean the consumables.

The background color of the counter changes as it gets closer to the time to replace the consumables or to clean the scanner.

The color of each counter changes as follows:

- [After cleaning] counter  
This counter turns yellow when the sheet count after cleaning reaches the value specified in [Scanner Cleaning Cycle \[Cleaning Cycle\] \(page 284\)](#) in the Software Operation Panel.
- [Brake Roller]/[Pick Roller] counters  
These counters turn light yellow when the sheet count after the consumable replacement reaches 95% of the value specified in [Replacement Cycle of Consumables \[Life Counter Alarm Setting\] \(page 285\)](#) in the Software Operation Panel, and turn yellow when the sheet count reaches 100%.

#### 1 Start up the Software Operation Panel.

For details, refer to [Starting Up the Software Operation Panel \(page 262\)](#).

#### 2 From the list on the left, select [Device Setting].

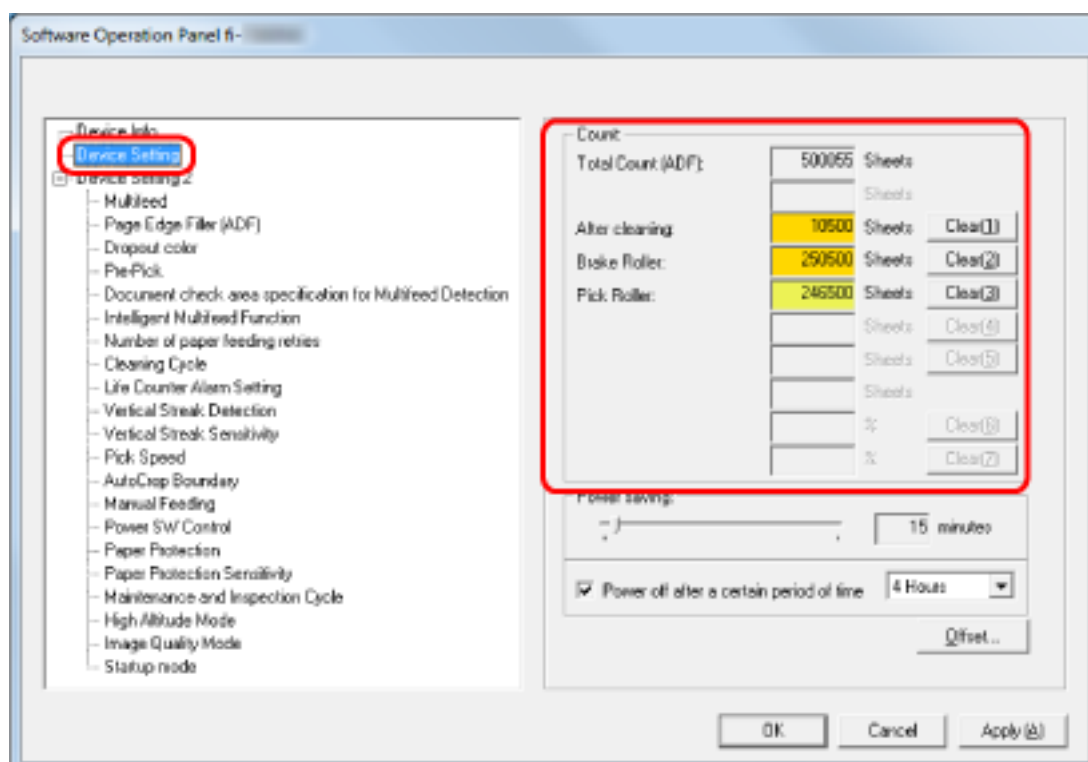

In this window, you can check the following items:

**Total Count (ADF)**

Total number of sheets scanned using the ADF

**After cleaning**

Total number of sheets scanned after cleaning

**Brake Roller**

Number of sheets scanned after the brake roller is replaced

**Pick Roller**

Displays the number of sheets scanned after the pick roller is replaced.

The factory default setting for each counter is "0".

**ATTENTION**

If you turned off the scanner by unplugging the power cable, or selected [Disable power switch], the number of scanned sheets may not be counted in [Total Count].

For details about disabling the power switch, refer to [Method of Turning the Scanner ON/OFF \[Power Switch Control\]](#) (page 319).

## Clearing the Sheet Counters

When you have replaced or cleaned a consumable part, clear the corresponding counter.

**1 Start up the Software Operation Panel.**

For details, refer to [Starting Up the Software Operation Panel \(page 262\)](#).

**2 From the list on the left, select [Device Setting] and click the [Clear] button for [After cleaning] when cleaning is performed or click the [Clear] button for the consumable that you replaced.**

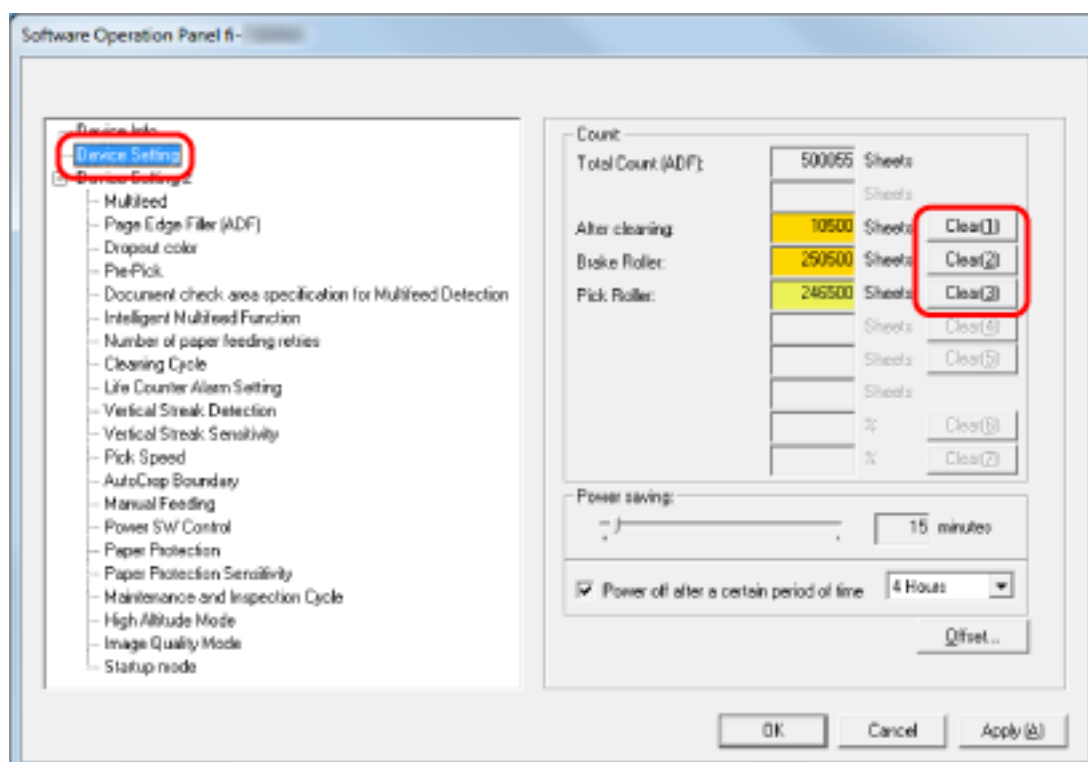

The counter is reset to "0".

**3 Click the [OK] button.**

A message window appears.

**4 Click the [OK] button.**

The settings are saved.

## Messages for Cleaning or Replacing Consumables

The following message may appear on the computer while the scanner is in use.

### Example: Message for replacing consumables

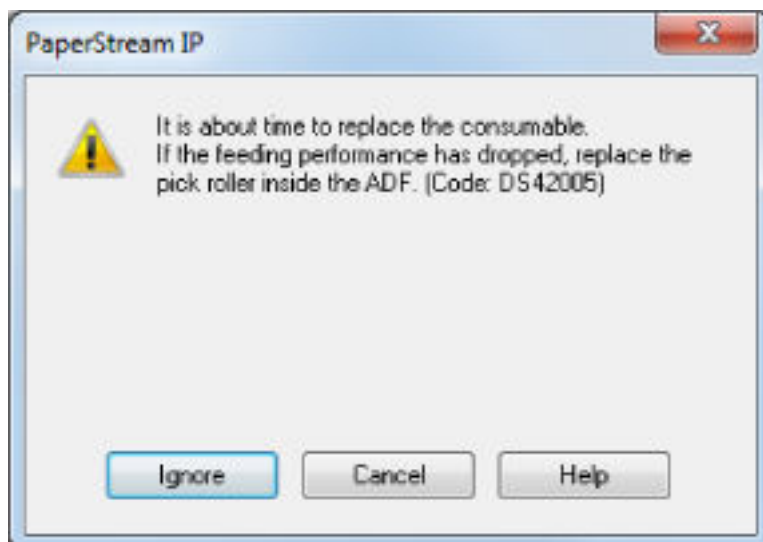

### Example: Message for cleaning

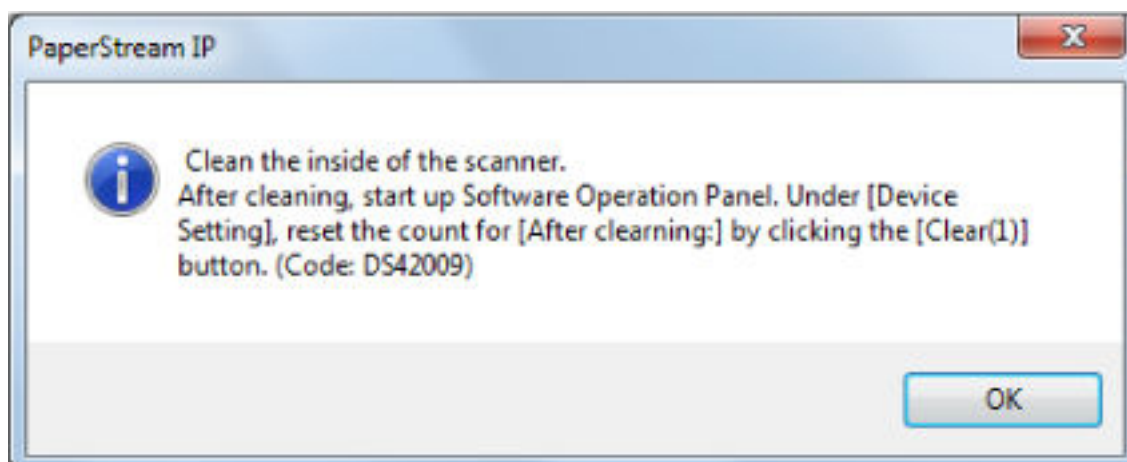

Check the message, and replace the consumable or perform cleaning accordingly.

Note that, when this message appears, the touch screen displays a notification on  for a message related to replacing the consumables or cleaning the scanner.

For details about replacing consumables, refer to the following:

- Brake roller  
[Replacing the Brake Roller \(page 135\)](#)
- Pick roller  
[Replacing the Pick Roller \(page 140\)](#)

For details about cleaning, refer to [Daily Care \(page 120\)](#).

## Scanner Cleaning Cycle [Cleaning Cycle]

Specify the cleaning cycle for the scanner inside.

The background color of the [After cleaning] counter in [Device Setting] changes to yellow when the counter reaches the specified value for this item.

You can also display a cleaning instruction message that is described in [Messages for Cleaning or Replacing Consumables](#) (page 283).

### 1 Start up the Software Operation Panel.

For details, refer to [Starting Up the Software Operation Panel](#) (page 262).

### 2 From the list on the left, select [Device Setting 2] → [Cleaning Cycle].

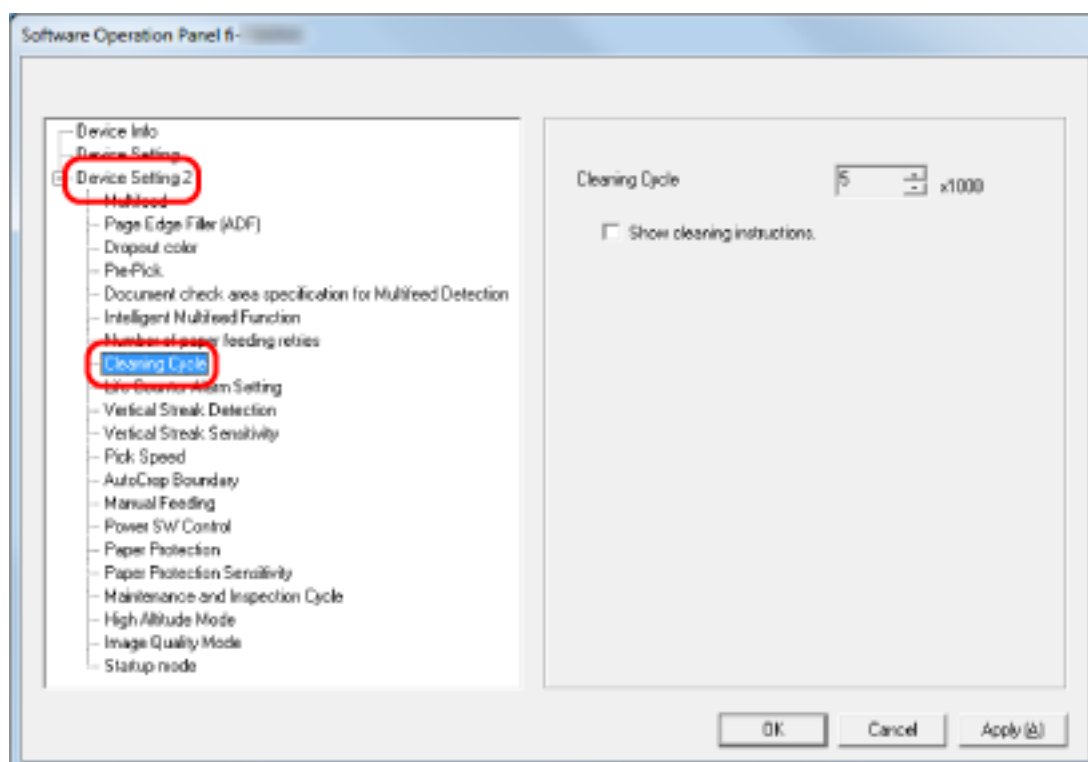

### 3 Specify a value for the cleaning cycle.

The value can range from 1,000 to 255,000 sheets (in increments of 1,000).

The factory default setting is "5".

### 4 Specify whether or not to display the cleaning instruction message.

The [Show cleaning instructions] check box is cleared for the factory default settings.

## Replacement Cycle of Consumables [Life Counter Alarm Setting]

Specify the replacement cycle for the consumables.

The background color of the counter for [Brake Roller] or [Pick Roller] in [Device Setting] changes to light yellow when the sheet count (after a consumable replacement) reaches 95% of the value specified for this setting and turns yellow when the sheet count reaches 100%.

You can also display the message for replacing consumables, which is described in [Messages for Cleaning or Replacing Consumables](#) (page 283).

### 1 Start up the Software Operation Panel.

For details, refer to [Starting Up the Software Operation Panel](#) (page 262).

### 2 From the list on the left, select [Device Setting 2] → [Life Counter Alarm Setting].

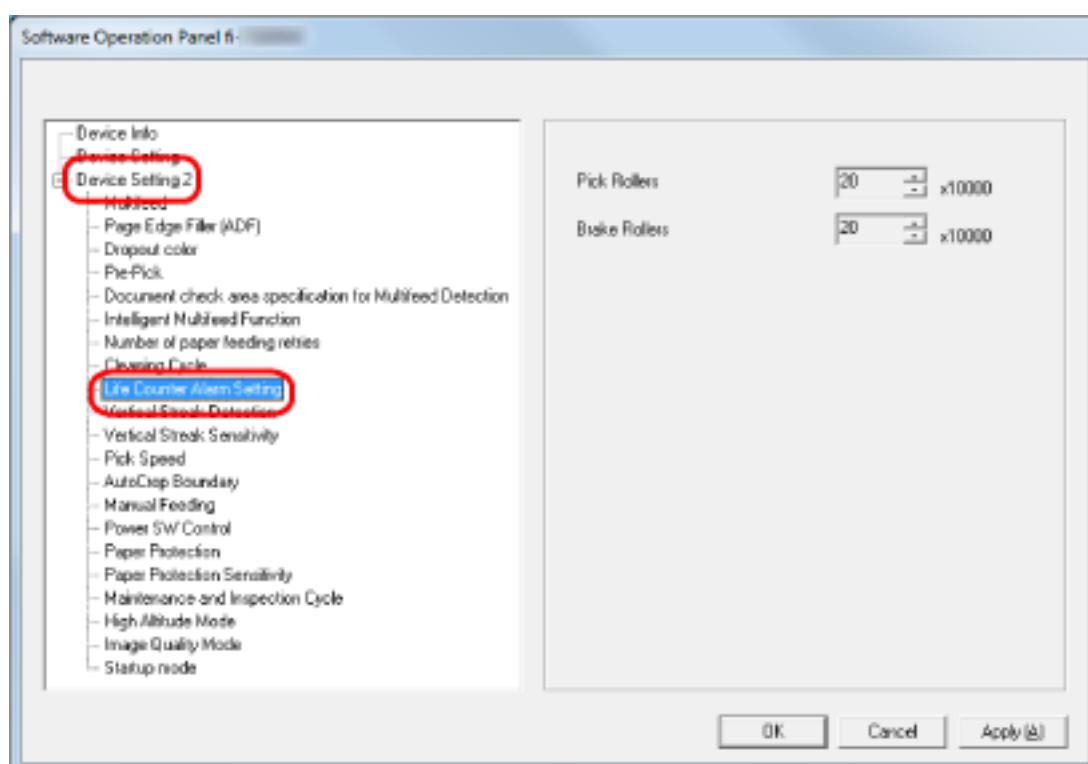

### 3 Specify a value as the replacement cycle for each of the consumables (brake roller and pick roller).

The value can range from 10,000 to 2,550,000 sheets (in increments of 10,000).

The factory default setting is "20".

## Settings Related to Scanning

### Adjusting the Position to Start the Scan [Offset Setting/Vertical magnification Adjustment]

When the output position of the scanned image is not correct or the image appears shortened/elongated (vertically), adjust the offset and the vertical magnification.

#### ATTENTION

Normally, you should not have to modify anything as the factory default settings already use adjusted values.

- 1 Start up the Software Operation Panel.  
For details, refer to [Starting Up the Software Operation Panel \(page 262\)](#).
- 2 From the list on the left, select [Device Setting] and click the [Offset] button.

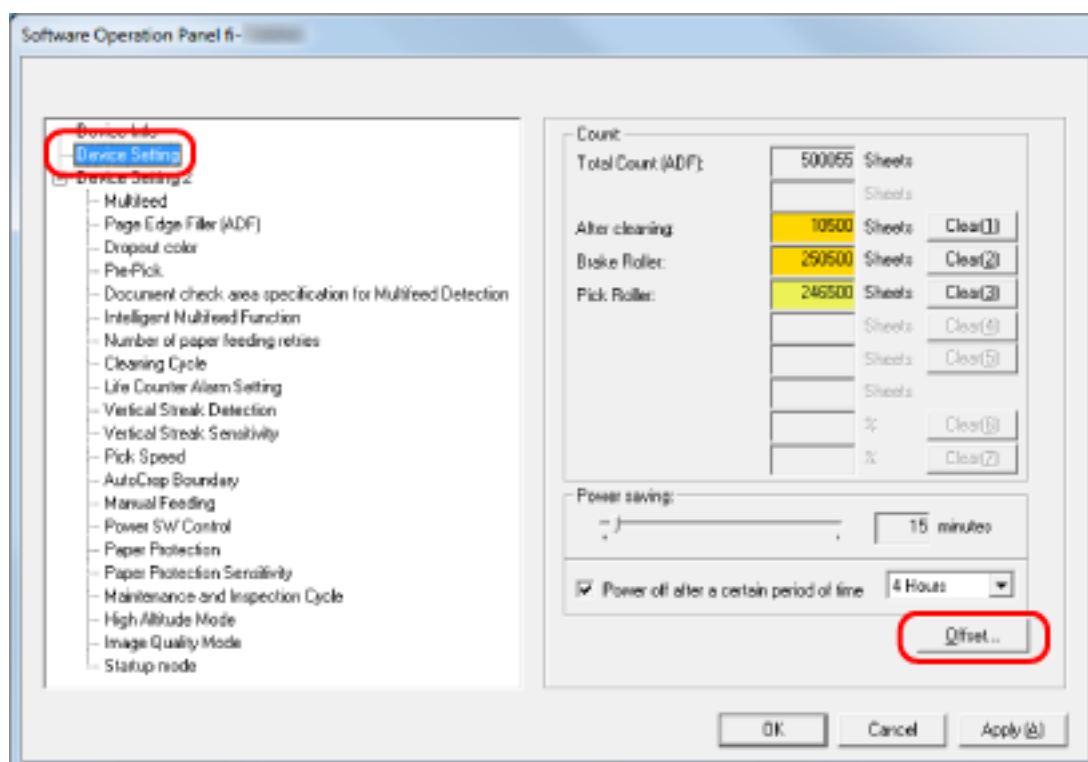

### 3 Adjust the level of offset/vertical magnification as needed.

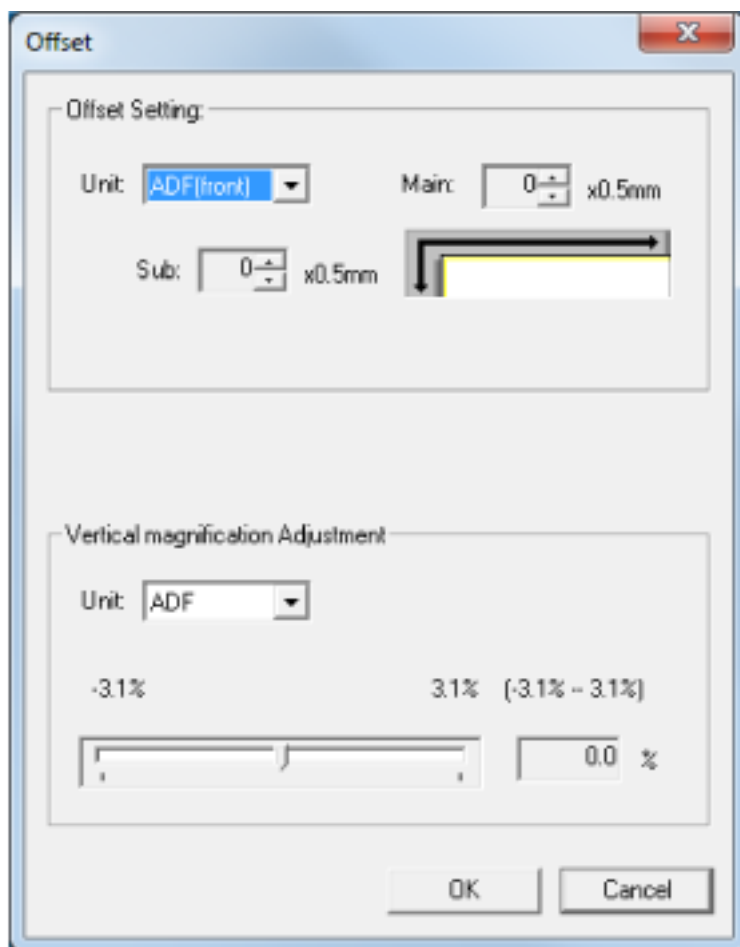

#### Offset Setting

##### Unit

Select [ADF (front)] or [ADF (back)] as the unit for an offset adjustment.  
The factory default setting is [ADF (front)].

##### Main

Specify the horizontal (width) offset.  
The specified value can range from -2 to +2 mm (in increments of 0.5).  
The factory default setting is "0".

##### Sub

Specify the vertical (length) offset.  
The specified value can range from -2 to +2 mm (in increments of 0.5).  
The factory default setting is "0".

## Vertical magnification Adjustment

### Unit

The unit for a vertical magnification adjustment is fixed to [ADF].

### Vertical magnification Adjustment

Specify the vertical (length) magnification.

The specified value can range from -3.1 to +3.1% (in increments of 0.1).

The factory default setting is "0.0".

## Removing Shadows/Streaks that Appear around Edges of Images [Page Edge Filler (ADF)]

Configure the settings to fill in the shadow or streaks around the edge of the scanned image. Depending on the condition of the documents that you scan, the shadow of a document may appear as black streaks on the edges of the scanned image.

In this case, remove the black streaks by filling in the edges of the scanned image.

### 1 Start up the Software Operation Panel.

For details, refer to [Starting Up the Software Operation Panel \(page 262\)](#).

### 2 From the list on the left, select [Device Setting 2] → [Page Edge Filler (ADF)].

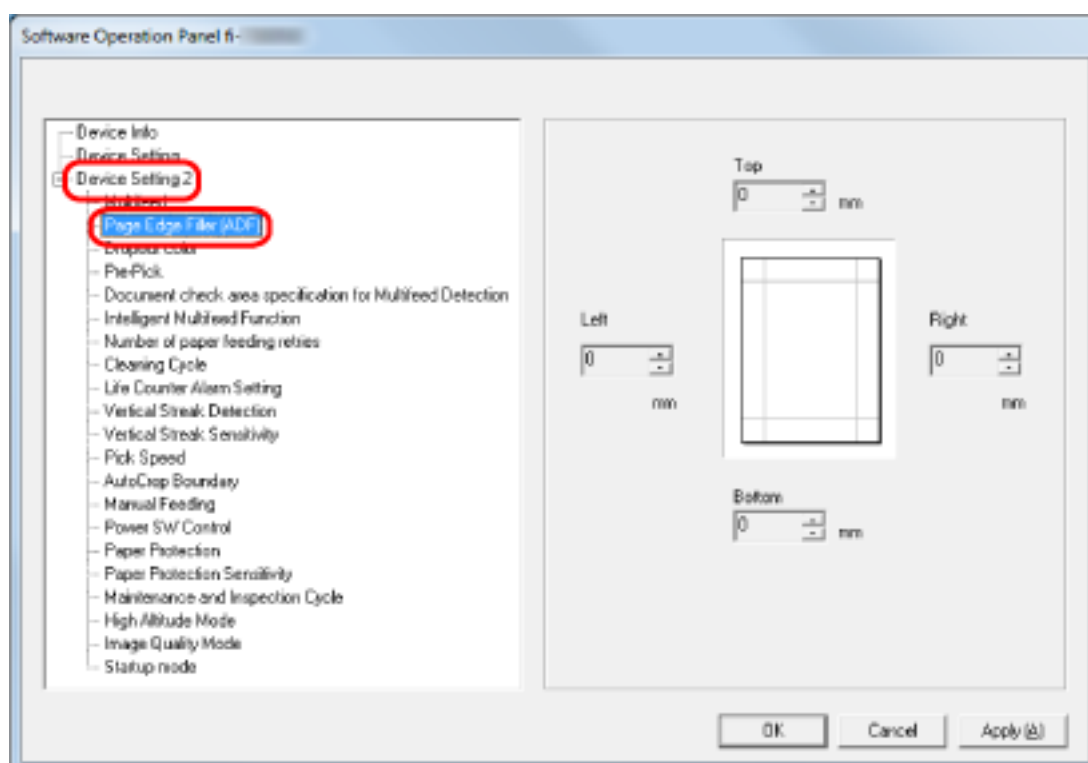

### 3 Specify the width of each margin (Top/Bottom/Right/Left) to fill in.

The factory default setting is "0".

The specified area is filled in white or black, according to the background color.

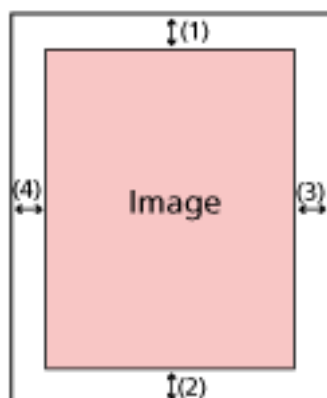

- (1): Top = 0 to 15 mm
  - (2): Bottom = -7 to 7 mm
  - (3): Right = 0 to 15 mm
  - (4): Left = 0 to 15 mm
- (in 1 mm increments)

#### ATTENTION

Note that if the target range of page edge filler is too wide, some characters near the edge may appear missing.

#### TIP

- You can change the background color to black or white in the scanner driver. For details, refer to the help for the scanner driver.
- Depending on the value you specify for the bottom margin of the page edge filler, the page edge filler function operates as follows:
  - 1 to 7 mm  
Fills in the specified area with the background color from the bottom edge of the image towards the inside.
  - -1 to -7 mm  
Outputs the image without filling in the specified area with the background color from the bottom edge of the image towards the outside. (Outputs the image with the specified area added when [Page End Detection] is set in the scanner driver.)
- This setting can also be configured in the scanner driver. In such a case, the page edge filler of the scanner driver is used on the image which the scanner already filled in the edges.

## Configuring the Scan Setting to Drop Out Specified Colors When Scanning [Dropout color]

You can exclude a color from being scanned by selecting either red, green, or blue (three primary colors).

Documents can be scanned without excluding any colors.

For example, when scanning a document with black characters and a green frame, if you select green for the dropout color, only the black characters of the document are scanned.

### 1 Start up the Software Operation Panel.

For details, refer to [Starting Up the Software Operation Panel \(page 262\)](#).

### 2 From the list on the left, select [Device Setting 2] → [Dropout color].

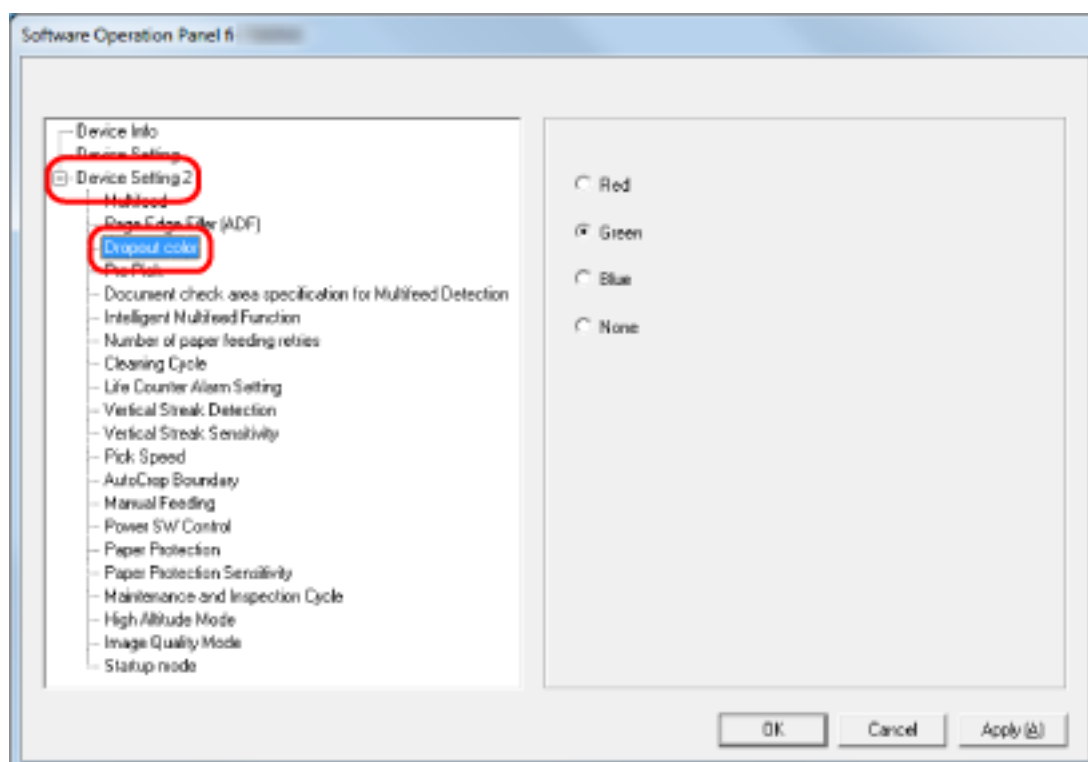

### 3 Select a color that you want to remove.

#### Red, Green, Blue

The selected color is removed.

The factory default setting is [Green].

#### None

No color is removed.

#### ATTENTION

- This function works the best with light (low intensity) colors, and dark colors may not be excluded.

- You cannot specify a color other than Red, Green, and Blue.  
To drop out other colors, configure the setting in the scanner driver.  
For details, refer to the help for the scanner driver.

**TIP**

- This is only available in black & white or grayscale mode.
- This setting can also be configured in the scanner driver.  
Note that priority is given to the scanner driver setting.

## Shortening the Scanning Intervals [Pre-Pick]

Enable this to shorten the scanning time when scanning continuously.

"Pre-pick" refers to feeding the next document into the ADF before ejecting the current document being scanned when scanning documents continuously.

### 1 Start up the Software Operation Panel.

For details, refer to [Starting Up the Software Operation Panel \(page 262\)](#).

### 2 From the listing on the left, select [Device Setting 2] → [Pre-Pick].

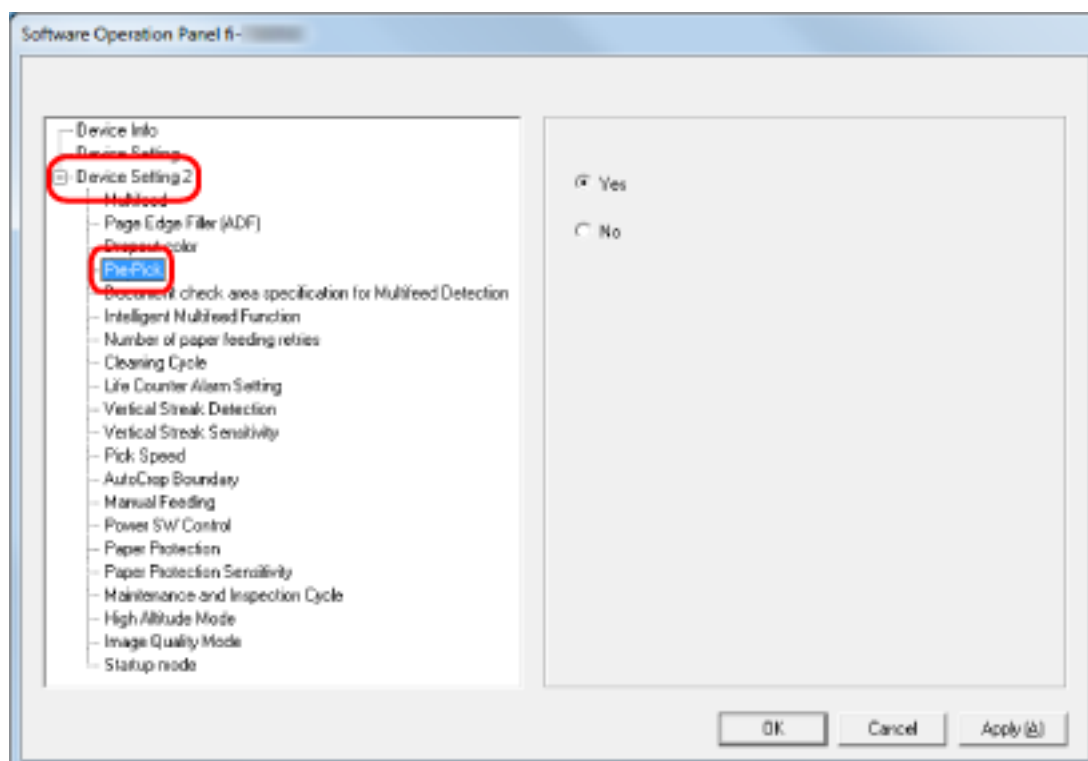

### 3 Specify whether or not to enable pre-pick.

Select [Yes] or [No].

The factory default setting is [Yes].

#### TIP

- If you cancel in the middle of scanning while pre-pick is enabled, you have to remove the pre-picked document, then load the document again.
- This setting can also be configured in the scanner driver.  
Note that priority is given to the scanner driver setting.

## Specifying the Number of Retries for Paper Feeding [Number of Paper Feeding Retries]

Specify the number of feeding retries when a document is not fed from the ADF paper chute (feeder).

**1 Start up the Software Operation Panel.**

For details, refer to [Starting Up the Software Operation Panel \(page 262\)](#).

**2 From the list on the left, select [Device Setting 2] → [Number of paper feeding retries].**

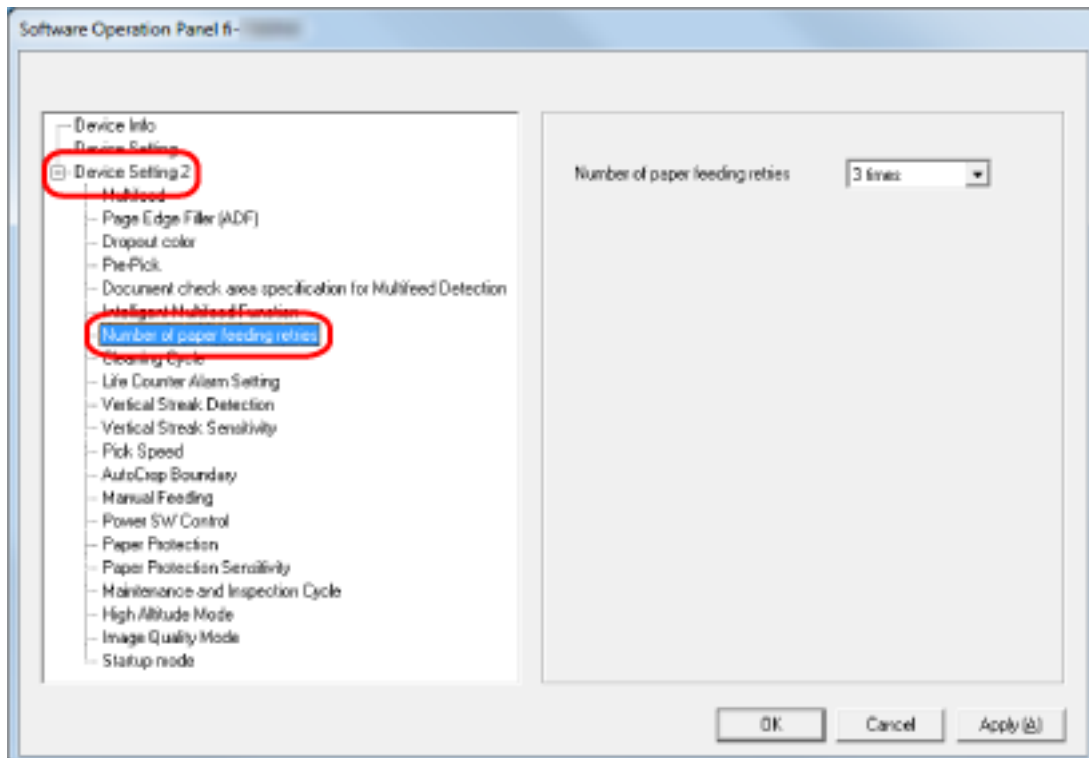

**3 Specify the number of paper feeding retries.**

The value can range from 1 to 12 times.

The factory default setting is "3 times".

## Feeding [Pick Speed]

You can specify the timing of when document feeding is started.

When overlapped documents or paper jams occur frequently, delaying the timing of document feeding may improve the performance.

This setting is effective when you scan thin paper.

### 1 Start up the Software Operation Panel.

For details, refer to [Starting Up the Software Operation Panel \(page 262\)](#).

### 2 From the list on the left, select [Device Setting 2] → [Pick Speed].

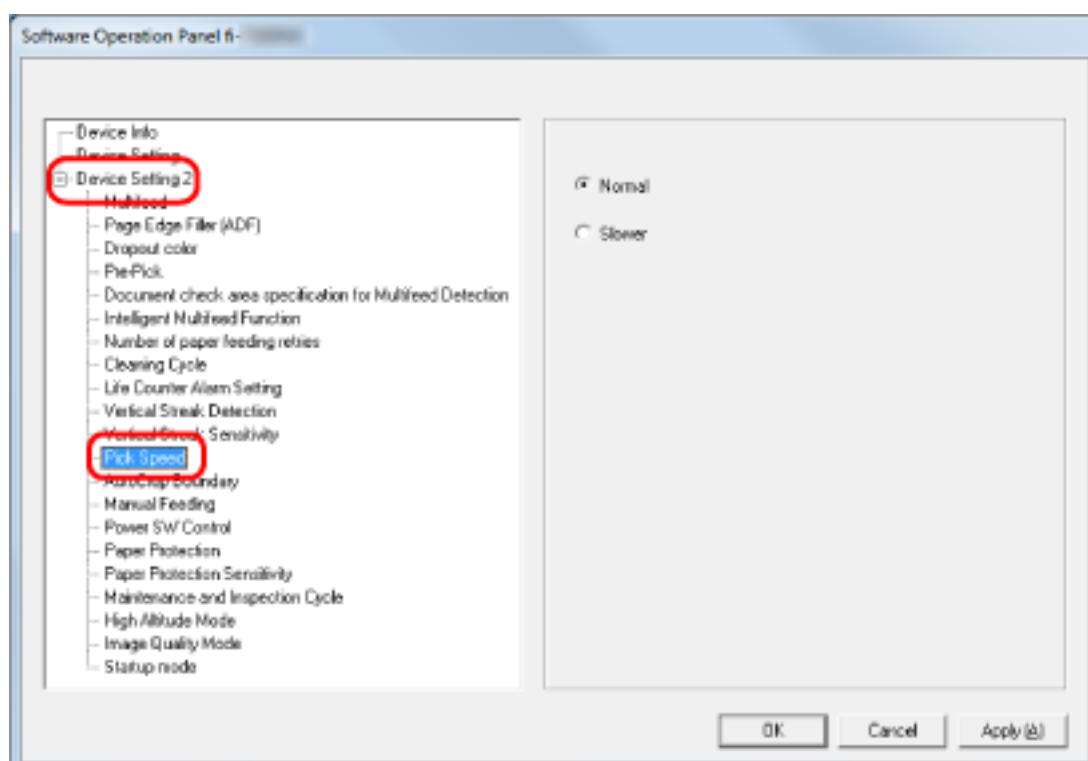

### 3 Select the feeding speed.

#### Normal

This is the optimum feeding speed.

This is the factory default setting.

#### Slower

The timing of document feeding is delayed more than [Normal].

#### ATTENTION

The total time for scanning is longer because the timing of document feeding is delayed.

## Cropping the Image Boundary [AutoCrop Boundary]

When the scanner is set to detect the paper size automatically, specify whether or not to optimize (round up/down) the fractional part of the scanned image.

When the paper size is detected, there may be a fractional part of the scanned image compared to the standard paper size.

Output image size varies depending on how the fractional part is processed.

### 1 Start up the Software Operation Panel.

For details, refer to [Starting Up the Software Operation Panel \(page 262\)](#).

### 2 From the list on the left, select [Device Setting 2] → [AutoCrop Boundary].

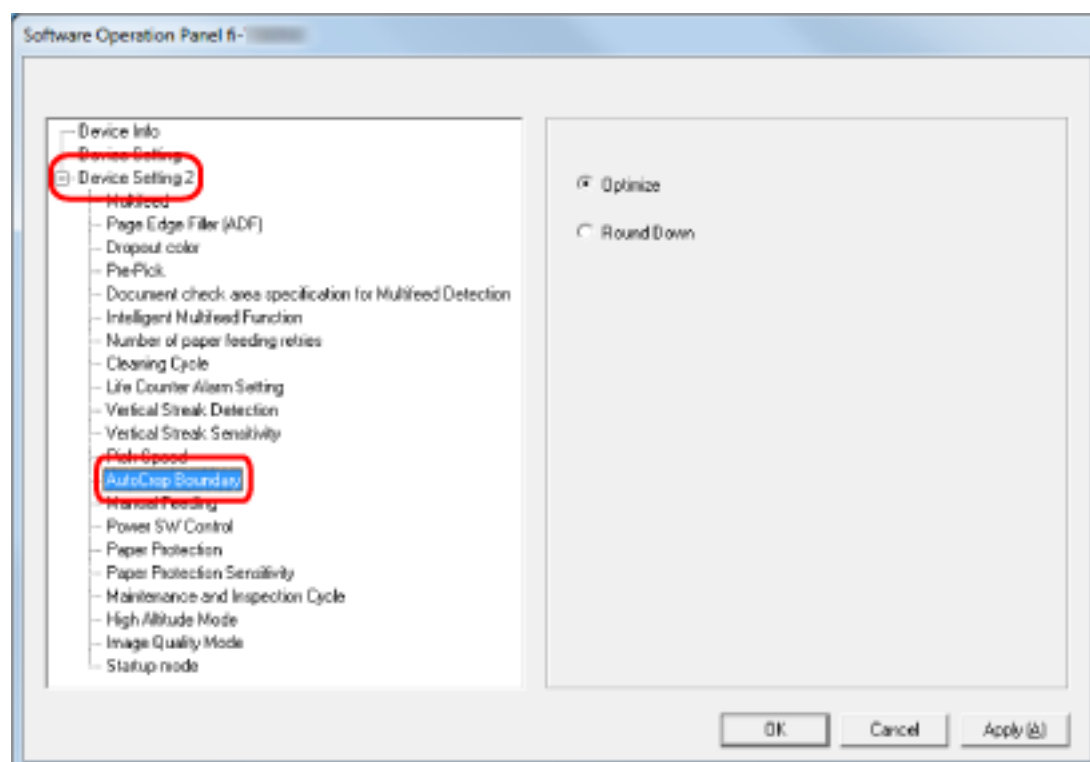

### 3 Select whether to include or exclude the fractional data.

Select [Optimize] to prevent information from missing a part.

The factory default setting is [Optimize].

#### ATTENTION

- While selecting [Optimize] can prevent information from missing a part, a shadow may appear around the edges.
- When you scan a document with text around the edges while [Round Down] is selected, a part of the information may be missing in the output image.
- For details about setting automatic page size detection, refer to the help for the scanner driver.

**TIP**

This setting is effective only for scanning images in black & white.

## Protecting the Documents from Being Damaged [Paper Protection]

Configure the setting to detect feeding errors.

This function detects feeding errors in the following cases:

- When the scanner detects a warped document caused by a feeding error
- When the scanner detects paper jam noise

Paper jams due to feeding errors could damage or tear valuable documents.

Detecting a feeding error and stopping the scan can prevent damage to documents.

This function is effective when you scan documents which are difficult to feed such as thin paper documents.

### 1 Start up the Software Operation Panel.

For details, refer to [Starting Up the Software Operation Panel \(page 262\)](#).

### 2 From the listing on the left, select [Device Setting 2] → [Paper Protection].

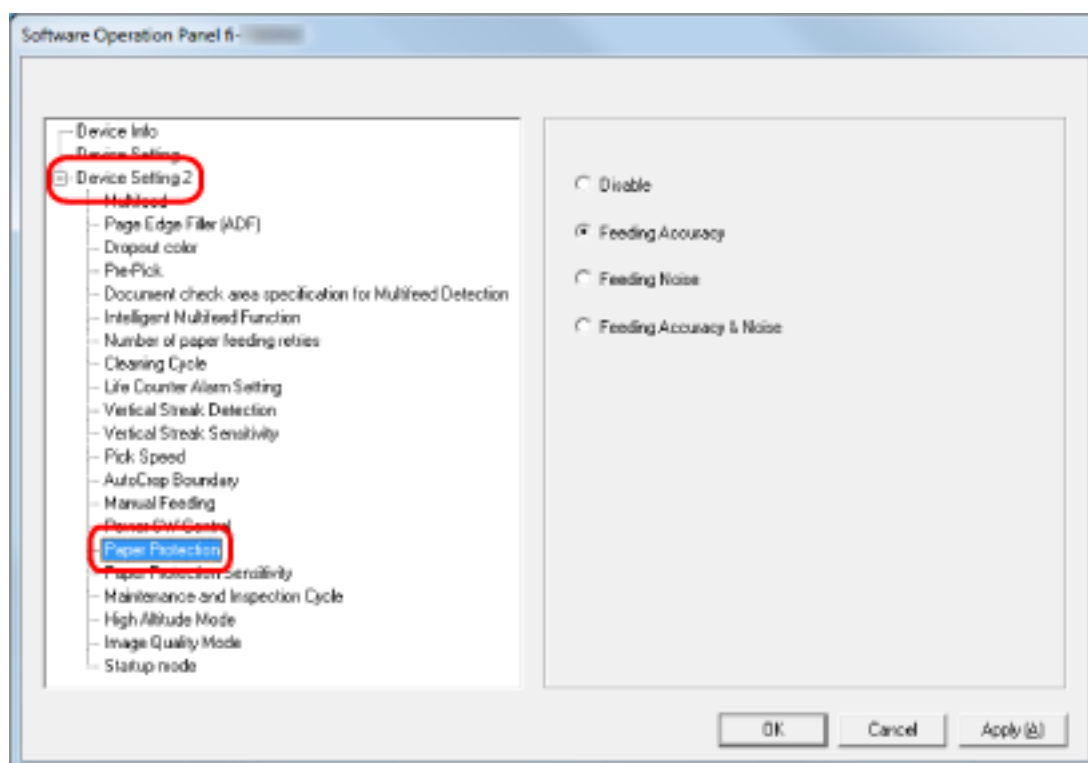

### 3 Select a detection method.

#### Disable

Does not detect feeding errors.

#### Feeding Accuracy

Stops the scan when the scanner detects a warped document caused by a feeding error.

This is the factory default setting.

### Feeding Noise

Stops the scan when the scanner detects paper jam noise.

### Feeding Accuracy & Noise

Stops the scan when the scanner detects a warped document caused by a feeding error, or when the scanner detects paper jam noise.

#### ATTENTION

- Note that the paper protection function is to prevent damages to documents, but the protection of all documents is not guaranteed.
- When you use the paper protection function, make sure to load the documents with their top edges aligned (especially for a mixed batch of documents with different lengths). If the top edges are not aligned properly, the scan may stop even when the documents are being fed correctly.

#### TIP

- If you scan a wrinkled document, the scan may stop even when the document is being fed correctly.  
In that case, the paper protection function can be disabled only for the document on the touch screen.  
For details, refer to [Disabling the Paper Protection Function \(page 118\)](#).
- If the paper protection function stops scans frequently, refer to [Paper Protection Is Set Off Frequently \(page 218\)](#).
- This setting can also be configured in the scanner driver.  
When the paper protection setting is set to on in the scanner driver, [Feeding Accuracy & Noise] is enabled regardless of the setting on the Software Operation Panel.
- For the paper protection setting, priority will be given in the following order:
  1. [Paper Protection] in the scanner driver
  2. [Paper Protection (Touch Screen Settings)] on the touch screen
  3. [Paper protection] on the touch screen or [Paper Protection] on the Software Operation Panel

## Specifying the Sensitivity Level for Paper Protection [Paper Protection Sensitivity]

Specify the sensitivity level for detecting feeding errors when the paper protection function is enabled. Documents are warped and deformed or paper jam noise is made when documents are not being fed properly.

Specify the sensitivity level for detecting deformed documents by warpage or feeding noise.

### 1 Start up the Software Operation Panel.

For details, refer to [Starting Up the Software Operation Panel \(page 262\)](#).

### 2 From the list on the left, select [Device Setting 2] → [Paper Protection Sensitivity].

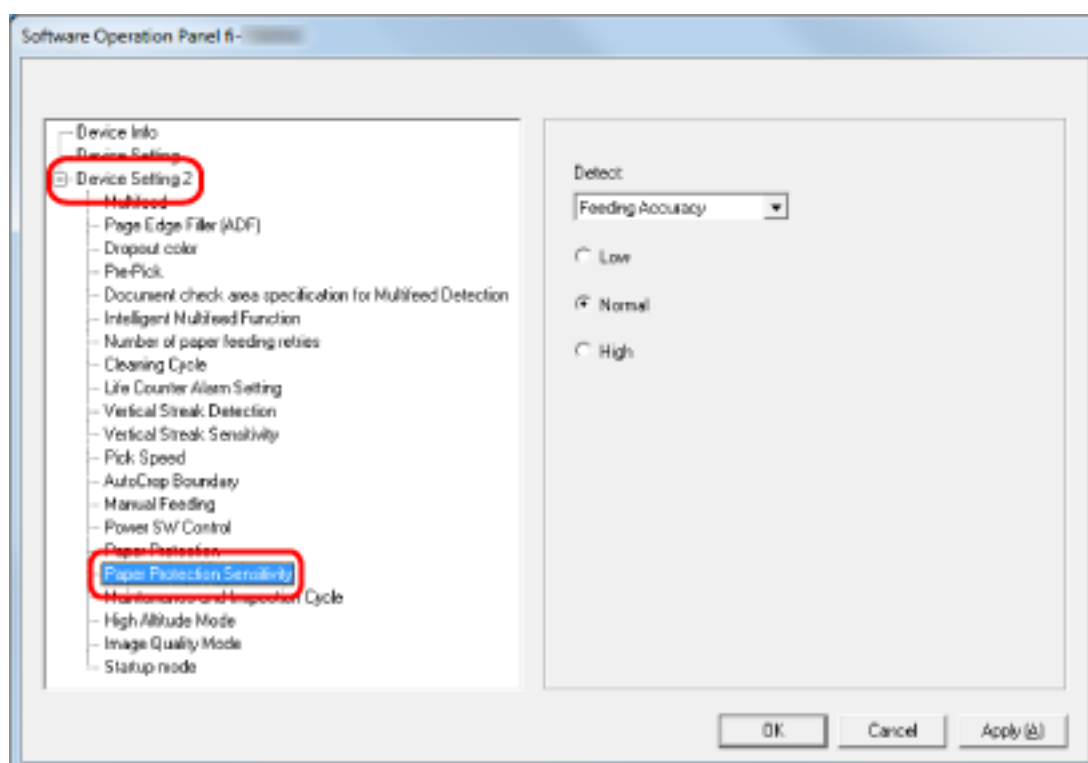

### 3 Select a detection method.

#### Feeding Accuracy

This is available when [Detect] for [Paper Protection] is either [Feeding Accuracy] or [Feeding Accuracy & Noise].

#### Feeding Noise

This is available when [Detect] for [Paper Protection] is either [Feeding Noise] or [Feeding Accuracy & Noise].

### 4 Select the sensitivity level.

#### Low

Decreases the sensitivity level to detect warped documents or paper jam noise.

Specify this to only detect highly deformed documents by warpage or loud paper noise.

**Normal**

Detects warped documents and paper jam noise with the optimum sensitivity.  
This is the factory default setting.

**High**

Increases the sensitivity level to detect warped documents or paper jam noise.  
Specify this to detect even slightly deformed documents by warpage or slight paper jam noise.

**TIP**

- To detect warped documents or paper jam noise immediately and stop the scan, select [High].
- If scanning stops frequently due to the paper protection function, select [Low].
- When the setting is to prioritize the touch screen setting, the touch screen setting is prioritized over the Software Operation Panel setting.

## Scanning at High Altitude [High Altitude Mode]

Enable this mode to use the scanner at an altitude of 2,000 m or higher.

Low atmospheric pressure at high altitudes may lower the accuracy in detections for overlapped documents with the ultrasonic sensor.

Setting [Enable] to on for High Altitude Mode improves the accuracy to detect overlapped documents.

### 1 Start up the Software Operation Panel.

For details, refer to [Starting Up the Software Operation Panel \(page 262\)](#).

### 2 From the list on the left, select [Device Setting 2] → [High Altitude Mode].

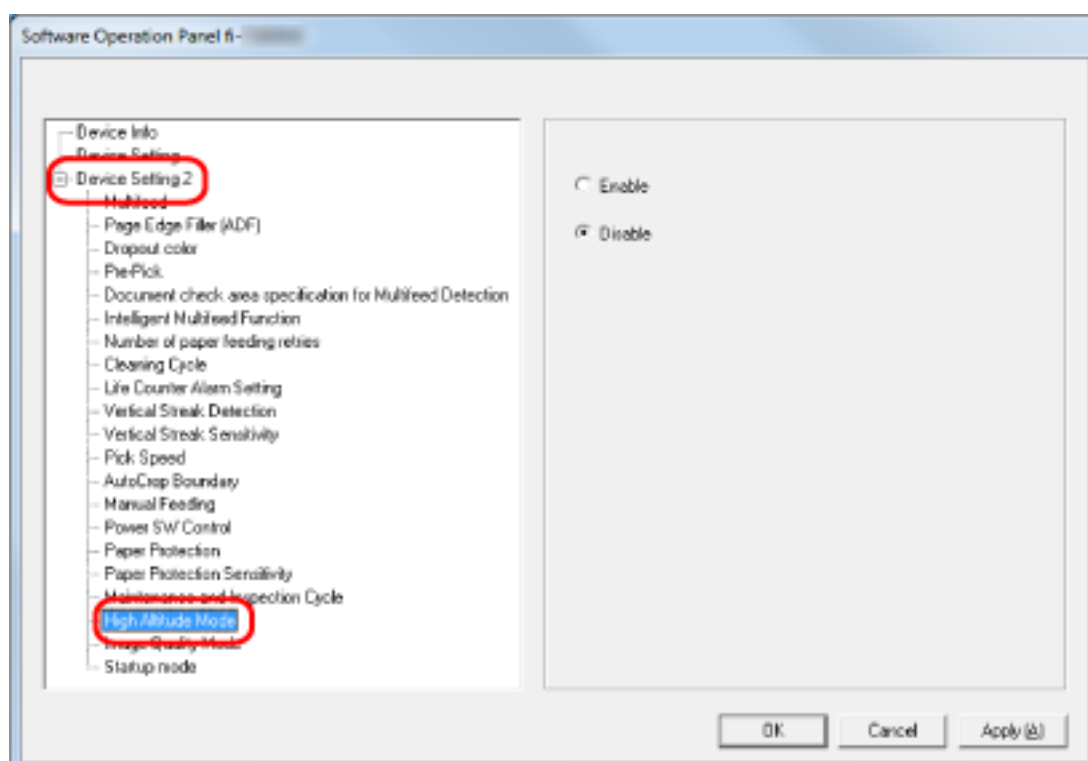

### 3 Select [Enable] to use the scanner at high altitude.

The factory default setting is [Disable].

## Specifying the Image Quality for Scanning [Image Quality Mode]

To obtain an image quality that is close to the image quality for scanning with fi-6130Z, set the image quality mode.

**1 Start up the Software Operation Panel.**

For details, refer to [Starting Up the Software Operation Panel \(page 262\)](#).

**2 From the list on the left, select [Device Setting 2] → [Image Quality Mode].**

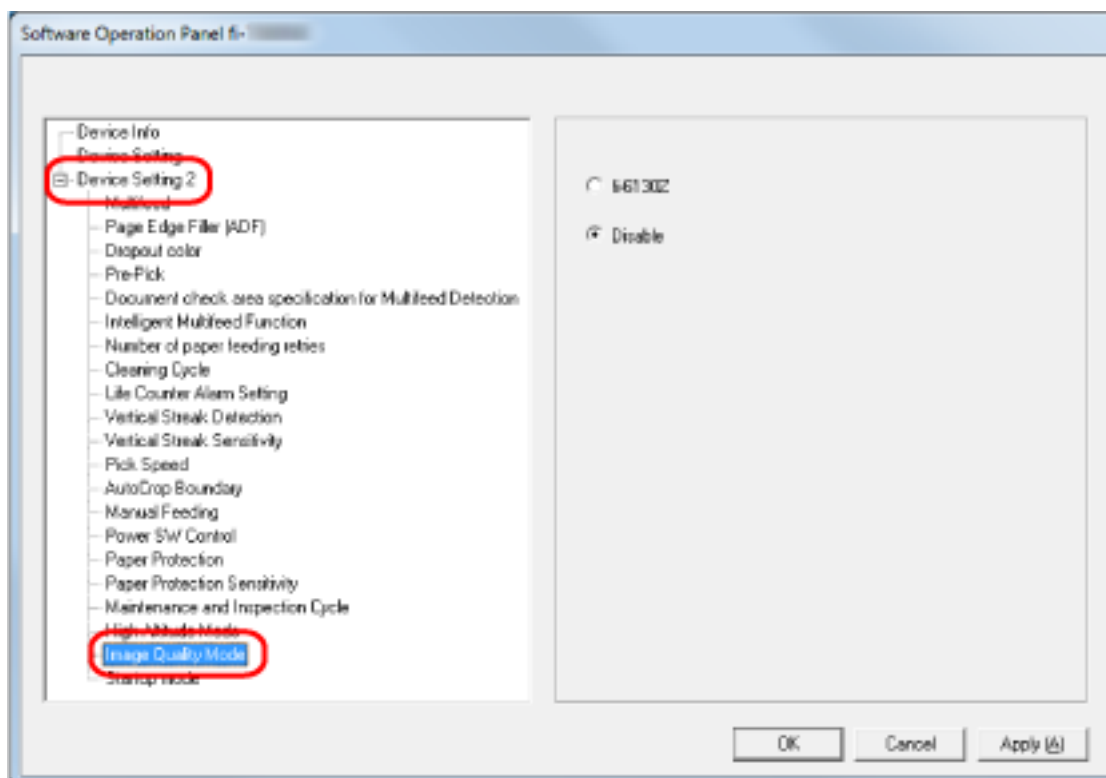

**3 Select whether to obtain an image quality that is close to the image quality with fi-6130Z.**  
The factory default setting is [Disable].

## Settings Related to the Detection for Overlapped Documents (Multifeed)

### Specifying a Method to Detect Overlapped Documents [Multifeed]

Multifeed is an error that occurs when two or more sheets are overlapped and fed at once.

Configure the settings to detect overlapped documents during a scan.

Overlapped documents are detected with the ultrasonic sensor or according to the difference in length of the documents.

When overlapped documents are detected, an error message is displayed on the touch screen and the scan stops. If documents are overlapped within 30 mm from the leading edge, they are not detected as overlapped.

#### 1 Start up the Software Operation Panel.

For details, refer to [Starting Up the Software Operation Panel \(page 262\)](#).

#### 2 From the list on the left, select [Device Setting 2] → [Multifeed].

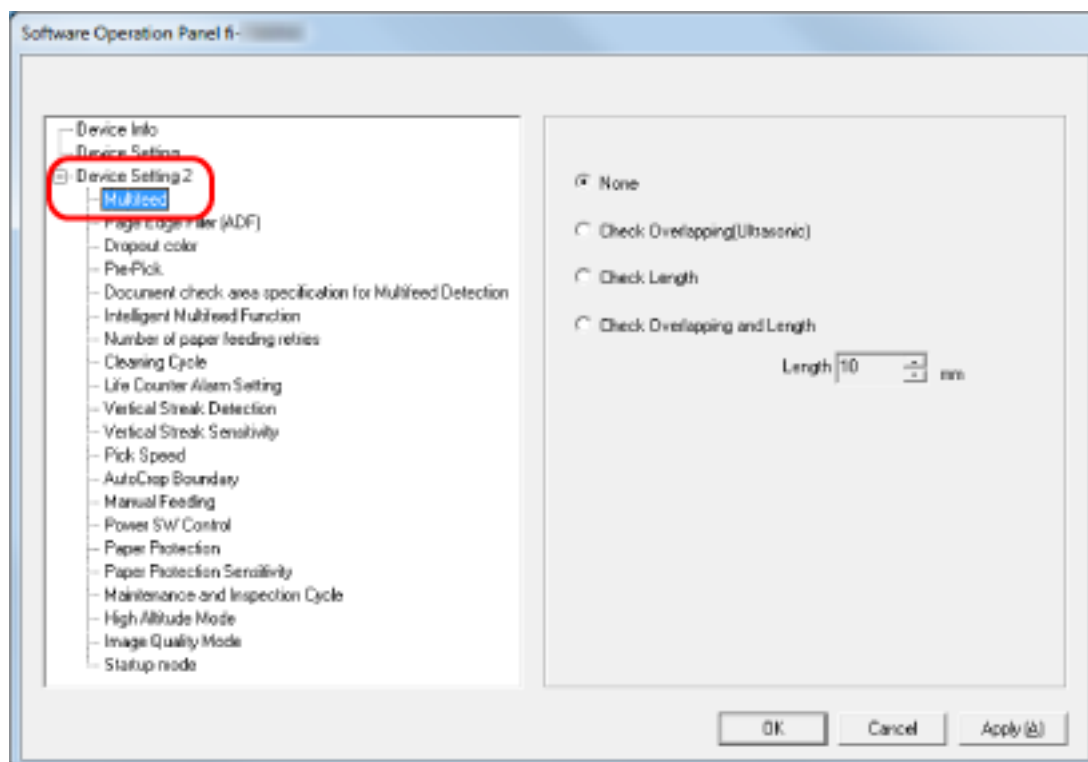

#### 3 Select a detection method.

##### None

Does not detect overlapped documents.

This is the factory default setting.

##### Check Overlapping(Ultrasonic)

Detects overlapped documents with the ultrasonic sensor.

When this is selected, you can specify the following two options:

- Specify an area to detect overlapped documents by the length from the leading edge of the document in the feeding direction.  
For details, refer to [Specifying the Area to Detect Overlapped Documents \[Document check area specification for Multifeed Detection\]](#) (page 307).
- When a piece of paper is attached on a document, the length and position of the paper can be memorized, and set to ignore overlapping of documents.  
For details, refer to [Configuring Not to Detect Certain Overlap Patterns](#) (page 115).

### Check Length

Detects overlapped documents according to the difference in length.

Select this to scan documents of the same length.

Note that overlapped documents cannot be detected accurately when a mixed batch of different lengths are scanned.

### Check Overlapping and Length

Detects overlapped documents by the combination of [Check Overlapping (Ultrasonic)] and [Check Length].

When this is selected, you can specify the following two options:

- Specify an area to detect overlapped documents by the length from the leading edge of the document in the feeding direction.  
For details, refer to [Specifying the Area to Detect Overlapped Documents \[Document check area specification for Multifeed Detection\]](#) (page 307).
- When a piece of paper is attached on a document, the length and position of the paper can be memorized, and set to ignore overlapping of documents.  
For details, refer to [Configuring Not to Detect Certain Overlap Patterns](#) (page 115).

Note that overlapped documents cannot be detected accurately when a mixed batch of different length are scanned.

### Length

Specify the difference in length of documents to be detected as overlapped documents. Overlapped documents are detected when the the difference in length of documents is longer than the specified value.

Specify this item when [Check Length] or [Check Overlapping and Length] is selected.

Any length under the specified value is tolerated as a slight error and not detected as overlapped documents.

Select from 10/15/20 mm. The factory default setting is "10".

#### ATTENTION

- To scan documents with different lengths, select [Check Overlapping (Ultrasonic)].
- When an attachment such as a sticky note, receipt, or photo is attached on the document, the attachment part of the document may be detected as overlapping of documents if [Check Overlapping (Ultrasonic)] is selected. In that case, select [Check Length].

Otherwise, detect overlapping of documents by specifying an area on the document that does not include an area attached with paper in order to ignore the overlapping of documents for that area.

**TIP**

- This setting can also be configured in the scanner driver.  
Note that priority is given to the scanner driver setting.
- When the Carrier Sheet setting is enabled in the scanner driver, the touch screen does not display the error message. The scanner driver does.

## Specifying the Area to Detect Overlapped Documents [Document check area specification for Multifeed Detection]

Specify an area to detect overlapped documents.

Specify this item when [Check Overlapping(Ultrasonic)] or [Check Overlapping and Length] is selected for [Multifeed].

### 1 Start up the Software Operation Panel.

For details, refer to [Starting Up the Software Operation Panel \(page 262\)](#).

### 2 From the list on the left, select [Device Setting 2] → [Document check area specification for Multifeed Detection].

Select the [Selected range] check box in the window.

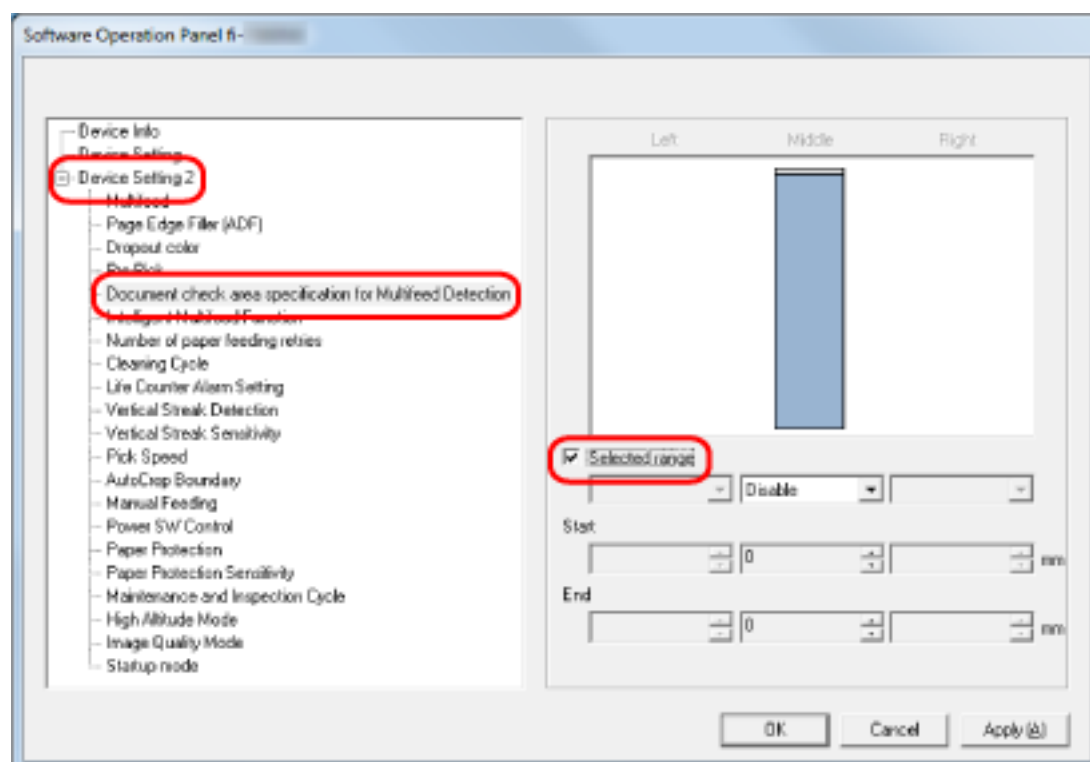

### 3 Specify the detection range.

**[Selected range] check box**

Select the check box to specify the detection range (colored in light pink) in the figure below.

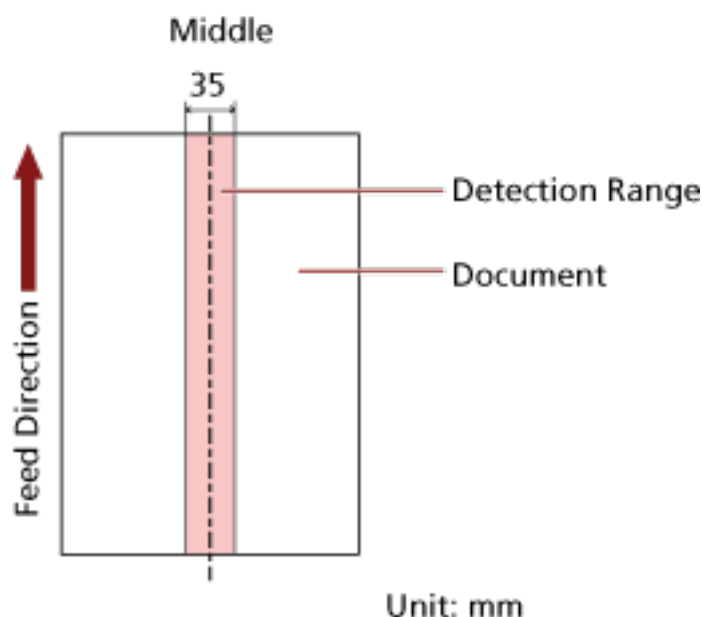

The check box is cleared for the factory default settings.

Clearing this check box sets both start and end positions to "0", and overlapped documents are detected within the whole document.

The above condition applies when the document is set to the center of the pick roller width. If documents are overlapped within 30 mm from the leading edge, they are not detected as overlapped.

**Disable (Middle)**

This can be selected when the [Selected range] check box is selected.

Overlapped documents are not detected within the specified area.

This is the factory default setting.

**Enable (Middle)**

This can be selected when the [Selected range] check box is selected.

Overlapped documents are detected within the specified area.

**Start (Middle)**

Specify the start position of the detection area by the length from the leading edge of the document in the feeding direction.

Range: 0 to 510 mm, in 2 mm increments, Start < End

The factory default setting is "0".

**End (Middle)**

Specify the end position of the detection area by the length from the leading edge of the document in the feeding direction.

Range: 0 to 510 mm, in 2 mm increments, Start < End  
The factory default setting is "0".

**TIP**

- When the start and end positions are both "0", overlapped documents are detected in the whole document regardless of the setting for [Selected range].
- To disable the detection of overlapped documents for the whole document, select [Disable] for [Selected range], and set the start position to "0" and the end position to equal the document length or longer.
- If the start position is set at a length longer than the document length, overlapped documents are detected in the whole document when [Disable] is selected for [Selected range], and overlapped documents are not detected anywhere in the whole document when [Enable] is selected for [Selected range].
- To detect overlapped documents, the area must be at least 5 mm in length. Configure the setting so that the value of the end position minus the start position is 6 mm or more.
- You can also set the start position and the end position by the following methods:
  - On the window for specifying the detection area, draw a square by dragging the mouse pointer.
  - On the window for specifying the detection area, drag the handles that indicate the start position and the end position.
- For examples of the overlapping detection area settings, refer to [Examples of the Settings for the Area to Detect the Overlapping of Documents \(page 310\)](#).

## ■ Examples of the Settings for the Area to Detect the Overlapping of Documents

### Example 1

Setting details are as follows.

Detection area: Specify the enabled area, Start: 50 mm, End: 200 mm

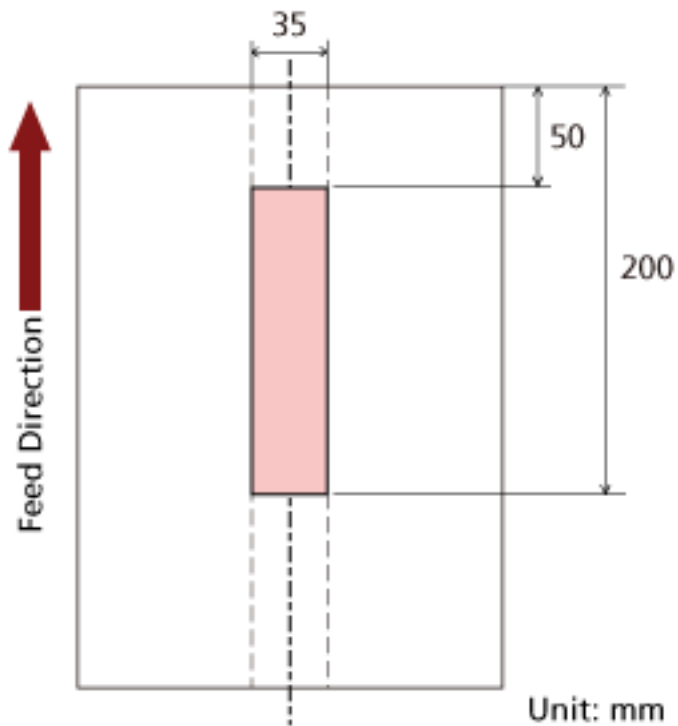

Overlapping of documents is detected only within the light pink area.

### Example 2

Setting details are as follows.

Detection area: Specify the disabled area, Start: 0 mm, End: 300 mm

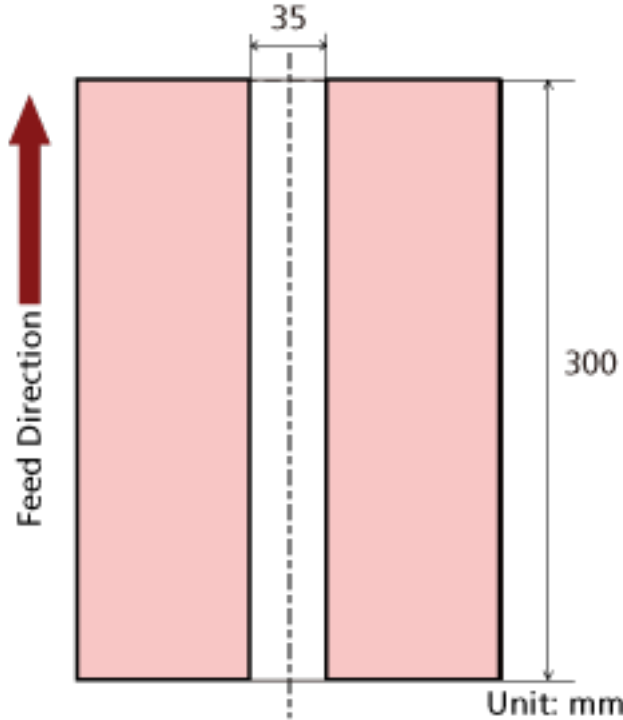

Overlapping of documents is detected only within the light pink area.

**Example 3 (Bad Example)**

Setting details are as follows.

Detection area: Specify the enabled area, Start: 100 mm, End: 102 mm

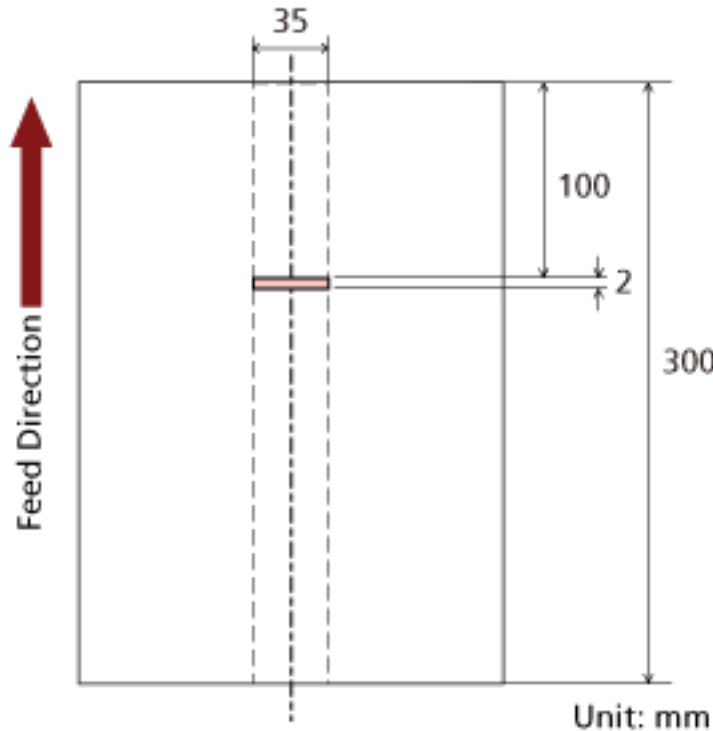

Since the detection area (length) is less than 5 mm, overlapped documents cannot be detected accurately.

## Setting to Ignore Certain Overlap Patterns [Intelligent Multifeed Function]

Configure the setting to automatically ignore certain patterns of overlapped documents when the setting to detect overlapped documents is enabled.

Note that you first need to specify [Check Overlapping (Ultrasonic)] or [Check Overlapping and Length] in the scanner driver and [Specifying a Method to Detect Overlapped Documents \[Multifeed\]](#) (page 304) on the Software Operation Panel before setting this item.

### 1 Start up the Software Operation Panel.

For details, refer to [Starting Up the Software Operation Panel](#) (page 262).

### 2 From the list on the left, select [Device Setting 2] → [Intelligent Multifeed Function].

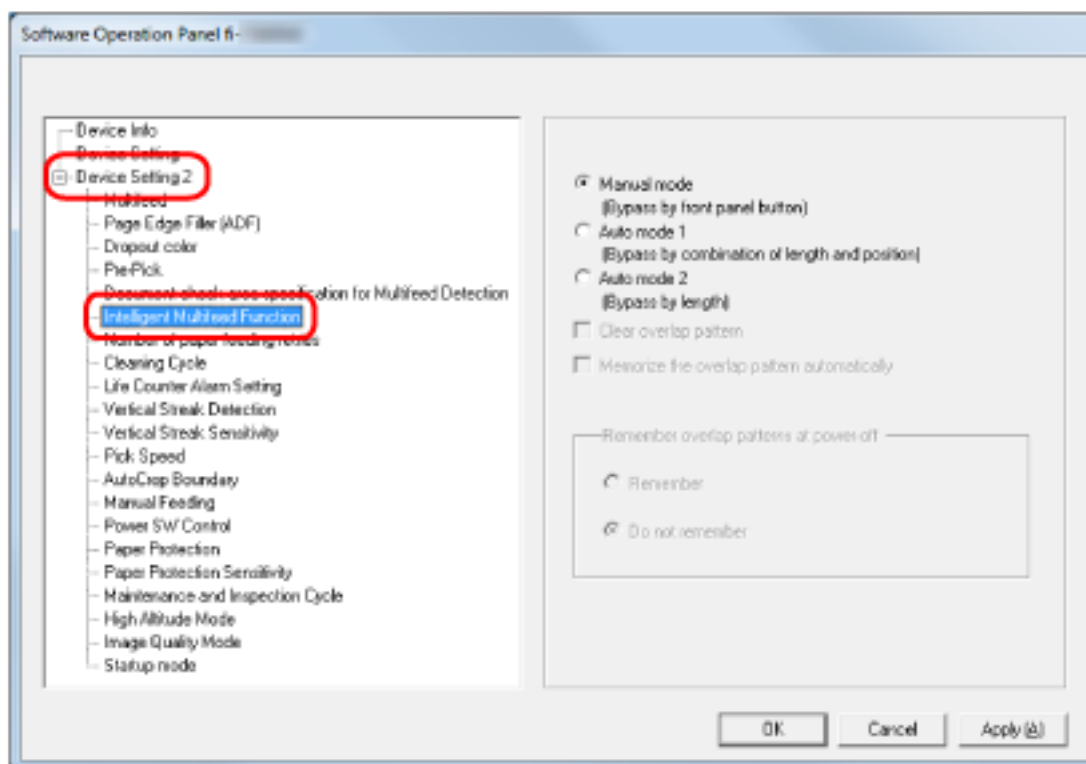

### 3 Select a operation mode.

#### Manual mode

Specify whether overlapped documents are detected when re-scanning documents detected as overlapped documents.

Does not memorize the size or location of the paper attachment.

This is the factory default setting.

#### Auto mode 1

Specify whether the length and position of a piece of paper attached on a document detected as overlapped documents are memorized as an overlap pattern.

If the overlap pattern is memorized, documents with the same overlap pattern are not detected as overlapped documents from the next scan.

**TIP**

When [Remember] in [Remember overlap patterns at power-off] is selected, among the memorized overlap patterns, only the overlap patterns memorized for the last eight sheets will be memorized.

**Auto mode 2**

Specify whether the length of the longest piece of paper attached on a document detected as overlapped documents is memorized as an overlap pattern.

If the overlap pattern is memorized, a document with a piece of paper in the same length or shorter attached is not detected as overlapped documents from the next scan.

**TIP**

- By selecting the [Clear overlap pattern] check box, you can erase the overlap patterns that were memorized in Auto mode.  
You can erase overlap patterns that were not supposed to be memorized, but be careful with this operation because all memorized patterns will be erased.  
The check box is cleared for the factory default settings.
- By selecting the [Memorize the overlap pattern automatically] check box, you can enable the function for memorizing an overlap pattern when overlapped documents are detected in Auto mode.  
The check box is cleared for the factory default settings.
- In [Remember overlap patterns at power-off], you can specify whether or not to keep the overlap pattern upon turning the power off.  
When [Remember] is specified, the overlap patterns memorized for the last eight sheets when the scanner is powered off can be used the next time the scanner is powered on.  
The factory default setting is [Do not remember].
- When the setting for using the Carrier Sheet is enabled in the scanner driver, [Intelligent Multifeed Function] is disabled.

## Settings Related to Waiting Time

### Waiting Time in Manual Feeding [Manual Feeding]

Configure the settings when manually loading and scanning one sheet at a time.

When you scan by manually loading one sheet at a time, you can specify the waiting time (interval) for loading the next document in the ADF paper chute (feeder). This enables continuous scanning as long as you load a document within the specified time.

If the specified time is exceeded, the scan is finished automatically.

#### 1 Start up the Software Operation Panel.

For details, refer to [Starting Up the Software Operation Panel \(page 262\)](#).

#### 2 From the list on the left, select [Device Setting 2] → [Manual Feeding].

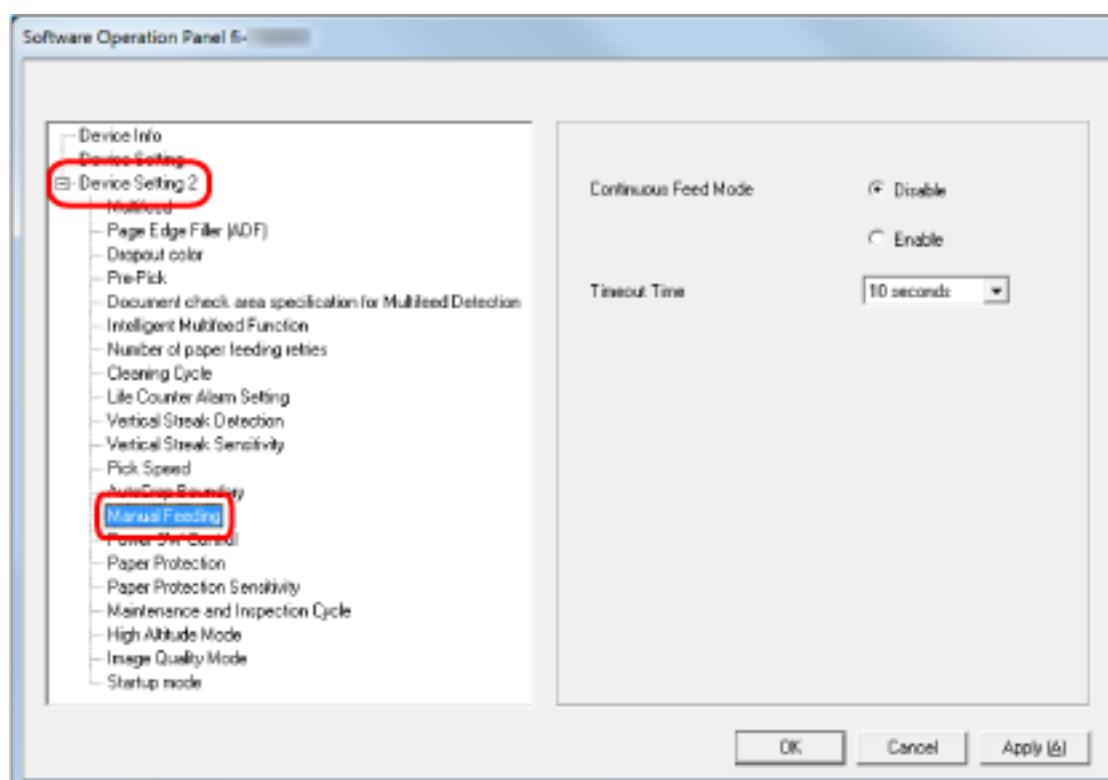

#### 3 Set [Timeout Time].

For [Timeout Time], specify the time period until which the scanner confirms that no documents are loaded in the ADF paper chute (feeder) (the interval between the last scan and the detection of whether the next document is loaded or not).

The factory default setting is "10 seconds".

- When scanning more than one document in succession manually
  1. Select [Enable] for [Continuous Feed Mode].
  2. Select the time for [Timeout Time].

- When scanning a document folded in half, an envelope, or a multi-layered transfer paper one at a time manually
  1. Slide the feed mode switch to the left to switch the feed mode to Manual Single Mode.
  2. Select the time for [Timeout Time].

**TIP**

- When [Enable] is selected for [Continuous Feed Mode], the scanner will wait for documents to be loaded until the specified timeout time elapses even if you start scanning with no document in the ADF paper chute (feeder).
- When the feed mode switch is set to Manual Single Mode, the scanner will wait for documents to be loaded until the specified timeout time elapses regardless of the setting for [Continuous Feed Mode].

## Waiting Time for the Scanner to Enter Power Saving Mode [Power saving]

Specify the waiting time before the scanner enters power saving mode.

### 1 Start up the Software Operation Panel.

For details, refer to [Starting Up the Software Operation Panel](#) (page 262).

### 2 From the list on the left, select [Device Setting].

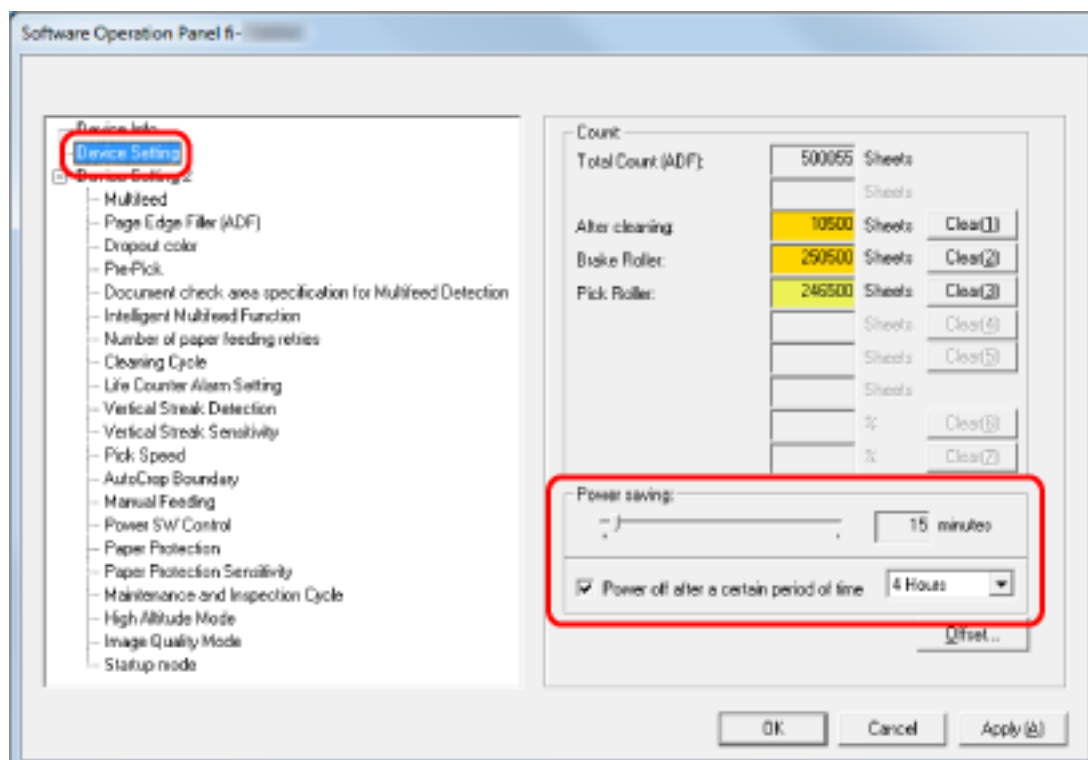

### 3 Use the slider to specify the waiting time for the scanner to enter power saving mode.

The value can range from 5 to 115 minutes (in increments of 5).

The factory default setting is "15" minutes.

#### TIP

- Selecting the [Power off after a certain period of time] check box turns the power off automatically if the scanner is left on for a certain period of time without being used. The check box is selected for the factory default setting. You can select the timeout period for the scanner to be automatically turned off by [1 Hour]/[2 Hours]/[4 Hours]/[8 Hours]. The factory default setting is "4 Hours". If one of the following items is selected, the scanner is not turned off even when the specified period of time for an auto shutdown has passed. The scanner's energy consumption will increase.
  - [Fast] is selected for [Startup mode]
  - [Disable power switch] is selected for [Power Switch Control]

- When the [Power off after a certain period of time] check box is cleared, the scanner's energy consumption will increase.

## Settings Related to Power On/Off and Start up of the Scanner

### Method of Turning the Scanner ON/OFF [Power Switch Control]

Specify whether or not to turn on/off the scanner by pressing the [Power] button on the scanner.

**1 Start up the Software Operation Panel.**

For details, refer to [Starting Up the Software Operation Panel \(page 262\)](#).

**2 From the list on the left, select [Device Setting 2] → [Power Switch Control].**

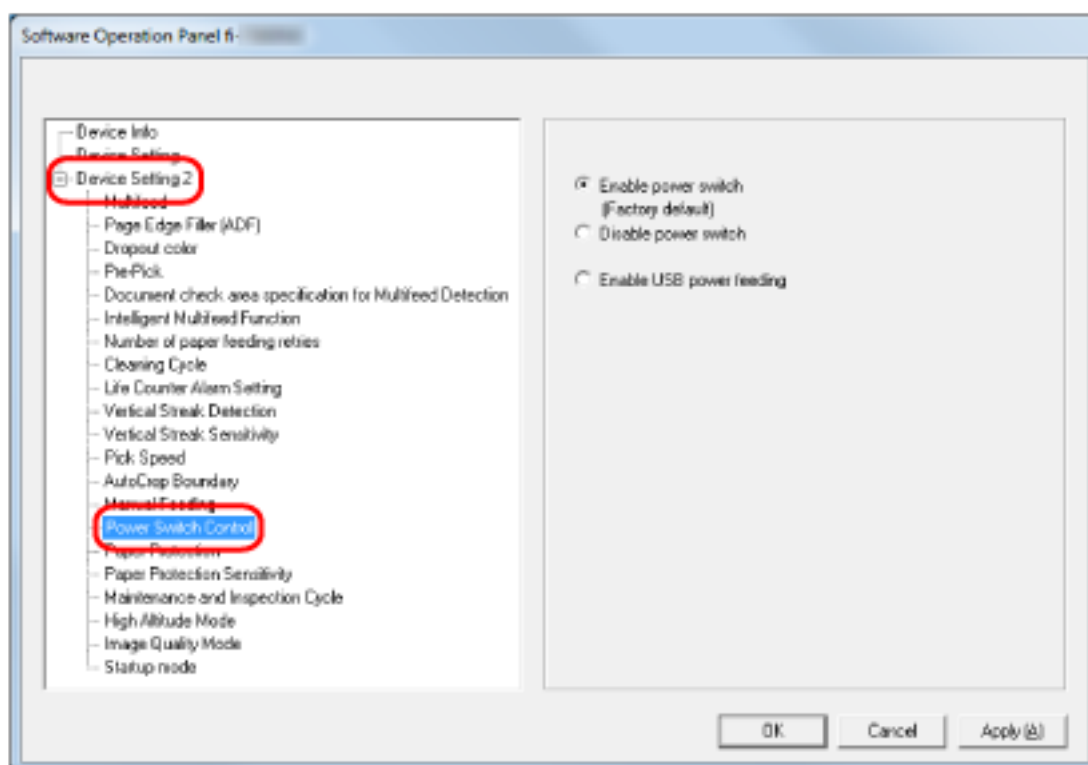

**3 Select one of the following:**

**Enable power switch**

The [Power] button on the scanner is used to turn on/off the scanner.  
This is the factory default setting.

**Disable power switch**

Select this to use an AC power strip to control power supply for peripherals such as a scanner in accordance with the computer's power.  
The [Power] button on the scanner is not used to turn on/off the scanner.

**Enable USB power feeding**

This can be selected when the scanner and the computer are connected via a USB cable.

In addition to the [Power] button on the scanner, turning on/off the computer can simultaneously turn on/off the scanner.

Connecting/disconnecting a USB cable can turn on/off the scanner.

**ATTENTION**

Some types of computers and USB hubs keep supplying power to the USB bus even after the computer is turned off.

In that case, [Enable USB Power Feeding] may not work properly.

**TIP**

When [Disable power switch] is set, the scanner's energy consumption will increase.

## Startup Mode Setting for the Scanner [Startup mode]

Specify a startup mode for the scanner.

### 1 Start up the Software Operation Panel.

For details, refer to [Starting Up the Software Operation Panel \(page 262\)](#).

### 2 From the list on the left, select [Device Setting 2] → [Startup mode].

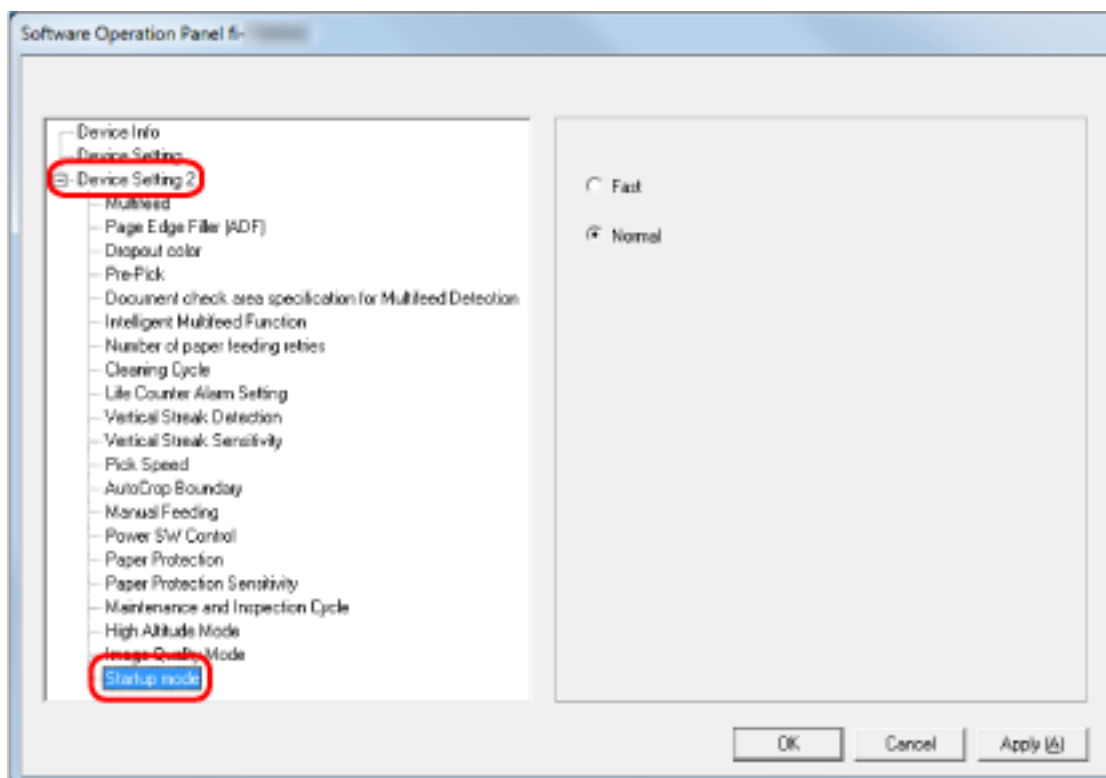

### 3 Select a startup mode for the scanner.

#### Fast

The scanner enters power saving mode by pressing the [Power] button for 2 seconds or more.

The scanner can perform a scan immediately when it resumes from power saving mode.

#### Normal

The scanner is turned off by pressing the [Power] button for 2 seconds or more.

This is the factory default setting.

#### ATTENTION

If you select [Fast], the scanner is not turned off regardless of the setting for [Power off after a certain period of time] in [Power saving].

The scanner's energy consumption will increase.

## Settings Related to Scanner Maintenance

### Detecting Vertical Streaks [Vertical Streak Detection]

You can configure the settings for detecting dirt on the glass.

Vertical streaks may appear on images if the glass is dirty.

If [Enable] is selected for the vertical streak detection setting, the touch screen displays a notification

on  when you receive a [Clean glass!] message. When you receive a message, clean the glass to prevent vertical streaks from appearing on images.

**1 Start up the Software Operation Panel.**

For details, refer to [Starting Up the Software Operation Panel \(page 262\)](#).

**2 From the list on the left, select [Device Setting 2] → [Vertical Streak Detection].**

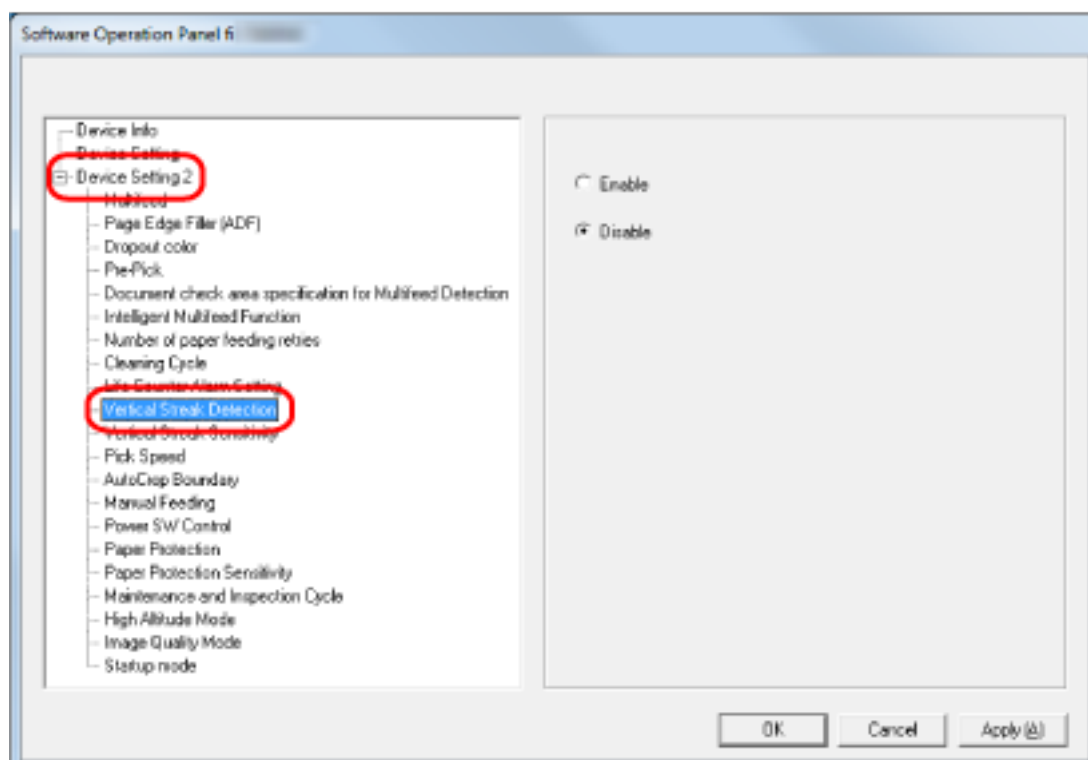

**3 Select whether or not to detect dirt on the glass (vertical streaks).**

When you select [Enable], the scanner detects dirt on the glass (vertical streaks).

The factory default setting is [Disable].

## Specifying the Sensitivity Level for Vertical Streak Detection [Vertical Streak Sensitivity]

Specify the sensitivity level to detect vertical streaks (dirt on the glass) when [Enable] is selected for [Vertical Streak Detection].

Adjust the sensitivity level according to how dirty the glass is.

### 1 Start up the Software Operation Panel.

For details, refer to [Starting Up the Software Operation Panel \(page 262\)](#).

### 2 From the list on the left, select [Device Setting 2] → [Vertical Streak Sensitivity].

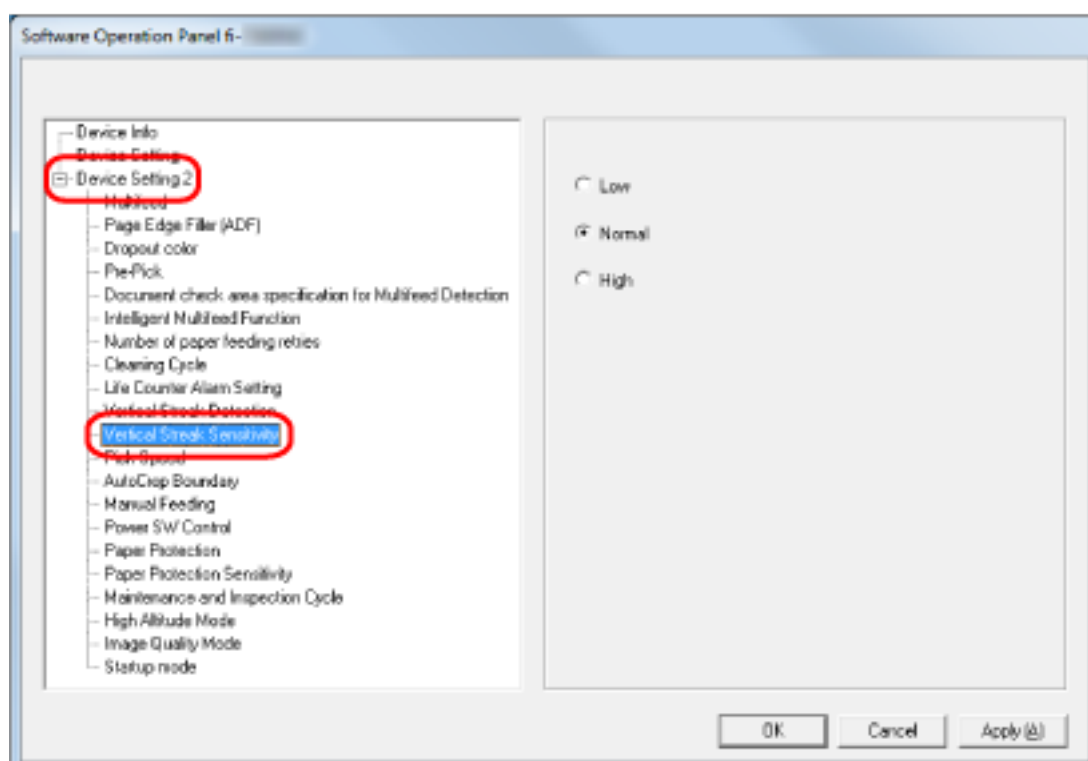

### 3 Select the sensitivity level to detect dirt on the glass.

#### Low

Decreases the sensitivity level to detect dirt on the glass.

Specify this to detect dirt only when the glass is very dirty.

#### Normal

Detects dirt on the glass with the optimum sensitivity.

This is the factory default setting.

#### High

Increases the sensitivity level to detect dirt on the glass.

Specify this to detect dirt even when the glass is slightly dirty.

## Settings Related to Scanner Maintenance and Inspection Cycle [Maintenance and Inspection Cycle]

Specify the maintenance and inspection cycle for the scanner that is performed by a service engineer. If the specified period has passed after the last maintenance and inspection date, the touch screen

displays a notification on  when you receive a [Maintenance] message.

For regular maintenance and inspection on the scanner by a service engineer, contact the distributor/ dealer where you purchased this product. Refer to the contact information in the Contact List if supplied with this product, or refer to the contact information in the Contact for Inquiries section if provided in Safety Precautions supplied with this product, and then make an inquiry.

### 1 Start up the Software Operation Panel.

For details, refer to [Starting Up the Software Operation Panel \(page 262\)](#).

### 2 From the list on the left, select [Device Setting 2] → [Maintenance and Inspection Cycle].

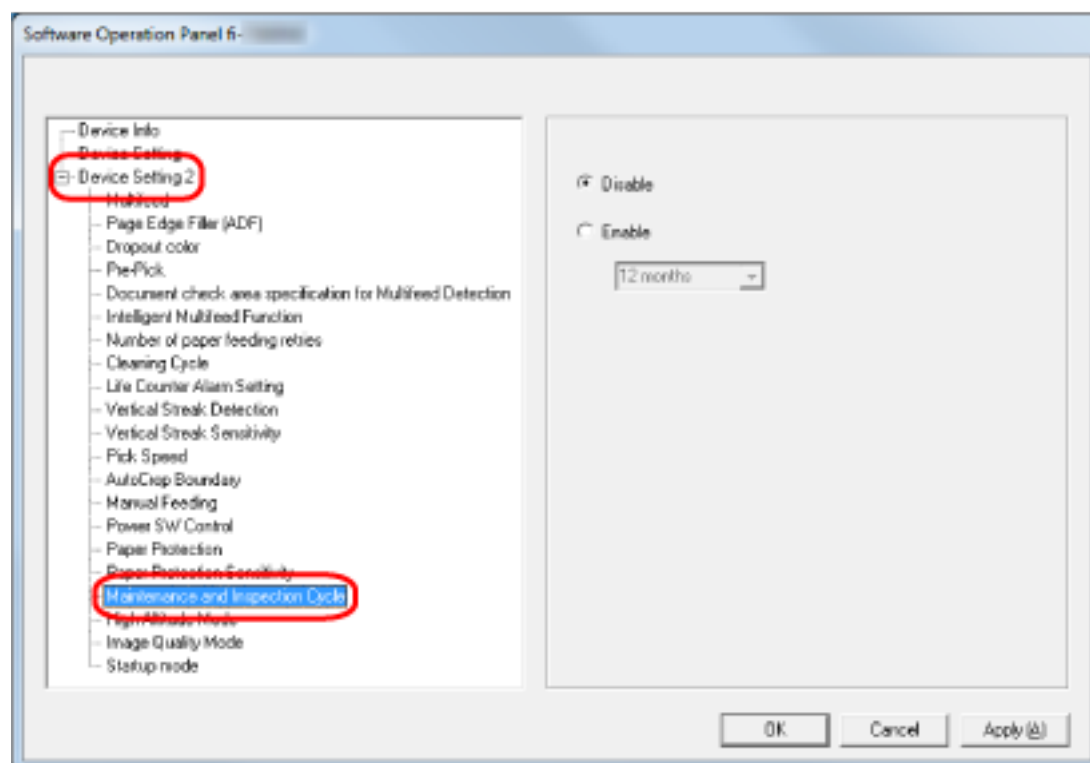

### 3 Select [Enable] to receive a message on the touch screen when it gets closer to the time for maintenance.

The factory default setting is [Disable].

### 4 Select the cycle to receive a message.

The factory default setting is "12 months".

# Appendix

## Basic Specification

Item		Specification
Scanner type		ADF (Automatic Document Feeder) Manual feeding (Single/Continuous) is available with the ADF.
Image sensor		Color CCD × 2 (front, back)
Light source		White LED × 2 (front, back)
Scanning area (width × length)	Minimum size	50.8 × 54 mm/2 × 2.1 in. 54 × 50.8 mm/2.1 × 2 in.
	Maximum size	A4 (portrait) (210 × 297 mm/8.3 × 11.7 in.) (*1) Legal (portrait) (8.5 × 14 in.) (*1)
Paper weight (thickness)		27 to 413 g/m <sup>2</sup> (7.2 to 110 lb) For A8 size or smaller, 128 to 209 g/m <sup>2</sup> (34 to 56 lb) 1.4 mm or less for plastic cards (*2)
Scanning speed (A4, Portrait, 300 dpi) (*3)	For USB connection	Simplex: 60 ppm, Duplex: 120 ipm
	For wired LAN connection	Simplex: 60 ppm, Duplex: 120 ipm
	For Wi-Fi connection	Simplex: 60 ppm, Duplex: 120 ipm
Loading capacity (*4)		80 sheets Paper weight: 80 g/m <sup>2</sup> (20 lb) Total thickness: 8 mm (0.3 in.) or less
Optical resolution		600 dpi
Output resolution	Binary (black & white)	50 to 600 dpi (configurable in 1 dpi increments) 1,200 dpi (created by scanner driver)
	Grayscale	
	Color	
Multi-valued level		Color: 24-bit Grayscale: 8-bit Binary (black & white): 1-bit
Interface	USB	USB 3.1 Gen 1/USB 3.0/USB 2.0/USB 1.1 (*5) Type B
	Wired LAN	IEEE802.3 Ethernet 10BASE-T/100BASE-TX/1000BASE-T

Item		Specification
		RJ-45
	Wi-Fi	For details, refer to <a href="#">Specifications of Wi-Fi (page 326)</a> .
Network protocol (wired LAN, Wi-Fi)		IPv4 (*6), TCP, UDP, ICMP, DHCP, DNS, HTTP/HTTPS, TLS 1.0/1.1/1.2
Touch screen		4.3-inch TFT color touch screen Pressure-sensitive
Contactless Smart Card Reader		Communication mode <ul style="list-style-type: none"> <li>• Compliant with the ISO/IEC 14443 Type A/Type B</li> <li>• Compliant with the ISO/IEC 18092</li> </ul>

**\*1:**Long page scanning supports documents with a length up to 5,588 mm (220 in.) when the resolution is set to 200 dpi or lower.

**\*2:**Up to three plastic cards can be loaded in the ADF paper chute (feeder).

**\*3:**Note that this is the hardware limitation, and the software's processing time such as data transfer time is added to the actual time of scanning.

The system environment used for measuring scan speed is as follows:

Operating system	Windows 11
CPU	Intel® Core™ i3-13100, up to 4.5 GHz
Memory	8 GB
Storage	SSD

**\*4:**The capacity varies depending on the paper weight.

For details, refer to [Documents for Scanning \(page 87\)](#).

**\*5:**Use the USB cable that is supplied.

When connecting the USB cable to a USB hub, make sure you connect it to a USB hub that is connected to the USB port of a computer.

Connection with USB 3.1 Gen 1/USB 3.0/USB 2.0 requires the USB port and the hub to support USB 3.1 Gen 1/USB 3.0/USB 2.0.

Also note that the scanning speed slows down when USB 1.1 is used.

**\*6:**IPv6 is not supported.

#### ● Specifications of Wi-Fi

Item	Specification
Observed standards	IEEE802.11a IEEE802.11b IEEE802.11g

Item	Specification
	IEEE802.11n IEEE802.11ac
Communication mode	Infrastructure mode (*1)
Frequency	2.4 GHz band 5 GHz band (*2)
Channel	2.4 GHz band: 1 to 13 ch 5 GHz band: 36 to 60 ch, 100 to 140 ch, 149 to 165 ch (increments of 4 ch)
Encryption	WEP (64bit/128bit) WPA (TKIP/AES) WPA2 (AES) WPA-PSK (TKIP/AES) WPA2-PSK (AES) WPA Enterprise (TKIP/AES) WPA2 Enterprise (AES)
Simple setup	Supports WPS2.0 (button/PIN code) (*3)

\*1: You need a wireless access point which supports the same standards as this scanner.

\*2: Depending on the country or region where the scanner is purchased, it may not work with a 5GHz SSID.

Change the wireless access point setting to use a 2.4 GHz SSID.

\*3: You need a wireless access point which supports the WPS function.

## Installation Specification

Item		Specification
Outer dimensions (W × D × H) (*1)		300 × 202 × 170 mm/11.81 × 7.95 × 6.69 in.
Installation space (W × D × H) (*2)		400 × 700 × 380 mm/15.75 × 27.56 × 14.96 in.
Weight		4.9 kg (10.80 lb) or less
Input power	Voltage range	AC 100 to 240 V ±10%
	Phase	Single phase
	Frequency range	50/60 Hz ±3 Hz
Power consumption	Operating	42 W or less
	Power saving	2.4 W or less
	Power off	0.3 W or less
Ambient conditions	Temperature	Operating: 5 to 35°C (41 to 95°F) Not operating: -20 to 60°C (-4 to 140°F)
	Humidity	Operating: 20 to 80% Not operating: 8 to 95%
Calorific value	Operating	36.12 kcal/h or less
	Power saving	2.07 kcal/h or less
Shipping weight (*3)		7.2 kg (15.88 lb) or less
Support period		5 years

\*1:The depth indicates the size of the scanner without the ADF paper chute (feeder) and the stacker.

\*2:The required installation space is a reference for scanning A4 size documents.

\*3:Includes the package weight.

## Outer Dimensions

The outer dimensions are as follows:

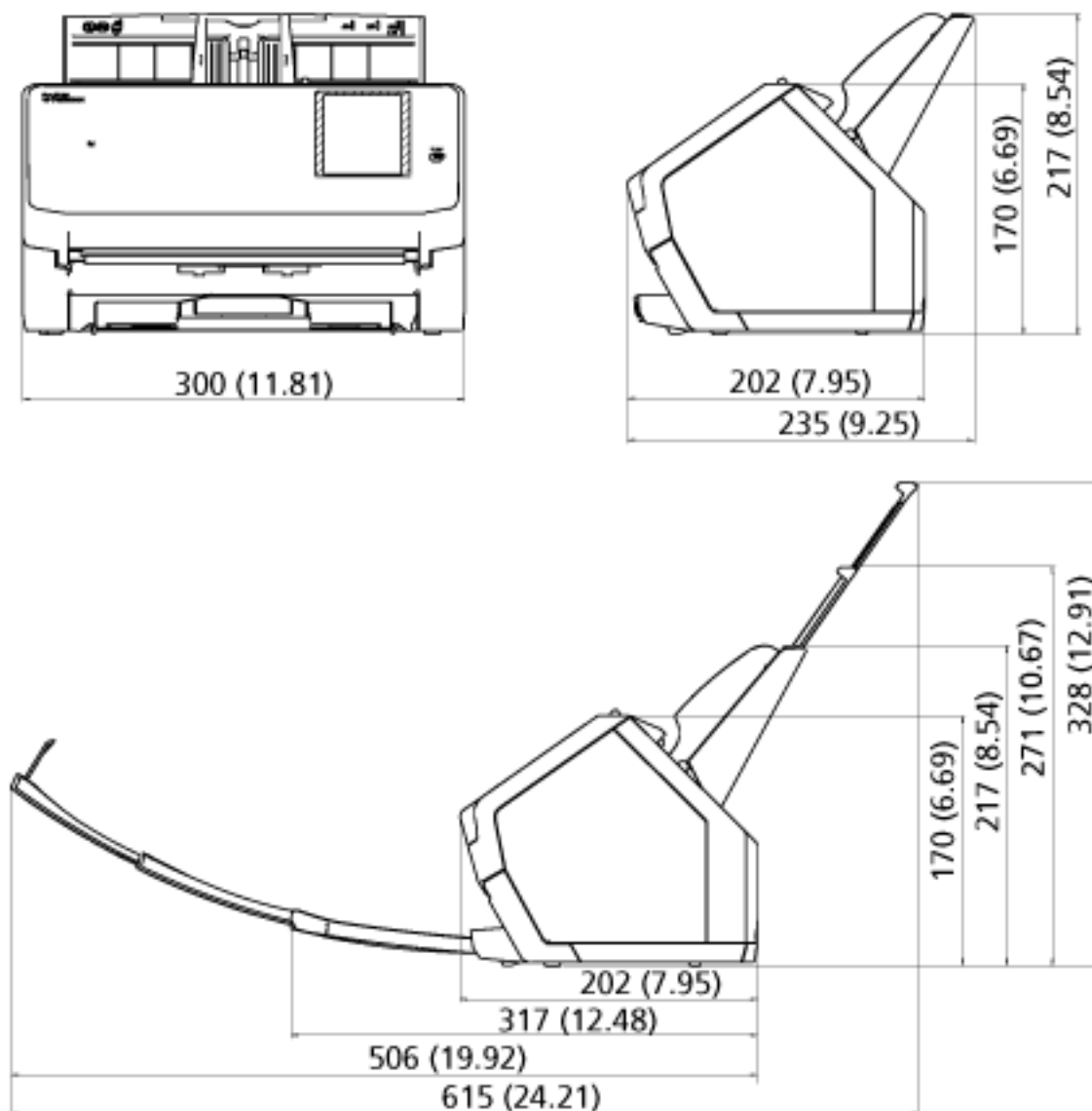

Unit: mm (in.)

## Scanner Options

Name	Part No.	Description
Carrier Sheets 	PA03360-0013	<p>Use this option to scan non-standard size documents such as photographs and clippings. Using the Carrier Sheets enable you to scan documents that can be damaged quite easily such as photographs, or documents that are difficult to load directly such as newspaper clippings.</p> <p>When a Carrier Sheet is too damaged or worn out to be used for scanning, extra carrier sheets can be purchased separately (5 sheets per set). The Carrier Sheet should be replaced approximately every 500 scans. However, replace it if damage or dirt is noticeable.</p>

For details about purchasing the scanner options and more information, contact the distributor/ dealer where you purchased this product. Refer to the contact information in the Contact List if supplied with this product, or refer to the contact information in the Contact for Inquiries section if provided in Safety Precautions supplied with this product, and then make an inquiry.

---

## Starting Up Scanner Selection Tool for fi Series

Scanner Selection Tool for fi Series can be started up in the following procedure:

- Windows 10/Windows Server 2016/Windows Server 2019/Windows Server 2022  
Click [Start] menu → [fi Series] → [Scanner Selection Tool for fi Series].
- Windows 11/Windows Server 2025  
Click [Start] menu → [All apps] → [fi Series] → [Scanner Selection Tool for fi Series].

---

## Uninstalling the Software

- 1 Turn on the computer and log onto Windows as a user with administrator privileges.**
- 2 Exit all running software.**
- 3 Display the [Control Panel] window.**
  - Windows 10/Windows Server 2016/Windows Server 2019/Windows Server 2022  
Click [Start] menu → [Windows System] → [Control Panel].
  - Windows 11/Windows Server 2025  
Click [Start] menu → [All apps] → [Windows Tools] and double-click [Control Panel].
- 4 Select [Uninstall a program].**

The [Programs and Features] window appears with a list of the currently installed software.
- 5 Select a software to uninstall.**
  - When uninstalling the PaperStream IP driver  
Select one of the following:
    - PaperStream IP (TWAIN)
    - PaperStream IP (TWAIN x64)
    - PaperStream IP (ISIS) Bundle
  - When uninstalling Network Setup Tool for fi Series  
Select [Network Setup Tool for fi Series].
  - When uninstalling Software Operation Panel  
Select [Software Operation Panel].  
The Software Operation Panel is installed together with the PaperStream IP driver.
  - When uninstalling Error Recovery Guide  
Select [Error Recovery Guide for fi-7300NX].
  - When uninstalling PaperStream ClickScan  
Select [PaperStream ClickScan].
  - When uninstalling PaperStream ClickScan Searchable PDF Option  
Select [PaperStream ClickScan Searchable PDF Option].
  - When uninstalling PaperStream Capture  
Select [PaperStream Capture].
  - When uninstalling manuals  
Select [fi Series manuals for fi-7300NX].
  - When uninstalling fi Series Online Update  
Select [fi Series Online Update].
- 6 Click the [Uninstall] button or the [Uninstall/Change] button.**
- 7 If a confirmation message appears, click the [OK] button or the [Yes] button.**

The software is uninstalled.

## Exporting the Scanner Settings (Using PaperStream NX Manager)

This section explains the scanner settings that can be exported and the exporting procedure.

When using PaperStream NX Manager, export the scanner settings and upload them to the Scanner Central Admin Server so that the scanner settings can be distributed to other scanners operated with PaperStream NX Manager.

For details about how to upload the exported scanner settings to the Scanner Central Admin Server or how to distribute the exported scanner settings, refer to the Scanner Central Admin User's Guide.

### Settings That Can Be Exported



The scanner settings that are set for  on the touch screen can be exported.

Note that the following settings cannot be exported:

- [Consumable counters] for [Cleaning & Maintenance]
- [Scanner name] for [Scanner Settings]
- The following settings in [Network] for [Scanner Settings]:
  - [IP Address] for [Wi-Fi]
  - [IP Address] for [Wired LAN]
- The following settings in [Image] for [Scanner Settings]:
  - [Offset]
  - [Magnification]

Export the scanner settings in the following procedure:

- 1 Turn on the computer and enter the following URL in the URL input field on the browser to establish a connection with a scanner.**

http or https(\*1)://xxx.xxx.xxx.xxx(\*2)/login.cgi

\*1:Enter "http" when [Encryption Off (HTTP)] is selected for [Network Encryption] in [Network] in [Scanner Settings]. Or, enter "https" when [Encryption On (HTTPS)] is selected.

\*2:Enter an IP address for the scanner.

You can enter a scanner name (host name) when [Dynamic DNS] is enabled for [Network] in [Scanner Settings]. For details, refer to [Network \(page 239\)](#).

#### TIP

If a blank space or "\_" is included in [Scanner name], change it to "-".

- 2 If the window to enter the administrator password appears, enter the administrator password to log in.**  
For details about the administrator password, refer to [Admin Password \(page 260\)](#).
- 3 Enter [Version/Name] when the window for exporting the scanner settings appears.**

Enter a version or name within 31 characters to identify the scanner settings.  
The characters you entered will be used for the name of the file to be exported.

**4 Click the [Download] button.**

The window appears asking you whether to open or save the file.

**5 Click the [Save] button.**

The scanner settings are exported as a file in the following file name.

ScannerSetting\_yyyyyyyy(\*3).cab

\*3: The characters you entered for [Version/Name] in step 3 are used.

**6 If the [Logout] button is displayed, click the [Logout] button.**

**ATTENTION**

To properly display the windows, ensure that the browser is configured as follows:

- Cookies are enabled
- JavaScript is enabled

**TIP**

Uploading the exported file to the Scanner Central Admin Server allows you to distribute the scanner settings to other scanners.

The scanner settings can be distributed to this scanner model (operated with PaperStream NX Manager) only.

For details, refer to the Scanner Central Admin User's Guide.

---

## Notes for Distributing Update Modules with the Scanner Central Admin Server

This section describes notes for distributing update modules such as the scanner settings and firmware to scanners that are operated with PaperStream NX Manager by using the Scanner Central Admin Server.

For details about how to distribute update modules by using the Scanner Central Admin Server, refer to the Scanner Central Admin User's Guide.

- Depending on the network environment, the communication between the Scanner Central Admin Server and the scanner may fail due to the network load.  
In this case, use Scanner Central Admin Console to reduce the number of scanners in the same update group, and the maximum number of scanners which can be connected together at the same time.  
For details, refer to the Scanner Central Admin User's Guide.
- Update modules such as the scanner settings and firmware will be distributed and applied to scanners in the following cases:

- When a scanner is turned on
- When an operation to log out from PaperStream NX Manager is performed

To prevent update modules from being distributed or applied during working hours, secure sufficient time between the time the scanner is turned on and the time operations begin.

In addition, Scanner Central Admin Console allows you to specify a time zone in which update modules are to be distributed.

For details, refer to the Scanner Central Admin User's Guide.

# Contact for Inquiries

- **Contact for Inquiries**

Refer to the contact list on the following web page:

<https://www.pfu.ricoh.com/global/scanners/contacts/>

- **Image Scanner fi Series**

For other inquiries regarding the scanner, refer to the following web page:

<https://www.pfu.ricoh.com/global/scanners/fi/support/>

If the solution to your problem cannot be found on the above web page, refer to the contact information for your distributor/dealer on the following web page:

<https://www.pfu.ricoh.com/global/scanners/inquiry.html>

- **Contact for Purchasing Consumables or Cleaning Materials**

<https://www.pfu.ricoh.com/global/scanners/contacts/>