

# fi-5530C2 Image Scanner

## Getting Started

Thank you for purchasing the fi-5530C2 Duplex Color Scanner.

This document describes how to use fi-5530C2 and basic operation methods. Before you start using fi-5530C2 be sure to thoroughly read this manual to ensure correct use.

The "fi-5530C2 Operator's Guide" stored on the Setup DVD-ROM provides useful and detailed information on Operations when you would like to use advanced features, Daily Care for maintenance of the scanner, and Replacing Consumables to maintain conditions for smooth scanning. Please also read the "fi-5530C2 Operator's Guide" for further information.

Microsoft, Windows, Windows Server, Windows Vista, Excel, and SharePoint are either registered trademarks or trademarks of Microsoft Corporation in the United States and/or other countries.

Word is a product of Microsoft Corporation in the United States.

ISIS is a registered trademark or trademark of EMC Corporation in the United States.

ABBYY™ FineReader™ Engine © ABBYY. OCR by ABBYY

ABBYY and FineReader are trademarks of ABBYY Software, Ltd. which may be registered in some jurisdictions.

ScanSnap, ScanSnap Manager, and PaperStream are registered trademarks of PFU LIMITED in Japan.

Other company names and product names are the registered trademarks or trademarks of the respective companies.

December, 2014

© PFU LIMITED 2007-2014

### How Trademarks Are Indicated In This Manual

References to operating systems (OS) are indicated as follows:

Windows XP      Windows® XP Home Edition operating system,  
Windows® XP Professional operating system (32-bit/64-bit)

Windows Server 2003      Windows Server® 2003, Standard Edition operating system (32-bit/64-bit),  
Windows Server® 2003 R2, Standard Edition (32-bit/64-bit)

Windows Vista      Windows Vista® Home Basic operating system (32-bit/64-bit),  
Windows Vista® Home Premium operating system (32-bit/64-bit),  
Windows Vista® Business operating system (32-bit/64-bit),  
Windows Vista® Enterprise operating system (32-bit/64-bit),  
Windows Vista® Ultimate operating system (32-bit/64-bit)

Windows Server 2008

Windows Server® 2008 Standard (32-bit/64-bit),  
Windows Server® 2008 R2 Standard

Windows 7

Windows® 7 Home Premium operating system (32-bit/64-bit),  
Windows® 7 Professional operating system (32-bit/64-bit),  
Windows® 7 Enterprise operating system (32-bit/64-bit),  
Windows® 7 Ultimate operating system (32-bit/64-bit)

Windows Server 2012

Windows Server® 2012 Standard (64-bit)

Windows Server 2012 R2

Windows Server® 2012 R2 Standard (64-bit)

Windows 8

Windows® 8 operating system (32-bit/64-bit),  
Windows® 8 Pro operating system (32-bit/64-bit),  
Windows® 8 Enterprise operating system (32-bit/64-bit)

Windows 8.1      Windows® 8.1 operating system (32-bit/64-bit),  
Windows® 8.1 Pro operating system (32-bit/64-bit),  
Windows® 8.1 Enterprise operating system (32-bit/64-bit)

Where there is no distinction between the different versions of the above operating system, the general term "Windows " is used.

## Safety Information

The attached "Safety Precautions" manual describes important details for users to use this product safely and correctly. Read the Safety Precautions thoroughly before you start using this product.

## Symbols Used In This Manual



This symbol alerts operators to particularly important information. Be sure to read this information.



This symbol alerts operators to helpful advice regarding operation.



## Screen Examples In This Manual





The screen examples in this manual are subject to change without notice in the interest of product improvement. If the actual displayed screen differs from the screen examples in this manual, operate by following the actual displayed screen while referring to the User's Manual of the scanner application you are using. The screen examples used in this manual are of the TWAIN driver, ISIS driver, and ScandAll PRO (image scanning application).

# Chapter1 PREPARING THE SCANNER

## 1.1 Checking the Contents of the Scanner Package

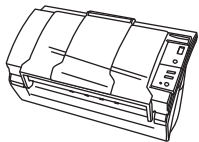
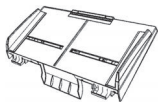
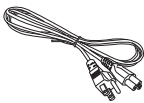
Make sure that all items shown below are included in the package.

If any parts are missing or defective, contact your scanner dealer or an authorized FUJITSU scanner service provider. Handle the scanner and accessories with care.

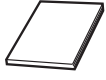
	Scanner (x1)
	ADF paper chute (x1)
	AC cable (The contents may vary depending on the country and the model purchased.)
	AC adapter (x1)
	USB cable (x1)
	Setup DVD-ROM (x1)
	2D Barcode for PaperStream Setup CD-ROM (x1)
	Safety Precautions (x1)



## 2.2 Connecting the Scanner to Your Personal Computer

Connect either with the USB interface cable or the SCSI interface cable.



This scanner is provided with two interfaces: Ultra SCSI and USB 2.0 /1.1. Connect only one of the USB or SCSI interface cable.



### ■ Connecting with the USB Interface Cable

1. Connect the USB interface cable to the USB interface connector.

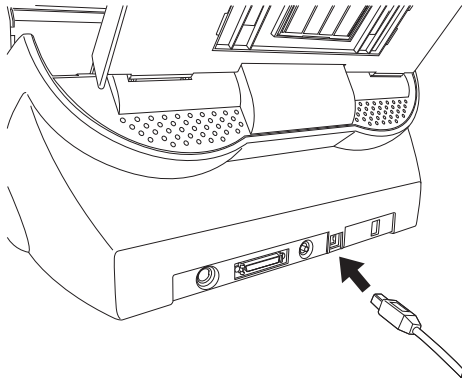

2. Connect the other end of the USB interface cable to your personal computer.



- Be sure to use the USB cable which comes with this scanner. Correct operation with commercially available cables is not guaranteed.
- When connecting to an USB hub, use the first stage USB hub that is closest to the computer. If you use the second or later hub stages, the scanner may not operate correctly.
- If you connect the scanner with USB 2.0, it is required that the USB port and Hub are compliant with USB 2.0. The scanning speed will slow down if it is connected with USB1.1.



### ■ Connecting with the SCSI Interface Cable

When using the scanner with a SCSI interface, the following SCSI interface cable and SCSI card must be purchased.

- SCSI interface cable:  
Use a cable which complies with a 50 Pin Contact Shielded High-Density SCSI Device Connector for Ultra SCSI.
- SCSI card  
Find the recommended SCSI card information in the Fujitsu web site (FAQ).

<http://imagescanner.fujitsu.com/>



- When connecting the SCSI interface cable, turn the scanner off. Be sure to connect the SCSI interface cable first, and then turn on the power of the scanner and personal computer.
- In a SCSI daisy chain formation, connect the scanner so that it is the terminated device.



1. Insert the SCSI interface cable into the interface connector of the scanner until both sides click.

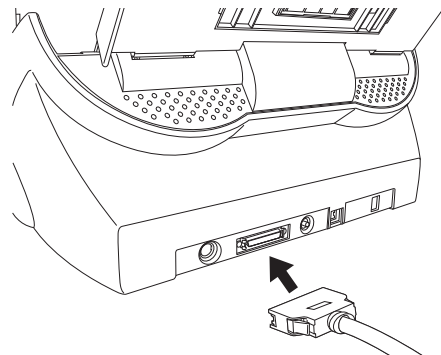

2. Connect the other end of the cable to your personal computer.



Be careful not to bend the pins of the SCSI cable when connecting to the scanner.



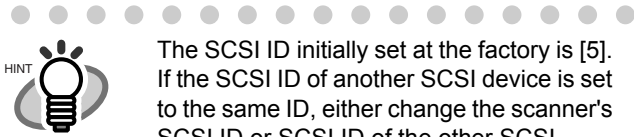

The SCSI ID initially set at the factory is [5]. If the SCSI ID of another SCSI device is set to the same ID, either change the scanner's SCSI ID or SCSI ID of the other SCSI device. For details on how to change the SCSI ID, refer to "Setting the SCSI ID" in this section.

## 2.3 Installing the Software

### ■ Bundled Software

The following software are bundled with the scanner:

- **PaperStream IP (TWAIN) Driver**  
Conforms to the TWAIN standard. Used when you operate the scanner using TWAIN-compliant applications.
- **PaperStream IP (ISIS) Driver**  
Conforms to the ISIS standard. Used when you operate the scanner using ISIS-compliant applications.
- **2D Barcode for PaperStream**  
This option can recognize two dimensional codes. Can be used with the PaperStream IP (TWAIN) driver, the PaperStream IP (ISIS) driver, or PaperStream Capture. For details about the installation, refer to readme in the 2D Barcode for PaperStream Setup CD-ROM.
- **Software Operation Panel**  
Configure various settings such as the operation of the scanner and managing the consumables. Installed together with the PaperStream IP (TWAIN) driver and PaperStream IP (ISIS) driver.
- **Error Recovery Guide**  
Shows the error status and countermeasures when an error occurs. Installed together with the PaperStream IP (TWAIN) driver and PaperStream IP (ISIS) driver.
- **PaperStream Capture**  
An image scanning application that supports the PaperStream IP (TWAIN) driver and PaperStream IP (ISIS) driver. By defining scan settings as document profiles, you can customize the settings according to your preference.
- **ScanSnap Manager for fi Series**  
An application that scans images with the driver settings that are used exclusively for ScanSnap Manager for fi Series. PaperStream IP (TWAIN) driver is required to use this application. Enables easy scanning with a single button. You can download and install this application from the download web page.

### ■ Setting the SCSI ID

The factory initial setting for SCSI ID is [5].

1. Press the power button at least for two seconds to turn off the scanner. Disconnect the AC cable from the outlet.
2. Set the SCSI ID using the SCSI ID switch on the back of the scanner.

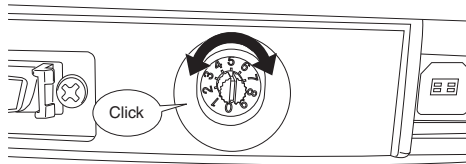

ID No.	Description
0 to 7	Can be set as the ID
8, 9	Works with the factory default value (SCSI ID = 5).

3. Press the power button to turn on the scanner.  
When the scanner is turned ON, the SCSI ID set at step 2 is enabled.

- **Scan to Microsoft SharePoint**  
An application that allows you to upload your files easily from ScanSnap Manager for fi Series to a SharePoint site. Can be used to scan from ScanSnap Manager for fi Series.  
You can download and install this application from the download web page.
- **ABBYY FineReader for ScanSnap™**  
Bundled for use with ScanSnap Manager for fi Series, this application converts scanned images into Microsoft® Office (Word/Excel®/PowerPoint®) files. Can be used to scan from ScanSnap Manager for fi Series.  
You can download and install this application from the download web page.
- **Manual**  
Includes Safety Precautions, Getting Started and Operator's Guide.
- **Scanner Central Admin Agent**  
Used to centralize the management of multiple scanners, by allowing you to apply firmware updates simultaneously, monitor the operating status, and check the scanner information. Note that required applications will differ depending on the form of operation. For details, refer to the Scanner Central Admin User's Guide.
- **fi Series Online Update**  
An application that checks for the software updates for fi Series, and runs the updates.
- **Other Software (Legacy)**  
Software that were bundled with older versions of scanners are also included.
  - **TWAIN Driver**  
Conforms to the TWAIN standard. Used when you operate the scanner using TWAIN-compliant applications.
  - **ISIS Driver**  
Conforms to the ISIS standard. Used when you operate the scanner using ISIS-compliant applications.
  - **Image Processing Software Option (trial)**  
A software option featuring advanced binarization of scanned images.
  - **ScandAll PRO**  
A TWAIN/ISIS-compliant image scanning application. You can define scanning settings as batch profiles to suit your various operation requirements. By defining scanning settings as batch profiles, you can easily perform scans in accordance with various operation requirements.  
You can download and install this application from the download web page.

## ■ Installing the Bundled Software

Install the bundled software from the Setup DVD-ROM in the following procedure.

Note that there are two ways to install the bundled software: select [Installation (Recommended)] to install all the software required to operate the scanner, or [Installation (Custom)] to select and install the software as needed.

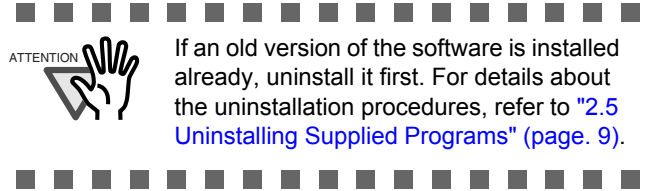

### Installation (Recommended)

The following software are installed:

- PaperStream IP (TWAIN) Driver
- Software Operation Panel
- Error Recovery Guide
- PaperStream Capture
- Manual
- Scanner Central Admin Agent
- fi Series Online Update

1. Turn on the computer and log onto Windows as a user with Administrator privileges.
2. Insert the Setup DVD-ROM into the DVD drive.  
⇒ The [fi Series Setup] screen appears.

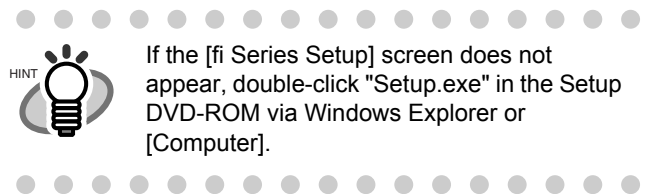

3. Click the scanner model.
4. Click the [Installation (Recommended)] button.



5. Follow the instructions on the screen to proceed with the installation.

## Installation (Custom)

1. Perform steps 1. to 3. in "Installation (Recommended)" (page. 7).
2. Click the [Installation (Custom)] button.



3. Select the check box for the software to install and click the [Next] button.
4. Follow the instructions on the screen to proceed with the installation.

## 2.4 Checking Scanner Driver Operation

This section explains how to check the operation of the installed scanner driver by using PaperStream Capture. Make sure that the scanner driver is installed properly, following the procedure below.

### ■ Checking the Operation of the Scanner Driver

1. Load the document on the scanner.  
For information about how to load the document, refer to section 1.2 in fi-5530C2 Operator's Guide.
2. Start up PaperStream Capture.
  - Windows XP/Windows Vista/Windows Server 2008/Windows 7  
Select the [Start] menu → [All Programs] → [PaperStream Capture] → [PaperStream Capture].
  - Windows Server 2012/Windows 8  
Right-click the Start screen, select [All apps] on the app bar, and then select [PaperStream Capture] under [PaperStream Capture].
  - Windows Server 2012 R2/Windows 8.1  
Click [↓] on the lower left side of the Start screen, and then select [PaperStream Capture] under [PaperStream Capture].  
To display [↓], move the mouse cursor.
3. Click the [Scan] button in the Menu Area.
4. Click one of the three types of document profiles that are prepared beforehand.  
Below is an example of when the document profile [Black and White] is clicked.

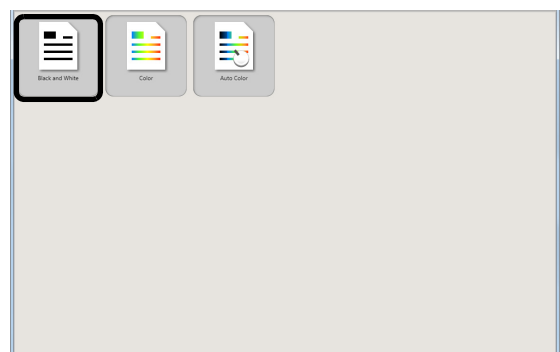

⇒ The document is scanned, and the scanned image is displayed.



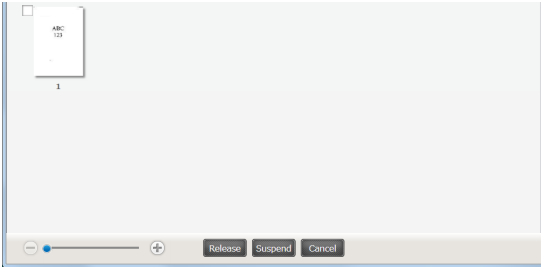

For further information about how to scan documents, refer to "fi-5530C2 Operator's Guide" contained in the Setup DVD-ROM.

## 2.5 Uninstalling Supplied Programs

The following explains how to uninstall software applications provided with the scanner.



The displayed windows and operations may slightly vary depending on the operating system you are using.



### 1. Start your personal computer.



Be sure to log on as a user with "Administrator" privileges.



### 2. Exit all applications.

### 3. From the [Start] menu, select [Control Panel] -> [Add or remove Programs].

⇒ In the [Add or remove Programs] dialog box, you can view a list of installed applications.

### 4. Select an application you want to uninstall as follows:

- PaperStream IP (TWAIN) driver: **[PaperStream IP (TWAIN)]**
- PaperStream IP (ISIS) driver: **[PaperStream IP (ISIS) Bundle]**
- 2D Barcode for PaperStream: **[2D Barcode for PaperStream]**
- PaperStream Capture: **[PaperStream Capture]**
- ScanSnap Manager for fi Series: **[ScanSnap Manager for fi Series]**
- Manual: **[fi Series manuals for fi-5530C2]**
- To remove TWAIN, select **"Scanner Utility for Microsoft Windows."**
- To remove ScandAll PRO, select **"Fujitsu ScandAll PRO"**
- Microsoft SharePoint: **"Scan to Microsoft SharePoint"**
- ABBYY FineReader for ScanSnap™: **"ABBYY FineReader for ScanSnap(TM)"**
- To remove ISIS, select **"ISIS Driver Bundle Installer for fi Series Scanners"**
- To remove Error Recovery Guide, select **"Error Recovery Guide."**

- To remove Software Operation Panel, select "**Software Operation Panel.**"
- To remove Scanner Central Admin Agent, select "**Scanner Central Admin Agent**"
- To remove fi Series Online Update, select "**fi Series Online Update**".

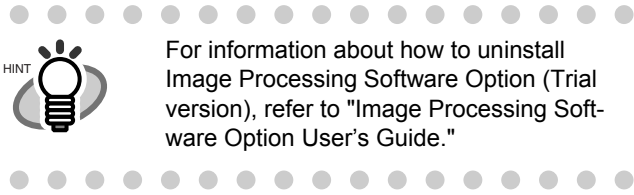

For information about how to uninstall Image Processing Software Option (Trial version), refer to "Image Processing Software Option User's Guide."



5. Click the [Change/Remove] button or the [Remove] button.
6. When you see a confirmation dialog box, click the [OK] button or the [Yes] button.

⇒ Upon clicking the button, uninstallation is started.



Displays may vary depending on the operating system you are using. Follow the on-screen instructions.

Examples

In Windows Vista, the window and button names described above are as follows:

- [Uninstall or Change a program] ->[Uninstall or Change]

