

fi-6140/fi-6240/fi-6130/fi-6230 Image Scanner

Contents

■ FCC Declaration	i
■ Liability Note	ii
■ Safety Precautions	iii
Chapter1 PREPARING THE SCANNER	1
1.1 Checking the Contents of the Scanner Package	1
1.2 Names of Parts.....	1
1.3 Operator Panel	2
Chapter2 INSTALLATION OF THE SCANNER	3
2.1 Installing the Scanner	3
2.2 Connecting the Scanner to Your PC.....	4
2.3 Installing the Scanner Software	5
2.4 Checking Scanner Driver Operation	10
2.5 Uninstalling Supplied Programs	11
Appendix1 TROUBLESHOOTING.....	AP-1
Appendix2 DAILY CARE	AP-2
Appendix3 REPLACING CONSUMABLES... ..	AP-3
Appendix4 Purchasing the Carrier Sheet....	AP-4

Getting Started

Instructions
préliminaires

Los Geht's

Avvio Rapido

Comenzando

Начало работы

스타트업 가이드

入門指南

Instruções
básicas

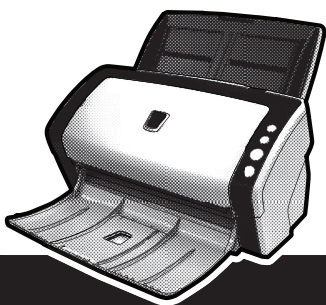

INTRODUCTION

Thank you for purchasing the fi-6140/fi-6240/fi-6130/fi-6230 Duplex Color Scanner.

This document describes how to use fi-6140/fi-6240/fi-6130/fi-6230 and basic operation methods. Before you start using fi-6140/fi-6240/fi-6130/fi-6230 be sure to thoroughly read this manual to ensure correct use.

The "fi-6140/fi-6240/fi-6130/fi-6230 Operator's Guide" stored on the Setup CD-ROM provides useful and detailed information on Operations when you would like to use advanced features, Daily Care for maintenance of the scanner, and Replacing Consumables to maintain conditions for smooth scanning. Please also read the "fi-6140/fi-6240/fi-6130/fi-6230 Operator's Guide" for further information. Regulatory Information

■ FCC Declaration

This equipment has been tested and found to comply with the limits for a Class B digital device, pursuant to Part 15 of the FCC Rules. These limits are designed to provide reasonable protection against harmful interference in a residential installation. This equipment generates, uses, and can radiate radio frequency energy and, if not installed and used in accordance with the instruction manual, may cause harmful interference to radio communications. However, there is no guarantee that interference will not occur in a particular installation. If this equipment does cause harmful interference to radio or television reception, which can be determined by turning the equipment off and on, the user is encouraged to try to correct the interference by one or more of the following measures:

- Reorient or relocate the receiving antenna.
- Increase the separation between the equipment and receiver.
- Connect the equipment into an outlet on a circuit different from that to which the receiver is located.
- Consult your dealer or an experienced radio/TV technician.

FCC warning: Changes or modifications not expressly approved by the party responsible for compliance could void the user's authority to operate the equipment.



The use of a shielded interface cable is required to comply with the Class B limits of Part 15 of FCC rules. The length of the AC cable must be 3 meters (10 feet) or less.

Canadian DOC Regulations

This digital apparatus does not exceed the Class B limit for radio noise emissions from digital apparatus set out in the Radio Interference Regulations of the Canadian Department of Communications.

This Class B digital apparatus complies with Canadian ICES-003.

Le présent appareil numérique n'émet pas de parasites radioélectriques dépassant les limites applicables aux appareils numériques de la classe B et prescrites dans le Règlement sur le brouillage radioélectrique dictées par le Ministère des Communications du Canada.

Cet appareil numérique de la classe B est conforme à la norme NMB-003 du Canada.

Bescheinigung des Herstellers / Importeurs

Für den fi-6140/fi-6240/fi-6130/fi-6230 wird folgendes bescheinigt:

- In Übereinstimmung mit den Bestimmungen der EN45014(CE) funkenstört
- Maschinenlärminformationsverordnung 3. GPSGV:
Der höchste Schalldruckpegel beträgt 70 dB (A) oder weniger, gemäß EN ISO 7779.

Dieses Gerät wurde nicht für die Benutzung in unmittelbarer Umgebung starker Lichtquellen (z. B. Projektoren) konzipiert.

International ENERGY STAR® Program

As an ENERGY STAR® Partner, PFU LIMITED has determined that this product meets the ENERGY STAR® guidelines for energy efficiency.

The International ENERGY STAR® Office Equipment

Program is an international program that promotes energy saving through the penetration of energy efficient computers and other office equipment. The program backs the development and dissemination of products with functions that effectively reduce energy consumption. It is an open system in which business proprietors can participate voluntarily. The targeted products are office equipment such as computers, monitors, printers, facsimiles, copiers, scanners, and multifunction devices. Their standards and logos are uniform among participating nations.



■ Liability Note

READ ALL OF THIS MANUAL CAREFULLY BEFORE USING THIS PRODUCT. IF THIS PRODUCT IS NOT USED CORRECTLY, UNEXPECTED INJURY MAY BE CAUSED TO USERS OR BYSTANDERS.

Also, keep this manual in a safe place so that it can be easily referred to during use of this product.

While all efforts have been made to ensure the accuracy of all information in this manual, PFU assumes no liability to any party for any damage caused by errors or omissions or by statements of any kind in this manual, its updates or supplements, whether such errors are omissions or statements resulting from negligence, accidents, or any other cause. PFU further assumes no liability arising from the application or use of any product or system described herein; nor any liability for incidental or consequential damages arising from the use of this manual. PFU disclaims all warranties regarding the information contained herein, whether expressed, implied, or statutory.

Use in High-safety Applications

This product has been designed and manufactured on the assumption that it will be used in office, personal, domestic, regular industrial, and general-purpose applications. It has not been designed and manufactured for use in applications (simply called "high-safety applications" from here on) that directly involve danger to life and health when a high degree of safety is required, for example, in the control of nuclear reactions at nuclear power facilities, automatic flight control of aircraft, air traffic control, operation control in mass-transport systems, medical equipment for sustaining life, and missile firing control in weapons systems, and when provisionally the safety in question is not ensured. The user should use this product with adopting measures for ensuring safety in such high-safety applications. PFU LIMITED assumes no liability whatsoever for damages arising from use of this product by the user in high-safety applications, and for any claims or compensation for damages by the user or a third party.

About the Use of Mercury



Lamp(s) inside this product contain mercury and must be recycled or disposed of according to local, state, or federal laws.

To avoid unexpected injuries:

- Do not put the substance contained in the lamp in your mouth as it has mercury.
- Do not breathe the chemical liquid contained in the scanner lamps.
- Do not incinerate, crush, or shred the lamps or scanner parts.

Trademarks

Microsoft, Windows, Windows Server and Windows Vista are registered trademarks of Microsoft Corporation in the United States and/or other countries. ISIS and QuickScan are trademarks or registered trademarks of EMC Corporation in the United States. Adobe, the Adobe logo, and Acrobat are either registered trademarks of Adobe Systems Incorporated in the United States and/or other countries. Other product names are the trademarks or registered trademarks of the respective companies.

How Trademarks Are Indicated In This Manual

References to operating systems (OS) and applications are indicated as follows:

Windows 2000	Microsoft® Windows® 2000 Professional operating system.
Windows XP	Microsoft® Windows® XP Professional operating system (32/64-bit), Microsoft® Windows® XP Home Edition operating system.
Windows Server 2003	Microsoft® Windows Server® 2003 Standard Edition operating system (32/64-bit).
Windows Server 2008	Microsoft® Windows Server® 2008 Standard Edition operating system (32/64-bit).
Windows Vista	Microsoft® Windows Vista® Home Basic operating system (32/64-bit), Microsoft® Windows Vista® Home Premium operating system (32/64-bit), Microsoft® Windows Vista® Business operating system (32/64-bit), Microsoft® Windows Vista® Enterprise operating system (32/64-bit), Microsoft® Windows Vista® Ultimate operating system (32/64-bit).

Where there is no distinction between the different versions of the above operating system, the general term "Windows" is used.

Adobe Acrobat Adobe® Acrobat®

All the descriptions in this manual assume the usage of Adobe Acrobat bundled with this product. However, Adobe Acrobat may be upgraded without notice. If the descriptions differ from the screens actually displayed, refer to the Acrobat's "Help."

Manufacturer

PFU LIMITED
 International Sales Dept., Imaging Business Division,
 Products Group
 Solid Square East Tower, 580 Horikawa-cho, Saiwai-
 ku, Kawasaki-shi Kanagawa 212-8563, Japan
 Phone : (81-44) 540-4538

© PFU LIMITED 2009-2011

About Maintenance

The user must not perform repairs on this scanner.
 Contact the store where you purchased the scanner or
 an authorized FUJITSU Image Scanner service
 provider to make repairs to this product.

Warning Indications Used In This Manual



This indication alerts operators to an operation that, if not strictly observed, may result in severe injury or death.



This indication alerts operators to an operation that, if not strictly observed, may result in safety hazards to personnel or damage to equipment.

Symbols Used In This Manual



This symbol alerts operators to particularly important information. Be sure to read this information.



This symbol alerts operators to helpful advice regarding operation.



A TRIANGLE symbol indicates that special care and attention is required. The drawing inside the triangle shows the specific caution.



A CIRCLE with a diagonal line inside shows action which users may not perform. The drawing inside or under the circle shows the specific action that is not allowed.



Outline characters on a colored background show instructions users should follow. It may also include the drawing that shows the specific instruction.

Warning Label



The glass surface inside the ADF becomes hot during the operation. Be careful not to touch the glass surface inside the ADF.



Do NOT remove from the scanner, stain or scratch the warning labels.











Screen Examples In This Manual













The screen examples in this manual are subject to change without notice in the interest of product improvement. If the actual displayed screen differs from the screen examples in this manual, operate by following the actual displayed screen while referring to the User's Manual of the scanner application you are using.



The screenshots in this manual were captured from FUJITSU TWAIN32 scanner driver, ScandAll PRO Image Capturing Utility Software, FUJITSU ISIS scanner driver, QuickScan Pro™ image capturing software and Adobe Acrobat.

■ Safety Precautions

WARNING	
	Do not damage the AC cable. A damaged AC cable may cause fire or electric shock. Do not place heavy objects on AC cables, or pull, bend, twist, heat, damage or modify AC cables. Do not use damaged AC cables or power plugs, or install any cables or power plugs to loose wall sockets.
	Use only specified AC cables and connector cables. Use only specified AC cables and connector cables. Failure to use the correct cables might cause electric shock and/or equipment failure. Please don't use the AC cable provided with this scanner for other devices, since this might cause equipment failure and other troubles or an electric shock.
	Make sure to ground the scanner. Make sure to ground to avoid electric shock. Be sure to ground before plugging into a power outlet. Unplug from the outlet before removing the ground connection.
	Use this scanner only at the indicated power voltage. Do not connect to multiple-power strips. Use this scanner only at the indicated power voltage and current. Improper power voltage and current might cause fire or electric shock. Do not connect to multiple-power strips.
	Do not touch the AC cable with wet hands. Do not touch the power plug with wet hands. Doing so might cause electric shock.
	Wipe any dust from the power plug. Wipe off any dust from metal parts on the power plug or metal fittings with a soft, dry cloth. Accumulated dust might cause fire or electric shock.
	Do not install the device in locations that has oil smoke, steam, humidity, and dust. Do not install the scanner in locations subject to oil smoke, steam, humidity, and dust. Doing so might cause a fire or electric shock.
	Turn the scanner OFF if it is damaged. If the scanner is damaged for any reason, turn the scanner off and unplug the power cable. Contact the store where you purchased the scanner.

  	<p>Do not put liquids inside the scanner.</p> <p>Do not insert or drop metal objects in to the scanner. Do not scan wet documents or documents with paper clips or staples. Do not splash or allow the scanner to get wet. If foreign objects (water, small metal objects, liquids, etc.) get inside the scanner, immediately turn off the scanner and disconnect the power plug from the power outlet. Then, contact the store where you bought the scanner or the Maintenance Service Center. Pay particular attention to this warning in households where there are small children.</p>
	<p>Unplug the scanner when a trouble occurs.</p> <p>Immediately unplug the scanner when a trouble occurs. Never cut the ground connection until the scanner is unplugged from the power outlet.</p>
	<p>Do not touch the inside of the scanner unless necessary.</p> <p>Do not take apart or modify the scanner. The inside of the scanner contains high-voltage components. Touching these components might cause electric shock or fire.</p>
	<p>Do not use the scanner if you smell a strange odor.</p> <p>If you detect heat coming from the device or detect other problems such as smoke, strange smells or noises, immediately turn off the scanner and then disconnect its power plug. Make sure that any smoke coming from it has stopped, before contacting the store where you bought the scanner or an authorized FUJITSU scanner service provider.</p>
	<p>Do not use aerosol sprays near the scanner.</p> <p>Do not use any aerosol sprays or alcohol based sprays to clean the scanner. Dust blown up by strong air from the spray may enter the inside of the scanner. This may cause the scanner to fail or malfunction. Sparks, caused by static electricity, generated when blowing off dust and dirt from the outside of the scanner may cause a fire.</p>
	<p>Do not place the scanner within the reach of small children.</p> <p>To avoid injuries, do not place the scanner in an area where small children may be able to reach.</p>
	<p>Do not touch the heated section for a long time.</p> <p>Do not touch the heated section such as the bottom of the scanner for a long time. Doing so may cause a low-temperature burn on your skin.</p>
	<p>Do not cover the scanner with something during its operation.</p> <p>Do not use the scanner while covered with a blanket, etc. Doing so may raise the temperature inside and cause a fire.</p>
	<p>Do not use the scanner where it gets wet.</p> <p>Do not use the scanner at a place such as a bathroom, shower room, or swimming pool where it may easily get wet. Doing so might cause electric shock or fire.</p>

<div style="border: 1px solid black; padding: 5px; display: inline-block;"> CAUTION</div>	
 	<p>Do not install the scanner on unstable surfaces.</p> <p>Make sure that the scanner is installed on a flat, level surface and that none of its parts extend beyond the surface top, such as a desk or table. Do not install the scanner on unstable surfaces. Install the scanner on a level surface that is free of vibration to prevent it from falling. Install the scanner on a strong surface that will support the weight of the scanner and other devices.</p>
	<p>Do not block the ventilation ports.</p> <p>Do not block the ventilation ports. Blocking the ventilation ports generates heat inside of scanner, which may result in fire or scanner failure.</p>
	<p>Do not place heavy objects or climb on top of the scanner.</p> <p>Do not place heavy objects on the scanner or use the scanner's surface top to perform other work. Improper installation might cause injuries and equipment failure.</p>
	<p>Firmly insert the power plug.</p> <p>Firmly insert the power plug as far it can go into the power outlet.</p>
	<p>Avoid any contact when scanner is in use.</p> <p>Avoid touching any scanner mechanism during scanning since this may cause injuries.</p>
	<p>Do not use the scanner immediately after moving it from a cold place into a warm room.</p> <p>Do not use the device immediately after moving it from a cold place into a warm room. Condensation may occur, which might lead to scanning errors. Let the device dry about one or two hours before you use it.</p>
	<p>Before moving the scanner, disconnect the power plug from the power outlet.</p> <p>Do not move the scanner with the power and interface cables connected as this can damage the cables, which can later cause fire, electric shock as well as injury. Before moving the scanner, be sure to disconnect the power plug from the power outlet, and all other data cables. Make sure that the floor is free of any obstructions.</p>
	<p>Protect the scanner from static electricity.</p> <p>Install the scanner away from strong magnetic fields and other sources of electronic noise. Also, protect the scanner against any static electricity, which can cause the scanner to malfunction.</p>
	<p>Disconnect the power plug from the power outlet when the scanner is not used for a long period of time.</p> <p>When the scanner is not going to be used for a long period of time, be sure to disconnect the power plug from the power outlet for safety.</p>
	<p>Do not install the scanner in the direct sunlight.</p> <p>Do not install the scanner under direct sunlight or near heating apparatus. Doing so might cause excessive heat to build up inside the scanner, which can cause scanner trouble or even fire. Install the scanner in a well-ventilated location.</p>

	<p>Before moving the scanner, make sure the transport lock is locked.</p> <p>When moving the scanner, be sure to lock the transport lock in order to prevent damage to the scanner.</p>
	<p>Handle documents carefully.</p> <p>When handling documents, be careful not to cut your fingers with them.</p>
	<p>Do not make the scanner wet while carrying it outside.</p> <p>When carrying the scanner outside while it is raining or snowing, pay special attention so the scanner does not get wet.</p>

Chapter 1 PREPARING THE SCANNER

1.1 Checking the Contents of the Scanner Package

When you open the scanner package, make sure it contains all the parts listed in the package contents list that is included in the package box.

If any parts are missing or defective, contact the dealer you purchased the scanner or an authorized Fujitsu scanner service provider. Handle the scanner and accessories with care.

1.2 Names of Parts

This section describes the names of parts.

■ Front side

[fi-6140/fi-6130]

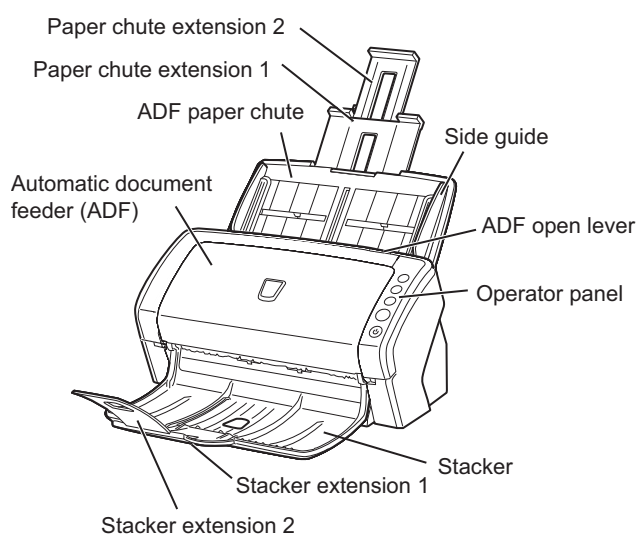

[fi-6240/fi-6230]

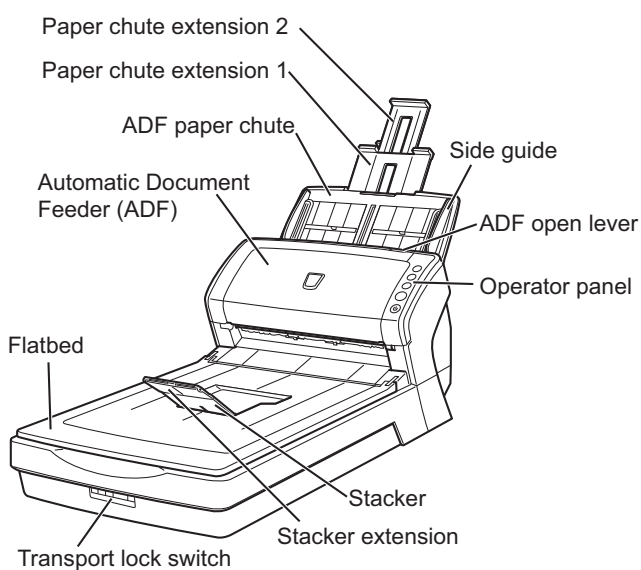

■ Inside

[fi-6240/fi-6230]

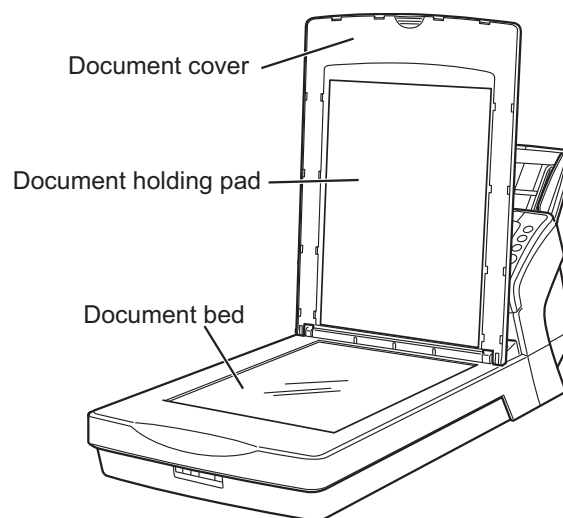

■ Rear side

[fi-6140/fi-6130]

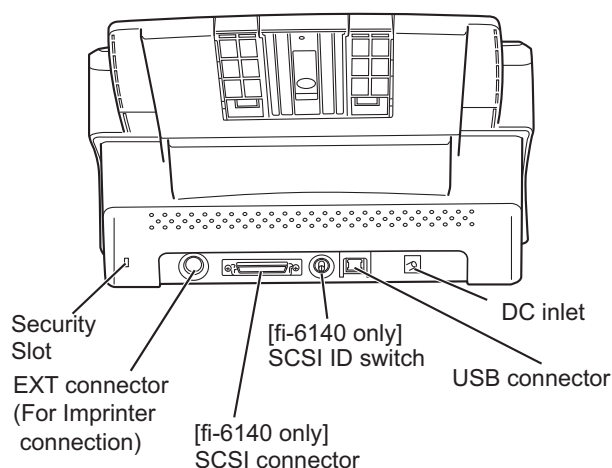

[fi-6240/fi-6230]

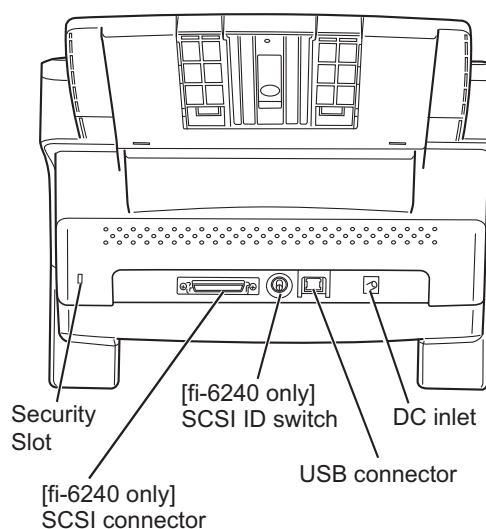

Removable Parts

The following shows the parts that can be removed from the scanner.

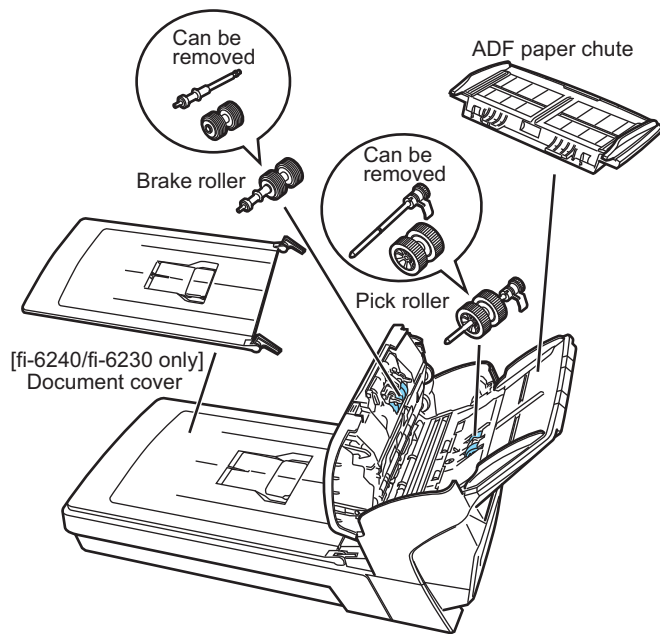

1.3 Operator Panel

The operator panel is located on the right side of the scanner. This panel is comprised of a Function Number Display, four buttons, and a LED.

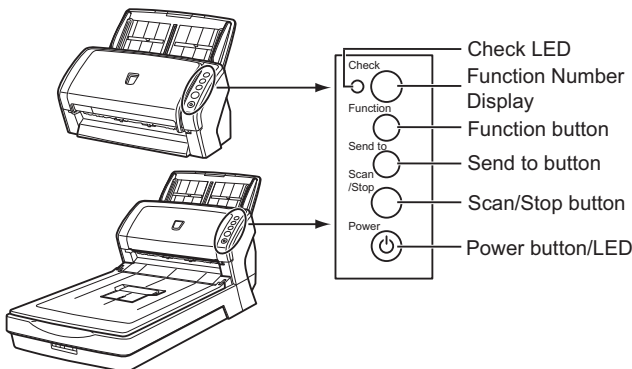

Name		Function
Function Number Display		Indicates the Function Number and error status. For details, refer to "Indications on the Function Number Display" below.
Buttons	Function	Changes the Function activated by the Send to button (*).
	Send to	<ul style="list-style-type: none"> • Launches the linked application software (*). • Resets an error.
	Scan/Stop	<ul style="list-style-type: none"> • Launches a linked application software. • Resets an error. • Cancels ongoing scanning.
	Power	Turns on and off the scanner.
LED	Check	Blinks to indicates an error.
	Power	Stays illuminated when the scanner is turned on.

*) About the settings on the launcher, refer to FUJITSU TWAIN32 scanner driver help and the "fi-6140/fi-6240/fi-6130/fi-6230 Operator's Guide" in the Setup CD-ROM.

Indications on the Function Number Display

Indication	Descriptions
8	Lights only one time upon turning on the scanner.
P	Indicates that the scanner has been turned ON and is being initialized.
0	Indicates that initialization will soon be completed.
1	Indicates that initialization has been completed successfully. This status is called "Ready Status."
J U	Indicates that a recoverable error occurred during scanning with the image scanner. "U" or "J" and an "error number" is displayed alternately. When an error is indicated, press the [Scan] or [Send to] button to return to the Ready Status ("1").
E F C H A L	Indicates that an abnormality (alarm) occurred in the image scanner during its initialization or during scanning. "E", "F", "C", "H", "A", or "L" and an "alarm number" is displayed alternately. When the alarm number is displayed, press the [Scan] or [Send to] button to return to the Ready Status. When an alarm is indicated, turn off the scanner once, and then turn it on. If the alarm persists, contact your service engineer, the store where you purchased the scanner, or an authorized service provider.

Chapter2 INSTALLATION OF THE SCANNER

2.1 Installing the Scanner

1. Place the scanner at its installation site.

For details on the scanner's dimensions and required installation space, refer to chapter 9 "SCANNER SPECIFICATION" of "fi-6140/fi-6240/fi-6130/fi-6230 Operator's Guide" in the Setup CD-ROM. For fi-6140/fi-6130, go to Step 3.

2. Unlock the Transport lock.

The carrier unit inside the fi-6240/fi-6230 is fixed in place with the transport lock to prevent the scanner from being damaged during transportation. To unlock the transport lock, slide the transport lock switch on the scanner front.

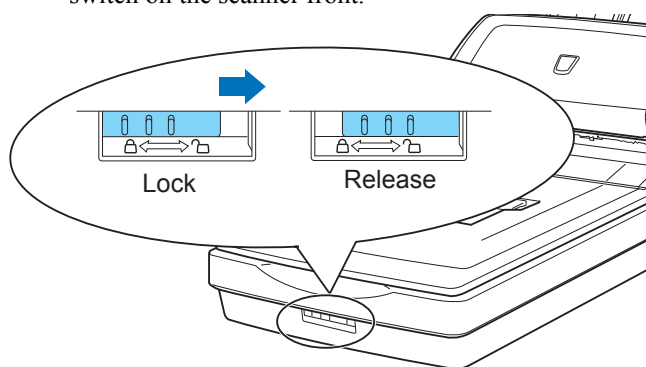

3. Attach the ADF paper chute.

Hold the ADF paper chute and insert its tabs into the corresponding slots in the scanner as shown in the next figure below. Let the ADF paper chute down to fit into position.

The Side guides of the ADF paper chute have to face up.

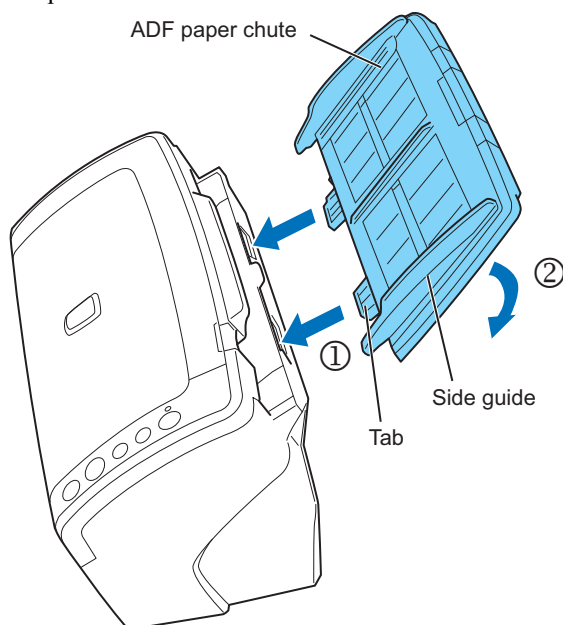

4. Connect the AC adapter.

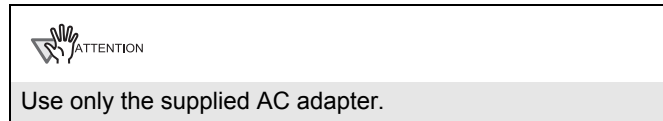

1) Connect the AC cable to the AC adapter.

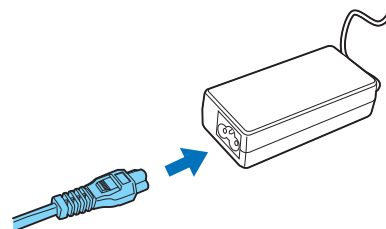

2) Connect the AC adapter connector to the scanner's DC inlet.

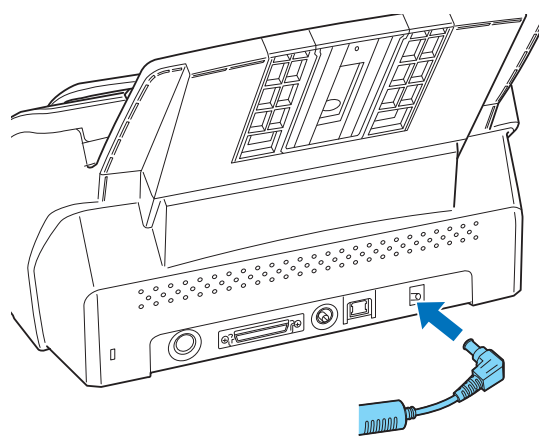

3) Plug the AC cable into an outlet.

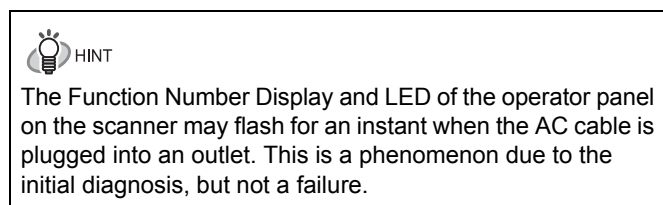

2.2 Connecting the Scanner to Your PC

Connect either with the USB cable or the SCSI cable. SCSI is supported for the fi-6140/fi-6240 only.



This scanner is provided with two interfaces: Ultra SCSI and USB 2.0 / 1.1. Connect only one of the USB or SCSI cable.

■ Connecting with the USB Cable

1. Connect the USB cable to the USB connector.

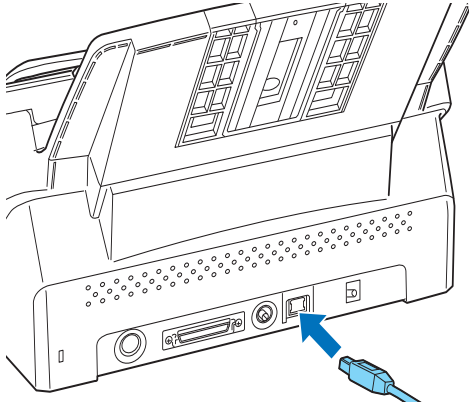

2. Connect the other end of the USB cable to the PC.



- Be sure to use the USB cable which comes as an accessory with this scanner. Scanning operation with commercially available cables is not guaranteed.
- When connecting to an USB hub, use the first stage USB hub that is closest to the computer. If you use the second or later hub stages, the scanner may not operate correctly.
- If you connect the scanner with USB 2.0, it is required that the USB port and Hub are compliant with USB 2.0. The scanning speed may slow down if it is connected with USB1.1.

■ Connecting with the SCSI Cable

When using the scanner with a SCSI interface, the following SCSI cable and SCSI card must be purchased.

- **SCSI cable:**
Use a cable which complies with a 50 Pin Contact Shielded High-Density SCSI Device Connector for Ultra SCSI.
- **SCSI card:**
Find the recommended SCSI card information in the Fujitsu web site (FAQ).

<http://imagescanner.fujitsu.com/>



- After connecting the SCSI cable, turn the scanner on.
- In a SCSI daisy chain formation, connect the scanner so that it is the terminated device.

1. Insert the SCSI cable into the SCSI connector of the scanner until both sides click.

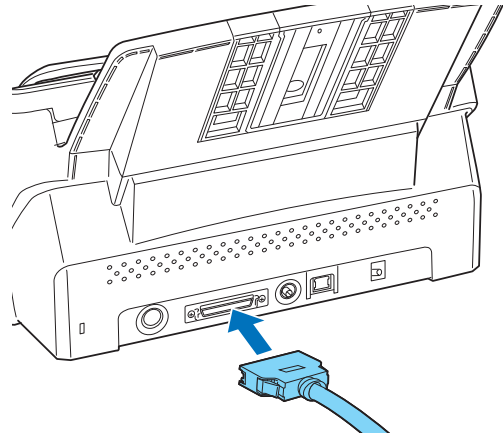

2. Connect the other end of the cable to your computer.



Be careful not to bend the pins of the SCSI connector when connecting to the scanner.



The SCSI ID initially set at the factory is [5]. If the SCSI ID of another SCSI device is set to the same ID, either change the scanner's SCSI ID or SCSI ID of the other SCSI device. For details on how to change the SCSI ID, refer to "Setting the SCSI ID" in this section (⇒ page 4).

■ Setting the SCSI ID

The factory initial setting for SCSI ID is [5].

1. Press the Power button at least for two seconds to turn off the scanner.
2. Set the SCSI ID using the SCSI ID switch on the back of the scanner.

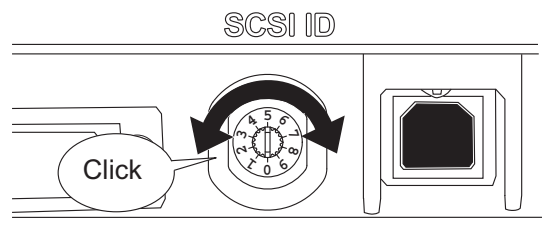

ID No.	Description
0 to 7	Can be set as the ID
8, 9	Works with the factory default value (SCSI ID = 5).

3. Press the Power button to turn on the scanner.
When the scanner is turned ON, the SCSI ID set at Step 2 is enabled.

2.3 Installing the Scanner Software

To scan documents with this scanner, you must install a scanner driver for operating the scanner as well as scanning software (hereinafter called the "application") for launching the driver and performing a scan.

The scanner drivers and application provided with the scanner are as follows:

- **Scanner driver:**
FUJITSU TWAIN 32 (⇒ page 5)
FUJITSU ISIS (⇒ page 6)
- **Scanning application:**
ScandAll PRO (⇒ page 8)
(Supports both FUJITSU TWAIN 32 and ISIS)

Install either of the scanner drivers above and ScandAll PRO.



Be sure to install a scanner driver, FUJITSU TWAIN 32 or FUJITSU ISIS for using VRS Image Processing Option, also. Installing any one of the scanner drivers will also install "Software Operation Panel," which is needed to change the scanner settings.

In addition, this scanner is bundled with the following software applications. To make full use of the scanner, try to use them together.

- **Error Recovery Guide (⇒ page 8)**
When errors occur in the scanner, you can view information about what happened to the scanner and how to solve the problem on the screen of the personal computer.
- **Image Processing Software Option <Trial Version> (⇒ page 8)**
This is an optional application for performing binary image processing on scanned images.
- **QuickScan Pro™ <Trial Version> (⇒ page 8)**
This application complies with the ISIS standard and it is used for scanning images. This scanner is accompanied with a trial version of this application.
- **Adobe Acrobat (⇒ page 9)**
This is an industry-standard application used for creating, managing, and making use of digitalized documents in PDF format.

How to install drivers and applications is described below.

For FUJITSU TWAIN32 Scanner Driver

FUJITSU TWAIN 32 is a TWAIN-compliant scanner driver. To use this scanner with any TWAIN-compatible application, install FUJITSU TWAIN 32, following the procedure below.

■ Preparation

Do the following before installing the application:

- Unpack the Setup CD-ROM, but do not insert the Setup CD-ROM into the CD drive yet.
- Connect the scanner correctly to your computer.



For details on how to connect the scanner, refer to section "2.2 Connecting the Scanner to Your PC" on page 4.

- Uninstall any older versions of FUJITSU TWAIN 32 if they are already installed on your computer.



Uninstall [Scanner Utility for Microsoft Windows] from [Add/Remove Programs] on the control panel.

■ Installing the FUJITSU TWAIN32 Scanner Driver



Screenshots taken in Windows XP are used as examples. The displayed windows and operations may slightly vary depending on the operating system you are using.

1. Press the Power button to turn on the scanner.
2. Turn on your computer and log on to Windows.



Be sure to log on as a user with "Administrator" privileges.

3. When the scanner is automatically detected, [Found New Hardware Wizard] or [Add/Remove Hardware Wizard] dialog box appears. Click [Cancel] to close the Wizard dialog box.



4. Insert the Setup CD-ROM into the CD drive.
⇒ <SETUP DISK START UP SCREEN> appears.



This screen may not appear if the "AutoPlay" setting is set to off. In this case, find "Install.exe" in the CD-ROM using "Explore" or "My Computer" to start installation.

- Click [INSTALL PRODUCTS], and then click [TWAIN Driver].

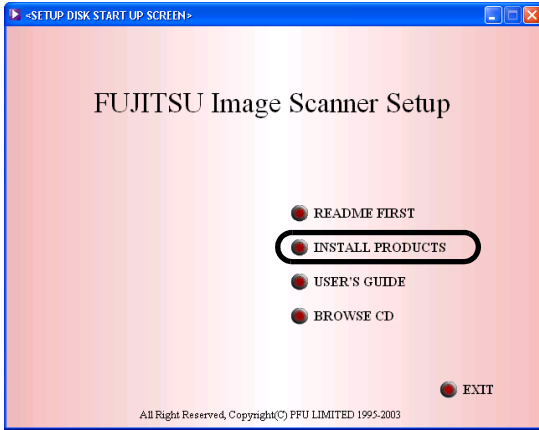

- The Error Recovery Guide Installation dialog box appears.

Error Recovery Guide is an application with which you can view on-screen information for troubleshooting errors that may occur in the scanner. This guide helps solve problems, so select [Yes] to install it. You may also choose to install it later.

ATTENTION

After you select [Yes] for installing Error Recovery Guide, the [Choose Setup Language] dialog box appears. Select a language and follow the on-screen instructions. The Error Recovery Guide dialog box is automatically displayed when the installation is complete. Wait until the installation of the TWAIN driver starts.

- Select a language for the installation on the [Choose Setup Language] dialog box, and then click the [Next] button.

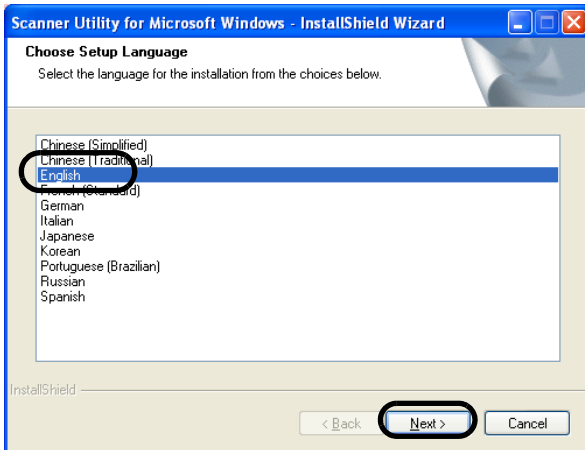

- Install the driver, following the on-screen instructions.

- When you see the [InstallShield Wizard Complete] dialog box, click the [Finish] button.

ATTENTION

- Depending on the state of the operating system, the computer may shut down and restart. In this case, the computer detects the scanner when it starts up. Do not remove the Setup CD-ROM from the CD drive until the computer completely starts up again.
- Depending on the operating system you are using, you may need to do the following.
 - Windows 2000:** If you see the [Digital Signature not Found] dialog box, click the [Yes] button.
 - Windows Vista:** If you see the [Found New Hardware] dialog box, select [Locate and install driver software], and then in the [User Account Control] dialog box, click the [Continue] button, if it is displayed.

The installation of FUJITSU TWAIN 32 is complete. Next, install ScandAll PRO (⇒ page 8).

ATTENTION

To make sure that FUJITSU TWAIN 32 is successfully installed, perform a scan with a TWAIN-compliant application such as ScandAll PRO. For information about how to scan with ScandAll PRO, refer to section "2.4 Checking Scanner Driver Operation" on page 10.

For FUJITSU ISIS Scanner Driver

FUJITSU ISIS is an ISIS-compliant scanner driver. To use this scanner with any ISIS-compatible application, install FUJITSU ISIS, following the procedure below.

■ Preparation

Do the following before installing the driver:

- Unpack the Setup CD-ROM, but do not insert the Setup CD-ROM into the CD drive yet.
- Connect the scanner correctly to your computer.

HINT

For details on how to connect the scanner, refer to section "2.2 Connecting the Scanner to Your PC" on page 4.

■ Installing the FUJITSU ISIS Scanner Driver



Screenshots taken in Windows XP are used as examples. The displayed windows and operations may slightly vary depending on the operating system you are using.

1. Press the Power button to turn on the scanner.
2. Turn on your computer, and then log on to Windows.



Be sure to log on as a user with "Administrator" privileges.

3. When the scanner is automatically detected, [Found New Hardware Wizard] or [Add/Remove Hardware Wizard] dialog box appears. Click the [Cancel] button to close the Wizard dialog box.



4. Insert the "Setup CD-ROM" into the CD drive.
⇒ <SETUP DISK START UP SCREEN> appears.



This screen may not appear if the "AutoPlay" setting is set to off. In this case, find "Install.exe" in the CD-ROM using "Explore" or "My Computer" and execute it.

5. Click [INSTALL PRODUCTS], and then click [ISIS Driver].

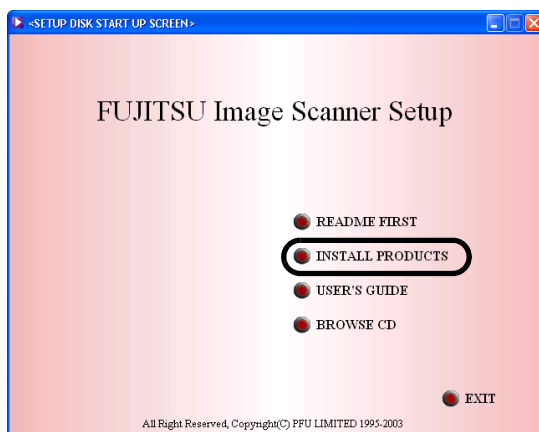

6. Error Recovery Guide Installation dialog box appears.

Error Recovery Guide is an application with which you can view on-screen information for troubleshooting errors that may occur in the scanner. This guide helps solve problems, so select [Yes] to install it. You may also choose to install it later.



After you select [Yes] for installing Error Recovery Guide, the [Choose Setup Language] dialog box appears. Select a language and follow the on-screen instructions. The Error Recovery Guide dialog box is automatically displayed when the installation is complete. Wait until the installation of the ISIS driver starts.

7. Select a language for the installation on the [Choose Setup Language] dialog box, and then click the [Next] button.

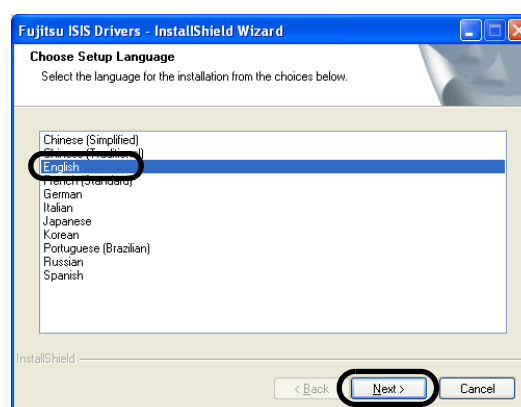

8. Install the driver, following the on-screen instructions.
9. When you see the [InstallShield Wizard Complete] dialog box, click the [Finish] button.

Your computer will restart and detect the scanner. Do not remove the Setup CD-ROM from the CD drive until your computer completely starts up again.



Depending on the operating system you are using, you may need to do the following.

Windows 2000:

If you see the [Digital Signature not Found] dialog box, click [Yes].

Windows Vista:

If you see the [Found New Hardware] dialog box, select [Locate and install driver software], and then in the [User Account Control] dialog box, click the [Continue] button, if it is displayed.

The installation of FUJITSU ISIS is complete.

Next, install ScandAll PRO (⇒ page 8).



To make sure that FUJITSU ISIS is successfully installed, perform a scan with a ISIS-compliant application such as ScandAll PRO. For information about how to scan with ScandAll PRO, refer to section "2.4 Checking Scanner Driver Operation" on page 10.

ScandAll PRO

ScandAll PRO is software for scanning images, which is in compliance with both TWAIN/ISIS standards. Using FUJITSU TWAIN 32 or FUJITSU ISIS together with ScandAll PRO allows you to create document images.



Be sure to log on as a user with "Administrator" privileges.

1. Insert the Setup CD-ROM into the CD drive.
⇒ <SETUP DISK START UP SCREEN> appears.
2. Click [INSTALL PRODUCTS], and then click [ScandAll PRO].
3. Select a language for the installation on [Choose Setup Language] dialog box, and then click the [OK] button.
4. Proceed with the installation, following the on-screen instructions.
5. When the [InstallShield Wizard Complete] dialog box appears, click the [Finish] button.



For information about the features of ScandAll PRO, refer to Help topics in ScandAll PRO.

Error Recovery Guide

If Error Recovery Guide is installed on your computer, you can troubleshoot errors that may occur in the scanner by simply following the on-screen instructions.

If you did not install Error Recovery Guide together with the scanner driver, follow the procedure below to install it.

1. Insert the Setup CD-ROM into the CD drive.
⇒ <SETUP DISK STARTUP SCREEN> appears.
2. Click [INSTALL PRODUCTS], and then click [Error Recovery Guide].
3. Select a language for the installation in the [Choose Setup Language] dialog box, and then click the [Next] button.
4. Install the application, following the on-screen instructions.
5. When you see the [InstallShield Wizard Complete] dialog box, click the [Finish] button.

Image Processing Software Option (Trial)

For details on the installation of Image Processing Software Option (Trial Version), refer to the "Image Processing Software Option User's Guide."

QuickScan Pro™ (Trial)

QuickScan Pro™ is image capturing software based on the ISIS standard. By using this software together with FUJITSU ISIS, you can scan documents with the scanner. Follow the procedure below to install the trial version of QuickScan Pro™ that comes with this scanner.



Be sure to log on as a user with "Administrator" privileges.

1. Insert the Setup CD-ROM into a CD drive.
⇒ <SETUP DISK STARTUP SCREEN> appears.
2. Click [INSTALL PRODUCTS], and then click [QuickScan Pro (Trial)].
3. In the [Welcome to the InstallShield Wizard for QuickScan 4.5] dialog box, click the [Next] button.
4. Type in necessary information in the [Customer Information] dialog box, and then click the [Next] button.

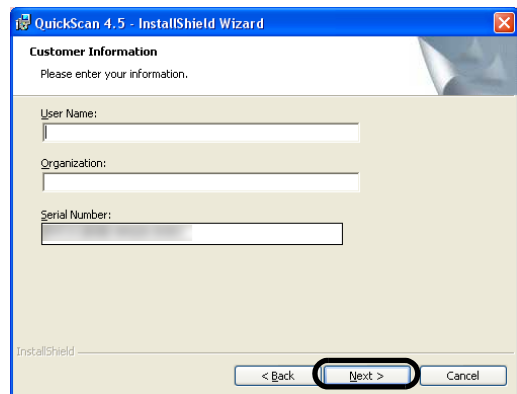

"QuickScan Pro™" included in the Setup CD-ROM is a trial version that can be executed 30 times before it is disabled. If you wish to continue using this product, please consider purchasing the full version. (When you install the trial version, use the displayed Serial Number.)

5. Install the application, following the on-screen instructions.



For information about the features and operations of QuickScan Pro™, refer to "QuickScan Overview" or "QuickScan Help." From the [start] menu, select [All Programs] ⇒ [EMC Captiva] ⇒ [QuickScan], and then select a desired file.

Adobe Acrobat

Install Adobe Acrobat from the "Adobe Acrobat CD-ROM" provided with this scanner.



HINT

Adobe Acrobat is needed to display manuals.
* You do not have to install Adobe Acrobat if it is already installed on your computer.

1. Insert the "Adobe Acrobat CD-ROM" into the CD drive.

⇒ The [Adobe Acrobat] dialog box appears.



ATTENTION

This dialog box may not appear if the "AutoPlay" setting is set to off. In this case, find "AutoPlay.exe" in the CD-ROM using "Explore" or "My Computer" and execute it.

2. In the dialog box below, click the folder icon; installation starts and the Setup dialog box appears.

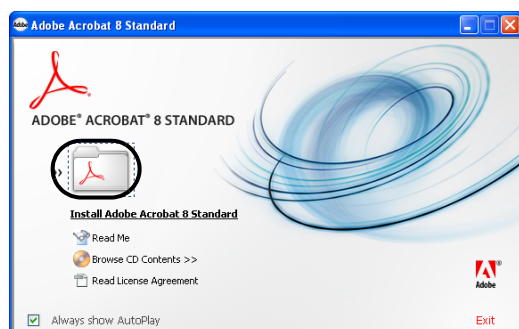

3. In the dialog box below, click the [Next] button.



4. Install the application, following the on-screen instructions.



HINT

For information about how to install Adobe Acrobat, refer to "Read Me" that you can view when [Readme] is clicked in the dialog box shown in Step 2.

For information about how to operate Adobe Acrobat, refer to the Help topics in Adobe Acrobat.



ATTENTION

Notes for using Adobe Acrobat

When scanning a paper document and converting the image to PDF using Adobe Acrobat, unexpected images may be output when:

1. Setting "Edge Shadow Removal" in Acrobat, and setting "Digital Endorser" or "Black Background" options in the TWAIN driver at the same time. Letter strings embedded in the image or the background may be missed.
Solution 1: Set "Edge Shadow Removal" to "OFF" or set any option other than "Adaptive" for "Color/Grayscale" and/or "Monochrome" under "Compression" by selecting [File]⇒[Create PDF]⇒[From Scanner]⇒[Optimization Options] in Acrobat.
Solution 2: Adjust the scanning density in the TWAIN driver.
2. Setting "Adaptive" for "Color/Grayscale" and/or "Monochrome" under "Compression" in Acrobat and scanning in a resolution lower than the resolution recommended for Acrobat.
Solution: Set OPTION to something other than "Adaptive" under "Compression."
3. Scanning a document longer than the double letter (11x17) or A3 size, when setting "Overscan" in the TWAIN driver, the scan may fail.
Solution: When scanning a double letter (11x17) or A3 size of document, do not set "Overscan" in TWAIN driver.
*As for detailed usage and information on Acrobat, refer to "Create a PDF file from a scanned document" in Acrobat Help.

Support and User registration for Adobe products

For details, refer to the technical support information stored in the [Customer Support] folder on Adobe Acrobat CD-ROM. (Note that free person-to-person support is not available for this is a bundled product.)

2.4 Checking Scanner Driver Operation

This section explains how to check the operation of the installed scanner driver by using ScandAll PRO. Make sure that the scanner driver is installed properly, following the procedure below.

1. Load the document on the scanner.
For information about how to load the document, refer to section "2.2 Loading Documents on the ADF for Scanning" in "fi-6140/fi-6240/fi-6130/fi-6230 Operator's Guide."
2. Launch ScandAll PRO.
From the [start] menu, select [All Programs] ⇒ [Fujitsu ScandAll PRO] ⇒ [Fujitsu ScandAll PRO].
3. In ScandAll PRO, select [Tool] on the menu, and then select [Preferences].

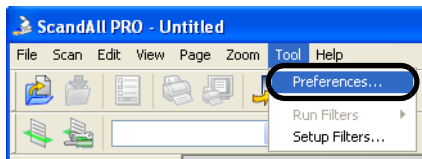

⇒ The [Setup] dialog box appears.

4. On the [Scan] tab, select a driver.
To check the operation of FUJITSU TWAIN 32, select [TWAIN].
To check the operation of FUJITSU ISIS, select [ISIS].

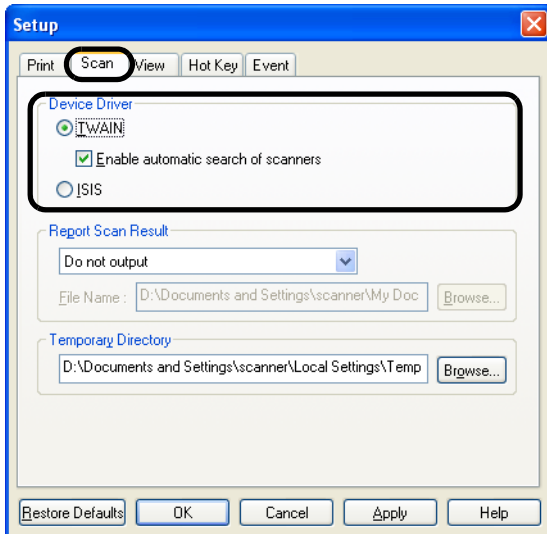

5. Click the [OK] button to close the [Setup] dialog box.
6. In ScandAll PRO, select [Scan] on the menu, and then select [Select Scanner].

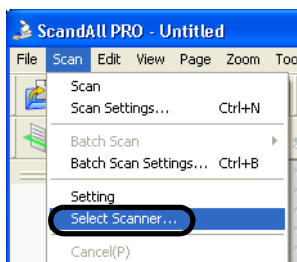

7. Select a scanner in the displayed dialog box.
To use FUJITSU TWAIN 32:
Select [FUJITSU fi-6140dj], [FUJITSU fi-6240dj], [FUJITSU fi-6130dj], or [FUJITSU fi-6230dj], and then click the [Select] button.

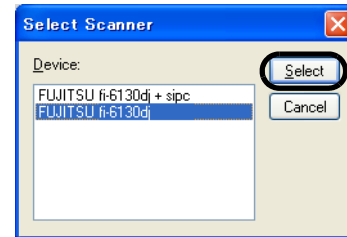

- To use FUJITSU ISIS:
Select [Fujitsu fi-6140], [Fujitsu fi-6240], [Fujitsu fi-6130], or [Fujitsu fi-6230], and then click the [Select] button.

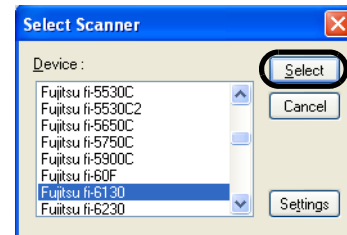

8. Select [Scan] on the menu, and then select [Scan Settings].
9. In the [Scan Settings] dialog box, clear the [Save to file] checkbox.

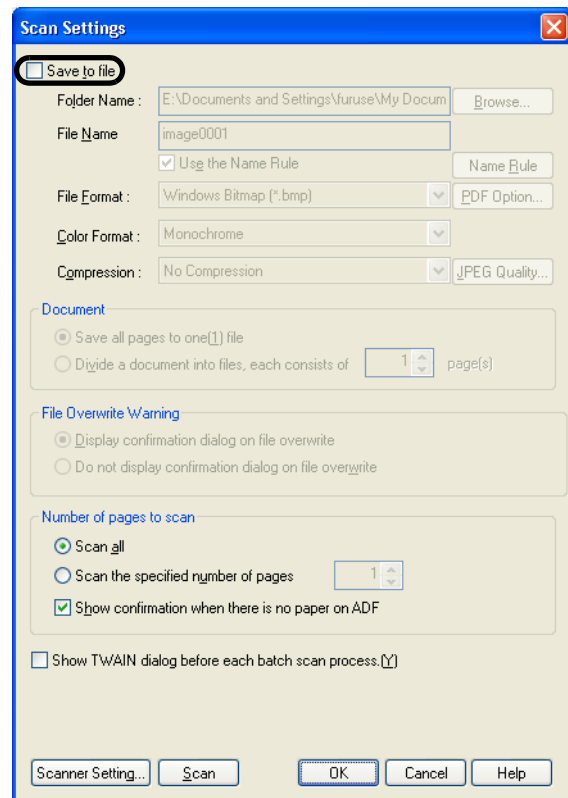

HINT
You only check the operation now, so you do not have to save to file.

10. Click [Scanner Setting].

⇒ A setup dialog box appears for you to configure scanner driver settings.

11. Configure scanner settings such as the resolution and paper size.

To use FUJITSU TWAIN 32:

On the dialog box below, configure scan settings, and then click the [OK] button.

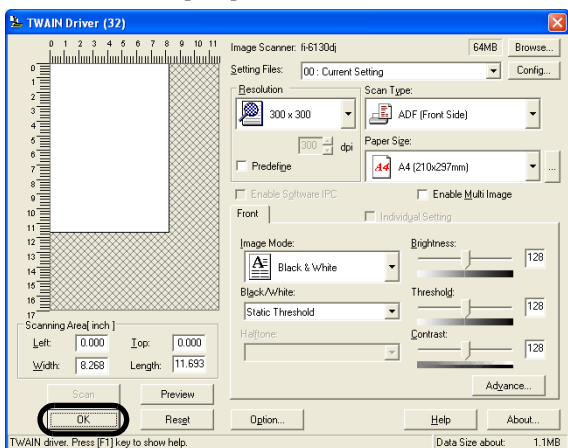

To use FUJITSU ISIS:

On the dialog box below, configure scanning settings, and then click the [OK] button.

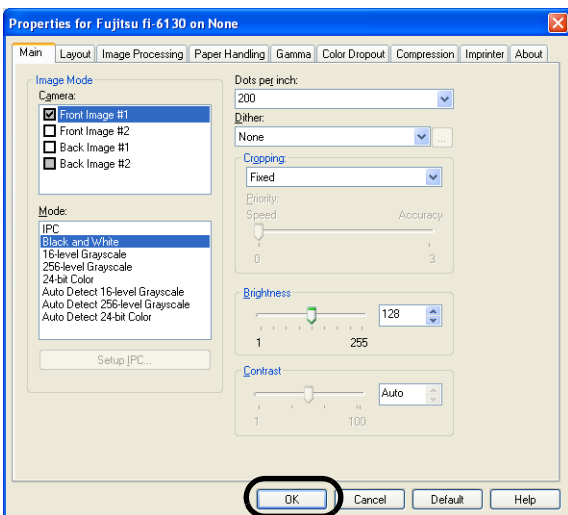

⇒ You are returned to the [Scan Settings] dialog box.

12. Click the [Scan] button.

⇒ The document is scanned and the scanned image is displayed in the [ScandAll PRO] window.

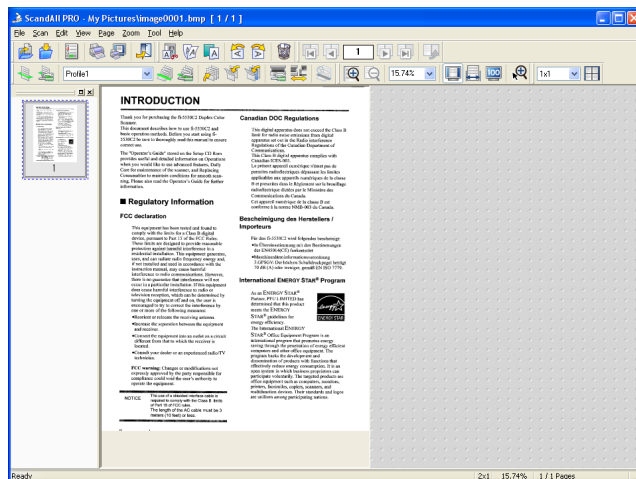

If the scanned document image is displayed in the window, it means that the scanner driver is installed properly.

For further information about how to scan documents, refer to "fi-6140/fi-6240/fi-6130/fi-6230 Operator's Guide" contained in the Setup CD-ROM.

2.5 Uninstalling Supplied Programs

The following explains how to uninstall software applications provided with the scanner.



HINT

Screenshots taken in Windows XP are used as examples. The displayed windows and operations may slightly vary depending on the operating system you are using.

1. Start your computer.



ATTENTION

Be sure to log on as a user with "Administrator" privileges.

2. Exit all applications.

3. From the [start] menu, select [Control Panel] ⇒ [Add or Remove Programs].

⇒ In the [Add or Remove Programs] dialog box, you can view a list of installed applications.

4. Select an application you want to uninstall as follows:

- To remove FUJITSU TWAIN 32, select **"Scanner Utility for Microsoft Windows."**
- To remove ScandAll PRO, select **"Fujitsu ScandAll PRO."**
- To remove FUJITSU ISIS, select **"Fujitsu ISIS Drivers."**
- To remove Error Recovery Guide, select **"Error Recovery Guide for fi-6140/fi-6240"** or **"Error Recovery Guide fi-6130/fi-6230."**



HINT

When you are using FUJITSU TWAIN 32, you may see the TWAIN Driver setup dialog box again. If so, click the [Scan] button on the dialog box.

- To remove Software Operation Panel, (Software Operation Panel is automatically installed together with FUJITSU TWAIN 32/ISIS), select "**Software Operation Panel.**"
- To remove QuickScan Pro™, select "**QuickScan.**"



HINT

- For information about how to uninstall Image Processing Software Option (Trial version), refer to "Image Processing Software Option User's Guide."
- For information about how to uninstall Adobe Acrobat, refer to Adobe Acrobat "Read Me."

5. Click the [Change/Remove] button or the [Remove] button.
6. When you see a confirmation dialog box, click the [OK] button or the [Yes] button.
⇒ Upon clicking the button, uninstallation is started.



ATTENTION

Displays may vary depending on the operating system you are using. Follow the on-screen instructions.

Examples:

In Windows 2000, the window and button names described above are as follows:

- [Add or Remove Programs] ⇔ [Add/Remove Applications]
- The [Change/Remove] button ⇔ The [Add/Remove] button

In Windows Vista, the window and button names described above are as follows:

- [Add or Remove Programs] ⇔ [Programs and Features]
- The [Change/Remove] button ⇔ The [Uninstall] button.

Appendix1 TROUBLESHOOTING

■ Troubleshooting checklist

Symptom	Check this item	Remedy
Scanner does not turn on.	Have you pressed the power button on?	Push the power button.
	Are the AC cable and AC adapter properly connected to the scanner?	Correctly connect the AC cable and the AC adapter. Disconnect the AC cable and the AC adapter from the scanner, then connect them again. If this does not restore the power supply, contact the store where you purchased the scanner or an authorized FUJITSU scanner service provider.
	Is Windows normally started up?	Push the power button again after completely starting up Windows.
Scanning does not start.	Are the documents loaded correctly on the ADF paper chute?	Load the document correctly on ADF paper chute.
	Is the ADF closed completely?	Close the ADF completely.
	Is the USB cable or SCSI cable properly connected?	Correctly connect the cable. (When a USB hub is used, check the hub's power supply.)
	(When using SCSI interface) Is SCSI ID set correctly?	Set SCSI ID correctly by SCSI ID switch on rear of scanner.
	Does the Function Number Display indicates an alarm or an error?	When the Function Number Display indicates an alarm or an error, refer to chapter 6 "Troubleshooting" of "fi-6140/fi-6240/fi-6130/fi-6230 Operator's Guide" for removing the alarm or the error.
	Does the alarm state remain displayed even after the scanner has been turned off and back on again?	Turn off and on the power button. If this does not eliminate the alarm state, contact the store where you purchased the scanner or an authorized FUJITSU scanner service provider.

Appendix2 DAILY CARE



When operating the scanner, the ADF's inside glass becomes very hot.

Before you clean inside the scanner, turn off its power and unplug the AC adapter from the outlet. Wait for at least 15 minutes.

Turn on the scanner when you clean the Feed rollers or Eject rollers.



Do not use any aerosol sprays or alcohol based sprays to clean the scanner.

Dust blown up by strong air from the spray may enter the inside of the scanner. This may cause the scanner to fail or malfunction.

Sparks, caused by static electricity, generated when blowing off dust and dirt from the outside of the scanner may cause a fire.

■ Cleaning Materials

Cleaning Materials	Parts Number	Remarks
Cleaner F1	PA03950-0352	1 bottle Moisten the cloth with this fluid and wipe the scanner clean. (*1)
Cleaning wipe	PA03950-0419	24 sheets per pack (*1)(*2)
Lint-free dry cloth	- Commercially available one	

*1: For details about the cleaning materials, contact the FUJITSU scanner dealer where you purchased the scanner.

*2: Pre-moistened with Cleaner F1, Cleaning Wipes are used instead of moistened cloths.

■ Cleaning Method

The ADF must be cleaned with a lint-free cloth moistened with the Cleaner F1.



It may take long before the cleaner vaporizes if a large quantity is used. When cleaning the scanner parts, dampen a cloth with modest quantities of the cleaner. In addition, wipe off the cleaner completely with a soft lint-free cloth to leave no residue on the surface of the cleaned parts.

■ Locations and Cycle for Cleaning

Part to clean	Standard Cleaning Cycle
Brake Roller	Clean these parts after every 5,000 sheets.
Pick roller	
Feed rollers	
Plastic rollers	
Eject rollers	
Glass	



The scanner must be cleaned more frequently if you scan any of the following type of sheets:

- Documents of coated paper
- Documents that are almost completely covered with printed text or graphics
- Chemically treated documents such as carbonless paper
- Documents containing a large amount of calcium carbonate
- Documents written by pencil
- Documents on which the toner is not fused sufficiently.

For details on cleaning the ADF, refer to section 4.3 "Cleaning the ADF" of "fi-6140/fi-6240/fi-6130/fi-6230 Operator's Guide" on the Setup CD-ROM.

Appendix 3 REPLACING CONSUMABLES



During its operation, the inside glass of the ADF becomes very hot.

Before replacing the consumables, turn its power off and unplug the AC adapter from the outlet. Wait at least 15 minutes.

Consumables and Replacement Cycles

The followings are the specifications of consumables and their recommended replacement cycles.

Description	Parts No.	Standard Replacement Cycle
Brake roller	PA03540-0001	After 200,000 sheets or one year
Pick roller	PA03540-0002	After 200,000 sheets or one year

To purchase consumables, contact the store where you purchased the scanner or an authorized FUJITSU scanner service provider.

The replacement cycles above are rough guidelines when using A4/Letter woodfree or wood containing paper 64 g/m² (17 lb). This cycle varies according to the type of the paper used and how frequently the scanner is used and cleaned.



Use only the designated consumables.

The following illustrations show the locations of the consumables. For details, refer to chapter 5 "REPLACING CONSUMABLES" of "fi-6140/fi-6240/fi-6130/fi-6230 Operator's Guide" on the Setup CD-ROM.

Replacing the Brake Roller

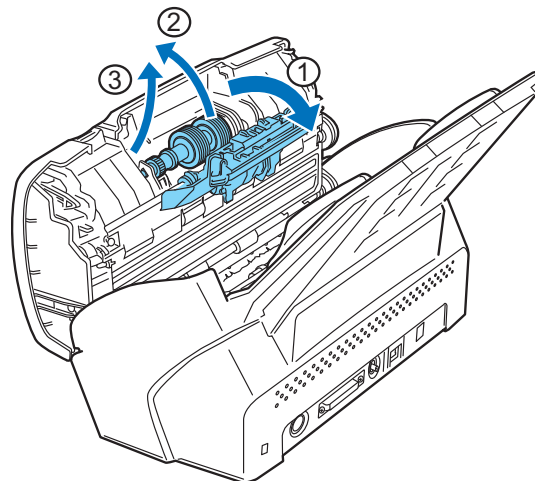

Replacing the Pick Roller

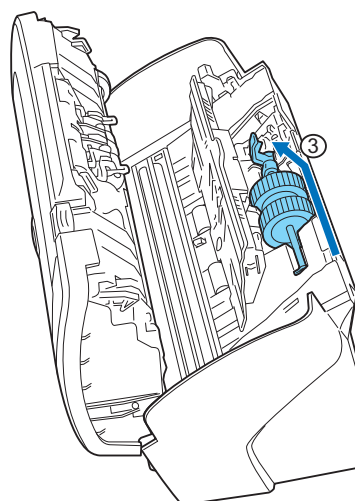
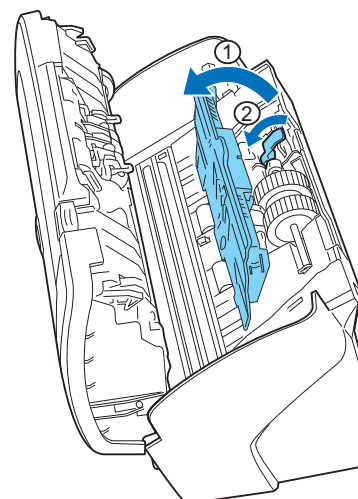

Appendix4 Purchasing the Carrier Sheet

It is necessary to purchase a Carrier Sheet separately when you want to perform a scan using the Carrier Sheet.

As a guideline, it is recommended to replace the Carrier Sheet every 500 scans.

However, the number of times of use differs according to usage. If scratches and dirt are conspicuous, replace the Carrier Sheet accordingly.

The description of the Carrier Sheet and its part number are as follows:

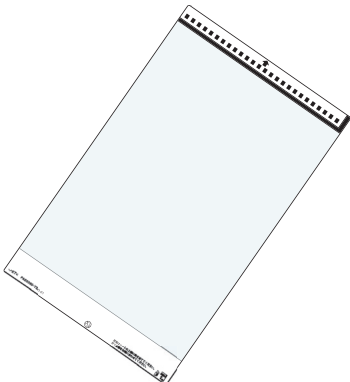
Description	Qty	P/N
<p>Carrier Sheet</p> 	5 pcs	PA03360-0013

To obtain this parts, contact your FUJITSU dealer or an authorized FUJITSU scanner service provider.

fi-6140/fi-6240/fi-6130/fi-6230 Image Scanner

Getting Started

P3PC-2152-05EN

Issue Date: August 2011

Issued by: PFU LIMITED

-
- Copying of the contents of this manual in whole or in part and copying of the scanner application is prohibited under the copyright law.
 - The contents of this manual are subject to change without notice.
 - PFU LIMITED is not liable whatsoever for any damages resulting from use of this scanner and procedures described in this manual, profit due to defects, and any claims by a third party.