



## Getting Started

### Contents

Introduction .....	1
Conventions .....	6
Safety Precautions .....	8
Chapter 1 Preparation .....	12
1.1 Checking the Contents of the Package .....	12
1.2 Names and Functions of Parts .....	13
Chapter 2 Connecting the ScanSnap .....	15
2.1 Installing the Supplied Software .....	15
2.2 Connecting the ScanSnap .....	18
Chapter 3 How to Use the ScanSnap .....	23
3.1 Scanning Documents .....	23
3.2 About the Scanning Settings .....	23
3.3 Scanning Office Documents .....	24
3.4 Scanning Business Cards using Cardiris .....	26
Chapter 4 Troubleshooting .....	29
4.1 Troubleshooting Checklist .....	29
4.2 Clearing Paper Jams .....	32
Chapter 5 Daily Care .....	33
5.1 Cleaning Materials .....	33
5.2 Cleaning the ScanSnap Exterior .....	33
5.3 Cleaning Inside of the ScanSnap .....	34
Chapter 6 Consumables .....	35

Please read this guide before connecting the scanner to your computer.

For further details, refer to the "ScanSnap S300M Operator's Guide" included in the supplied ScanSnap Setup CD-ROM.

---

# Introduction

Thank you for purchasing our Color Image Scanner, ScanSnap S300M (hereinafter referred to as "the ScanSnap").

The ScanSnap S300M is a color image scanner capable of double-sided scanning in both monochrome and color. It is complete Office Solution, which helps you improve productivity and solve scanning problems in your office.

The features of the ScanSnap product are as follows:

- **You can turn images on paper into PDF files by just pressing the [SCAN] button!**

You can turn documents cluttering up your desk into PDF files, which are easy to print and attach to e-mail messages; you can view and archive them on your right at your fingertips.

In addition, the ScanSnap can automatically recognize the type of documents, color or black-and-white, so that the size of the scanned image file can be reduced when documents containing both color and black-and-white pages are scanned. (Moreover, the ScanSnap can automatically remove blank pages from the document to further reduce the size of the file.)

- **You can scan documents with speed and efficiency!**

Double-sided color documents of A4 or letter size paper can be scanned at a speed of:

- Power-cable-connected: Approx. 8 sheets/minute
- USB-bus-power-cable-connected: Approx. 4 sheets/minute

(when used with a computer with Intel<sup>®</sup> Core<sup>™</sup> Duo 1.83 GHz and with Scan mode set to Normal, Color mode Auto, and Compression rate 3, and others set to defaults)

- **You can eliminate the nuisance of a bulky device!**

Smaller than a sheet of A4 or letter paper in size, the ScanSnap can fit unobtrusively on your desktop all the time.

- **Compact, light-weight, portable body design!**

Its compact, light-weight design makes it possible to hand-carry the ScanSnap together with your laptop computer. There is no need to find an electrical outlet for the ScanSnap if you use the supplied USB bus power cable to connect to your computer.

- **You can convert business cards to Address Book data with ease!**

With Cardiris (supplied with the ScanSnap), business cards can be easily recognized and converted to Address Book data by using the OCR function.

- **The Quick Menu lets even beginners operate the ScanSnap with automatic ease!**

When the [SCAN] button is pressed, the Quick Menu is displayed. What you should do is to select the action you want to perform on the Quick Menu. The Quick Menu is simple enough for first-time use by completely neophytes. (Quick Menu Mode)

- You can send off the scanner image by e-mail or output the scanned image to the printer immediately after scanning!

Without starting applications, you can attach the scanned image to e-mail or make copies of the scanned image by outputting it to the printer.

(\*The ScanSnap S300M Scanner does NOT comply with TWAIN or ISIS standards.)

## Manufacturer

PFU LIMITED

International Sales Dept., Imaging Business Division, Products Group

Solid Square East Tower, 580 Horikawa-cho, Saiwai-ku, Kawasaki-shi, Kanagawa 212-8563, Japan

Phone: (81) (44) 540-4538

## Trademarks

Apple, Apple logo, Mac, Mac OS, iPhoto and Macintosh are registered trademarks of Apple Inc.

Intel and Intel Core are trademarks or registered trademarks of Intel Corporation or its subsidiaries in the United States and other countries.

ISIS is a registered trademarks of EMC Corporation in the United States.

PowerPC is a trademark of International Business Machines Corporation in the United States, other countries, or both.

Cardiris is a trademark of I.R.I.S.

ScanSnap and ScanSnap logo are the trademarks of PFU LIMITED.

Other product names are the trademarks or registered trademarks of the respective companies.

## How Trademarks and Product Names Are Indicated In This Manual

References to operating systems (OS) are indicated as follows:

Mac OS X v10.1:	Mac operating system Version 10.1
Mac OS X v10.2:	Mac operating system Version 10.2
Mac OS X v10.3:	Mac operating system Version 10.3
Mac OS X v10.4:	Mac operating system Version 10.4
Mac OS X v10.5:	Mac operating system Version 10.5

Where there is no distinction between the different versions of the above operating system, the general term "Mac OS X" is used.



The screenshots used in this manual are of Mac OS v10.4. Depending on the operating systems you are using, the screen examples and operations may differ from the actual ones.

---

## ScanSnap and the Manuals

The ScanSnap S300M consists of:

Component	Specification
S300M	Color image scanner
ScanSnap Manager	ScanSnap's driver to scan and save documents
Cardiris	Software for recognizing business cards (OCR)

Following manuals are prepared for you:

Manual	Description
ScanSnap S300M Getting Started (This manual)	Provides basic information to install and use the ScanSnap.
ScanSnap S300M Getting Started (Cable Connection)	Provides detailed information on how to connect the ScanSnap to your computer.
ScanSnap S300M Operator's Guide	Provides detailed information about the installation of the ScanSnap software and hardware, operation of the ScanSnap hardware and ScanSnap Manager.
	Find in: ScanSnap Setup CD-ROM (PDF file)
Cardiris "Read Me.htm"	Provides detailed information on how to use Cardiris.
	Find in: Cardiris application installation folder
Cardiris "User's Manual.pdf"	Provides detailed information about the installation and operation of Cardiris.
	Find in: Cardiris application installation folder

## Regulatory Information

### FCC declaration

This equipment has been tested and found to comply with the limits for a Class B digital device, pursuant to Part 15 of the FCC Rules. These limits are designed to provide reasonable protection against harmful interference in a residential installation. This equipment generates, uses, and can radiate radio frequency energy and, if not installed and used in accordance with the instruction manual, may cause harmful interference to radio communications. However, there is no guarantee that interference will not occur in a particular installation. If this equipment does cause harmful interference to radio or television reception, which can be determined by turning the equipment off and on, the user is encouraged to try to correct the interference by one or more of the following measures:

- Reorient or relocate the receiving antenna.
- Increase separation between equipment and receiver.
- Connect the equipment into an outlet on a circuit different from that to which the receiver is located.
- Consult your dealer or an experienced radio/TV technician.



Changes or modifications not expressly approved by the party responsible for compliance could void the user's authority to operate the equipment.



- The use of a shielded interface cable is required to comply with the Class B limits of Part 15 of FCC rules.
- The length of the AC cable must be 3 meters (10 feet) or less.

## Canadian DOC Regulations

This digital apparatus does not exceed the Class B limit for radio noise emissions from digital apparatus set out in the Radio interference Regulations of the Canadian Department of Communications.

This Class B digital apparatus complies with Canadian ICES-003.

Le présent appareil numérique n'émet pas de parasites radioélectriques dépassant les limites applicables aux appareils numériques de la classe B et prescrites dans le Règlement sur le brouillage radioélectrique dictées par le Ministère des Communications du Canada.

Cet appareil numérique de la classe B est conforme à la norme NMB-003 du Canada.

## Bescheinigung des Herstellers / Importeurs

Für den S300M wird folgendes bescheinigt:

- In Übereinstimmung mit den Bestimmungen der EN45014(CE) funktentstört
- Maschinenlärminformationsverordnung 3. GPSGV: Der höchste Schalldruckpegel beträgt 70 dB (A) oder weniger, gemäß EN ISO 7779.

Dieses Gerät wurde nicht für die Benutzung in unmittelbarer Umgebung starker Lichtquellen (z. B. Projektoren) konzipiert.

## International ENERGY STAR® Program

As an ENERGY STAR® Partner, PFU LIMITED has determined that this product meets the ENERGY STAR® guidelines for energy efficiency.

The International ENERGY STAR® Office Equipment Program is an international program that promotes energy saving through the penetration of energy efficient computers and other office equipment.

The program backs the development and dissemination of products with functions that effectively reduce energy consumption. It is an open system in which business proprietors can participate voluntarily.

The targeted products are office equipment such as computers, monitors, printers, facsimiles, copiers, scanners, and multifunction devices. Their standards and logos are uniform among participating nations.



## Use in High-Safety Applications

This product has been designed and manufactured on the assumption that it will be used in office, personal, domestic, regular industrial, and general-purpose applications. It has not been designed and manufactured for use in applications (simply called "high-safety applications" from here on) that directly involve danger to life and health when a high degree of safety is required, for example, in the control of nuclear reactions at nuclear power facilities, automatic flight control of aircraft, air traffic control, operation control in mass-transport systems, medical equipment for sustaining life, and missile firing control in weapons systems, and when provisionally the safety in question is not ensured. The user should use this product with adopting measures for ensuring safety in such high-safety applications. PFU LIMITED assumes no liability whatsoever for damages arising from use of this product by the user in high-safety applications, and for any claims or compensation for damages by the user or a third party.

# Conventions

## Warning Indications Used in This Manual



This sign warns the operator that improper use, indicated with this sign, may cause death or severe injury of the operator or people in the vicinity, if not followed.



This sign warns the operator that improper use, indicated with this sign, may cause minor injury of the operator, or damage to equipment or property, if not followed.

## Symbols Used in This Manual

This manual uses the following symbols in explanations in addition to warning indications:



This symbol alerts operators to particularly important information. Be sure to read this information.



This symbol alerts operators to helpful advice regarding operation.



This symbol indicates the section where you can get information on related matters such as operation methods.



A TRIANGLE symbol indicates that special care and attention is required.

The drawing inside the triangle shows the specific caution.



A CIRCLE with a diagonal line inside shows action which users may not perform.

The drawing inside or under the circle shows the specific action that is not allowed.



Outline characters on a colored background show instructions users should follow.

It may also include the drawing that shows the specific instruction.

## **Screen Examples in This Manual**

The screen examples in this manual are subject to change without notice in the interest of product improvement.

If actual screens differ from those used as examples in this manual, operate by following the actual ones referring to the User's Manual of the ScanSnap.

The screenshots used in this manual are for the ScanSnap Manager and the Cardiris applications.

## **About Maintenance**

Repairs should be done by properly trained repair technicians.

When this product needs servicing, please contact the store where you purchased it or any authorized FUJITSU Image Scanner service provider.























# Safety Precautions





FOLLOW THESE INSTRUCTIONS AND BE SURE TO HEED ALL WARNINGS AND CAUTIONS DESCRIBED BELOW.



The following describes important warnings.







 	Do not touch the power plug, or connect/disconnect the power or USB bus power cable with wet hands. Doing so might cause electric shock.
	A damaged power or USB bus power cable may cause fire or electric shock. Do not place heavy objects on the power or USB bus power cable, or pull, bend, twist, heat, damage or modify it. Do not use damaged power or USB bus power cables or power plugs. Also, do not use the power cable when the wall socket is loose.
	Use only specified power, USB bus power, and interface cables. Failure to use the correct cables might cause electric shock and equipment failure.
	Use this scanner only at the indicated power voltage and current. Improper power voltage and current might cause fire or electric shock. Also, do not connect to multiple-power strips.
	Wipe off any dust from the metal part and surrounding section of the power plug and those of the USB bus power cable with a soft, dry cloth. Accumulated dust might cause fire or electric shock.
	Do not install the scanner in locations subject to oil smoke, steam, humidity, and dust. Doing so might cause a fire or electric shock.
	To avoid low-temperature burn, do not operate the scanner while keeping touching its heat-generating section such as the bottom of the scanner or the AC adapter for a long time.
	Do not cover the scanner or the AC adapter with a cloth or blanket while the power is being supplied to the scanner. This can help excessive heat generation, and may cause fire.
	Do not use the scanner at a place such as a bathroom, shower room, or swimming pool where it may easily get wet or moistured. Doing so might cause electric shock or fire.

	<p>If you detect heat coming from the device or detect other problems such as smoke, strange smells or noises, immediately turn off the scanner, and disconnect its power plug from the power outlet, or unplug the USB bus power cable from the computer. Make sure that the smoking has stopped, and then contact the store where you bought the scanner or an authorized FUJITSU scanner service provider.</p>
	<p>Firmly insert the power plug and into the power outlet, or the USB bus power cable into the USB port on the computer as far it can go. Not doing so might cause electric shock or fire.</p>
	<p>Do not place heavy objects on the scanner or use the scanner's top surface for performing other work. Improper installation might cause injuries or scanning failure.</p>
	<p>When the scanner is not used for a long period, be sure to disconnect the power plug from the power outlet, or disconnect the USB bus power cable from the computer for safety. Not doing so might cause electric shock or fire.</p>
	<p>In case you have dropped the scanner and any of the parts (e.g., cover) is broken, disconnect the power plug from the power outlet, or disconnect the USB bus power cable from the computer. Then, contact the store where you bought the scanner or an authorized FUJITSU scanner service provider.</p>
	<p>Do not insert or drop metal or flammable foreign objects into the scanner. Do not scan wet documents or documents with paper clips or staples. Do not splash or allow the scanner to get wet.</p>
 	<p>If foreign objects (water, small metal objects, liquids, etc.) get inside the scanner, immediately turn off the scanner and disconnect the power plug from the power outlet, or the USB bus power cable from the computer, and disconnect the interface cable from the computer. Then, contact the store where you bought the scanner or an authorized FUJITSU scanner service provider. Pay particular attention to this warning in households where there are small children.</p>
	<p>Do not take apart or modify the scanner. The inside of the scanner contains high-voltage components. Touching these components might cause fire or electric shock.</p>
	<p>To avoid injuries, do not place the scanner in an area where small children may be able to reach.</p>
	<p>Do not use the scanner while driving a car for safety. Accidents can happen.</p>

	Do not leave the scanner in the direct sunlight, at high temperature such as in a car in the scorching sun, or near heating apparatus. Doing so might cause excessive heat to build up inside the scanner, causing heating, deforming, or melting of the scanner parts (e.g., cover), and raising the temperature inside the scanner, which could result in fire or scanner trouble. Install the scanner in a well-ventilated location.
	Do not move the scanner with the power and interface cables connected as this might damage the cables, causing fire, electric shock or injuries. Before moving the scanner, be sure to disconnect the power plug from the power outlet, and disconnect interface cables as well. Also, make sure that the floor is free of obstructions.
	Avoid getting a sleeve, necktie, or hair caught up in any scanner mechanism when scanning as this may cause injuries.
	Do not use any aerosol sprays or alcohol based sprays to clean the scanner. Dust blown up by strong air from the spray may enter the inside of the scanner. This may cause the scanner to fail or malfunction. Sparks, caused by static electricity, generated when blowing off dust and dirt from the outside of the scanner may cause a fire.

 CAUTION

The following describes important cautions.

 	Install the scanner on a desk so that none of its parts protrude outside of the desktop. Also, make sure that the scanner is installed on a flat, level surface.
	Install the scanner away from strong magnetic fields and other sources of electronic noise. Also, protect the scanner from static electricity as this might cause the scanner to malfunction.
	Do not use aerosol sprays to clean the scanner. Aerosol sprays cause dirt and dust to enter the scanner, resulting in scanner failure and malfunction.
	Do not use the scanner immediately after moving it from a cold place to a warm room. This may cause condensation, which might lead to scanning errors. Let the device dry about one or two hours before you use it.
	When carrying the scanner outside while it is raining or snowing, pay close attention so the scanner does not get wet or moistured.



When handling the paper, be careful not to cut your fingers by the paper.

---

# Chapter 1 Preparation

This chapter describes necessary preparations before using the ScanSnap.



Do not connect the ScanSnap to your computer before installing "ScanSnap Manager."

If the ScanSnap is connected before installing ScanSnap Manager, it will not operate correctly.

For the installation of ScanSnap Manager, refer to page 15.

---

## 1.1 Checking the Contents of the Package

This manual describes how to install and connect the ScanSnap to your computer, and describes basic operations of the ScanSnap.

Refer to the following manuals when necessary.

Manual	See
ScanSnap S300M Getting Started (Cable Connection) (paper)	Plastic bag where the supplied cables are packed
ScanSnap S300M Operator's Guide (PDF)	<ul style="list-style-type: none"><li>• ScanSnap Setup CD-ROM</li><li>• After installation of ScanSnap Manager, with Finder, select [Applications] ⇨ [ScanSnap] ⇨ [En] ⇨ Manual.pdf</li></ul>

## 1.2 Names and Functions of Parts

When you unpack the ScanSnap package, make sure that all parts are included. Refer to the package contents list included in the ScanSnap package box.



To avoid danger of suffocation, keep the packaging materials away from small children's reach and prevent them from putting the materials in their mouths or putting them on their heads.

### ■ Front View

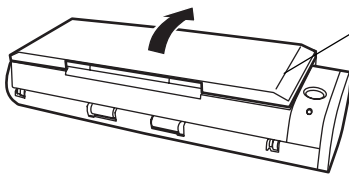

#### Paper chute

Open this cover when using the ScanSnap.

⇒ Opening the cover turns ON the ScanSnap.

#### Paper chute guide

Pull out this guide to support the documents when necessary.

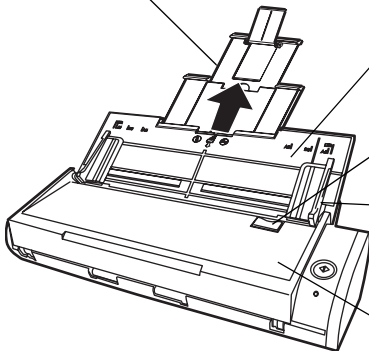

#### Paper chute

Open it and load the documents onto this part when scanning documents.

#### Cover open lever

Pull this lever to open the ADF cover.

#### Side guide

Adjust these guides to the documents width for preventing skewed loading.

#### ADF cover

(ADF: Automatic Document Feeder)

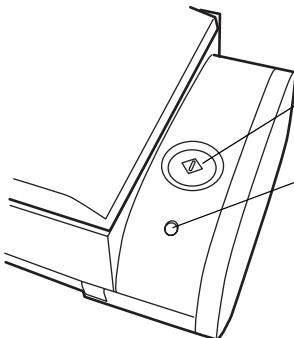

#### [SCAN] button

Starts scanning.

#### Power Indicator

Indicates the ScanSnap status of the power supply to the ScanSnap.

White (Solid): Ready

White (Blinking): Scanning/Standing by

Orange: Error

Light off: Power off

## ■ Rear View

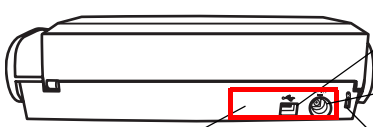

**USB connector**  
Connect a USB cable here.

**Power connector**  
Connect either the Power cable or  
USB bus power cable.

**Security cable slot**  
You can plug a commercially available  
security cable into this slot (anti-theft).

**Adhesive label**

Reminds you that the supplied software has to be installed first. After installing ScanSnap Manager onto your computer, remove this label to connect the ScanSnap to your computer.



---

For the Document Specification, refer to "**3.2 Paper Sizes of Documents to be Scanned**" in "**ScanSnap S300M Operator's Guide**" stored in the ScanSnap Setup CD-ROM.

---



---

The ScanSnap is turned on/off in conjunction with the connected computer, or with opening/closing of the paper chute. Ordinary, you can forget about turning on/off the ScanSnap.

---

# Chapter 2 Connecting the ScanSnap

This chapter describes how to connect the ScanSnap to your computer.

## 2.1 Installing the Supplied Software

Before connecting the ScanSnap to your computer, install the following software on your computer.

Software	Mac OS X v10.1	Mac OS X v10.2 (*1)	Mac OS X v10.3	Mac OS X v10.4	Mac OS X v10.5
ScanSnap Manager (Driver)	—	✓	✓	✓	✓
Cardiris	—	—	✓ (*2)	✓	✓

(✓: Supported, —: Not supported)

\*1) When the operating system you are using is Mac OS X v10.2.8.

\*2) When the operating system you are using is Mac OS X v10.3.9.



- We recommend applying the latest updates to the Mac OS for better reliability.
- Log on as a user with Administrator privileges.
- Requirements for the ScanSnap S300M are as follows:

CPU: - PowerPC® G4 Processor 800MHz or higher  
- Intel® Core™ Solo or Duo Processor  
(Intel® Core™ Duo Processor 1.83GHz or higher is recommended)

Memory: 128MB or more  
(512MB or more is recommended. When the OS is Mac OS X v10.5, 1GB or more is recommended.)

\* If the CPU and memory do not meet the recommended requirements or the USB version 1.1 is used, the scanning speed will slow down.

### ■ Installing Cardiris

Prepare the Cardiris CD-ROM.

1. Insert the "Cardiris™ Setup CD-ROM" into the CD-ROM drive.
2. Double-click the "Cardiris 3.6 for ScanSnap" on the desktop.
3. Double-click the "Cardiris 3.6 for ScanSnap" icon.  
⇒ A screen of Cardiris installation appears.



4. Scroll down and read License Agreement to the end. Then click the [Continue] button, and install Cardiris, by following instruction on the screen. By default, Cardiris is installed on the Applications Folder.
5. After installation, Mac OS X restarts, and the Cardiris icon appears on the Dock menu.
6. Check that Cardiris can be started by clicking the Cardiris icon.  
After confirming the application startup, exit Cardiris.



This operation is required for ScanSnap interaction with Cardiris.  
This operation must be performed before installing ScanSnap Manager.

## ■ Installing ScanSnap Manager

Prepare the ScanSnap Setup CD-ROM.

1. Insert the "ScanSnap Setup CD-ROM" into the CD-ROM drive.  
⇒ The "ScanSnap" window appears.
2. Double-click the ScanSnap Manager icon.

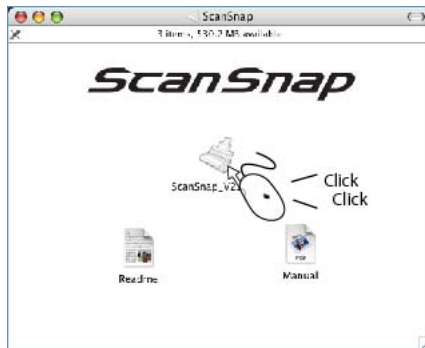

⇒ The "Welcome to ScanSnap Manager Installer" window appears.

3. Follow the instructions to install the software.  
ScanSnap Manager is installed on the Applications Folder.

4. After the installation is complete, eject the CD-ROM from the CD-ROM drive.

⇒ The ScanSnap Manager icon  appears on the Dock menu.

---





The status of the ScanSnap Manager icon will change from  to



after connecting the ScanSnap to your computer.

The displayed icon in the Dock menu varies depending on the cable connection you made.

- Power cable connection: 
- USB bus power cable connection: 

This guide uses examples for power cable connection.

---



For information about how to install ScanSnap Manager and Cardiris, refer to "**ScanSnap S300M Operator's Guide.**"

---

## 2.2 Connecting the ScanSnap

When the installation of the above programs is complete, connect the ScanSnap to your computer.



Install ScanSnap Manager, and then restart your computer, before connecting the ScanSnap to your computer.

### ■ Connecting the cable

Connect the ScanSnap to a power supply in either of two ways below:

Power source	Use the following cable:	See:
<p>Power outlet</p> <p>(When always operating the ScanSnap at the same regular place where it can be fed power from a power outlet)</p>	<p>Power cable</p> <p>The Power cable is a combination of the AC adapter and AC cable.</p>	<p>"When connecting with the Power cable:" (page 19)</p>
<p>Computer</p> <p>(When using the ScanSnap at a place where it reaches no power outlet, or when carrying the ScanSnap together with your laptop computer around and operating at a place where no power outlet is available)</p>	<p>USB bus power cable</p>	<p>"When connecting with the USB bus power cable:" (page 20)</p>

After connecting to a power source with the cable above, connect to your computer with a USB cable.

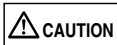

Use only the AC cable and AC adapter (power cable) below: Otherwise, a failure may be caused.

- Manufacturer: LEI
- Model No.: NU13-1072166-I3



- When using the USB bus power cable, your computer must have two USB ports; one for power feeding, the other for USB cable connection.
- When connecting with the USB bus power cable via a USB hub, use a powered hub equipped with an AC adapter.
- When the ScanSnap is connected with the USB bus power cable, the scanning speed becomes slow.  
Double-sided color documents of A4 or letter in size can be scanned at a speed of:  
Power-cable-connected: Approx. 8 sheets/minute  
USB-bus-power-cable-connected: Approx. 4 sheets/minute  
(when used with a computer with Intel® Core™ Duo 1.83 GHz and with Scan mode set to Normal, Color mode Auto, and Compression rate 3, and others set to defaults)

### •When connecting with the Power cable:

Use the power cable **1** and USB cable **2**.

1. Connect the Power cable.  
Remove the adhesive label covering the USB and power connectors. Connect to the ScanSnap's power connector and an outlet.
2. Connect the USB cable.  
Connect the USB cable to both the ScanSnap and your computer.

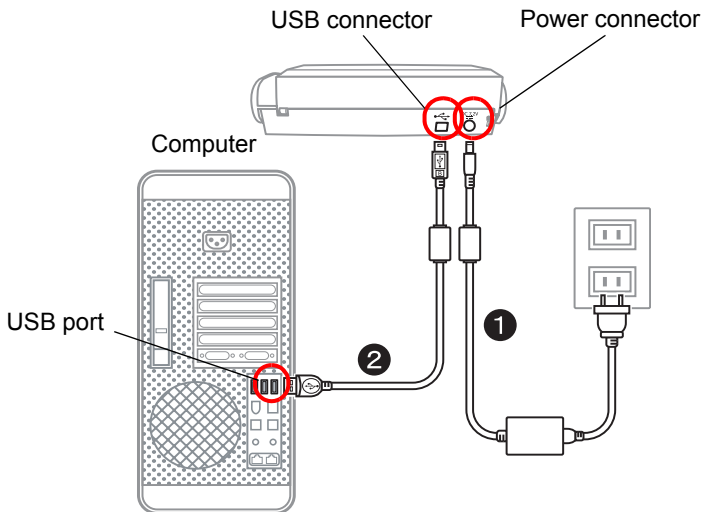

3. After power and USB ports are connected with cables, perform the procedure described in "Turning the ScanSnap ON" (page 21).



- Be sure to use the supplied AC adapter and AC cable.
- Be sure to use the supplied USB cable. The operation with any commercially available USB cable is not guaranteed.
- If only the USB cable is used, the ScanSnap does not operate. Be sure to use two types of cables, Power and USB cables, to connect the ScanSnap to your computer.
- When connecting to a USB hub, be sure to use the first stage USB hub that is closest to the computer. If you use the second or later hub stages, the ScanSnap may not operate properly.
- When connecting with a USB 2.0 cable, make sure that the USB port to connect to and hub must be USB 2.0-compliant. Note that if connected with a USB 1.1 cable, the scanning speed may become slow. When a USB 2.0-compliant port is available, it is recommended that the USB 2.0-compliant port be used.

### •When connecting with the USB bus power cable:

Use the USB bus power cable **1** and USB cable **2**.

1. Connect the USB bus power cable.  
Remove the adhesive label covering the USB and power connectors  
Connect to the ScanSnap's power connector and your computer.
2. Connect the USB cable.  
Connect the USB cable to both the ScanSnap and your computer.

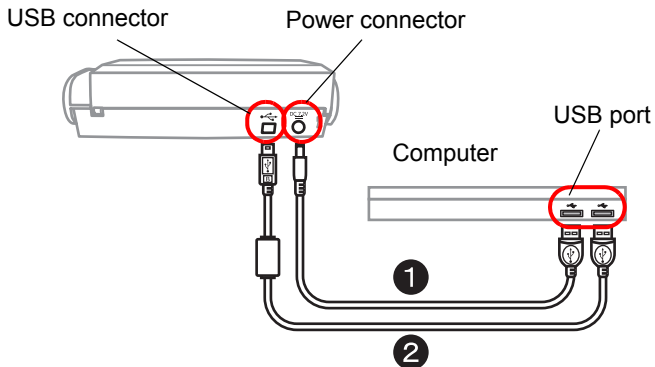

3. After power and USB ports are connected with cables, perform the procedure described in "Turning the ScanSnap ON" (page 21).



- Be sure to use the supplied USB bus power cable.
- Be sure to use the supplied USB cable.  
The operation with any commercially available USB cable is not guaranteed.
- If only the USB cable is used, the ScanSnap does not operate. Be sure to use two types of cables, the USB bus power and USB, to connect the ScanSnap to your computer.  
Or, use a powered hub equipped with an AC adapter, and connect both cables to the same hub.
- When connecting to a USB hub, be sure to use the first stage USB hub that is closest to the computer. If you use the second or later hub stages, the ScanSnap may not operate properly.
- When connecting with a USB 2.0 cable, make sure that the USB port to connect to and hub must be USB 2.0-compliant. Note that if connected with a USB 1.1 cable, the scanning speed may become slow. When a USB 2.0-compliant port is available, it is recommended that the USB 2.0-compliant port be used.

## ■ Turning the ScanSnap ON



The ScanSnap is turned on/off automatically, when you open/close the Paper chute.

It is also turned on/off in conjunction with the connected computer's power on/off status.

1. Open the Paper chute of the ScanSnap.

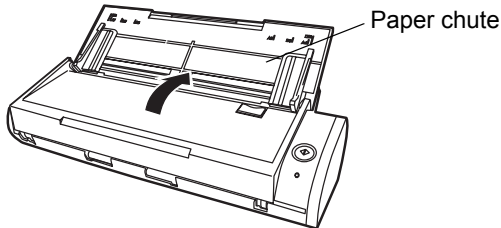

2. The ScanSnap is turned ON.  
⇒ The Power indicator starts blinking, and becomes solid. Then, the ScanSnap is recognized as new hardware by your computer.





Depending on the performance of the computer and the load on it, it may take time before the power LED gets illuminated. For example, it may take time if there are many programs running on the computer. In such case, wait until the power LED is steadily on.

### 3. The connection of the ScanSnap is complete.

---



The ScanSnap Manager icon in the Dock menu is displayed as .  
The displayed icon in the Dock menu varies depending on the cable connection you made.

- Power cable connection: 
- USB bus power cable connection: 

This guide uses examples for power cable connection.

---

# Chapter 3 How to Use the ScanSnap

This chapter describes basic operation of the ScanSnap.

## 3.1 Scanning Documents

With the ScanSnap, you can turn paper office documents on your desk into digital files, save them, attach them to e-mail, and print them just by pressing a single button. The scanned image can be viewed on the screen using the application (Preview).

Two typical usages are:

- Create digital backups of general office documents in PDF format.
- With the "Action List", attach the scanned documents to e-mail, print them out with a printer, and share them over the network.



### Action List

The ScanSnap has frequently-used functions at the ready in the Action List to help you make efficient use of your time at your office. Refer to "**Chapter 5 About Actions**" of "**ScanSnap S300M Operator's Guide**" in the ScanSnap Setup CD-ROM to learn more about the Action List.

## 3.2 About the Scanning Settings

You can change the ScanSnap settings by using ScanSnap Manager.



For details of scanning settings, refer to "**4.2 Changing Scanning Settings**" of "**ScanSnap S300M Operator's Guide**."

1. Click and hold the ScanSnap Manager icon  in the Dock menu. Select [Settings] from the ScanSnap Manager menu to change the settings for scanning with a single pressing of the [SCAN] button.  
⇒ The "ScanSnap Manager - Scan and Save Settings" window appears.

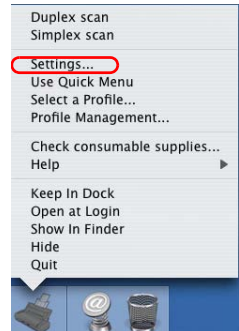



2. Change the scanning settings on the "ScanSnap Manager - Scan and Save Settings" window. You can update your last-saved settings for scanning when [Settings] is selected.

There are six tabs used to configure the scan options at maximum (The number of tabs displayed and items that can be configured vary depending on the operation mode.)

3. Click the [Apply] button to finish the configuration.  
⇒ The new settings are enabled.



### 3.3 Scanning Office Documents

This section describes how to scan the documents generally used in most offices. The ScanSnap can scan the documents in various sizes.



For details of how to scan documents, refer to "**Chapter 3 Using the ScanSnap**" of "**ScanSnap S300M Operator's Guide.**"

1. Pull up the Paper chute guide and open the extension in the order given, and load the documents onto the ScanSnap.  
Paper chute guide

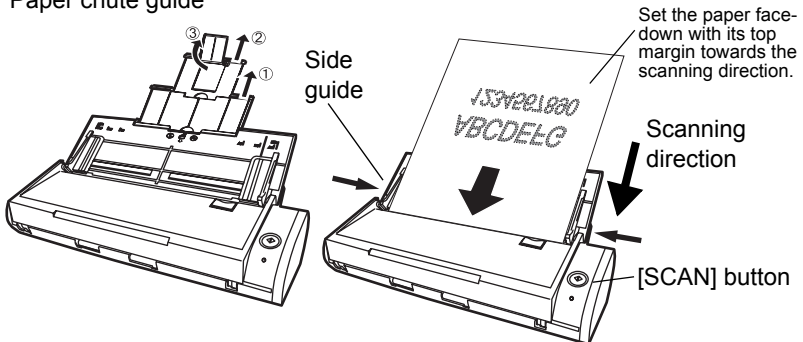

2. Adjust the side guides to the width of the loaded document.

3. Press the [SCAN] button.  
 ⇒ Scanning is started.  
 ⇒ The ScanSnap Quick Menu appears after scanning.
4. Select a desirable action in the ScanSnap Quick Menu for the image of the scanned document.

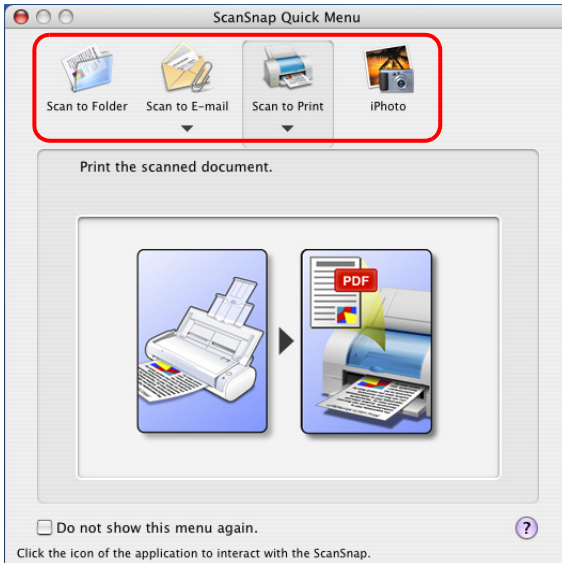

The scanning method above is for the case where the "Quick Menu Mode" is applied.

If you switch to the "Profile Mode," you will be able to perform the scanning operation with the specified application without the ScanSnap Quick Menu displayed. You can also switch to any settings for scanning if you register scanning configurations to the "Select a Profile" window in advance. When you become accustomed to the ScanSnap operation, switch the Operation Mode during operation when needed.

The Operation Mode can be switched by clicking and holding the ScanSnap Manager icon  on the Dock menu and then marking [Use Quick Menu].

The ScanSnap can scan documents using various settings.

Refer to the "**ScanSnap S300M Operator's Guide**" on the ScanSnap Setup CD-ROM to learn more.

### 3.4 Scanning Business Cards using Cardiris

1. Select "Cardiris" in the "Select a Profile" window which pops up when clicking the ScanSnap Manager icon  .

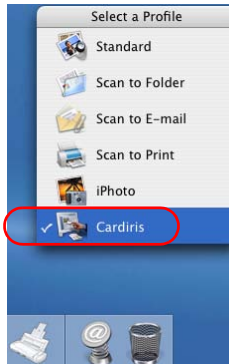

In Quick Menu Mode, ScanSnap cannot interact with Cardiris.

2. Load the document onto the ScanSnap and press the [SCAN] button.
  - Load the business cards face down.
  - When scanning more than one business card, set them together.
  - Adjust the side guides so that they are touching the edges of the business card. When moving the side guides, hold the tag of the side guide.

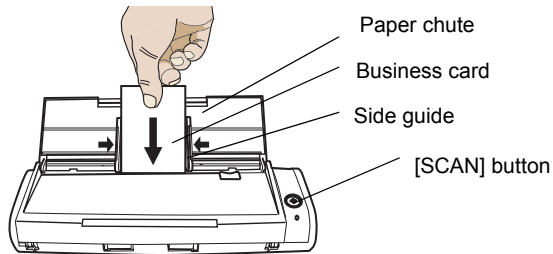

- Do not connect or disconnect other USB devices during the scanning operation.
- Do not close the paper chute on the ScanSnap during the scanning operation.
- Do not switch the user to log in during the scanning operation.

⇒ Scanning is started.

⇒ When scanning is complete, Cardiris window appears.

3. Check the image data of the scanned business cards in the Cardiris window.

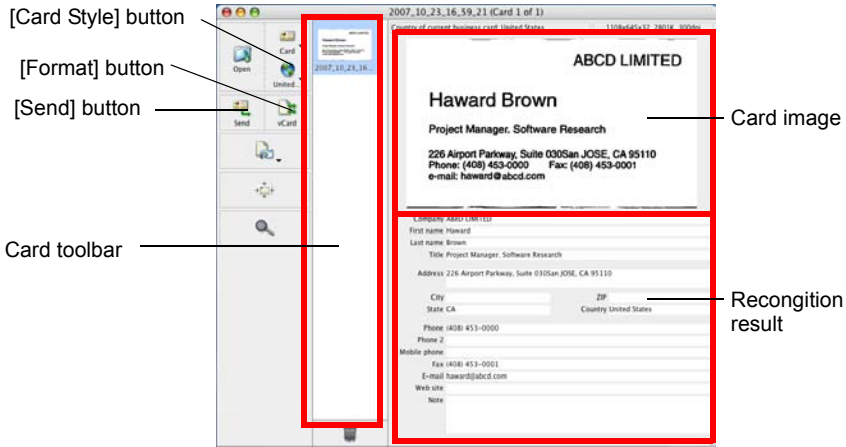

The images of each business card are displayed on the right.  
 A list of already scanned business cards is displayed on the left.  
 Under the image, the recognized characters are displayed.



To scan business card of a different language from the one set with the [Card Style] button, change the language setting in the Cardiris window before scanning.

4. Should there be any recognition errors, correct the data manually.  
 Correct misrecognized characters.

To register the recognized characters of a scanned business cards in the Address Book, perform the following procedure.

5. Click the [Format] button or select [Settings] - [Output Format] on the menu bar.  
 ⇒ The following window appears.



6. On the "Format:" pop-up menu, select "Address Book."

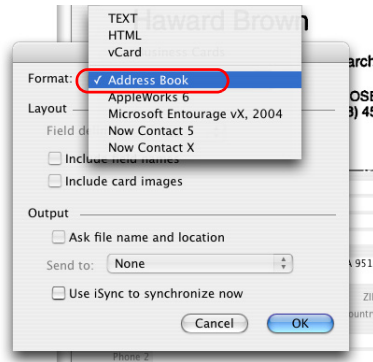

7. Click the [OK] button.
8. Click the [Send] button or select [Process] - [Send] on the menu bar.  
⇒ The Address Book window appears, and the recognized characters of all scanned business cards in the card toolbar are registered in Address Book.

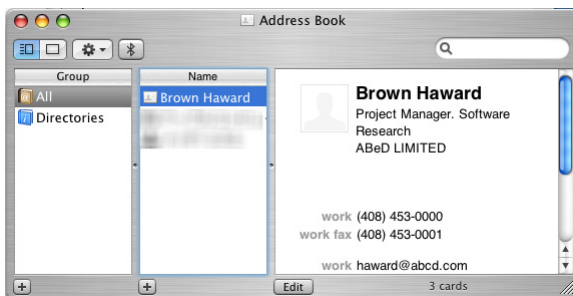

9. On the menu bar, select [Cardiris] - [Quit Cardiris] to quit Cardiris.



- The recognition result of scanned business cards can be output as text or vCard format.
- For more details, refer to the User's Manual in the Cardiris application installation folder or Cardiris Help.

## Chapter 4 Troubleshooting

This chapter describes common problems during the usage of the ScanSnap and how to remedy them.

### 4.1 Troubleshooting Checklist

Before you ask for repair service, please check the following items.



If you cannot solve the problem even after checking the following items, contact the store where you purchased the ScanSnap, or contact an authorized FUJITSU scanner service provider.



For troubleshooting errors caused during operation, refer to "**7.2 Troubleshooting Checklist**" of "**ScanSnap S300M Operator's Guide.**"

\* Visit our Web site for your reference. Other useful information will be posted on the FAQ corner at the following Web site:  
<http://scansnap.fujitsu.com/>

Symptom	Check This Item	Remedy
The ScanSnap cannot be turned on.	Is the AC/USB cable and the AC adapter connected correctly?	Correctly connect the power or USB cable and USB bus power cable to the computer. When using a hub, check the hub's power supply. When using a USB bus power cable, use a powered USB hub equipped with an AC adapter. If you connect to a non-powered hub, the ScanSnap may not work properly.  Disconnect and then re-connect the power or USB bus power cable. (Note: Wait at least five seconds before reconnecting the Power/USB bus power cable)
	Is the paper chute closed? (The ScanSnap is automatically powered on/off when the paper chute is opened/closed.)	Open the paper chute cover.
	Is the Mac OS started completely? (This ScanSnap is powered on/off in conjunction with the computer.)	Wait until Mac OS X has started up completely. The  LED stays out while Mac OS X is starting up or in the sleep mode.

Symptom	Check This Item	Remedy
Scanning does not start.	Is ScanSnap Manager for the ScanSnap S300M installed in your computer?	Install ScanSnap Manager for the ScanSnap S300M. (See "Installing the Supplied Software" (page 15).)
	Is the USB cable correctly connected?	Connect the USB cable correctly. When using a hub, check the hub's power supply. When using a USB bus power cable, use a powered USB hub equipped with an AC adapter. If you connect to a non-powered hub, the ScanSnap may not work properly.
Scanning does not start.	Is the  LED light blinking?	Disconnect and then re-connect the AC cable and AC adapter. (Wait at least five seconds before reconnecting the AC or USB cable.)
	Did you resume the computer from the hibernation state?	When you perform scanning after resuming the computer from the hibernation state, move the mouse or press any key before scanning.
	Is ScanSnap Manager surely started? (If ScanSnap Manager is active, the ScanSnap Manager icon  appears in the Dock menu.)	If the ScanSnap Manager icon is not displayed, with Finder, select the destination folder where the ScanSnap is installed (generally, you can find "ScanSnap" in "Applications"), and then select "ScanSnap Manager" to start up "ScanSnap Manager."
	Is ScanSnap Manager running normally? (If ScanSnap Manager is not running normally, the ScanSnap Manager icon in the Dock menu is in the not-ready state  .) Depending on the features of the computer, the ScanSnap may not be recognized shortly after the power is turned on back if the computer goes into the sleep mode before turning off the power.	Perform the following: 1. Disconnect and re-connect the AC cable and AC adapter. If doing so does not improve the situation, perform Step 2. 2. If a USB hub is being used, directly connect the ScanSnap to your computer. If this does not improve the situation, perform Step 3. 3. Restart your computer. If none of the above operations resolves the problem, uninstall and re-install ScanSnap Manager. For how to uninstall ScanSnap Manager, refer to " <b>Appendix A Uninstalling ScanSnap</b> " in " <b>ScanSnap S300M Operator's Guide</b> ."

Symptom	Check This Item	Remedy
<p>The ScanSnap is not recognized, though ScanSnap Manager is installed.</p>	<p>Did you connect the ScanSnap to your computer before installing ScanSnap Manager? Have the "ScanSnap Manager" started?</p>	<p>If your operating system is Mac OS X v10.2, in the "System Preferences" window, select "Login Items" - "Add" to add "ScanSnap Manager." If your operating system is Mac OS X v10.3, v10.4, or V10.5, in the "System Preferences" window, select "Accounts" - "My Account" - "Login Items (for Mac OS X v10.4 or v10.5)" or "Startup Items (for Mac OS X v10.3)," and then select "+" to add "ScanSnap Manager."</p>



## 4.2 Clearing Paper Jams

1. Remove the document on the paper chute.
2. Open the ADF while pulling the Cover open lever.
3. Remove the jammed document.
4. Close the ADF.  
⇒ You should hear the ADF click when it returns to its original position.

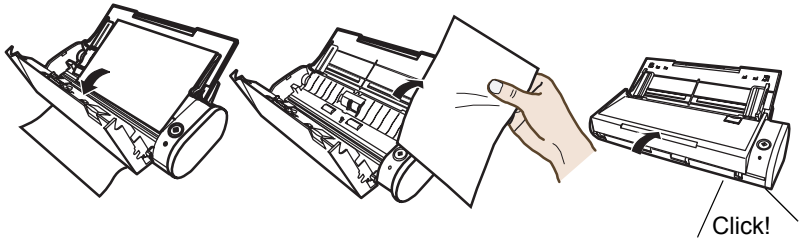

# Chapter 5 Daily Care

This chapter describes how to clean the ScanSnap.



- Before you clean the ScanSnap, unplug the power cable from the power outlet, or the USB bus power cable from the computer to prevent from fire or electric shock.
- To avoid injuries, do not place the internal parts (such as the Pad ASSY and pick roller) in areas where small children can reach.

## 5.1 Cleaning Materials

Cleaning Materials	Parts No.	Remarks
Cleaner F1	PA03950-0352	1 bottle (100 ml) (*1)
Cleaning wipe	PA03950-0419	1 pack (24 sheets) (*2)

\*1) It may take long before the cleaner vaporizes if a large quantity is used. When cleaning the ScanSnap parts, dampen a cloth with modest quantities of the cleaner. In addition, wipe off the cleaner completely with a soft lint-free cloth to leave no residue on the surface of the cleaned parts.

\*2) Pre-moistened with Cleaner F1, Cleaning Wipes are used instead of moistened cloths.

To purchase the cleaning material, contact the store where you purchased the ScanSnap or an authorized FUJITSU scanner service provider.

## 5.2 Cleaning the ScanSnap Exterior

Clean the ScanSnap exterior with a cloth moistened with a small amount of neutral detergent or Cleaner F1 (sold separately).



- Never use paint thinner or other organic solvents.
- During the cleaning, prevent water or moisture from getting inside the ScanSnap.
- Do not use aerosol sprays to clean the ScanSnap. Aerosol sprays cause dirt and dust to enter the ScanSnap, resulting in the ScanSnap failure or malfunction, or errors in scanned images.

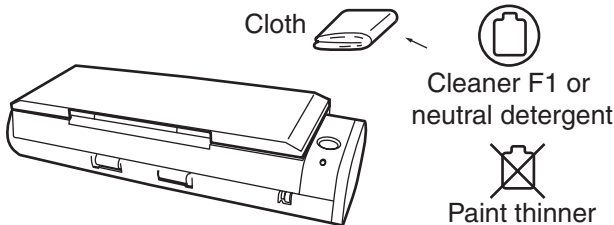

## 5.3 Cleaning Inside of the ScanSnap

Clean inside of the ScanSnap with a cloth moistened with Cleaner F1.

In an alternating succession of scanning documents, the accumulated paper-powder and dust inside the ScanSnap causes a scanning error.

As a guideline, clean the ADF every 200 sheets of documents. Note that this guideline varies according to the type of documents you are scanning. For example, the ADF must be cleaned more frequently when scanning documents on that the toner has not been sufficiently fixed on.

Clean the ADF according to the following procedure referring to the illustrations.



- Never use water or neutral detergent to clean the inside of the ScanSnap.
- Do not use aerosol sprays to clean the ScanSnap. Aerosol sprays cause dirt and dust to enter the ScanSnap, resulting in the ScanSnap failure, malfunction and image error.

1. Open the ADF while pulling the Cover open lever.

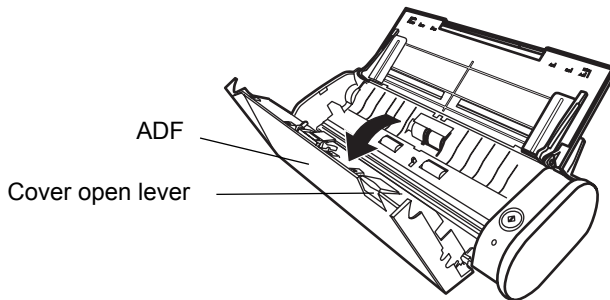

2. Clean the following locations with a cloth moistened with Cleaner F1.

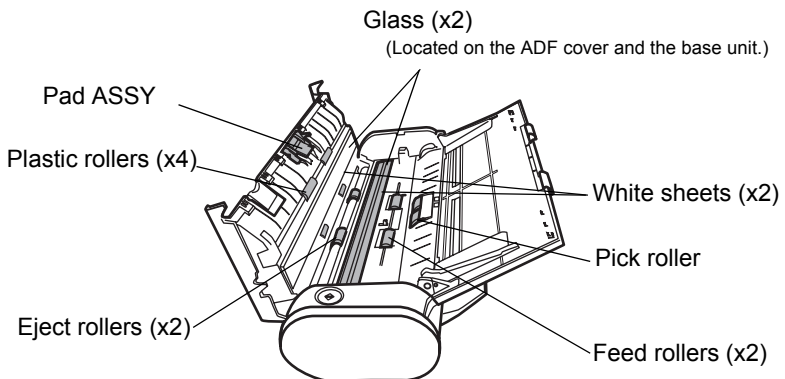

For more details, refer to "**Chapter 8 Daily Care**" in the "**ScanSnap S300M Operator's Guide.**"

## Chapter 6 Consumables

This chapter describes how to replace and purchase consumables and regular replacement parts.



- Before you replace the consumables of the ScanSnap, unplug the power cable from the power outlet, or the USB bus power cable from the computer to prevent from fire or electric shock.
- To avoid injuries, do not place the internal parts (such as the Pad ASSY and pick roller) in areas where small children can reach.

The following table lists the part numbers of consumables and shows rough guidelines for replacing these parts.

No	Description	P/N	Replacement Cycle
1	Pad ASSY	PA03541-0002	10,000 sheets or one year
2	Pick roller	PA03541-0001	100,000 sheets or one year

These replacement cycles are rough guidelines when A4/Letter wood-free paper 64 g/m<sup>2</sup> (17 lb) is used. The actual cycle may differ depending on the scanned paper.

Use only the consumables specified by PFU LIMITED.



Use the following procedure to check the target values for replacement and usage information of consumables.

1. Click and hold the ScanSnap Manager icon in the Dock menu.
  2. Click [Check consumable supplies] on the menu.
- ⇒ The "ScanSnap Manager - Check consumable status" window appears. This window indicates how many times consumables have been used.

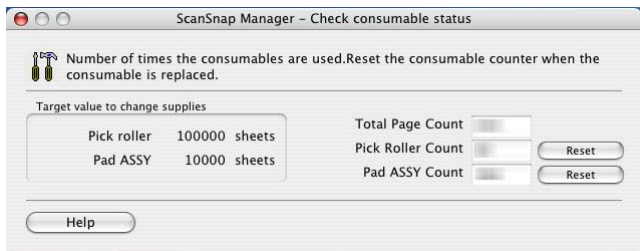
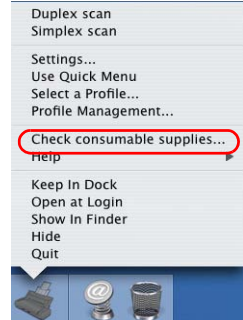

Replace consumables using "Target value to change supplies" as guidelines. For details about purchasing consumables, visit the website below or contact the FUJITSU scanner dealer where you purchased your ScanSnap. [Website] <http://scansnap.fujitsu.com/>



For information on how to replace the Pad ASSY and the pick roller, refer to **"9.2 Replacing the Pad ASSY"** and **"9.3 Replacing the Pick Roller"** respectively in the **"ScanSnap S300M Operator's Guide."**

---

The contents of this manual are subject to change without notice. This manual may not be reproduced, adapted or translated without prior written permission. READ THIS ENTIRE MANUAL CAREFULLY BEFORE USING THIS PRODUCT. IF THIS PRODUCT IS NOT USED CORRECTLY, UNEXPECTED INJURY MAY BE CAUSED TO USERS OR BYSTANDERS. While all efforts have been made to ensure the accuracy of all information in this manual, PFU LIMITED assumes no liability to any party for any damage caused by errors or omissions or by statements of any kind in this manual, its updates or supplements, whether such errors are omissions or statements resulting from negligence, accidents, or any other cause. PFU LIMITED further assumes no liability arising from the application or use of any product or system described herein; nor any liability for incidental or consequential damages arising from the use of this manual. PFU LIMITED disclaims all warranties regarding the information contained herein, whether expressed, implied, or statutory. PFU LIMITED assumes no liability for incidental or consequential damages arising from the use of this product, and any claims by a third party. Copying of the contents of this manual in whole or in part and copying of the scanner applications are prohibited under the copyright law.