

***ScanSnap***  
***S1300i***

# **Basic Operation Guide**

## **(Windows)**

# Contents

About This Manual .....	4
Safety Information.....	5
Manuals .....	6
Trademarks.....	9
Manufacturer.....	10
Symbols Used in This Manual.....	11
Arrow Symbols in This Manual.....	12
Screen Examples in This Manual .....	13
Abbreviations Used in This Manual .....	14
What You Can Do with the ScanSnap .....	16
Scanning a Document.....	17
Scanning a Long Page.....	22
Scanning Documents of Different Widths or Lengths in One Batch.....	26
ScanSnap Overview.....	31
Parts and Functions .....	32
System Requirements .....	34
Overview of the Software Related to the ScanSnap.....	36
How to Install the Software.....	37
ScanSnap Manager Icon.....	38
Right-Click Menu .....	39
ScanSnap Setup Window .....	41
Turning the ScanSnap On or Off.....	42
Turning the ScanSnap On.....	43
Turning the ScanSnap Off.....	45
Sleep Mode.....	46
Automatic Power OFF .....	47
Documents to Scan.....	48
What You Can Do with Related Software .....	50
What You Can Do with the ScanSnap Organizer.....	51
Basic Operation Procedure of ScanSnap Organizer .....	52
Managing Files.....	54
Using Files.....	56
What You Can Do with CardMinder.....	57
Basic Operation Procedure of CardMinder .....	59
Linking Card Data with Other Applications.....	62
Searching Card Data with the Basic Search Toolbar.....	63
Searching Card Data with CardMinder Viewer .....	64
Attaching a File to Card Data.....	65
Useful Usages.....	66
Managing Paper Documents by Folder on a Computer .....	67
Saving Business Cards to a Computer.....	70
Troubleshooting .....	72

How to Find Your Solution.....	73
If Your First Attempt to Install Failed .....	74
If You Have Installed the Software Before .....	75
Uninstalling the Software .....	76
Removing the Installation Information .....	77
Installing the Software from the [ScanSnap Setup] Window .....	81
Installing One Software at a Time.....	82
When the ScanSnap Manager Icon Does Not Appear .....	83
Displaying the ScanSnap Manager Icon.....	84
When ScanSnap Manager Does Not Operate Normally .....	85
Removing Unnecessary Icons from the Notification Area.....	86
Checking the Connection between the ScanSnap and the Computer .....	87
Checking If ScanSnap Manager Is Operating Normally .....	88
Removing the ScanSnap's Connection Information .....	91
When You Cannot Uninstall the Software.....	93
<b>Cleaning .....</b>	<b>94</b>
Cleaning Materials .....	95
Cleaning the Outside of the ScanSnap .....	96
Cleaning the Inside of the ScanSnap.....	97
<b>Consumables .....</b>	<b>101</b>
Part Numbers and Replacement Cycle of Consumables.....	102
Checking the Status of Consumables .....	103
Replacing Consumables .....	104
Replacing the Pad Assy.....	105
Replacing the Pick Roller Assembly .....	108
<b>Appendix .....</b>	<b>113</b>
Updating the Software .....	114
Uninstalling the Software .....	115
Specifications of the ScanSnap.....	117
<b>About Customer Support and Maintenance.....</b>	<b>119</b>

# About This Manual

- "Safety Information" (page 5)
- "Manuals" (page 6)
- "Trademarks" (page 9)
- "Manufacturer" (page 10)
- "Symbols Used in This Manual" (page 11)
- "Arrow Symbols in This Manual" (page 12)
- "Screen Examples in This Manual" (page 13)
- "Abbreviations Used in This Manual" (page 14)

# Safety Information

The attached "Safety Precautions" manual contains important information about the safe and correct use of the ScanSnap. Make sure that you read and understand it before using the ScanSnap.

# Manuals

Read the following manuals according to your needs when using the ScanSnap.



## Before Using the ScanSnap

Manual	Description and Location
Safety Precautions	<p>This manual contains important information about the safe use of the ScanSnap. Make sure you read this manual before using the ScanSnap.</p> <p>This manual is included in the package.</p> <p>In addition, after installing the software you can refer to this manual in the following procedure:</p> <ul style="list-style-type: none"> <li>● Windows 10 Select [Start] menu → [All apps] → [ScanSnap Manuals] → [S1300i Safety Precautions].</li> <li>● Windows 8.1 Click  on the lower left side of the Start screen, and select [S1300i Safety Precautions] under [ScanSnap Manuals] on the All apps screen.</li> <li>● Windows 8 Right-click the Start screen, and select [All apps] on the app bar → [ScanSnap Manuals] → [S1300i Safety Precautions].</li> <li>● Windows 7/Windows Vista/Windows XP Select [Start] menu → [All Programs] → [ScanSnap Manuals] → [S1300i Safety Precautions].</li> </ul>



## When Setting Up the ScanSnap

Manual	Description and Location
ScanSnap S1300i Getting Started	<p>This manual explains the setup procedure from the moment you open the package to testing the operations.</p> <p>Getting Started is included in the package.</p> <p>In addition, after installing the software you can refer to this manual in the following procedure:</p> <ul style="list-style-type: none"> <li>● Windows 10 Select [Start] menu → [All apps] → [ScanSnap Manuals] → [S1300i Getting Started].</li> <li>● Windows 8.1 Click  on the lower left side of the Start screen, and select [S1300i Getting Started] under [ScanSnap Manuals] on the All apps screen.</li> <li>● Windows 8 Right-click the Start screen, and select [All apps] on the app bar → [ScanSnap Manuals] → [S1300i Getting Started].</li> <li>● Windows 7/Windows Vista/Windows XP Select [Start] menu → [All Programs] → [ScanSnap Manuals] → [S1300i Getting Started].</li> </ul>

## When Operating the ScanSnap

Manual	Description and Location
ScanSnap S1300i Basic Operation Guide (this manual)	This manual explains the basic operations and cleaning procedure for the ScanSnap.
ScanSnap Advanced Operation Guide	This manual describes operations including various scanning methods and useful usages of the ScanSnap. You can refer to this manual at the following website. <a href="http://www.pfu.fujitsu.com/imaging/downloads/manual/advanced/v62/en/common/index.html">http://www.pfu.fujitsu.com/imaging/downloads/manual/advanced/v62/en/common/index.html</a>
ScanSnap Manager Help	This Help file describes the windows, operational troubles and the solutions, as well as messages of the ScanSnap Manager. This manual can be accessed by one of the following methods: <ul style="list-style-type: none"> <li>● Right-click the ScanSnap Manager icon  in the notification area located at the far right of the taskbar, and select [Help] → [Help] from the "Right-Click Menu" (page 39).</li> <li>● Click the Help button () for ScanSnap Manager.</li> <li>● Press the [F1] key on the keyboard while a window is displayed.</li> <li>● Click the [Help] button in any window.</li> </ul>

## When Saving Scanned Images to a Mobile Device



Manual	Description and Location
ScanSnap Basic Operation Guide (Mobile Connection for iOS)	This manual describes operations to be performed on an iOS-based mobile device when you save scanned images to the mobile device. This manual can be accessed by the following method: <ol style="list-style-type: none"> <li>1. Start up ScanSnap Connect Application on the mobile device. ⇒ The [File List] screen appears.</li> <li>2. Tap the  button. ⇒ The [Information] screen appears.</li> <li>3. Tap the [Help] button.</li> </ol>
ScanSnap Basic Operation Guide (Mobile Connection for Android)	This manual describes operations to be performed on an Android-based mobile device when you save scanned images to the mobile device. This manual can be accessed by the following method: <ol style="list-style-type: none"> <li>1. Start up ScanSnap Connect Application on the mobile device. ⇒ The [File List] screen appears.</li> <li>2. Tap .</li> <li>⇒ The menu appears.</li> <li>3. Tap [Help].</li> </ol>

Manual	Description and Location
Scan to Mobile Help	<p>This Help file describes the operations, windows, and messages of Scan to Mobile. This Help file can be accessed by one of the following methods:</p> <ul style="list-style-type: none"> <li>● The [Scan to Mobile] icon is displayed in the menu that appears when you click  in the notification area located at the far right of the taskbar. Right-click the [Scan to Mobile] icon, and select [Help] from the menu that appears.</li> <li>● Press the [F1] key on the keyboard while a window is displayed.</li> <li>● Click the [Help] button in any window.</li> </ul>

## When Updating the Software

Manual	Description and Location
ScanSnap Online Update Help	<p>This Help file describes the operations, windows, and messages of ScanSnap Online Update. This Help file can be accessed by one of the following methods:</p> <ul style="list-style-type: none"> <li>● Press the [F1] key on the keyboard while a window is displayed.</li> <li>● Click the Help button in any window.</li> </ul>

## When Using Related Applications

Manual	Description and Location
ScanSnap Organizer Help	<p>This Help file describes the operations, windows, and messages of ScanSnap Organizer. This Help file can be accessed by one of the following methods:</p> <ul style="list-style-type: none"> <li>● Click the Help button (  ) for ScanSnap Organizer.</li> <li>● Press the [F1] key on the keyboard while a window is displayed.</li> <li>● Click the [Help] button in any window.</li> </ul>
CardMinder Help	<p>This Help file describes the operations, windows, and messages of CardMinder. This Help file can be accessed by one of the following methods:</p> <ul style="list-style-type: none"> <li>● Click the Help button (  ) next to the Basic Search Toolbar.</li> <li>● Press the [F1] key on the keyboard while a window is displayed.</li> <li>● Click the [Help] button in any window.</li> </ul>
ABBYY FineReader for ScanSnap User's Guide	<p>This manual describes the overview and operations of ABBYY FineReader for ScanSnap. This Help file can be accessed by one of the following methods:</p> <ul style="list-style-type: none"> <li>● Press the [F1] key on the keyboard while a window is displayed.</li> <li>● Click the [Help] button in any window.</li> </ul>



---

# Trademarks

Microsoft, Windows, Windows Vista, Excel, PowerPoint, Outlook, SharePoint, Windows Live, Internet Explorer, and OneDrive are either registered trademarks or trademarks of Microsoft Corporation in the United States and/or other countries.

Word is the product of Microsoft Corporation in the United States.

Adobe, Acrobat, and Reader are either registered trademarks or trade names of Adobe Systems Incorporated in the United States and/or other countries.

Intel and Intel Core are registered trademarks or trademarks of Intel Corporation in the United States and other countries.

ABBYY™ FineReader™ Engine © ABBYY. OCR by ABBYY

ABBYY and FineReader are trademarks of ABBYY Software, Ltd. which may be registered in some jurisdictions.

Evernote is a registered trademark or trademark of Evernote Corporation.

Google, Android, Google Play, and Google Drive are registered trademarks or trademarks of Google Inc. Use of these registered trademarks or trademarks is subject to Google Permissions.

Salesforce, the Salesforce logo, and Salesforce CRM are registered trademarks or trademarks of salesforce.com, inc. in the United States and other countries.

Wi-Fi, Wi-Fi Protected Setup, and the Wi-Fi Protected Setup logo are trademarks of Wi-Fi Alliance.

ScanSnap, the ScanSnap logo, ScanSnap Manager, ScanSnap Organizer, CardMinder, and Rack2-Filer are registered trademarks or trademarks of PFU LIMITED in Japan.

Other company names and product names are the registered trademarks or trademarks of the respective companies.

## Manufacturer



PFU LIMITED

YOKOHAMA i-MARK PLACE, 4-4-5 Minatomirai, Nishi-ku, Yokohama, Kanagawa, 220-8567, Japan

© PFU LIMITED 2014-2015

## Symbols Used in This Manual

The following indications are used in this manual to obviate any chance of accident or damage to you and people near you, and your property. Warning labels indicate the warning level and statements. The symbols indicating warning levels and their meanings are as follows.

Indication	Description
	This indication alerts operators of an operation that, if not strictly observed, may result in severe injury or death.
	This indication alerts operators of an operation that, if not strictly observed, may result in safety hazards to personnel or damage to the product.

## Arrow Symbols in This Manual

Right-arrow symbols (→) are used to connect icons or menu options you should select in succession.

Example: Select [Start] menu → [Computer].



## Screen Examples in This Manual



Microsoft product screenshots are reprinted with permission from Microsoft Corporation.

The screenshots used in this manual are of Windows 7.

The actual windows and operations may differ depending on the operating system.

### Icon in the Notification Area

The ScanSnap Manager icon  is displayed in the menu which appears when you click  in the notification area.

To have the ScanSnap Manager icon  always displayed in the notification area, drag the icon  and drop it onto the notification area.

The notification area is located at the far right of the taskbar.

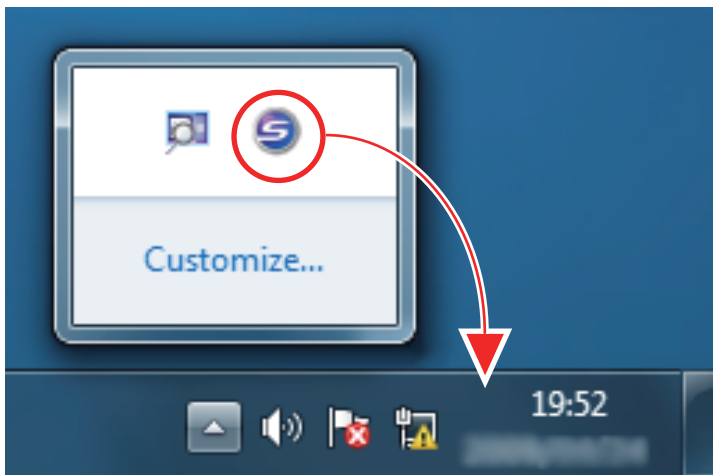

The explanations in this manual use the case in which the ScanSnap Manager icon  is always displayed in the notification area.

## Abbreviations Used in This Manual

Also, the following abbreviations are used in this manual.

Abbreviation Used	Designation
Windows 10	Windows® 10 Home operating system, English Version Windows® 10 Pro operating system, English Version Windows® 10 Enterprise operating system, English Version Windows® 10 Education operating system, English Version
Windows 8.1	Windows® 8.1 operating system, English Version Windows® 8.1 Pro operating system, English Version Windows® 8.1 Enterprise operating system, English Version
Windows 8	Windows® 8 operating system, English Version Windows® 8 Pro operating system, English Version Windows® 8 Enterprise operating system, English Version
Windows 7	Windows® 7 Starter operating system, English Version Windows® 7 Home Premium operating system, English Version Windows® 7 Professional operating system, English Version Windows® 7 Enterprise operating system, English Version Windows® 7 Ultimate operating system, English Version
Windows Vista	Windows Vista® Home Basic operating system, English Version Windows Vista® Home Premium operating system, English Version Windows Vista® Business operating system, English Version Windows Vista® Enterprise operating system, English Version Windows Vista® Ultimate operating system, English Version
Windows XP	Windows® XP Home Edition operating system, English Version Windows® XP Professional operating system, English Version
Windows	Windows 10, Windows 8.1, Windows 8, Windows 7, Windows Vista, or Windows XP operating system
Microsoft Office	Microsoft® Office
Word	Microsoft® Word 2013 Microsoft® Word 2010 Microsoft® Office Word 2007 Microsoft® Office Word 2003
Excel	Microsoft® Excel® 2013 Microsoft® Excel® 2010 Microsoft® Office Excel® 2007 Microsoft® Office Excel® 2003
PowerPoint	Microsoft® PowerPoint® 2013 Microsoft® PowerPoint® 2010 Microsoft® Office PowerPoint® 2007 Microsoft® Office PowerPoint® 2003

Abbreviation Used	Designation
SharePoint	Microsoft® SharePoint® Server 2010, English Version Microsoft® Office SharePoint® Server 2007, English Version Microsoft® Office SharePoint® Portal Server 2003, English Version Microsoft® SharePoint® Foundation 2010, English Version Microsoft® Windows® SharePoint® Services 2.0/3.0, English Version
Internet Explorer	Windows® Internet Explorer® Microsoft® Internet Explorer®
Microsoft Edge	Microsoft® Edge
.NET Framework	Microsoft® .NET Framework
ABBYY FineReader for ScanSnap	ABBYY FineReader for ScanSnap™ All the descriptions in this manual assume the usage of ABBYY FineReader for ScanSnap bundled with the ScanSnap. Unless otherwise specified, the term ABBYY FineReader for ScanSnap refers to the ABBYY FineReader for ScanSnap bundled with the ScanSnap. Note that ABBYY FineReader for ScanSnap may be upgraded without notice. If the descriptions in this manual differ from the actual displayed screens, refer to the ABBYY FineReader for ScanSnap User's Guide.
Google Drive	Google Drive™
Android	Android™
ScanSnap	Color Image Scanner ScanSnap S1300i

# What You Can Do with the ScanSnap

## Scanning Multiple Documents

A document stack with a thickness of 1 mm (0.04 in.) or less (for A4 or smaller sizes: up to 10 sheets with 80 g/m<sup>2</sup> [20 lb] paper weight) can be loaded into the ScanSnap for scanning.

For details, refer to "Scanning a Document" (page 17).

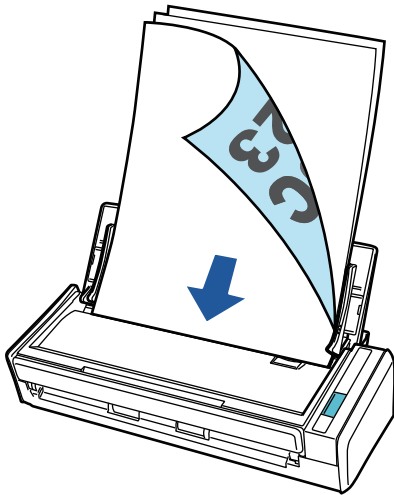

## Using the USB Bus-Powered Drive that Does Not Require Any Power Supply

You can use the ScanSnap in an environment where no power supply is available, such as outside or on a business trip, by connecting the ScanSnap to a USB port on a computer.

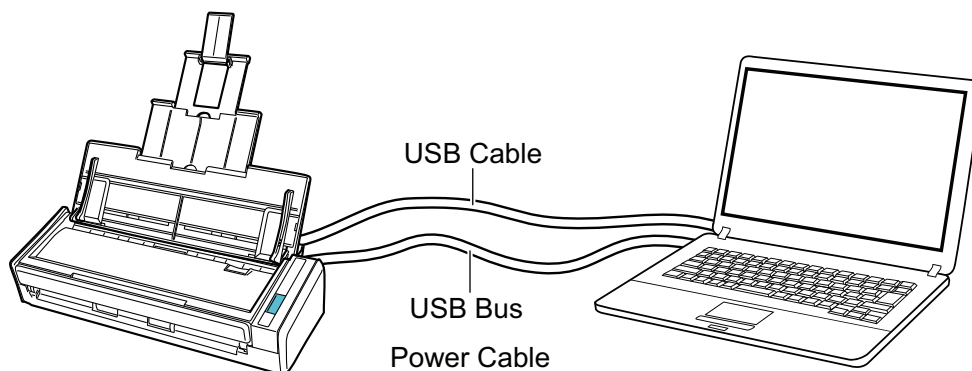



# Scanning a Document

You can scan documents such as handouts for meetings or business cards.

For details about documents that can be scanned, refer to ["Documents to Scan"](#) (page 48).

## 1. If you are loading multiple sheets, check the number of sheets.

The maximum number of sheets in the ScanSnap is as follows:

For A4 or smaller sizes: Up to 10 sheets can be loaded (with paper weight of 80 g/m<sup>2</sup> [20 lb] and thickness of the document stack under 1 mm [0.04 in.]).

### ATTENTION

If you try to scan more than the maximum amount that can be loaded, the following problems may occur:

- Files cannot be properly created due to excessive file size.
- Paper jams occur during scanning.

## 2. Fan the documents.

1. Hold both ends of the documents and fan them a few times.

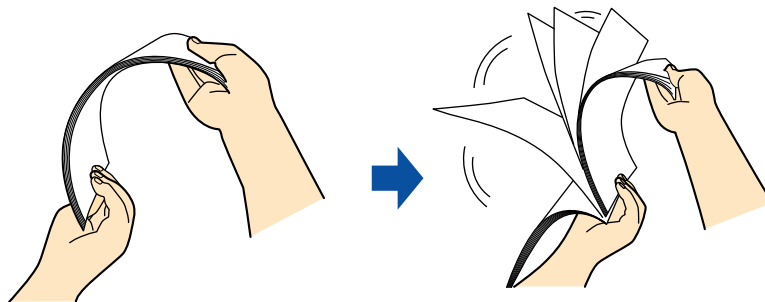

2. Rotate the documents 90 degrees and fan them in the same manner.

## 3. Straighten the edges of the documents and slightly displace the top edges at an angle.

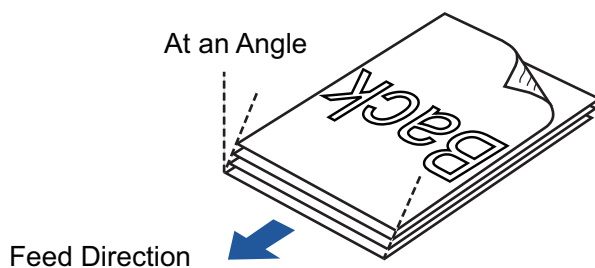



### ATTENTION

Paper jams or damage to documents may occur if you scan the documents without aligning the edges first.

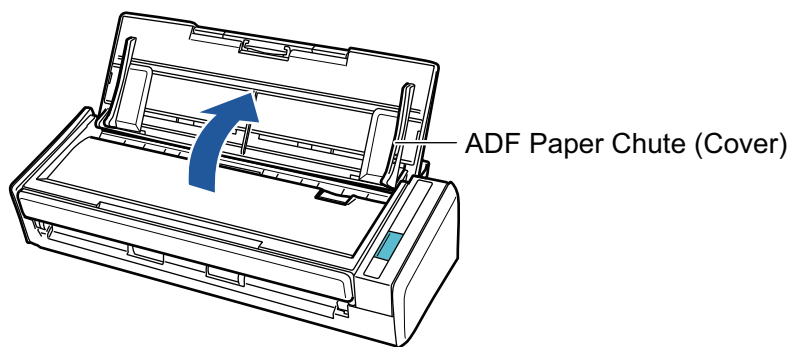
## 4. Open the ADF paper chute (cover) of the ScanSnap.



⇒ The [Scan] button flashes in blue. The button returns to being lit normally when document scanning is enabled.

In addition, the ScanSnap Manager icon in the notification area located at the far right of the taskbar changes from  to .

**5.** Pull out the extension.

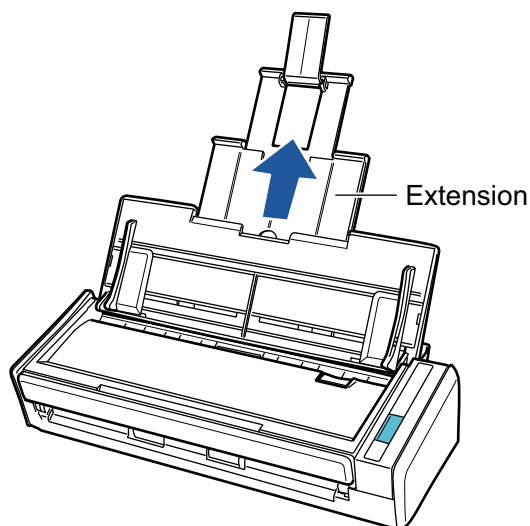

**6.** Load the documents in the ADF paper chute (cover).

Load the documents face-down and top-first with their back facing you. Adjust the number of documents so that they do not go beyond the reference marks and are kept within the side guides when they are loaded.

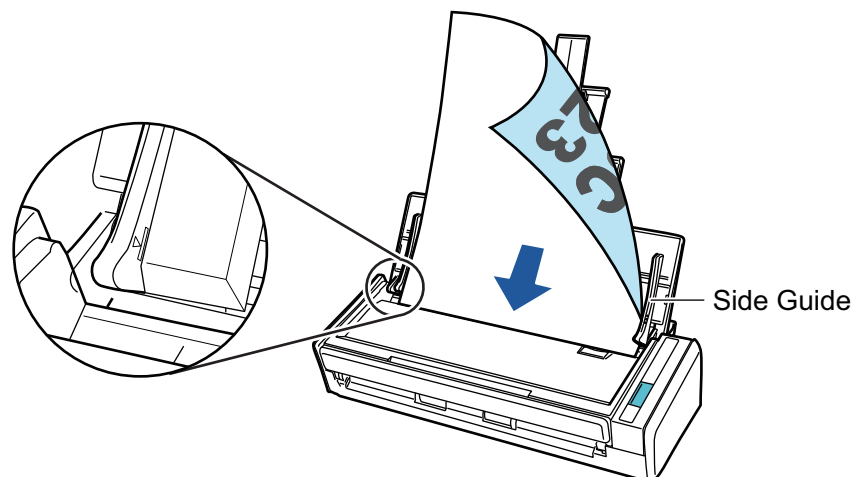

**ATTENTION**

When the [Place document face up] checkbox is selected in the [Scanning mode option] window, load the documents face-up and bottom edge down.

To open the [Scanning mode option] window, click the [Option] button in the [Scanning] tab of the "ScanSnap Setup Window" (page 41).

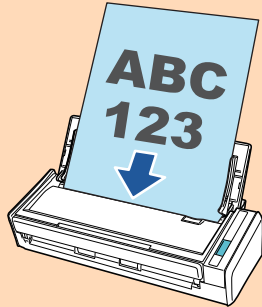
**7. Adjust the side guides to the width of the documents.**

Hold each side guide in the middle to adjust them. Otherwise, the documents may be fed skewed.

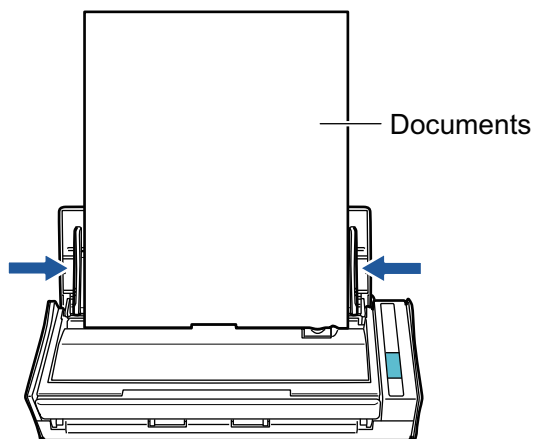
**8. Press the [Scan] button on the ScanSnap to start a scan.****ATTENTION**

Do not perform the following operations during scanning. Doing so will stop scanning.

- Connect or disconnect the ScanSnap and other USB devices.
- Close the ADF paper chute (cover).
- Switch users.
- Allow the computer to enter sleep mode.

⇒ The [Scan] button on the ScanSnap flashes in blue while the documents are being scanned.

The [ScanSnap Manager - Image scanning and file saving] window appears.

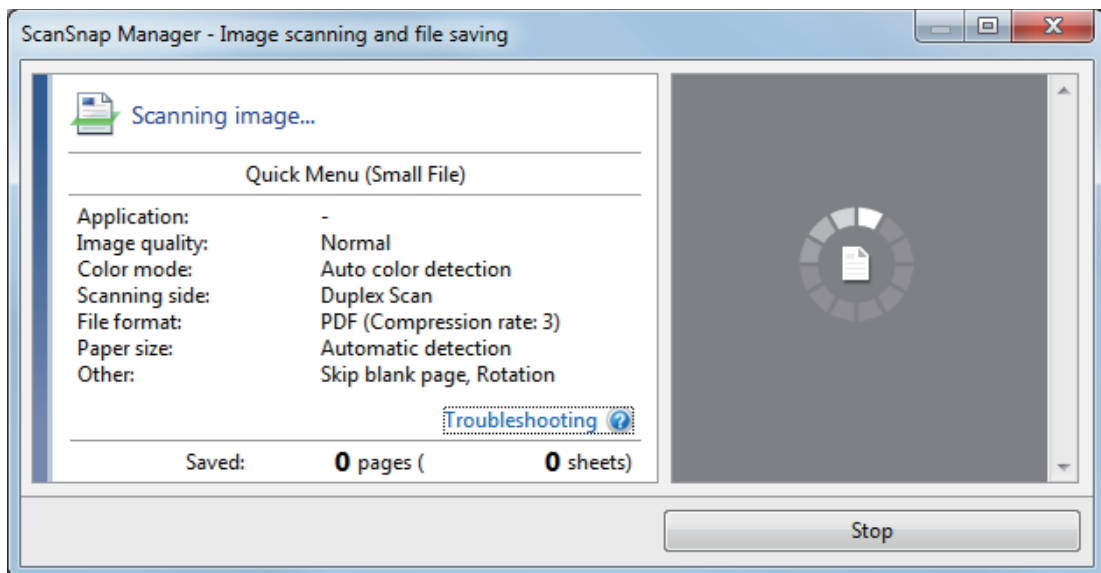

⇒ The Quick Menu appears when the scanning is completed.

**9. In the Quick Menu, click the icon of the application to link with ScanSnap Manager.**

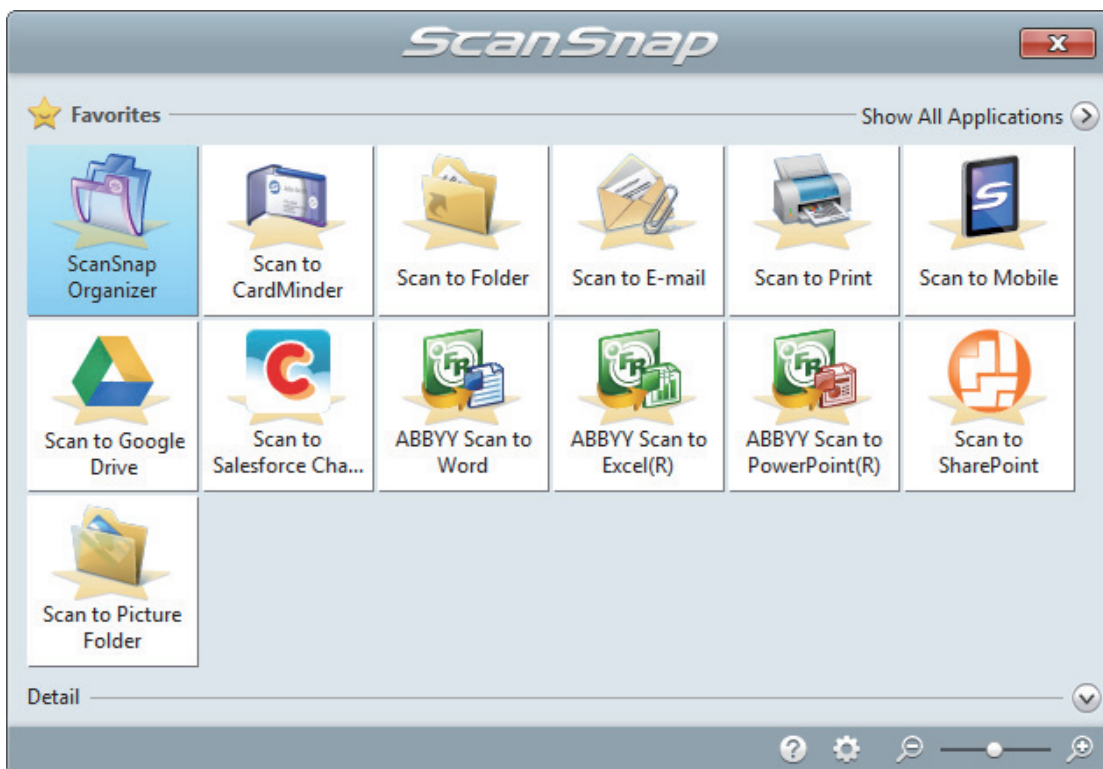

⇒ The selected application starts up. For details, refer to the Advanced Operation Guide.

**ATTENTION**

- You cannot start scanning when the Quick Menu is displayed. Either select an icon from the Quick Menu and finish the process, or close the Quick Menu before you perform the next scan.
- Do not move, delete, or rename scanned images using other applications while the Quick Menu is displayed.

**HINT**

- Clicking  displays the description of an application. Placing the mouse cursor over the icon of another application displays the description of the application.
  - Performing a scan while an application that can be automatically linked with is active automatically starts the linkage between ScanSnap Manager and the application.
- For details, refer to the Advanced Operation Guide.

# Scanning a Long Page

Documents up to 863 mm (34 in.) in length can be scanned.

For details about documents that can be scanned, refer to "Documents to Scan" (page 48).

## HINT

For details about how to load documents that are 360 mm (14.17 in.) or less in length, refer to "Scanning a Document" (page 17).

### 1. Open the ADF paper chute (cover) of the ScanSnap.

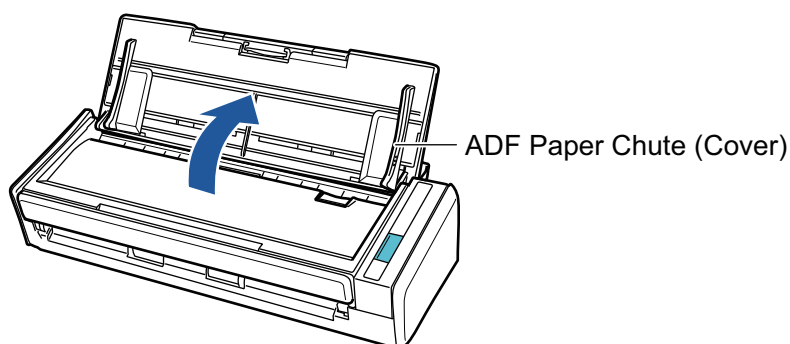

⇒ The [Scan] button flashes in blue. The button returns to being lit normally when document scanning is enabled.

In addition, the ScanSnap Manager icon in the notification area located at the far right of the taskbar changes from .

### 2. Pull out the extension.

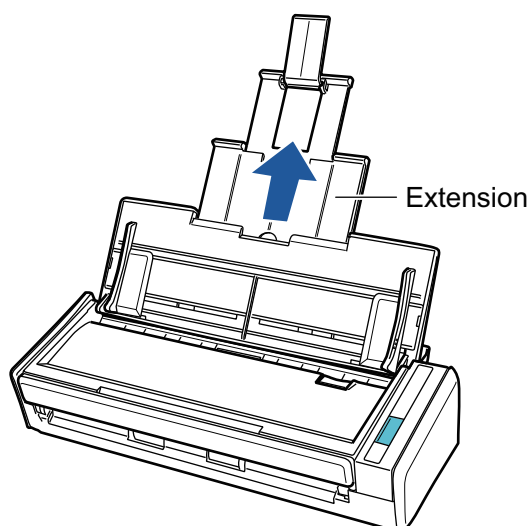

### 3. Load only one document in the ADF paper chute (cover).

Hold the document with your hand so that it does not fall out of the ADF paper chute (cover).

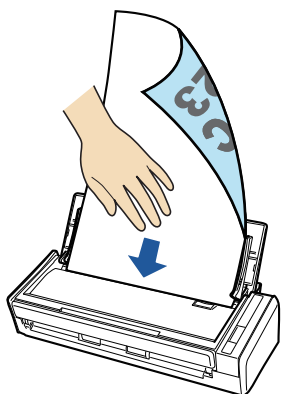

- 4. Press the [Scan] button on the ScanSnap (for three seconds or longer) until the button flashes in blue to start a scan.**

#### ATTENTION

- Secure enough space where the scanned documents are ejected from the ScanSnap, and pick up the documents with your hands to prevent them from falling off the unit where the ScanSnap is placed on.

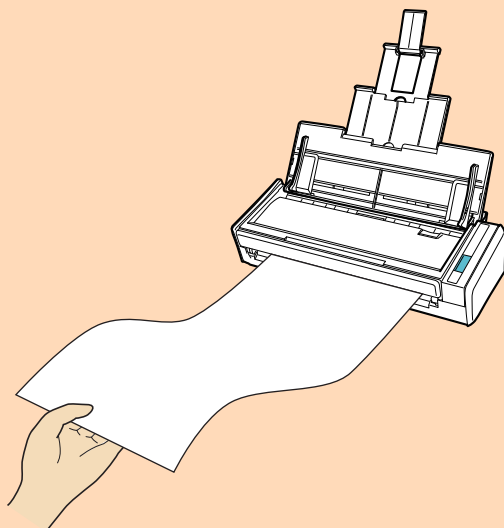

- Do not perform the following operations during scanning. Doing so will stop scanning.
  - Connect or disconnect the ScanSnap and other USB devices.
  - Close the ADF paper chute (cover).
  - Switch users.
  - Allow the computer to enter sleep mode.

#### HINT

When you scan the first page as a long page and continue scanning, the subsequent documents are also scanned as long pages.

- ⇒ The [Scan] button on the ScanSnap flashes in blue while the documents are being scanned.  
The [ScanSnap Manager - Image scanning and file saving] window appears.

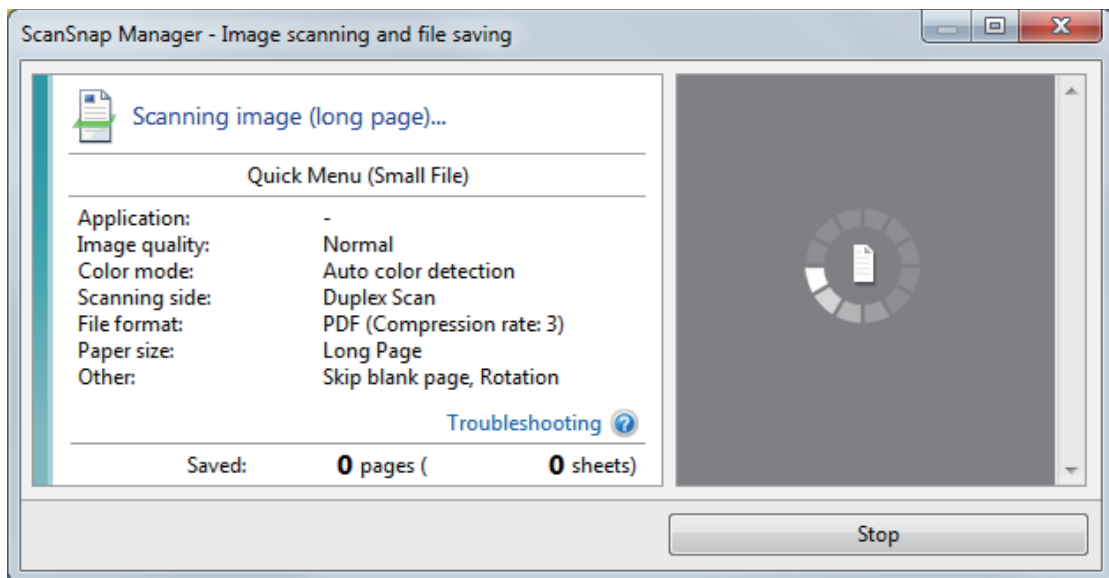

⇒ The Quick Menu appears when the scanning is completed.

**5. In the Quick Menu, click the icon of the application to link with ScanSnap Manager.**



When you select , you can manage scanned images by folder with ScanSnap Organizer.

For details, refer to "[Managing Paper Documents by Folder on a Computer](#)" (page 67).

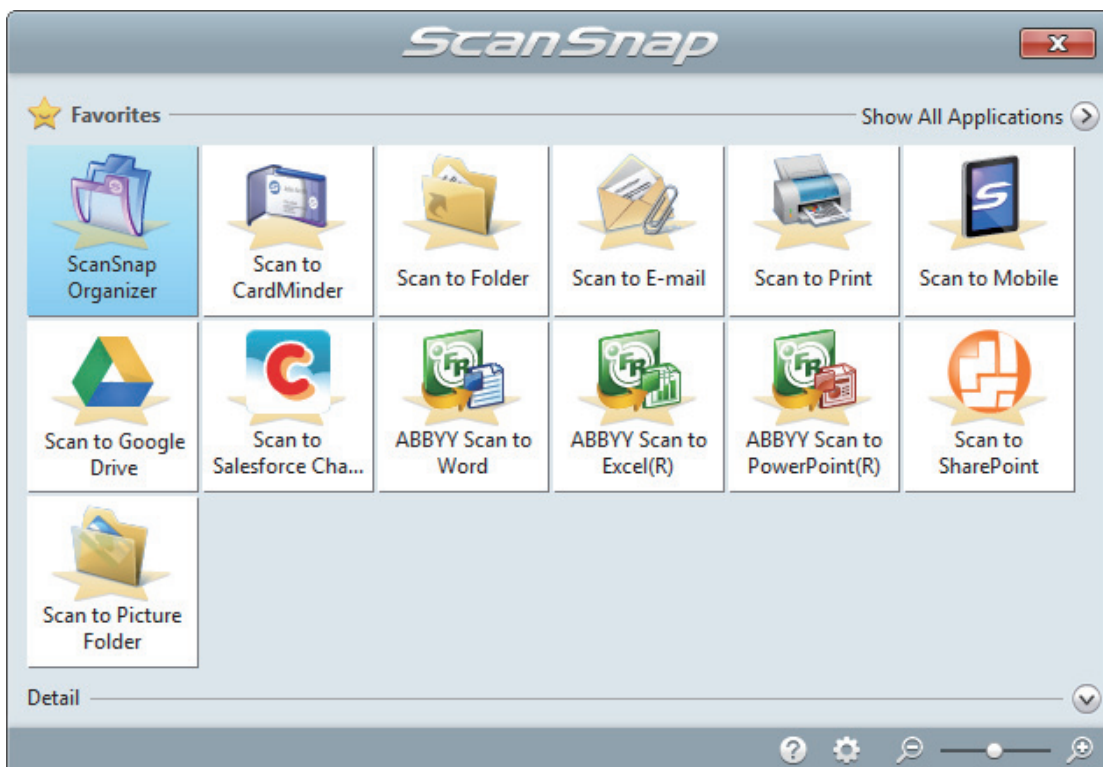

⇒ The selected application starts up. For details, refer to the Advanced Operation Guide.



**ATTENTION**

- You cannot start scanning when the Quick Menu is displayed. Either select an icon from the Quick Menu and finish the process, or close the Quick Menu before you perform the next scan.
- Do not move, delete, or rename scanned images using other applications while the Quick Menu is displayed.

**HINT**

- Clicking  displays the description of an application. Placing the mouse cursor over the icon of another application displays the description of the application.
- Performing a scan while an application that can be automatically linked with is active automatically starts the linkage between ScanSnap Manager and the application.  
For details, refer to the Advanced Operation Guide.

# Scanning Documents of Different Widths or Lengths in One Batch



Documents of different widths or lengths can be scanned in one batch.

For details about documents that can be scanned, refer to "Documents to Scan" (page 48).

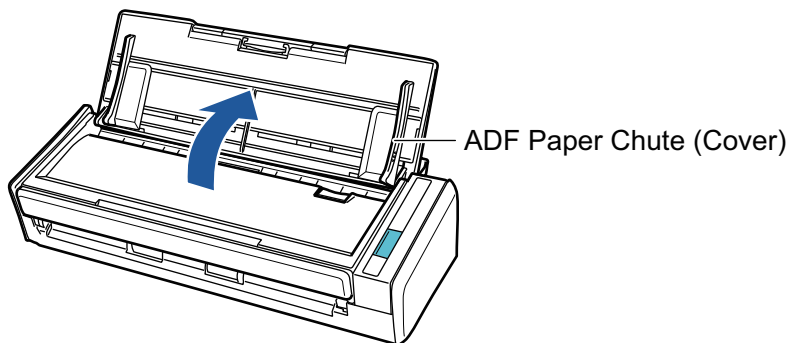
## 1. Open the ADF paper chute (cover) of the ScanSnap.



⇒ The [Scan] button flashes in blue. The button returns to being lit normally when document scanning is enabled.

In addition, the ScanSnap Manager icon in the notification area located at the far right of the taskbar changes from  to .

## 2. Pull out the extension.

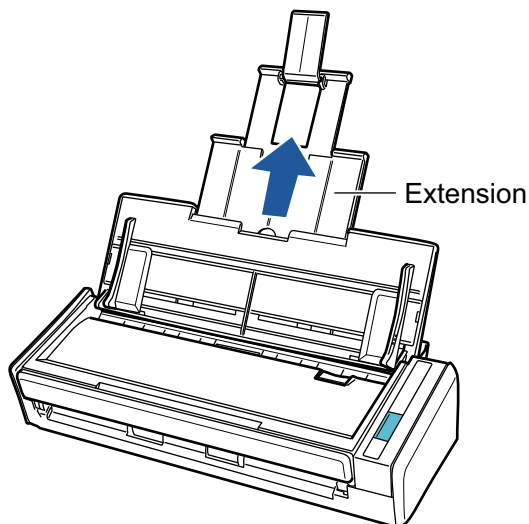

## 3. Right-click the ScanSnap Manager icon in the notification area located at the far right of the taskbar, and select the [Scan Button Settings] from the "Right-Click Menu" (page 39).

⇒ The ScanSnap setup window appears.

## 4. In the [Paper] tab, select [Automatic detection] in [Paper size].

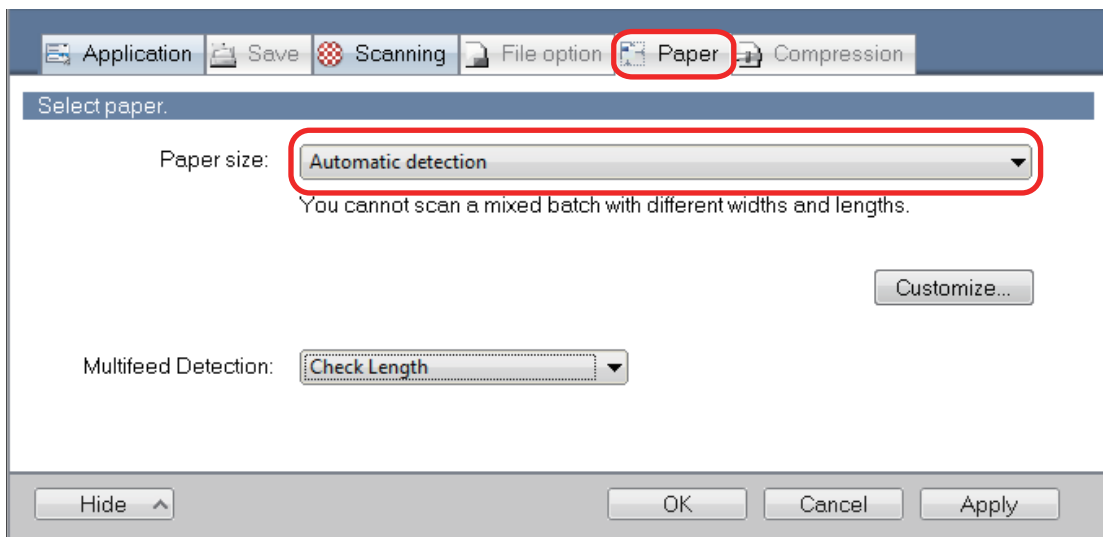

**5. Select [None] in [Multifeed Detection].**

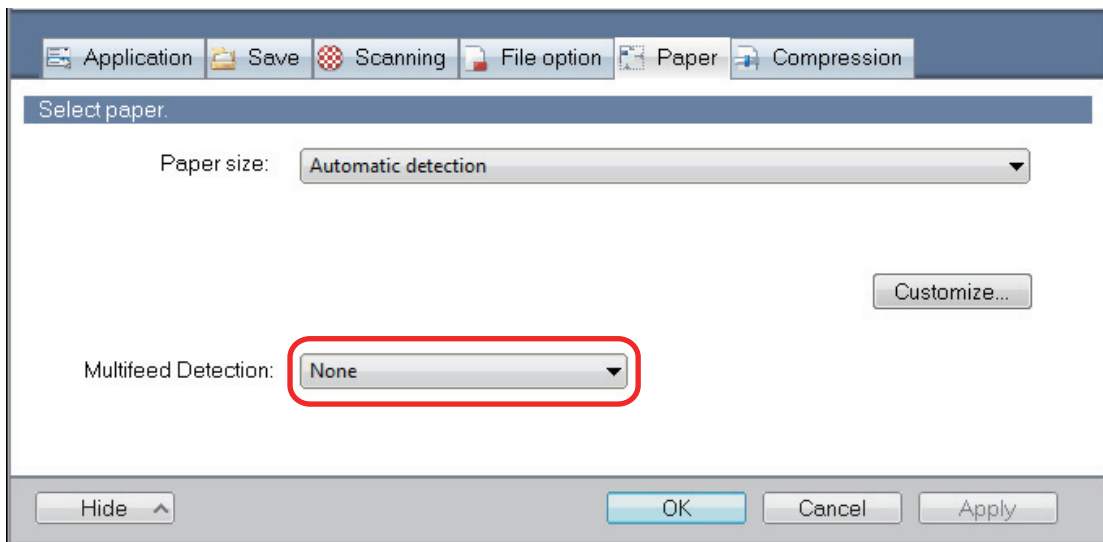

**6. Click the [OK] button to close the ScanSnap setup window.**

**7. Load documents in the ScanSnap.**

1. Align the edges of the documents.

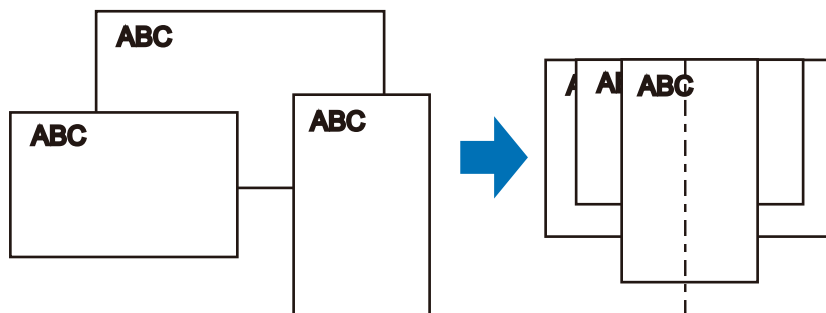

2. Load the documents at the center of the ADF paper chute (cover).

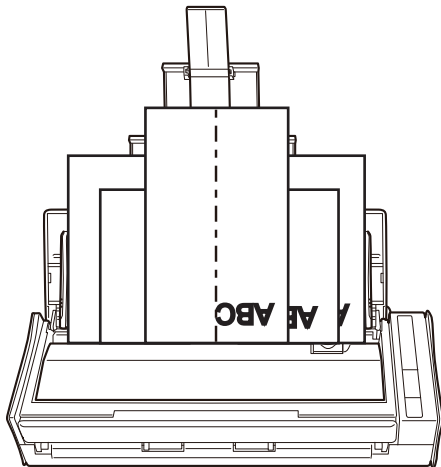

### ATTENTION

- Load all documents over one another above the pick roller (center). Documents that are not loaded above the pick roller cannot be fed.

Pick Roller Assembly's Width

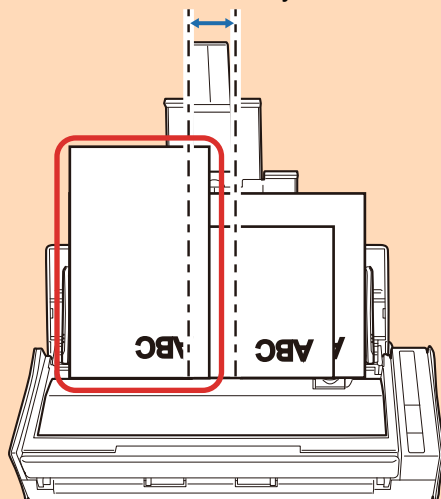

## Incorrect

- Adjust the side guides to the widest document. If the side guides are not adjusted properly, a paper jam may occur.
- Load smaller documents so that they can be scanned straight.

If the documents are skewed during scanning, the following problems may occur:

- Part of the document does not appear in the scanned image
- Slant lines appear in the scanned image
- The documents are scanned in a wrong paper size

If the documents are not scanned straight, it is recommended that you select the [Continue scanning after last page] checkbox in the [Scanning] tab of the "ScanSnap Setup Window" (page 41), separate the documents by their widths, and scan them in different batches.

## 8. Press the [Scan] button on the ScanSnap to start a scan.

### ATTENTION

Do not perform the following operations during scanning. Doing so will stop scanning.

- Connect or disconnect the ScanSnap and other USB devices.
- Close the ADF paper chute (cover).

- Switch users.
- Allow the computer to enter sleep mode.

⇒ The [Scan] button on the ScanSnap flashes in blue while the documents are being scanned.

The [ScanSnap Manager - Image scanning and file saving] window appears.

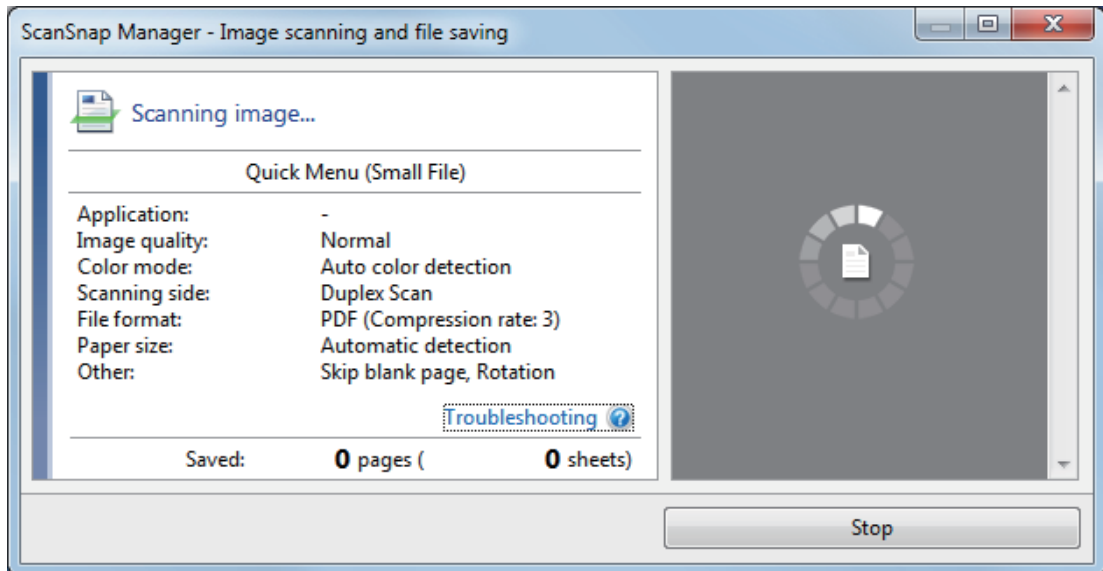

⇒ The Quick Menu appears when the scanning is completed.

## 9. In the Quick Menu, click the icon of the application to link with ScanSnap Manager.



When you select , you can manage scanned images by folder with ScanSnap Organizer.

For details, refer to "Managing Paper Documents by Folder on a Computer" (page 67).

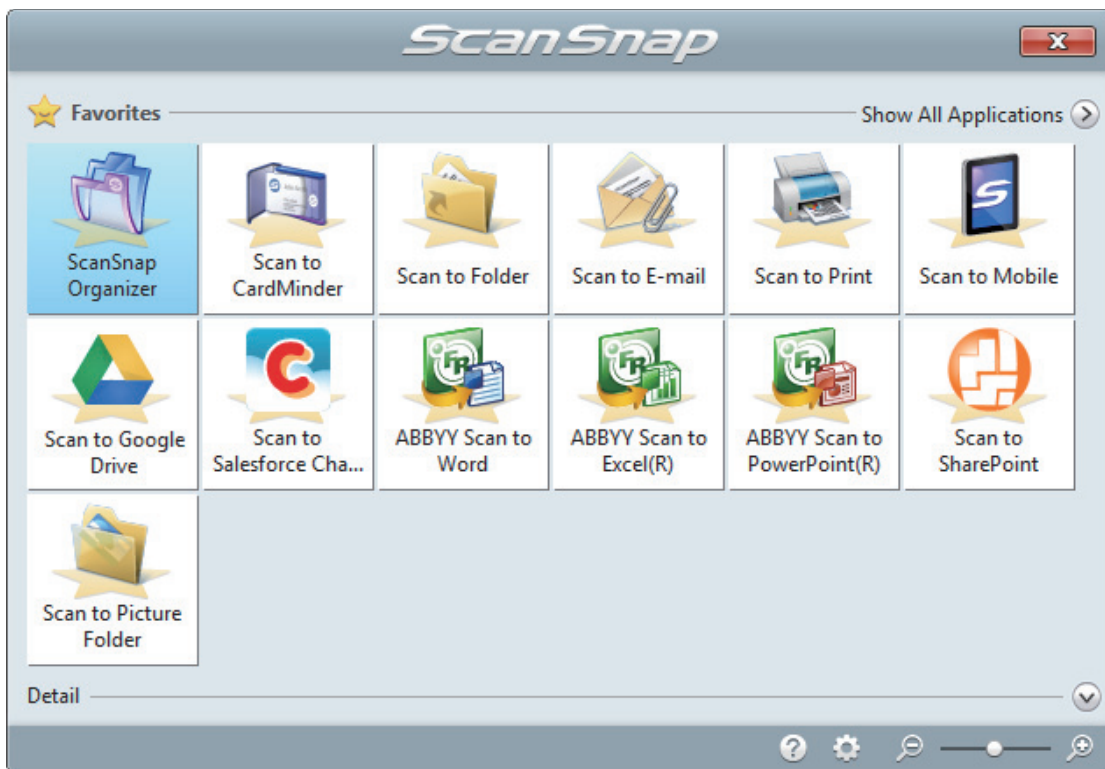

⇒ The selected application starts up. For details, refer to the Advanced Operation Guide.

#### ATTENTION

- You cannot start scanning when the Quick Menu is displayed. Either select an icon from the Quick Menu and finish the process, or close the Quick Menu before you perform the next scan.
- Do not move, delete, or rename scanned images using other applications while the Quick Menu is displayed.

#### HINT

- Clicking  displays the description of an application. Placing the mouse cursor over the icon of another application displays the description of the application.
- Performing a scan while an application that can be automatically linked with is active automatically starts the linkage between ScanSnap Manager and the application.  
For details, refer to the Advanced Operation Guide.

# ScanSnap Overview

This section provides an overview that you should be aware of before operating ScanSnap.

- ["Parts and Functions" \(page 32\)](#)
- ["System Requirements" \(page 34\)](#)
- ["Overview of the Software Related to the ScanSnap" \(page 36\)](#)
- ["How to Install the Software" \(page 37\)](#)
- ["ScanSnap Manager Icon" \(page 38\)](#)
- ["Right-Click Menu" \(page 39\)](#)
- ["ScanSnap Setup Window" \(page 41\)](#)
- ["Turning the ScanSnap On or Off" \(page 42\)](#)
- ["Documents to Scan" \(page 48\)](#)

## Parts and Functions

This section explains the names and functions of the ScanSnap parts.

### Front

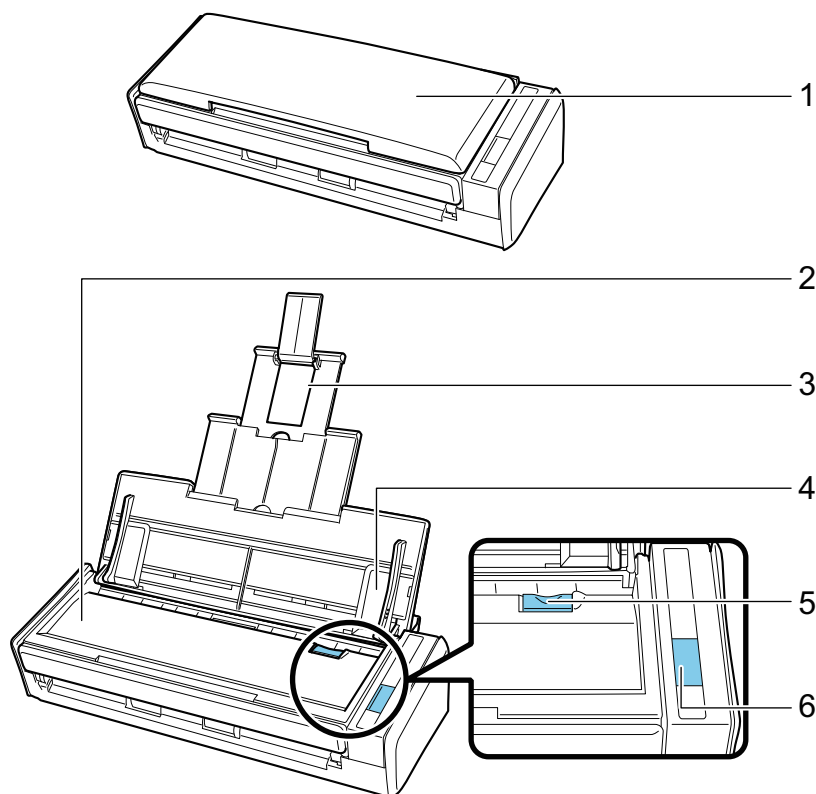

No.	Name	Description
1	ADF paper chute (cover) (*1)	Open it to use the ScanSnap. Opening it turns on the ScanSnap. Then, you can load a document on it.
2	ADF top section	Open it to remove jammed documents, replace the Roller Set, or clean the inside of the ScanSnap.
3	Extension	Pull out when scanning long documents.
4	Side guide	Adjust to the width of documents to prevent them from getting skewed.
5	ADF release tab	Pull this tab to open the ADF top section.
6	[Scan] button (*1)	Starts scanning. Indicates the status of the ScanSnap as follows: Blue (lit): Ready Blue (flashing): Scanning Orange (flashing): Error

\*1: When the ScanSnap has turned off automatically because of the automatic power off function, either press the [Scan] button (this will not start scanning), or close the ADF paper chute (cover), then open it again to turn the ScanSnap back on.

For details, refer to ["Automatic Power OFF" \(page 47\)](#).



## Back

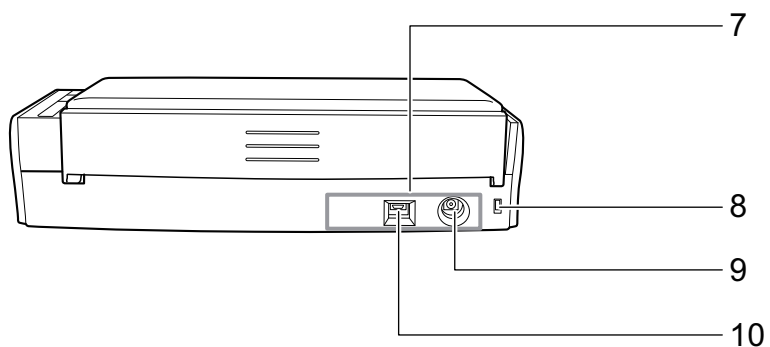

No.	Name	Description
7	Tape seal	Remove this tape seal after installing the software.
8	Security cable slot	Used to connect an anti-theft security cable (commercially available).
9	Power connector	Used to connect a power cable.
10	USB connector	Used to connect a USB cable.

# System Requirements

The ScanSnap has the following system requirements.

For the latest information on requirements, please visit the ScanSnap Support Site at:

<http://scansnap.fujitsu.com/g-support/en/>

<b>Operating system</b>	Windows 10 (32-bit/64-bit) (*1) Windows 8.1 (32-bit/64-bit) (*1) Windows 8 (32-bit/64-bit) (*1) Windows 7 (32-bit/64-bit) Windows Vista (32-bit/64-bit) (*2) Windows XP (32-bit) (*3)
<b>CPU</b>	Intel® Core™ i5 2.5 GHz or higher
<b>Memory</b>	4 GB or more
<b>Display resolution (*4)</b>	Windows 10/Windows 8.1/Windows 8: 1024 × 768 pixels or higher Windows 7/Windows Vista/Windows XP: 800 × 600 pixels or higher
<b>Disk space</b>	Free space required to install the software related to the ScanSnap is as follows: (*5) <ul style="list-style-type: none"> <li>● ScanSnap Manager: 700 MB</li> <li>● ScanSnap Organizer: 670 MB</li> <li>● CardMinder: 660 MB</li> <li>● ABBYY FineReader for ScanSnap: 620 MB</li> <li>● ScanSnap Online Update: 10 MB</li> <li>● Scan to Microsoft SharePoint: 40 MB</li> <li>● ScanSnap S1300i Basic Operation Guide: 10 MB</li> </ul>
<b>USB port</b>	USB 3.0 (*6)/USB 2.0/USB 1.1

\*1: The software bundled with the ScanSnap operates as a desktop application.

\*2: Service Pack 2 or later is required.

\*3: Service Pack 3 or later is required.

\*4: When the font size is large, some screens may not be displayed correctly.

In such a case, use a smaller font size.

\*5: To save scanned images, more free space is required.

For details about estimated image data size, refer to the ScanSnap Manager Help.

\*6: When the ScanSnap is connected to a USB 3.0 port, the port operates as a USB 2.0 port.

## ATTENTION

- If the system requirements above are not satisfied, the ScanSnap may not operate.
- If a USB port on the keyboard or on the monitor is in use, the ScanSnap may not operate.
- When using a commercially available USB hub, use a type that is powered from an electrical power supply (and that comes with an adapter).
- Scanning speed decreases in the following cases:
  - The CPU or the memory does not meet the recommended specifications.
  - The version of the USB port or the USB hub is USB 1.1.
- The actual disk space used for the installation of the software and the disk space required for the installation may be different because of the disk management in your Windows system.

- To scan a document, a disk space that is approximately three times larger than the size of the file to be saved is required.
- If characters are not correctly displayed when using CardMinder, Scan to Mobile, Scan to Salesforce Chatter, or Scan to Dropbox, perform the following.
  - Windows XP
    - Select [Control Panel] → [Regional and Language Options] → [Install files for East Asian languages] in the [Language] tab.
    - Install the universal font (Arial Unicode MS) from the setup disk of Microsoft Office 2000 or later.
  - Windows Vista/Windows 7/Windows 8/Windows 8.1/Windows 10  
Install the universal font (Arial Unicode MS) from the setup disk of Microsoft Office 2003 or later.

#### HINT

- For Windows 7, Windows Vista, or Windows XP, when the following software programs are installed, .NET Framework 4 or an in-place update for .NET Framework 4 (which requires 2 GB of free disk space at most) may be installed:
  - ScanSnap Manager
  - ScanSnap OrganizerAfter installing .NET Framework, apply the updates in Windows Update.
- For Windows 10, Windows 8.1, Windows 8, Windows Vista, or Windows XP, when the following software programs are installed, .NET Framework 3.5 SP1 (which requires 500 MB of free disk space at most) may be installed at the same time:
  - ScanSnap Manager
  - ScanSnap Organizer
  - CardMinder
- For Windows XP, when Scan to Microsoft SharePoint is installed, .NET Framework 2.0 (which requires 280 MB of free disk space at most) may be installed at the same time.

# Overview of the Software Related to the ScanSnap

This section gives an overview of each bundled software and their functions. You can edit, manage, and arrange the scanned image by using the following software:

## **ScanSnap Manager**

This scanner driver is required to scan documents with the ScanSnap. Scanned images can be saved as PDF or JPEG files to a computer.

You need to have ScanSnap Connect Application installed on your mobile device to save PDF or JPEG files to your mobile device.

You can download ScanSnap Connect Application for your mobile device from its application market.

## **ScanSnap Organizer**

You can use this application to display image data (PDF or JPEG files) without opening them, create folders and arrange files as you like.

## **CardMinder**

You can use this application to efficiently digitalize a large number of business cards.

Text recognition can be performed on business cards and you can create a database to facilitate card data management and searches. Data in the database can be printed and linked with various applications.

## **ABBYY FineReader for ScanSnap**

This application can perform text recognition on the scanned images using OCR (Optical Character Recognition) to convert the image data to Word, Excel, or PowerPoint files that can be edited.

## **ScanSnap Online Update**

This application checks whether the latest updates or software programs are available on the download server. When the latest updates or software programs are available, you can automatically apply updates or download and install the software programs manually.

## **Scan to Microsoft SharePoint**

You can easily save files in SharePoint using the ScanSnap.

## **Evernote for Windows**

You can easily save files in Evernote using the ScanSnap.

## **Dropbox for Windows**

You can easily save files to your Dropbox folder using the ScanSnap.

## How to Install the Software

When you insert the Setup DVD-ROM into the DVD-ROM drive on your computer, the [ScanSnap Setup] window appears.

### ATTENTION

- Do not connect the ScanSnap to the computer before installing the software. Doing so may cause the ScanSnap not to be recognized by the computer. In that case, install the software, and then reconnect the ScanSnap to the computer.
- If a DVD-ROM drive is not available, the installers for the software programs can be downloaded from the following web page.

<http://scansnap.fujitsu.com/g-support/en/>

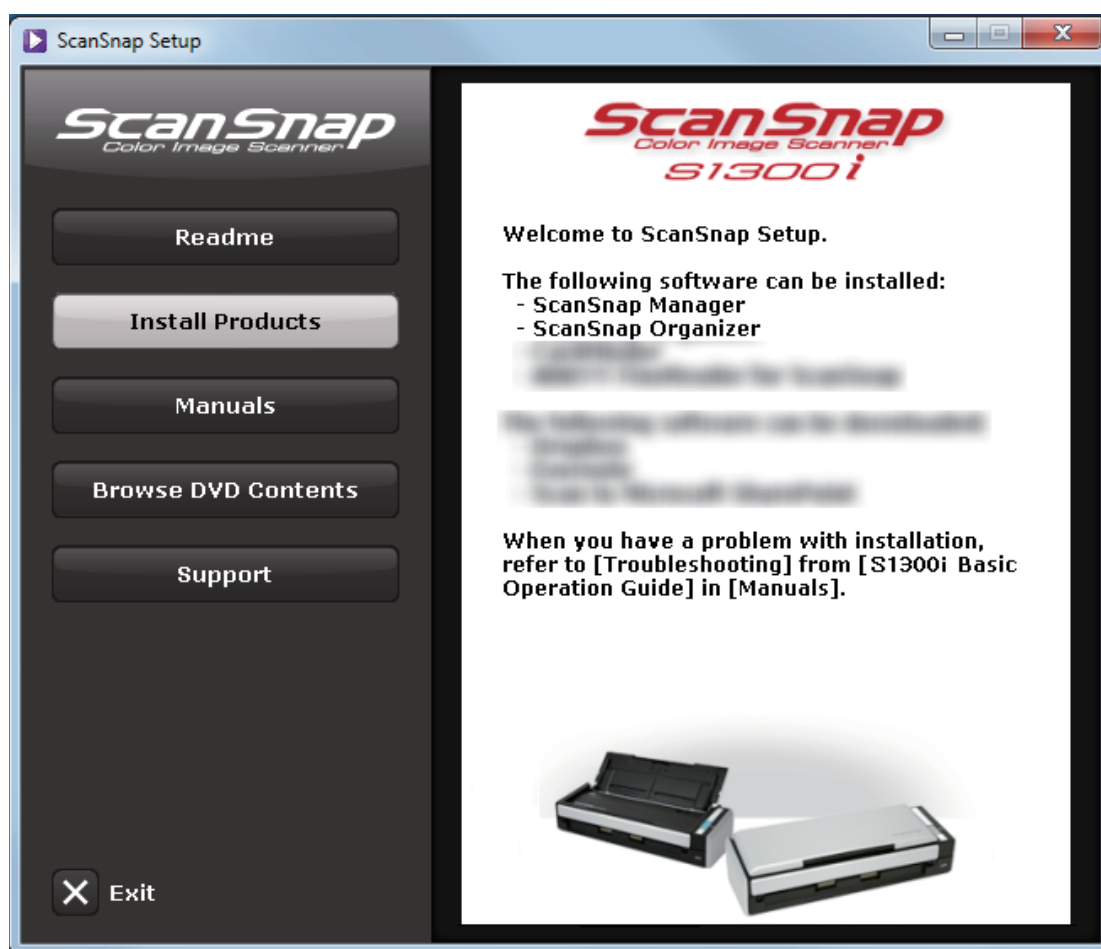

The functions of each button in the [ScanSnap Setup] window are as follows.



Button	Function
Readme	Displays the [Readme] window. You can refer to the Readme file of each software in this window.
Install Products	Displays the [Install Products] window. You can start installing software.
Manuals	Displays the [Manuals] window. You can refer to Safety Precautions, Getting Started, the Basic Operation Guide (this manual), and the manual of each software program in this window.
Browse DVD Contents	Opens Windows Explorer to display the files from the Setup DVD-ROM.
Support	Displays contact information for customer support.

## ScanSnap Manager Icon

When ScanSnap Manager is running, the ScanSnap Manager icon is displayed in the notification area. The notification area is located at the far right of the taskbar.

The ScanSnap Manager icon indicates whether or not ScanSnap Manager is successfully communicating with the ScanSnap. The appearance of the icon changes according to the communication status as shown below.

This manual assumes that the ScanSnap is powered by a power cable.

Communication Status	ScanSnap Manager Icon
Communicating	When the ScanSnap is powered by a power cable 
	When the ScanSnap is powered by a USB bus power cable 
Not communicating	

### HINT

Turn the ScanSnap on to begin communication between ScanSnap Manager and the ScanSnap. For details about how to turn on the ScanSnap, refer to "[Turning the ScanSnap On](#)" (page 43).

You can display the menu for scanning documents and ScanSnap Manager settings from the ScanSnap Manager icon.

- Right-clicking  
Displays the "[Right-Click Menu](#)" (page 39).
- Left-clicking  
Displays the Left-Click Menu.  
For details, refer to the Advanced Operation Guide.

## Right-Click Menu

This menu appears when you right-click the ScanSnap Manager icon  in the notification area located at the far right of the taskbar.

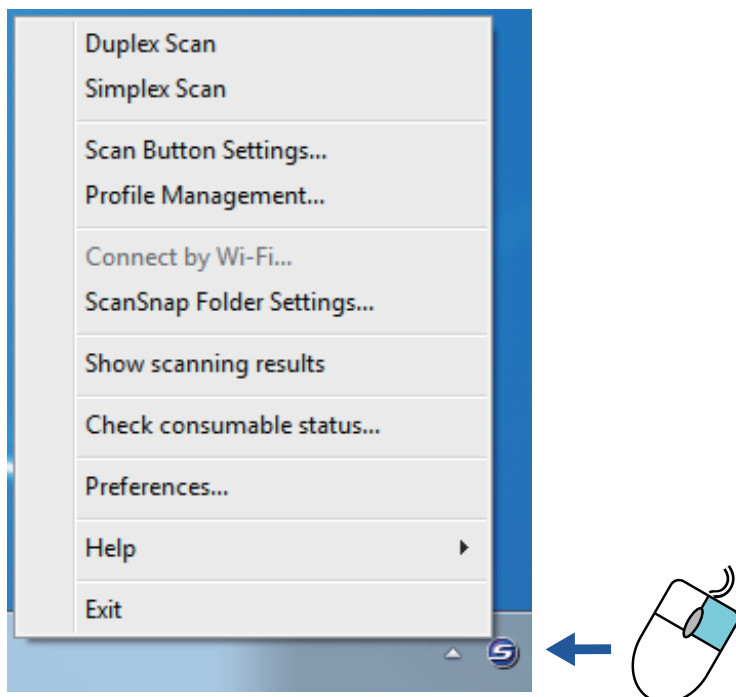

Item	Function
Duplex Scan	Scans both sides of the document.Follows the settings configured in [Scan Button Settings].
Simplex Scan	Scans only one side of the document.Follows the settings configured in [Scan Button Settings].
Scan Button Settings	Displays the " <a href="#">ScanSnap Setup Window</a> " (page 41). You can configure the scan settings in this window.
Profile Management	Displays the [ScanSnap Manager - Profile Management] window. You cannot select [Profile Management] when the [Use Quick Menu] checkbox is selected in the ScanSnap setup window. For details, refer to the Advanced Operation Guide.
Connect by Wi-Fi	Displays the [ScanSnap Manager - Connect by Wi-Fi] window. Available with iX500 and iX100.
ScanSnap Folder Settings	Displays the ScanSnap setup window. You can configure the scan settings for using ScanSnap Folder in this window. For details, refer to the Advanced Operation Guide.

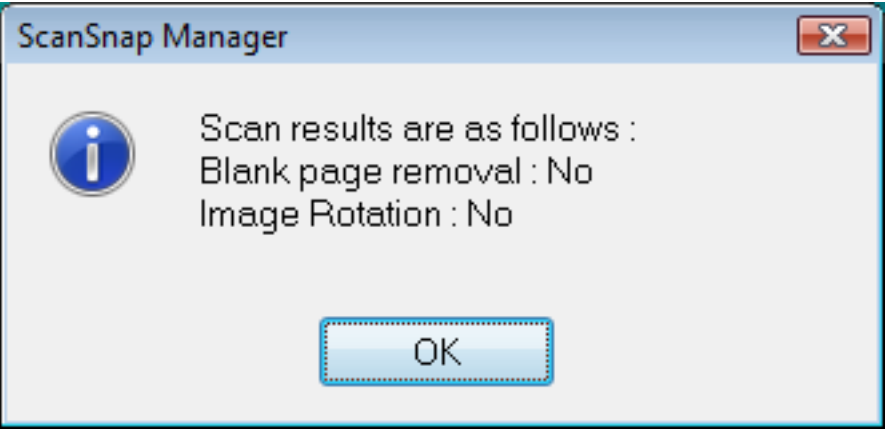
Item	Function
Show scanning results	<p>After scanning is completed, a message appears to inform you whether the image is rotated.</p> 
Check consumable status	<p>Displays the [ScanSnap Manager - Check consumable status] window. You can reset the consumable counters after replacing the consumables.</p>
Preferences	<p>Displays the [ScanSnap Manager - Preferences] window.</p>
Help	<p>Displays the following menu:</p> <ul style="list-style-type: none"> <li>● Help Opens the ScanSnap Manager Help.</li> <li>● Troubleshooting Displays [Troubleshooting] in the ScanSnap Manager Help.</li> <li>● ScanSnap Portal Site Opens the ScanSnap global homepage (<a href="http://scansnap.fujitsu.com">http://scansnap.fujitsu.com</a>).</li> <li>● About ScanSnap Manager Displays the [ScanSnap Manager - Version Information] window.</li> <li>● ScanSnap information Displays the [ScanSnap Manager - Scanner and driver information] window. Displayed when the ScanSnap and computer are connected.</li> <li>● Online Update Starts the ScanSnap Online Update. For details, refer to "<a href="#">Updating the Software</a>" (page 114).</li> </ul>
To establish connection	<p>Displayed when ScanSnap Manager is not communicating with the ScanSnap correctly.</p>
Exit	<p>Exits ScanSnap Manager.</p>



# ScanSnap Setup Window

When you right-click the ScanSnap Manager icon  in the notification area located at the far right of the taskbar, and select [Scan Button Settings] from the "Right-Click Menu" (page 39), the following ScanSnap setup window appears.

In the ScanSnap setup window, you can use the [Use Quick Menu] checkbox to specify whether or not to use the Quick Menu. You can also use the profile buttons and detail setting tabs to specify scan settings according to your scanning needs.

For details, refer to the ScanSnap Manager Help.

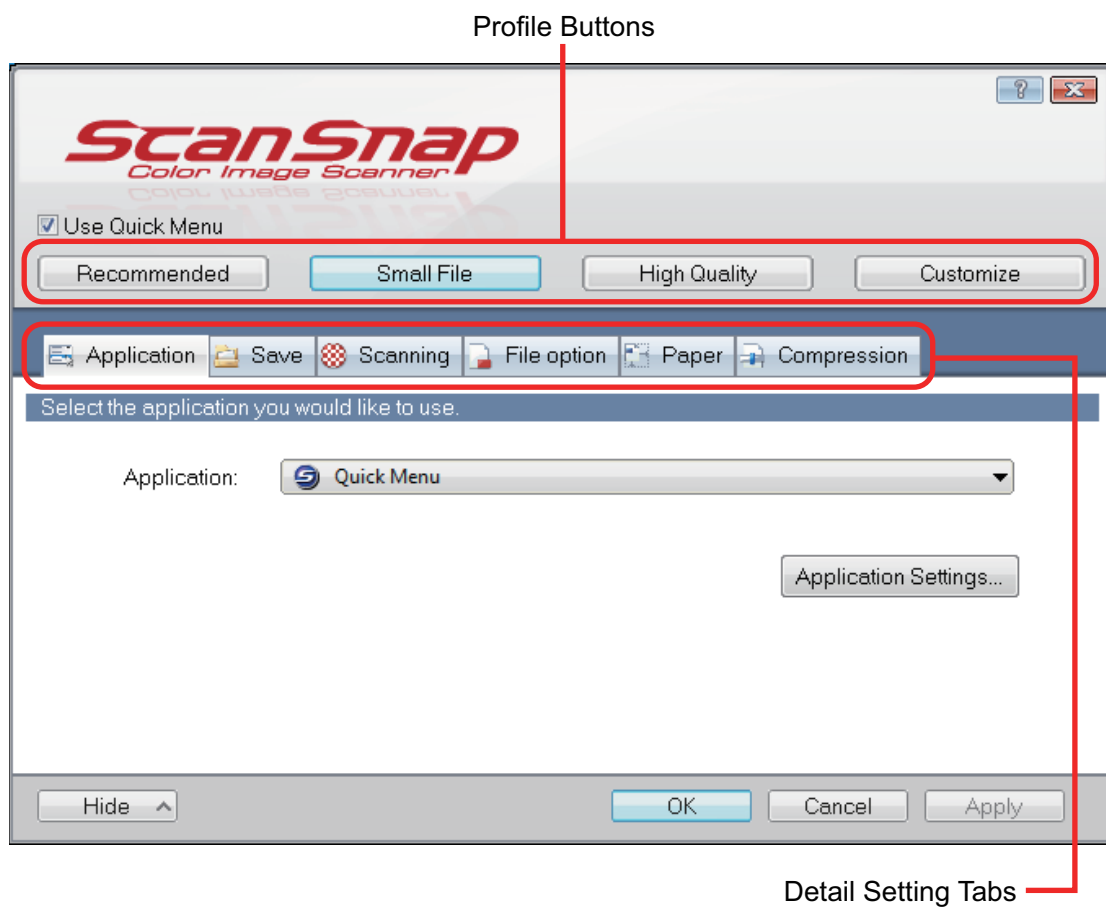

# Turning the ScanSnap On or Off

This section explains how to turn the ScanSnap on or off.

- ["Turning the ScanSnap On" \(page 43\)](#)
- ["Turning the ScanSnap Off" \(page 45\)](#)
- ["Sleep Mode" \(page 46\)](#)
- ["Automatic Power OFF" \(page 47\)](#)



## Turning the ScanSnap On

### 1. Turn on the computer.

⇒ The computer starts up and the ScanSnap Manager icon  appears in the notification area located at the far right of the taskbar.





#### HINT

- If the ScanSnap Manager icon  is not displayed in the notification area, start ScanSnap Manager. Start ScanSnap Manager in the following procedure.
  - Windows 10  
Select [Start] menu → [All apps] → [ScanSnap Manager] → [ScanSnap Manager].
  - Windows 8.1  
Click  on the lower left side of the Start screen, and select [ScanSnap Manager] under [ScanSnap Manager] on the All apps screen.
  - Windows 8  
Right-click the Start screen, and select [All apps] on the app bar → [ScanSnap Manager] under [ScanSnap Manager].
  - Windows 7/Windows Vista/Windows XP  
Select [Start] menu → [All Programs] → [ScanSnap Manager] → [ScanSnap Manager].
- If ScanSnap Manager does not automatically start when you log on to your computer, change the setting in the following procedure:
  1. Right-click the ScanSnap Manager icon  in the notification area and select [Preferences] from the "Right-Click Menu" (page 39).  
⇒ The [ScanSnap Manager - Preferences] window appears.
  2. In the [Auto Startup] list, select the [Start up ScanSnap Manager when you log on] checkbox.

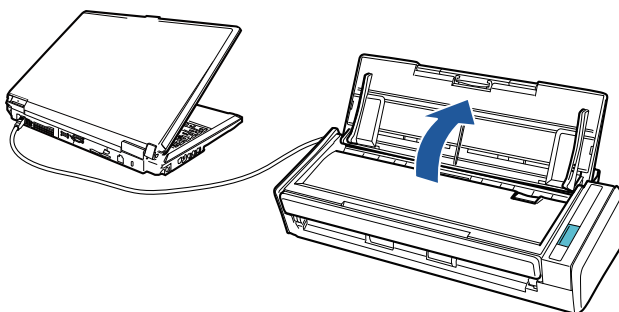
### 2. Open the ADF paper chute (cover) of the ScanSnap to turn the power on.



⇒ The [Scan] button flashes in blue. The button returns to being lit normally when document scanning is enabled.

In addition, the ScanSnap Manager icon in the notification area changes from  to .

### ATTENTION

With some computers, the initialization of the ScanSnap may be performed several times when the computer is started up.

### HINT

- It may take more time for the ScanSnap Manager icon in the notification area to change to  depending on computer performance, operating environment, or loading, for example, when many software programs are running at the same time.
- When the ScanSnap is turned on, a notification informs you of the ScanSnap's communication status.

To disable notifications of the ScanSnap's communication status, change the setting in the following procedure:



1. Right-click the ScanSnap Manager icon  in the notification area and select [Preferences] from the "Right-Click Menu" (page 39).  
⇒ The [ScanSnap Manager - Preferences] window appears.
2. Clear the [Notify of the communication status] checkbox in the [Status Display] list.

## Turning the ScanSnap Off

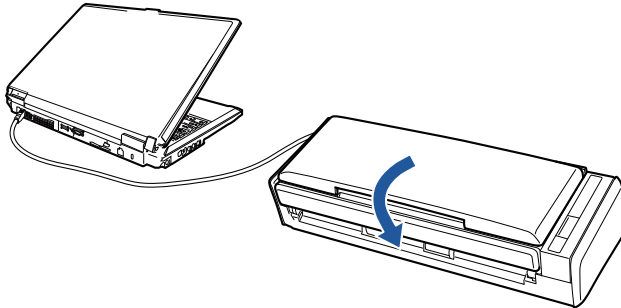
### 1. Close the ADF paper chute (cover).



⇒ The [Scan] button turns off.

In addition, the ScanSnap Manager icon in the notification area changes from  to .

#### ATTENTION

- Close the ADF paper chute (cover) after putting the extension back.
- If moving the ScanSnap, first turn the power off and remove all cables.

The bottom part of the ScanSnap may become hot when the ScanSnap is being used but this does not affect ScanSnap operation or cause any physical harm. Be careful not to drop the ScanSnap when carrying it.

#### HINT

- The power of the ScanSnap is linked with the power of the computer to which the ScanSnap is connected. If you keep the ScanSnap connected to the computer, you do not have to worry about turning the power ON/OFF.
- With some computers, it may take 2 to 3 minutes until the light of the [Scan] button goes out after the computer is turned off.
- When the ScanSnap is turned off, a notification informs you of the ScanSnap's communication status.

To disable notifications of the ScanSnap's communication status, change the setting in the following procedure:

1. Right-click the ScanSnap Manager icon  in the notification area and select [Preferences] from the "Right-Click Menu" (page 39).
  - ⇒ The [ScanSnap Manager - Preferences] window appears.
2. Clear the [Notify of the communication status] checkbox in the [Status Display] list.

---

## Sleep Mode

When the ScanSnap is on and has not been used for one minute, it enters sleep (power saving) mode.

---

## Automatic Power OFF

When the ScanSnap is turned on and left unused for the specified time (default is "4 hours"), it will turn itself off automatically.

To turn the ScanSnap back on, perform one of the following operations:

- Press the [Scan] button on the ScanSnap (this will not start scanning)
- Close the ADF paper chute (cover) and open it again

### HINT

- To continue using the ScanSnap, reset the time until auto power-off by performing one of the following:
  - Load a document in the ScanSnap
  - Press the [Scan] button on the ScanSnap
  - Close the ADF paper chute (cover) and open it again
- You can change the time of the ScanSnap to turn off automatically or change the setting so that it will not turn off automatically. Set according to the following procedures:
  1. Right-click the ScanSnap Manager icon  in the notification area and select [Preferences] from the "Right-Click Menu" (page 39).
    - ⇒ The [ScanSnap Manager - Preferences] window appears.
  2. In the [Power] list, change the settings for [Power setting] based on how it is connected.
- A notification informs you 5 minutes before the ScanSnap turns off automatically.

# Documents to Scan

Conditions for documents that can be loaded into the ScanSnap are as follows:

## Office paper, postcards, business cards

<b>Document type</b>	Office paper, postcards, business cards
<b>Paper weight</b>	64 to 104.7 g/m <sup>2</sup> (17 to 20 lb)
<b>Paper size</b>	Width: 50.8 to 216 mm (2 to 8.5 in.) Length: 50.8 to 360 mm (2 to 14.17 in.) ● For long page (*1) 216 × 863 mm (8.5 × 34 in.)

\*1: Scanning starts when you hold down the [Scan] button on the ScanSnap for 3 seconds or longer.

### ATTENTION

The following types of documents must not be scanned:

- Documents attached with the metals such as paper clips or staples that can damage the inside of the ScanSnap  
Remove the metals for scanning.
- Documents on which the ink is still wet  
Wait until the ink dries completely to scan these documents.
- Documents larger than width 216 mm (8.5 in.), length 863 mm (34 in.)
- Documents other than paper such as fabric, metal foil, OHP film, or plastic card
- Documents with photographs or memo papers attached

### Documents that you need to treat with caution

- Documents written in pencil  
When you scan documents written in pencil, there may be black traces left on them. Also, dirt accumulating on the rollers may cause feeding errors. Clean the rollers occasionally when you scan such documents. For details about how to perform cleaning, refer to "Troubleshooting" in the ScanSnap Manager Help.
- Carbonless paper  
Carbonless paper may contain chemicals that can harm the pad assy and the rollers inside the ScanSnap. Make sure to perform cleaning occasionally to maintain the scanner performance when scanning carbonless paper. For details about how to perform cleaning, refer to "Troubleshooting" in the ScanSnap Manager Help. Depending on the type of carbonless paper, the life span of the scanner may be shortened compared to scanning office paper.
- Scanning the following types of documents can result in documents being damaged or scanned incorrectly.
  - Documents smaller than width 50.8 mm (2 in.), length 50.8 mm (2 in.)
  - Documents that weigh less than 64 g/m<sup>2</sup> (17 lb)
  - Documents with an uneven surface (such as envelopes and paper sheets with attached materials)
  - Wrinkled or curled documents
  - Folded or torn documents
  - Tracing paper



- Coated paper
- Photographs (photographic paper)
- Perforated or punched documents
- Documents that are not rectangular or square
- Carbon paper or thermal paper
- Documents with memo papers or sticky notes attached

## Picture Postcards

Picture postcards can be scanned when a power cable connection is used.

<b>Document type</b>	Picture postcards
<b>Paper weight</b>	64 to 326 g/m <sup>2</sup> (17 to 87 lb)
<b>Paper size</b>	Width: 50.8 to 100 mm (2 to 3.9 in.) Length: 50.8 to 148 mm (2 to 5.8 in.)

### ATTENTION

- All conditions below must be satisfied when scanning picture postcards. Otherwise, paper jam may occur.
  - Power cable connection
  - Normal room temperature and humidity levels
  - Load the picture postcard face-down in the ScanSnap
- When you scan photographs or picture postcards, be aware that the picture side may get damaged. It is the responsibility of the customer to scan photographs or picture postcards.

# What You Can Do with Related Software

This section explains the basic operation procedure of software related to the ScanSnap and gives an overview of its functions.

- ["What You Can Do with the ScanSnap Organizer" \(page 51\)](#)
- ["What You Can Do with CardMinder" \(page 57\)](#)

# What You Can Do with the ScanSnap Organizer

ScanSnap Organizer is an application used for displaying, organizing, and managing image data (PDF or JPEG files) scanned with the ScanSnap.

You can use this application to display image data (PDF or JPEG files) without opening them, create folders and arrange files for various uses.

Pages of a PDF file can also be flipped through in thumbnails to verify the scanned image data.

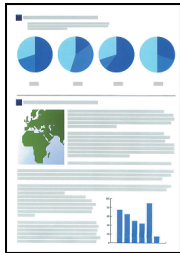

Scan documents with the ScanSnap

Main Window

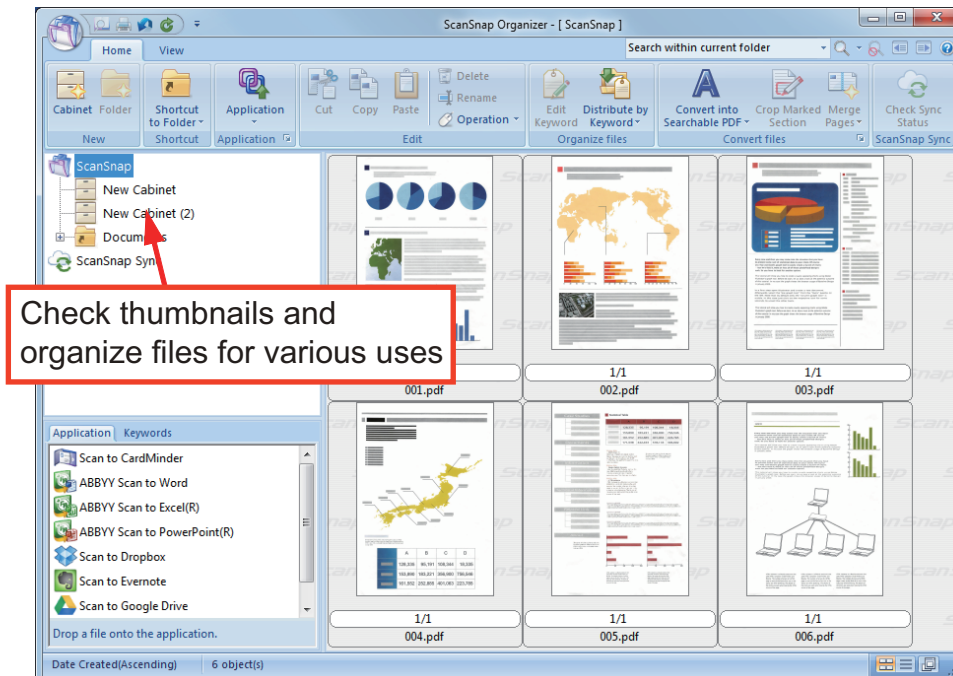

- "Basic Operation Procedure of ScanSnap Organizer" (page 52)
- "Managing Files" (page 54)
- "Using Files" (page 56)

## Basic Operation Procedure of ScanSnap Organizer

This section explains the basic operation procedure of ScanSnap Organizer.

### 1. Start up ScanSnap Organizer.

Start up ScanSnap Organizer by double-clicking the [ScanSnap Organizer] icon on the desktop.

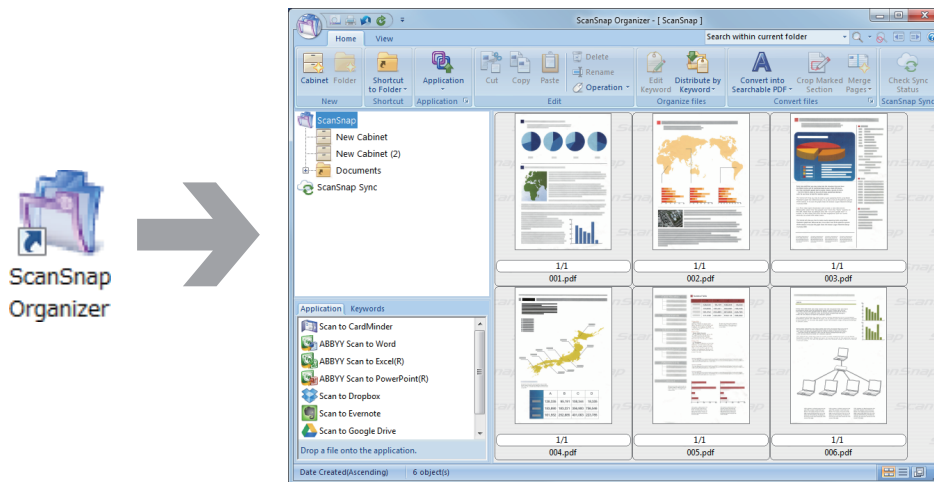

### 2. Scan documents with the ScanSnap.

⇒ A list of scanned images is displayed in ScanSnap Organizer.

### 3. Start up ScanSnap Organizer Viewer.

Double-click a scanned image to start up the Viewer Window for displaying and editing scanned images.

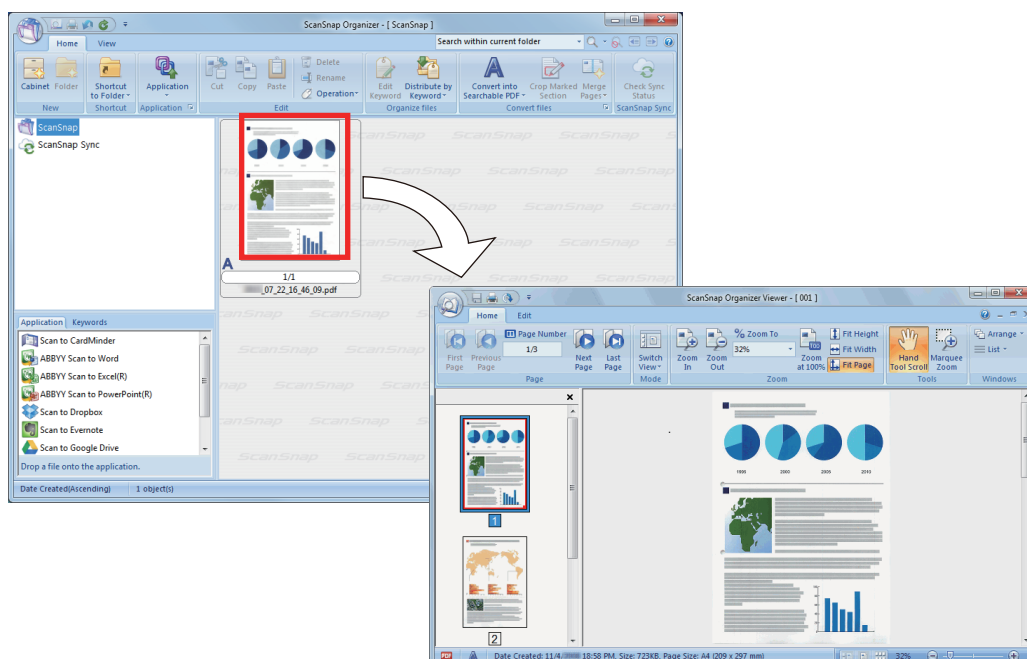

**4. In the Viewer Window, check the orientation of scanned images, and check for unnecessary pages.**

Rotate any scanned images that are not oriented correctly. Delete any unnecessary pages. Make other edits such as inserting a page where necessary.

**5. Exit ScanSnap Organizer Viewer.**

To exit ScanSnap Organizer Viewer, click the Application button and then click the [Exit] button in the menu that appears.

## Managing Files

For details about operations, refer to the ScanSnap Organizer Help.

### Setting Keywords for a File

You can set a character string (keyword) indicating the content of a PDF file so that you can immediately recognize the file without opening it.

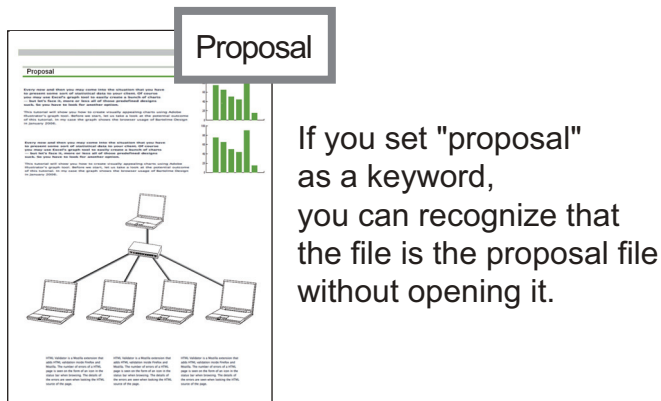

### Setting a Marked Character String as a Keyword

Keywords can be set to a PDF file by using the keyword setting function.

These keywords can be used when you search for PDF files.

When black and white documents that have been marked are scanned by the ScanSnap, the marked character strings are set as keywords for the PDF file.

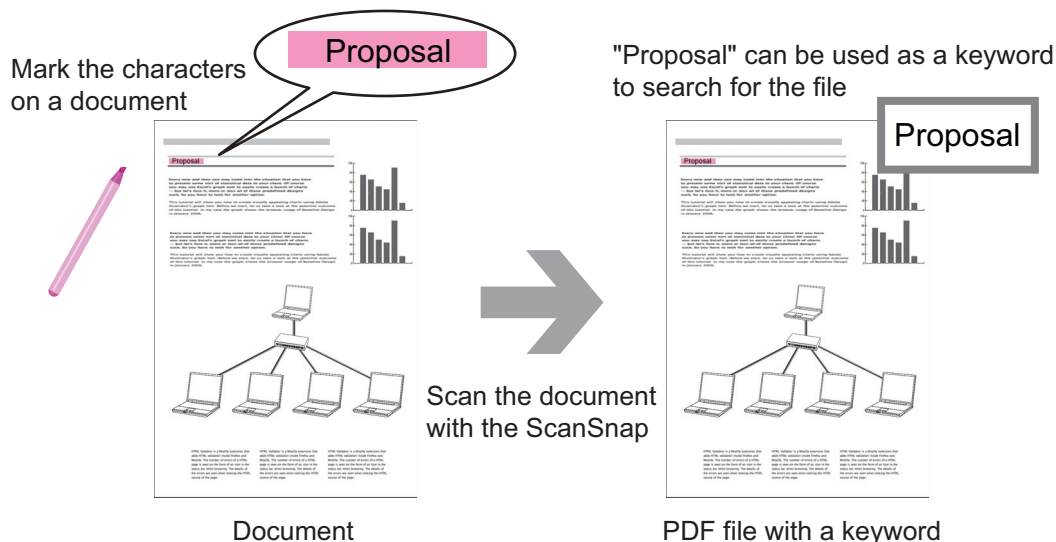

For other keyword setting methods, refer to ScanSnap Organizer Help.

### Recognizing a Character String in a Page to Embed It into the Page

By using text recognition (OCR) software, you can embed character strings into the page of a PDF file scanned by the ScanSnap, and then search the PDF file using the character strings.

OCR recognizes "proposal" as textual information.

Proposal

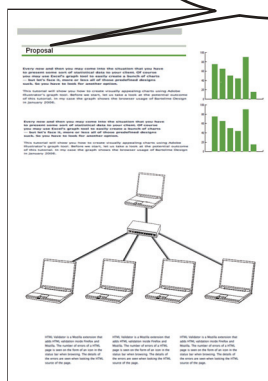

PDF file



"Proposal" can be used as a keyword to search for the file

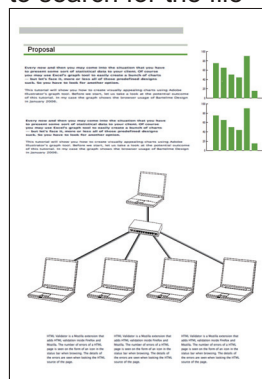

## Searching Files

You can search files that are managed in ScanSnap Organizer.

There are two search methods of Adobe Acrobat search and Windows Desktop Search.

## Automatically Distributing Files According to Set Conditions

You can use the keyword distribution function so that PDF files are automatically distributed into cabinets and folders according to the keywords that have been set.

PDF files with keywords

Main Window

## Using Files

For details about operations, refer to the ScanSnap Organizer Help.

### Linking Files with Other Applications

You can use files with a variety of applications.

The applications that can be used are displayed in the Application List Pane at the lower left corner of the Main Window.

### Sending Files by E-mail

Files can be sent by e-mail.

### Clipping Important Items from Documents

You can use the marked section cropping function to clip important items from documents.

Mark the necessary sections of a black & white document and scan it with the ScanSnap to create a new PDF or JPEG file that contains only the marked section.

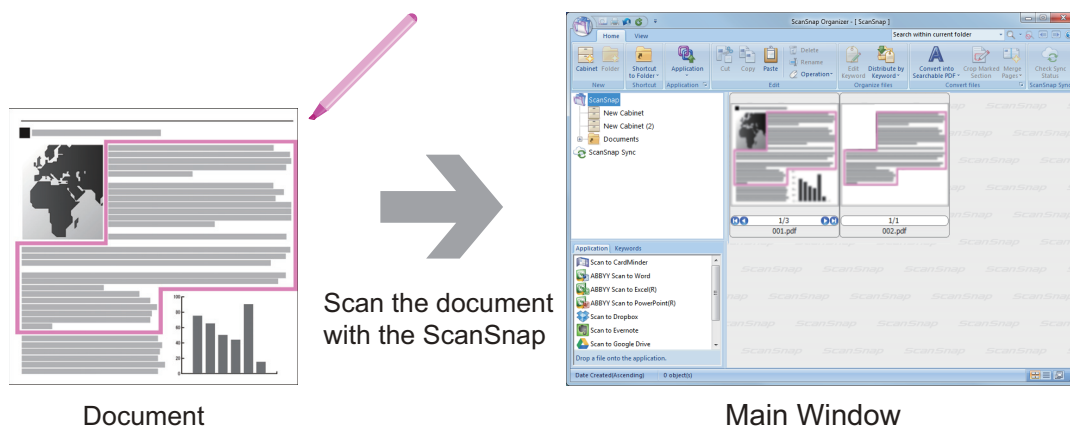

### Using Files by Syncing with a Mobile Device

By using the ScanSnap Sync function, an image file scanned by the ScanSnap can be synced automatically with a mobile device and can be used easily anytime or anywhere via a cloud service.

The files are organized and managed in the "ScanSnap Sync" folder in ScanSnap Organizer.

### Syncing Files Made up of Images That Were Saved Together ("JPEG (Save together)" Files)

Using the ScanSnap Sync function allows you to sync "JPEG (Save together)" files between a mobile device and ScanSnap Organizer.

A "JPEG (Save together)" file consists of multiple images that are scanned with ScanSnap Connect Application.



## What You Can Do with CardMinder

CardMinder is an application used for displaying, organizing, and managing card image data scanned with a scanner.

This application digitalizes large amounts of business cards into images at a high speed and recognizes text on those cards, thus allowing you to search for your clients' business cards from those data quickly, and create your client databases conveniently. CardMinder uses an Optical Character Recognition (OCR) engine to recognize text on cards and shares the data with Personal Information Manager (PIM) applications.

CardMinder contains two separate functions: CardMinder Viewer to enable business card data to be quickly searched from other applications, and CardMinder Mobile Viewer to enable scanned business card data to be viewed on a computer in which CardMinder is not installed.

Card

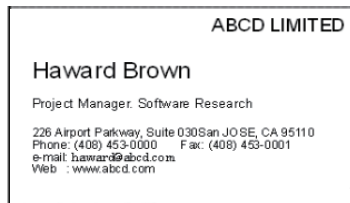

Scan

CardMinder Window

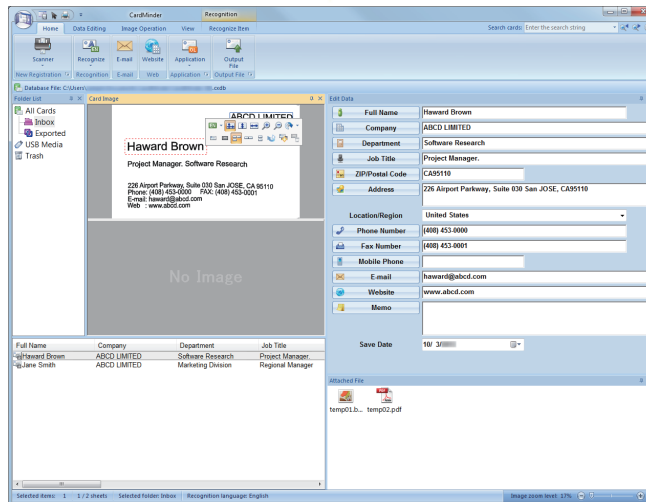

Recognized data

PIM Window  
(Example: Windows Mail (\*))



\*: This is the Windows Vista example.

- "Basic Operation Procedure of CardMinder" (page 59)
- "Linking Card Data with Other Applications" (page 62)
- "Searching Card Data with the Basic Search Toolbar" (page 63)
- "Searching Card Data with CardMinder Viewer" (page 64)
- "Attaching a File to Card Data" (page 65)

## Basic Operation Procedure of CardMinder

This section explains the basic operation procedure of CardMinder.

### 1. Start CardMinder.

Start up CardMinder by double-clicking the [CardMinder] icon on the desktop.

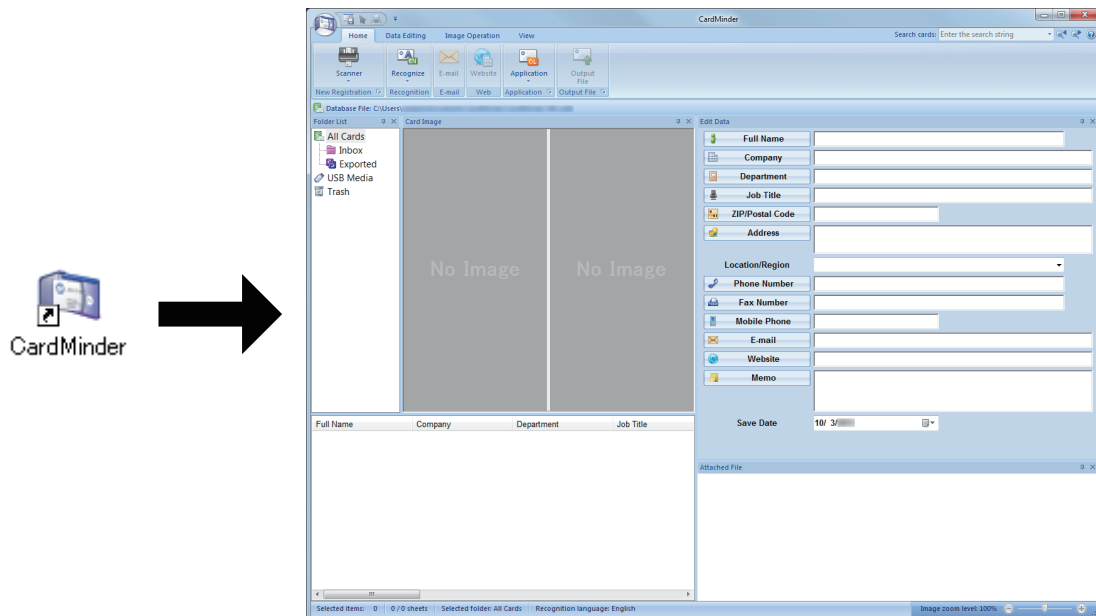

### 2. Scan a card with the scanner.

Click the [Scanner] button on the [Home] tab to start scanning a card.

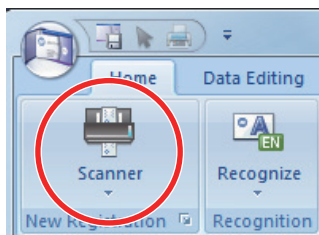

When scanning is complete, the information printed on the card (such as name, company, and address) is automatically recognized as text and displayed in the Edit Data pane.

The image data scanned from the card is displayed in the Card Image pane.

#### ATTENTION

ScanSnap Manager must be installed on your computer when you want to recognize the following languages:

- Chinese (simplified)
- Chinese (traditional)
- Korean

### 3. Check the card data.

Make sure that the front and back card images are correct, and that the text on the card images are displayed correctly in the Edit Data pane.



Card Image Pane

Edit Data Pane

#### 4. If the language to be used for text recognition is different, perform text recognition again in the following procedure:

1. Click  on the [Home] tab.
  - ⇒ The recognized languages are displayed.
2. Select a language for the character strings to be recognized.
  - ⇒ The icon for the [Recognize] button changes to the selected language.
3. Click the icon for the [Recognize] button.



Example: To recognize English, click .

⇒ A confirmation message for the recognition process is displayed.

4. Click the [Yes] button.
  - ⇒ Character strings on the card data will be recognized as the selected language.

#### 5. Correct the card data, if necessary.

The card data can be corrected in the following ways. For details, refer to the CardMinder Help.

- Redoing the recognition process on the character strings in the selected areas
- Entering text directly in the Edit Data pane
- Correcting the orientation of the card image or switching the front and back images

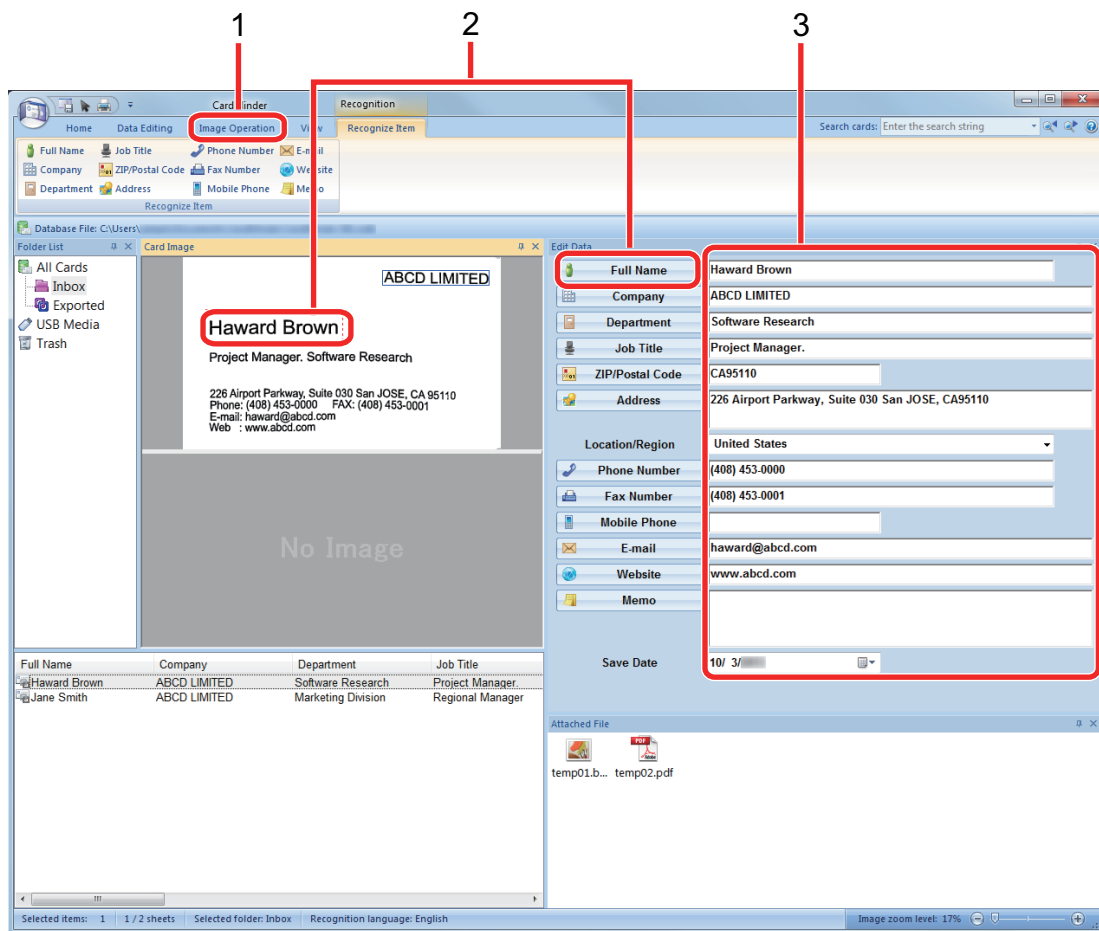

No.	Description
1	In the [Image Operation] tab, you can perform corrections, such as rotating the card image or switching the front and back images.
2	By selecting character strings in the card image and then clicking the buttons of the appropriate fields in the Edit Data pane, you can redo the recognition process on the selected areas.
3	You can directly correct the text of each field in the Edit Data pane.

## 6. Exit CardMinder.

To exit CardMinder, click the application button and then click the [Exit] button in the menu that appears.

## Linking Card Data with Other Applications

Click the following buttons on the [Home] tab to use card data in a variety of applications.

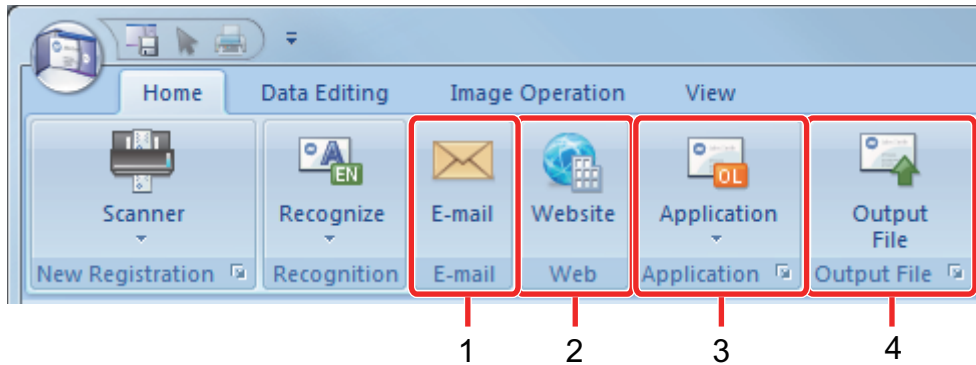

No.	Item	Description
1	E-mail	You can start an e-mail program, using the e-mail address specified in [E-mail] for the card data as the destination address.
2	Internet search	You can search the URL specified in [Website] for the card data with a web browser.
3	Linking card data with another application	You can link card data with another application such as Outlook Express or Salesforce CRM to use the card data in the linked application. You can also link card data with USB media to use the card data on a different computer.
4	Outputting card data in a different format	You can output card data in the vCard, CSV, text, or ContactXML format.

For details, refer to CardMinder Help.

---

## Searching Card Data with the Basic Search Toolbar

This section explains how to search card data with the CardMinder Basic Search Toolbar.

### Search cards (Basic Search Toolbar)

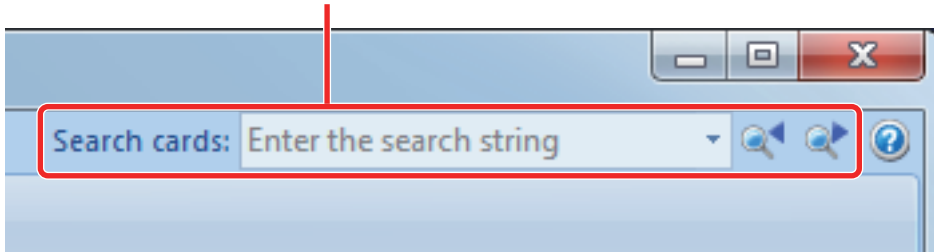

To search card data, type in a search term (such as an individual name or a company name) in the Basic Search Toolbar.

The search results are displayed in the main window.

If multiple cards match the search conditions, click  to display the next result of the search in the main window.

---

## Searching Card Data with CardMinder Viewer

This section explains how to search card data with CardMinder Viewer.

Even when CardMinder is not running, you can search card data by using a character string in another application (such as Microsoft Notepad) as the keyword for searching.

- 1. Drag the mouse to select a character string you want to search for.**
- 2. Press [Alt] + [F3] keys on the keyboard at the same time.**
  - ⇒ CardMinder Viewer starts and the card data found, based on the search conditions entered (such as an individual name and a company name), is displayed in the window.

If multiple cards match the search conditions, click  to display the next result of the search in the CardMinder Viewer window.

### HINT

Click  to display in the CardMinder window the details of the card data selected in the CardMinder Viewer window.



## Attaching a File to Card Data

A file can be attached to card data easily by dragging and dropping it.

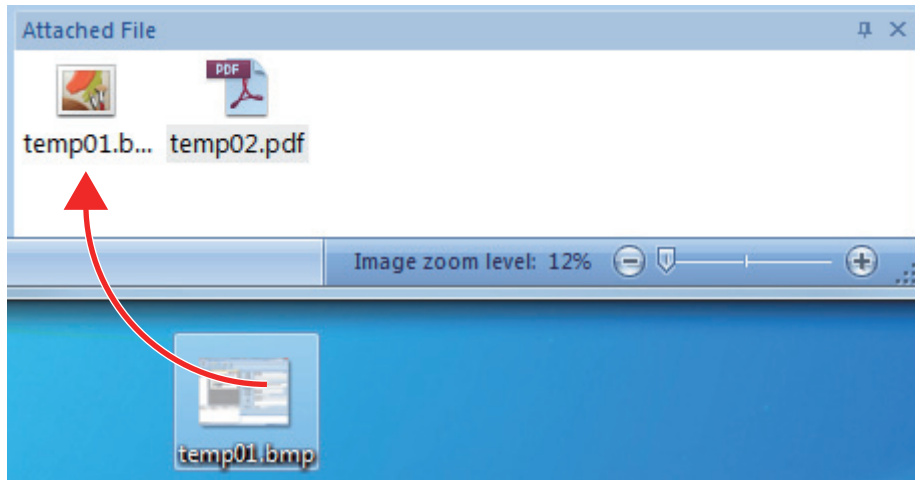

# Useful Usages

This section explains how to use related software for the scanned image that is created after a document is scanned with the ScanSnap and how to scan a document with a setting other than the default setting.

- ["Managing Paper Documents by Folder on a Computer" \(page 67\)](#)
- ["Saving Business Cards to a Computer" \(page 70\)](#)

# Managing Paper Documents by Folder on a Computer

This section explains how to digitize paper documents and manage the data by folder in ScanSnap Organizer.

## 1. Scan a paper document with the ScanSnap.

For details about scanning a document, refer to "Scanning a Document" (page 17).

⇒ The Quick Menu appears.



## 2. Click the [ScanSnap Organizer] icon in the Quick Menu.

⇒ The [ScanSnap Organizer] window appears.

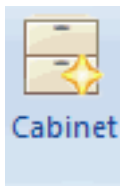
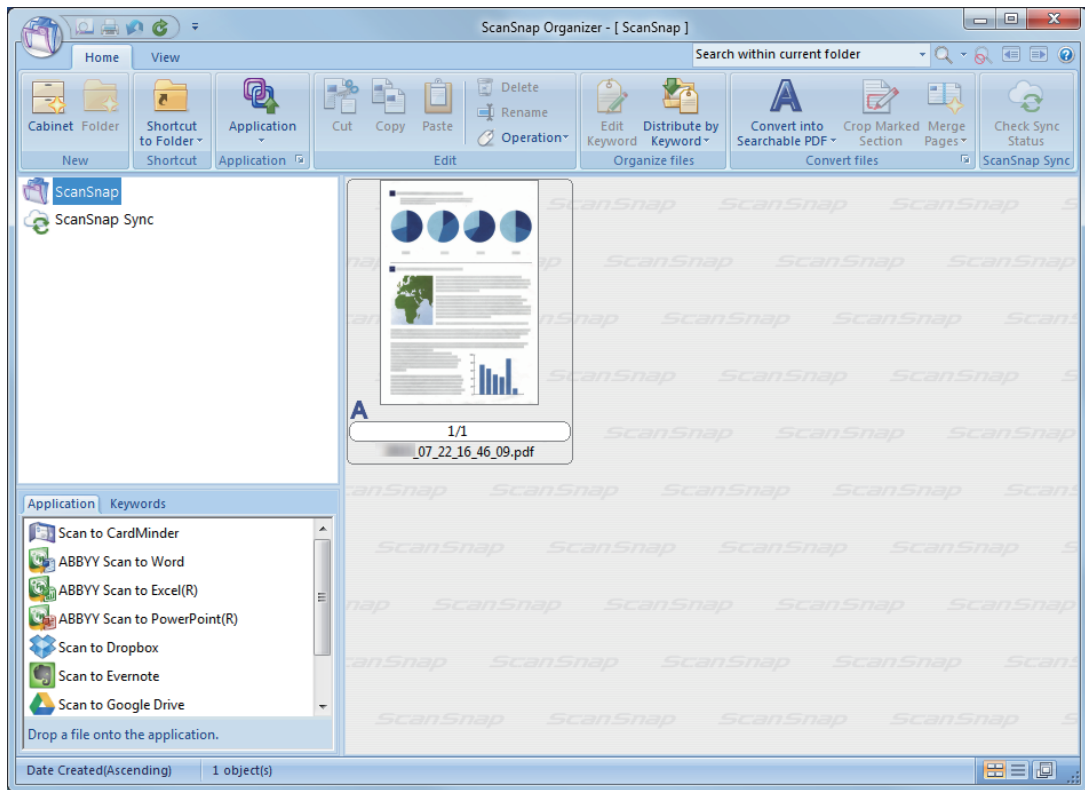

3. Click **Cabinet** on the [Home] tab.

⇒ A new cabinet is created in the folder list.

4. Rename the created cabinet.

#### HINT

To create multiple cabinets, repeat steps 3 to 4.

5. Select the scanned image from the file list, and drag and drop it to the cabinet.

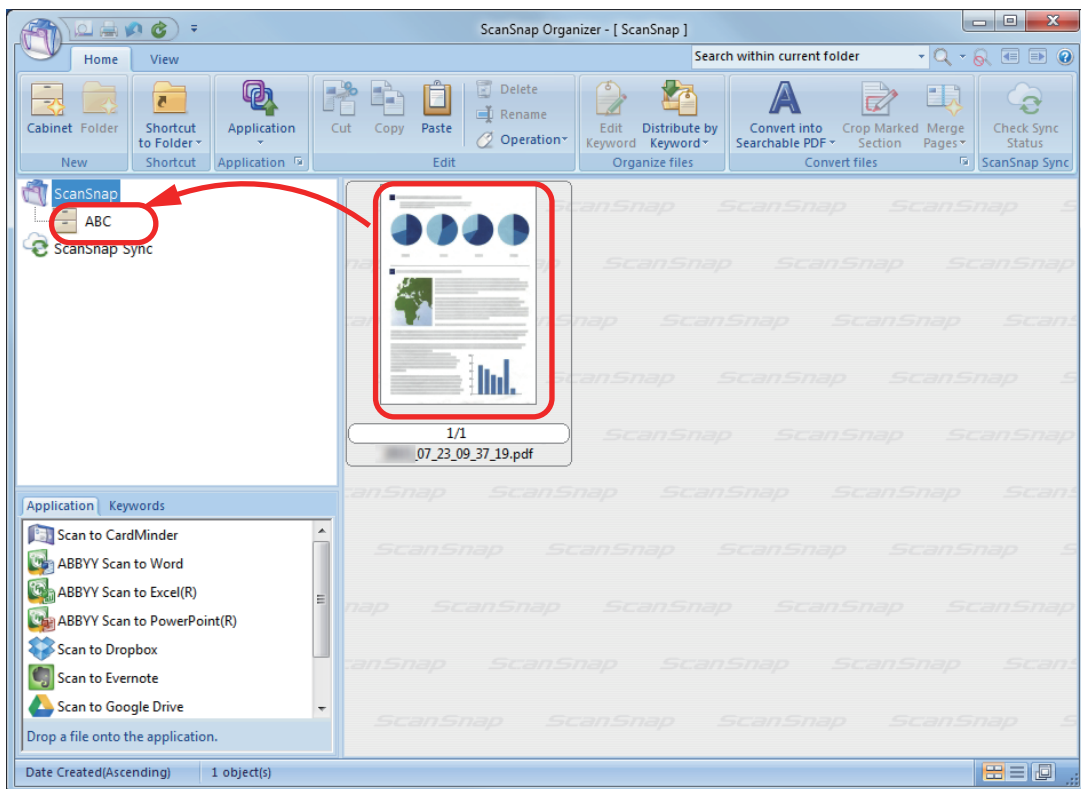

⇒ The scanned image is moved to the cabinet.

#### HINT

ScanSnap Organizer has various functions for using saved files.  
For details, refer to the ScanSnap Organizer Help.

# Saving Business Cards to a Computer

This section explains how to digitize business cards and save the card data in CardMinder.

## ATTENTION

If you do not log on as a user with Administrator privileges, you may not be able to link the ScanSnap with another application properly.

### 1. Scan business cards with the ScanSnap.

For details about scanning business cards, refer to "Scanning a Document" (page 17).

⇒ The Quick Menu appears.



### 2. Click the [Scan to CardMinder] icon in the Quick Menu.

⇒ The [CardMinder] window appears.

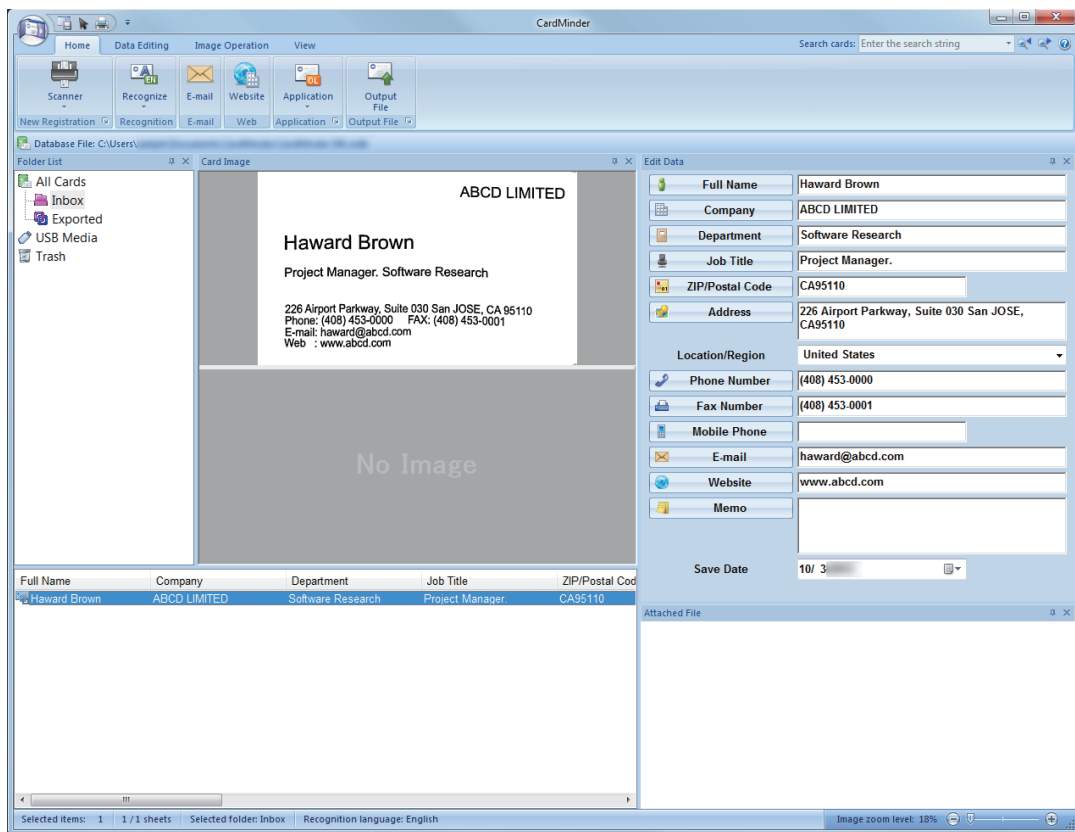

### 3. Check the card data.

Make sure that the text on the card images are displayed correctly in the Edit Data pane. If the card data must be corrected, click the text to be corrected and then directly edit it.



Card Image Pane

Edit Data Pane

#### HINT

When you scan double-sided business cards, you must scan one side of each card and edit the card data in CardMinder.

For details, refer to the CardMinder Help.

# Troubleshooting

This section explains how to solve troubles you may encounter upon installing or uninstalling the software related to the ScanSnap.

- "How to Find Your Solution" (page 73)
- "If Your First Attempt to Install Failed" (page 74)
- "If You Have Installed the Software Before" (page 75)
- "When the ScanSnap Manager Icon Does Not Appear" (page 83)
- "When ScanSnap Manager Does Not Operate Normally" (page 85)
- "When You Cannot Uninstall the Software" (page 93)

For details about the troubles you may encounter and the solutions while using the ScanSnap, refer to the following:

- "Troubleshooting" in the ScanSnap Manager Help

To display this section, right-click the ScanSnap Manager icon  in the notification area, and select [Help] → [Troubleshooting] from the "Right-Click Menu" (page 39).

- ScanSnap Support Site (<http://scansnap.fujitsu.com/g-support/en/>)

If you cannot solve the problem after referring to the above section, contact your FUJITSU scanner dealer or an authorized FUJITSU scanner service provider.



# How to Find Your Solution

When software installation fails, or the ScanSnap does not operate normally after installation is complete, refer to the flow chart below for troubleshooting.

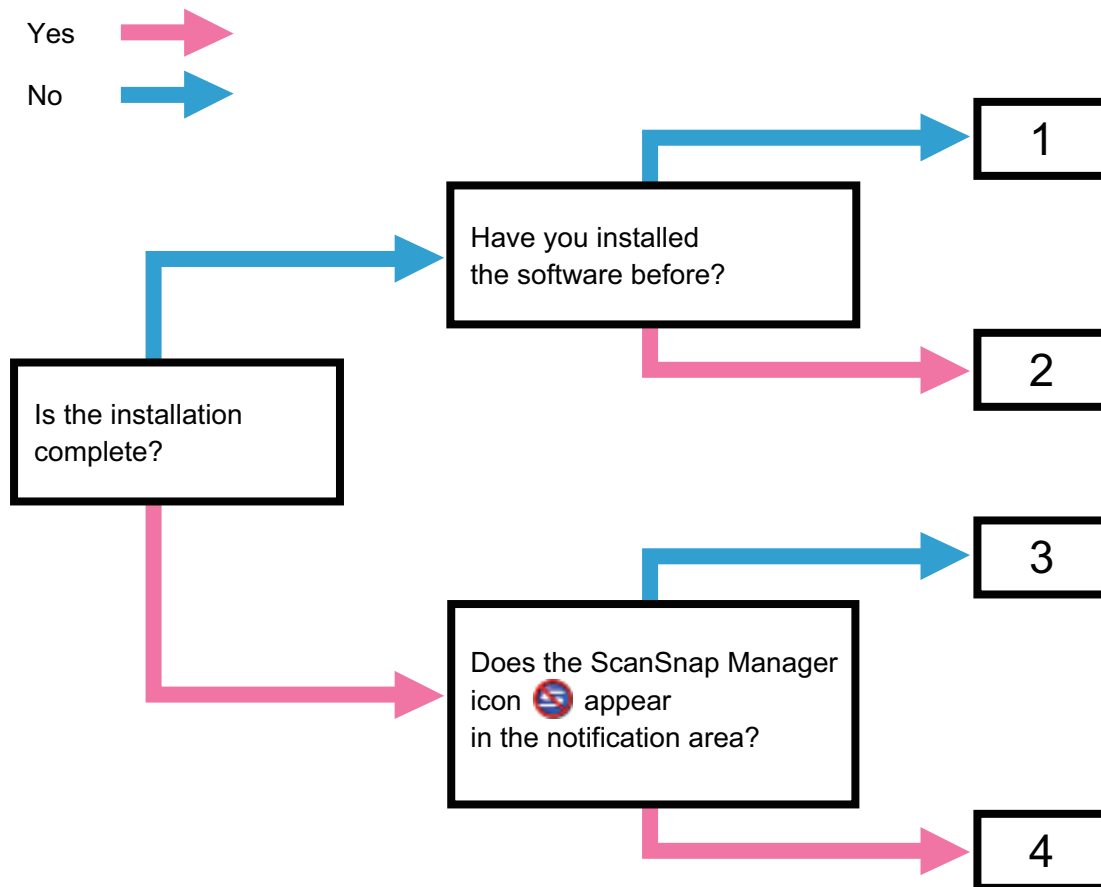

No.	Topic to Be Referred to
1	"If Your First Attempt to Install Failed" (page 74)
2	"If You Have Installed the Software Before" (page 75)
3	"When the ScanSnap Manager Icon Does Not Appear" (page 83)
4	"When ScanSnap Manager Does Not Operate Normally" (page 85)

## If Your First Attempt to Install Failed

This section explains how to troubleshoot when the first attempt to install the software related to the ScanSnap failed.

If any software related to the ScanSnap (including models other than S1300i) has been installed before, refer to ["If You Have Installed the Software Before"](#) (page 75).

- 1. Restart the computer and log on as a user with Administrator privileges.**
- 2. Reinstall the software.**

For details, refer to ["How to Install the Software"](#) (page 37).

## If You Have Installed the Software Before

This section explains how to troubleshoot if your attempt to reinstall the software related to the ScanSnap (including models other than S1300i) failed.

- ["Uninstalling the Software" \(page 76\)](#)
- ["Removing the Installation Information" \(page 77\)](#)
- ["Installing the Software from the \[ScanSnap Setup\] Window" \(page 81\)](#)
- ["Installing One Software at a Time" \(page 82\)](#)

## Uninstalling the Software

Uninstall the software that is already installed.

The uninstallation procedure is as follows.

- 1. If the ScanSnap is connected to the computer, unplug the USB cable from the computer.**
- 2. Log on as a user with Administrator privileges.**
- 3. If anti-virus software is running, disable the software temporarily.**

### ATTENTION

If you cannot disable the anti-virus software, check if the software is set to lock the application.

- 4. Uninstall the software.**

The following software programs must be uninstalled:

- ScanSnap Manager
- ScanSnap Organizer
- CardMinder

For details, refer to "[Uninstalling the Software](#)" (page 115).

- If the software was successfully uninstalled, proceed to "[Installing the Software from the \[ScanSnap Setup\] Window](#)" (page 81).
- If the software still remains in the list, proceed to the next topic "[Removing the Installation Information](#)" (page 77).

---

## Removing the Installation Information

If the name of the software that you tried to uninstall still remains in the list in [Programs and Features] of the Control Panel, or if the software cannot be uninstalled for some reason, the installation information needs to be removed.

Remove the installation information in the following procedure.

### ATTENTION

If you cannot successfully remove the installation information, contact your FUJITSU scanner dealer or an authorized FUJITSU scanner service provider.

- 1. Log on as a user with Administrator privileges.**
- 2. Insert the Setup DVD-ROM into the DVD-ROM drive.**
  - ⇒ The [ScanSnap Setup] window appears.
- 3. Click the [Close] button to close the [ScanSnap Setup] window.**
- 4. Start up the tool for removing the installation information.**
  - Windows 10/Windows 8.1/Windows 8/Windows 7/Windows Vista
    1. From Windows Explorer, open the [Tool] folder in the Setup DVD-ROM.
    2. Right-click "SSClean.exe" and select [Run as administrator] from the displayed menu.
      - ⇒ The [User Account Control] window appears.
    3. Click the [Yes] button ([Continue] button in Windows Vista).
      - ⇒ The [Remove Installation Information] window appears.
  - Windows XP
    1. From Windows Explorer, open the [Tool] folder in the Setup DVD-ROM and double-click "SSClean.exe".
      - ⇒ The [Remove Installation Information] window appears.
- 5. Select the software from which you want to remove the installation information.**
  - ScanSnap Manager
    1. Select [ScanSnap Manager] and click the [Remove] button.

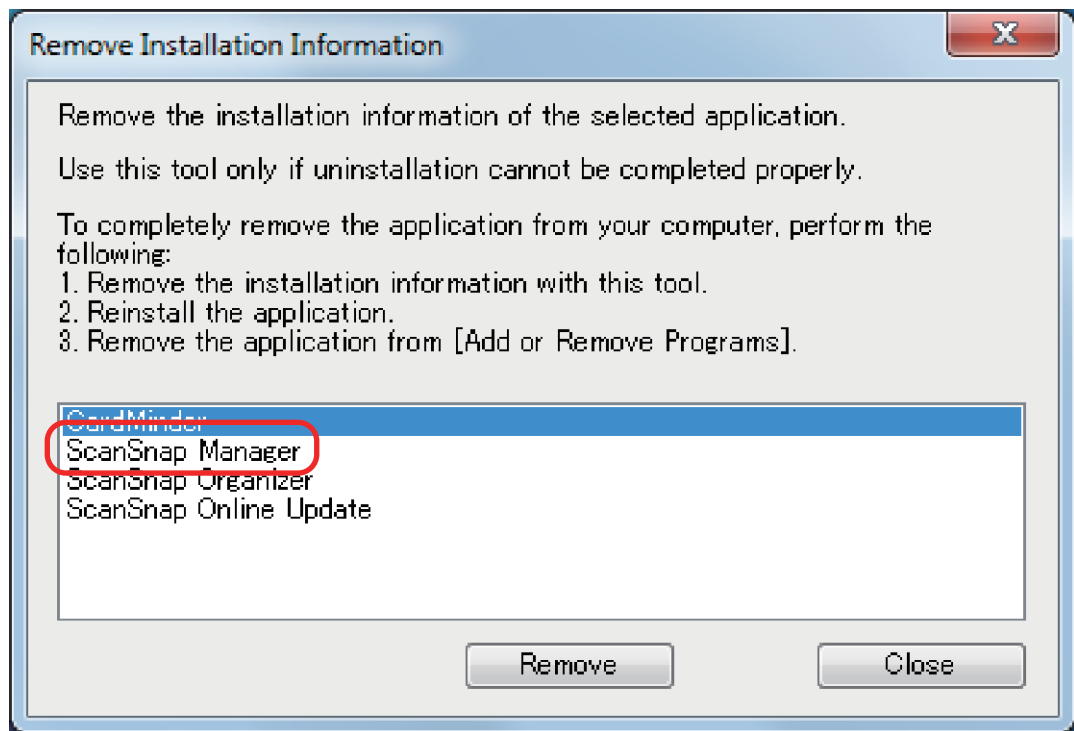

⇒ A confirmation message appears.

2. Click the [Yes] button.

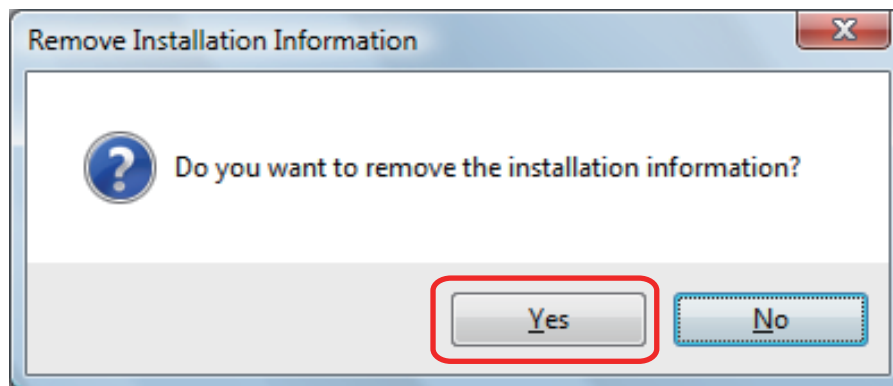

⇒ A message appears to check whether or not to remove the profile information.

3. Click the [Yes] button to remove and the [No] button to keep the profile information.

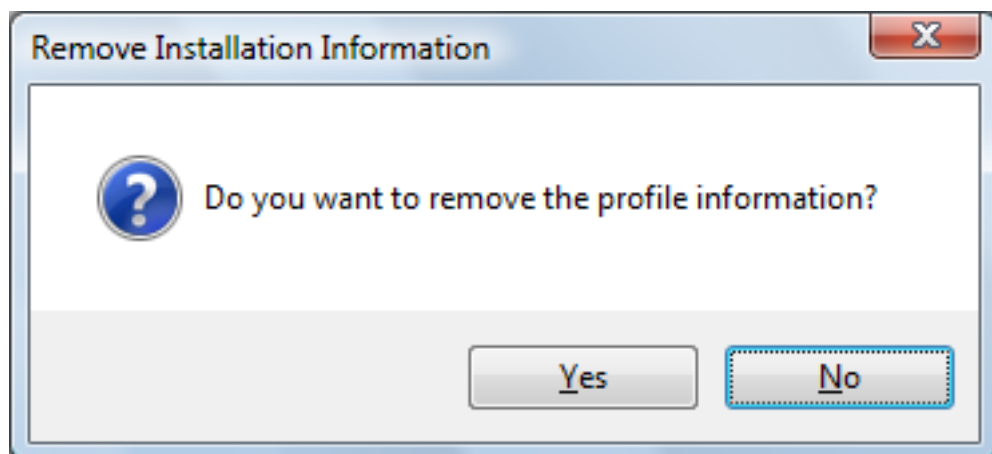

**ATTENTION**

If the problem persists when you kept the profile information then reinstalled the software, try again after removing the profile information.

⇒ The installation information is removed, and the following message appears.

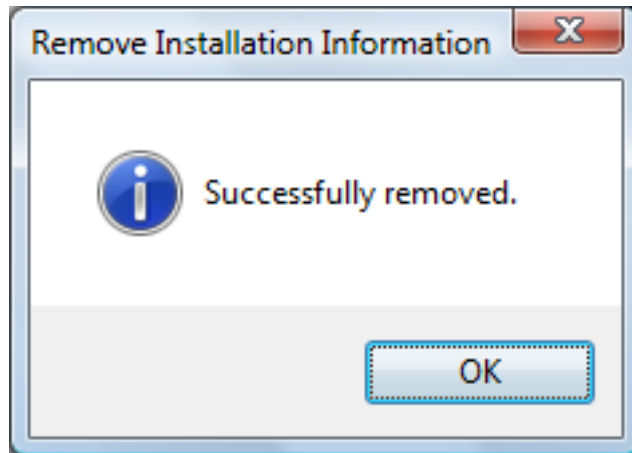

4. Click the [OK] button to close the [Remove Installation Information] window.
- ScanSnap Organizer/CardMinder/ScanSnap Online Update
  1. Select [ScanSnap Organizer], [CardMinder], or [ScanSnap Online Update], and click the [Remove] button.

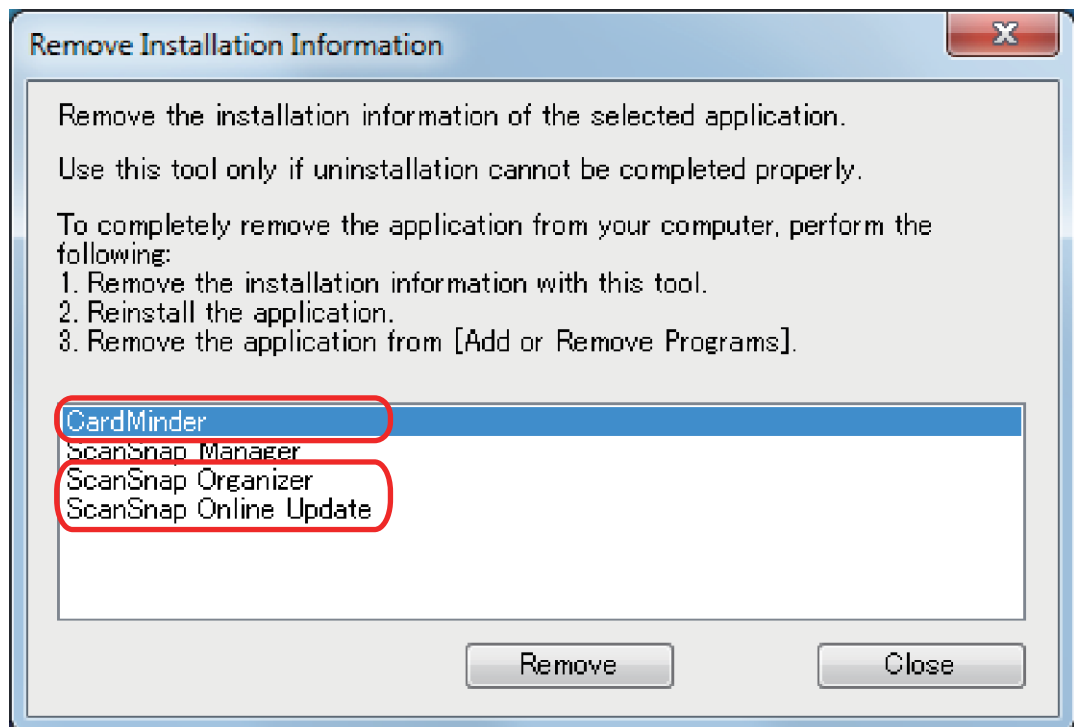

⇒ A confirmation message appears.

2. Click the [Yes] button.

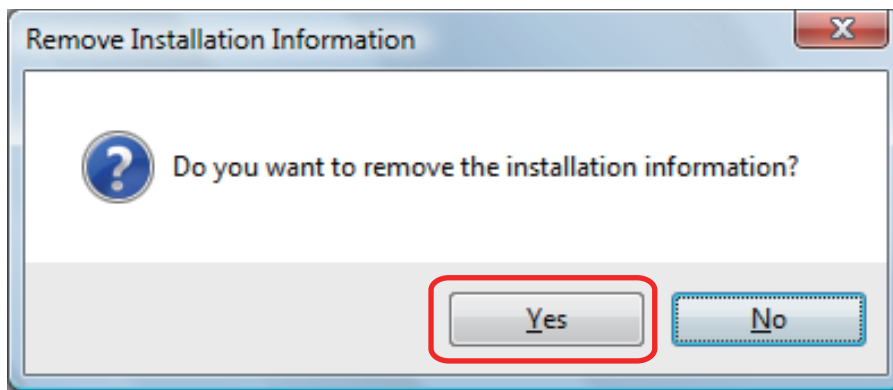

⇒ The installation information is removed, and the following message appears.

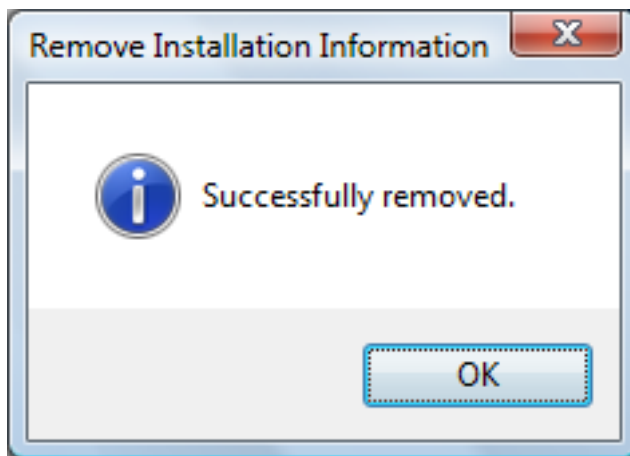

3. Click the [OK] button to close the [Remove Installation Information] window.
- 6. By repeating step 5, remove the installation information of all the software listed in the [Remove Installation Information] window.**
- 7. Click the [Close] button to close the [Remove Installation Information] window.**
- 8. Confirm that the installation folder no longer exists.**

If the [ScanSnap] folder remains in the following location, rename the folder (such as [-ScanSnap]). This folder can later be deleted once the installation is successfully completed.

Path: *DriveName (such as C):\Program Files\PFU*

After completing the procedure, proceed to "Installing the Software from the [ScanSnap Setup] Window" (page 81).



---

## Installing the Software from the [ScanSnap Setup] Window

Once the software is uninstalled or the installation information is removed, install the software from the [ScanSnap Setup] window.

Install the software in the following procedure.

- 1. Restart the computer.**
- 2. Log on as a user with Administrator privileges.**
- 3. If anti-virus software is running, disable the software temporarily.**

### ATTENTION

If you cannot disable the anti-virus software, check if the software is set to lock the application.

- 4. Install the software.**

For details, refer to ["How to Install the Software" \(page 37\)](#).

If you did not perform the procedure in ["Removing the Installation Information" \(page 77\)](#) and then failed to install the software, perform the following procedures again:

- ["Uninstalling the Software" \(page 76\)](#)
- ["Removing the Installation Information" \(page 77\)](#)
- ["Installing the Software from the \[ScanSnap Setup\] Window" \(page 81\)](#)

If you still could not reinstall the software after performing the above procedures, proceed to ["Installing One Software at a Time" \(page 82\)](#).

---

## Installing One Software at a Time

Install the software one by one in the following procedure.

- 1. Restart the computer.**
- 2. Log on as a user with Administrator privileges.**
- 3. If anti-virus software is running, disable the software temporarily.**

### ATTENTION

If you cannot disable the anti-virus software, check if the software is set to lock the application.

- 4. Insert the Setup DVD-ROM into the DVD-ROM drive.**

⇒ The [ScanSnap Setup] window appears.

- 5. Click the [Close] button to close the [ScanSnap Setup] window.**

- 6. Install the software.**

Open the Setup DVD-ROM from Windows Explorer, and run the "setup.exe" of each software.

- ScanSnap Manager  
*DVD-ROMDrive:\Software\ScanSnap\setup.exe*
- ScanSnap Organizer  
*DVD-ROMDrive:\Software\Organizer\setup.exe*
- CardMinder  
*DVD-ROMDrive:\Software\Card\setup.exe*

Install one of the software above, and then install the following application.

- ScanSnap Online Update  
*DVD-ROMDrive:\Software\Online Update\setup.exe*

⇒ The setup window appears.

Follow the instructions on the screen to continue with the installation.

If you cannot proceed further because a message appears to indicate that the software is already installed, start over again from the procedure in "[Uninstalling the Software](#)" (page 76).

### ATTENTION

If the "setup.exe" for a software program is not included in the Setup DVD-ROM, download the installer for the software program from the following web page, then install it.

<http://scansnap.fujitsu.com/g-support/en/>

- 7. Restart the computer.**

## When the ScanSnap Manager Icon Does Not Appear

This section explains how to troubleshoot when the ScanSnap Manager icon  does not appear in the notification area even though the software is installed and the ScanSnap is connected to the computer.

- ["Displaying the ScanSnap Manager Icon" \(page 84\)](#)

## Displaying the ScanSnap Manager Icon

### 1. Start ScanSnap Manager.

- Windows 10  
Select [Start] menu → [All apps] → [ScanSnap Manager] → [ScanSnap Manager].
- Windows 8.1  
Click  on the lower left side of the Start screen, and select [ScanSnap Manager] under [ScanSnap Manager] on the All apps screen.
- Windows 8  
Right-click the Start screen, and select [All apps] on the app bar → [ScanSnap Manager] under [ScanSnap Manager].
- Windows 7/Windows Vista/Windows XP  
Select [Start] menu → [All Programs] → [ScanSnap Manager] → [ScanSnap Manager].

#### HINT

If the problem is solved, you can change the setting so that ScanSnap Manager will start up automatically from the next time you log on to the computer. The procedure is as follows.

1. ⇨ The [ScanSnap Manager - Preferences] window appears.
2. In the [Auto Startup] list, select the [Start up ScanSnap Manager when you log on] checkbox.

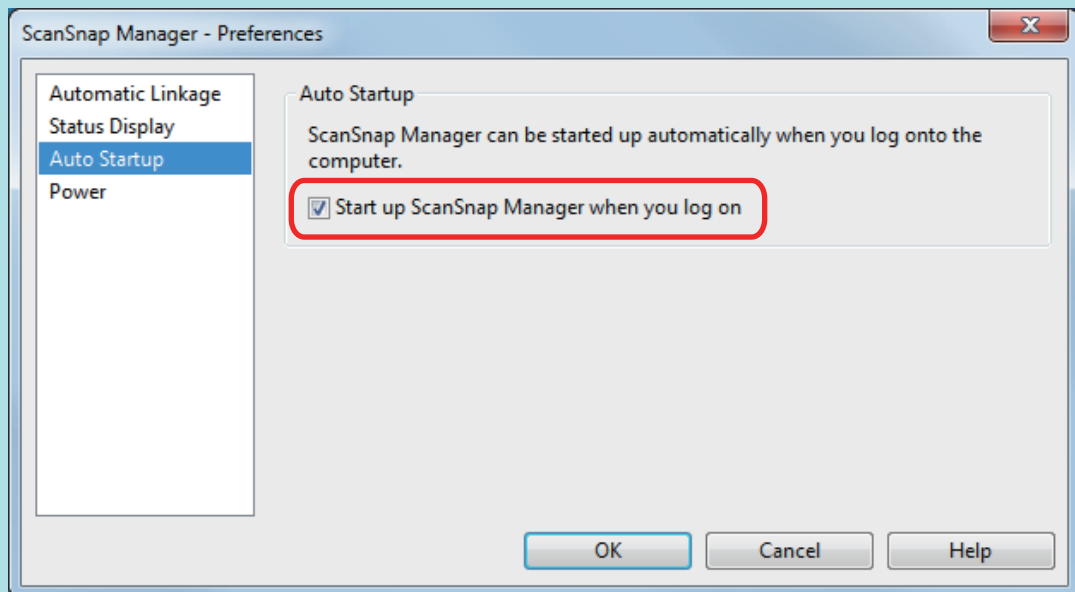

If the problem persists, refer to "When ScanSnap Manager Does Not Operate Normally" (page 85).

## When ScanSnap Manager Does Not Operate Normally

If the ScanSnap Manager icon in the notification area located at the far right of the taskbar is displayed as  even though the software is installed and the ScanSnap is connected to the computer, perform the following procedures.

- ["Removing Unnecessary Icons from the Notification Area" \(page 86\)](#)
- ["Checking the Connection between the ScanSnap and the Computer" \(page 87\)](#)
- ["Checking If ScanSnap Manager Is Operating Normally" \(page 88\)](#)
- ["Removing the ScanSnap's Connection Information" \(page 91\)](#)

---

## Removing Unnecessary Icons from the Notification Area

**1. Check the software icons in the notification area, and exit the software that you are not using.**

⇒ The icon is removed from the notification area.

**2. Right-click the ScanSnap Manager icon  in the notification area and select [Exit] from the "Right-Click Menu" (page 39).**

**3. Start ScanSnap Manager.**

- Windows 10

Select [Start] menu → [All apps] → [ScanSnap Manager] → [ScanSnap Manager].

- Windows 8.1

Click  on the lower left side of the Start screen, and select [ScanSnap Manager] under [ScanSnap Manager] on the All apps screen.

- Windows 8

Right-click the Start screen, and select [All apps] on the app bar → [ScanSnap Manager] under [ScanSnap Manager].

- Windows 7/Windows Vista/Windows XP

Select [Start] menu → [All Programs] → [ScanSnap Manager] → [ScanSnap Manager].

If the problem persists, refer to " <a href="#">Checking the Connection between the ScanSnap and the Computer</a> " (page 87).
--

---

## Checking the Connection between the ScanSnap and the Computer

- 1. Unplug the USB cable from the computer and the ScanSnap, then plug it back in.**

Make sure to leave at least 5 seconds between unplugging and plugging the cable.

If you are using a USB hub, connect the USB cable to the computer directly.

If the problem persists, refer to " <a href="#">Checking If ScanSnap Manager Is Operating Normally</a> " (page 88).
---

## Checking If ScanSnap Manager Is Operating Normally

### 1. Turn off the ScanSnap and then turn it on again.

Make sure to leave at least 5 seconds between turning off and on the ScanSnap.

If the problem persists, proceed to step 2.

### 2. If you are using a USB hub, connect the ScanSnap to the computer directly with a USB cable.

If the problem persists, proceed to step 3.

### 3. If there is more than one USB port on the computer, connect the USB cable to a different USB port.

If the problem persists, proceed to step 4.

### 4. If a USB device other than the ScanSnap is connected to the computer, disconnect it.

If the problem persists, proceed to step 5.

### 5. If anti-virus software is running, disable the software temporarily.

#### ATTENTION

If you cannot disable the anti-virus software, check if the software is set to lock the application.

If the problem persists, proceed to step 6.

### 6. Check the privileges to access the installation files.

#### 1. Start the ScanSnap Support Tool.

- Windows 10

Select [Start] menu → [All apps] → [ScanSnap Manager] → [ScanSnap Support Tool].

- Windows 8.1

Click  on the lower left side of the Start screen, and select [ScanSnap Support Tool] under [ScanSnap Manager] on the All apps screen.

- Windows 8

Right-click the Start screen, and select [All apps] on the app bar → [ScanSnap Support Tool] under [ScanSnap Manager].

- Windows 7/Windows Vista/Windows XP

Select [Start] menu → [All Programs] → [ScanSnap Manager] → [ScanSnap Support Tool].

⇒ The [ScanSnap Support Tool] window appears.



- Click the [Check] button on the [Recover] tab, and proceed by following the instructions displayed on the screen.

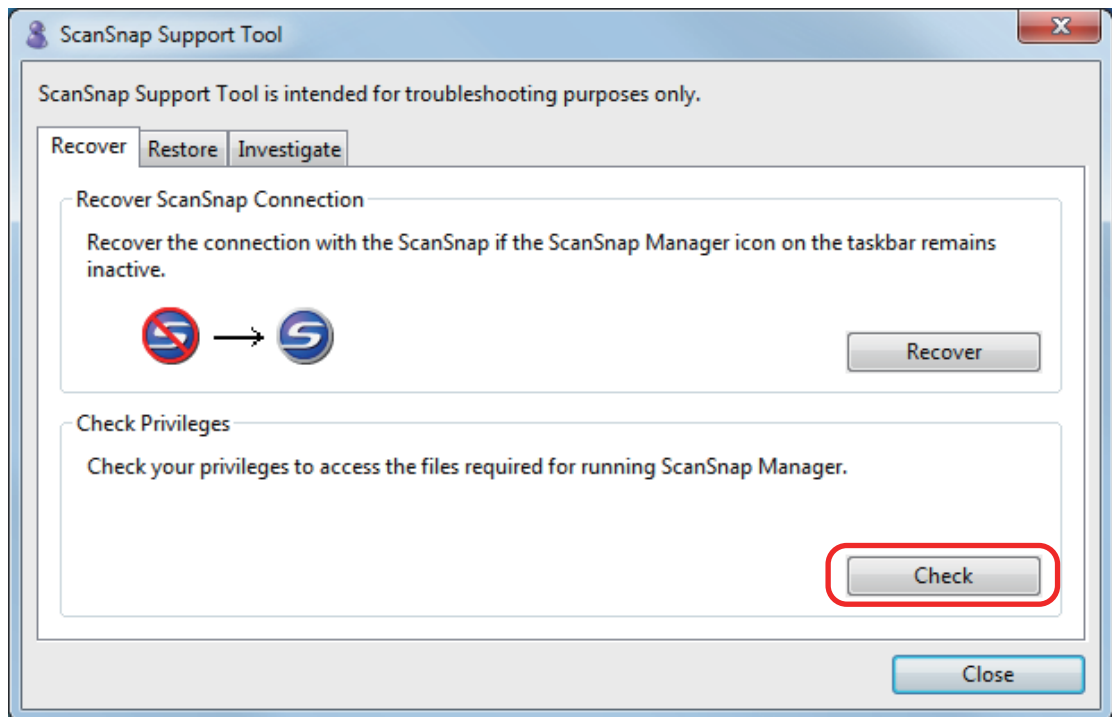

- ⇒ If the message "The recommended privileges have been applied." appears, turn off the ScanSnap and then turn it on again. Make sure to leave at least 5 seconds between turning off and on the ScanSnap.

If the message "Failed to change the privileges. Uninstall ScanSnap Manager then install it again." appears or the problem still persists, proceed to step 7.

## 7. Recover the connection with the ScanSnap.

- Start the ScanSnap Support Tool.
  - Windows 10  
Select [Start] menu → [All apps] → [ScanSnap Manager] → [ScanSnap Support Tool].
  - Windows 8.1  
Click  on the lower left side of the Start screen, and select [ScanSnap Support Tool] under [ScanSnap Manager] on the All apps screen.
  - Windows 8  
Right-click the Start screen, and select [All apps] on the app bar → [ScanSnap Support Tool] under [ScanSnap Manager].
  - Windows 7/Windows Vista/Windows XP  
Select [Start] menu → [All Programs] → [ScanSnap Manager] → [ScanSnap Support Tool].

⇒ The [ScanSnap Support Tool] window appears.
- Click the [Recover] button on the [Recover] tab, and proceed by following the instructions displayed on the screen.

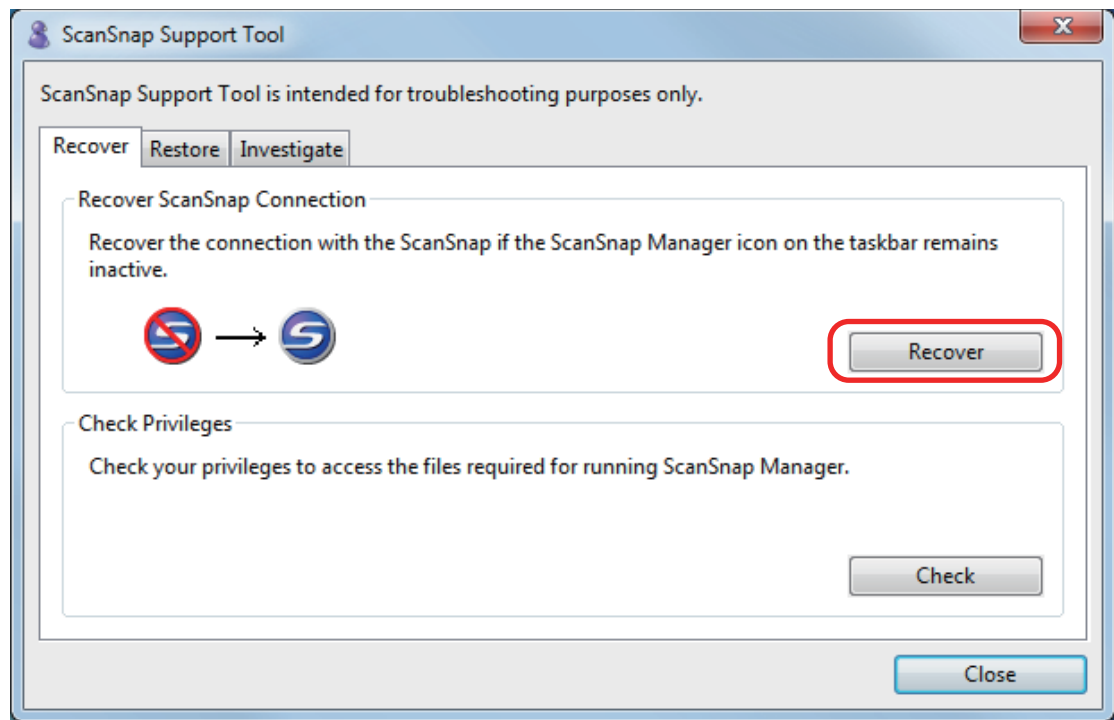



**8. Turn off the ScanSnap and restart the computer.**

If the problem persists, refer to ["Removing the ScanSnap's Connection Information"](#) (page 91).

---

## Removing the ScanSnap's Connection Information

The ScanSnap might have been connected to the computer before the software was installed. In this case, the ScanSnap's connection information needs to be removed. Remove the ScanSnap's connection information in the following procedure.

- 1. Connect the ScanSnap to the computer, and turn on the ScanSnap.**
- 2. Open Device Manager.**
  - Windows 10  
Right-click the [Start] menu and select [Device Manager].
  - Windows 8.1  
Click  on the lower left side of the Start screen → [Control Panel] under [Windows System] → [Hardware and Sound] → [Device Manager].
  - Windows 8  
Right-click the Start screen, and select [All apps] on the app bar → [Control Panel] under [Windows System] → [Hardware and Sound] → [Device Manager].
  - Windows 7  
Select [Start] menu → [Control Panel] → [Hardware and Sound] → [Device Manager].
  - Windows Vista  
Select [Start] menu → [Control Panel] → [System and Maintenance] → [Device Manager].
- 3. Select [Imaging devices] and right-click on [ScanSnap S1300i] (or [Other devices] → [ScanSnap S1300i]), and then select [Uninstall] from the displayed menu.**
- 4. If other USB ports have been used to connect to the ScanSnap, perform steps 1 to 3 for each of the ports.**
- 5. Turn off the ScanSnap.**
- 6. Unplug the USB cable from the computer.**
- 7. Restart the computer.**
- 8. Connect the USB cable to the computer.**
- 9. Turn on the ScanSnap.**
  - ⇒ The ScanSnap Manager icon appears in the notification area. Make sure that the displayed icon is .

If the problem persists, refer to ["If You Have Installed the Software Before"](#) (page 75).

If the problem still persists, perform the procedures described in ["When ScanSnap Manager Does Not Operate Normally"](#) (page 85) once again.

If the above procedures do not solve the problem, please attach the data of your system information to an email and send it to your FUJITSU scanner dealer or an authorized FUJITSU scanner service provider. For details about how to collect system information, refer to "Troubleshooting" in the ScanSnap Manager Help.

# When You Cannot Uninstall the Software

This section explains how to troubleshoot when you cannot uninstall the following software programs:

- ScanSnap Manager
- ScanSnap Organizer
- CardMinder
- ScanSnap Online Update

**1. Restart the computer and log on as a user with Administrator privileges.**

**2. Remove the installation information.**

⇒ For details, refer to ["Removing the Installation Information"](#) (page 77).

**3. Install the software.**

⇒ For details, refer to ["How to Install the Software"](#) (page 37).

**4. Uninstall the software.**

⇒ For details, refer to ["Uninstalling the Software"](#) (page 115).



# Cleaning

This section explains about the cleaning materials and how to clean the ScanSnap.

- ["Cleaning Materials" \(page 95\)](#)
- ["Cleaning the Outside of the ScanSnap" \(page 96\)](#)
- ["Cleaning the Inside of the ScanSnap" \(page 97\)](#)

# Cleaning Materials

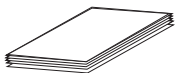
Cleaning materials and their part numbers are as below.

Product Name	Part No.	Unit	Note
Cleaner F1 	PA03950-0352	1 bottle	Size: 100 ml
Cleaning Paper (*1) 	CA99501-0012	1 pack	10 sheets
Cleaning Wipe (*2) 	PA03950-0419	1 pack	24 packets
Lint-free dry cloth (*3)	Commercially available	-	-

\*1: Used with Cleaner F1.

\*2: The cleaning wipes are wet tissues that have been soaked with Cleaner F1. In place of this product, you can use a cloth soaked with Cleaner F1.

\*3: Any lint-free cloth can be used.

Contact your FUJITSU scanner dealer or an authorized FUJITSU scanner service provider for details about purchasing the cleaning materials.

For details, refer to the following web page:

<http://scansnap.fujitsu.com/>

## Cleaning the Outside of the ScanSnap

Clean the outside of the ScanSnap, the ADF paper chute (cover), and the ADF top section in the following procedure.

- 1. Unplug the cables from the ScanSnap.**
- 2. Clean the outside of the ScanSnap with a dry cloth, or a cloth moistened with Cleaner F1/mild detergent.**

### ATTENTION

- Never use paint thinner or any other organic solvents. The shape or color may be changed.
- When cleaning the ScanSnap, prevent liquids from entering the ScanSnap.
- It may take a long time for Cleaner F1 to dry if an excessive amount is used. Moisten the cloth with moderate quantity. Wipe off the cleaner completely with a soft cloth to leave no residue on the cleaned parts.

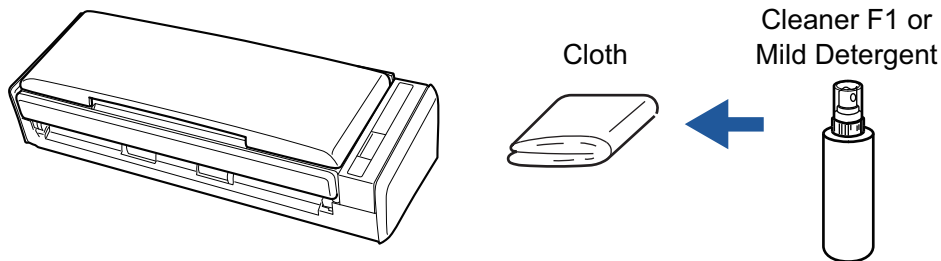



# Cleaning the Inside of the ScanSnap

Scanning repeatedly may cause dust and paper dust to accumulate inside the ScanSnap resulting in a scanning error.

As a guideline, the inside of the ScanSnap should be cleaned every 200 sheets scanned. Note that this guideline varies depending on the types of documents you scan. For instance, it may be necessary to clean the scanner more frequently when you scan documents on which the toner is not sufficiently fused.



- Before cleaning the ScanSnap, you must turn off the ScanSnap and unplug the power connection cable (power cable or USB bus power cable) from the power supply source (AC outlet or computer). Not doing so may cause fire or electrical shock.
- Do not place internal parts such as the pad assy and the pick roller assembly within reach of small children. Doing so may cause injury.
- When the ScanSnap is operating, the internal glass surface will be hot.  
Before you clean the inside of the ScanSnap, you must unplug the power connection cable (power cable or USB bus power cable) from the power supply source (AC outlet or computer) and leave the ScanSnap for 15 minutes or more.



- Do not use aerosol spray or spray that contains alcohol to clean the scanner. Paper dust and other dust blown up by strong air from the spray may enter the inside of the scanner which may cause scanner failure or malfunction.  
Also note that sparks generated by static electricity may cause a fire.
- While cleaning, pay attention to the inside structure of the ScanSnap and avoid accidentally getting your hand or a cloth caught on the pick spring (metal part). Otherwise, the pick spring (metal part) may be deformed, which causes injury.

## ATTENTION

- Do not use water or mild detergent to clean the inside of the ScanSnap.
- It may take a long time for Cleaner F1 to dry if an excessive amount is used. Moisten the cloth with moderate quantity.

Wipe off the cleaner completely to leave no residue on the cleaned parts.

## HINT

To check the number of sheets scanned with the ScanSnap, see [Total Page Count] in the [ScanSnap Manager - Check consumable status] window.

To open the [ScanSnap Manager - Check consumable status] window, right-click the ScanSnap

Manager icon  in the notification area located at the far right of the taskbar, and select [Check consumable status] from the "Right-Click Menu" (page 39).

## 1. Clean the following items:

- Pad assy

- Idler roller
  - Glass
  - Pick roller assembly
  - White backing strip
1. Unplug the power connection cable (power cable or USB bus power cable) from the power supply source (AC outlet or computer).
  2. Pull the ADF release tab to open the ADF top section.

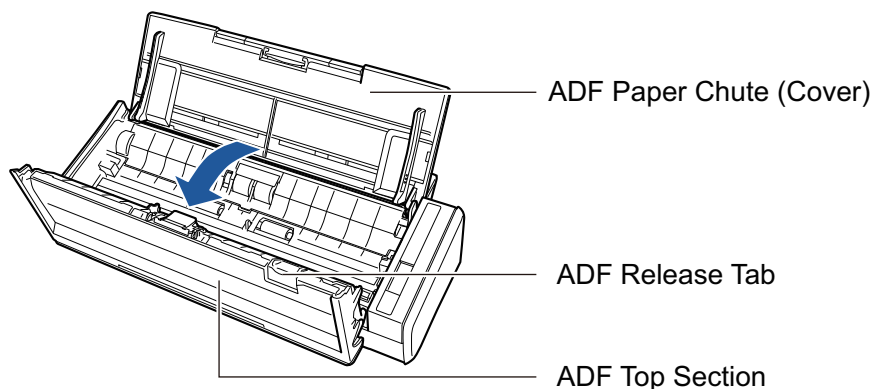

3. Clean the following locations with a cloth moistened with Cleaner F1.

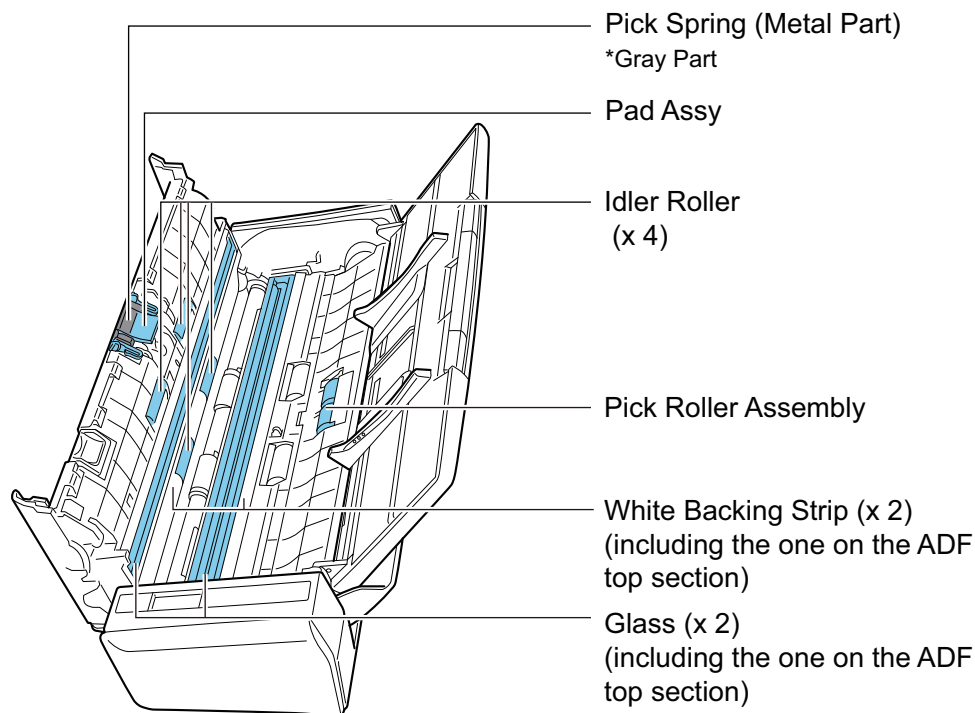

- Idler roller (× 4, located on the ADF top section)  
Gently wipe the dirt and dust off the rollers as you rotate them manually. Be careful not to damage the surface of the rollers. Make sure that they are cleaned properly because residue on the rollers will affect the feeding performance.
- Pad assy (× 1, located on the ADF top section)  
Wipe the rubber surface of the pad downward to remove any dirt and dust. Be careful not to accidentally get your hand or a cloth on the pick spring (metal part).
- Pick roller assembly (× 1)

Gently wipe the dirt and dust off the rollers as you manually rotate them downward. Be careful not to damage the surface of the rollers. Make sure that they are cleaned properly because residue on the rollers will affect the feeding performance.

- Glass (× 2, one on the ADF top section and one on the opposite side)

Gently wipe the dirt and dust off the surface of the glass sections. Make sure that they are cleaned properly because dirty glass sections may cause vertical lines on scanned images.

- White backing strip (× 2, one on the ADF top section and one on the opposite side)

The white sections at the edge of the glass sections. Gently wipe the dirt and dust off the surface.

## 2. Clean the feed rollers and eject rollers.

1. Connect the power connection cable (power cable or USB bus power cable) to the power supply source (AC outlet or computer), and press the [Scan] button for three seconds with the ADF top section open.

### ATTENTION

Connect the power connection cable (power cable or USB bus power cable) to the power supply source (AC outlet or computer) only when cleaning the feed rollers and eject rollers.

2. Clean the following locations with a cloth moistened with Cleaner F1.

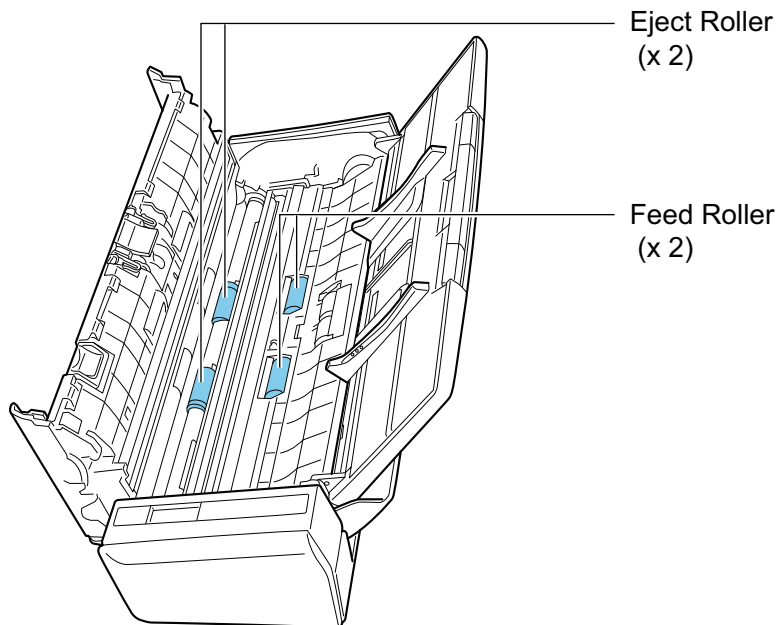

- Feed roller (× 2)/eject roller (× 2)

Press the [Scan] button to rotate the rollers. Gently wipe the dirt and dust off while taking care not to damage the surface of each roller. Make sure that they are cleaned properly because residue on the rollers will affect the feeding performance.

### HINT

Pressing the [Scan] button seven times will rotate the feed rollers and the eject rollers one revolution.

## 3. Close the ADF top section.

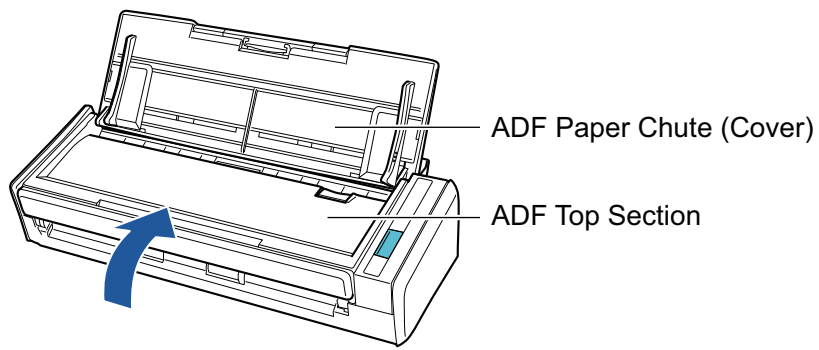

⇒ It clicks when it returns to its original position.

**ATTENTION**

Make sure that the ADF top section is completely closed.  
Otherwise, paper jams or other feeding errors, or image faults may occur.

# Consumables

This section explains about the consumable part numbers, replacement cycles and how to replace the consumables.



- Before replacing consumables, you must turn off the ScanSnap and unplug the power connection cable (power cable or USB bus power cable) from the power supply source (AC outlet or computer). Not doing so may cause fire or electrical shock.
- Do not place internal parts such as the pad assy and the pick roller assembly within reach of small children. Doing so may cause injury.

## ATTENTION

The bottom part of the ScanSnap may become hot when the ScanSnap is being used but this does not affect ScanSnap operation or cause any physical harm. Be careful not to drop the ScanSnap when carrying it.

- ["Part Numbers and Replacement Cycle of Consumables" \(page 102\)](#)
- ["Checking the Status of Consumables" \(page 103\)](#)
- ["Replacing Consumables" \(page 104\)](#)

## Part Numbers and Replacement Cycle of Consumables

The following table shows the part number of the consumables and the suggested replacement cycles.

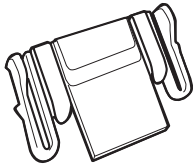
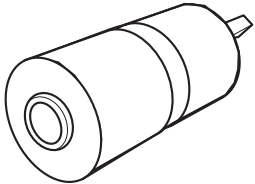
Product Name	Part No.	Suggested replacement cycle
PAD ASSY 	PA03541-0002	10,000 sheets or one year
PICK ROLLER 	PA03541-0001	100,000 sheets or one year

Note that the suggested replacement cycles are guidelines for using A4 (80 g/m<sup>2</sup> [20 lb]) wood-free paper, as these cycles vary depending on the type of documents scanned.

Only use the specified consumables.

Contact your FUJITSU scanner dealer or an authorized FUJITSU scanner service provider for details about purchasing the consumables.

For details, refer to the following portal site:

<http://scansnap.fujitsu.com/>

# Checking the Status of Consumables

You can check the status of each consumable in the following procedure.

1. **Right-click the ScanSnap Manager icon  in the notification area located at the far right of the task bar and select [Check consumable status] from the "Right-Click Menu" (page 39).**

⇒ The [ScanSnap Manager - Check consumable status] window appears.

2. **Check the status of each consumable.**

Refer to [Suggested replacement cycle] as a guideline and replace the consumables.

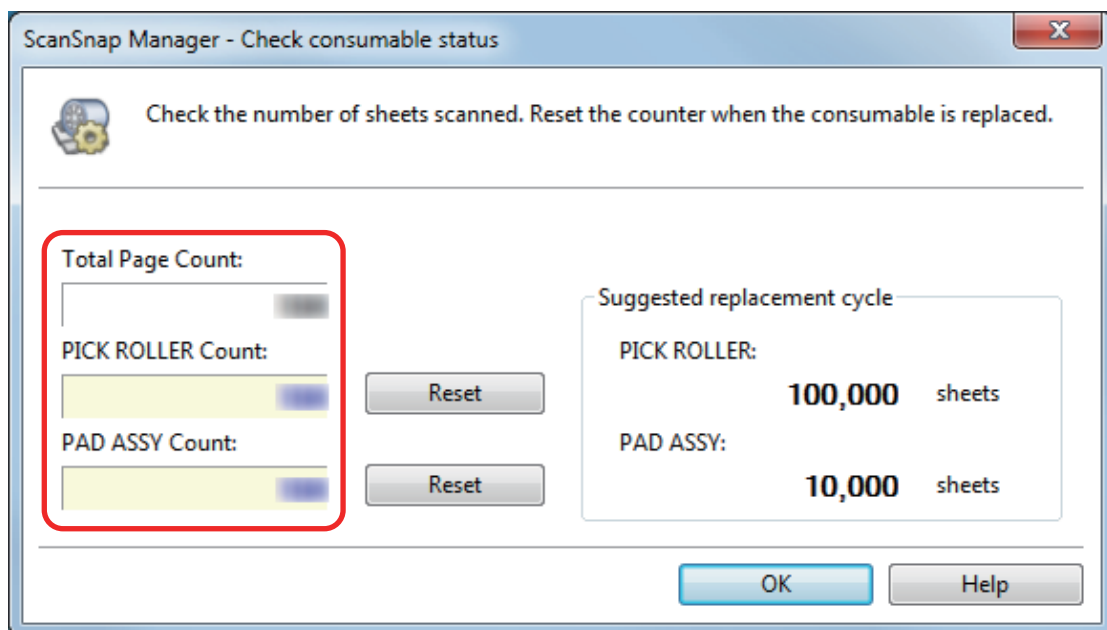

# Replacing Consumables

This section explains how to replace the pad assy and the pick roller assembly.

- ["Replacing the Pad Assy" \(page 105\)](#)
- ["Replacing the Pick Roller Assembly" \(page 108\)](#)



## Replacing the Pad Assy

Replace the pad assy in the following procedure:

- 1. Unplug the power connection cable (power cable or USB bus power cable) from the power supply source (AC outlet or computer).**
- 2. Remove any documents from the ADF paper chute (cover).**
- 3. Pull the ADF release tab to open the ADF top section.**

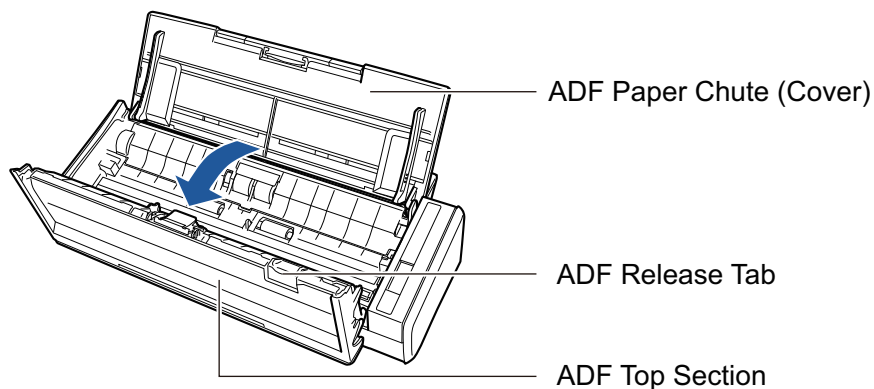

- 4. Remove the pad assy.**

Hold the both ends of the pad assy and remove it in the direction of the arrow.

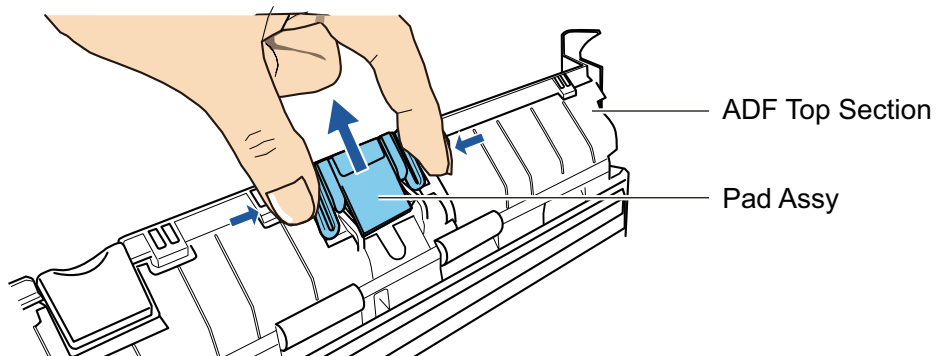

- 5. Attach the new pad assy while pressing the pad plate.**

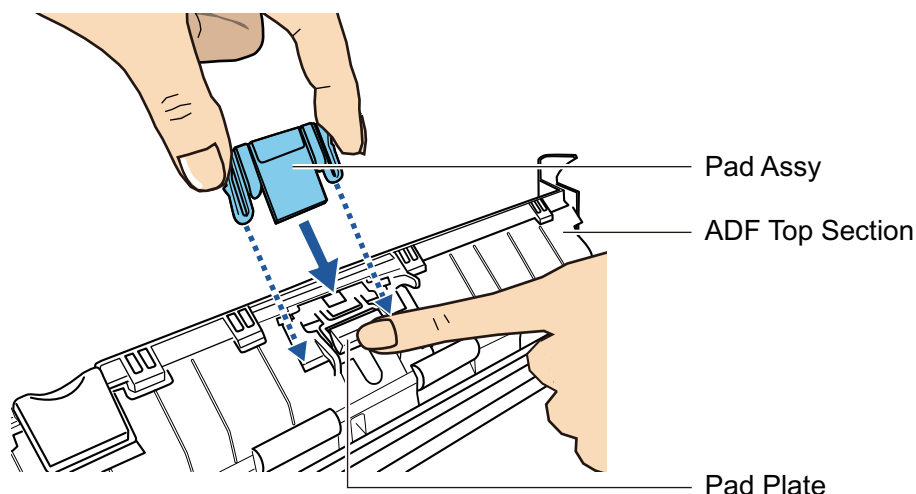
**ATTENTION**

Attach the pad assy with the front side up.

If the pad assy is attached upside down, paper jams or other feeding errors may occur.

Correct



Front

Incorrect



Back

**6. Make sure that the pad assy is attached to the retaining hook firmly.**

**ATTENTION**

Make sure that the pad assy is attached firmly. Otherwise, paper jams or other feeding errors may occur.

**7. Close the ADF top section.**

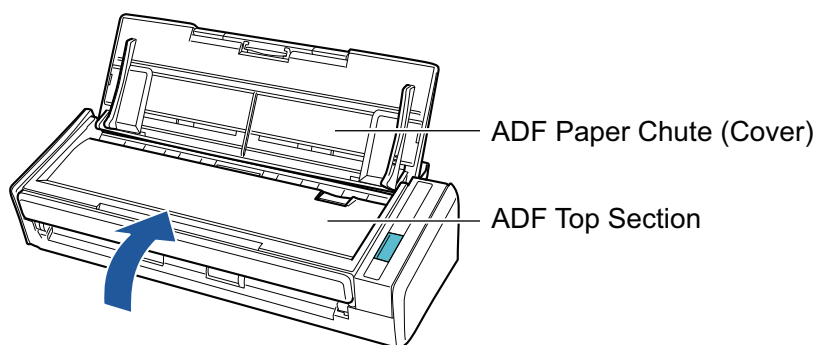

→ It clicks when it returns to its original position.

**8. Connect the power connection cable (power cable or USB bus power cable) to the power supply source (AC outlet or computer), and turn on the ScanSnap.**

**9. Reset the pad assy count.**

1. Click the ScanSnap Manager icon  in the notification area located at the far right of the taskbar and select [Check consumable status] from the "Right-Click Menu" (page 39).  
→ The [ScanSnap Manager - Check consumable status] window appears.
2. Click the [Reset] button for [PAD ASSY Count].  
→ A confirmation window appears.
3. Click the [Yes] button.  
→ [PAD ASSY Count] is reset to 0.

## Replacing the Pick Roller Assembly

Replace the pick roller assembly in the following procedure:

- 1. Unplug the power connection cable (power cable or USB bus power cable) from the power supply source (AC outlet or computer).**
- 2. Remove any documents from the ADF paper chute (cover).**
- 3. Pull the ADF release tab to open the ADF top section.**

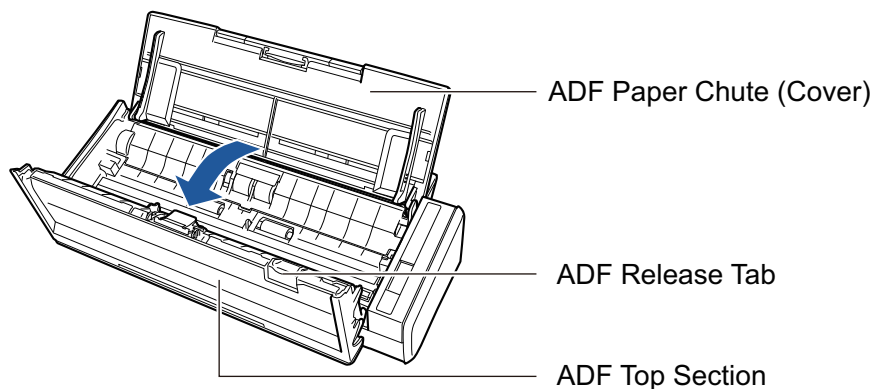

- 4. Remove the sheet guide.**

While holding the squeeze clip on the right end and pressing it inward, lift the sheet guide to remove it.

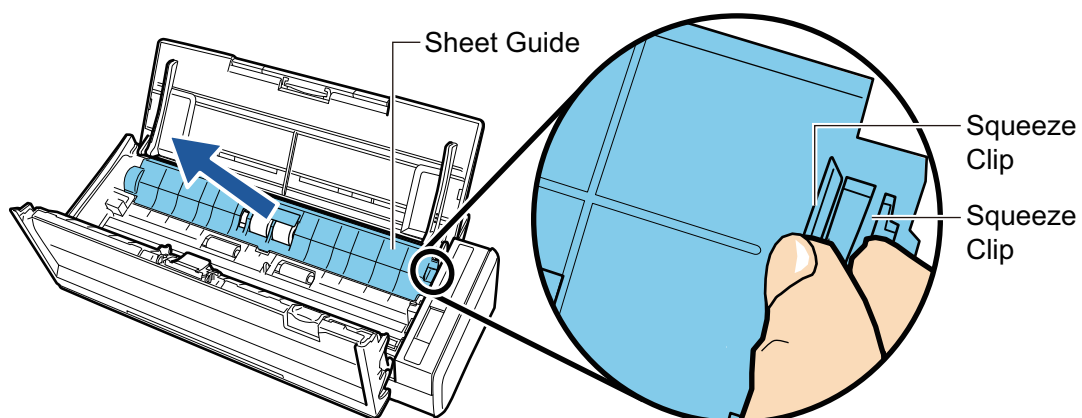

- 5. Turn the bushing that is on the left.**

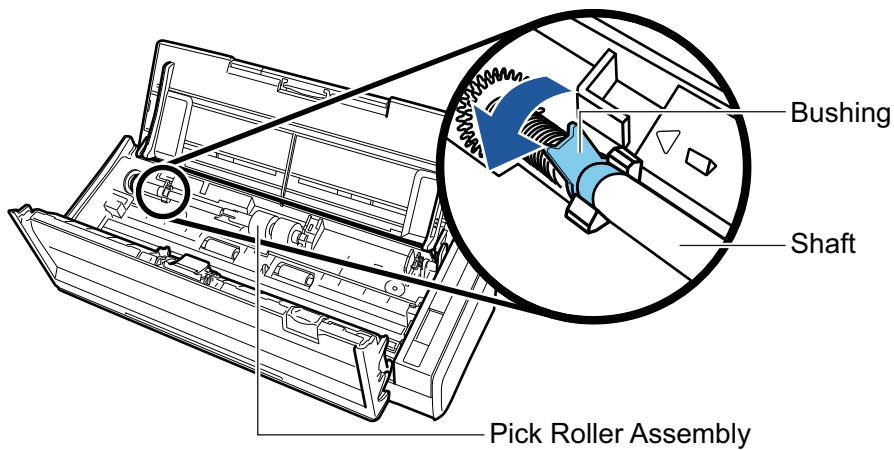

**6. Remove the shaft of the pick roller from the ScanSnap.**

Lift the left side of the shaft slightly (about 5 mm), move it toward the left, and then lift it upward to pull it out.

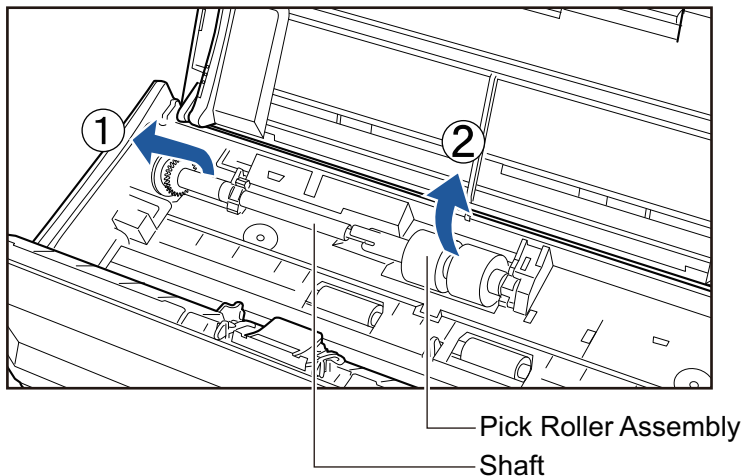

**ATTENTION**

There may be paper dust around the pick roller assembly.  
Wipe off the paper dust with a cloth moistened with Cleaner F1. Not doing so may cause image faults.  
Do not use water, mild detergent, or aerosol spray.

**7. Remove the pick roller assembly from the shaft.**

→ While lifting the retaining clip of the pick roller assembly, pull out the shaft.

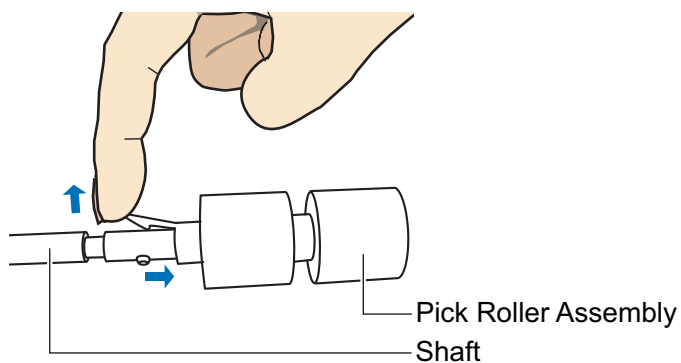

**ATTENTION**

Lifting the retaining clip with your fingernail may hurt or damage your fingernail.  
Use a paper clip or something alike if you have trouble lifting it up.

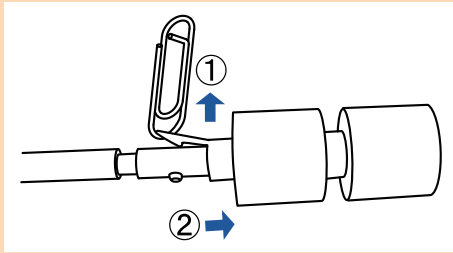
**8. Attach the new pick roller assembly to the shaft.**

Insert the drive pin of the shaft into the slot of the pick roller assembly.

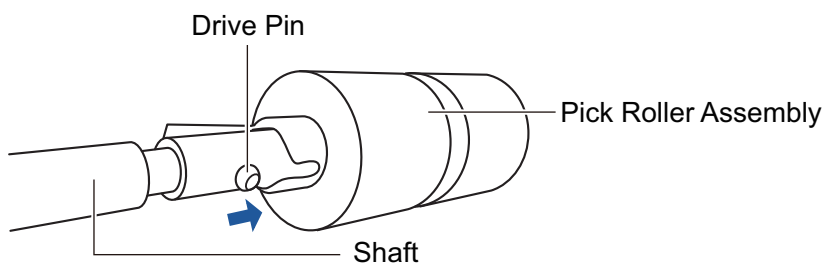
**9. Attach the shaft to the ScanSnap.**

Insert the right end of the shaft into the bushing on the right side, and then slowly attach the left end of the shaft into place.

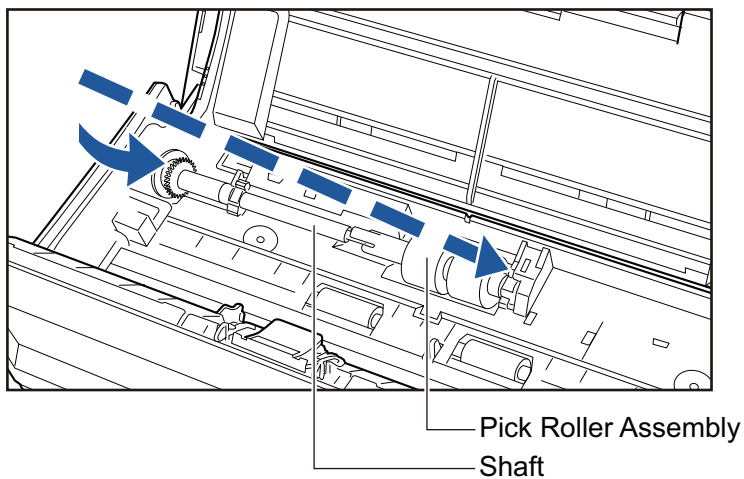
**10. Secure the bushing on the left.**

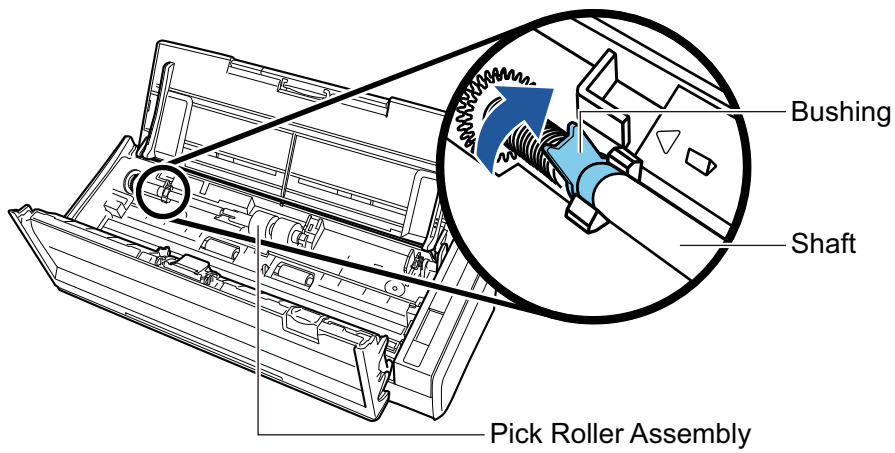

**ATTENTION**

Make sure that the shaft is attached firmly. Otherwise, paper jams or other feeding errors may occur.

**11. Attach the sheet guide.**

While holding the squeeze clip on the right end, attach the sheet guide to its original position.

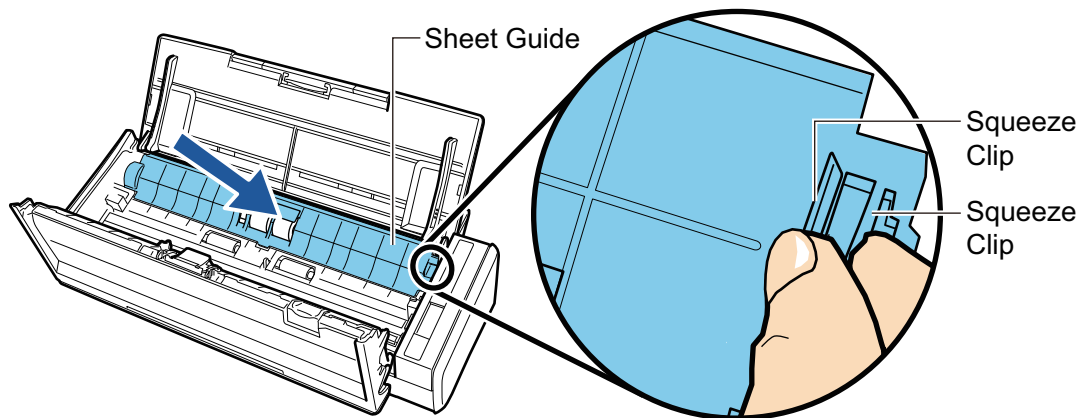

→ It clicks when the squeeze clip is locked in place.

**ATTENTION**

Make sure that the sheet guide is attached firmly. Otherwise, paper jams or other feeding errors may occur.

**12. Close the ADF top section.**

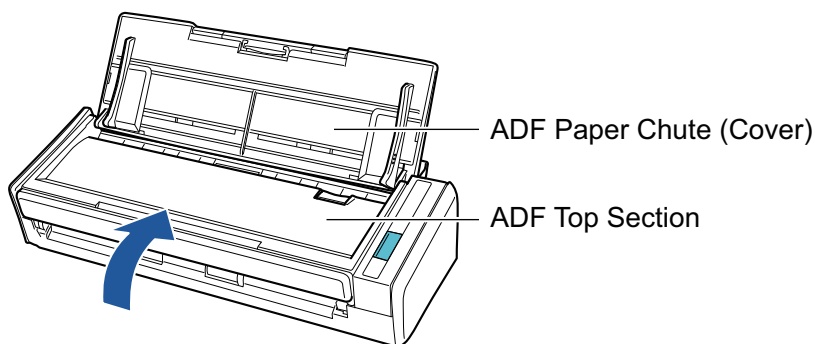

→ It clicks when it returns to its original position.

**13. Connect the power connection cable (power cable or USB bus power cable) to the power supply source (AC outlet or computer), and turn on the ScanSnap.**

**14. Reset the pick roller count.**

1. Click the ScanSnap Manager icon  in the notification area located at the far right of the taskbar and select [Check consumable status] from the "Right-Click Menu" (page 39).  
→ The [ScanSnap Manager - Check consumable status] window appears.
2. Click the [Reset] button for [PICK ROLLER Count].  
→ A confirmation window appears.
3. Click the [Yes] button.  
→ [PICK ROLLER Count] is reset to 0.



# Appendix

- ["Updating the Software" \(page 114\)](#)
- ["Uninstalling the Software" \(page 115\)](#)
- ["Specifications of the ScanSnap" \(page 117\)](#)

# Updating the Software

Latest updates for ScanSnap related software are available for free from our download server. This is called ScanSnap Online Update.

It is recommended that you apply latest updates to enhance security, operability and functions.

For the software programs that can be updated, refer to the following:

<http://www.fujitsu.com/global/support/computing/peripheral/scanners/software/online-setup-help.html>

ScanSnap Online Update checks the download server periodically.

When the latest version of ScanSnap is available, a notification appears.

To install the update, click on the notification and follow the instructions on the window that appears.

For details, refer to the ScanSnap Online Update Help.

You can also manually check from ScanSnap Manager whether a newer version of the program is available and run the update.

- 1. Right-click the ScanSnap Manager icon  in the notification area located at the far right of the task bar and click [Help] → [Online Update] from the "Right-Click Menu" (page 39).**

⇒ ScanSnap Online Update checks whether a newer version of ScanSnap Manager is available. Proceed with the update as you follow the instructions.

For details, refer to the ScanSnap Online Update Help.

## ATTENTION

- To run the online update for ScanSnap Manager, you need to have access to the Internet.
- Log on as a user with Administrator privileges.

## HINT

For details about updates of ScanSnap Manager, visit the following web pages:

<http://scansnap.fujitsu.com/g-support/en/>

# Uninstalling the Software

This section explains how to uninstall the following software programs:

- ScanSnap Manager
- ScanSnap Organizer
- CardMinder
- ABBYY FineReader for ScanSnap
- Scan to Microsoft SharePoint

## HINT

If all of the following software programs are uninstalled, ScanSnap Online Update is also uninstalled at the same time:

- ScanSnap Manager
- ScanSnap Organizer
- CardMinder

The procedure is as follows.

- 1. Turn on the computer and log on as a user with Administrator privileges.**
- 2. Exit all running software programs.**
- 3. Show the [Programs and Features] window.**

- Windows 10

Right-click the [Start] menu and select [Programs and Features].

- Windows 8.1

Click  on the lower left side of the Start screen → [Control Panel] under [Windows System] → [Uninstall a program] under [Programs].

- Windows 8

Right-click the Start screen, and select [All apps] on the app bar → [Control Panel] under [Windows System] → [Uninstall a program] under [Programs].

- Windows 7/Windows Vista/Windows XP

Select [Start] menu → [Control Panel] → [Uninstall a program] under [Programs].

⇒ The [Uninstall or change a program] window appears with a list of currently installed software programs.

- 4. Select a software program to uninstall.**

## HINT

To uninstall more than one software program, repeat steps 4 to 6 for each software program.

- 5. Click the [Uninstall] button.**

⇒ A confirmation message appears.

## 6. Click the [Yes] button.

⇒ The software program is uninstalled.

### ATTENTION

- Screen displays may vary slightly depending on the operating system that you are using. In that case, follow the instructions by the operating system.

#### Example:

- [Programs and Features]  
In Windows XP: [Add or Remove Programs]
- [Uninstall] button  
In Windows XP: [Remove] button
- If you cannot successfully uninstall the following software programs, refer to "[When You Cannot Uninstall the Software](#)" (page 93):
  - ScanSnap Manager
  - ScanSnap Organizer
  - CardMinder
  - ScanSnap Online Update

# Specifications of the ScanSnap

The following table summarizes the specifications of the ScanSnap.

Item		Specification
Product Name		ScanSnap S1300i
Scanning method		Automatic Document Feeder (ADF), simultaneous duplex scanning
Scanning color mode		Simplex/duplex, color/gray/black and white/auto (automatic color, gray, and B&W detection)
Optical system/image sensor		Selfoc lens equal-magnification optics/color CIS × 2 (front × 1, back × 1)
Light source		3 color LED (Red/Green/Blue)
Scanning speed (A4 portrait)	Power cable connection	Automatic resolution: 6 sheets/minute Normal: 12 sheets/minute Better: 9 sheets/minute Best: 6 sheets/minute Excellent: 1 sheet/minute
	USB bus power cable connection	Automatic resolution: 2 sheets/minute Normal: 4 sheets/minute Better: 3 sheets/minute Best: 2 sheets/minute Excellent: 1 sheet/minute
Scan area		Refer to <a href="#">"Documents to Scan"</a> (page 48)
Document thickness		
Number of sheets allowed to be loaded		Up to 10 sheets A4: 80 g/m <sup>2</sup> (20 lb)
Interface	USB	USB 2.0/USB 1.1 (connector: USB Mini-B type) (*1)
Input power	Voltage	100 to 240 V ±10% or 5 V (USB bus power)
	Phase	Single phase
	Frequency range	50/60 Hz
Power consumption	Power cable connection	During operation: 9 W or less During sleep mode: 2.6 W or less
	USB bus power cable connection	During operation: 5 W or less During sleep mode: 2 W or less
Temperature/humidity allowable ranges	Temperature	During operation: 5 to 35 degrees C/41 to 95 degrees F During standby: -20 to 60 degrees C/-4 to 140 degrees F During storage/transportation: -20 to 60 degrees C/-4 to 140 degrees F
	Humidity	During operation: 20 to 80% During standby: 8 to 95% During storage/transportation: 8 to 95%
Outer dimensions (Width × Depth × Height)		Min.: 284 × 99 × 77 mm/11.18 × 3.90 × 3.03 in. (when the ADF paper chute (cover) is closed) Max.: 284 × 231 × 240 mm/11.18 × 9.09 × 9.45 in. (when the ADF paper chute (cover) is open and the extension is extended)
Weight		1.4 kg (approx. 3.09 lb)

Item		Specification
Environmental specification		Compliant with the International Energy Star Program, and RoHS Directive
Related Software	Scanner driver	ScanSnap Manager
	File management	ScanSnap Organizer
	Business card management	CardMinder
	Text recognition	ABBYY FineReader for ScanSnap
	Update management and application	ScanSnap Online Update
	ECM linkage	Scan to Microsoft SharePoint

\*1: When the ScanSnap is connected to a USB 3.0 port, the port operates as a USB 2.0 port.

# About Customer Support and Maintenance

## Customer Support

- ABBYY FineReader for ScanSnap

- Windows 10

From the [Start] menu, select [All apps] → [ABBYY FineReader for ScanSnap(TM) 5.0] → [User's Guide] → [Technical Support].

- Windows 8.1

Click  on the lower left side of the Start screen, and select [User's Guide] under [ABBYY FineReader for ScanSnap(TM) 5.0] on the All apps screen → [Technical Support].

- Windows 8

Right-click the Start screen, and select [All apps] on the app bar → [User's Guide] under [ABBYY FineReader for ScanSnap(TM) 5.0] → [Technical Support].

- Windows 7/Windows Vista/Windows XP

Select [Start] menu → [All Programs] → [ABBYY FineReader for ScanSnap(TM) 5.0] → [User's Guide] → [Technical Support].

- Evernote

Refer to the following web page:

<http://www.evernote.com/about/contact/support/>

- Google Drive

Refer to the Google Drive Help Center or the Google Product Forums.

To open them, select [Help] in Google Drive.

- Salesforce

Contact the system administrator of your Salesforce.

- Dropbox

Refer to the following web page:

<http://www.dropbox.com/contact>

- ScanSnap

For other inquiries on the ScanSnap, refer to the ScanSnap Support Site.

<http://scansnap.fujitsu.com/g-support/en/>

If your problem cannot be solved after referring to the above web pages, visit the following web page to check the contact information of a suitable Fujitsu office and contact the Fujitsu office.

<http://imagescanner.fujitsu.com/warranty.html>

## Suppliers of Consumables/Optional Parts

<http://scansnap.fujitsu.com/>

## Maintenance

Contact your FUJITSU scanner dealer or an authorized FUJITSU scanner service provider for repairs on this product.

For details, refer to the following portal site:

<http://imagescanner.fujitsu.com/warranty.html>

### ATTENTION

For safety reasons, never attempt repairs by yourself.