

fi-6670(A)/fi-6770(A)/fi-6750S

Image Scanner

Operator's Guide

Thank you for purchasing a fi-6670(A) / fi-6770(A) / fi-6750S Color Image Scanner series. This manual provides the basics of how to operate and handle the scanner. Refer to the Getting Started for information on how to install and connect the scanner, and how to install related scanning software.

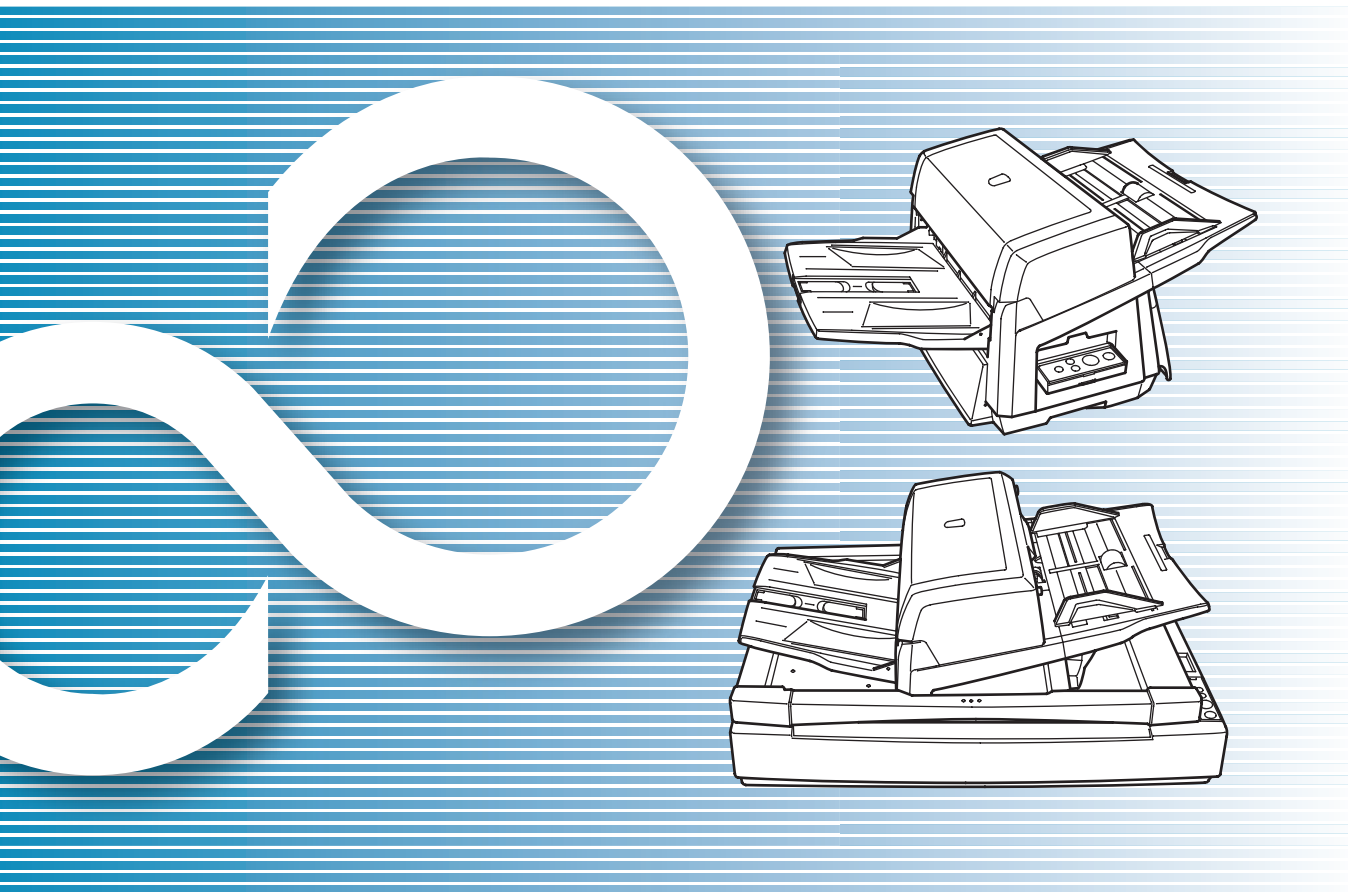

	TOP
	Contents
	Index
	Introduction
Shows scanner's parts names and their functions plus the basic operation.	Scanner Overview
Explains how to load documents on the scanner.	Loading Documents
Describes the configurable parameters in the scanner drivers.	Scan Parameters
Explains how to scan various types of documents.	Various Documents
Explains how to clean the scanner.	Daily Care
Explains how to replace the scanner consumables.	Consumables
Explains how to troubleshoot scanner problems.	Troubleshooting
Explains how to configure scanner settings using the Software Operation Panel.	Operational Settings
	Appendix
	Glossary

How to Use This Manual

The following shows the tips for using this manual.

Cover page

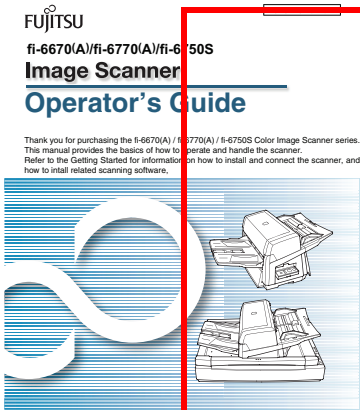

TOP
Contents
Index
Introduction
Scanner Overview
Loading Documents
How to Use ScanAI PRO
Scan Parameters
Various Scans
Daily Care
Consumables
Troubleshooting
Operational Settings
Appendix
Glossary

Clicking a desired chapter title moves to its top page.

Moves to this page (here).

- TOP: Moves to the top page of this manual.
- Contents: Moves to the top page of the Table of Contents.
- Index: Moves to the top page of the Index section.

Contents page

Contents	TOP
How to Use This Manual	Contents
Introduction	Index
Regulatory Information	Introduction
Safety Information	Scanner Overview
Chapter 1 Scanner Overview	Loading Documents
1.1 Overview and Features	How to Use ScanAI PRO
1.2 Scanner Parts and Their Functions	Scan Parameters
1.3 Functions of the Operator Panel	Various Scans
1.4 Turning the Scanner On and Off	Daily Care
1.5 Power Save Mode	Consumables
Chapter 2 Loading Documents	Troubleshooting
2.1 Loading Documents on the ADF	Operational Settings
2.2 ADF-Loaded Documents	Appendix
2.3 Changing the ADF Position (PB Type Only)	Glossary
2.4 Loading Documents on the Flatbed (PB Type Only)	
Chapter 3 How to Use ScanAI PRO	
3.1 Overview of ScanAI PRO	
3.2 Launching ScanAI PRO	
3.3 Selecting a Scanner Driver	
3.4 Selecting a Scanner Model	
3.5 Scan Parameters	
3.6 Selecting a Scanning Method (with [Scan Settings])	
Chapter 4 Daily Care	
4.1 Cleaning the Scanner	
4.2 Replacing Consumables	
4.3 Troubleshooting	
4.4 Operational Settings	
4.5 Appendix	
4.6 Glossary	

Clicking the title moves to the page that describes it.

Index page

Index	TOP
ADP-Loaded Documents	Contents
Advanced Scanning	Index
	Introduction
	Scanner Overview
	Loading Documents
	How to Use ScanAI PRO
	Scan Parameters
	Various Scans
	Daily Care
	Consumables
	Troubleshooting
	Operational Settings
	Appendix
	Glossary

Clicking the page for the desired item in the Index moves to the page that describes it.

Common Notes:

- Clicking a blue-colored character string (where your mouse pointer changes to the shape of a hand pointing upward (such as ) when you hover over the string) moves to the linked section.
- In this manual, you can use the navigation option of Adobe® Acrobat® or Adobe® Reader. For details, refer to the Adobe® Acrobat® or Adobe® Reader Help.
- Keyboard assistance is also available. Use the PageUp key to go to the previous page, and the PageDown key to the next page.

TOP
Contents
Index
Introduction
Scanner Overview
Loading Documents
Scan Parameters
Various Documents
Daily Care
Consumables
Troubleshooting
Operational Settings
Appendix
Glossary

Introduction

Thank you for purchasing our fi-6670(A)/fi-6770(A)/fi-6750S series Color Image Scanner.

This document describes the basic operation methods to perform scanning by using ScandAll PRO. The version of ScandAll PRO bundled with this product is subject to change without notice, in which case the screenshots captured in this document may differ from the actual displayed image.

For more information about ScandAll PRO, refer to the separate [ScandAll PRO V2.0 User's Guide].

Scanner Models

This manual covers the following five scanner models, each featuring as:

Model	Description
fi-6670 fi-6670A	Equipped with an automatic document feeder (ADF) for automatic document feeding and duplex scanning. The fi-6670A comes with a Color Graphics Accelerator (CGA) board as a standard feature. It enables advanced image processing at a high speed when used with Kofax VRS Professional (hereinafter referred to as "Kofax VRS").
fi-6770 fi-6770A	Equipped with an automatic document feeder (ADF) for automatic document feeding and duplex scanning, and a flatbed for scanning documents such as thin paper or thick books. The fi-6770A comes with a Color Graphics Accelerator (CGA) board as a standard feature. It enables advanced image processing at a high speed when used with Kofax VRS.
fi-6750S	Equipped with an automatic document feeder (ADF) for automatic document feeding and simplex scanning, and a flatbed for scanning documents such as thin paper or thick books. The ADF features simplex scanning only.

TOP

Contents

Index

Introduction

Scanner
OverviewLoading
DocumentsScan
ParametersVarious
Documents

Daily Care

Consumables

Trouble-
shootingOperational
Settings

Appendix

Glossary

Manuals

The following manuals are included in the for the scanner. Read them as needed.

Manual	Description
Getting Started (paper, PDF)	Outlines the procedures from installing up to starting the operation of the scanner. Read this manual first.
Operator's Guide (This Manual) (PDF)	Provides detailed information on how to operate, and maintain the scanner daily, how to replace the consumables, and how to troubleshoot problems. Included in the Setup DVD-ROM. The PDF data is included in the Setup DVD-ROM.
ScandAll PRO V2.0 User's Guide (PDF)	Provides information on how to scan documents by using ScandAll PRO. Included in the Setup DVD-ROM.
ScandAll PRO ScanSnap mode Add-in V1.0 User's Guide (PDF)	Provides information on how to scan documents by using ScandAll PRO ScanSnap mode Add-in. Included in the Setup DVD-ROM.
TWAIN User's Guide (PDF)	Explains how to install and operate the TWAIN scanner driver. Included in the Setup DVD-ROM.
Image Processing Software Option User's Guide (PDF)	Explains how to install and operate the Image Processing Software Option. Included in the Setup DVD-ROM.
VRS Note (PDF)	Explains how to connect and install Kofax VRS. Included in the Setup DVD-ROM.
Scanner Central Admin 4.0 User's Guide (PDF)	Explains about the overview, installation, operation and maintenance of Scanner Central Admin. Included in the Setup DVD-ROM.

Manual	Description
Error Recovery Guide (HTML help)	Details the status of the scanner and explains how to resolve problems encountered. Contains movies that explain how to replace the consumables. Included in the Setup DVD-ROM.
Help - Embedded in scanner drivers	Explains how to use the scanner drivers, and how to configure the settings for them.
Help - Embedded in related applications	Explains how to use and configure the settings for the application software. Use help files as necessary. Can be referenced from the applications.

TOP

Contents

Index

Introduction

Scanner
OverviewLoading
DocumentsScan
ParametersVarious
Documents

Daily Care

Consumables

Trouble-
shootingOperational
Settings

Appendix

Glossary

Trademarks

Microsoft, Windows, Windows Server, Windows Vista, and SharePoint are either registered trademarks or trademarks of Microsoft Corporation in the United States and/or other countries.

ISIS and QuickScan are trademarks or registered trademarks of EMC Corporation in the United States.

Adobe, the Adobe logo, Acrobat, and Adobe Reader are either registered trademarks or trade names of Adobe Systems Incorporated in the United States and/or other countries.

ABBYY™ FineReader™ Engine © 2011 ABBYY. OCR by ABBYY

ABBYY and FineReader are trademarks of ABBYY.

Kofax and VRS are trademarks or registered trademarks of Kofax, Inc.

Other company names and product names are the registered trademarks or trademarks of the respective companies.

Manufacturer

PFU LIMITED

International Sales Dept., Imaging Business Division,
Products Group

Solid Square East Tower, 580 Horikawa-cho, Saiwai-ku,
Kawasaki-shi Kanagawa 212-8563, Japan

Phone: (81-44) 540-4538

© PFU LIMITED 2008-2011

TOP

Contents

Index

Introduction

Scanner
Overview

Loading
Documents

Scan
Parameters

Various
Documents

Daily Care

Consumables

Trouble-
shooting

Operational
Settings

Appendix

Glossary

Regulatory Information

FCC Declaration

This equipment has been tested and found to comply with the limits for a Class B digital device, pursuant to Part 15 of the FCC Rules.

These limits are designed to provide reasonable protection against harmful interference in a residential installation. This equipment generates, uses, and can radiate radio frequency energy and, if not installed and used in accordance with the instruction manual, may cause harmful interference to radio communications.

However, there is no guarantee that interference will not occur in a particular installation. If this equipment does cause harmful interference to radio or television reception, which can be determined by turning the equipment off and on, the user is encouraged to try to correct the interference by one or more of the following measures:

- Reorient or relocate the receiving antenna.
- Increase the separation between the equipment and receiver.
- Connect the equipment into an outlet on a circuit different from that to which the receiver is located.
- Consult your dealer or an experienced radio/TV technician.

FCC warning: Changes or modifications not expressly approved by the party responsible for compliance could void the user's authority to operate the equipment.



The use of a shielded interface cable is required to comply with the Class B limits of Part 15 of FCC rules. The length of the Power cable must be 3 meters (10 feet) or less.

Canadian DOC Regulations

This digital apparatus does not exceed the Class B limit for radio noise emissions from digital apparatus set out in the Radio interference Regulations of the Canadian Department of Communications.

This Class B digital apparatus complies with Canadian ICES-003.

Le présent appareil numérique n'émet pas de parasites radioélectriques dépassant les limites applicables aux appareils numériques de la classe B et prescrites dans le Règlement sur le brouillage radioélectrique dictées par le Ministère des Communications du Canada.

Cet appareil numérique de la classe B est conforme à la norme NMB-003 du Canada.

Bescheinigung des Herstellers/ Importeurs

Für den fi-6670(A)/fi-6770(A)/fi-6750S wird folgendes bescheinigt:

- In Übereinstimmung mit den Bestimmungen der EN45014(CE) funkentstört
- Maschinenlärminformationsverordnung 3. GPSGV: Der höchste Schalldruckpegel beträgt 70 dB (A) oder weniger, gemäß EN ISO 7779.

Dieses Gerät wurde nicht für die Benutzung in unmittelbarer Umgebung starker Lichtquellen (z. B. Projektoren) konzipiert.

TOP

Contents

Index

Introduction

Scanner
OverviewLoading
DocumentsScan
ParametersVarious
Documents

Daily Care

Consumables

Trouble-
shootingOperational
Settings

Appendix

Glossary

ENERGY STAR®

PFU LIMITED, a Fujitsu company, has determined that this product meets the ENERGY STAR® guidelines for energy efficiency. ENERGY STAR® is a registered trademark of the United States.



Use in High-Safety Applications

This product has been designed and manufactured on the assumption that it will be used in office, personal, domestic, regular industrial, and general-purpose applications.

It has not been designed and manufactured for use in applications (simply called "high-safety applications" from here on) that directly involve danger to life and health when a high degree of safety is required, for example, in the control of nuclear reactions at nuclear power facilities, automatic flight control of aircraft, air traffic control, operation control in mass-transport systems, medical equipment for sustaining life, and missile firing control in weapons systems, and when provisionally the safety in question is not ensured.

The user should use this product with adopting measures for ensuring safety in such high-safety applications. PFU LIMITED assumes no liability whatsoever for damages arising from use of this product by the user in high-safety applications, and for any claims or compensation for damages by the user or a third party.

TOP

Contents

Index

Introduction

Scanner
Overview

Loading
Documents

Scan
Parameters

Various
Documents

Daily Care

Consumables

Trouble-
shooting

Operational
Settings

Appendix

Glossary

Conventions

Symbols Used In This Manual

For notational convention, the following symbols are used in this manual:



This symbol alerts operators to particularly important information. Be sure to read this information.



This symbol alerts operators to helpful advice regarding operation.

Naming Conventions in This Manual

Scanners:

The scanners are indicated as follows:

Model	Indication	
fi-6670/fi-6670A	ADF type	Scanner
fi-6770/fi-6770A/fi-6750S	Flatbed type	

The explanation in this manual bases on the following models:

ADF type: fi-6670

Flatbed type: fi-6770

Operating Systems and Software Products:

The OSs and products in this manual are indicated as follows:

Product	Indication	
Windows® 2000 Professional	Windows 2000	Windows (*1)
Windows® XP Home Edition Windows® XP Professional Windows® XP Professional x64 Edition	Windows XP	
Windows Server® 2003, Standard Edition Windows Server® 2003, Standard x64 Edition Windows Server® 2003 R2, Standard Edition Windows Server® 2003 R2, Standard x64 Edition	Windows Server 2003	
Windows Vista® Home Basic (32/64-bit) Windows Vista® Home Premium (32/64-bit) Windows Vista® Business (32/64-bit) Windows Vista® Enterprise (32/64-bit) Windows Vista® Ultimate (32/64-bit)	Windows Vista	
Windows Server® 2008 Standard (32/64-bit) Windows Server® 2008 R2 Standard (64-bit)	Windows Server 2008	
Windows® 7 Home Premium (32/64-bit) Windows® 7 Professional (32/64-bit) Windows® 7 Enterprise (32/64-bit) Windows® 7 Ultimate (32/64-bit)	Windows 7	

Product	Indication
Microsoft® Office SharePoint® Portal Server 2003	SharePoint Server
Microsoft® Office SharePoint® Server 2007	
Microsoft® SharePoint® Server 2010	
Adobe® Acrobat®	Adobe Acrobat (*2)

*1: Where there is no distinction between the different versions of the above operating system, the general term "Windows" is used.

*2: All the descriptions in this manual assume the usage of Adobe Acrobat bundled with this product. However, Adobe Acrobat may be upgraded without notice. If the descriptions differ from the screens actually displayed, refer to the Adobe Acrobat Help.

Arrow Symbols in This Manual

Right-arrow symbols (⇒) are used to separate icons or menu options you should select in succession.

Example: Click [Tool] ⇒ [Scan Setting].

Screen Examples in This Manual

The screen examples in this manual are subject to change without notice in the interest of product improvement.

If the actual displayed screen differs from the screen examples in this manual, operate by following the actual displayed screen while referring to the user's manual of the scanner application you are using.

The screen examples used in this manual are of TWAIN scanner driver, ISIS scanner driver, ScandAll PRO (which is an image capturing software), and Adobe Acrobat.

Precautions

Liability Note

READ ALL OF THIS MANUAL CAREFULLY BEFORE USING THIS PRODUCT. IF THIS PRODUCT IS NOT USED CORRECTLY, UNEXPECTED INJURY MAY BE CAUSED TO USERS OR BYSTANDERS.

Also, keep this manual in a safe place so that it can be easily referred to during use of this product.

While all efforts have been made to ensure the accuracy of all information in this manual, PFU assumes no liability to any party for any damage caused by errors or omissions or by statements of any kind in this manual, its updates or supplements, whether such errors are omissions or statements resulting from negligence, accidents, or any other cause. PFU further assumes no liability arising from the application or use of any product or system described herein; nor any liability for incidental or consequential damages arising from the use of this manual. PFU disclaims all warranties regarding the information contained herein, whether expressed, implied, or statutory.

Use of Mercury



Lamp(s) inside this product contain mercury and must be recycled or disposed of according to local, state, or federal laws.

To avoid unexpected injuries:

- Do not put the substance contained in the lamp in your mouth as it has mercury.
- Do not breathe the chemical liquid contained in the scanner lamps.
- Do not incinerate, crush, or shred the lamps or scanner parts.

Maintenance

The user must not perform repairs on this scanner. Contact the store where you purchased the scanner or an authorized FUJITSU Image Scanner service provider to make repairs to this product.

[TOP](#)[Contents](#)[Index](#)[Introduction](#)[Scanner Overview](#)[Loading Documents](#)[Scan Parameters](#)[Various Documents](#)[Daily Care](#)[Consumables](#)[Troubleshooting](#)[Operational Settings](#)[Appendix](#)[Glossary](#)

Warning Label

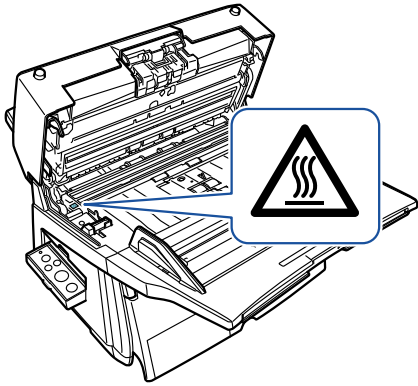

HOT warning label:

The glass surface inside the ADF becomes hot during the operation. Be careful not to touch glass surfaces inside the ADF.

To avoid burns, never touch around the area indicated by this label.

Take care not to get your finger(s) caught in the ADF while turning.

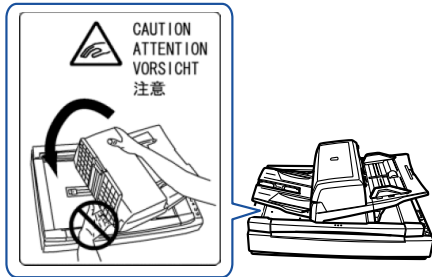

You must NOT remove this warning label from your scanner. When it gets old or unreadable by staining or scratches, contact the store where you purchased the scanner or an authorized FUJITSU scanner service provider.

Safety Information



This manual describes important details for users to use this product safely and correctly. Read this manual thoroughly before you start using this product.

Be sure to read and fully understand the Safety Information, in particular.

In addition, keep this manual handy during use of this product, so that you can refer to it quickly when necessary.

Warning Indications Used In This Manual

The following indications are used in this manual to obviate any change of accident or damage to you and/or the product.

	<p>This indication alerts operators to an operation that, if not strictly observed, may result in severe injury or death.</p>
	<p>This indication alerts operators to an operation that, if not strictly observed, may result in safety hazards to personnel or damage to the product.</p>

 A TRIANGLE symbol indicates that special care and attention is required. The drawing inside the triangle shows the specific caution.



 A CIRCLE with a diagonal line inside shows action which users may not perform. The drawing inside or under the circle shows the specific action that is not allowed.









Outline characters on a colored background show instructions users should follow. It may also include the drawing that shows the specific instruction.











The following are important warnings described in this manual.



Description	
	<p>Do not damage the power cable. A damaged power cable may cause fire or electric shock. Do not place heavy objects on power cable, or pull, bend, twist, heat, damage or modify Power cables. Do not use any damaged power cables or power plugs, or install any cables or power plugs to loose wall sockets.</p>
	<p>Use only specified power cables and interface cables. Use only specified power cables and interface cables. Failure to use the correct cables might cause electric shock and/or equipment failure. Do not use the power cable provided with the scanner for other devices, since this might cause equipment failure and other troubles or an electric shock.</p>
	<p>Make sure to ground the scanner. Make sure to ground to avoid electric shock. Be sure to ground before plugging into a power outlet. Unplug from the outlet before removing the ground connection.</p>

- TOP
- Contents
- Index
- Introduction
- Scanner Overview
- Loading Documents
- Scan Parameters
- Various Documents
- Daily Care
- Consumables
- Trouble-shooting
- Operational Settings
- Appendix
- Glossary

Description	
	<p>Use the scanner only at the indicated power voltage. Do not connect to multiple-power strips. Use the scanner only at the indicated power voltage and current. Improper power voltage or current might cause fire or electric shock. Do not connect to multiple-power strips.</p>
	<p>Do not touch the power cable with wet hands. Do not touch the power plug with wet hands. Doing so might cause electric shock.</p>
	<p>Wipe off any dust from the power plug. Wipe off any dust from the metal parts on the power plug or metal fittings with a soft, dry cloth. Accumulated dust might cause fire or electric shock.</p>
	<p>Do not install the scanner in a location that has oil smoke, steam, humidity, and dust. Do not install the scanner in a location subject to oil smoke, steam, humidity, and dust. Doing so might cause a fire or electric shock.</p>
	<p>Do not use the scanner if there is a strange odor. If you detect excessive heat coming from the scanner or detect smoke, strange smells or noises during the operation, immediately disconnect the power plug from the power outlet. Before contacting the store where you bought the scanner or an authorized FUJITSU scanner service provider, make sure that any smoke coming from it has completely stopped. Never try fixing such problems by yourself. Doing so is dangerous.</p>
	<p>Disconnect the power if the scanner is damaged. If the scanner is damaged for any reason, immediately disconnect the power plug from the power outlet. Then, contact the store where you bought the scanner or an authorized FUJITSU scanner service provider.</p>







Description	
	<p>Do not put liquids inside the scanner. Do not insert or drop any metal objects into the ADF slot or ventilation ports on the scanner.</p>
	<p>Do not scan any wet documents or documents with paper clips or staples attached.</p>
	<p>Do not splash or allow the scanner to get wet. If foreign objects (water, small metal objects, liquids, etc.) get inside the scanner, immediately disconnect the power plug from the power outlet. Then, contact the store where you bought the scanner or an authorized FUJITSU scanner service provider. Pay particular attention to this warning in households where there are small children.</p>
	<p>Unplug the scanner when a trouble occurs. Immediately unplug the scanner when a trouble occurs. Never cut the ground connection until the scanner is unplugged from the power outlet.</p>
	<p>Do not disassemble the scanner. Do not take apart or modify the scanner. The inside of the scanner contains high-voltage components. Touching these components might cause electric shock or fire.</p>
	<p>Do not use aerosol or alcohol sprays near the scanner. Do not use any flammable substance or alcohol based cleaning sprays (such as aerosol sprays) to clean the scanner. Sparks, caused by static electricity, generated when blowing off dust and dirt from the outside of the scanner, may cause a fire.</p>
	<p>Do not place the scanner within the reach of small children. To avoid injuries, do not place the scanner in an area where small children may be able to reach.</p>
	<p>Do not touch the heated section for a long time. Do not touch the heated section such as the bottom of the scanner for a long time. Doing so may cause a low-temperature burn on your skin.</p>

- TOP
- Contents
- Index
- Introduction
- Scanner Overview
- Loading Documents
- Scan Parameters
- Various Documents
- Daily Care
- Consumables
- Trouble-shooting
- Operational Settings
- Appendix
- Glossary







Description	
	<p>Do not cover the scanner with something during its operation. Do not use the scanner while covered with a blanket, etc. Doing so may raise the temperature inside and cause a fire.</p>
	<p>Do not use the scanner where it gets wet. Do not use the scanner at a place such as a bathroom, shower room, or swimming pool where it may easily get wet. Doing so might cause electric shock or fire.</p>





The following are important cautions described in this manual:

Description	
	<p>Do not install the scanner on an unstable work table. When installing the scanner on a work table, make sure that the table is flat and level. Place the scanner so that none of its parts extend beyond the edge of the table. Also, it must be strong enough to support the weights of the scanner and other devices.</p>
	
	<p>Firmly insert the power plug. Firmly insert the power plug into the power outlet as far it can go.</p>
	<p>Do not block the ventilation ports. Do not block the ventilation ports. Blocking the ventilation ports generates heat inside of the scanner, which may result in fire or scanner failure.</p>
	<p>Do not place heavy objects or stand on the top of the scanner. Do not place heavy objects on the scanner or stand on its top to perform other work. Doing so might cause injuries and equipment failure.</p>
	<p>Do not use the scanner immediately after moving it from a cold place into a warm room. Do not use the scanner immediately after moving it from a cold place into a warm room. Condensation may occur, which might lead to scanning errors. Let the scanner dry for one or two hours before you use it.</p>

- TOP
- Contents
- Index
- Introduction
- Scanner Overview
- Loading Documents
- Scan Parameters
- Various Documents
- Daily Care
- Consumables
- Trouble-shooting
- Operational Settings
- Appendix
- Glossary

Description	
	<p>Before moving the scanner, disconnect the power plug from the power outlet.</p> <p>Do not move the scanner with the power and interface cables connected as this can damage the cables, which can later cause fire, electric shock as well as injuries.</p> <p>Before moving the scanner, be sure to disconnect the power plug from the power outlet, and all other interface cables. Make sure that the floor is free of any obstructions.</p>
	<p>Protect the scanner from static electricity.</p> <p>Install the scanner away from strong magnetic fields and other sources of electronic noise. Also, protect the scanner against any static electricity, which can cause the scanner to malfunction. Choose a static-free place to install the scanner.</p>
	<p>Avoid any contact when scanner is in use.</p> <p>Avoid getting a sleeve, necktie, or hair caught up in any scanner mechanism during scanning since this may cause injuries.</p>
	<p>Disconnect the power plug from the power outlet when the scanner is not in use for a long period of time.</p> <p>When the scanner is not going to be used for a long period of time, be sure to disconnect the power plug from the power outlet.</p>
	<p>Do not install the scanner in direct sunlight.</p> <p>Do not install the scanner under direct sunlight or near heating apparatus. Doing so might cause excessive heat to build up inside the scanner, which can cause scanner trouble or even fire. Install the scanner in a well-ventilated location.</p>
	<p>Do not try to move or lift the scanner alone.</p> <p>When transporting the scanner, never carry it alone.</p>

Description	
	<p>Before moving the scanner, make sure the transport lock is locked. (Flatbed type)</p> <p>When moving the scanner, be sure to lock the transport lock and the ADF transport lock in order to prevent damage to the scanner.</p>
	<p>Handle documents carefully.</p> <p>When handling documents, be careful not to cut your fingers with them.</p>
	<p>Do not make the scanner wet while carrying it outside.</p> <p>When carrying the scanner outside while it is raining or snowing, pay special attention so the scanner does not get wet.</p>

- TOP
- Contents
- Index
- Introduction
- Scanner Overview
- Loading Documents
- Scan Parameters
- Various Documents
- Daily Care
- Consumables
- Trouble-shooting
- Operational Settings
- Appendix
- Glossary

Contents

How to Use This Manual	2
Introduction	3
Regulatory Information	6
Conventions	8
Precautions	10
Safety Information	12
Chapter 1 Scanner Overview.....	20
1.1 Features	21
Features	21
1.2 Scanner Parts and Their Functions	22
fi-6670/fi-6670A (ADF Type)	22
fi-6770/fi-6770A/fi-6750S (Flatbed Type)	24
Model-Common Parts	27
1.3 Functions of the Operator Panels	28
Operator Panel	28
Indications on the Function Number Display	30
1.4 Turning the Scanner ON and OFF	31
Turning the Scanner ON	31
Turning the Scanner OFF.....	31
1.5 Power Save Mode	32
Returning from Power Save Mode	32
1.6 Basic Flows of Scanning Documents	33
1.7 Image Scanning Application	36
1.8 Centralized Management of Scanners	37

Chapter 2 Loading Documents.....	38
2.1 Loading Documents on the ADF	39
2.2 ADF-Loaded Documents	42
Sizes.....	42
Paper Quality.....	42
Maximum Document Loading Capacity.....	44
Area Not to be Perforated	44
Loading Documents with Tabs or Non-Rectangular Documents	45
Multifeed Detection Conditions.....	45
Limiting the Background Color Area.....	46
Job Separation Sheet.....	47
2.3 Changing the ADF Position (Flatbed Type Only)	48
2.4 Loading Documents on the Flatbed (Flatbed Type Only)	50
Chapter 3 Scan Parameters	51
3.1 TWAIN Scanner Driver	52
Resolution	52
Scan Type	52
Paper Size.....	53
Image Mode	53
[Scan] Button.....	53
[Preview] Button	53

TOP
Contents
Index
Introduction
Scanner Overview
Loading Documents
Scan Parameters
Various Documents
Daily Care
Consumables
Trouble-shooting
Operational Settings
Appendix
Glossary

[Close]/[OK] Button.....	53	4.3	Advanced Scanning	67
[Reset] Button.....	53		Excluding Color(s) from Images (Dropout Color) .	67
[Help] Button.....	53		Skipping Blank Pages	69
[About] Button.....	53		Scanning the Image Brighter.....	70
[Option] Button	54		Removing Punch Holes from A Scanned Image ..	72
[Advance] Button	54		Scanning A Document from the ADF in Manual	
[Config] Button.....	54		Loading Mode.....	74
3.2	ISIS Scanner Driver	55	Duplex Scanning Using the ADF Virtual Duplex	
[Main] Tab	55		Function (fi-6750S Only)	75
[Layout] Tab	56	4.4	Setting Post-Scan Operations and Handling ..	77
[Image Processing] Tab	57		Automatically Correcting Skewed Document	
[Paper Handling] Tab	57		Images.....	77
[Gamma] Tab	58		Setting Auto Correction for Document Page	
[Color Dropout] Tab.....	58		Orientations.....	79
[Blank Page Deletion] Tab.....	59		Saving Scanned Images in PDF Format.....	80
[Compression] Tab	59		Horizontally Splitting a Scanned Image into Two .	85
[Imprinter] Tab	60		Outputting in Multi-Image Mode	86
[About] Tab.....	60		Setting Auto Detection for Content Colors	
Chapter 4	Various Documents	61	(Color/Monochrome)	88
4.1	Summary	62	4.5	Customizing the Hardware Settings
4.2	Scanning Documents of Different Types or		Using the Scanner Buttons to Start A Scan	
Sizes	63		Quickly.....	90
Scanning Both Sides of A Document			Detecting Multifeds.....	92
(fi-6670/fi-6670A/fi-6770/fi-6770A Only).....	63		Bypassing Multifeed Detection for a Fixed	
Scanning A Large-Size Document or Book			Format.....	93
(Flatbed Type Only).....	63	Chapter 5	Daily Care.....	97
Scanning Documents of Different Widths.....	64	5.1	Cleaning Materials and Locations Requiring	
Scanning A Document Longer Than A3 Size	65		Cleaning	98

TOP
Contents
Index
Introduction
Scanner Overview
Loading Documents
Scan Parameters
Various Documents
Daily Care
Consumables
Trouble-shooting
Operational Settings
Appendix
Glossary

Cleaning Materials.....	98	Function Number Display indicates an error code (alphabetical letter plus number) alternately after the scanner is turned ON.	127
Locations to Clean and Cleaning Frequency	99	Multifeed errors occur frequently.....	128
5.2 Cleaning the ADF	100	Pickup errors occur frequently.....	130
Cleaning with a Cloth Moistened with Cleaner F1	100	Paper jams occur frequently.....	131
5.3 Cleaning the Flatbed (Flatbed Type Only)	105	Scanned images are elongated when scanned from the ADF.....	132
Chapter 6 Consumables	106	There is a shadow on leading edge of scanned image.....	133
6.1 Consumables and the Replacement Cycles .	107	The scanner is not recognized by your computer when Kofax VRS is used.....	134
6.2 Replacing the Pick Rollers	108	7.4 Before Contacting Your Dealer or Scanner Service Provider	135
6.3 Replacing the Brake Roller	110	General Details.....	135
Chapter 7 Troubleshooting.....	112	Troubles	135
7.1 Paper Jams	113	7.5 Checking Labels on the Scanner	137
7.2 Errors Indicated on the Operator Panel	115	Positions of Labels on the Scanner.....	137
Temporary Errors	116	Chapter 8 Operational Settings	138
Device Errors.....	117	8.1 Starting Up the Software Operation Panel	139
7.3 Troubleshooting	119	8.2 Configurable Items	140
Scanner cannot be turned on.	120	Device Setting	140
Indication on Function Number Display goes out.	121	Device Setting 2	142
Scanning does not start.....	122	[Default] button	147
Quality of scanned pictures or photos is not satisfactory when scanning in black and white...	123	[Save] button	147
Quality of scanned text or lines is unsatisfactory.	124	[Restore] button.....	147
Images are distorted or blurred.	125	8.3 Settings Related to Consumables and Useful Life Counters	148
Vertical lines appear in scanned images.....	126		

TOP
Contents
Index
Introduction
Scanner Overview
Loading Documents
Scan Parameters
Various Documents
Daily Care
Consumables
Trouble-shooting
Operational Settings
Appendix
Glossary

Confirming and Resetting the Counters	148	Adjusting the Paper Picking Pressure	
Cycle for Cleaning the Scanner		[Pick Pressure]	161
[Cleaning Cycle]	150	8.5 Settings Related to Multifeed Detection	163
Cycle for Replacing the Consumables		Multifeed Detection.....	163
[Useful life counter].....	151	Specifying the Multifeed Detection Range	
8.4 Settings Related to Scanning	152	[Document Check Area Specification for	
Adjusting the Starting Position for Scanning		Multifeed Detection].....	165
[Offset/Vertical Magnification Adjustment].....	152	Setting A Non-Multifeed-Detection Range	
Eliminating Shadows or Stripes on the Scanned		[Intelligent Multifeed Function].....	168
Image Edge [Page Edge Filler]	154	8.6 Settings Related to Wait Time	169
Scanning with Particular Color(s) Dropped Out		Timeout for Manual Feeding	
[Dropout color].....	155	[Manual-feed timeout].....	169
Shorting the Scanning Intervals [Pre-Pick].....	156	Setting the Wait Time in Power Saving Mode	
Cropping the Image Boundary		[Power saving].....	170
[AutoCrop Boundary].....	157	8.7 Settings Related to Power ON/OFF Control ..	171
Configuring the Data Transfer Width		Power ON/OFF Control [Power SW Control]	171
[SCSI Bus Width].....	158	8.8 Overscan Control	172
Scan Setting for Documents with Tabs or		8.9 Paper feeding retry times	173
Non-Rectangular Documents		Appendix	174
[Scan Setting for Documents with Tab (Automatic		A.1 Basic Specification	175
Paper Size Detection)]	158	A.2 Installation Specification	177
Scan Setting for The Document Whose One Side Is		A.3 Outer Dimensions	178
in Dark Background Color		ADF type	178
[Scan Setting for Document in Dark Background		Flatbed type.....	179
Color].....	159	A.4 Scanner Options	180
Adjusting the Scanned Document Output Images		A.5 Uninstalling the Software	181
[Overcrop/Undercrop].....	160	Glossary	182

TOP
Contents
Index
Introduction
Scanner Overview
Loading Documents
Scan Parameters
Various Documents
Daily Care
Consumables
Trouble-shooting
Operational Settings
Appendix
Glossary

Chapter 1 Scanner Overview

This chapter describes the components of the scanner, showing their names and functions, and explains the basics of how to operate them.

Here, Windows Vista screen samples are used to explain the operations. The screens and operations may differ slightly if the OS that you are using is other than Windows Vista. Take note that, when the TWAIN or ISIS scanner driver is updated, the screens and operations herein may also be slightly different. In such case, refer to the relevant manuals or materials, which are to be supplied when updating the driver.

1.1 Features	21
1.2 Scanner Parts and Their Functions	22
1.3 Functions of the Operator Panels	28
1.4 Turning the Scanner ON and OFF	31
1.5 Power Save Mode.....	32
1.6 Basic Flows of Scanning Documents	33
1.7 Image Scanning Application	36
1.8 Centralized Management of Scanners	37

TOP

Contents

Index

Introduction

Scanner
Overview

Loading
Documents

Scan
Parameters

Various
Documents

Daily Care

Consumables

Trouble-
shooting

Operational
Settings

Appendix

Glossary

1.1 Features

This section explains the major features of the scanner.

Features

The scanner has the following features:

Realizes a high-speed scanning of 90 sheets (or 180 pages) per minute under JPEG compression (fi-6670/fi-6670A/fi-6770/fi-6770A only).

The scanner mounts newly-developed high-speed CCD and high-speed image processing circuit. This mechanism has realized a scan speed of 90 sheets or 180 pages (at 200 dpi) per minute. You can perform a batch scanning of about 45,000 sheets per day.

Reduces the work loss caused by multifeeds.

The scanner mounts an ultrasonic multifeed sensor that definitely detects two or more sheets fed simultaneously (this is called a "multifeed"). This feature enables multifeed detection for documents of different thicknesses, sizes, color and/or color density, thus preventing any work loss caused by multi-feeds.

Provides the Intelligent Multifeed function.

The Intelligent Multifeed function recognizes paper (sticky notes or labels) of the same size which are glued onto a pre-specified same location of your document.

The function suppresses multifeed detection at this location and continues scanning.

Mounts an adjustable ADF (Flatbed type only).

The scanner is equipped with an adjustable ADF. You can rotate it by 180 degree or slide to a desired position among three, thus saving your installation space.

Centralized management of multiple scanners

The bundled "Scanner Central Admin Agent" application allows you to manage multiple scanners together, for example, to update the scanner settings and drivers, as well as to monitor the operating status of each scanner.

TOP

Contents

Index

Introduction

Scanner Overview

Loading Documents

Scan Parameters

Various Documents

Daily Care

Consumables

Trouble-shooting

Operational Settings

Appendix

Glossary

1.2 Scanner Parts and Their Functions

This section shows you the names of the scanner parts, and briefly describes how they function.

fi-6670/fi-6670A (ADF Type)

ADF (Automatic Document Feeder)

Feeds documents to the scanning position automatically. Documents are fed sheet by sheet when loaded for batch scanning. Both sides of documents can be scanned at one time.

Stacker

Scanned documents are ejected from the ADF onto this stacker. You can adjust the height of the stacker at lower or upper position. Is removable.

Stacker Extension

Pull out this extension according to the document length.

Stopper

Raise this if the documents loaded are long.

EXT Connector

A connector for connecting to the imprinter option. For details of the imprinter option, refer to the "Imprinter Operator's Guide."

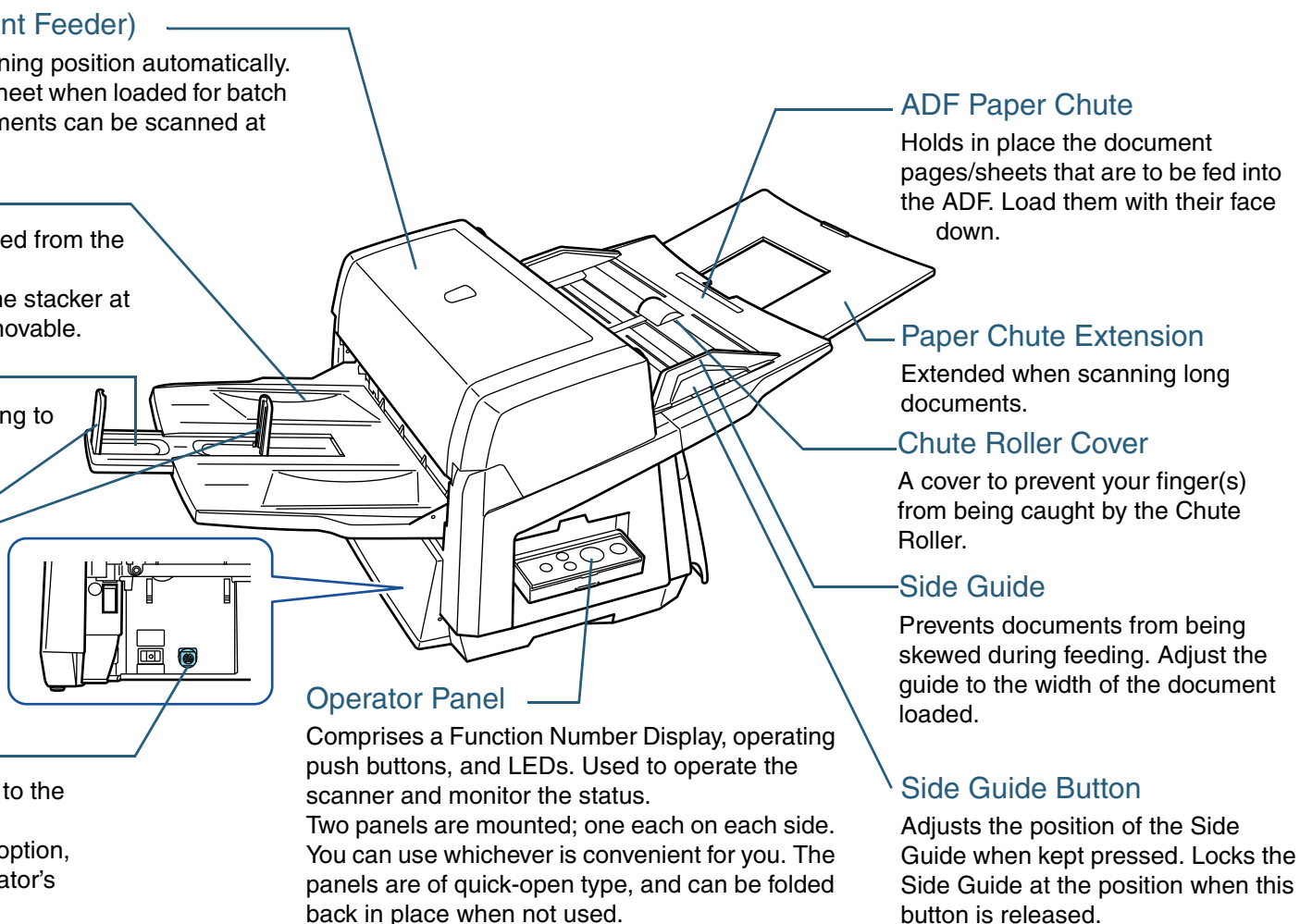

ADF Paper Chute

Holds in place the document pages/sheets that are to be fed into the ADF. Load them with their face down.

Paper Chute Extension

Extended when scanning long documents.

Chute Roller Cover

A cover to prevent your finger(s) from being caught by the Chute Roller.

Side Guide

Prevents documents from being skewed during feeding. Adjust the guide to the width of the document loaded.

Side Guide Button

Adjusts the position of the Side Guide when kept pressed. Locks the Side Guide at the position when this button is released.

Operator Panel

Comprises a Function Number Display, operating push buttons, and LEDs. Used to operate the scanner and monitor the status. Two panels are mounted; one each on each side. You can use whichever is convenient for you. The panels are of quick-open type, and can be folded back in place when not used.

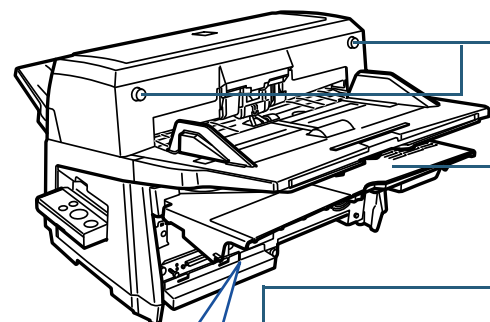

ADF Open Button (Common)

Opens the ADF. Push the buttons in to open the ADF.

Cable Cover (Common)

A cover to house the cablings inside to protect them. The cables are let out from either side of the cover to avoid tangling.

CGA Board Slot (fi-6670 only)

Remove the cover to install a CGA or optional board. The fi-6670A mounts a CGA board. For details of the CGA board, refer to ["A.4 Scanner Options" \(on page 180\)](#).

Main Power Switch (Common)

Used to turn the scanner ON and OFF.

Power Connector (Common)

A connector for a power cable.

Ventilation Port (Common)

An open port for ventilating hot air from inside the scanner.

SCSI Connector 1 (Common)

A connector for a SCSI interface cable.

SCSI ID Switch (Common)

Used to configure a SCSI ID (ID=5 by factory setting).

USB Connector 1 (Common)

A connector for a USB interface cable.

CGA Board (fi-6670A only)

For details of the CGA board, refer to ["A.4 Scanner Options" \(on page 180\)](#).

USB Connector 2 (fi-6670A only)

A connector for a USB interface cable.

SCSI Connector 2 (fi-6670A only)

A connector for a SCSI interface cable.

fi-6670

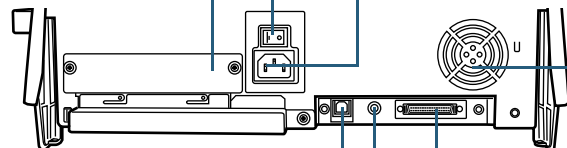

fi-6670A

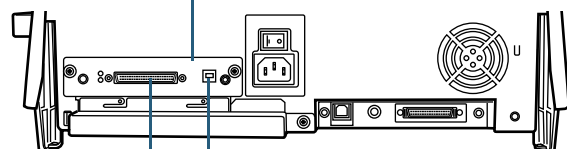

- TOP
- Contents
- Index
- Introduction
- Scanner Overview**
- Loading Documents
- Scan Parameters
- Various Documents
- Daily Care
- Consumables
- Troubleshooting
- Operational Settings
- Appendix
- Glossary

fi-6770/fi-6770A/fi-6750S (Flatbed Type)

ADF (Automatic Document Feeder)

Feeds documents to the scanning position automatically. Documents are fed sheet by sheet when loaded for batch scanning. The fi-6770/fi-6770A can scan both sides of documents at one time.

Stacker Extension

Pull out the extension according to the document length.

Stopper

Raise it if the documents loaded are long.

Stacker

Scanned documents are ejected from the ADF onto this stacker. You can adjust the height of the stacker at lower or upper position. Is removable.

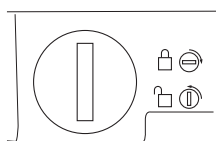

Transport Lock

Locks the carrier unit inside the Flatbed during transportation. Use a coin or similar to unlock it. Turn the slot to a vertical position to release the lock; to a horizontal position to lock it.

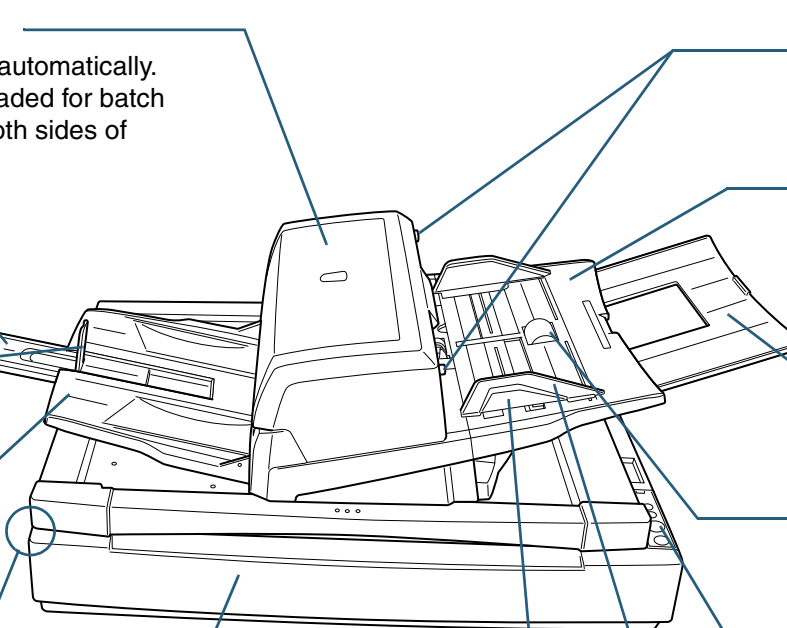

Flatbed

Place them on the glass sheet by sheet for manual scanning. Allows for scanning thick documents such as books.

Side Guide Button

Adjusts the position of the Side Guide when kept pressed. Locks the Side Guide at the position when this button is released.

ADF Open Button

Opens the ADF. Push the buttons in to open the ADF.

ADF Paper Chute

Holds in place the document pages/sheets that are to be fed into the ADF. Load them with their face down.

Paper Chute Extension

Extended when scanning long documents.

Chute Roller Cover

A cover to prevent your finger(s) from being caught by the Chute Roller.

Operator Panel

Used to operate the scanner and monitor the status. Comprises a Function Number Display, operating push buttons, and LEDs.

Side Guide

Prevents documents from being skewed during feeding. Adjust the guide to the width of the documents loaded.

Lock Screw Storage Hole

Stores the ADF Lock Screws that were removed after the ADF has been unlocked.

ADF Lock Screw

Fixes the ADF.

Document Bed

Place documents on the glass when scanning through the flatbed.

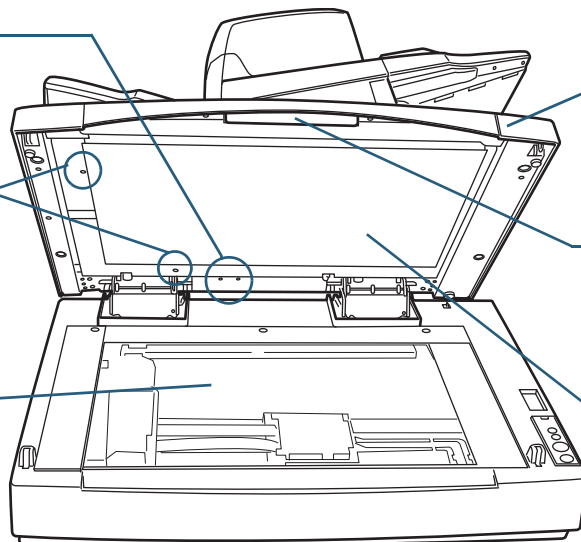

Document Cover

Holds the loaded documents at the scanning position when closed.

Handle

Used to open and close the Document Cover.

Document Holding Pad

Holds documents to the Document Bed.



The Document Cover with a black document holding pad is optionally available. This type is convenient for scanning documents in black background when loading them from the flatbed. This option allows you to correct skewed document images after scanned with the flatbed and to recognize the size of document to output at its original size.

Name: Black Document Pad
Parts No.: PA03338-D960

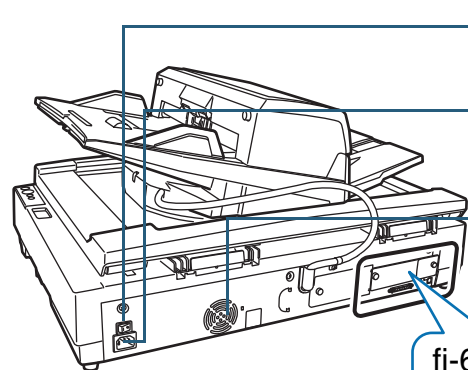

Main Power Switch (Common)

Used to turn the scanner ON and OFF.

Power Connector (Common)

A connector for the power cable.

Ventilation Port (Common)

An open port for ventilating hot air from inside the scanner.

fi-6770

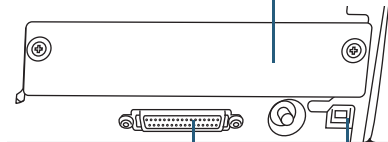

CGA Board Slot (fi-6770 only)

Connects a CGA board.

For details of the CGA board, refer to ["A.4 Scanner Options" \(on page 180\)](#).

SCSI ID Switch (fi-6770/fi-6770A only)

Used to configure a SCSI ID (ID=5 by factory setting).

SCSI Connector 1 (fi-6770/fi-6770A only)

A connector for a SCSI interface cable.

fi-6770A

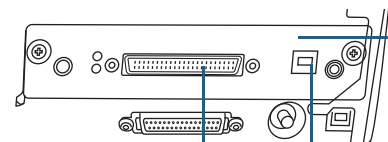

CGA Board (fi-6770A only)

For details of the CGA board, refer to ["A.4 Scanner Options" \(on page 180\)](#).

USB Connector 2 (fi-6770A only)

A connector for a USB interface cable.

SCSI Connector 2 (fi-6770A only)

A connector for a SCSI interface cable.

fi-6750S

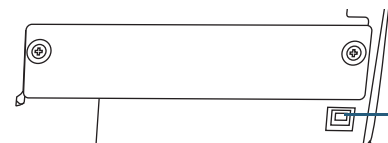

USB Connector 1 (Common)

A connector for a USB interface cable.

Model-Common Parts

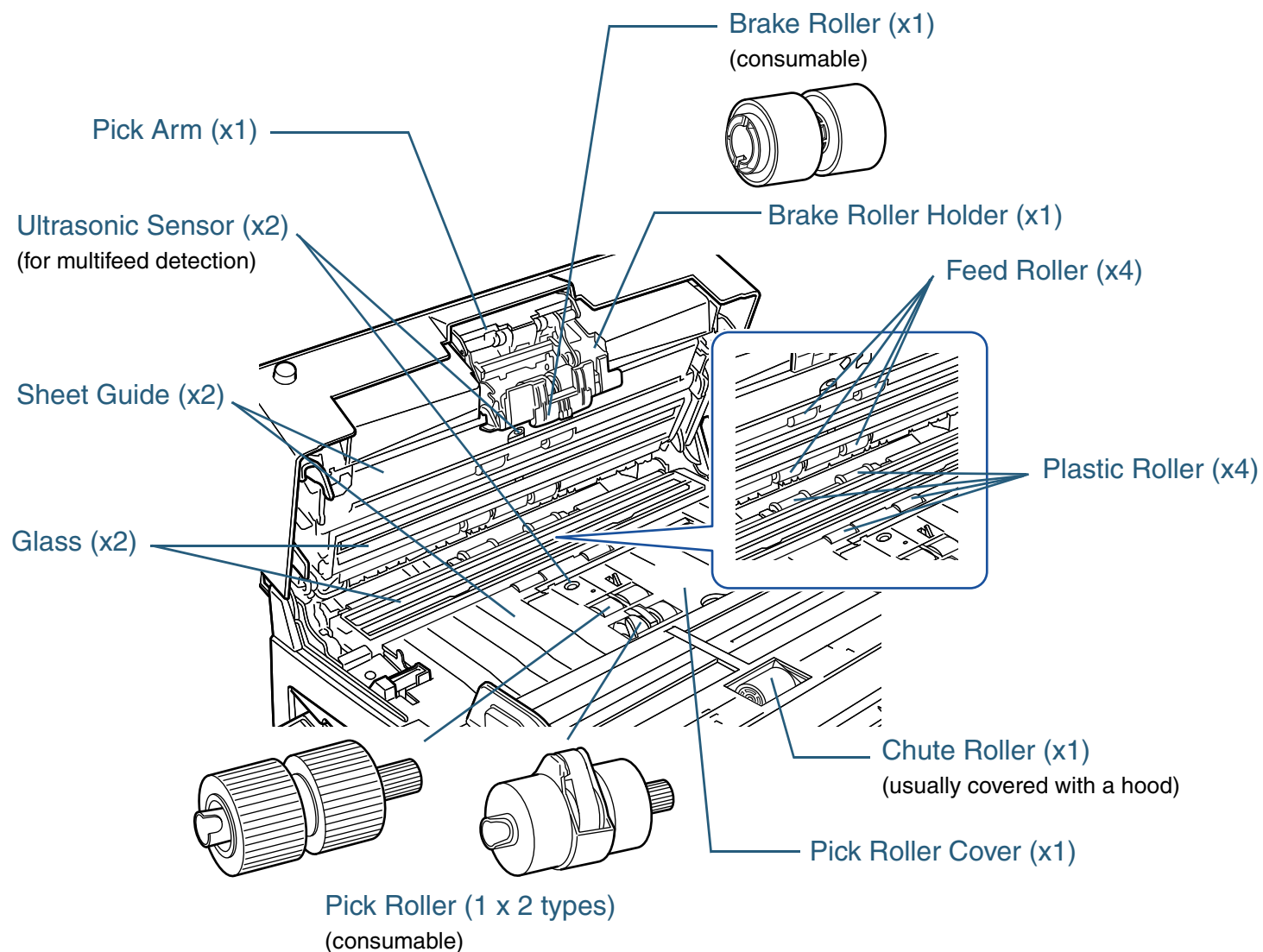

TOP

Contents

Index

Introduction

Scanner
Overview

Loading
Documents

Scan
Parameters

Various
Documents

Daily Care

Consumables

Trouble-
shooting

Operational
Settings

Appendix

Glossary

1.3 Functions of the Operator Panels

The Operator Panel Consists of a Function Number Display, operating push buttons, and LEDs.

Operator Panel

fi-6670/fi-6670A (ADF Type)

Two Operator Panels are mounted on the scanner; one each on each side. You can use whichever is convenient for you. They can be folded back in place when not used.

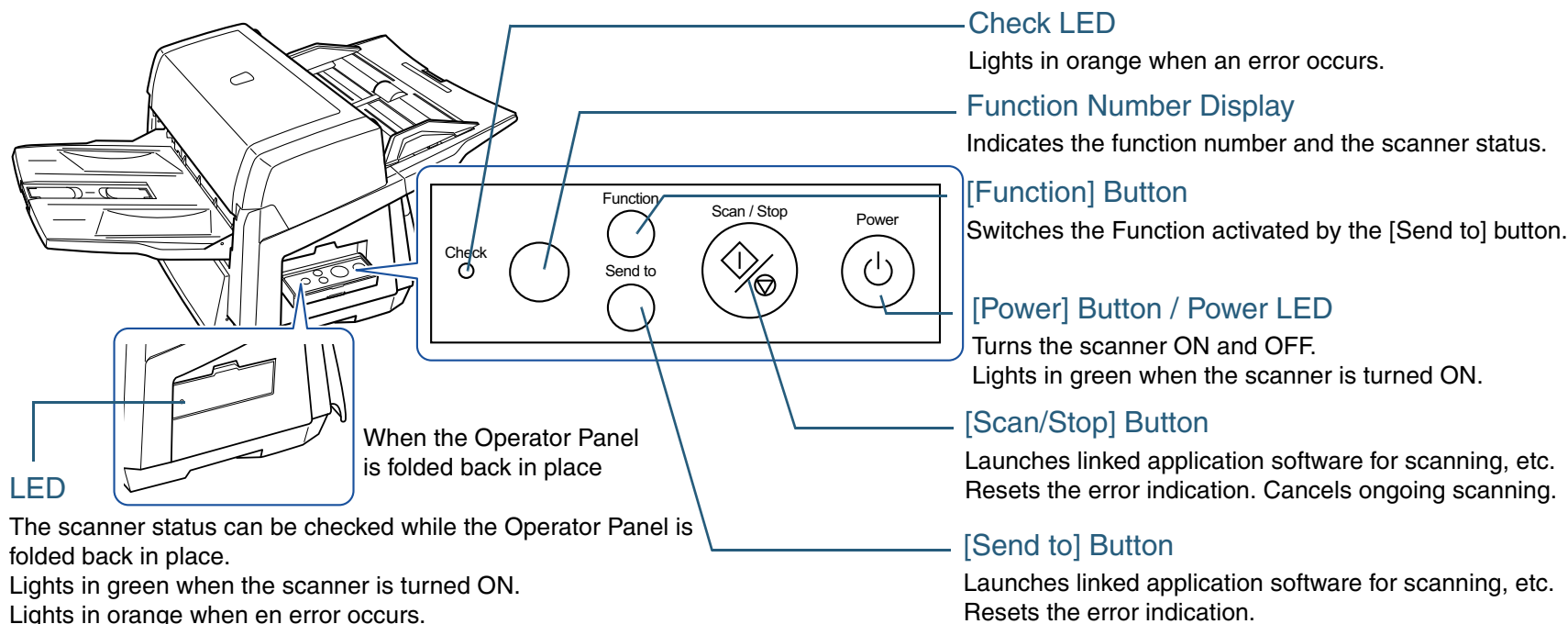

For details of how to scan documents using the [Scan/Stop] or [Send to] button, refer to the TWAIN Scanner Driver Help included in the Setup DVD-ROM, and the section "[Using the Scanner Buttons to Start A Scan Quickly](#)" (on page 90).

fi-6770/fi-6770A/fi-6750S (Flatbed Type)

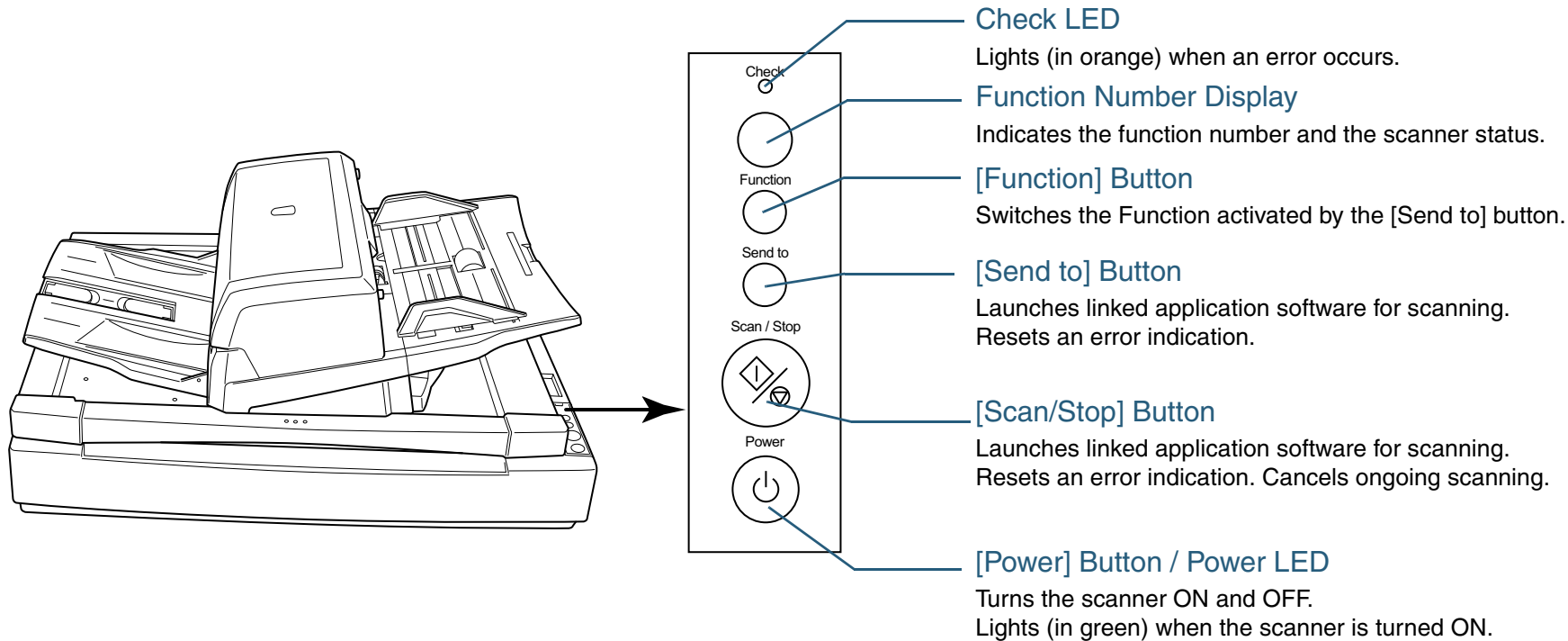

For details of how to scan documents using the [Scan/Stop] or [Send to] button, refer to the TWAIN Scanner Driver Help included in the Setup DVD-ROM, and the section ["Using the Scanner Buttons to Start A Scan Quickly"](#) (on page 90).

Indications on the Function Number Display

Indication	Explanation
8	Blinks only one time upon turning on the scanner.
P	Indicates that the scanner has been turned ON and is being initialized.
1	Indicates that initialization has ended successfully. This status is called "Ready Status" in which you can perform a scan.
J U	Indicates that a recoverable error occurred during scanning. "J" or "U" and an "error number" are displayed alternately. For error details, refer to "Temporary Errors" (on page 116) . After the error has been resolved, you can return to the Ready Status (see "1" above) by pressing the [Stan/Stop] or [Send to] button.
E F C H A L	Indicates that an abnormality (device error) occurred in the scanner during its initialization or during scanning documents. "E", "F", "C", "H", "A", or "L" and an "error number" are displayed alternately. For details of the errors, refer to "Device Errors" (on page 117) . If this error occurs, turn the Main Power Switch OFF and then ON again. If the error persists after this, contact the store where you purchased the scanner or an authorized FUJITSU scanner service provider.

TOP

Contents

Index

Introduction

Scanner
OverviewLoading
DocumentsScan
ParametersVarious
Documents

Daily Care

Consumables

Trouble-
shootingOperational
Settings

Appendix

Glossary

1.4 Turning the Scanner ON and OFF

This section describes how to turn the scanner ON and OFF.

Turning the Scanner ON

The following shows the procedure for turning the scanner ON.



For a SCSI cable connection, be sure to turn on your computer **AFTER** turning on the scanner, and making sure number "1" indicates on the Function Number Display.

- 1 Press the "I" side of the Main Power Switch.

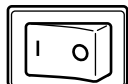

- 2 Press the [Power] button on the Operator Panel.

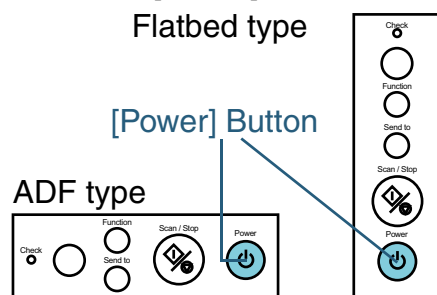

⇒ The scanner is turned on, and the Power LED lights in green.

Note that, while the scanner is being initialized, the Function Number Display changes as follows: "8" ⇔ "P" ⇔ "1", where "1" means the scanner is in the Ready Status.



Use the Main Power Switch to turn the power ON if the Operator Panel power switch has been disabled. For details, refer to ["8.7 Settings Related to Power ON/OFF Control" \(on page 171\)](#).

Turning the Scanner OFF

The following shows the procedure for turning the scanner OFF.

- 1 Press the [Power] button on the Operator Panel for more than 2 seconds.

⇒ The power is turned off and the Power LED goes off.



- If you will not use the scanner for a long time, press the "O" side of the Main Power Switch to turn the power OFF. Then, unplug the scanner from the power outlet.

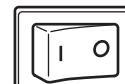

- Use the Main Power Switch to turn the power OFF if the Operator Panel power switch has been disabled. For details, refer to ["8.7 Settings Related to Power ON/OFF Control" \(on page 171\)](#).

1.5 Power Save Mode

The Power Save mode is a state in which the powered scanner is kept in a low-powered state if it has not been operated for a certain period of time.

If no operation is performed on the scanner for 15 minutes, the scanner automatically switches to the Power Save mode.

In the Power Save mode, the indication of the Function Number Display on the Operator Panel goes out, but the Power LED stays lit in green.

Returning from Power Save Mode

To return from Power Save mode, perform one of the following:

- Load some sheet of paper on the ADF Paper Chute.
- Hit any button on the Operator Panel. Do not press down the [Power] button for more than 2 seconds. This will turn off the scanner.
- Execute a command from the scanner driver.



You can change the time interval for switching to Power Save mode by using the Software Operation Panel. For details, refer to "[Setting the Wait Time in Power Saving Mode \[Power saving\]](#)" (on page 170).

TOP

Contents

Index

Introduction

Scanner
OverviewLoading
DocumentsScan
ParametersVarious
Documents

Daily Care

Consumables

Trouble-
shootingOperational
Settings

Appendix

Glossary

1.6 Basic Flows of Scanning Documents

This section explains about the basic flow of performing a scan.

In order to perform a scan, you need a scanner driver and an application that supports the scanner driver.

This product bundles the TWAIN driver and the ISIS driver (compliant to the respective standards), Kofax VRS, and an application called "ScandAll PRO" which supports both drivers and Kofax VRS.



- For details about the scanner drivers, refer to the following:
 - ["Chapter 3 Scan Parameters" \(on page 51\)](#)
 - TWAIN Scanner Driver Help
 - ISIS Scanner Driver Help
- For details about Kofax VRS, refer to:
 - Kofax VRS Help
- For details of ScandAll PRO, refer to the following:
 - ScandAll PRO V2.0 User's Guide
 - ScandAll PRO Help

1 Turn the scanner ON.

For how to turn on the scanner, refer to ["1.4 Turning the Scanner ON and OFF" \(on page 31\)](#).



- For a SCSI cable connection, be sure to turn on your computer AFTER turning on the scanner, and making sure number "1" indicates on the Function Number Display.
- Turn off the scanner and your computer first when you switch the interface cable.

2 Load a target document on the scanner.

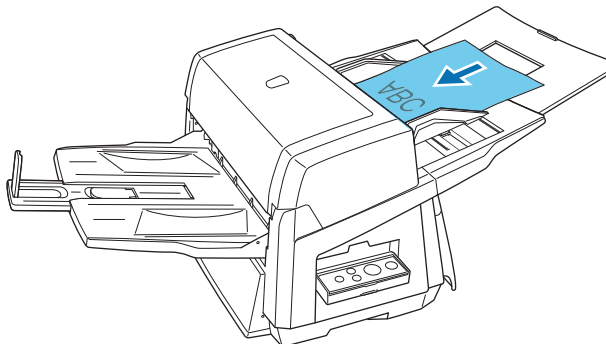

For how to load documents on the scanner, refer to ["Chapter 2 Loading Documents" \(on page 38\)](#).

3 Launch an application you want to use for scanning.

The following steps show example windows when ScandAll PRO is selected.

When ScandAll PRO is launched:

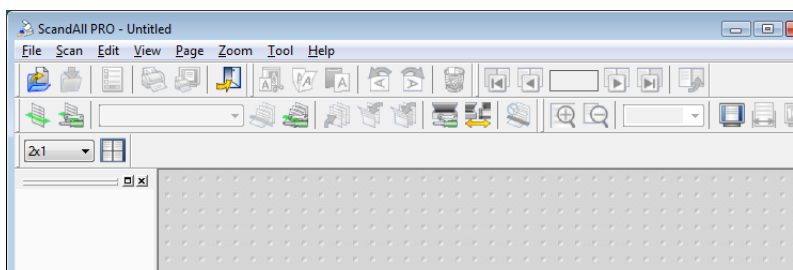

For how to launch ScandAll PRO, refer to ["ScandAll PRO V2.0 User's Guide"](#).

4 Select a scanner driver to use.

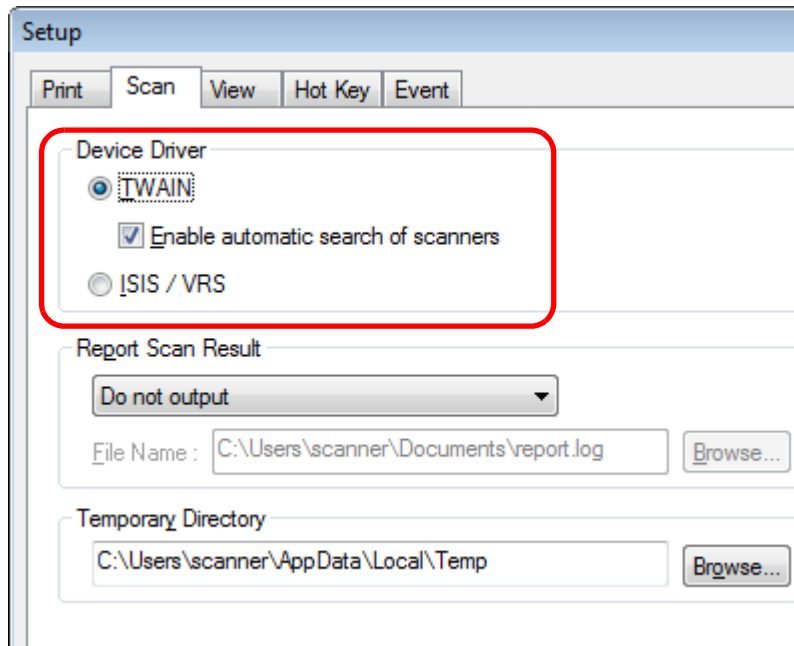

5 Select a scanner to use.

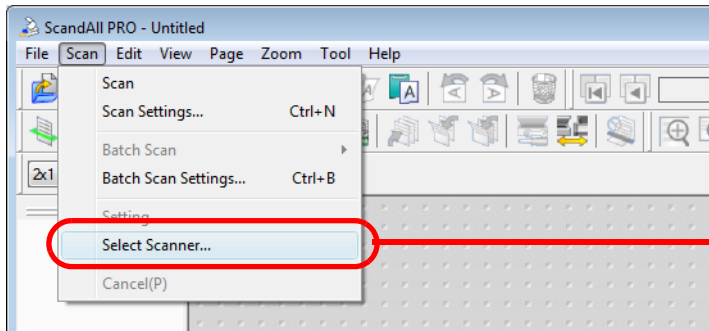

TWAIN scanner driver

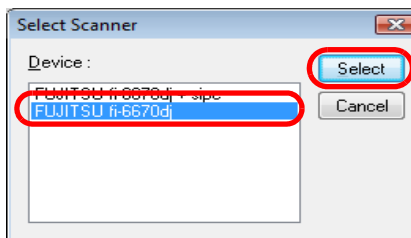

ISIS scanner driver

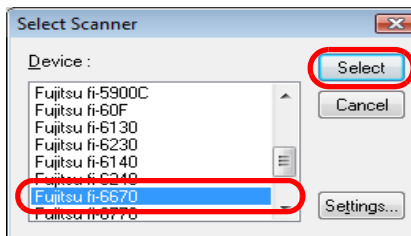

Kofax VRS

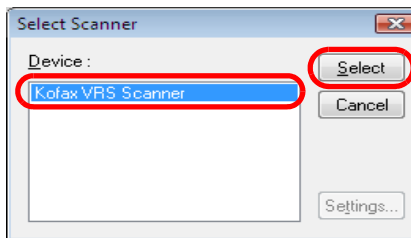

- TOP
- Contents
- Index
- Introduction
- Scanner Overview**
- Loading Documents
- Scan Parameters
- Various Documents
- Daily Care
- Consumables
- Trouble-shooting
- Operational Settings
- Appendix
- Glossary

6 In the application, invoke a scanner driver.

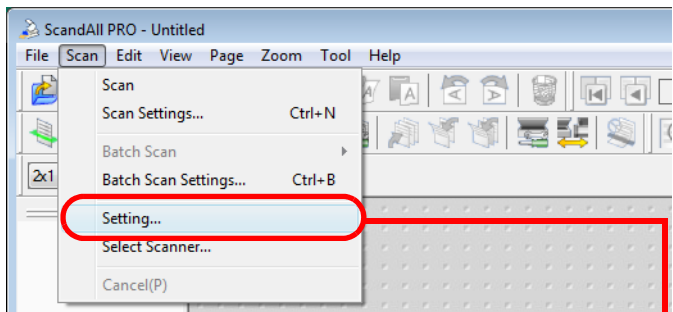

Twain scanner driver

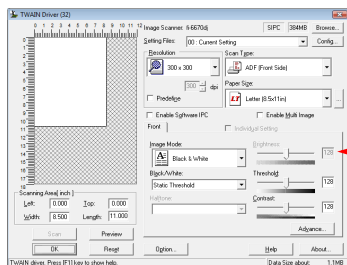

ISIS scanner driver

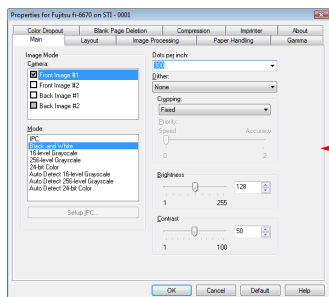

Kofax VRS

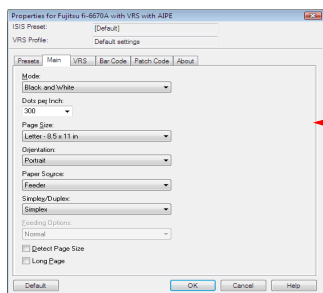

7 In the scanner driver's setting dialog box, configure scan parameters.

8 Perform a scan.

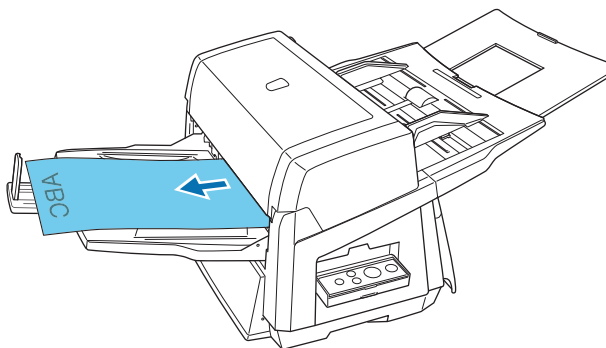

For how to scan using ScandAll PRO, refer to "ScandAll PRO V2.0 User's Guide".

9 Save the scanned document images to a file.



The procedures and operation slightly may differ depending on the application you use. For how to scan documents using ScandAll PRO, refer to "ScandAll PRO V2.0 User's Guide". If you want to use other applications for scanning, refer to the respective manuals that come with the applications.

1.7 Image Scanning Application

This section explains about the bundled “ScandAll PRO” image scanning application, which is used as an example to explain the procedures in this manual.

ScandAll PRO supports both TWAIN and ISIS drivers. By defining scan settings as profiles, you can customize the settings according to your preference.

When ScandAll PRO is installed, you can also install “ScandAll PRO ScanSnap mode Add-in”. This is an add-in application which provides a different set of driver settings as an alternative to using ScandAll PRO. TWAIN driver is required to use this application. Using the ScandAll PRO ScanSnap mode Add-in enables easy scanning with a single button.



You cannot use ScandAll PRO ScanSnap mode Add-in in the following cases:

- When the scanner is connected to fi-5000N
- When the scanner is connected with a SCSI cable

["Chapter 4 Various Documents" \(on page 61\)](#) explains how to scan different types of documents by using examples of the TWAIN driver started via ScandAll PRO.

For more details about ScandAll PRO, refer to “ScandAll PRO V2.0 User’s Guide”.

For details about ScandAll PRO ScanSnap mode Add-in, refer to the ScandAll PRO ScanSnap mode Add-in V1.0 User’s Guide.

[TOP](#)[Contents](#)[Index](#)[Introduction](#)[Scanner Overview](#)[Loading Documents](#)[Scan Parameters](#)[Various Documents](#)[Daily Care](#)[Consumables](#)[Trouble-shooting](#)[Operational Settings](#)[Appendix](#)[Glossary](#)

1.8 Centralized Management of Scanners

This section explains about managing a large number of scanners in a unified manner by providing the following capabilities.

- Simultaneously update settings for multiple scanners and their drivers.
Because there is no need to update each scanner one by one, a significant reduction is achieved in the time required to update a large number of scanners.
- Monitor scanners to check for any consumable parts that require replacement, or the occurrence of errors.
The alerts for consumable part replacement and errors are provided by scanners, which provides an easy way of checking the operating status of scanners.

To enable the above functions, "Scanner Central Admin" is required which consists of four applications bundled with this product:

- **Scanner Central Admin Server**
Install this application in the main computer that is used for the centralized management of scanners.
By registering scanners on the Scanner Central Admin Server, you can build a system to run a unified management for all scanners.
- **Scanner Central Admin Console**
Install this application in a computer to upload update modules and to monitor the operating status of the scanners.
The administrators can perform these tasks from the Scanner Central Admin Console window, where they can also check the alerts for consumable replacement and errors sent from the scanners.
- **Scanner Central Admin Agent**
Install this application in a computer connected to a scanner. It allows scanners to link with the Scanner Central Admin Server.

Linking with the Scanner Central Admin Server will enable you to apply updates on scanner settings, and the scanner can also send alerts on consumable replacement and errors.

- **SCAModule Creator**

Use this application to create update modules to upload onto the Scanner Central Admin Server.

It is only required for creating update modules.

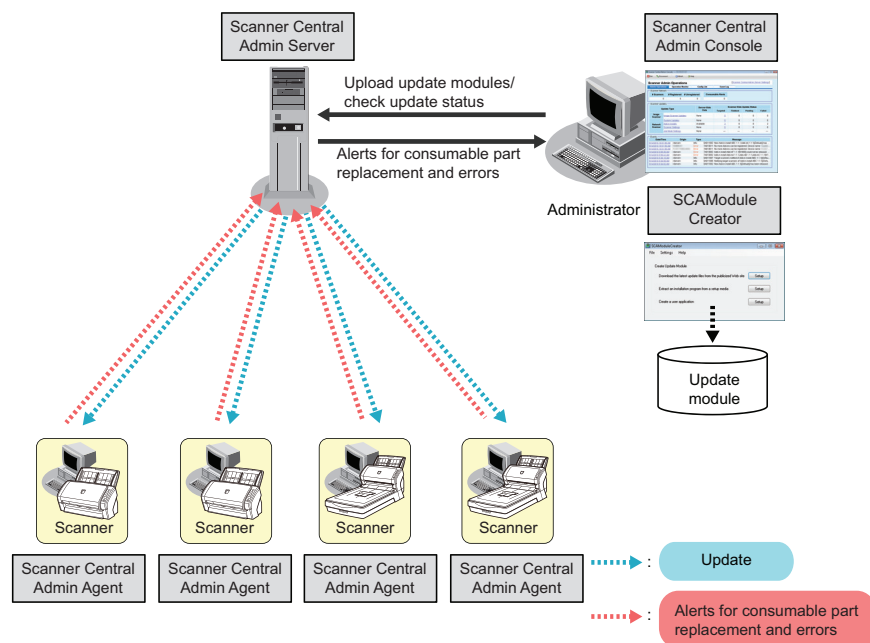

For more details, refer to the Scanner Central Admin 4.0 User's Guide.

Chapter 2 Loading Documents

This chapter describes how to load documents on the scanner.

2.1 Loading Documents on the ADF	39
2.2 ADF-Loaded Documents	42
2.3 Changing the ADF Position (Flatbed Type Only)	48
2.4 Loading Documents on the Flatbed (Flatbed Type Only)	50

[TOP](#)

[Contents](#)

[Index](#)

[Introduction](#)

[Scanner
Overview](#)

[Loading
Documents](#)

[Scan
Parameters](#)

[Various
Documents](#)

[Daily Care](#)

[Consumables](#)

[Trouble-
shooting](#)

[Operational
Settings](#)

[Appendix](#)

[Glossary](#)

2.1 Loading Documents on the ADF

This section describes how to load documents on the ADF.



- Refer to ["2.2 ADF-Loaded Documents" \(on page 42\)](#) for information about the required document sizes and paper quality for ensuring correct operation when scanning documents from the ADF.
- Refer to ["2.3 Changing the ADF Position \(Flatbed Type Only\)" \(on page 48\)](#) for how to change the ADF position (Flatbed type only).

1 Align the edge of your document.

- Confirm that all the document sheets have the same width.
- Check the number of sheets in the document stack.

The following is a guideline for the limits on loadable sheets:

- A4/Letter-size paper or smaller that makes a document stack of 20 mm (0.79 in.) or less (200 sheets with paper weight of 80 g/m² (20 lb))
- A4/Letter-size paper or larger that makes a document stack of 10 mm (0.39 in.) or less (100 sheets with paper weight of 80 g/m² (20 lb))

For details, refer to ["Maximum Document Loading Capacity" \(on page 44\)](#).

2 To avoid sticky edges, fan the document as follows:

- Hold both ends of the document, and bend the document stack into an arch.

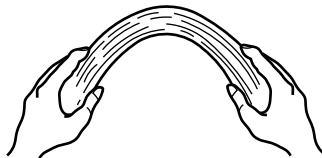

- Firmly holding the document with both hands, bend it back so that the bent section rises up in the middle of the document as follows.



- Repeat Steps 1 to 2 twice or three times.
- Turn the document stack by 90 degree, and then fan it in the different orientation again.
- Align the edge of the document.



For details of how to fan documents, refer to the Error Recovery Guide. You can find the Error Recovery Guide in the Setup DVD-ROM. For how to install the Error Recovery Guide, refer to "Chapter 4 Installing the Scanner Software" in the Getting Started.

3 Load the document on the ADF Paper Chute.

Load it face down on the ADF Paper Chute.

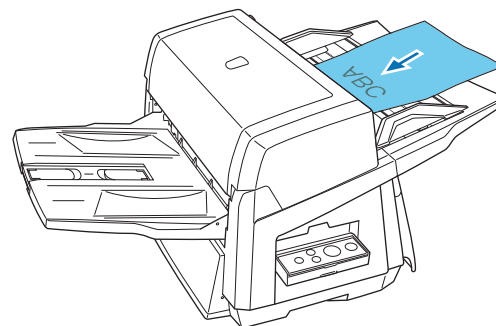

For how to load documents with tabs or non-rectangular documents, refer to "[Loading Documents with Tabs or Non-Rectangular Documents](#)" (on page 45).



According to the length of your document, slide the Paper Chute Extension out from the ADF Paper Chute up to the position where the document can be fully supported.

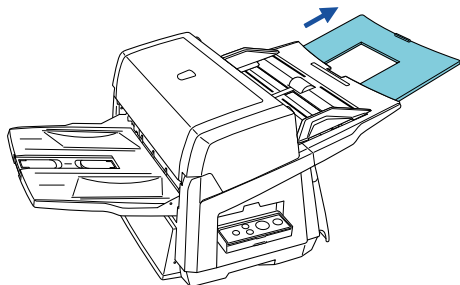

When scanning plastic cards, take a special care for the following:

- Place one card at a time on the ADF Paper Chute.
- It is recommended that the front side of the card be placed face down in the ADF.
- Place the card in the following orientation (portrait).

Place face down.

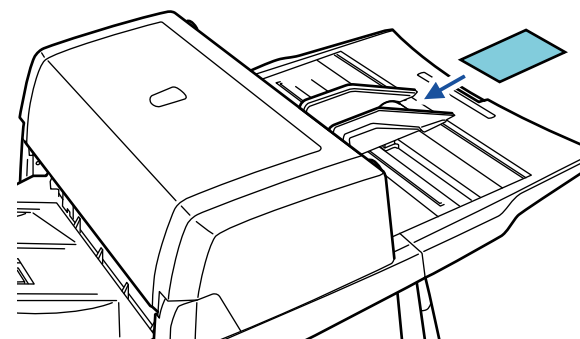

- Cards to be scanned should satisfy:
ISO7810 type ID-1 type compliant card
Size : 86 mm (height) x 54 mm (width)
(3.39 in. x 2.13 in.)
Thickness : 0.76 ± 0.08 mm (0.030 ± 0.003 in.)
Material : Poly vinyl chloride (PVC) or Polyvinyl chloride acetate (PVCA)
Before scanning your card, test with a dummy card of the same material to see if it can be fed into the ADF properly.
- Embossed cards cannot be scanned.
- Cards that are excessively rigid or stiff may not feed smoothly.
- Clean off greasy finger prints if any from the surface of your card before scanning.
- Cards cannot be scanned when the imprinter is installed.

- 4** Adjust the Side Guides to the width of the document. Slide the Side Guides so that they will touch both sides of the document tightly.

Any gap between the Side Guides and the document edges may make the scanned images skewed.

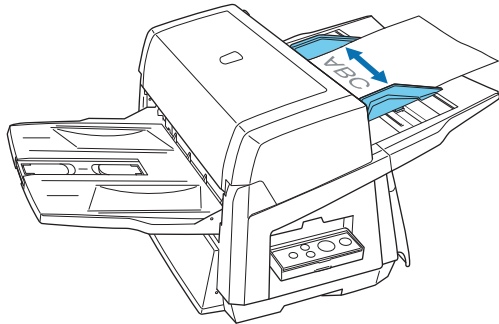

- Remove paper clips or staples from the document. If a multifeed or mis-picking occurs, reduce the number of the document in the ADF Paper Chute.
- When loading a small document, be careful not to touch the hood for the Chute Roller during scanning. Doing so may let the hood open, which may catch your finger.

- 5** Pull out the Stacker Extension to the length of the document, and then raise the Stopper to stop the document.

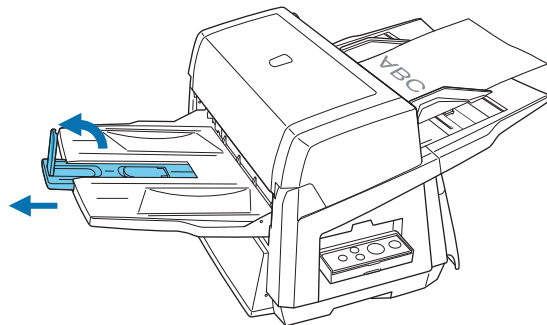

Adjust the height of the Stacker according to the paper type of the document. Select the lower position for ordinary use. When scanning a thin or curled document, select the upper position.

Lower position (Normal paper)

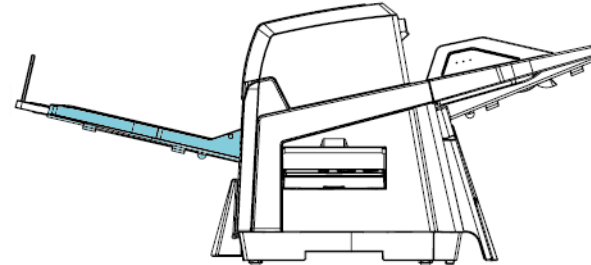

Upper position (Thin paper)

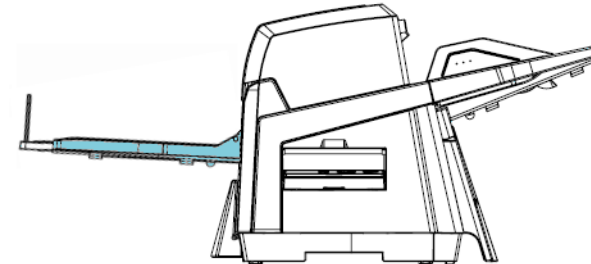

The number of document sheets loadable on the ADF decreases when the upper position is selected (about 100 sheets if the paper weight is 80 g/m² (20 lb)).

- 6** Start up the application supported by the scanner to scan the document.

For how to scan documents using ScandAll PRO, refer to "ScandAll PRO V2.0 User's Guide".

2.2 ADF-Loaded Documents

Sizes

The following shows the sizes of documents scannable with the ADF.

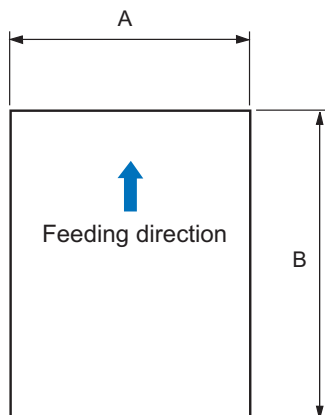

A : 53 mm (2.09 in.) to 297 mm (11.69 in.)

B : 74 mm (2.91 in.) to 431 mm (16.97 in.) (*1)

*1: Up to 3 m (118.11 inches) of documents can be scanned when "Long page" is selected in [Scan Type].

Paper Quality

Paper Types

The following types of paper are recommended as the scannable documents:

- Woodfree paper
- Wood containing paper

For documents of paper types other than the above, check if they can be scanned; test with a few dummy sheets of the same paper type before scanning the actual document.

Paper Thicknesses

Paper thickness is expressed by "paper weight." The paper thicknesses allowable for scanning on this scanner are as follows:

- A4/Letter size or smaller : 31 g/m² to 209 g/m² (8.3 lb to 56.1 lb)
- Size larger than A4/Letter : 52 g/m² to 209 g/m² (14.0 lb to 56.1 lb)
- A8 size : 127 g/m² to 209 g/m² (34 lb to 56.1 lb)

TOP

Contents

Index

Introduction

Scanner
OverviewLoading
DocumentsScan
ParametersVarious
Documents

Daily Care

Consumables

Trouble-
shootingOperational
Settings

Appendix

Glossary

Precautions

The following types of documents may not be scanned successfully:

- Documents of non-uniform thickness (e.g., envelopes and photo-attached documents)
- Wrinkled or curled documents
- Folded or torn documents
- Tracing paper
- Coated paper
- Carbon paper
- Photosensitive paper
- Perforated documents
- Documents that are not square or rectangular
- Very thin documents
- Photographs (Photographic paper)

You must not scan the following types of documents:

- Paper-clipped or stapled documents
- Documents on which the ink is still wet
- Documents smaller than A8 size
- Documents wider than A3 size (297 mm or 11.69 in.)
- Documents other than paper such as fabric, metal foil, or transparencies
- Important documents such as certificates and cash vouchers that must not get scratched or become smeared



- When scanning a semi-transparent document, slide the [Brightness] bar to light to avoid bleed through.
- To prevent the rollers from becoming dirty, avoid scanning documents containing large areas written or filled with pencil.
- When using the ADF, the leading edge of all document sheets must be evenly aligned. Make sure that curling at the leading edge is within the following tolerances:

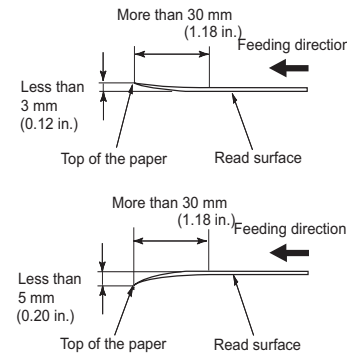

- Carbonless paper contains chemical substances that may harm the Brake Rollers or paper-feeding rollers (e.g. Pick Rollers) when documents are fed. Pay attention to the following:
 - Cleaning :**
If document jams occur frequently, clean the Brake Rollers and the Pick Rollers. For how to clean the Brake and Pick Rollers, refer to "[Chapter 5 Daily Care](#)" (on page 97).
 - Replacing parts :**
The service life of the Brake Rollers and the Pick Rollers for scanning "carbonless paper" may be shorter than that for scanning "wood containing paper."
- The service life of the Brake Rollers and the Pick Rollers for scanning "wood containing paper" may become shorter than that for scanning "woodfree paper."
- The Brake Rollers or Pick Rollers could be damaged if any photos or sticky notes on your document have contact with the Brake Rollers or Pick Rollers during scanning.
- Scanning documents of calendered paper, such as photos, may damage their surface.

Maximum Document Loading Capacity

The maximum number of sheets that can be loaded on the ADF Paper Chute is determined by the size and thickness of document. See the following graph:

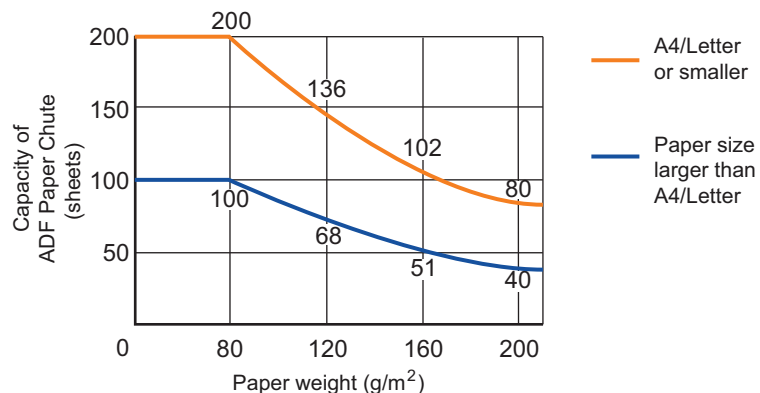

Paper thickness (Unit)	Conversion										
	31	40	52	64	75	80	90	104	127	203	209
g/m ² (paper weight)											
lb	8.3	11	14	17	20	21	24	28	34	54	56.1
kg	26.7	35	45	55	64.5	69	77.5	90	110	174	180



- The paper weight available for a size larger than A4/Letter ranges from 52 g/m² to 209 g/m² (14.0 lb to 56.1 lb).
- The paper weight for A8 size ranges from 127 g/m² to 209 g/m² (34 lb to 56.1 lb).

Area Not to be Perforated

When using the ADF, a document error might occur if there are punched hole(s) in the blue-shaded area as in the following figure. When using the flatbed-type scanner, you should scan such a document through its flatbed.

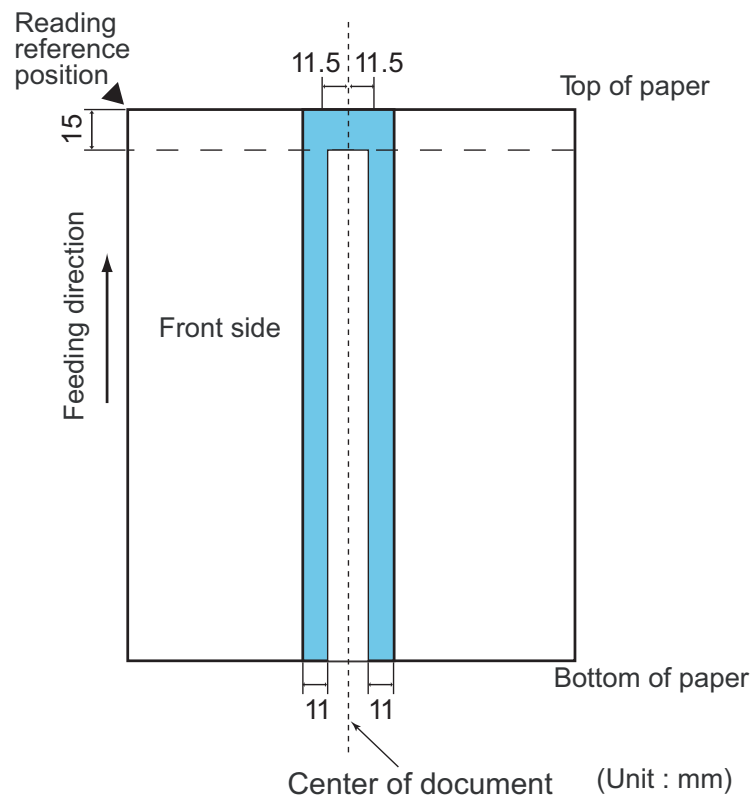

Loading Documents with Tabs or Non-Rectangular Documents

To scan a document with a tab attached at its bottom or a non-rectangular document, place it on the scanner so that its tab or clipped section will be fed last through the ADF.

Good Example:

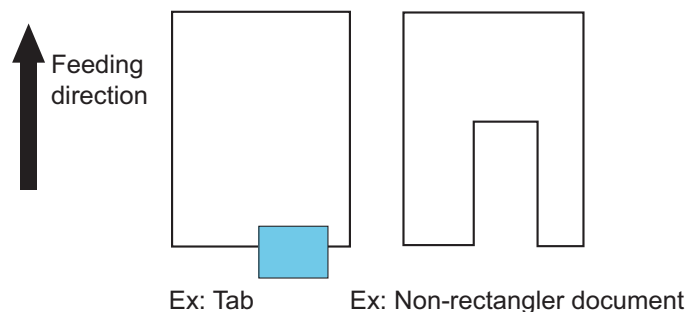

Bad Example:

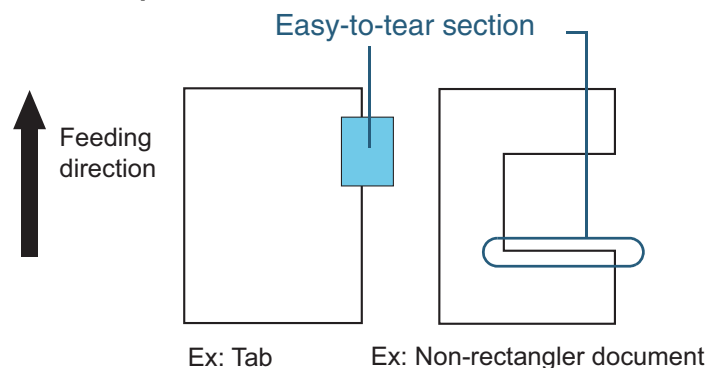

- If scanning a document as in the bad example above, the indicated section may be caught during feeding. This might cause a paper jam or make the document torn.
- If the non-rectangular section or tab of the document (see the figures above) is off the paths of the two Feed Rollers inside, it will not be fed properly. As a result, this part will remain in the ADF, and make the scanned image elongated accordingly.

Multifeed Detection Conditions

A multifeed refers to an error that occurs when more than one sheet of paper is fed into the ADF at the same time.

There are three modes to detect multifeeds: document overlapping, document length, and both document overlapping and length. The following conditions must be satisfied in each of these detection modes.

Detection By Document Overlapping

- Load sheets of the same thickness on the ADF at a time.
- Document paper weight: of 31 g/m² to 209 g/m² (8.3 lb to 56.1 lb) (0.04 mm to 0.26 mm or 0.002 in. to 0.010 in.)
- Punched holes are not allowed within 35 mm (1.38 in.) of the vertical center line of document.
- Do not glue separate paper within 35 mm (1.38 in.) of the vertical center line of document.

Detection By Document Length

- Load sheets of the same length on the ADF at a time.
- Document length deviation: 1% or less
- Punched holes are not allowed within 35 mm (1.38 in.) of the vertical center line of document.

Detection By Document Overlapping and Length

- Load sheets of the same thickness and same length on the ADF at a time.
- Document thickness: 31 g/m² to 209 g/m² (8.3 lb to 56.1 lb) (0.04 mm to 0.26 mm or 0.002 in. to 0.010 in.)
- Document length deviation: 1% or less
- Punched holes are not allowed within 35 mm (1.38 in.) of the vertical center line of document.
- Do not glue separate paper within 35 mm (1.38 in.) of the vertical center line of document.

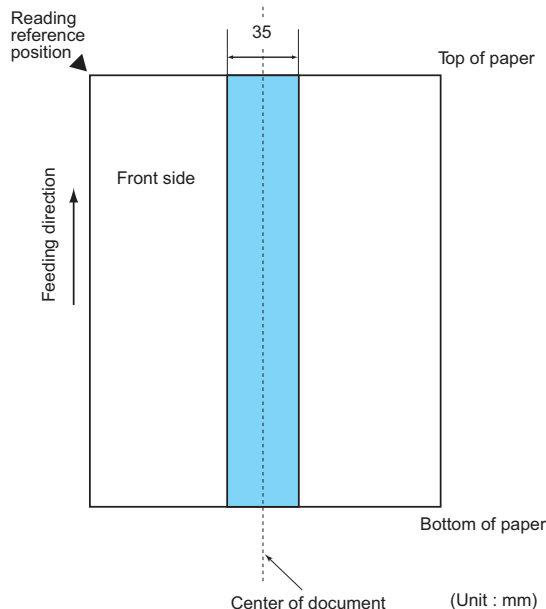

Limiting the Background Color Area

The area from the leading edge to 3 mm (0.12 in.) down in the scanning area must be in white color (as the document background color).

If [White Level Follower] is enabled, the following blue-shaded area must be either in a color that is the same as the document background color, or in the color to be dropped out. If your document contains any text, frame, or signature in this area, disable [White Level Follower].

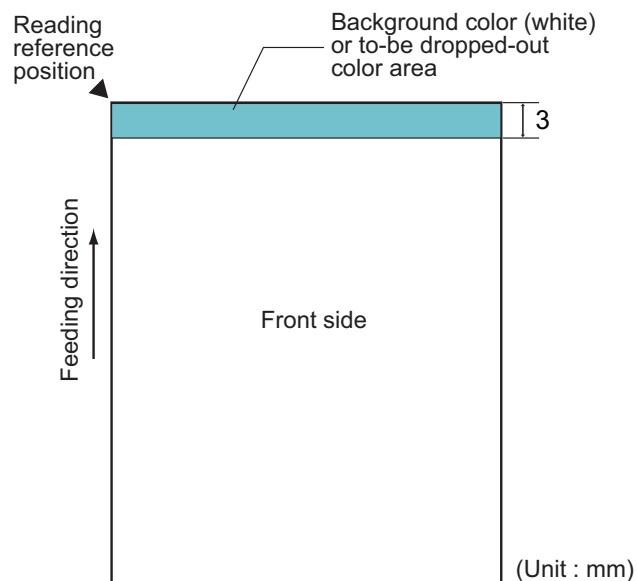

For details about [White Level Follower], refer to the TWAIN Scanner Driver Help.



Multifeed detection by document overlapping will often misdetect very thick paper or media such as plastic cards. When scanning documents like this, disable Multifeed Detection.



Some document types and/or some document conditions may cause the multifeed detection rate to drop. Multifeed Detection is not available in the area about 30 mm (1.18 in.) from the leading edge of document.

Job Separation Sheet

The following shows the typical format of the job separation sheet.

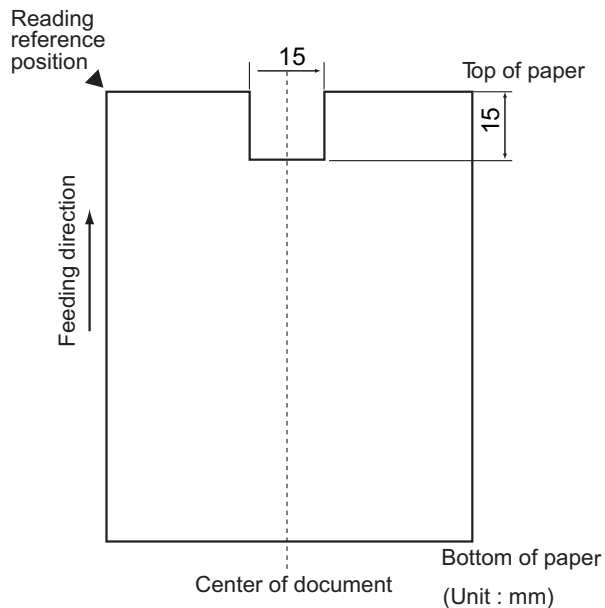

The document width must be A4/Letter (210 mm or 8.27 in.) or wider.

TOP

Contents

Index

Introduction

Scanner
Overview

Loading
Documents

Scan
Parameters

Various
Documents

Daily Care

Consumables

Trouble-
shooting

Operational
Settings

Appendix

Glossary

2.3 Changing the ADF Position (Flatbed Type Only)

This section describes how to change the ADF position.

- 1** Raise the Stacker.

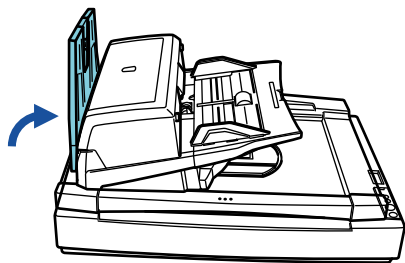

- 2** Holding the handle, lift up the Document Cover.

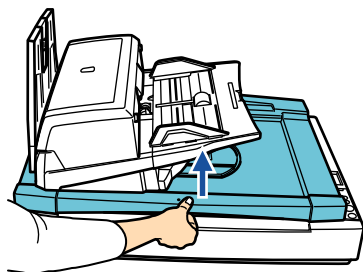

- 3** Remove the ADF Lock Screws, and fix them to the Lock Screw Storage Holes.

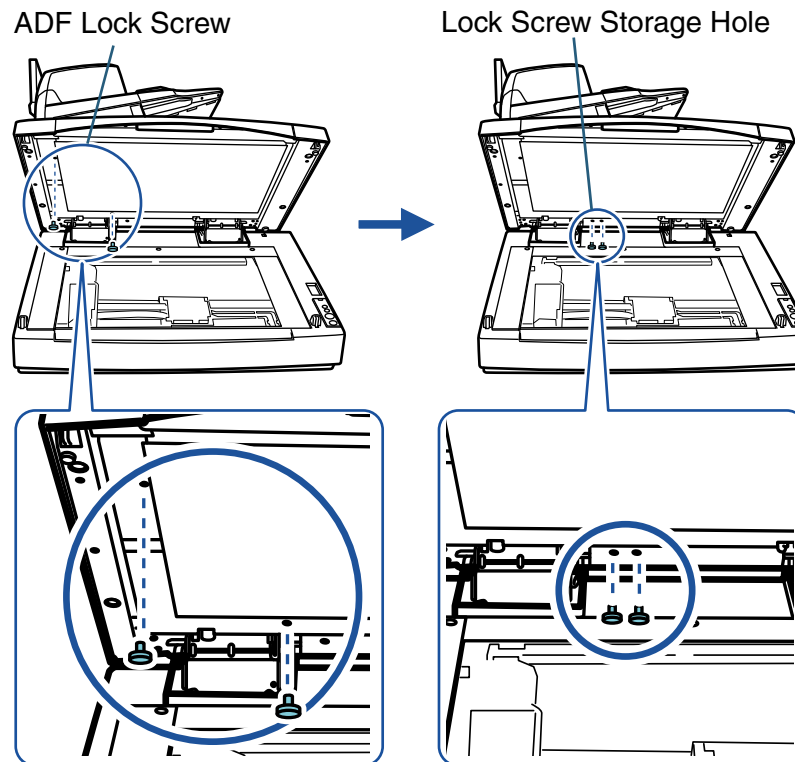

Make sure that the ADF Lock Screws have been inserted into the Lock Screw Storage Holes.

- 4** Gently close the Document Cover.

[TOP](#)[Contents](#)[Index](#)[Introduction](#)[Scanner Overview](#)[Loading Documents](#)[Scan Parameters](#)[Various Documents](#)[Daily Care](#)[Consumables](#)[Troubleshooting](#)[Operational Settings](#)[Appendix](#)[Glossary](#)

5 Change the position of the ADF.

Slide the ADF until it clicks into place. Make sure that the ADF is firmly locked to the installation position.

The three adjustable positions of the ADF are:

- Traditional (Traditional style set by default)

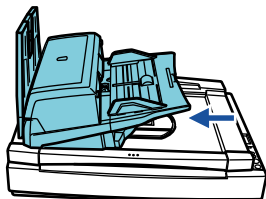

- Standard (Space-saving type and for right-handed operators)
Slide the ADF to the center of the scanner.

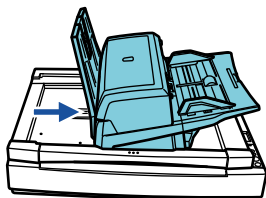

- Reversed (Space-saving type and for left-handed operators)
Slide the ADF to the center of the scanner, and then rotate it counterclockwise by 180 degree.

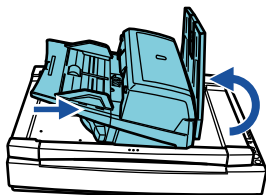

- Be careful not to get your fingers pinched while sliding the ADF.
- Do not rotate the ADF by more than 180 degree. Doing so may damage the ADF.

6 Let the Stacker down.

2.4 Loading Documents on the Flatbed (Flatbed Type Only)

This section describes how to load documents on the flatbed. The flatbed allows for easy scanning of thick documents such as books or irregularly-shaped documents.

- 1 Holding the handle, lift up the Document Cover.

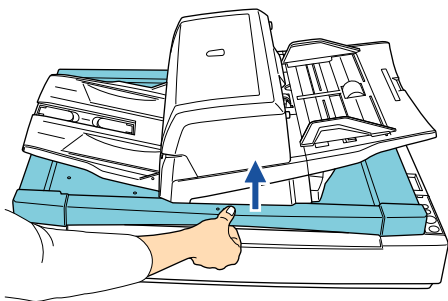

Make sure that no document is left on the ADF Paper Chute or on the Stacker.

- 2 Place a target document on the Document Bed face down and the top left corner aligned to the reference point.

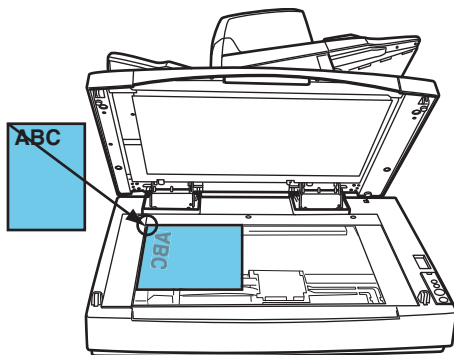

- 3 Gently close the Document Cover.

- 4 Start up an application which supports the scanner, and scan the document.

For how to scan documents using ScandAll PRO, refer to "ScandAll PRO V2.0 User's Guide".



The Document Cover with a black document holding pad is optionally available.

This type is convenient for scanning documents in black background when loading them on the flatbed.

This option allows you to correct skewed document images when scanned with the flatbed and to recognize the size of document output at its original size.

Name: Black Document Pad

Parts No.: PA03338-D960

TOP

Contents

Index

Introduction

Scanner
OverviewLoading
DocumentsScan
ParametersVarious
Documents

Daily Care

Consumables

Trouble-
shootingOperational
Settings

Appendix

Glossary

Chapter 3 Scan Parameters

This chapter describes the scan parameters you can configure for scanning within the scanner driver.

Here, Windows Vista screen samples are used to explain the operations. The screens and operations may differ slightly if the OS that you are using is other than Windows Vista. Take note that, when the TWAIN or ISIS scanner driver is updated, the screens and operations herein may also be slightly different. In such case, refer to the relevant manuals or materials, which are to be supplied when updating the driver.

3.1 TWAIN Scanner Driver	52
3.2 ISIS Scanner Driver	55

TOP

Contents

Index

Introduction

Scanner
Overview

Loading
Documents

Scan
Parameters

Various
Documents

Daily Care

Consumables

Trouble-
shooting

Operational
Settings

Appendix

Glossary

3.1 TWAIN Scanner Driver

The TWAIN scanner driver is a driver software product that complies with the TWAIN standard. You can use this driver to perform a scan using a TWAIN-supported scanning application.

Usually, you first invoke a required scanner driver from the scanning application and configure your scanning settings in the scanner driver's setting dialog box. (Depending on the application settings, this setting dialog box may not appear.)



How to invoke a scanner driver depends on the scanning application you use. For details, refer to the manual or help of the application you use.

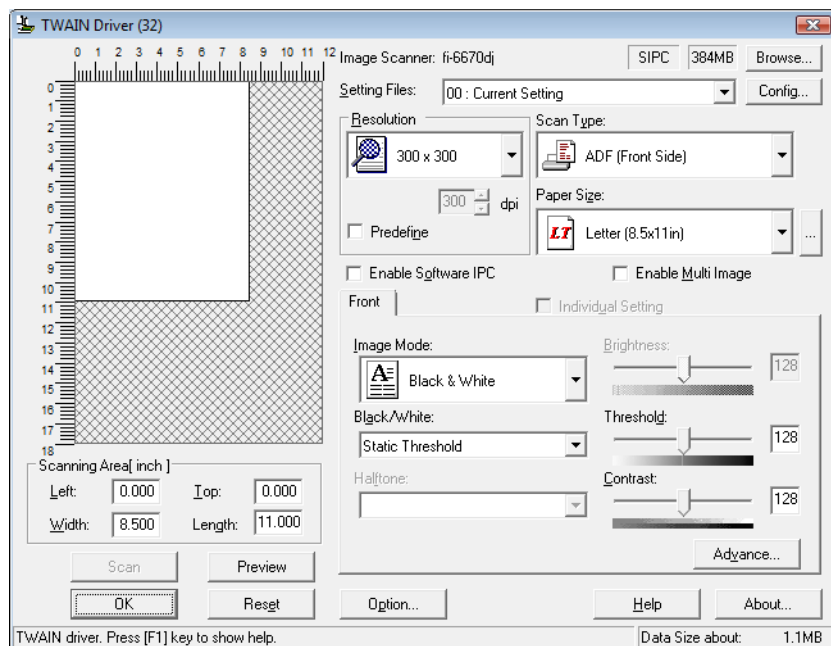

In the TWAIN scanner driver, you can configure various scan settings in the dialog box above.

For the major scan parameters, see the description below.

For details, refer to the TWAIN Scanner Driver Help.

Resolution

Specify a resolution for scanning images.

You can select a value from the predefined standard resolutions in the drop-down list. If a desired value is not listed, you can select [Custom] to specify the value (in increments of 1 dpi from 50 to 600 dpi).

By marking the [Predefine] checkbox, you can select one of three predefined settings, [Best], [Better], and [Normal], and this allows you to scan documents simply and quickly.

You can also customize the values of [Best], [Better], and [Normal] as desired in the window that appears when the [...] button is clicked.

Scan Type

Specify the side(s) of document to scan.

The specifiable scan types are as follows:

- ADF (Front Side)
- ADF (Duplex) (fi-6670/fi-6670A/fi-6770/fi-6770A only)
- ADF (Virtual Duplex) (fi-6750S only)
- Long page (Front Side)
- Long page (Duplex) (fi-6670/fi-6670A/fi-6770/fi-6770A only)
- Flat Bed (flatbed type only)
- ADF (Back Side) (fi-6670/fi-6670A/fi-6770/fi-6770A only)

Paper Size

Select a desired paper size to scan, from the sizes shown in the list.

You can save up to three paper sizes using the [...] button as your customized settings.

Also, you can change the order of the listings displayed.

Image Mode

You can specify the type of the output image of scanned document.

Mode	Description
Black&White	Documents are scanned in binary (black & white) mode.
Halftone	Documents are scanned through halftone processing in binary (black & white) mode.
Grayscale	Documents are scanned in gradations from black to white. In this mode, you can select either [Grayscale] (256) or [4bit Grayscale] (4-bit or 16 grayscale).
SEE (Selectable Edge Enhancement)	Documents with line drawings and photographs are scanned using halftone processing, and only the line drawings and text are emphasized. This mode is most suitable for emphasizing only text of documents containing both photographs and text.
Color	Documents are scanned in color mode. In this mode, you can select one out from [24Color] (24-bit color), [256Color] (256 colors), and [8Color] (8 colors).

[Scan] Button

Clicking this button starts scanning documents with the current settings.

[Preview] Button

Documents can be checked before the actual scanning. You can test-scan documents with the current settings, and display them in the preview window.

[Close]/[OK] Button

Clicking this button saves the current settings and closes the dialog box.

[Reset] Button

This button is used to undo changes to the current settings.

[Help] Button

Clicking this button opens the [TWAIN Scanner Driver Help] window. You can also open the window by pushing the [F1] key.

[About] Button

Clicking this button views the information about the TWAIN Scanner Driver's version.

[Option] Button

You can configure desired options in the dialog box below:

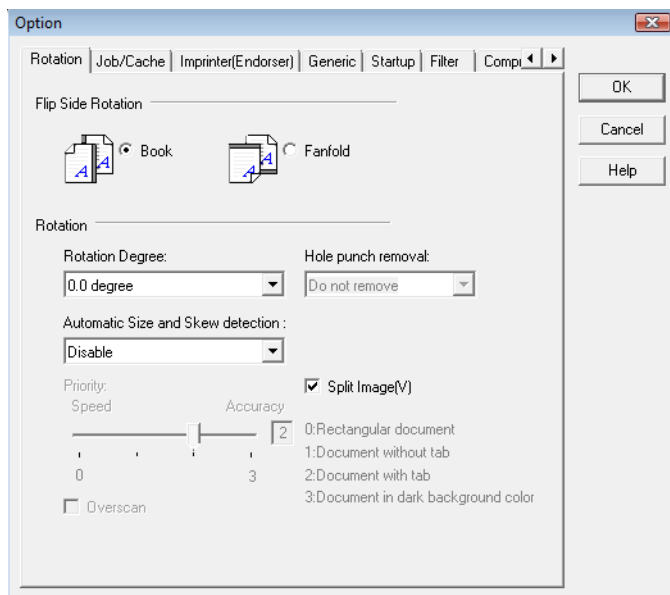

- **[Rotation] Tab**
Select this tab when configuring settings for the flip side rotation on double-sided scanning, image rotation, document size and skew detection, overscan, hole punch removal, and split image.
- **[Job/Cache] Tab**
Select this tab when setting the cache mode, multifeed detection, pre-pick control, blank page skipping, etc.
- **[Imprinter (Endorser)] Tab**
Select this tab when specifying the text to print on scanned documents using the optionally-available imprinter. This tab does not appear unless the imprinter is installed.
- **[Generic] Tab**
Select this tab when specifying the unit of scaling/measurement in the [TWAIN Driver (32)] dialog box.
Select inches, millimeters (mm), or pixel.

- **[Startup] Tab**
Select this tab when configuring settings on the scanner's Operator Panel.
- **[Filter] Tab**
Select this tab for setting the image processing filter(s).

Filter	Description
Digital Endorser	Adds a character string (alphanumeric data) to scanned document images.
Page Edge Filler	Fills up the margins of scanned document images with a selected color.

- **[Compression] Tab**
Select this tab for setting the compression rate of JPEG Transfer.

[Advance] Button

Click this button for setting up for advanced image processing. You can specify Edge Extract, Gamma Pattern, Dropout Color, Reverse, White Page Follower, etc.

[Config] Button

Click this button to configure setting files. You can save the changes made in the [TWAIN Driver (32)] dialog box, to a file under [Setting File]. From the next scanning, a set of settings is quickly switched by using these setting files.

3.2 ISIS Scanner Driver

The ISIS scanner driver is a driver software product that complies with the ISIS standard. You can use this driver to perform a scan using a ISIS-supported scanning application. Usually, you first invoke a desired scanner driver from the scanning application and configure your scanning settings in the scanner driver's setting dialog box. (Depending on the application settings, this setting dialog box may not appear.)



How to invoke a scanner driver varies depending on the application. For details, refer to the manual or help of the application you use.

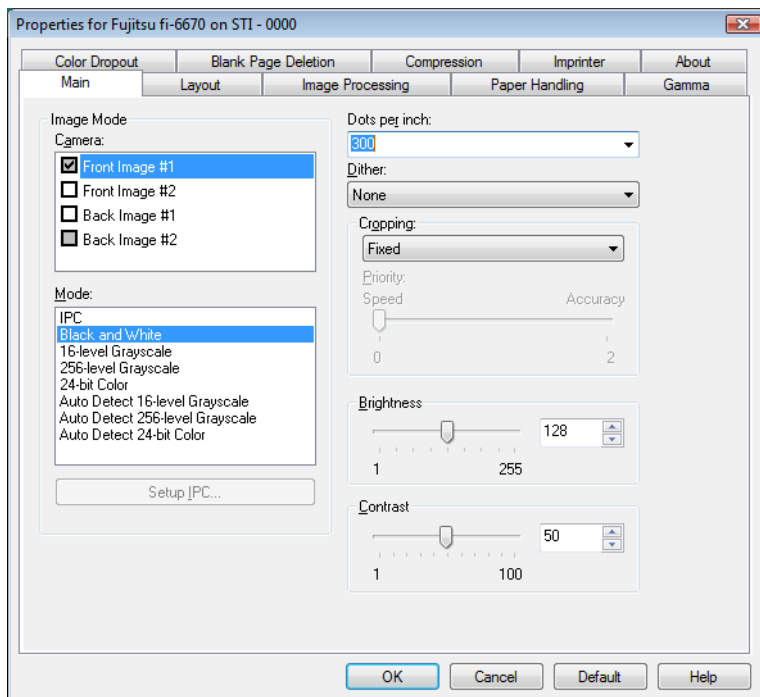

In the ISIS scanner driver, you can configure various scan settings in the dialog box above. For the major scan parameters, see the description below. For details, refer to the ISIS Scanner Driver Help.

[Main] Tab

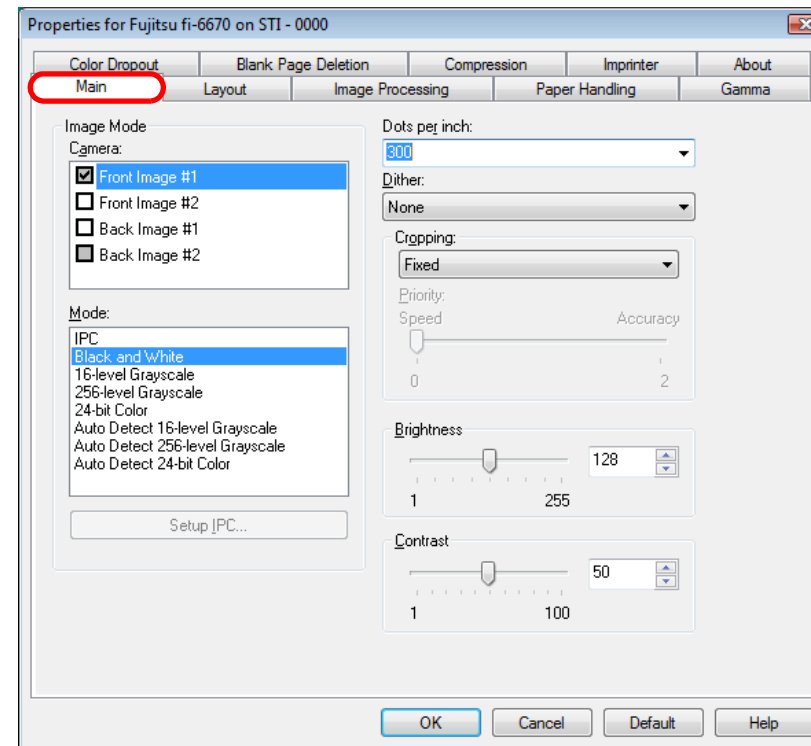

Select this tab when specifying the side of document to scan, color (color/grayscale/black&white), resolution, brightness, and contrast.

[Layout] Tab

Select this tab when specifying the page orientation of document to scan, the binding direction for double-sided scanning, paper feed direction, and paper size.

Clicking the [Scan Area] button displays the [Scan Area] dialog box.

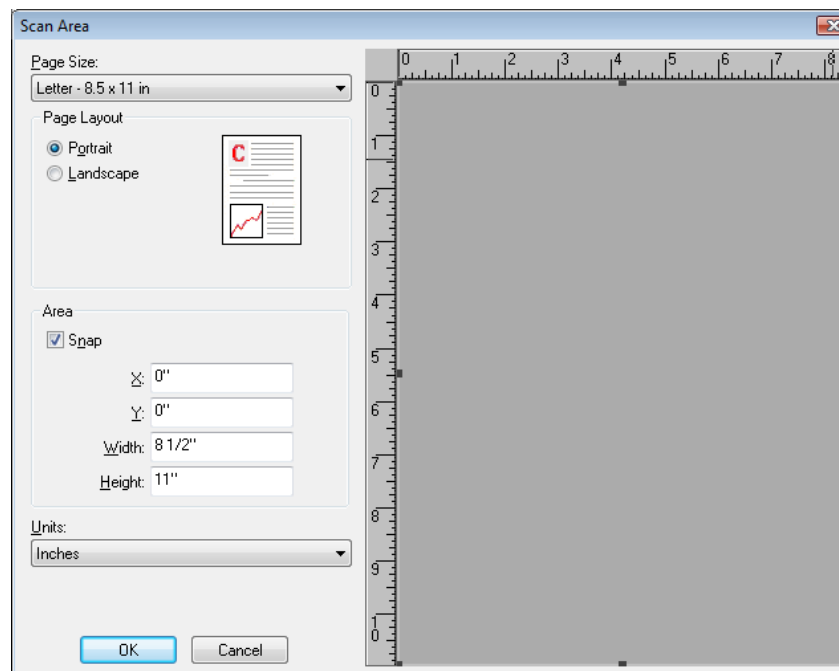

Note that [Automatic] in [Image Orientation] is available only when ScandAll PRO is installed.

[Scan Area] Window

You can specify the scan area for the paper size specified for [Paper Size].

[Image Processing] Tab

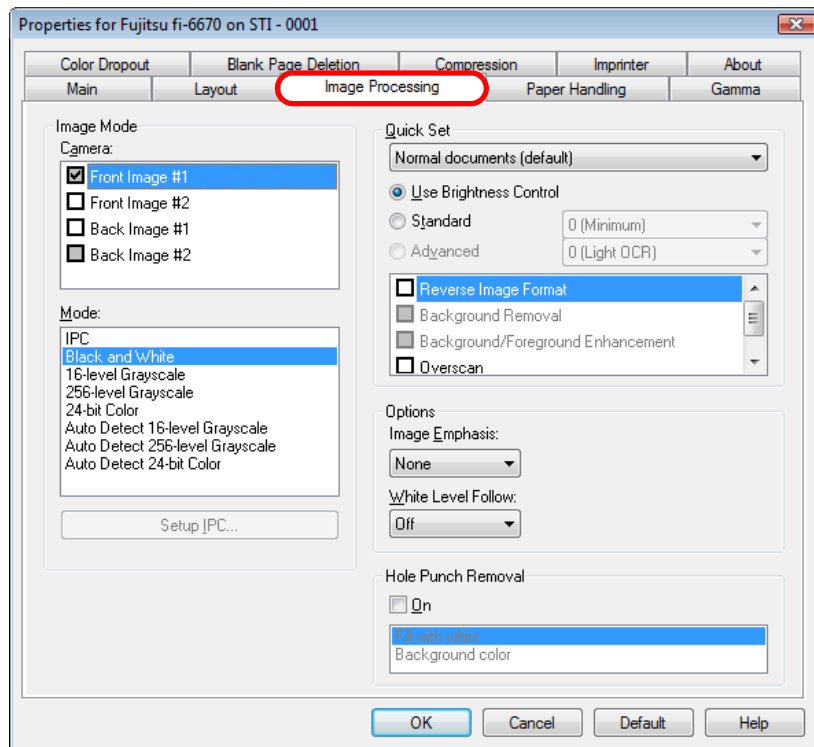

Select this tab when selecting a common setting pattern for scanning.

You can also configure settings for scanning documents with non-white background, or those with punch holes.

[Paper Handling] Tab

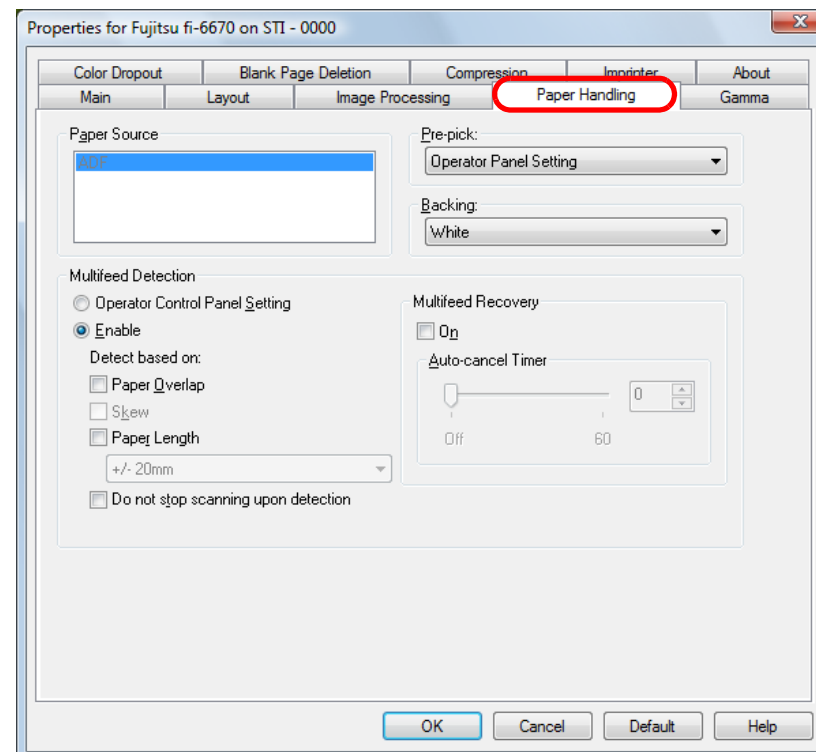

Select this tab when configuring settings for pre-picking (i.e., feeding of loaded document at a scanning point beforehand), and multifeed detection.

If using the Flatbed type, select a desired paper handling type from among [Automatic], [ADF], and [Flatbed] under [Paper Source].

TOP

Contents

Index

Introduction

Scanner
OverviewLoading
DocumentsScan
ParametersVarious
Documents

Daily Care

Consumables

Trouble-
shootingOperational
Settings

Appendix

Glossary

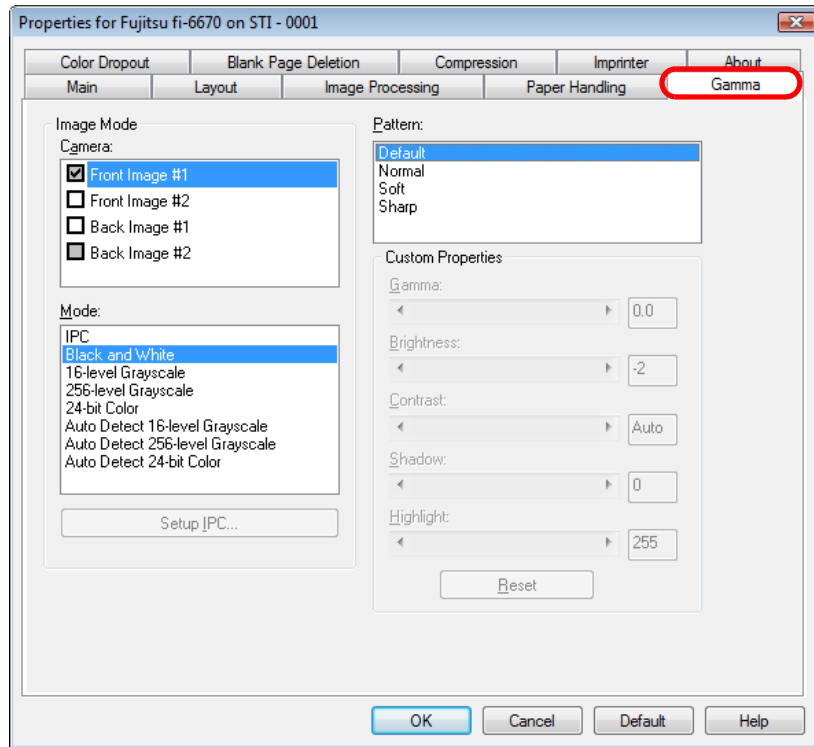
[Gamma] Tab

Select this tab when selecting a gamma correction pattern. You can customize detailed settings such as the gamma value and brightness when scanning documents in color mode.

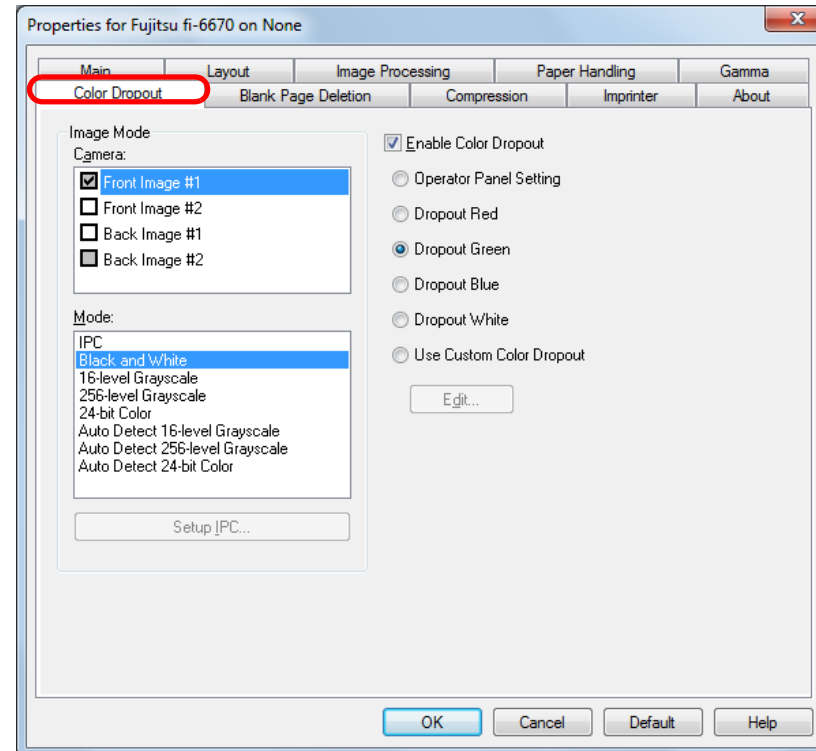
[Color Dropout] Tab

Select this tab when selecting color(s) to drop out when scanning documents.

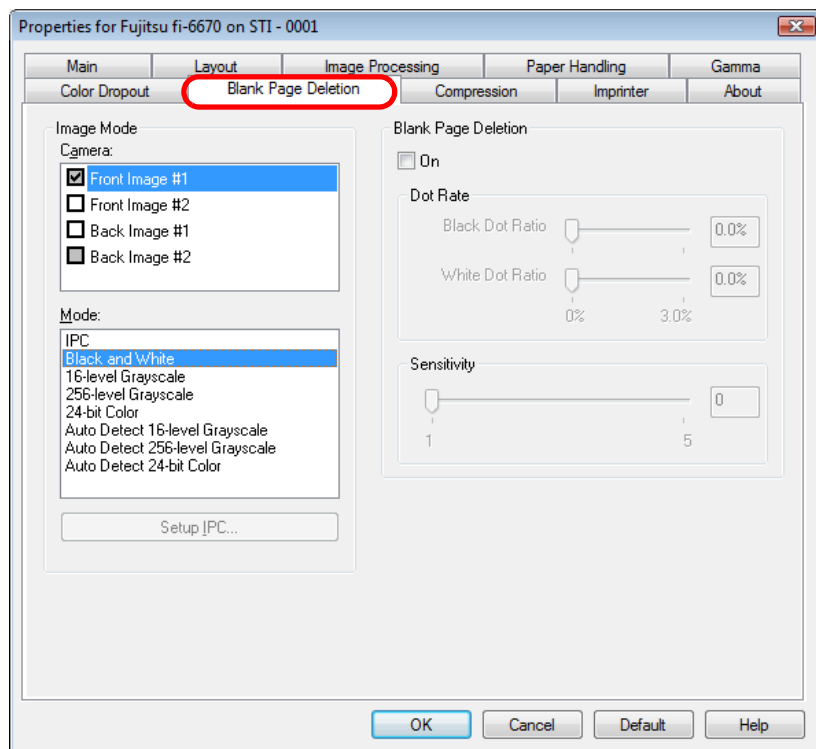
[Blank Page Deletion] Tab

Select this tab when determining how to delete blank pages in scanned documents.

When scanning a document in monochrome mode, you can use the dot rate to process the blank page(s) for the white and black backgrounds separately.

When scanning a document in grayscale/color mode, you can use the sensitivity to process blank page(s) commonly for the white and black backgrounds.

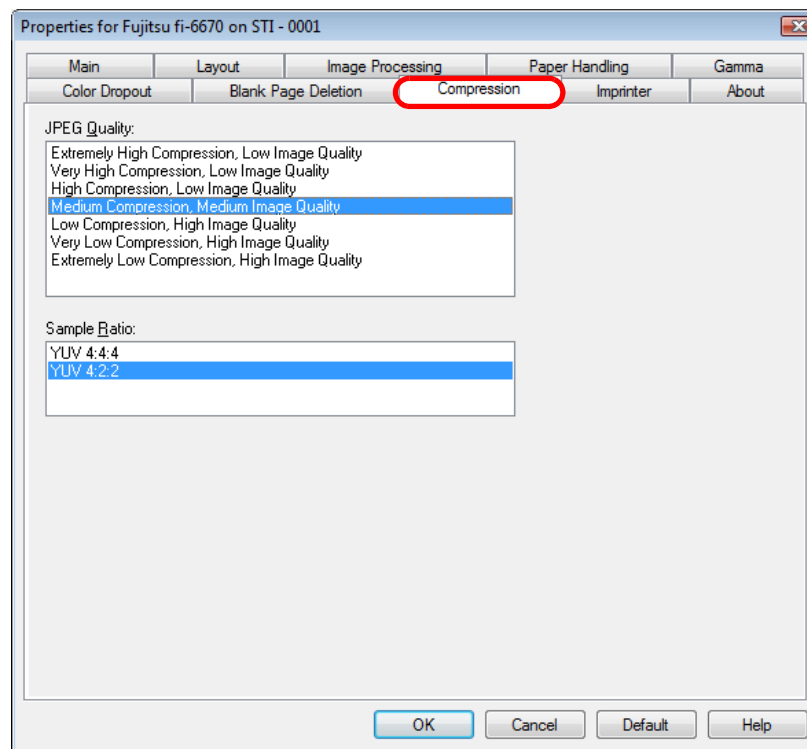
[Compression] Tab

Select this tab when specifying a compression rate and an image quality for images scanned in color or grayscale mode. The sampling ratio used for compressing images is shown here.

TOP

Contents

Index

Introduction

Scanner
OverviewLoading
DocumentsScan
ParametersVarious
Documents

Daily Care

Consumables

Trouble-
shootingOperational
Settings

Appendix

Glossary

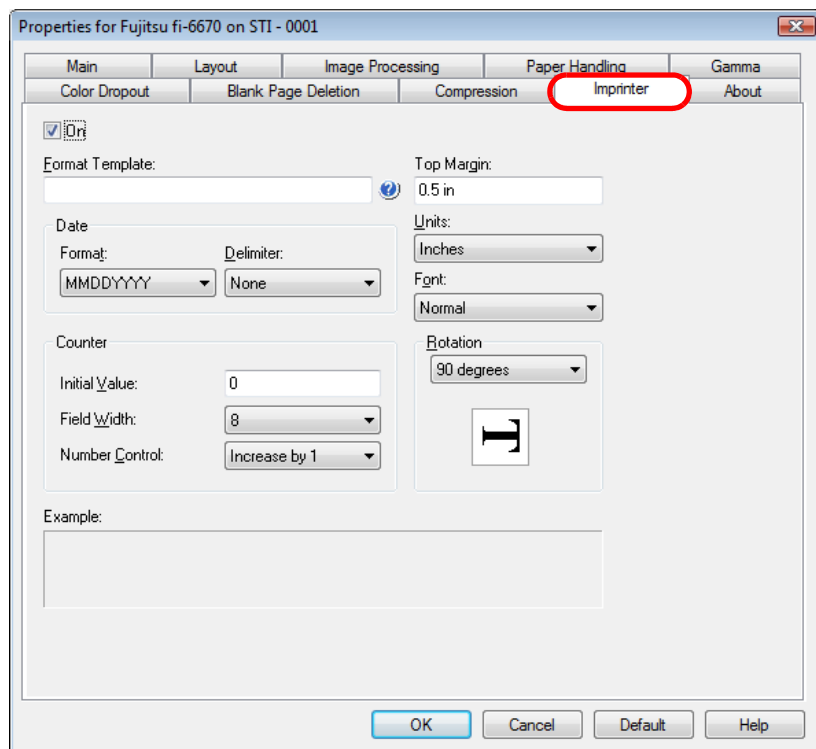
[Imprinter] Tab

Select this tab when configuring settings for printing text on scanned documents using the imprinter option (to be purchased separately). This tab is not displayed unless the imprinter option is installed.

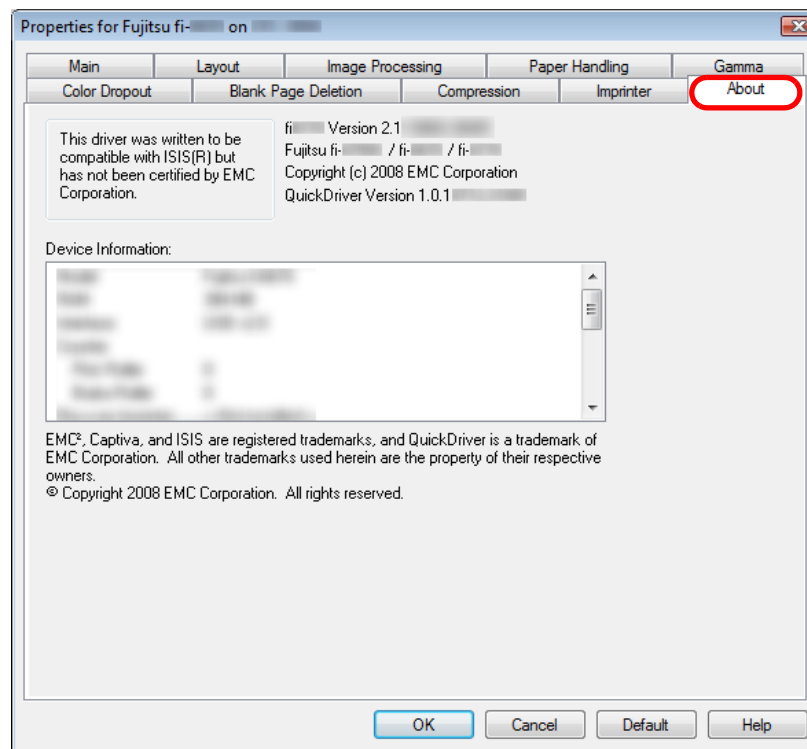
[About] Tab

Select this tab when viewing the version of the ISIS scanner driver and information on the scanner connected to your computer.

Chapter 4 Various Documents

This chapter describes how to scan documents in various ways, showing some examples using the TWAIN scanner driver started from ScandAll PRO.

Here, Windows Vista screen samples are used to explain the operations. The screens and operations may differ slightly if the OS that you are using is other than Windows Vista. Take note that, when the TWAIN or ISIS scanner driver is updated, the screens and operations herein may also be slightly different. In such case, refer to the relevant manuals or materials, which are to be supplied when updating the driver.

4.1 Summary	62
4.2 Scanning Documents of Different Types or Sizes.....	63
4.3 Advanced Scanning.....	67
4.4 Setting Post-Scan Operations and Handling	77
4.5 Customizing the Hardware Settings	90

TOP

Contents

Index

Introduction

Scanner
Overview

Loading
Documents

Scan
Parameters

Various
Documents

Daily Care

Consumables

Trouble-
shooting

Operational
Settings

Appendix

Glossary

4.1 Summary

The following lists various ways of scanning and the major applications of the scanner.

Scanning Documents of Different Types or Sizes

- [Scanning Both Sides of A Document \(fi-6670/fi-6670A/fi-6770/fi-6770A Only\) \(on page 63\)](#)
- [Scanning A Large-Size Document or Book \(Flatbed Type Only\) \(on page 63\)](#)
- [Scanning Documents of Different Widths \(on page 64\)](#)
- [Scanning A Document Longer Than A3 Size \(on page 65\)](#)

Advanced Scanning

- [Excluding Color\(s\) from Images \(Dropout Color\) \(on page 67\)](#)
- [Skipping Blank Pages \(on page 69\)](#)
- [Scanning the Image Brighter \(on page 70\)](#)
- [Removing Punch Holes from A Scanned Image \(on page 72\)](#)
- [Scanning A Document from the ADF in Manual Loading Mode \(on page 74\)](#)
- [Duplex Scanning Using the ADF Virtual Duplex Function \(fi-6750S Only\) \(on page 75\)](#)

Configuring Post-Scan Operations and Handling

- [Automatically Correcting Skewed Document Images \(on page 77\)](#)
- [Setting Auto Correction for Document Page Orientations \(on page 79\)](#)
- [Saving Scanned Images in PDF Format \(on page 80\)](#)

- [Horizontally Splitting a Scanned Image into Two \(on page 85\)](#)
- [Outputting in Multi-Image Mode \(on page 86\)](#)
- [Setting Auto Detection for Content Colors \(Color/Monochrome\) \(on page 88\)](#)

Customizing the Hardware Settings

- [Using the Scanner Buttons to Start A Scan Quickly \(on page 90\)](#)
- [Detecting Multifeds \(on page 92\)](#)
- [Bypassing Multifeed Detection for a Fixed Format \(on page 93\)](#)

For information on how to scan documents in the following methods, refer to "ScandAll PRO V2.0 User's Guide".

- [Duplex Scanning Using the ADF Virtual Duplex Option](#)
- [Dividing a Multipage Document Using Patch Codes](#)
- [Dividing a Multipage Document Using Barcodes](#)
- [Specifying the Result of Zone OCR as a File Name](#)
- [Specifying the Result of Barcode Recognition as a File Name](#)
- [Creating Saving Folders for Each Batch Scan](#)
- [Saving Scanned Images from a Batch Scan to Microsoft SharePoint Server](#)
- [Restarting a Suspended Batch Scan](#)
- [Outputting Indexing Information File and Linking with an Application](#)

TOP

Contents

Index

Introduction

Scanner
OverviewLoading
DocumentsScan
ParametersVarious
Documents

Daily Care

Consumables

Trouble-
shootingOperational
Settings

Appendix

Glossary

4.2 Scanning Documents of Different Types or Sizes

Scanning Both Sides of A Document (fi-6670/fi-6670A/fi-6770/fi-6770A Only)

- 1 Load a target document on the ADF Paper Chute.
For how to load documents on the ADF Paper Chute, refer to "2.1 Loading Documents on the ADF" (on page 39).
- 2 Start up ScandAll PRO, and then open the [TWAIN Driver (32)] dialog box.
For how to open the [TWAIN Driver (32)] dialog box, refer to "ScandAll PRO V2.0 User's Guide".
- 3 Select [ADF (Duplex)] under [Scan Type].

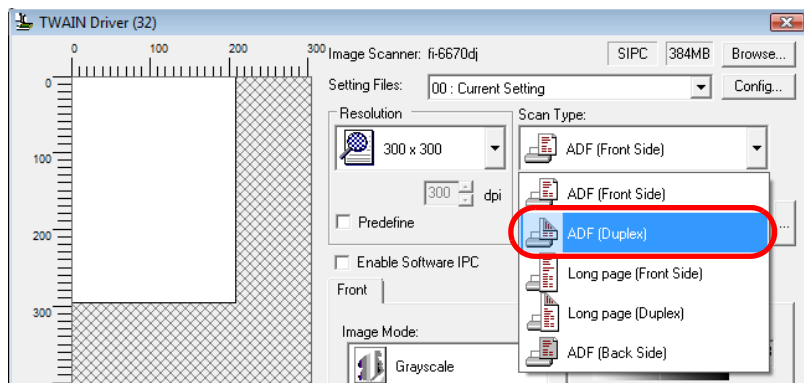

- 4 Specify a desired paper size from [Paper Size], etc.
- 5 Click the [OK] button.
⇒ The changes made are applied.
- 6 From ScandAll PRO, perform a scan.
For how to perform a scan, refer to "ScandAll PRO V2.0 User's Guide".

Scanning A Large-Size Document or Book (Flatbed Type Only)

- 1 Holding the handle, lift up the Document Cover.

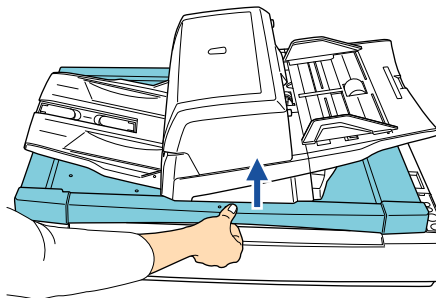

- 2 Place a target document page on the Document Bed face down and the top left corner aligned to the reference point.

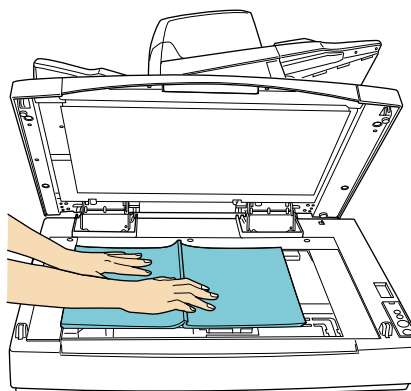

- 3 Start up ScandAll PRO, and then open the [TWAIN Driver (32)] dialog box.
For how to open the [TWAIN Driver (32)] dialog box, refer to "ScandAll PRO V2.0 User's Guide".

TOP

Contents

Index

Introduction

Scanner
OverviewLoading
DocumentsScan
ParametersVarious
Documents

Daily Care

Consumables

Trouble-
shootingOperational
Settings

Appendix

Glossary

4 Select [Flat Bed] under [Scan Type].

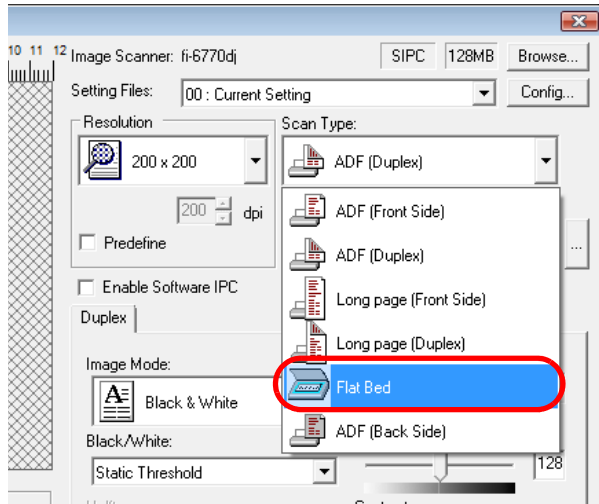

5 Specify a desired paper size from [Paper Size], etc.

6 Click the [OK] button.

⇒ The changes made are applied.

7 From ScandAll PRO, perform a scan.

For how to perform a scan, refer to "ScandAll PRO V2.0 User's Guide".



Never look into the light source directly during scanning.



- Do not move the document during scanning.
- For a document of up to A3 or Double Letter size, be sure to close the Document Cover before scanning.

Scanning Documents of Different Widths

When you scan documents of different widths, scan them, following the procedure below.



When you scan documents of different widths at one time from the ADF, some documents that are small in paper size may be skewed or may not be fed into the scanner. It is recommended that only documents of the same width be scanned at one time.

1 To prevent images from being skewed, select [Automatic Page Size Detection] from the [Automatic Size and Skew Detection] drop-down list.

For how to configure the settings, refer to "[Automatically Correcting Skewed Document Images](#)" (on page 77).

2 Center all the document sheets as shown in the figure below.

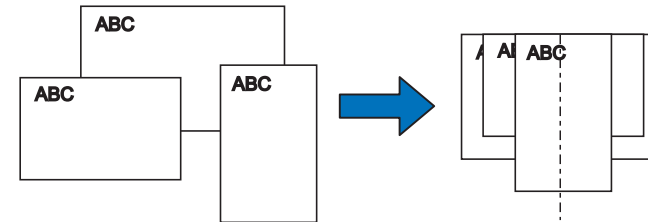

Inside the opening of the ADF is a Pick Roller, which picks and feeds documents into the ADF. Therefore, off-center documents, if out of contact with the Pick Roller, cannot be fed into the scanner.

- Place the whole document on the ADF Paper Chute, and then adjust the Side Guides so that they lightly touch the widest sheets of the document.



When loading a small-size document on the ADF Paper Chute, be careful not to touch the hood for the Chute Roller. Touching the hood during scanning opens it, and may catch your finger in.

- From ScandAll PRO, perform a scan.
For how to perform a scan, refer to "ScandAll PRO V2.0 User's Guide".

Scanning A Document Longer Than A3 Size

- Load a target document on the ADF Paper Chute.
For how to load documents on the ADF Paper Chute, refer to "2.1 Loading Documents on the ADF" (on page 39).



When scanning a document longer than A3 size, pull out the Paper Chute Extension and the Stacker Extension to their maximum. Here, do not raise the Stoppers.

- Start up ScandAll PRO, and then open the [TWAIN Driver (32)] dialog box.
For how to open the [TWAIN Driver (32)] dialog box, refer to "ScandAll PRO V2.0 User's Guide".

- Select [Long page (Front Side)] or [Long page (Duplex)] from [Scan Type].
Select [Long page (Front Side)] for single-sided scanning; [Long page (Duplex)] for double-sided scanning.

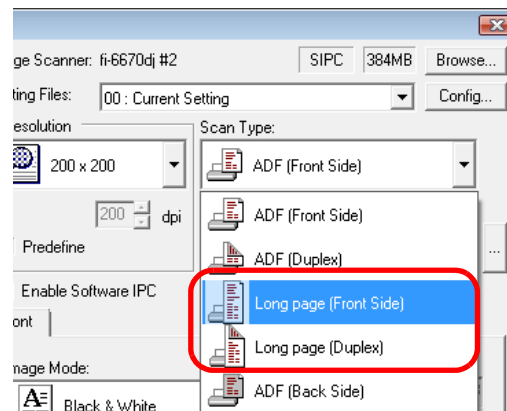

⇒ The [Long Page Paper Size Setting] dialog box appears.



The [Long Page Paper Size Setting] dialog box appears for the fi-6670, fi-6670A, fi-6770, or fi-6770A only.

- 4 Specify the document length, and then click the [OK] button.

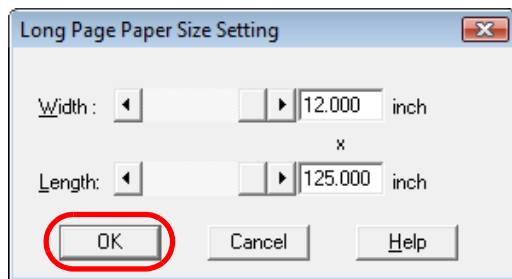

- 5 Click the [OK] button.
⇒ The changes made are applied.

- 6 From ScandAll PRO, perform a scan.
For how to perform a scan, refer to "ScandAll PRO V2.0 User's Guide".



- The setting above is not available if any one or both of the following options is enabled:
 - Multi Image Output (TWAIN scanner driver)
 - Auto Color Detection (ScandAll PRO)
- If you want to scan a document that is longer than 864 mm (34.02 inches), specify a resolution of 200 dpi or lower.

4.3 Advanced Scanning

Excluding Color(s) from Images (Dropout Color)

You can select a color from primary colors (red, green, and blue) to remove (drop out) from a scanned document image. For example, when you scan a document containing black text with green background, you can output an image of only black text.

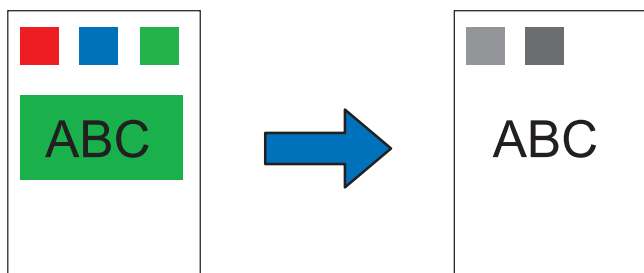

Example: When "green" is selected to be dropped out



Note the dropout color can be specified only in binary (black & white) or grayscale mode.

- 1 Load a target document on the scanner.
For how to load documents on the scanner, refer to "[Chapter 2 Loading Documents](#)" (on page 38).
- 2 Start up ScandAll PRO, and then open the [TWAIN Driver (32)] dialog box.
For how to open the [TWAIN Driver (32)] dialog box, refer to "ScandAll PRO V2.0 User's Guide".

- 3 Click the [Advance] button.

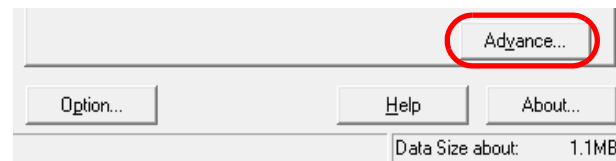

⇒ The [Advance] dialog box appears.

- 4 Select a color you want to remove, from the [Dropout Color] drop-down list under [More].

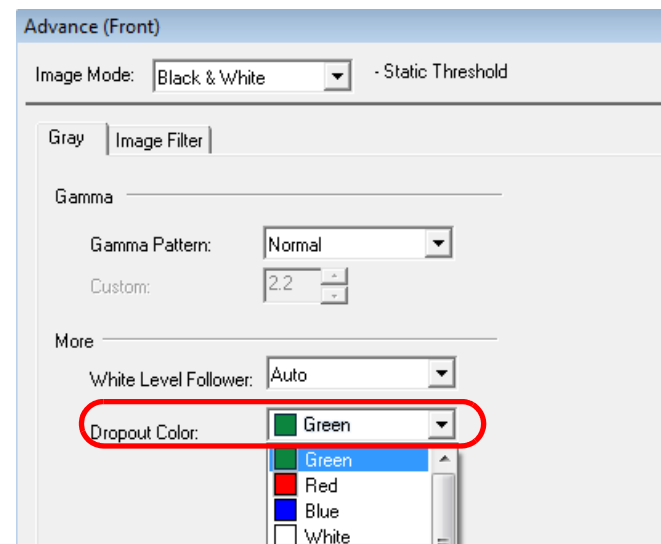

If you want no color to be dropped out, select [None].

To drop out a desired color, select [Custom], [Custom 2], or [Custom 3].

If you select one of them, the [Select Dropout Color] dialog box will appear. Here, you can specify up to three colors to be dropped out.

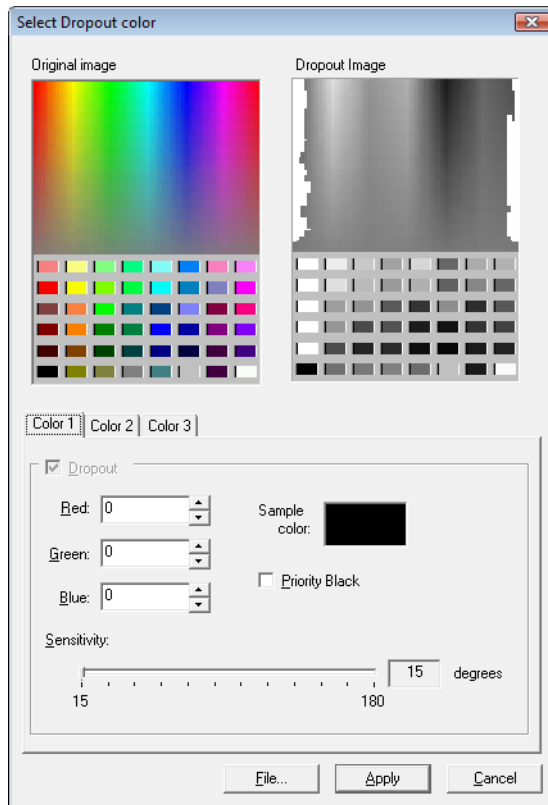

- Original image
Color samples are displayed. Select a color to be dropped out.
- Dropout Image
The dropped out image is displayed.
- [Color 1], [Color 2], and [Color 3] tabs
Specify color(s) to be dropped out. Up to three colors can be specified at the same time.
 - [Dropout] checkbox
Select this checkbox on both the [Color 2] and [Color 3] tabs to make this option effective when specifying two or more colors to be dropped out.

- [Red]/[Green]/[Blue] fields
Under [Dropout Color], the specified color's values and the sample color image are displayed.
You can change the color values by directly typing in or by using the [▲] and/or [▼] buttons.

- Sample color
The color specified to be dropped out is shown here.

- [Priority Black] checkbox
Select this checkbox not to drop out text.
This option prevents low-intensity colors such as black, which are generally used as text, from being dropped out.
- Sensitivity
For the color you selected, specify the allowable range of colors to be dropped out.
Specifiable range: 15 to 180 degrees
The larger the numeric value, the wider the color dropout range is.
- [File] button
You can display a desired image file (in the format of *.bmp) in the [Original image] area and select, from here, the color to be dropped out.
- [Apply] button
Applies the changes made and closes the dialog box.
- [Cancel] button
Cancels the changes made and closes the dialog box.

5 Click the [OK] button.
⇒ You are returned to the [TWAIN Driver (32)] dialog box.

6 In the [TWAIN Driver (32)] dialog box, click the [OK] button.
⇒ The changes made are saved.

7 From ScandAll PRO, perform a scan.
For how to perform a scan, refer to "ScandAll PRO V2.0 User's Guide".

Skipping Blank Pages

Blank pages (white or black paper) included in your document are detected and removed automatically before scanning. For example, when scanning both double-sided and single-sided documents together in duplex mode, you can obtain the scanned document images with blank pages removed from the single-sided document scanned.

- 1 Load a target document on the ADF Paper Chute.
For how to load documents on the ADF Paper Chute, refer to "2.1 Loading Documents on the ADF" (on page 39).
- 2 Start up ScandAll PRO, and then open the [TWAIN Driver (32)] dialog box.
For how to open the [TWAIN Driver (32)] dialog box, refer to "ScandAll PRO V2.0 User's Guide".
- 3 Click the [Option] button.

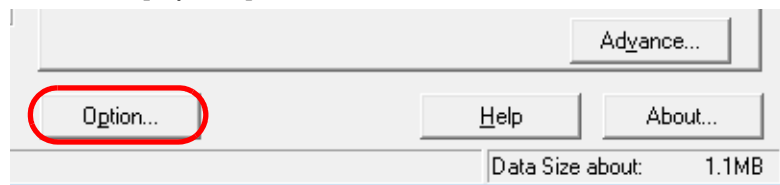

⇒ The [Option] dialog box appears.

- 4 Select the [Job/Cache] tab, and then select the [Blank Page Skip] checkbox.

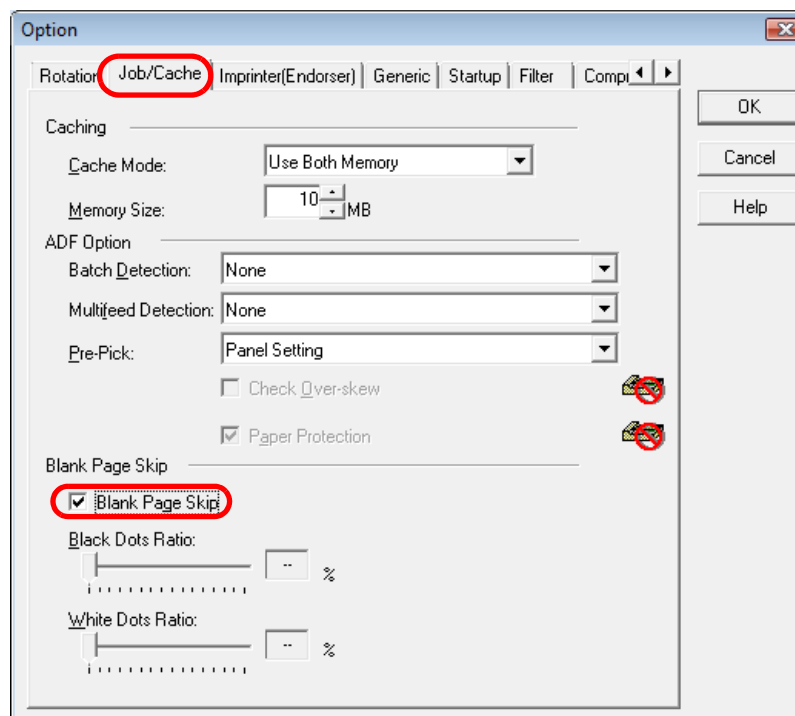

If this checkbox is marked, the cache mode is automatically switched to [Use Both Memory].

- 5 With the slider control under [Blank Page Skip], specify the Blank Page Skip degrees.
 - In Binary/Halftone mode

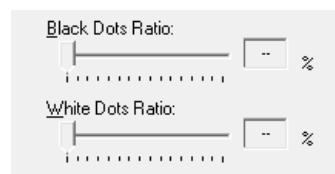

The value displayed to the right of the slider bar shows a noise (dots) ratio(*1). If a scanned page includes dots less than this value, the page is recognized as a blank page.

You can select OFF(-) or a value from 0.2% to 3.0% (in increments of 0.2%).

*1: Ratio of black dots included in the scanned area (for white pages)

- In Color/Grayscale mode

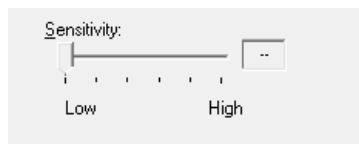

Use the slider bar to specify a level from among five levels (1 to 5). The larger the number, the higher the accuracy.

- 6 Click the [OK] button.
⇒ You are returned to the [TWAIN Driver (32)] dialog box.
- 7 In the [TWAIN Driver (32)] dialog box, click the [OK] button.
⇒ Changes made are saved.
- 8 From ScandAll PRO, perform a scan.
For how to perform a scan, refer to "ScandAll PRO V2.0 User's Guide".

Scanning the Image Brighter

The brightness of the scanned image can be increased for scanning in grayscale or color.

- 1 Load a target document on the scanner.
For how to load documents on the scanner, refer to "[Chapter 2 Loading Documents](#)" (on page 38).
- 2 Start up ScandAll PRO, and then open the [TWAIN Driver (32)] dialog box.
For how to open the [TWAIN Driver (32)] dialog box, refer to "ScandAll PRO V2.0 User's Guide".

TOP

Contents

Index

Introduction

Scanner
Overview

Loading
Documents

Scan
Parameters

Various
Documents

Daily Care

Consumables

Trouble-
shooting

Operational
Settings

Appendix

Glossary

3 Select grayscale or color in [Image Mode].

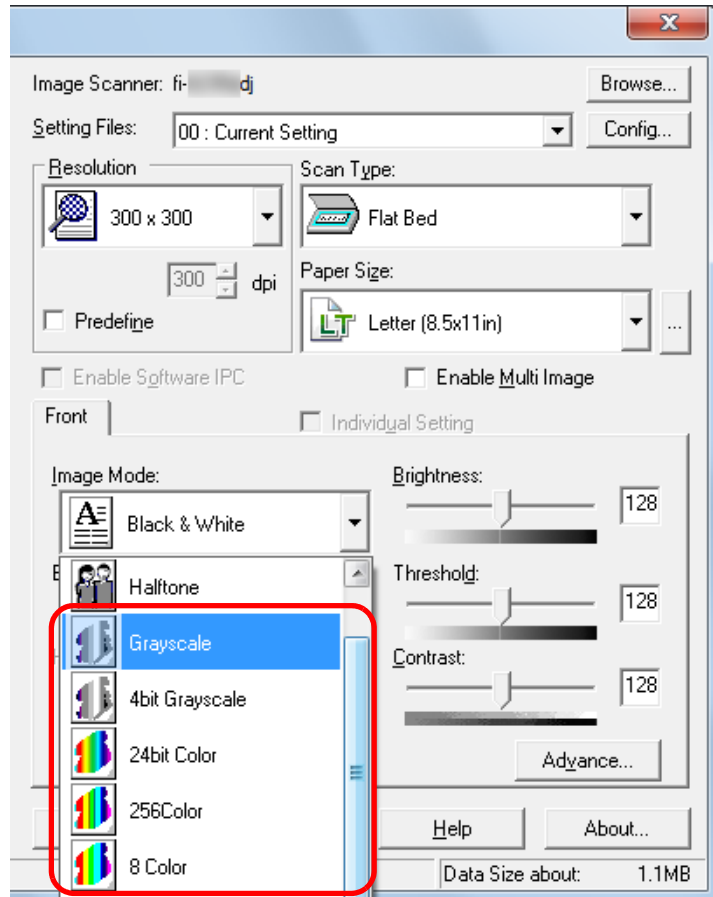

4 Click the [Advance] button.

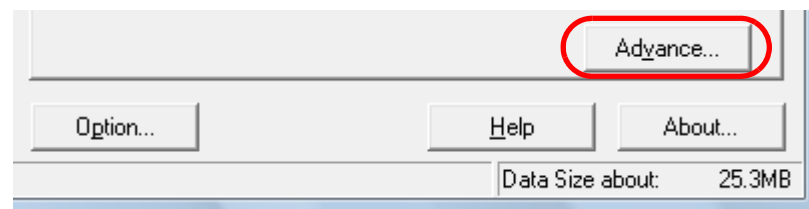

⇒ The [Advance] dialog box appears.

5 Click the [Color] tab, and then select [Bright] in [Preset Gamma].

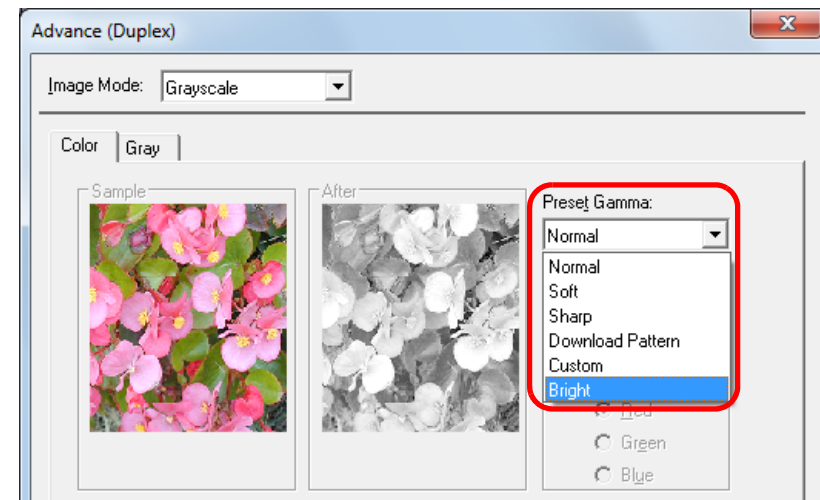

6 Click the [OK] button.

⇒ It returns to the [TWAIN Driver (32)] dialog box.

7 In the [TWAIN Driver (32)] dialog box, click the [OK] button.

⇒ The settings are saved.

8 From ScandAll PRO, perform a scan.

For how to perform a scan, refer to "ScandAll PRO V2.0 User's Guide".



When using applications other than ScandAll PRO, you can also increase the default brightness of the TWAIN driver. Select [Tools] → [FtSwtGmm] → [Twain] in the Setup DVD-ROM and double-click "FtSwtGmm.exe", and then select [Bright] in the [Default scan setting (TWAIN)] dialog box.

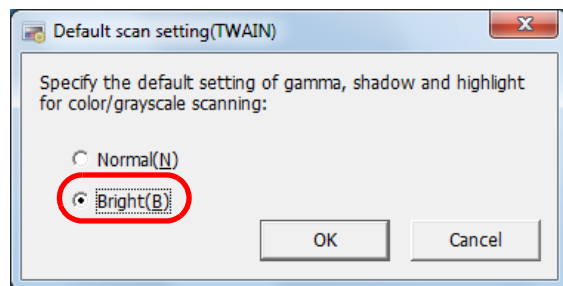

Removing Punch Holes from A Scanned Image

You can remove or obscure punch holes (black dots) from the output image of a scanned punched document.

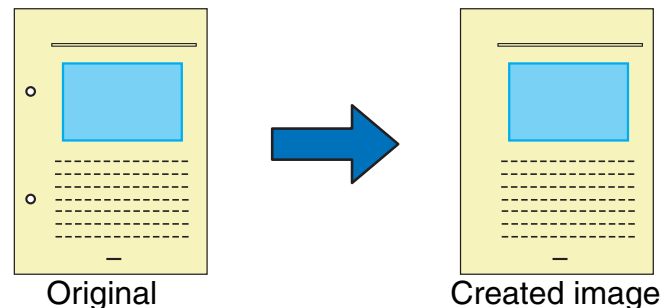

Punch hole marks are not removed when:

- They are not aligned along with the document edge.
- They vary in size or appear at various intervals.
- The scanned document is not rectangular.
- The scanned document is in dark-colored background.
- Characters or figures exist at the edge of the document, or they overlap with the hole marks.
- The document of a size larger than the specified page size is scanned with [Automatic Page Size Detection] enabled.
- The size of the scanned document is not as specified in [Paper Size] while [Black Background] is selected.

1

Load a target document on the scanner.

For how to load documents on the scanner, refer to "[Chapter 2 Loading Documents](#)" (on page 38).

2

Start up ScandAll PRO, and then open the [TWAIN Driver (32)] dialog box.

For how to open the TWAIN Driver (32) dialog box, refer to "ScandAll PRO V2.0 User's Guide".

3 Click the [Option] button.

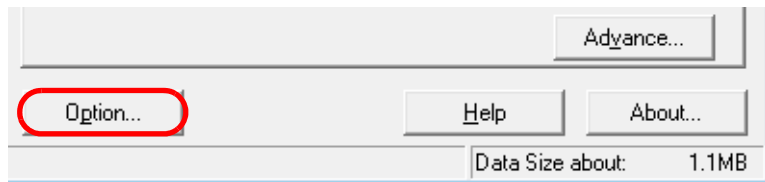

⇒ The [Option] dialog box appears.

4 Click the [Rotation] tab, and then select [Automatic Page Size Detection] or [Black Background] under [Automatic Size and Skew Detection].

If you select a setting other than [Automatic Page Size Detection] or [Black Background], the Hole Punch Removal function will not be available.

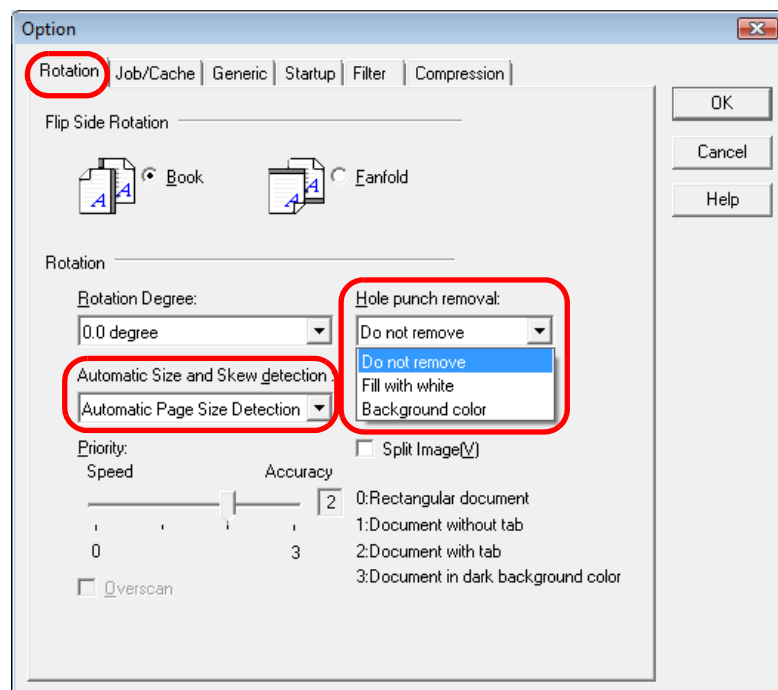

5 Select [Fill with white] or [Background color] under [Hole punch removal].

When scanning a color document, select [Background color]. If you select [Fill with white], the punch holes will look as if they are filled with white squares.

6 Click the [OK] button.

⇒ You are returned to the [TWAIN Driver (32)] dialog box.

7 In the [TWAIN Driver (32)] dialog box, click the [OK] button.

⇒ Changes made are saved.

8 From ScandAll PRO, perform a scan.

For how to perform a scan, refer to "ScandAll PRO V2.0 User's Guide".



Depending on the documents to scan, the characters and/or graphics on them may be mistakenly detected as punch holes and filled with a color, or the punch holes may not be filled with a color at all. If these happen, select [Automatic Page Size Detection] and specify "3" for [Priority] to improve the accuracy of hole punch removal.

Scanning A Document from the ADF in Manual Loading Mode

"Manual loading" refers to a user's action to place documents sheet by sheet on the ADF for scanning.

Usually, the scanner stops scanning once it senses no sheet loaded in the ADF. In this manual loading mode, if the scanner judges no sheet loaded in the ADF, it waits for the next sheet to come within a predetermined time interval. If the next sheet is loaded in time, the scanner scans it and waits for the next sheet. If no further sheet is found in time, the scanner stops the scanning.

With this option, you can confirm contents of multiple sheets of your document sheet by sheet before scanning them.

This manual loading is effective when:

- Scanning a document while confirming its contents
- Batch-scanning a document set, which may cause multifeed or paper jam
- Continuously scanning a document set of various shapes or sizes, like clippings of magazines or new papers, that cannot be loaded at once

The procedure is as follows:

- 1** Configure settings in the Software Operation Panel to enable manual loading.

For details of the settings, refer to "[Timeout for Manual Feeding \[Manual-feed timeout\]](#)" (on page 169).

- 2** Load the first sheet of a target document on the ADF Paper Chute.

For how to load documents on the ADF Paper Chute, refer to "[2.1 Loading Documents on the ADF](#)" (on page 39).

- 3** Start up ScandAll PRO to perform a scan.
For how to perform a scan, refer to "ScandAll PRO V2.0 User's Guide".

⇒ After the current sheet has been scanned, the scanner waits for the next sheet to load by keeping the rollers on the ADF rotating for the timeout time specified in the Software Operation Panel.

- 4** Load the next sheet on the ADF Paper Chute.

⇒ The loaded sheet is scanned with the same settings configured.

- 5** Repeat Step 4 until no remaining sheet is left.

⇒ The scanner terminates the scanning if no paper is loaded on the ADF within the timeout time specified in the Software Operation Panel.



- Pressing the [Send to] button while the scanner is waiting for the next sheet immediately terminates the scanning.
- Once the Manual-feed timeout option is enabled, the scanner waits until a sheet to load within a specified timeout time even if you start a scan with no document loaded on the ADF Paper Chute.
- You may have to replace the consumables more frequently if you often scan documents in this manual loading mode.

Duplex Scanning Using the ADF Virtual Duplex Function (fi-6750S Only)

The ADF (Virtual Duplex) option allows you to scan front-side pages of document first, and then scan back-side pages in succession, and automatically sorts these scanned pages in a correct order.

This option virtually realizes double-sided scanning on the ADF-type simplex scanner model (fi-6750S).

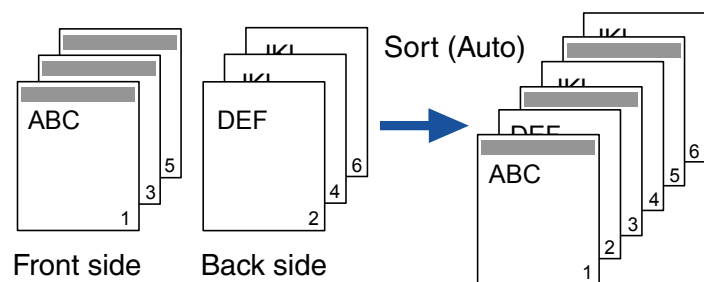

1 Load a target document face down on the ADF Paper Chute.

For how to load documents on the ADF Paper Chute, refer to ["2.1 Loading Documents on the ADF" \(on page 39\)](#).

2 In ScandAll PRO, specify Duplex Scan mode.

When selecting the "Scan" option

Select the [Perform ADF virtual duplex scanning] checkbox in the [Scan Settings] dialog box.

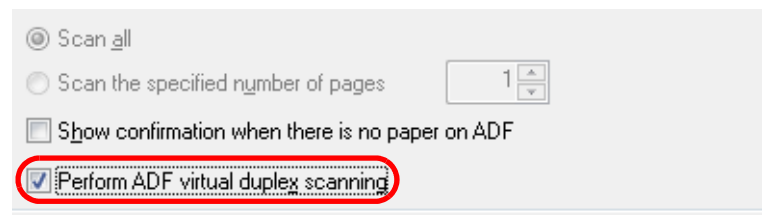

When selecting the "Batch Scan" option

Display the profile to be used for scanning in the [Profile Editor] dialog box. On the [Scan] tab, select [ADF (Virtual Duplex)] from [Scan Type].

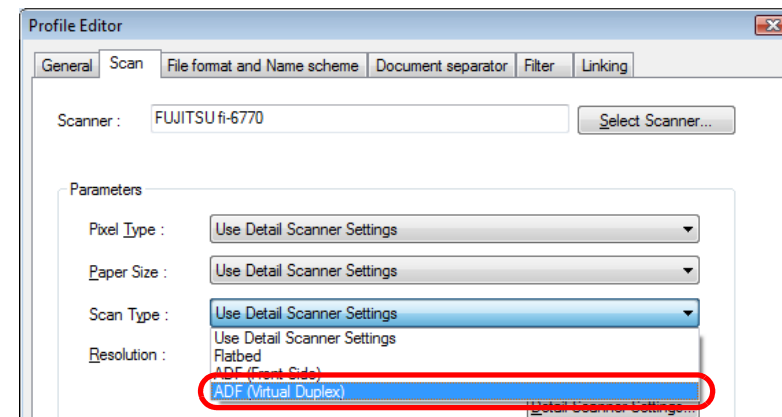

When using a scanner driver

In the [TWAIN Driver (32)] dialog box, select [ADF (Virtual Duplex)] from [Scan Type].

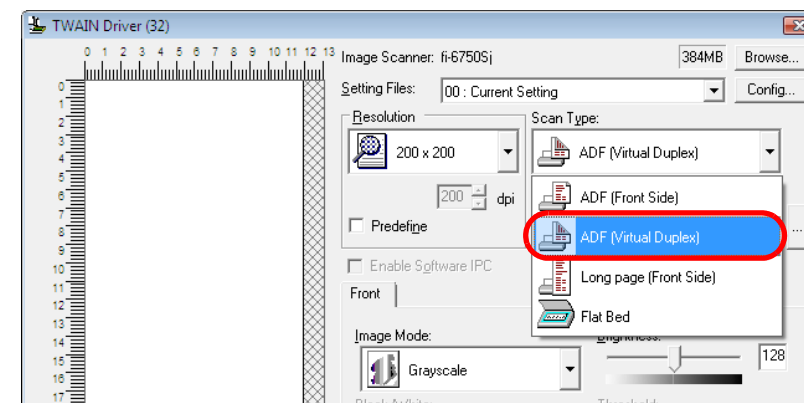

In the ISIS scanner driver, you cannot configure settings for ADF virtual duplex scanning. When using this driver, go to the [Scan Settings] dialog box or use the Batch Scan option.

3 From ScandAll PRO, perform a scan.

For how to perform a scan, refer to "ScandAll PRO V2.0 User's Guide".

⇒ When the scanning is complete, a message appears to prompt you to load your document face up.

4 Load the document face up on the ADF Paper Chute.

For how to load documents on the ADF Paper Chute, refer to "[2.1 Loading Documents on the ADF](#)" (on page 39).



When scanning the back side pages, carefully load the document so that:

- the back-side pages will be scanned in the same order as the front-side pages.
- the front-side pages will not be scanned up-side-down.

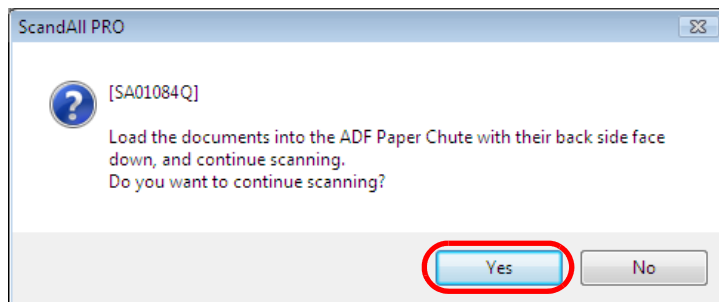
5 In response to the message shown, click the [Yes] button.

⇒ The back-side pages of the document are scanned.

6 When the scanning is complete, the scanned document images are sorted automatically.

- The ADF Virtual Duplex option is not available once you have selected any of the following. To use the option, clear the selected item(s) in ScandAll PRO and/or in the scanner driver.
 - the [Output color and monochrome simultaneously] and [Automatic Color-Monochrome Detection] checkboxes on the [File format and Name scheme] tab of the [Profile Editor] dialog box.
 - any of the checkboxes under [Job Separator Sheet Handling] on the [Document separator] tab of the [Profile Editor] dialog box.
 - the [Multi Image Output] checkbox in the [Multi Image] dialog box, which is opened by clicking the [Enable Multi Image] checkbox in the [TWAIN Driver (32)] dialog box of the TWAIN scanner driver.
 - the [Split Image] and [Blank Page Skip] checkboxes in the [Option] dialog box, which is opened by clicking the [Option] button in the [TWAIN Driver (32)] dialog box of the TWAIN scanner driver.
- The scanned images are not sorted if the page count on the front pages differs from that on the back sides.

4.4 Setting Post-Scan Operations and Handling

Automatically Correcting Skewed Document Images

You can direct the scanner to sense and automatically correct your document skew if it is fed askew into the ADF.

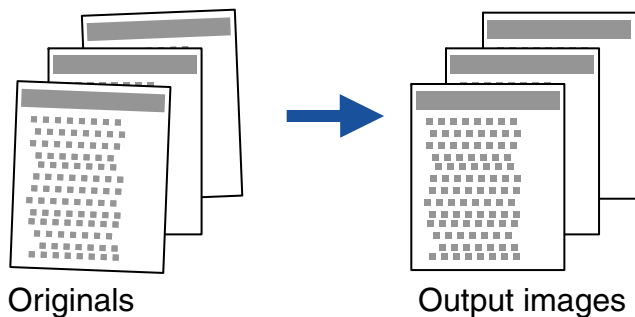

- 1 Load a target document on the ADF Paper Chute.
For how to load documents on the ADF Paper Chute, refer to ["2.1 Loading Documents on the ADF" \(on page 39\)](#).
- 2 Start up ScandAll PRO, and then open the [TWAIN Driver (32)] dialog box.
For how to open the [TWAIN Driver (32)] dialog box, refer to "ScandAll PRO V2.0 User's Guide".
- 3 Click the [Option] button.

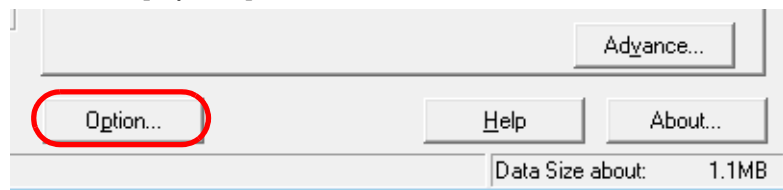

⇒ The [Option] dialog box appears.

- 4 Select the [Rotation] tab, and then select [Automatic Deskew] or [Automatic Page Size Detection] under [Automatic Size and Skew detection].

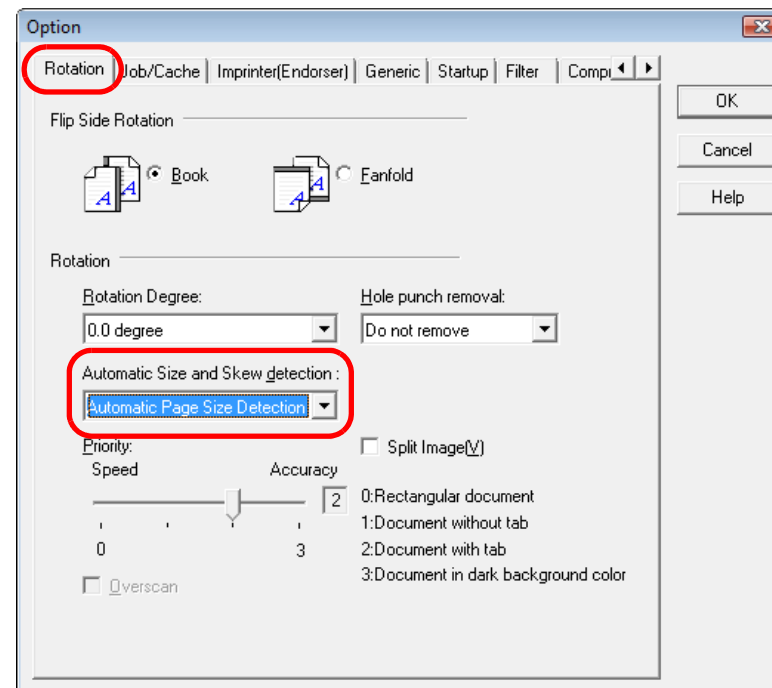



- When [Automatic Deskew] is selected, the paper size of documents is not automatically detected.
- With the [Priority] slider control, you can change the accuracy of Automatic Page Size Detection.
 - To give a priority to the scan speed before scanning documents, specify a smaller value. To give a priority to the detection accuracy, specify a larger value.
 - When detecting a paper size of documents to which index sheets, sticky notes or index stickers are attached, specify 2 for the priority.
 - When detecting a paper size of documents whose one side (front or back) is in dark background color, specify 3 for the priority.

Priority	Suited Document Type
0	Rectangular documents with straight side edges
1	Documents without tabs (those that have no index sheets, sticky notes, or index stickers)
2	Documents with tabs (those that have index sheets, sticky notes, or index stickers)
3	Documents whose one side (front or back) is in dark background



The Automatic Page Size Detection is not available, if the document to scan is one of the following:

- Thin documents whose paper weight is 52 g/m² or 14 lb or less
- Non-rectangular documents
- Documents whose margins are filled with dark color

5 Click the [OK] button.

⇒ You are returned to the [TWAIN Driver (32)] dialog box.

6 In the [TWAIN Driver (32)] dialog box, click the [OK] button.

⇒ Changes made are saved.

7 From ScandAll PRO, perform a scan.

For how to perform a scan, refer to "ScandAll PRO V2.0 User's Guide".

Setting Auto Correction for Document Page Orientations

You can direct the scanner to automatically correct a batch of documents with a mixture of page orientations.

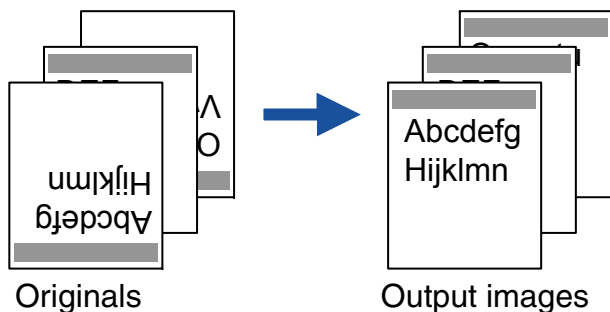

- 1 Load a target document on the ADF Paper Chute.
For how to load documents on the ADF Paper Chute, refer to "2.1 Loading Documents on the ADF" (on page 39).
- 2 Start up ScandAll PRO, and then open the [TWAIN Driver (32) dialog box.
For how to open the [TWAIN Driver (32)] dialog box, refer to "ScandAll PRO V2.0 User's Guide".
- 3 Click the [Option] button.

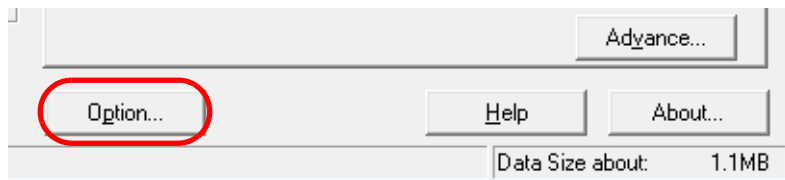

⇒ The [Option] dialog box appears.

- 4 Select the [Rotation] tab, and then select [Automatic] under [Rotation Degree].

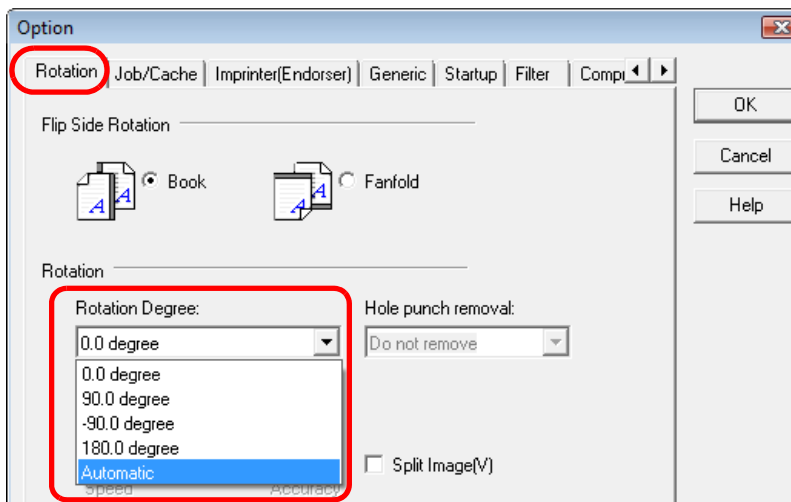

- This function determines a document page orientation based on the characters printed on it. So it may not work properly for the following kinds of documents:
 - Documents with a resolution for scanning not between:
 - 300 dpi and 600 dpi (in Black & White mode) or
 - 200 dpi and 600 dpi (in Color or Grayscale mode)
 - Documents with many extremely-large/small characters
 - Documents on which the pitches of lines or characters are extremely narrow, or characters are overlapped
 - Documents with many photographs or figures and only a few characters
 - Documents on which characters are printed in various directions such as drawings
 - Documents written only in capital characters
 - Handwritten documents
 - Skewed documents

- Documents written in a non-supported language. The supported languages are: Japanese, English, German, French, Spanish, Italian, Korean, Traditional Chinese, Simplified Chinese, Russian, and Portuguese
- Documents with uneven colors, design and/or patterns in background
- Documents with intricate design
- Documents with a lot of noise
- To judge text in documents, use a language that is set in Windows's Regional and Language Options.
- The image orientation may not be corrected properly depending on the scanner driver setting at scanning (e.g. dithering).
- If you cannot correct the image orientation properly, use the Edge Emphasis function of the drivers to correct it.
- Shadows may remain on the edge of the scanned image.
- [Automatic] in [Rotation Degree] is available only when ScandAll PRO is installed.

5 Click the [OK] button.
⇒ You are returned to the [TWAIN Driver (32)] dialog box.

6 In the [TWAIN Driver (32)] dialog box, click the [OK] button.
⇒ The settings configured are saved.

7 From ScandAll PRO, perform a scan.
For how to perform a scan, refer to "ScandAll PRO V2.0 User's Guide".

Saving Scanned Images in PDF Format

You can create PDF data from scanned document images in either of the following two ways:

Creating with ScandAll PRO

ScandAll PRO is recommended for scanning in color or grayscale mode.

With ScandAll PRO, you can:

- Reduce the size of PDF data
- Create PDF data with facility



For how to use ScandAll PRO, refer to "ScandAll PRO V2.0 User's Guide".

Creating with Adobe Acrobat

Adobe Acrobat is recommended when you want to create PDF data quickly and when you scan documents in black-and-white mode. You can:

- Create PDF data at an original resolution in a short time
- Create PDF data compressed to a desired size by changing compression rates

The file size of color documents increases if scanned by following a general procedure. You can drastically reduce the size if you run Acrobat Distiller before saving.

For details, see the HINT box in Step 10 of the "Creating with Adobe Acrobat" section.



Notes on the use of Adobe Acrobat

- As Adobe Acrobat's settings override the settings in the scanner driver, such as for [Resolution], [Scan Type], and [Image Mode], the scanned image may not be displayed as configured with the previous settings in the scanner driver.

- The following options are not available:
 - [256 Color] and [8 Color] modes
 - [Rotation Degree] specified when [End of Page Detection] is selected
 - Long Page Scanning
 - Automatic Page Size Detection
- Scanning paper documents with the scanner and converting them into a PDF format with Adobe Acrobat may output unexpected images in the following cases:
 - The "Edge Shadow Removal" option enabled in Acrobat, and the "Digital Endorser" or "Black Background" option specified in the TWAIN scanner driver at the same time. In this case, character strings embedded in the image or the background may be lost.
Solution 1: In Acrobat, select [File] ⇒ [Create PDF] ⇒ [From Scanner] ⇒ [Image Settings], and set [Edge shadow removal] to [OFF] or set [Color/Grayscale] and/or [Monochrome] under [Compression] to a setting other than [Adaptive].
Solution 2: Adjust the scanning density in the TWAIN scanner driver.
 - The option(s) [Color/Grayscale] and/or [Monochrome] set to [Adaptive] under [Compression] in Acrobat, and documents scanned at a resolution lower than the recommended value for Acrobat. In this case, inappropriate images may be output.
Solution: Under [Compression], set [Color/Grayscale] and/or [Monochrome] to a setting other than [Adaptive].
 - The "Overscan" option specified in the TWAIN scanner driver to scan documents of Double-Letter size (11x17 in.) or those of A3 size or longer. Such documents may not be scanned properly because scanning of those sizes are not available in Acrobat.
Solution: When scanning a Double-Letter sized document (11x17 in.) or an A3-sized or longer document, do not set [Overscan] in the TWAIN scanner driver.

For detailed usage and information on Acrobat, refer to "Create a PDF file from a scanned document" in the Adobe Acrobat Help.

■ Creating with ScandAll PRO

- Load a target document on the scanner.
For how to load documents on the scanner, refer to "[Chapter 2 Loading Documents](#)" (on page 38).
- In ScandAll PRO, select [PDF File], [SinglePage PDF File], [PDF/A file], or [SinglePage PDF/A file] to save the scanned document images.



The file format of [PDF file] or [SinglePage PDF file] is saved as a file compatible with Adobe Acrobat 4.0 (PDF 1.3); that of [PDF/A file] or [SinglePage PDF/A file] saved in a PDF/A-1b format (format for an archive of digital documents based on PDF 1.4).
Selecting [SinglePage PDF file] or [SinglePage PDF/A file] creates one file per image, and selecting [PDF file] or [PDF/A file] creates one file containing multiple images.

When scanning with the "Scan" option

Select a file format from the [File Format] in the [Scan Settings] dialog box.

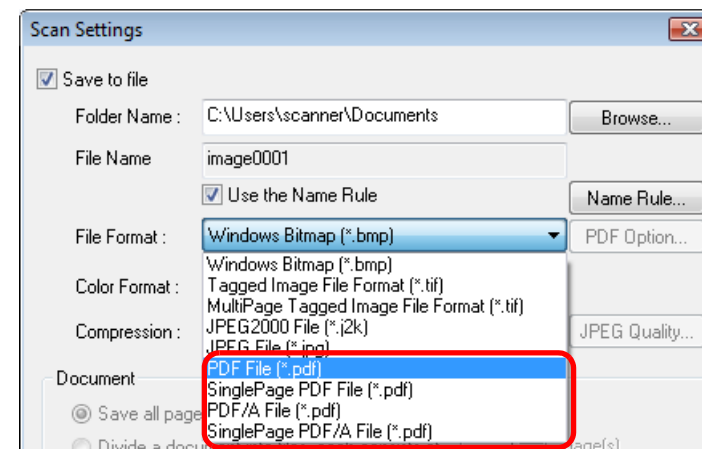

When scanning with the "Batch Scan" option

Display a profile name you want to use for scanning your file in the [Profile Editor] dialog box. Select the [File format and Name scheme] tab, and then select a file format from [File Format].

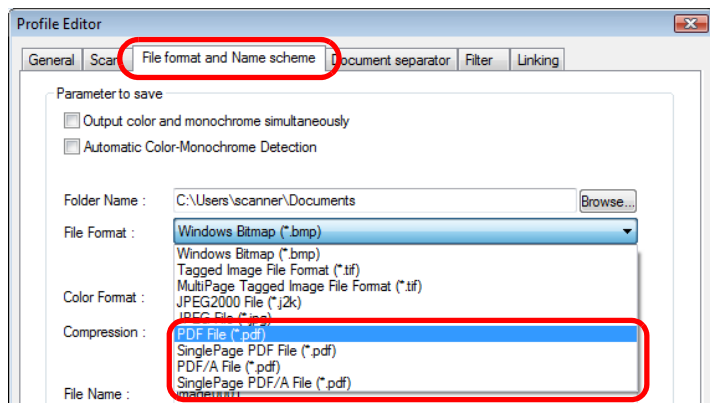

3 To configure PDF-related optional settings, click the [PDF Option] button.

⇒ The [Output PDF File] dialog box appears.

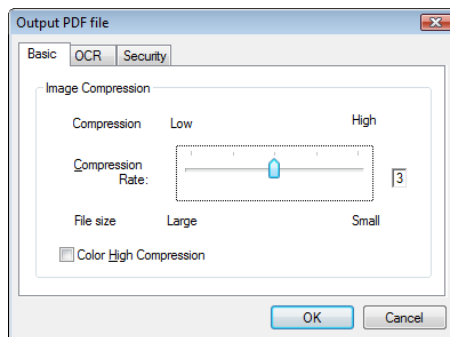

In this dialog box, you can change the compression rate for creating a file, turn on the OCR (i.e., text recognition) function to make searchable PDF files, and enhance the security of created PDF files by adding a password to.



For details about the [Output PDF File] dialog box, refer to the ScandAll PRO Help.

4 From ScandAll PRO, perform a scan. For how to perform a scan, refer to "ScandAll PRO V2.0 User's Guide".

■ Creating with Adobe Acrobat

- 1 Load a target document on the scanner.
For how to load document on the scanner, refer to "[Chapter 2 Loading Documents](#)" (on page 38).
- 2 Select the [start] menu ⇒ [All Programs] ⇒ [Adobe Acrobat].
⇒ Adobe Acrobat starts up.
- 3 Select the [File] menu ⇒ [Create PDF] ⇒ [From Scanner].

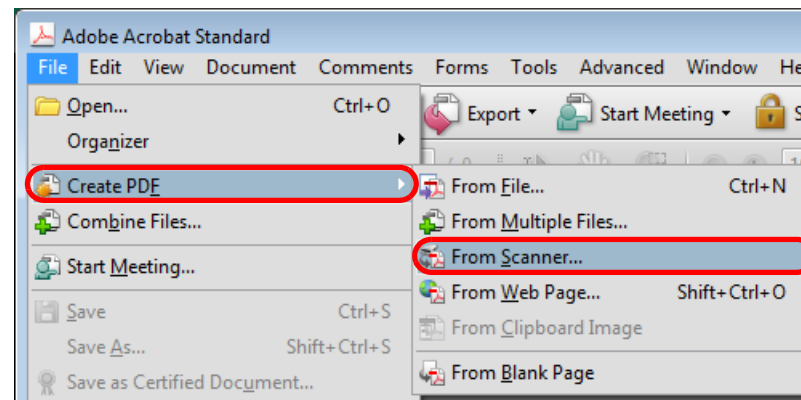

⇒ The [Acrobat Scan] dialog box appears.

4 Select one of the following at [Scanner].

- FUJITSU fi-6670dj
- FUJITSU fi-6770dj
- FUJITSU fi-6750Sj

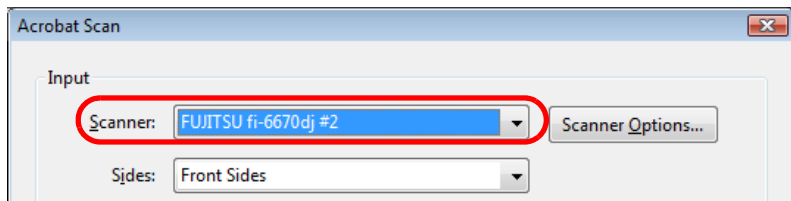

If your document is scanned under the default settings, the output image(s) may not be satisfactory. It is recommended the settings be changed, following the procedure below:

- 1 Clear the [Make Searchable (Run OCR)] checkbox.
- 2 Click the [Options] button for [Optimization].
⇒ The [Optimization Options] dialog box appears.
- 3 Select [Custom Settings] and change the following settings:
 - Color/Grayscale: none
 - Monochrome: JBIG2 or CCITT Group 4
 - Background removal: Off
 - Edge shadow removal: Off

5 Click the [Scanner Options] button.

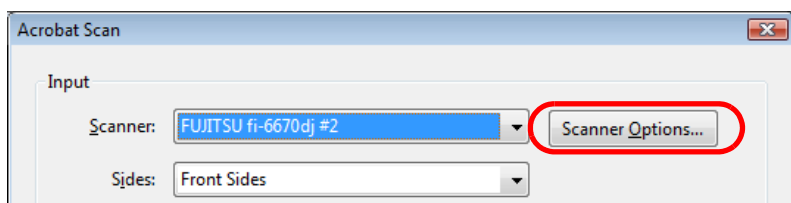

⇒ The [Scanner Options] dialog box appears.

6 Select [Show Scanner's Native Interface] at [User Interface], and then click the [OK] button.

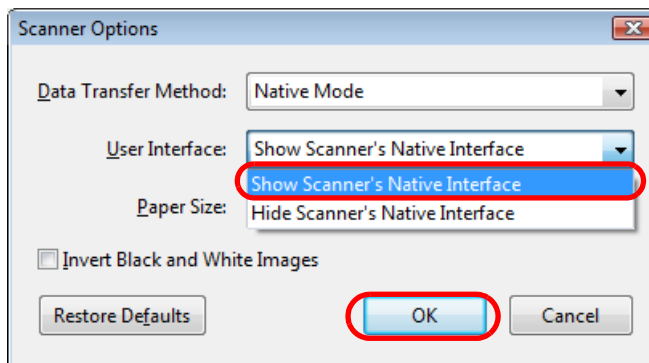

⇒ The [Scanner Options] dialog box is closed and you are returned to the [Acrobat Scan] dialog box.

7 Click the [Scan] button.

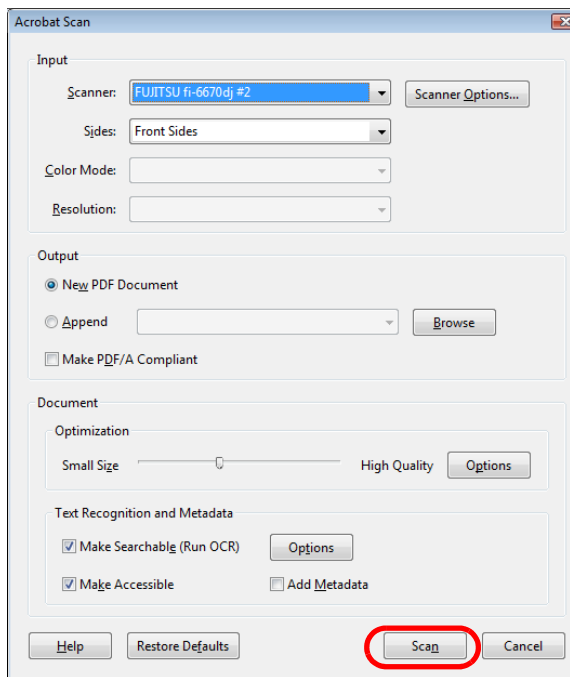

⇒ The [Save Scanned File As] dialog box appears.

- 8 Type in the name of the file to save at [File name], and then click the [Save] button.

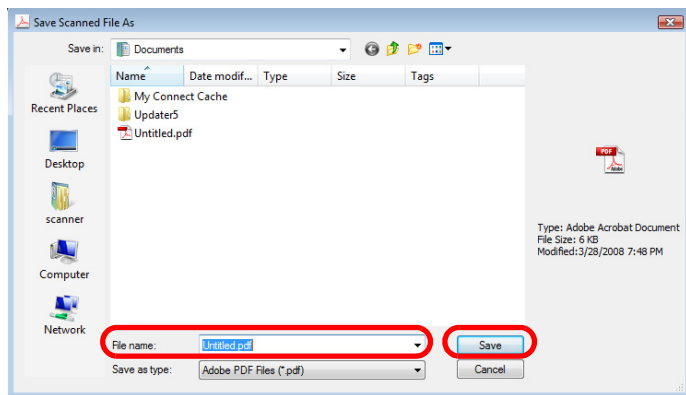

⇒ The scanned images are displayed.

- 9 Configure settings such as for [Image Mode] and [Resolution], and then click the [Scan] button.

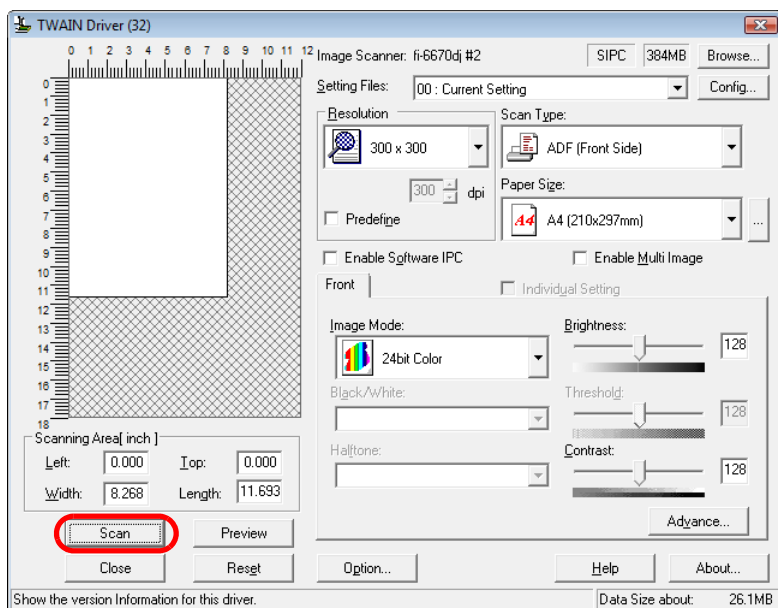

- 10 To finish the scanning, select [Scanning complete] and click the [OK] button.

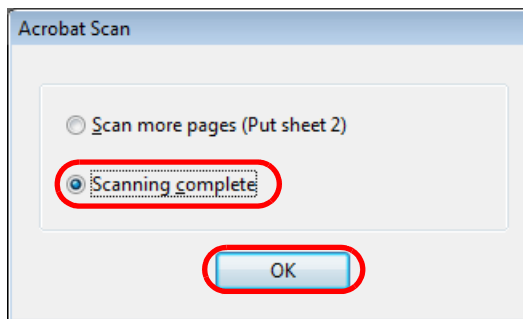

⇒ The scanned images are displayed.

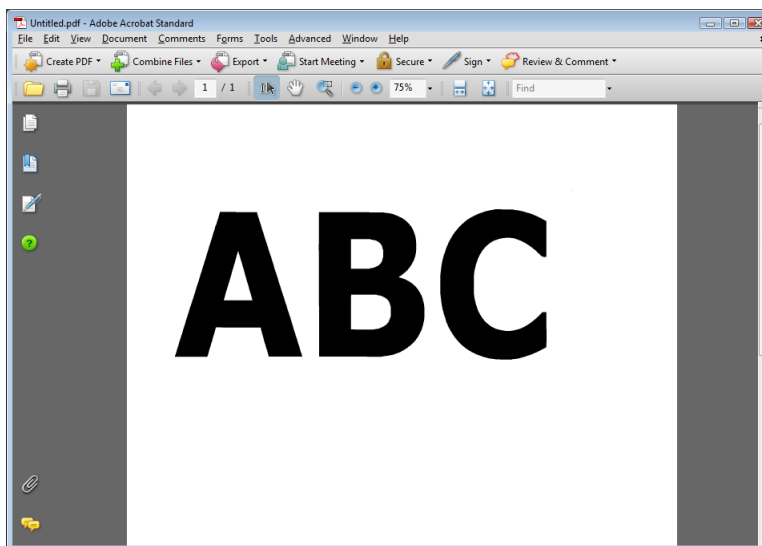

For details on the operation of Adobe Acrobat, refer to the Adobe Acrobat Help.

- TOP
- Contents
- Index
- Introduction
- Scanner Overview
- Loading Documents
- Scan Parameters
- Various Documents
- Daily Care
- Consumables
- Trouble-shooting
- Operational Settings
- Appendix
- Glossary



If you save the scanned document images in Step 8 above, the file size may increase greatly. To reduce the size, retry saving the images, following the procedure below. (It may take more time than you save as usual.)

- 1 Select [File] ⇒ [Print].
- 2 In the dialog box below, select [Adobe PDF] at [Name].

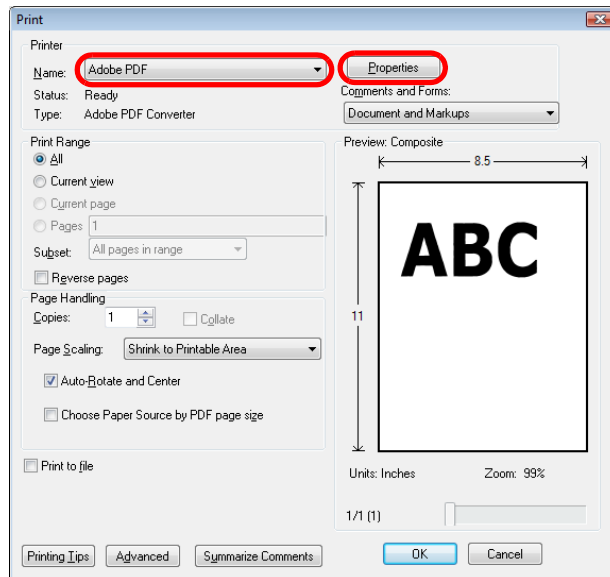

- 3 Click the [Properties] button.
⇒ The [Adobe PDF Document Properties] dialog box appears.
- 4 Select the [Adobe PDF Settings] tab.
- 5 Select a desired job option from [Default Settings]. Here, for example, select [Smallest File Size].
- 6 Click the [OK] button.
- 7 In the [Print] dialog box, click the [OK] button.
⇒ The [Save PDF File As] dialog box appears.
- 8 Specify a desired file name, and then click the [Save] button to save the file.

Horizontally Splitting a Scanned Image into Two

You can obtain two images by horizontally splitting a single scanned page image.



This function is not supported by all applications.

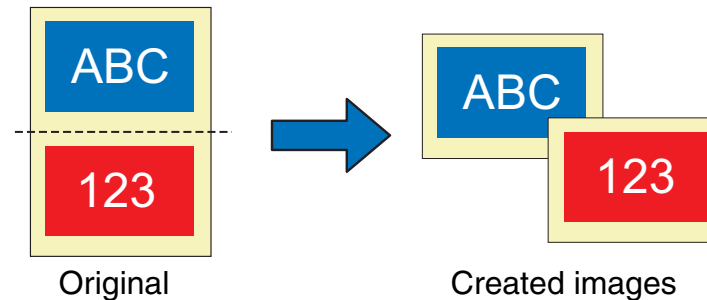

- 1 Load a target document on the scanner.
For how to load documents on the scanner, refer to "[Chapter 2 Loading Documents](#)" (on page 38).
- 2 Start up ScandAll PRO, and then open the [TWAIN Driver (32)] dialog box.
For how to open the [TWAIN Driver (32)] dialog box, refer to "ScandAll PRO V2.0 User's Guide".
- 3 Click the [Option] button.

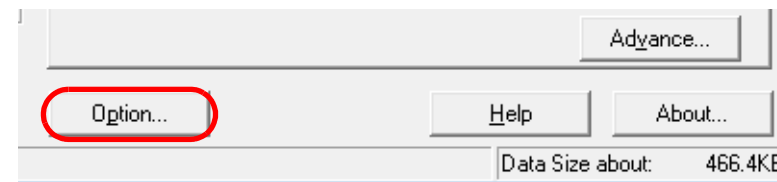

⇒ The [Option] dialog box appears.

- 4 Select the [Rotation] tab, and then select the [Split Image] checkbox.

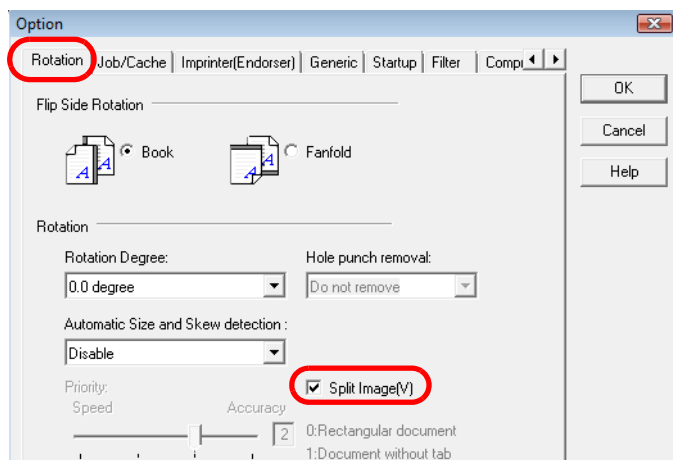

When a document is scanned in Duplex Scan mode, the scanned back side image(s) are output according to the [Flip Side Rotation] settings in the order below:

- Book: Upper half ⇔ Lower half
- Fanfold: Lower half ⇔ Upper half



This function is not available with:

- [Multi Image Output] selected
- [Color/Monochrome Auto Detection] selected

- 5 Click the [OK] button.
⇒ You are returned to the [TWAIN Driver (32)] dialog box.

- 6 In the [TWAIN Driver (32)] dialog box, click the [OK] button.
⇒ Changes made are saved.

- 7 From ScandAll PRO, perform a scan.
For how to perform a scan, refer to "ScandAll PRO V2.0 User's Guide".

Outputting in Multi-Image Mode

You can obtain both color/grayscale and binary black-and-white image outputs at a single scan (this is called the Multi Image Output function).



This function is not supported by all applications.

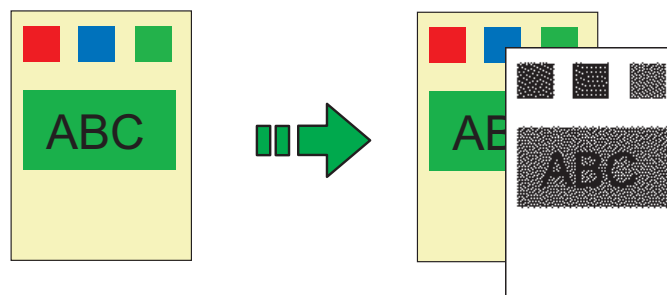

Original

Created images

Example: When a color document is scanned

- 1 Load a target document on the scanner.
For how to load documents on the scanner, refer to "[Chapter 2 Loading Documents](#)" (on page 38).
- 2 Start up ScandAll PRO, and then open the [TWAIN Driver (32)] dialog box.
For how to open the [TWAIN Driver (32)] dialog box, refer to "ScandAll PRO V2.0 User's Guide".

3 Select the [Enable Multi Image] checkbox.

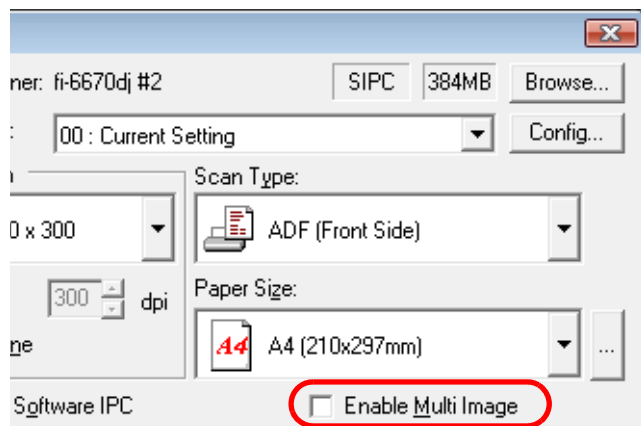

⇒ The [Multi Image] dialog box appears.

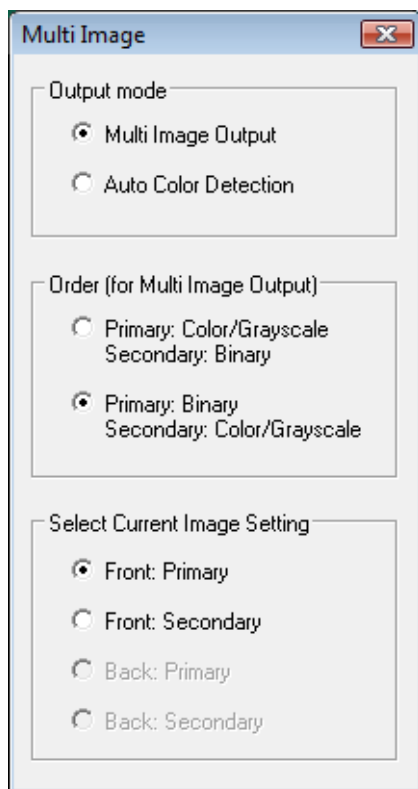

4 Select [Multi Image Output] under [Output mode].

5 Select the order to output multi-images under [Order (for Multi Image Output)].

- Primary: Color/Grayscale
Secondary: Binary
First, a color or grayscale image is output, and then a black-and-white image.
- Primary: Binary
Secondary: Color/Grayscale
First, a black-and-white image is output, and then a color or grayscale image.

6 Under [Select Current Image Setting], select a side (if in Duplex Scan mode).

7 In the [TWAIN Driver (32)] dialog box, click the [OK] button.

⇒ Changes made are saved.

8 From ScandAll PRO, perform a scan.

For how to perform a scan, refer to "ScandAll PRO V2.0 User's Guide".

Setting Auto Detection for Content Colors (Color/Monochrome)

You can configure settings so the scanner will automatically detect whether the images are color (or grayscale) or binary black-and-white ones. Scanning color documents produces color (or grayscale) images, and scanning black-and-white documents produces black-and-white images.



This function is not supported by all applications.

- 1 Load a target document on the scanner.
For how to load documents on the scanner, refer to "[Chapter 2 Loading Documents](#)" (on page 38).
- 2 Start up ScandAll PRO, and then open the [TWAIN Driver (32)] dialog box.
For how to open the [TWAIN Driver (32)] dialog box, refer to "ScandAll PRO V2.0 User's Guide".
- 3 Select the [Enable Multi Image] checkbox.

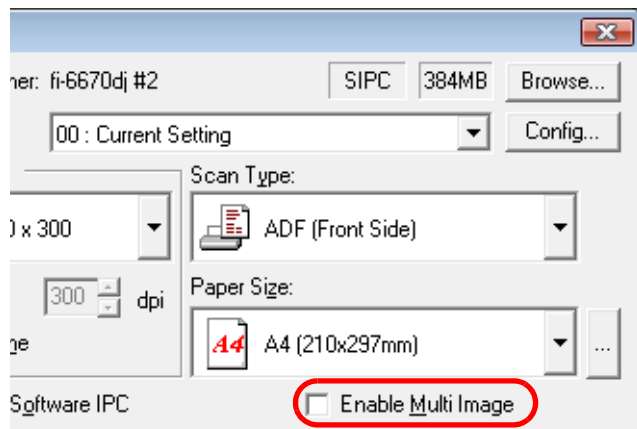

⇒ The [Multi Image] dialog box appears.

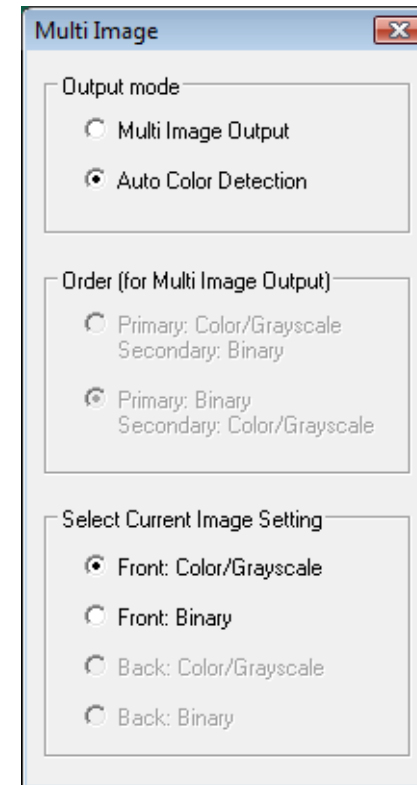

- 4 Select [Auto Color Detection] under [Output mode].

5 Under [Select Current Image Setting], select the side(s) to scan.

Configure scan settings for both color and black-and-white documents in the [TWAIN Driver (32)] dialog box.

You need to pre-configure settings for [Color/Grayscale] detection as well as those for [Binary] detection.

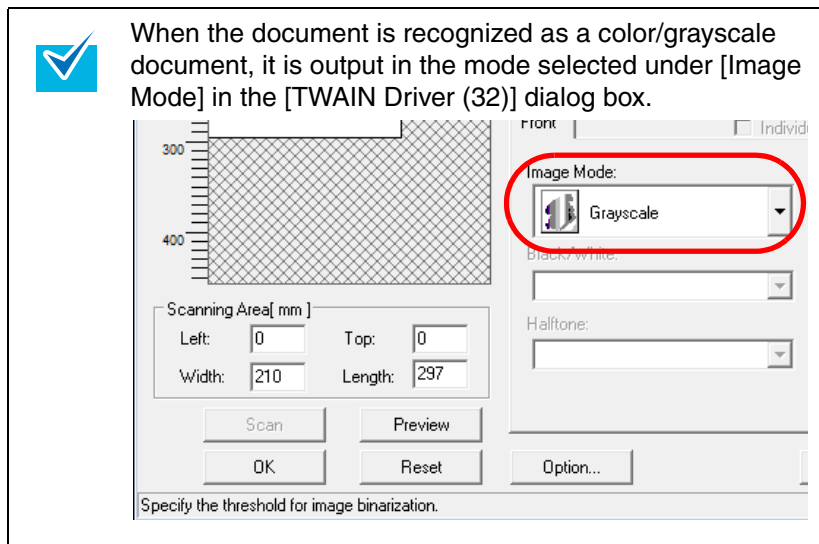

6 In the [TWAIN Driver] dialog box, click the [OK] button.

⇒ Changes made are saved.

7 From ScandAll PRO, perform a scan.

For how to perform a scan, refer to "ScandAll PRO V2.0 User's Guide".

4.5 Customizing the Hardware Settings

Using the Scanner Buttons to Start A Scan Quickly

You can perform a scan simply by pressing the [Scan/Stop] or [Send to] button on the scanner. To do this, you first need to assign your desired scanning applications to these buttons.

Computer Settings

- 1 Confirm that the scanner is connected properly to your computer, then power on the scanner.
For how to connect the scanner to your computer, refer to "Chapter 3 Connecting the Cables" in the Getting Started.
- 2 Select the [start] menu ⇒ [Control Panel].
⇒ The [Control Panel] window appears.
- 3 Select the [Hardware and Sound] icon.
⇒ The [Hardware and Sound] window appears.
- 4 Select the [Scanners and Cameras] icon.
⇒ The [Scanners and Cameras] window appears.
- 5 Display the properties of the scanner.
Double-click the [fi-6670dj], [fi-6770dj], or [fi-6750Sj] icon.

- 6 Select the [Events] tab, and then select an event from [Select an event].

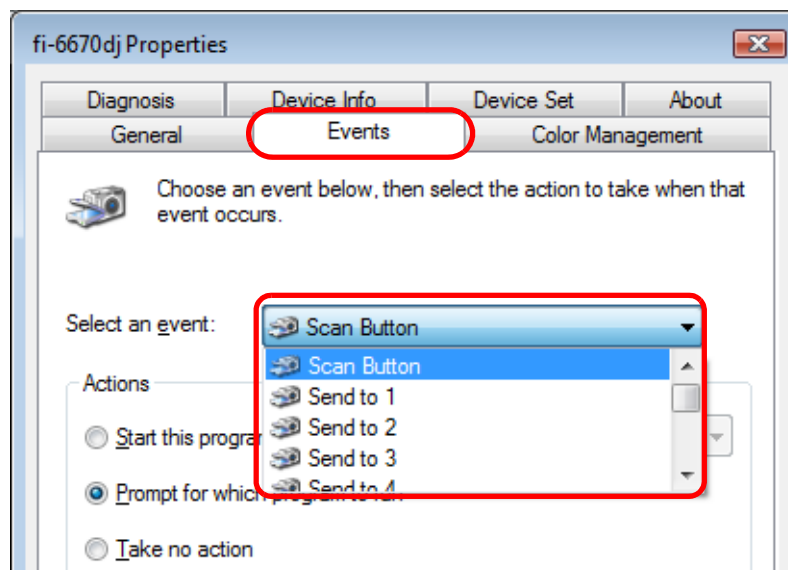

The following events can be selected:

- "Scan Button" (when the [Scan/Stop] button is pressed)
- "Send to 1" to "Send to 9" (when the [Send to] button is pressed while a number (from 1 to 9) is displayed on the Function Number Display)

TOP

Contents

Index

Introduction

Scanner
OverviewLoading
DocumentsScan
ParametersVarious
Documents

Daily Care

Consumables

Trouble-
shootingOperational
Settings

Appendix

Glossary

- 7** Select the application to launch when an event occurs. Select the [Start the program] radio button under [Actions], and then select the application you want to use.

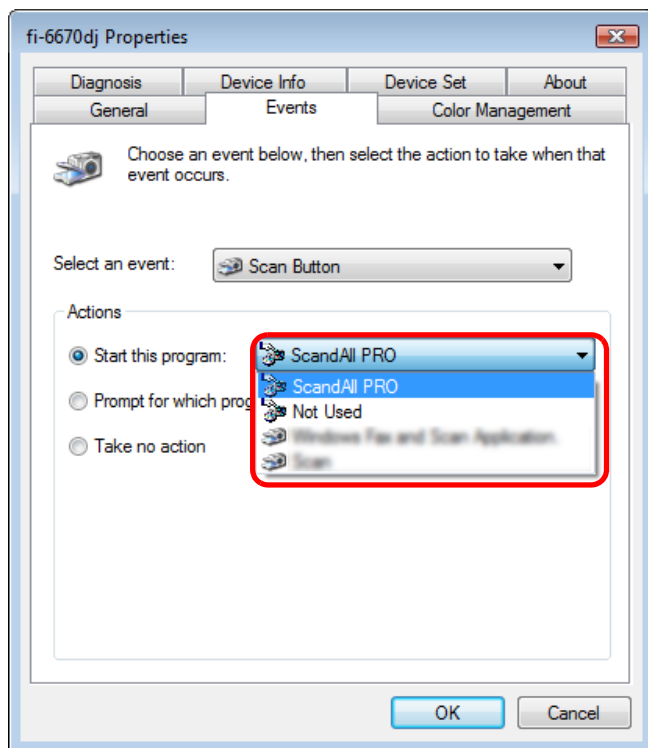

- 8** Click the [OK] button. If you are using ScandAll PRO, refer to "ScandAll PRO V2.0 User's Guide". This completes the computer settings if you will use a scanning application other than ScandAll PRO. Then, continue to configure settings for your scanner.



- The screens and operations may differ slightly depending on the OS you are using.
- If you want to link with other buttons here, repeat Steps 5 to 8.

Scanner Settings

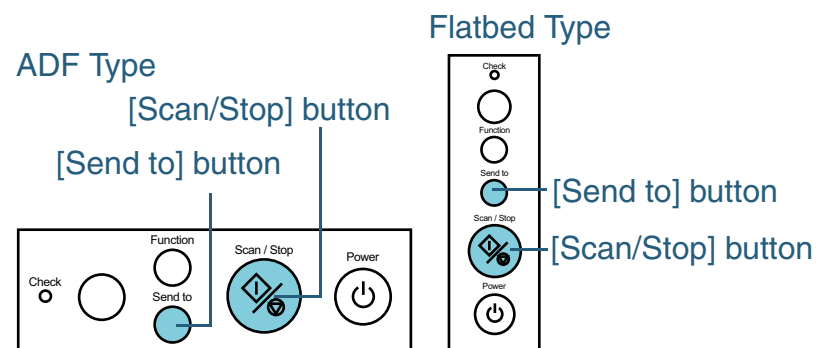

- When using the [Scan/Stop] button
No setting is needed.
⇒ Pressing the [Scan/Stop] button starts up the application configured.
- When using the [Send to] button
Press the [Function] button to change a number displayed on the Function Number Display.
When the displayed number and the event number you have selected in Step 5 ("Send to 1" to "Sent to 9") matches, stop pressing the [Function] button.
To perform the event configured with "Send to 2," for example, display [2] on the Function Number Display.
⇒ Pressing the [Send to] button starts up the application you selected.



- For details of the Operator Panel, refer to "[1.3 Functions of the Operator Panels](#)" (on page 28).
- Each time the [Function] button is pressed, the number displayed changes as follows: 1, 2, 3, ...9, C, 1, 2, 3, ...

Detecting Multifeeds

A "multifeed" is a feeding error that occurs when two or more sheets in the ADF Paper Chute are fed simultaneously into the scanner.

You can set the scanner so it will detect multifeeds and display an error message.

To make the scanner to detect multifeeds, change the settings in the scanner driver or in the Software Operation Panel.

For how to configure settings in the Software Operation Panel, refer to ["Multifeed Detection" \(on page 163\)](#).

- 1 Load a target document on the ADF Paper Chute.
For how to load documents on the ADF Paper Chute, refer to ["2.1 Loading Documents on the ADF" \(on page 39\)](#).
- 2 Start up ScandAll PRO, and then open the [TWAIN Driver (32)] dialog box.
For how to open the [TWAIN Driver (32)] dialog box, "ScandAll PRO V2.0 User's Guide".

- 3 Click the [Option] button.

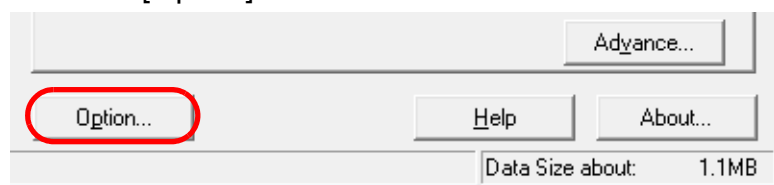

⇒ The [Option] dialog box appears.

- 4 Select the [Job/Cache] tab, and then specify the desired multifeed detection condition at [Multifeed Detection] under [ADF Option].

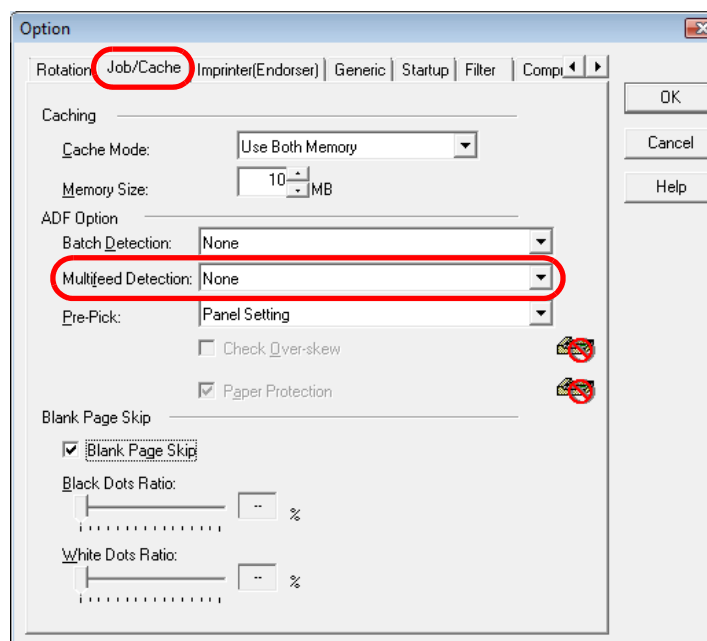

The following list the multifeed detection conditions:

Condition	Description
None	Does not detect multifeeds.
Check Overlapping and Length	Monitors both document overlapping and length to detect multifeeds.
Check Overlapping	Uses the built-in ultrasonic sensors inside the ADF to monitor document sheets during feeding, and to judge multifeeds according to the deviation of reflected ultrasonic waves.
Check Length	Monitors the length of document during feeding, and judges multifeeds according to the deviation of lengths sensed.

For details of the multifeed detection, refer to "[Multifeed Detection Conditions](#)" (on page 45).

- 5 Click the [OK] button.
⇒ You are returned to the [TWAIN Driver (32)] dialog box.
- 6 In the [TWAIN Driver (32)] dialog box, click the [OK] button.
⇒ Changes made are saved.
- 7 From ScandAll PRO, perform a scan.
For how to perform a scan, refer to "ScandAll PRO V2.0 User's Guide".

Bypassing Multifeed Detection for a Fixed Format

If you attempt to scan a document sheet with a sticky note, receipt, or photo glued on it while the Multifeed Detection function is enabled, the scanner could mistakenly judge this as a multifeed error and discontinue the scanning. To resolve such a problem, the "Intelligent Multifeed Function" is provided.

There are two modes to this function. In one mode, you can suppress multifeeds forcibly by operating the Operator Panel on the scanner. In the other mode, you can suppress multifeeds automatically by letting the scanner learn the locations and sizes of the sticky note, glued receipt or glued photo beforehand.

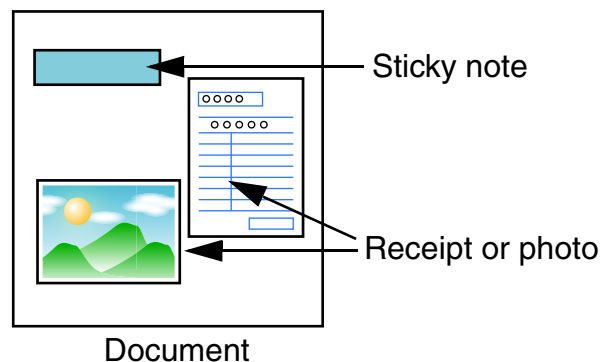

Intelligent Multifeed Function

Use this function when you want to continue scanning while checking if any sticky notes are attached to the document each time the multifeed error occurs.

Mode	Description
Manual Mode (Bypass by Operator Panel button)	The scanner stops scanning each time a multifeed error is detected. You can resume scanning after checking for any glued paper on your document on detection of each multifeed error.
Auto Mode 1 (Bypass by length and position)	Used to scan a document stack with paper of the same size glued at the same position.
Auto Mode 2 (Bypass by length)	Used to scan a document stack with paper of different sizes glued at different positions.



Irregular (incomplete or deformed) images may be created when multifeeds occur.

To select one of the modes above, use the Software Operation Panel.

For details, refer to "[Setting A Non-Multifeed-Detection Range \[Intelligent Multifeed Function\]](#)" (on page 168).

Settings Before Using This Function

Prior to using this function, you need to configure the following settings:

■ With TWAIN Scanner Driver

- 1 Start up ScandAll PRO, select the [Scan] menu ⇒ [Scan Settings].
⇒ The [TWAIN Driver (32)] dialog box appears.
- 2 Click the [Option] button.
- 3 Select the [Job/Cache] tab, and select [Check overlapping] or [Check overlapping and length] for [Multifeed Detection] under [ADF Option].

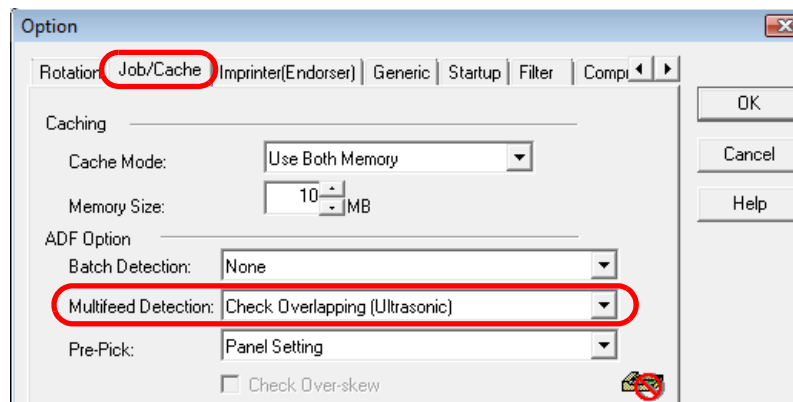
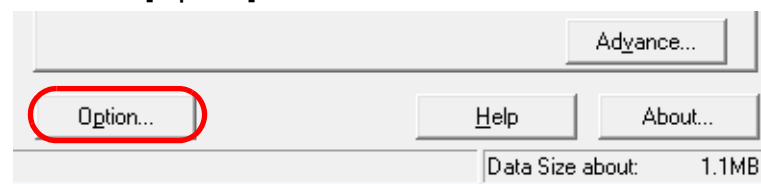

TOP

Contents

Index

Introduction

Scanner
OverviewLoading
DocumentsScan
ParametersVarious
Documents

Daily Care

Consumables

Trouble-
shootingOperational
Settings

Appendix

Glossary

- 4 Select the [Startup] tab, and then select the [Enable Scanner Panel] and [Enable [Scan] Button] checkboxes.

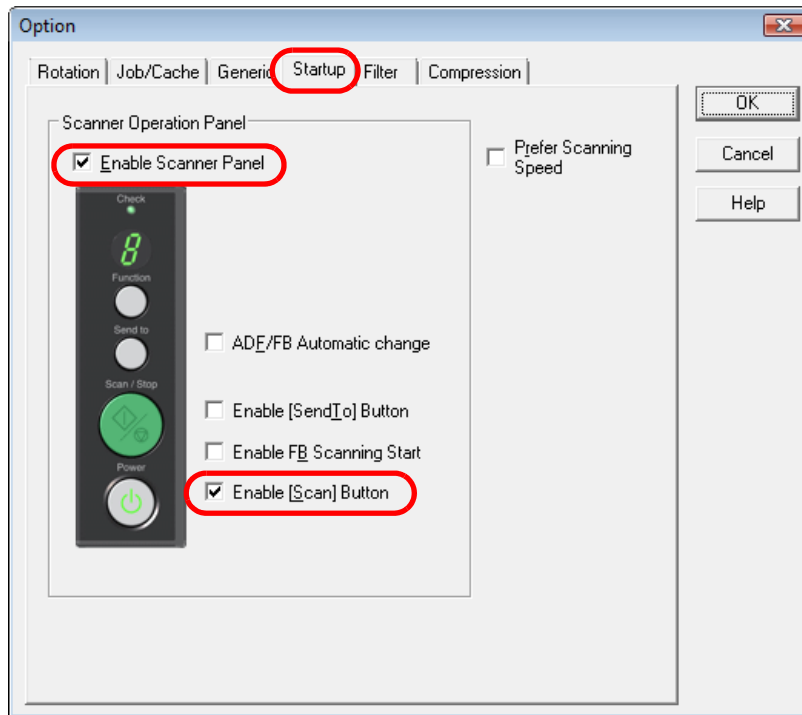

■ With ISIS Scanner Driver

- 1 Start up ScandAll PRO, select the [Scan] menu ⇒ [Scan Settings].
⇒ The ISIS scanner driver's setting dialog box appears.
- 2 Select the [Paper Handling] tab, and then select:
 - [Enable] and [Paper Overlap] under [Multifeed Detection]
 - [On] under [Multifeed Recovery]

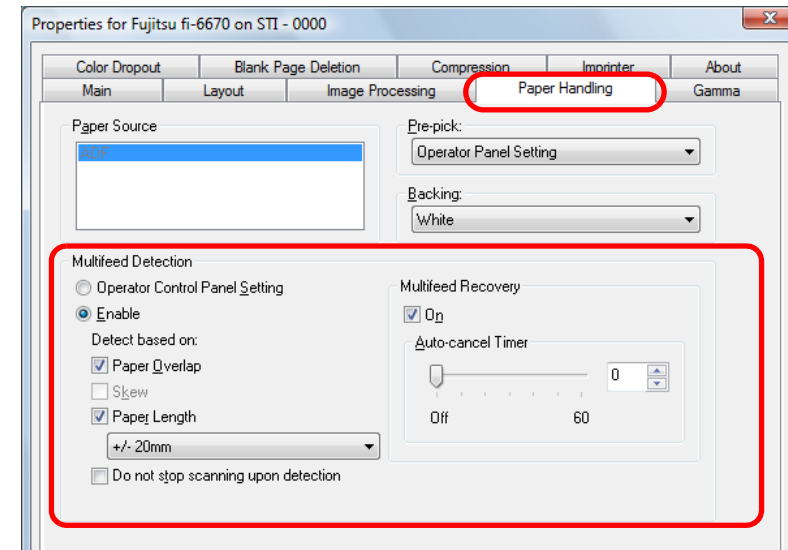

- 3 Specify a desired time (in minutes) at [Auto-cancel Timer].

Operating the Scanner

- 1 After a multifeed error has occurred, press the [Send to] button to eject the document from the paper feed path, or open the ADF and remove the sheets from there.
When the sheets are removed, the function number displayed changes as follows:

At multifeed error

"J" and "2" are indicated alternately.

At document ejecting

⇒ The corresponding function number blinks.

2 Return the ejected or removed sheets to the ADF Paper Chute.

If a multifeed error is detected while no paper has been glued on the sheet, press the [Scan/Stop] button or restart the scanning via the computer. (In this case, do not press the [Function] button.)

If glued paper is present on the removed/ejected sheet and this is likely the cause of the multifeed error, then go to the next step:

ADF Type

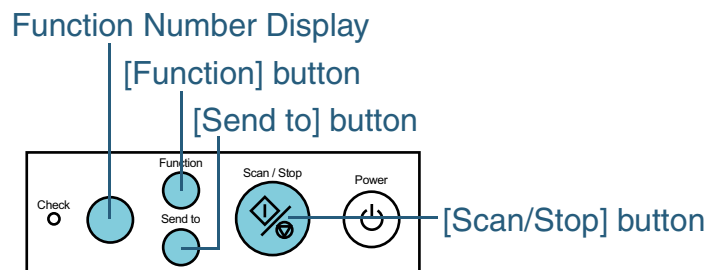

Flatbed Type

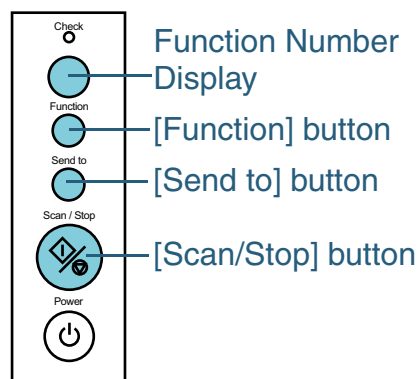

3 Press the [Function] button, and then make sure that the function number blinks faster than before you pressed the [Scan/Stop] button. Otherwise, restart the scanning via the computer.

Note that, from this on, the blinking speed of the function number switches between "slow" and "fast" every time the [Function] button is pressed. According to the mode specified, the scanner operates as explained below if documents are scanned with the function number blinking faster.

- **Manual Mode (Bypassing by operator panel buttons)**
The first sheet of document is scanned without a multifeed error being detected. When the second and following sheets are scanned, multifeed errors are detected based on the settings that have been configured in the Software Operation Panel or in the scanner driver.
- **Auto Mode 1 (Bypassing by Document Overlapping and Length)**
The scanner remembers the length and location of glued paper (overlap pattern) that caused a multifeed error and continues scanning. When glued paper of a similar pattern is detected, the scanner automatically ignores it to suppress multifeed detection. (*1)(*2)
- **Auto Mode 2 (Bypassing by Document Length)**
The scanner remembers the length of the glued paper that caused a multifeed error and continues scanning. When glued paper of the same or shorter length is scanned, the scanner automatically ignores it to suppress multifeed detection. (*2)

*1: In this mode, up to 32 overlap patterns can be remembered (stored in memory). When the 33rd overlap pattern is detected, the first-remembered pattern is deleted from memory.

*2: The remembered overlap patterns can be deleted from memory by pressing the [Function] button for 2 seconds or longer while the function number is blinking. After all overlap patterns are deleted, the display indicates "o" (square). By doing so, you can delete all 32 patterns. Be careful not to delete necessary overlap patterns, too.

Chapter 5 Daily Care

This chapter describes how to clean the scanner.



CAUTION



- When operating the scanner, the glasses inside the ADF become very hot.
- Before you clean the inside of the scanner, turn off its power and unplug the power cable from the power outlet. Wait for at least 15 minutes for the ADF glasses to cool down.
- Before you clean the Feed Rollers and Eject Rollers, turn off the power and unplug the AC adapter from the power outlet. Wait for at least 15 minutes, then turn on the power again.



WARNING



Do not use any aerosol sprays or alcohol based sprays to clean the scanner. Dust blown up by strong air from the spray may enter the inside of the scanner. This may cause the scanner to fail or malfunction.

Sparks caused by static electricity, generated when blowing off dust and dirt from the outside of the scanner, may cause a fire.



5.1 Cleaning Materials and Locations Requiring Cleaning.....98

5.2 Cleaning the ADF 100

5.3 Cleaning the Flatbed (Flatbed Type Only) 105

5.1 Cleaning Materials and Locations Requiring Cleaning

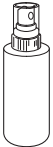
Cleaning Materials

Cleaning Material	Part No.	Remarks
Cleaner F1 	PA03950-0352	1 bottle (100 ml) Moisten the cloth with this fluid and wipe the scanner clean. As it may take long before the cleaner vaporizes if a large quantity is used. Dampen a cloth with modest quantities of the cleaner. In addition, wipe off the cleaner completely with a soft lint-free cloth to leave no residue on the surface of the cleaned parts.
Cleaner F2 	PA03950-0353	1 bottle (80 ml) Use this cleaner to clean the Plastic Rollers only.
Cleaning paper 	CA99501-0012	Use this paper together with Cleaner F1.
Cleaning wipe 	PA03950-0419	1 box (24 sheets) Pre-moistened with Cleaner F1, Cleaning Wipes are used instead of moistened cloths.
Swab	Commercially available.	
Dry cloth		



Never clean rubber rollers with Cleaner F2. Doing so may deform the rubber.

For details of the cleaning materials, consult the store where you bought your scanner or an authorized FUJITSU service provider.

TOP

Contents

Index

Introduction

Scanner
OverviewLoading
DocumentsScan
ParametersVarious
Documents

Daily Care

Consumables

Trouble-
shootingOperational
Settings

Appendix

Glossary

Locations to Clean and Cleaning Frequency

Location		Cleaning paper sprayed with Cleaner F1 (every 10,000 sheets)	Cleaning wipes or cloth sprayed with Cleaner F1 (every 10,000 sheets)	Swab dipped with Cleaner F2 (for areas with heavy dirt)
Flatbed	Document holding pad	No	Yes	No
	Document bed	No	Yes	No
ADF	Chute roller	No	Yes	No
	Pick arm	No	Yes	No
	Pick roller	Yes	Yes	No
	Brake roller	Yes	Yes	No
	Feed roller	Yes	Yes	No
	Plastic roller	Yes	Yes	Yes
	Sheet guide/glass	Yes	Yes	No
	Ultrasonic sensor	Yes (Use a soft, dry cloth.)	No	No

Yes : Cleanable

No : Not cleanable



Never clean rubber rollers with Cleaner F2. Doing so may deform the rubber.



The actual cleaning cycle depends on the conditions of the documents scanned. You must clean the scanner more frequently when the following documents are scanned:

- Smooth-faced documents such as coated paper
- Documents with printed text or graphics almost covering the entire surface
- Chemically treated documents such as carbonless paper
- Documents containing a large amount of calcium carbonate
- A large volume of documents written with pencil
- Documents on which the toner is not fused sufficiently

TOP

Contents

Index

Introduction

Scanner
OverviewLoading
DocumentsScan
ParametersVarious
Documents

Daily Care

Consumables

Trouble-
shootingOperational
Settings

Appendix

Glossary

5.2 Cleaning the ADF

As a Guideline, clean the ADF every 10,000 scanned sheets. Note that this guideline varies according to the type of documents you scan. For example, it may be necessary to clean the ADF more frequently if documents are scanned when the toner is not sufficiently fixed on the printout.



When operating the scanner, the glasses inside the ADF become very hot. Before you clean the inside of the scanner, turn off its power and unplug the power cable from the power outlet. Wait for at least 15 minutes for the ADF glasses to cool down.

Cleaning with a Cloth Moistened with Cleaner F1

- 1 Turn off the scanner, and wait for at least 15 minutes. For how to turn off the scanner, refer to "1.4 Turning the Scanner ON and OFF" (on page 31).
- 2 Pushing the ADF Open Buttons, lift open the ADF.

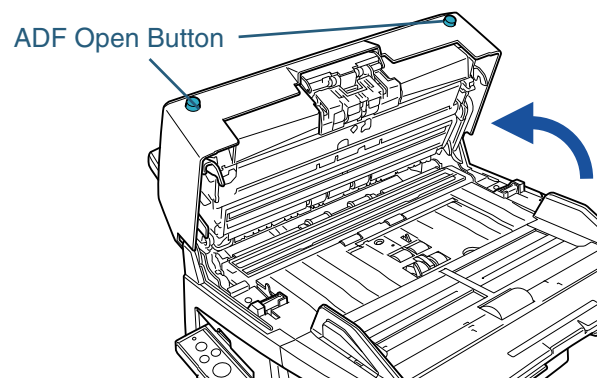

Be careful, the ADF may close and pinch your fingers.

- 3 Clean the following locations using a cloth moistened with Cleaner F1.



To avoid damaging the document sensors, take care so the cloth does not hook them during wiping.

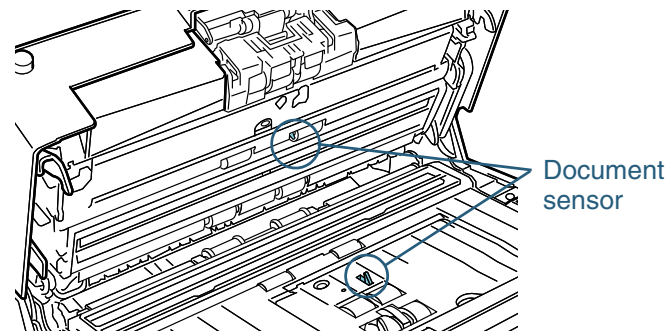

- TOP
- Contents
- Index
- Introduction
- Scanner Overview
- Loading Documents
- Scan Parameters
- Various Documents
- Daily Care**
- Consumables
- Troubleshooting
- Operational Settings
- Appendix
- Glossary

Brake Roller

Lightly clean the Brake Roller along the grooves on the roller, taking care not to scratch its surface.

When cleaning the Brake Roller, remove it from the scanner. For how to remove the Brake Roller, refer to ["6.3 Replacing the Brake Roller"](#) (on page 110).

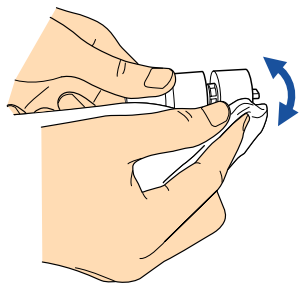

Pick Rollers

Lightly clean the Pick Rollers along the grooves on the rollers, taking care not to scratch their surface. Take particular care when cleaning these rollers as black debris on them adversely affects the pickup performance. For how to remove the Pick Rollers, refer to ["6.2 Replacing the Pick Rollers"](#) (on page 108).

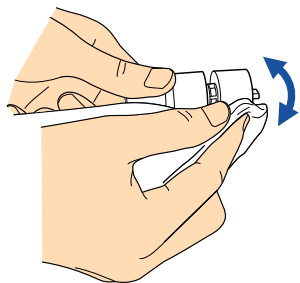

Roller without grooves

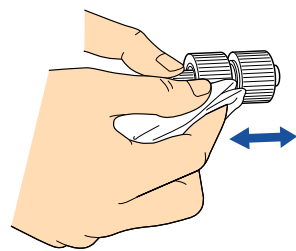

Roller with grooves

Plastic Rollers

Lightly clean the Plastic Rollers, taking care not to damage their surface. Take particular care when cleaning these rollers as black debris on them adversely affects the pickup performance. Be careful not to damage the sponges attached around the middle of the rollers.

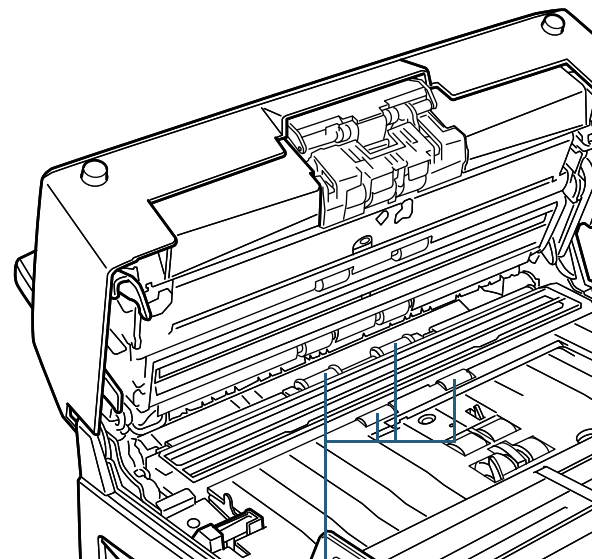

Plastic Roller (x4)

TOP

Contents

Index

Introduction

Scanner
Overview

Loading
Documents

Scan
Parameters

Various
Documents

Daily Care

Consumables

Trouble-
shooting

Operational
Settings

Appendix

Glossary

Pick Arm

Lightly wipe off the roller at the tip of the Pick Arm.

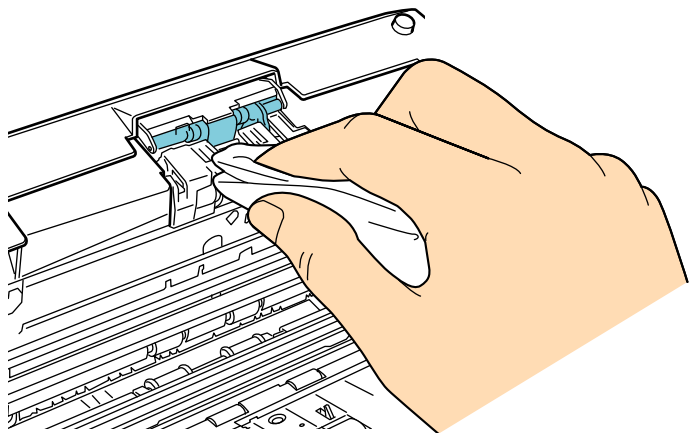

Chute Roller

Lightly wipe off the Chute Roller with its hood open.

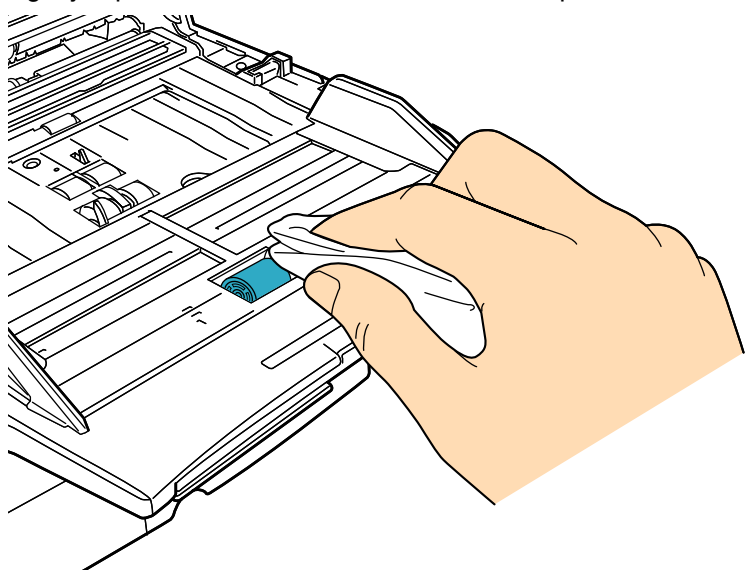

Glasses/Sheet Guides/Ultrasonic Sensors

Lightly wipe off the glasses, Sheet Guides, and Ultrasonic Sensors.

Ultrasonic Sensor (x2)
(for multifeed detection)

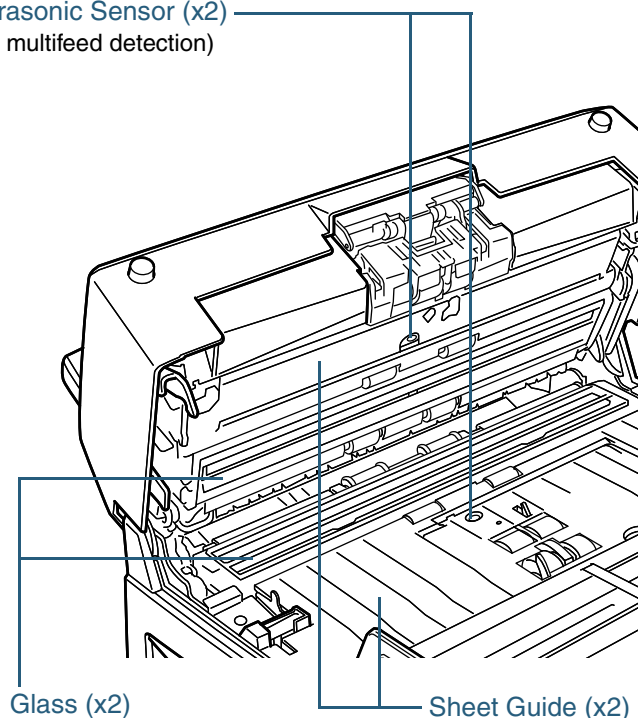

If the glass(es) are dirty, vertical streaks may appear in the scanned images.

- 4 Turn on the scanner. Then, clean the Feed Rollers. For how to turn on the scanner, refer to ["1.4 Turning the Scanner ON and OFF"](#) (on page 31).

Feed Rollers

The cleaning procedure is as follows:

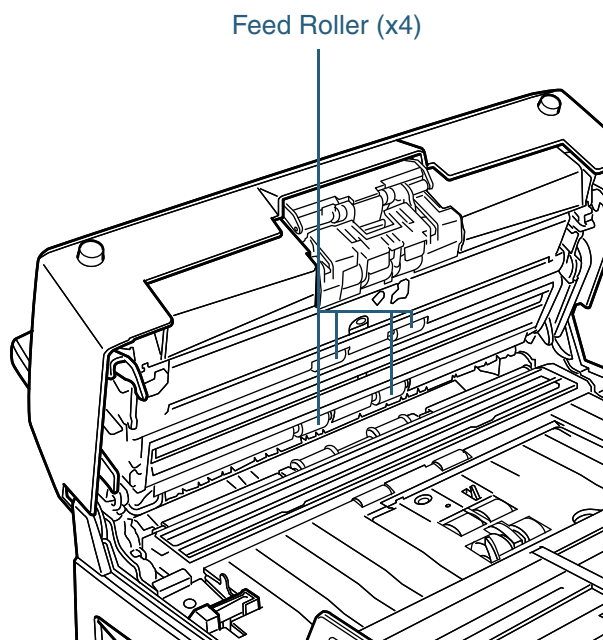

- 1 With the power on, open the ADF when the Operator Panel indicates a code other than "P."
Note that the Feed Rollers will not rotate if you open the ADF and do the following action while "P" is indicated.
- 2 Hold down the [Send to] and [Scan/Stop] buttons simultaneously on the Operator Panel. The Feed Rollers and Eject Rollers start to rotate by a certain angle.



Both the Feed Rollers and Eject Rollers turn at the same time. Do not touch the Feed Rollers or Eject Rollers during cleaning if they are rotating.

- 3 Hold a soft cloth moistened with Cleaner F1 against the surface of the rotating Feed Rollers and Eject Rollers so that the cloth wipes off the surface of the rollers lightly. Take particular care in cleaning these rollers as black debris on them adversely affects the feeding performance.

As a guideline, seven presses of the [Send to] and [Scan/Stop] buttons together makes the Feed Rollers to rotate one full turn.

ADF type

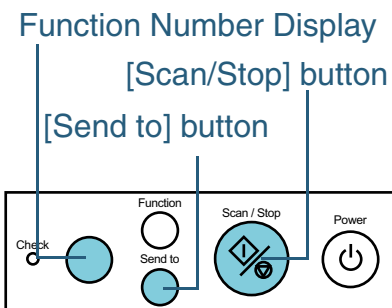

Flatbed type

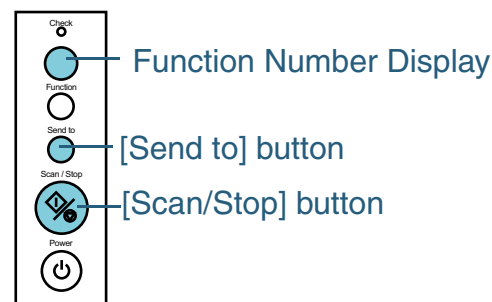

TOP

Contents

Index

Introduction

Scanner
OverviewLoading
DocumentsScan
ParametersVarious
Documents

Daily Care

Consumables

Trouble-
shootingOperational
Settings

Appendix

Glossary

5 Close the ADF.

Press down on the center of the ADF to return it to its original position until the ADF Open Buttons are locked.

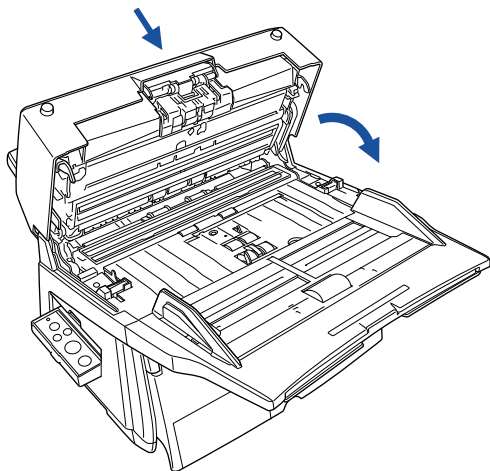

When the ADF has returned to its original position, make sure that it is completely closed. Feeding errors may occur if the ADF is not closed completely.

TOP

Contents

Index

Introduction

Scanner
Overview

Loading
Documents

Scan
Parameters

Various
Documents

Daily Care

Consumables

Trouble-
shooting

Operational
Settings

Appendix

Glossary

5.3 Cleaning the Flatbed (Flatbed Type Only)

- 1 Holding the handle, lift up the Document Cover.

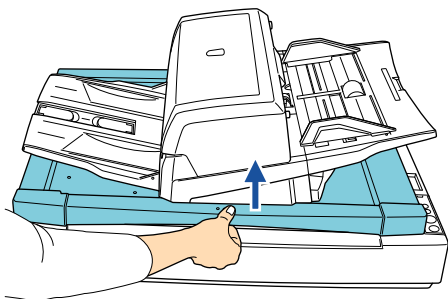

- 2 Lightly wipe off the following locations using a cloth moistened with Cleaner F1.

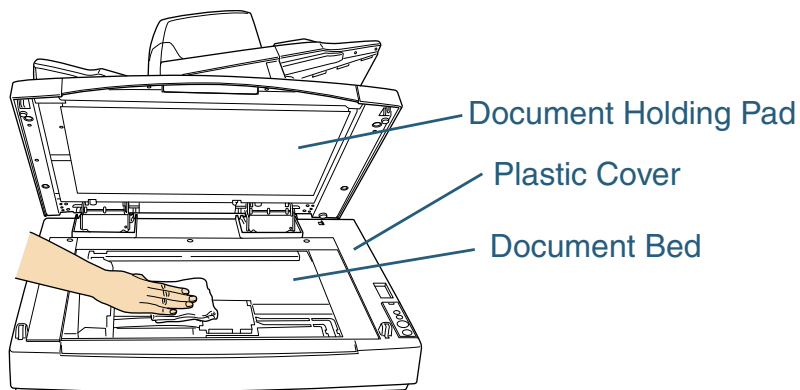

Do not allow moisture to flow into the gap between the Document Bed and the Plastic Cover.

- 3 Wait for the cleaned parts to dry.
- 4 Gently close the Document Cover.

TOP

Contents

Index

Introduction

Scanner
Overview

Loading
Documents

Scan
Parameters

Various
Documents

Daily Care

Consumables

Trouble-
shooting

Operational
Settings

Appendix

Glossary

Chapter 6 Consumables

This chapter describes how to replace the scanner consumables.



- When operating the scanner, the glasses inside the ADF become very hot.
- Before you replace the consumables, turn the scanner off and unplug the power cable from the power outlet. Wait for at least 15 minutes for the ADF glasses to cool down.

6.1 Consumables and the Replacement Cycles.....	107
6.2 Replacing the Pick Rollers.....	108
6.3 Replacing the Brake Roller	110

6.1 Consumables and the Replacement Cycles

The following table shows the consumables and their standard replacement cycles.

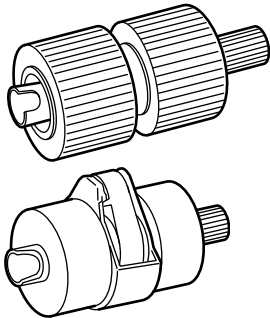
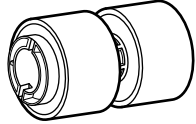
Consumable	Part No.	Standard Replacement Cycle
Pick Roller 	PA03338-K011	After scanning of 250,000 sheets or one year
Brake Roller 	PA03576-K010	After scanning of 250,000 sheets or one year

The consumables must be replaced periodically. Order new consumables before the consumables on the scanner reach the end of their service life. It is recommended that you keep a stock of new consumables. By referring to the numbers of scanned sheets counted at each replacement of the rollers (Brake Roller and Pick Rollers), you can judge when you will need to replace the rollers next time.

If you want to check the counted values for the rollers, refer to ["8.3 Settings Related to Consumables and Useful Life Counters"](#) (on page 148).

The replacement cycles above are rough guidelines for the case of using A4/Letter-sized woodfree or wood containing paper of 80 g/m² (20.0 lb) in weight. This cycle varies according to the type of the paper used and how frequently the scanner is used and cleaned.



Use only the specified consumables to avoid document feeding troubles.

To purchase the consumables, contact the store where you purchased the scanner or an authorized FUJITSU scanner service provider.

Please understand that some parts may need replacement by service engineer depending on the scanned document type or its duty of scanning. For further information, contact the FUJITSU scanner service provider.

TOP

Contents

Index

Introduction

Scanner
OverviewLoading
DocumentsScan
ParametersVarious
Documents

Daily Care

Consumables

Trouble-
shootingOperational
Settings

Appendix

Glossary

6.2 Replacing the Pick Rollers



The scanner has two Pick Rollers. Be sure to replace both of them at the same time.

- 1 Remove documents (if any) from the ADF Paper Chute.
- 2 Pushing the ADF Open Buttons, lift open the ADF.

ADF Open Button

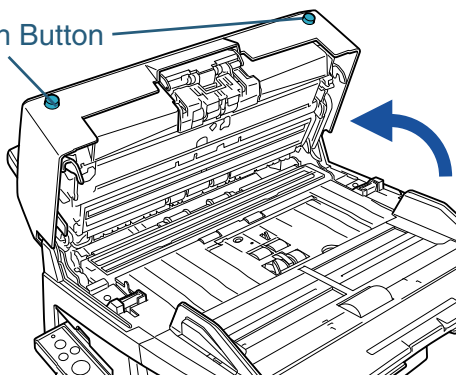

Be careful, the ADF may close and pinch your fingers.

- 3 Remove the ADF Paper Chute.

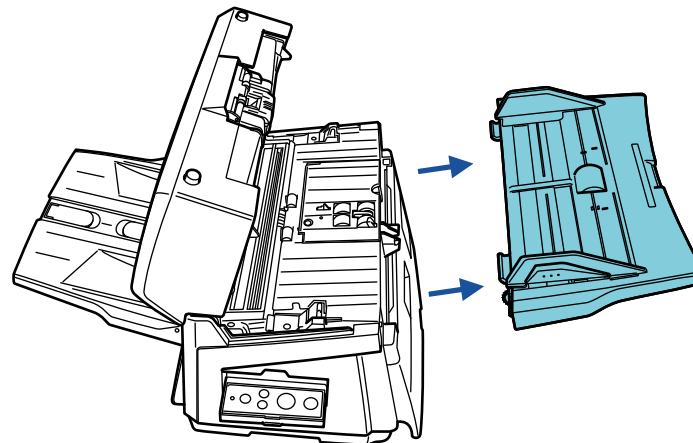

- 4 Remove the Pick Rollers (x2) from the scanner.
 - 1 Open the Pick Roller Cover.

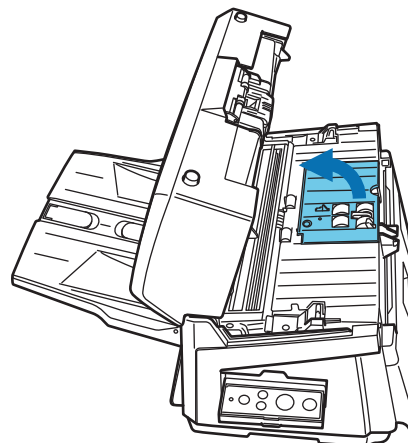
[TOP](#)
[Contents](#)
[Index](#)
[Introduction](#)
[Scanner Overview](#)
[Loading Documents](#)
[Scan Parameters](#)
[Various Documents](#)
[Daily Care](#)
[Consumables](#)
[Troubleshooting](#)
[Operational Settings](#)
[Appendix](#)
[Glossary](#)

- 2 Pull out the two Pick Rollers from the rotating shaft.

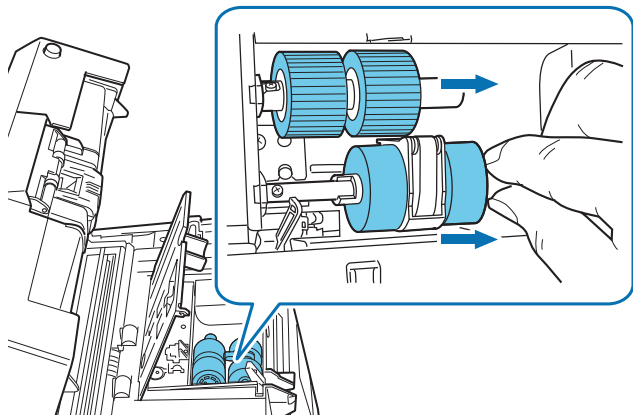

5 Attach new two Pick Rollers to the scanner.

- 1 Attach both of the two Pick Rollers to the rotating shaft.

Insert each roller so its socket will fit to the rotating shaft screw on the scanner.

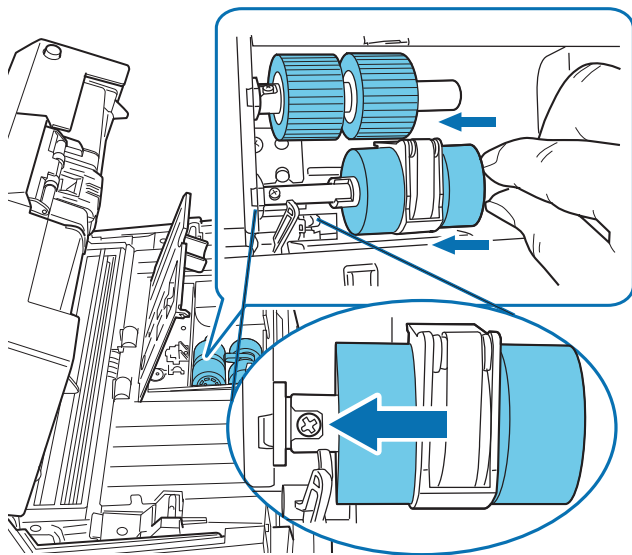

- 2 Close the Pick Roller Cover. Confirm that both sides of the cover are locked firmly.

6 Attach the ADF Paper Chute.

7 Close the ADF.

Press down on the center of the ADF to return it to its original position until the ADF clicks into place.

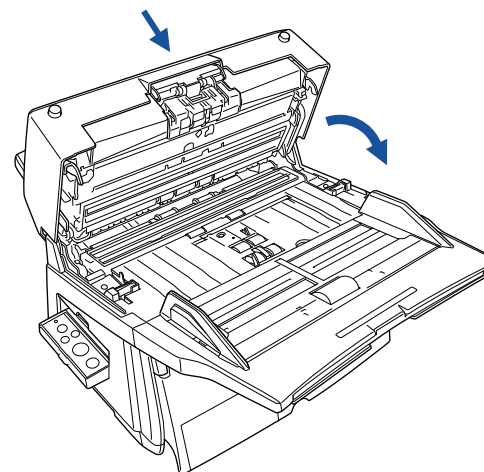

CAUTION Be careful, the ADF may close and pinch your fingers.



- Do not close the ADF while the Pick Roller Cover is kept open.
- Confirm that the Pick Rollers are attached firmly. If not, paper feed errors such as paper jams will occur.

8 Reset the pick roller counter.

Start up the Software Operation Panel, and then reset the counter. For details, refer to "[Resetting the counters](#)" (on page 149).

6.3 Replacing the Brake Roller

- 1 Remove documents (if any) from the ADF Paper Chute.
- 2 Pushing the ADF Open Buttons, lift open the ADF.

ADF Open Button

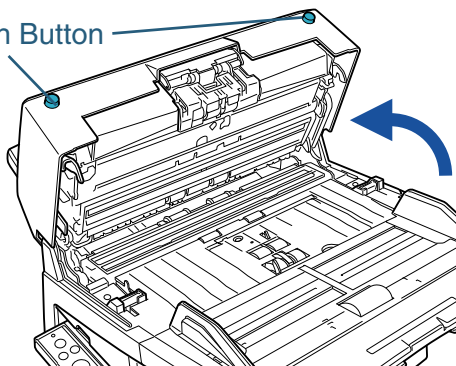

Be careful, the ADF may close and pinch your fingers.

- 3 Remove the Brake Roller from the scanner.
 - 1 Holding the Pick Arm, open the Brake Roller Holder in the arrow-indicated direction.

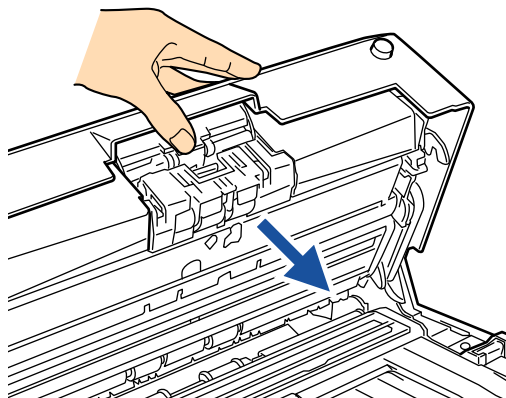

- 2 Remove the Brake Roller.

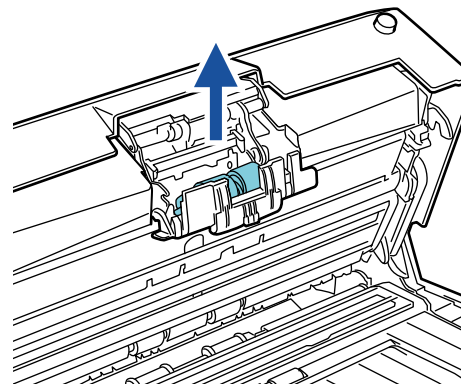

- 4 Remove the Brake Roller from its shaft.

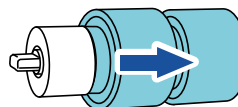

- 5 Attach a new Brake Roller.
 - 1 Align the groove of the shaft with the protruding section of the rotating shaft.

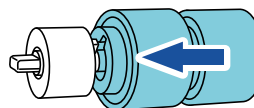

TOP

Contents

Index

Introduction

Scanner
Overview

Loading
Documents

Scan
Parameters

Various
Documents

Daily Care

Consumables

Trouble-
shooting

Operational
Settings

Appendix

Glossary

6 Attach the Brake Roller to the scanner.

- 1 Put the Brake Roller by adjusting the flat section of the rotating shaft to the guide slot of the Brake Roller Holder.
- 2 Close the Brake Roller Holder.

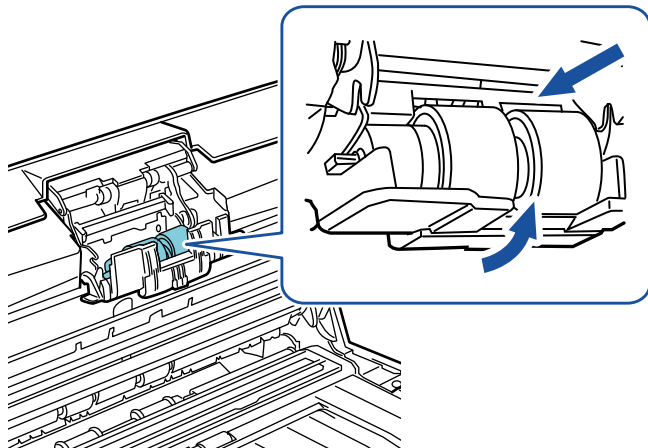

7 Close the ADF.

Press down on the center of the ADF to return it to its original position until the ADF clicks into place.

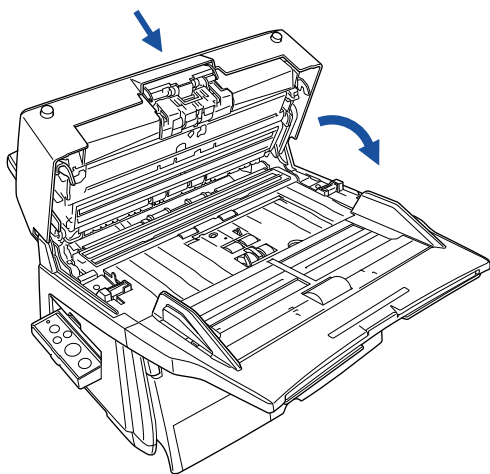

CAUTION

Be careful, the ADF may close and pinch your fingers.



- Do not close the ADF while the Brake Roller Cover is kept open.
- Confirm that the Brake Roller is attached firmly. If not, paper feed errors such as multifeeds will occur.

8 Reset the brake roller counter.

Start up the Software Operation Panel, and then reset the counter. For details, refer to "[Resetting the counters](#)" (on page 149).

Chapter 7 Troubleshooting

This chapter describes the measures against document jams or troubles, shows you what to check before asking your nearest scanner service provider for help, and describes how to read the product labels.



For details about troubles that are not described here, and those about the scanning errors, refer to the TWAIN Scanner Driver Help.

7.1 Paper Jams.....	113
7.2 Errors Indicated on the Operator Panel.....	115
7.3 Troubleshooting	119
7.4 Before Contacting Your Dealer or Scanner Service Provider.....	135
7.5 Checking Labels on the Scanner.....	137

TOP

Contents

Index

Introduction

Scanner
Overview

Loading
Documents

Scan
Parameters

Various
Documents

Daily Care

Consumables

Trouble-
shooting

Operational
Settings

Appendix

Glossary

7.1 Paper Jams

If your document jams, follow the procedure below to remove it.



- Take care not to get injured when removing the jammed document.
- Be careful not to get your necktie, necklace, etc. caught in the scanner when removing the jammed document.
- The glass surfaces and guides may become hot during operation. Take care not to get burned.

1 Remove the document sheet(s) remaining on the ADF Paper Chute.

2 Pushing the ADF Open Buttons, lift open the ADF.

ADF Open Button

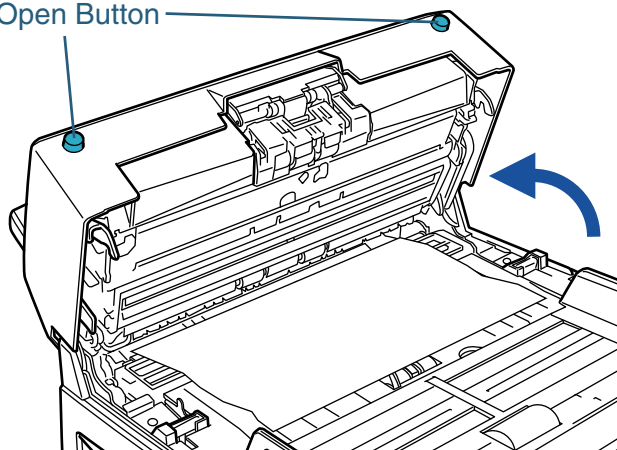

Be careful, the ADF may close and pinch your fingers.

3 Remove the jammed document.

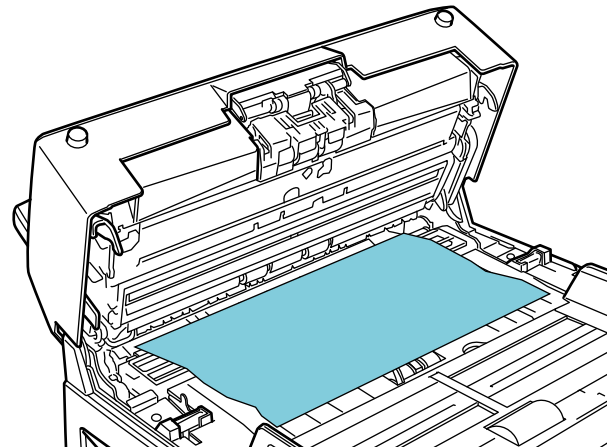

- Staples, paper clips, etc. could cause document jams. Be sure to check for small metal objects on your document or on the paper feed path, and remove them. Also, before you start scanning, be sure to remove them from the document.
- In case you have scanned any stapled or clipped documents, do not pull them out forcibly. Otherwise, the glasses and/or guides may be damaged.

TOP

Contents

Index

Introduction

Scanner
Overview

Loading
Documents

Scan
Parameters

Various
Documents

Daily Care

Consumables

Trouble-
shooting

Operational
Settings

Appendix

Glossary

4 Close the ADF.

Press down on the center of the ADF to return it to its original position until the ADF clicks into place.

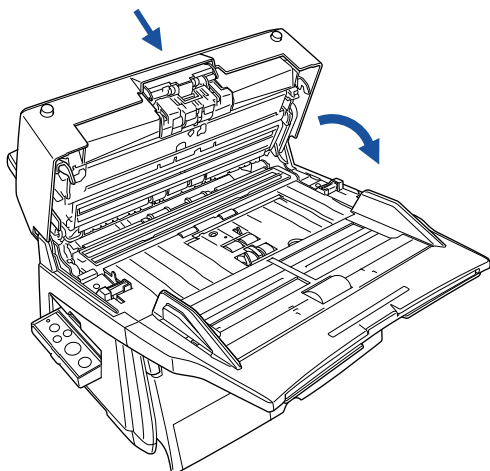

- Make sure that the ADF is completely closed. Feeding errors may occur if the ADF is not closed completely.
- When scanning is canceled halfway through, some sheets of the document might remain inside the ADF even though no error message is displayed. Follow the procedure (Steps 1 to 4) above to remove the sheets remaining in the ADF.

TOP

Contents

Index

Introduction

Scanner
Overview

Loading
Documents

Scan
Parameters

Various
Documents

Daily Care

Consumables

Trouble-
shooting

Operational
Settings

Appendix

Glossary

7.2 Errors Indicated on the Operator Panel

When an error occurs, the Check LED lights in orange. For temporary errors, the Function Number Display on the Operator Panel indicates [J] or [U] and a number alternately; [E], [F], [C], [H], [A], or [L] and a number alternately for device errors (permanent errors). Temporary errors can be solved by the operator, but the device errors (permanent errors) require recovery works by support engineers. If you want to clear the error indication, press the [Scan/Stop] or [Send to] button. The scanner will return to the "Ready Status."

ADF type

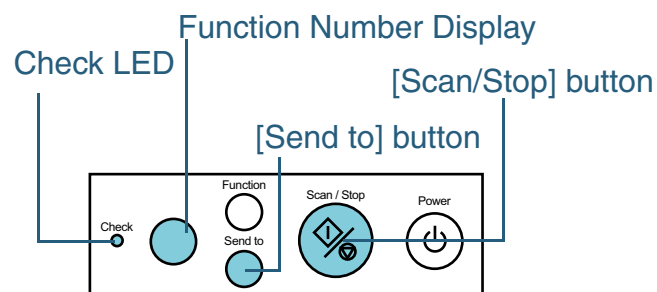

Flatbed type

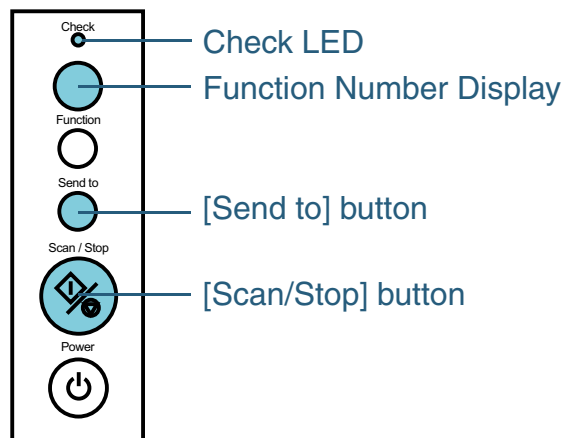

Once the Error Recovery Guide has been installed on your computer, its window appears as soon as your Windows is started up. When a temporary or device (permanent) error occurs, this software displays information such as the error name or error code regarding that error. Write down the information displayed on the message box, and then click the [More Info] button to learn detailed information for troubleshooting.

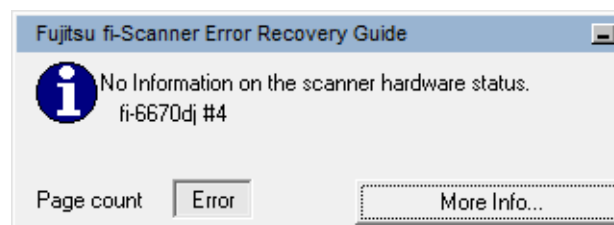

The Error Recovery Guide is stored in the Setup DVD-ROM. For how to install this guide, refer to "Chapter 4 Installing the Scanner Software" in the Getting Started.

Temporary Errors

Temporary errors can be solved by ordinary operators. They are listed as follows:

■ Paper Feed Errors

[J] and a number are displayed alternately.

Indication	Item	Remedy
J1	Paper jam	<ol style="list-style-type: none"> 1 Remove the halted or jammed document remaining inside. For how to remove such documents, refer to "7.1 Paper Jams" (on page 113). 2 Confirm that the documents meet the paper conditions for scanning from the ADF. For details, refer to "2.2 ADF-Loaded Documents" (on page 42).
J9		
J2	Multifeed error	Pressing the [Send to] button on the Operator Panel ejects multifeed documents.

■ Cover Open and Print Errors

[U] and a number are displayed alternately.

Indication	Item	Remedy
U0	Transport lock error (Flatbed type only)	Unlock the Transport Lock. For how to unlock the Transport Lock, refer to "Chapter 3 Connecting the Cables" in the Getting Started.
U4	The ADF opened during scanning.	Close the ADF and load the document again.
U5	The print section of the imprinter opened during scanning. (only when the imprinter option for fi-6670/fi-6670A is installed)	
U6	The print cartridge of the imprinter option is not set.	This is a temporary error related to the imprinter option (sold separately). For details refer to the "Imprinter Operator's Guide."
U7	The imprinter failed to sense documents. Or, the print area is incorrect.	

Device Errors

Device errors require recovery works by support engineers. They are listed as follows:

■ Motor and Optical System Errors

[E] and a number are displayed alternately.

Indication	Item	Remedy
E0	Flatbed motor malfunction (Flatbed type only)	1 Confirm that the Transfer Lock is unlocked. 2 Turn the scanner off and on again.
E1	Flatbed optical system malfunction (Flatbed type only)	If the error is still displayed on the Function Number Display, record the indicated error code, and contact the store where you purchased the scanner or an authorized FUJITSU scanner service provider.

Indication	Item	Remedy
E2	Optical system error (Front-side scanning thru the ADF)	Turn off and on the scanner again. If the error is still displayed on the Function Number Display, record the indicated error code, and contact the store where you purchased the scanner or an authorized FUJITSU scanner service provider.
E3	Optical system error (Back-side scanning thru the ADF). (fi-6670/fi-6670A/fi-6770/fi-6770A)	
E6	Operator panel error	
E7	Internal memory error (EEPROM)	
E8	SCSI interface circuit error (fi-6670/fi-6670A/fi-6770/fi-6770A)	
E9	Image memory error	

■ Overrun Errors

[F] and a number are displayed alternately.

Indication	Item	Remedy
F2	Pick arm error	Turn off and on the scanner again. If the alarm is still displayed on the Function Number Display, record the indicated error code, and contact the store where you purchased the scanner or an authorized FUJITSU scanner service provider.
F4	Background switching mechanism error	
F6	Fan error	
F7	Heater error	
F8		
F9		

TOP

Contents

Index

Introduction

Scanner Overview

Loading Documents

Scan Parameters

Various Documents

Daily Care

Consumables

Troubleshooting

Operational Settings

Appendix

Glossary

■ Chip Errors

[C] and a number are displayed alternately.

Indication	Item	Remedy
C0	LSI error	Turn off and on the scanner again. If the error is still displayed on the Function Number Display, record the indicated error code, and contact the store where you purchased the scanner or an authorized FUJITSU scanner service provider.
C8	Intra-scanner communication error	

■ Circuit Errors

[H] and a number are displayed alternately.

Indication	Item	Remedy
H1	Motor circuit error	Turn off and on the scanner again. If the error is still displayed on the Function Number Display, record the indicated error code, and contact the store where you purchased the scanner or an authorized FUJITSU scanner service provider.
H5	CGA board error (fi-6670A/fi-6770A)	
H6	Imprinter motor circuit error (only when the imprinter option for fi-6670/fi-6670A is installed)	
H7	Lamp circuit error	

■ Errors in the Option (only when the imprinter option for fi-6670/fi-6670A is installed)

[A] and a number are displayed alternately.

Indication	Item	Remedy
A0	Error in imprinter's control board	Turn off and on the scanner again. If the error is still displayed on the Function Number Display, record the indicated error code, and contact the store where you purchased the scanner or an authorized FUJITSU scanner service provider.
A1	Communication timeout error in the imprinter	
A2	Error in imprinter's ink head	
A3	Error in imprinter's internal memory (EEPROM)	
A4	Imprinter ROM error	

■ Sensor Errors

[L] and a number are displayed alternately.

Indication	Item	Remedy
L6	Ultrasonic sensor error	Turn off and on the scanner again. If the error is still displayed on the Function Number Display, record the indicated error code, and contact the store where you purchased the scanner or an authorized FUJITSU scanner service provider.
L9	OMR sensor error	

TOP

Contents

Index

Introduction

Scanner Overview

Loading Documents

Scan Parameters

Various Documents

Daily Care

Consumables

Troubleshooting

Operational Settings

Appendix

Glossary

7.3 Troubleshooting

This section describes troubles that may occur during scanning and how to remedy them. Before you ask for repair, check the following list for possible causes. If the remedies in these flowcharts do not solve the problem, check each item in "7.4 Before Contacting Your Dealer or Scanner Service Provider" (on page 135), and then contact the dealer where you purchased the scanner or an authorized FUJITSU scanner service provider.

The possible troubles are listed as follows:

Possible Trouble
Scanner cannot be turned on. (See page 120.)
Indication on Function Number Display goes out. (See page 121.)
Scanning does not start. (See page 122.)
Quality of scanned pictures or photos is not satisfactory when scanning in black and white. (See page 123.)
Quality of scanned text or lines is unsatisfactory. (See page 124.)
Images are distorted or blurred. (See page 125.)
Vertical lines appear in scanned images. (See page 126.)
Function Number Display indicates an error code (alphabetical letter plus number) alternately after the scanner is turned ON. (See page 127.)
Multifeed errors occur frequently. (See page 128.)
Pickup errors occur frequently. (See page 130.)
Paper jams occur frequently. (See page 131.)
Scanned images are elongated when scanned from the ADF. (See page 132.)
There is a shadow on leading edge of scanned image. (See page 133.)
The scanner is not recognized by your computer when Kofax VRS is used. (See page 134.)

TOP

Contents

Index

Introduction

Scanner
OverviewLoading
DocumentsScan
ParametersVarious
Documents

Daily Care

Consumables

Trouble-
shootingOperational
Settings

Appendix

Glossary

Scanner cannot be turned on.

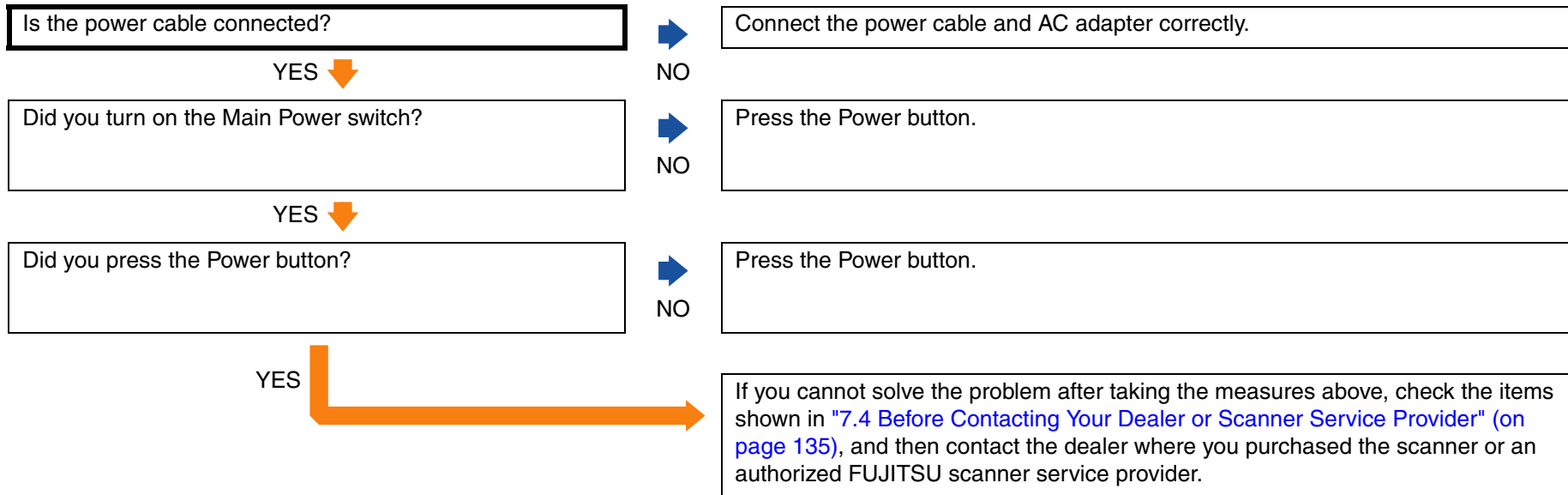

Indication on Function Number Display goes out.

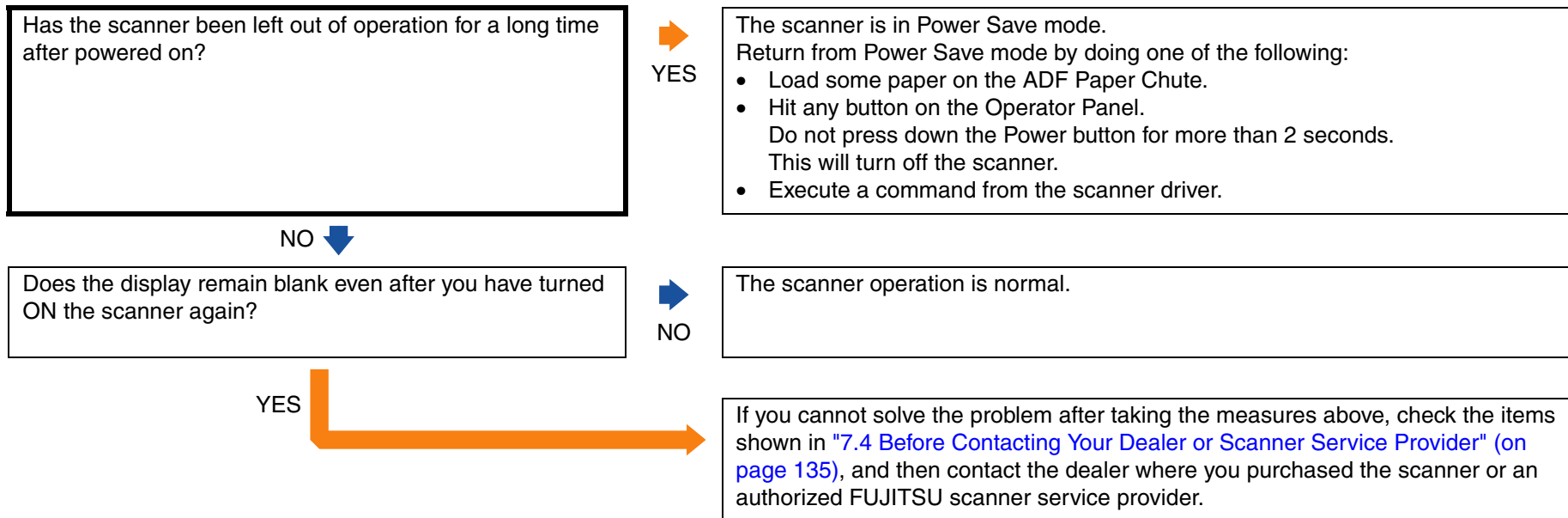

Scanning does not start.

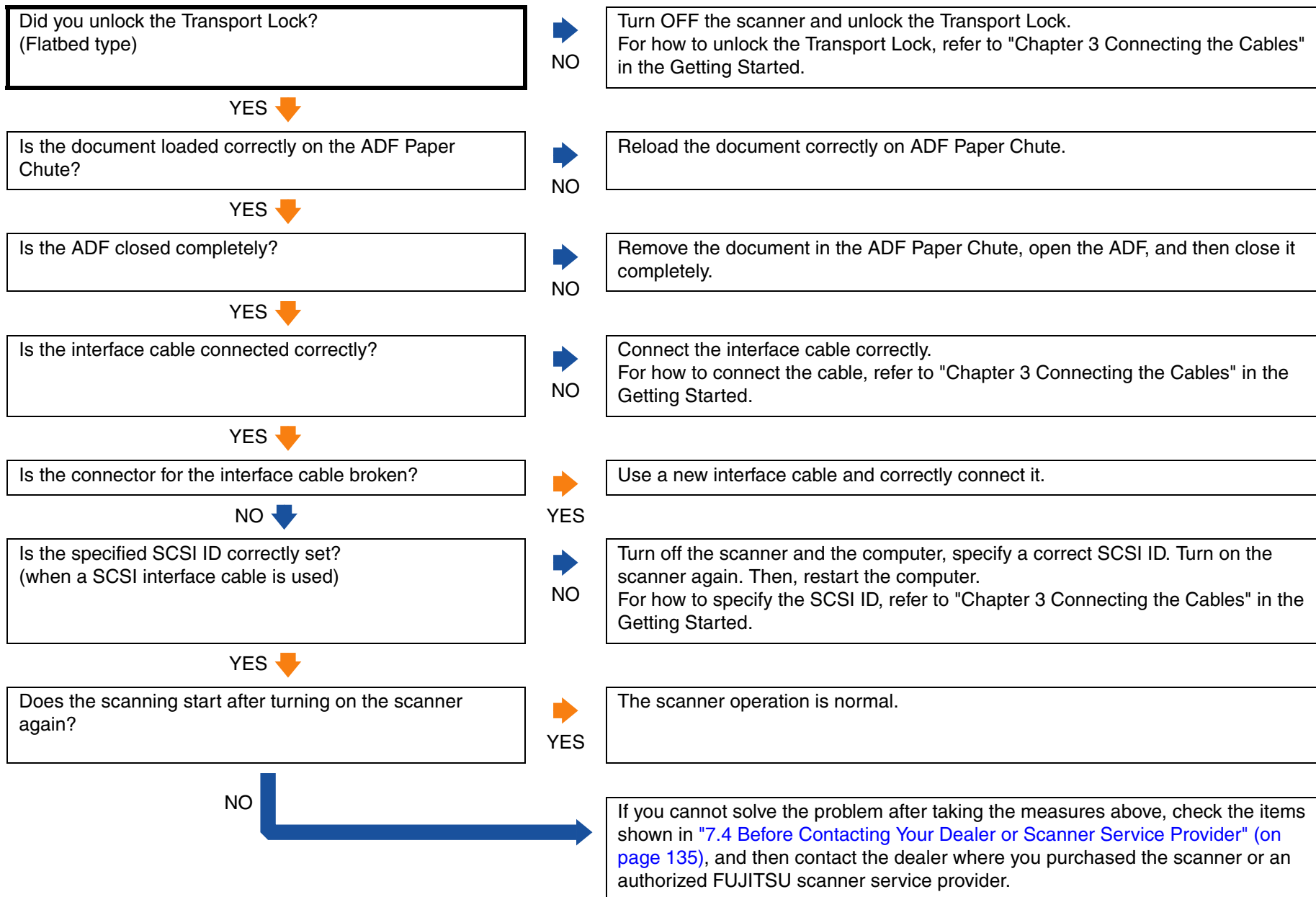

Quality of scanned pictures or photos is not satisfactory when scanning in black and white.

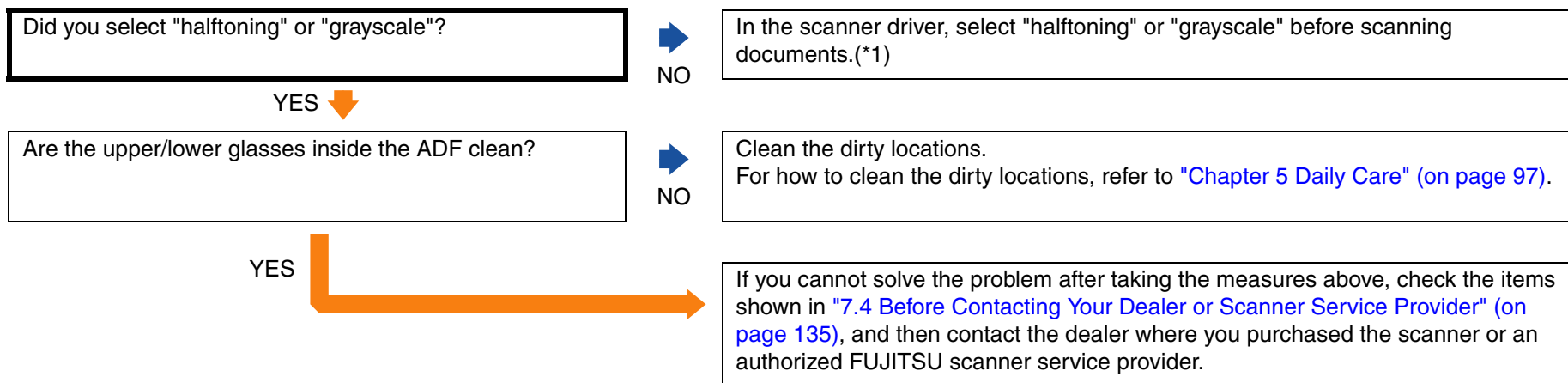

*1: When scanning pictures or photos simply in binary black-and-white mode, the generated image might significantly differ from the originals. If possible, set the image type on the scanner driver to "halftoning" or "grayscale" before scanning.

Quality of scanned text or lines is unsatisfactory.

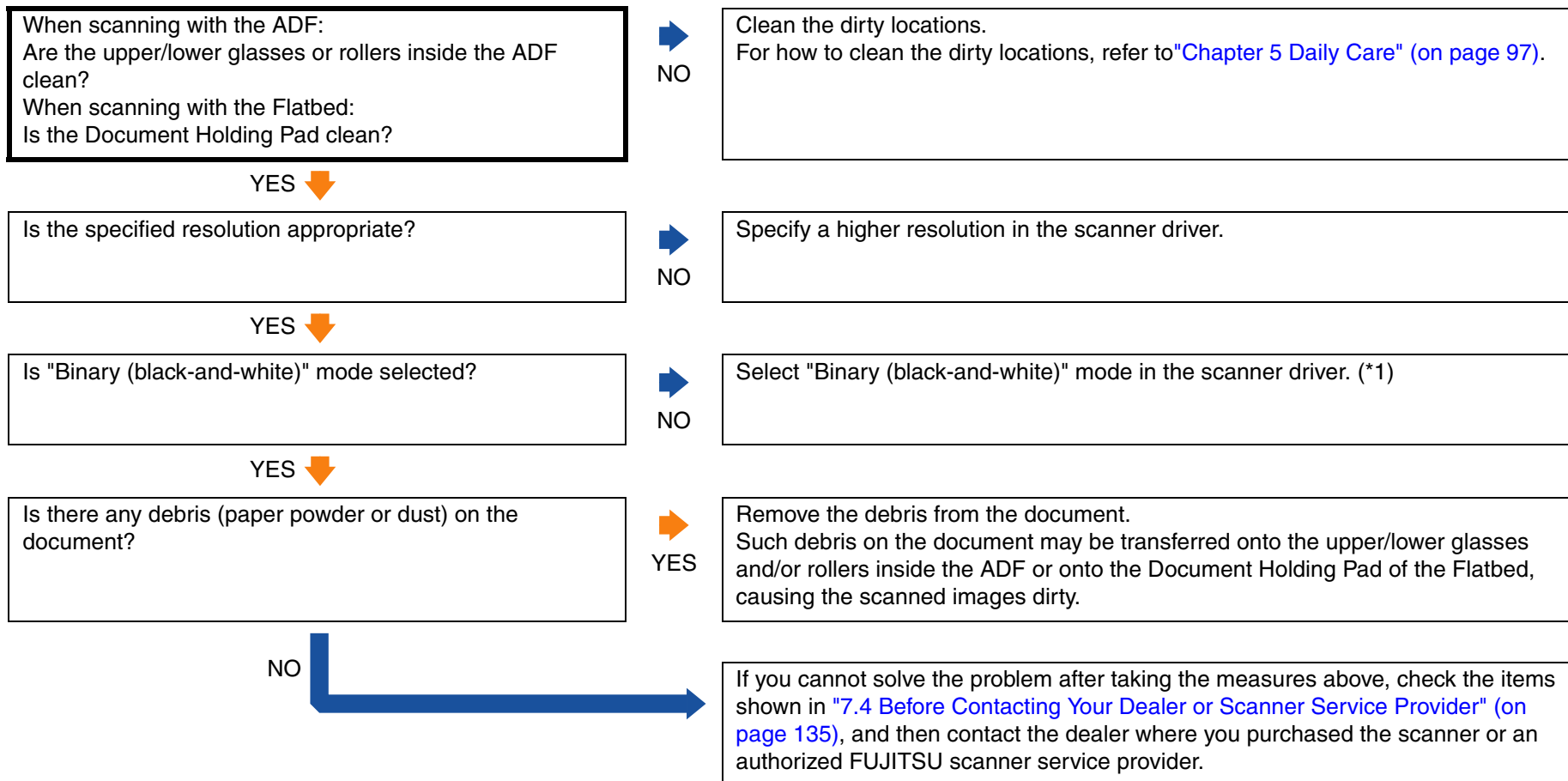

*1: When scanning with "halftone," "grayscale," or "color" specified, the scanned image might not become sharp and clear. If possible, set the image type to "Binary (black and white)" in the scanner driver.

Images are distorted or blurred.

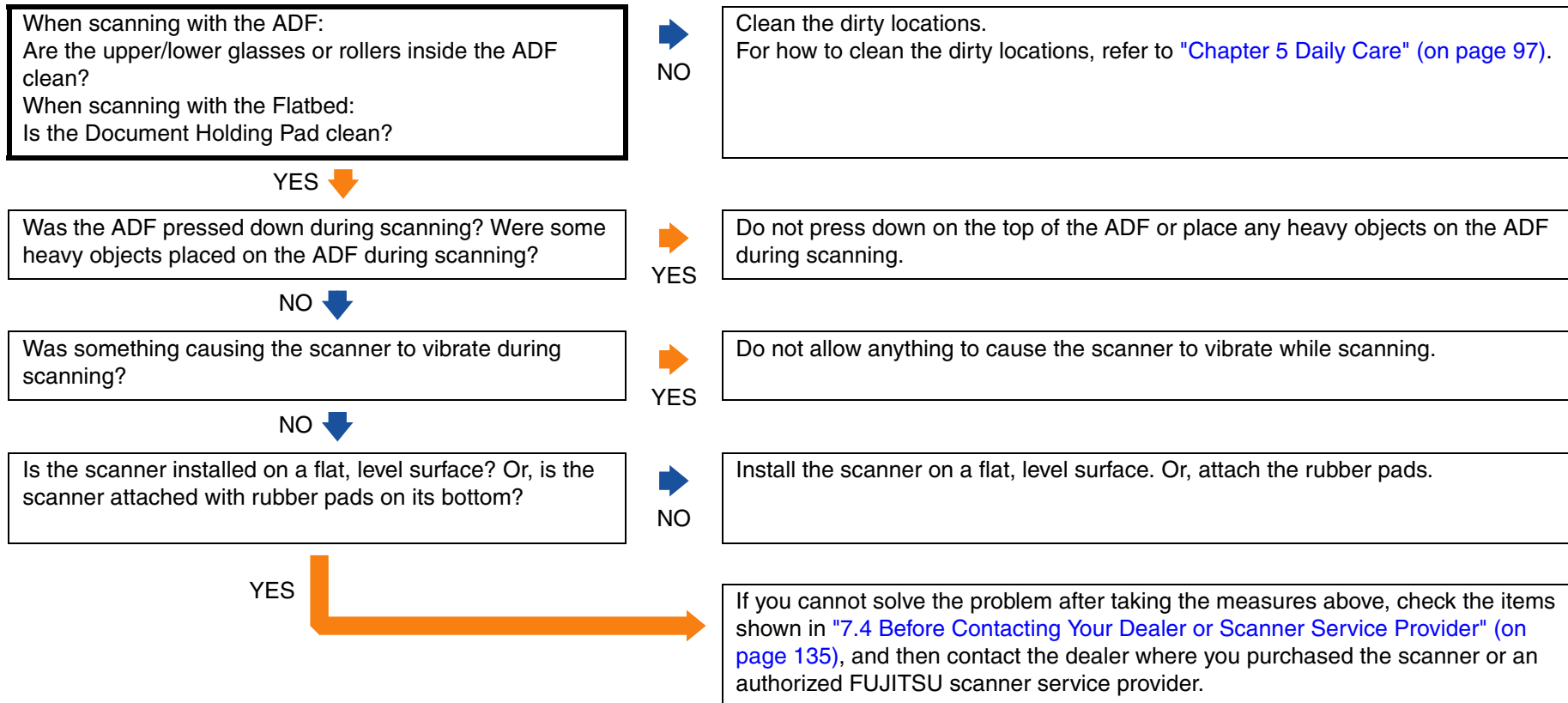

Vertical lines appear in scanned images.

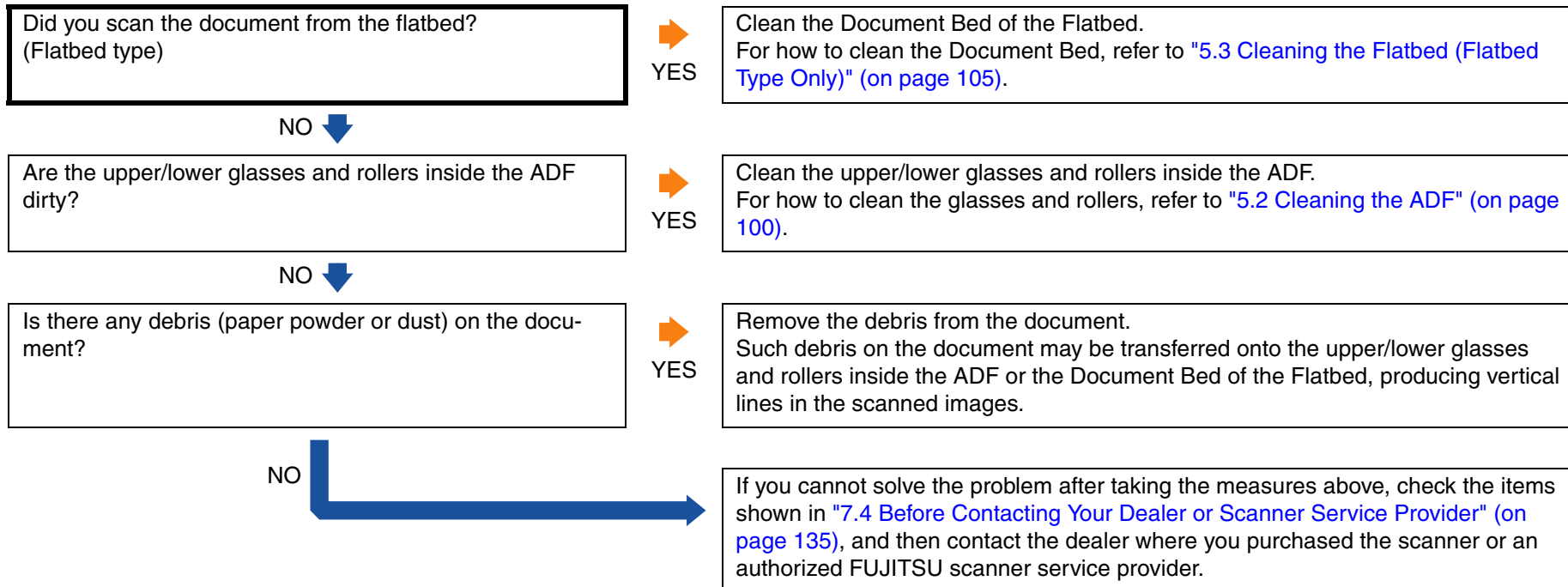

Function Number Display indicates an error code (alphabetical letter plus number) alternately after the scanner is turned ON.

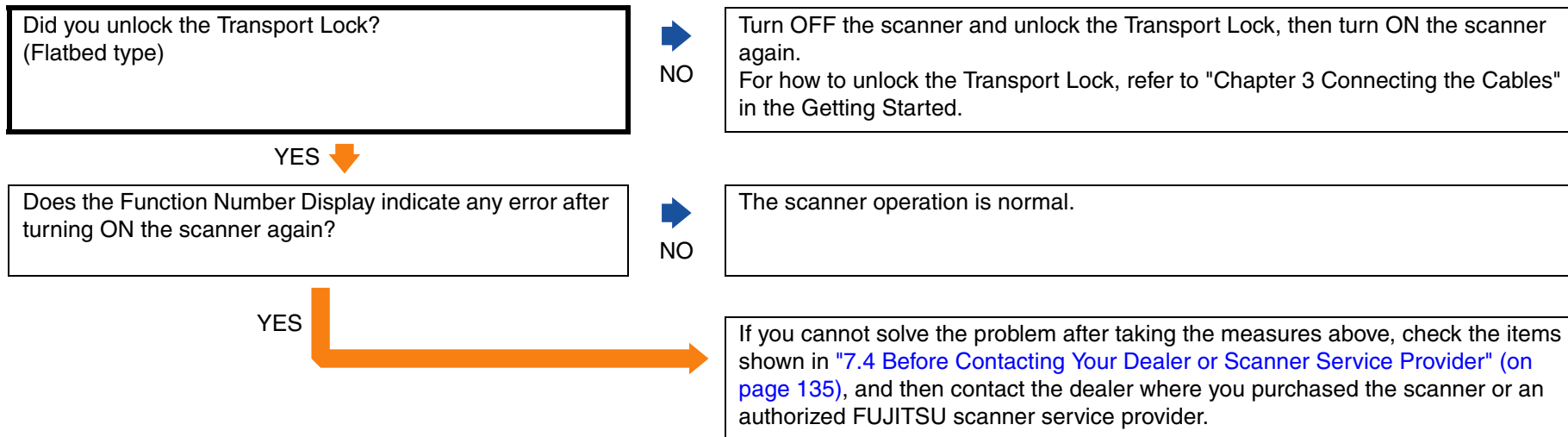

- TOP
- Contents
- Index
- Introduction
- Scanner Overview
- Loading Documents
- Scan Parameters
- Various Documents
- Daily Care
- Consumables
- Troubleshooting**
- Operational Settings
- Appendix
- Glossary

Multifeed errors occur frequently.

Does the document satisfy the requirements described in Precautions in "Paper Quality" (page 42)?	<p>➔ NO</p>	Use the document that satisfies the requirements. For the document requirements, refer to "2.2 ADF-Loaded Documents" (on page 42).
<p>YES ↓</p> With the Multifeed Detection set to ON, do the settings configured satisfy the requirements to detect multifeeds correctly?	<p>➔ NO</p>	Configure the settings for detecting multifeeds correctly. For the multifeed detection conditions, refer to "Multifeed Detection Conditions" (page 45). Specify the multifeed detection range, if needed, by referring to "Detecting Multifeeds" (page 92).
<p>YES ↓</p> Did you scan very thick media such as a plastic card?	<p>➔ YES</p>	When scanning media like this, disable Multifeed Detection.
<p>NO ↓</p> Did you fan the document before loading it on the scanner?	<p>➔ NO</p>	Fan the document before loading.
<p>YES ↓</p> Has the document just been printed out on a copier or laser printer?	<p>➔ YES</p>	Fan the document three or four times to remove static electricity from the paper.
<p>NO ↓</p> Is the document stack less than 20 mm (0.79 in.) thick (10 mm (0.39 in.) when the document size is larger than A4/Letter)?	<p>➔ NO</p>	Reduce the number of sheets of the document stack.
<p>YES ↓</p> Are all the consumables (*1) installed correctly?	<p>➔ NO</p>	Correctly install the consumables (*1). For how to install the consumables, refer to "Chapter 6 Consumables" (on page 106).
<p>YES ↓</p> Is any of the consumables (*1) dirty?	<p>➔ YES</p>	Clean the dirty consumables (*1). For how to clean the consumables, refer to "5.2 Cleaning the ADF" (on page 100).
<p>NO ↓</p>		

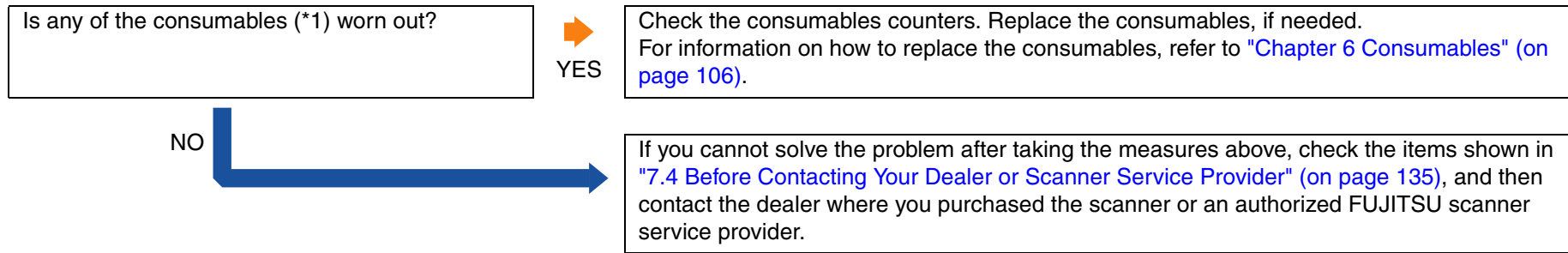

*1 : Pick Rollers and Brake Rollers

- TOP
- Contents
- Index
- Introduction
- Scanner Overview
- Loading Documents
- Scan Parameters
- Various Documents
- Daily Care
- Consumables
- Troubleshooting**
- Operational Settings
- Appendix
- Glossary

Pickup errors occur frequently.

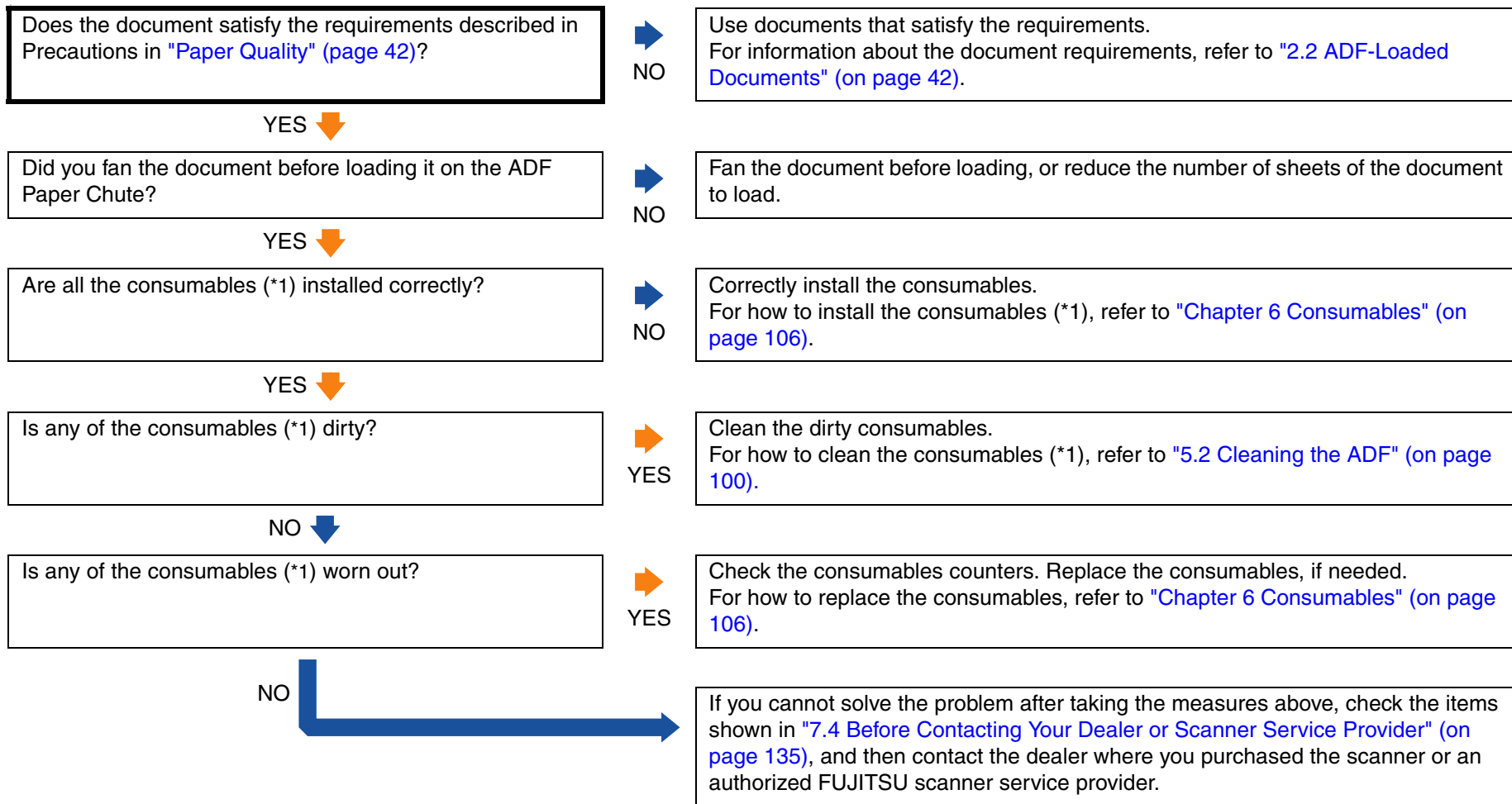

*1 : Pick Rollers and Brake Rollers

- TOP
- Contents
- Index
- Introduction
- Scanner Overview
- Loading Documents
- Scan Parameters
- Various Documents
- Daily Care
- Consumables
- Troubleshooting**
- Operational Settings
- Appendix
- Glossary

Paper jams occur frequently.

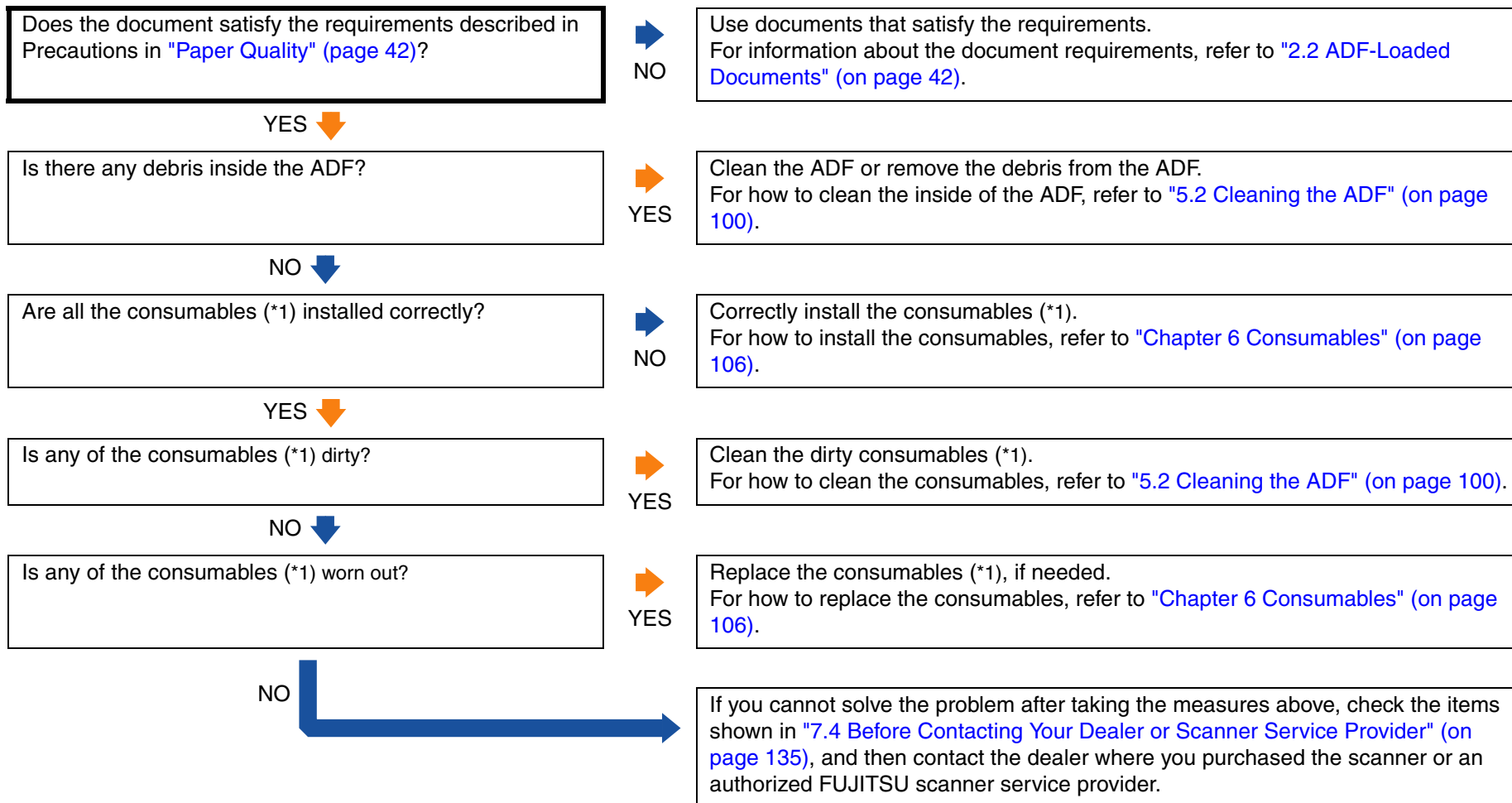

*1 : Pick Rollers and Brake Rollers

TOP

Contents

Index

Introduction

Scanner
OverviewLoading
DocumentsScan
ParametersVarious
Documents

Daily Care

Consumables

Trouble-
shootingOperational
Settings

Appendix

Glossary

Scanned images are elongated when scanned from the ADF.

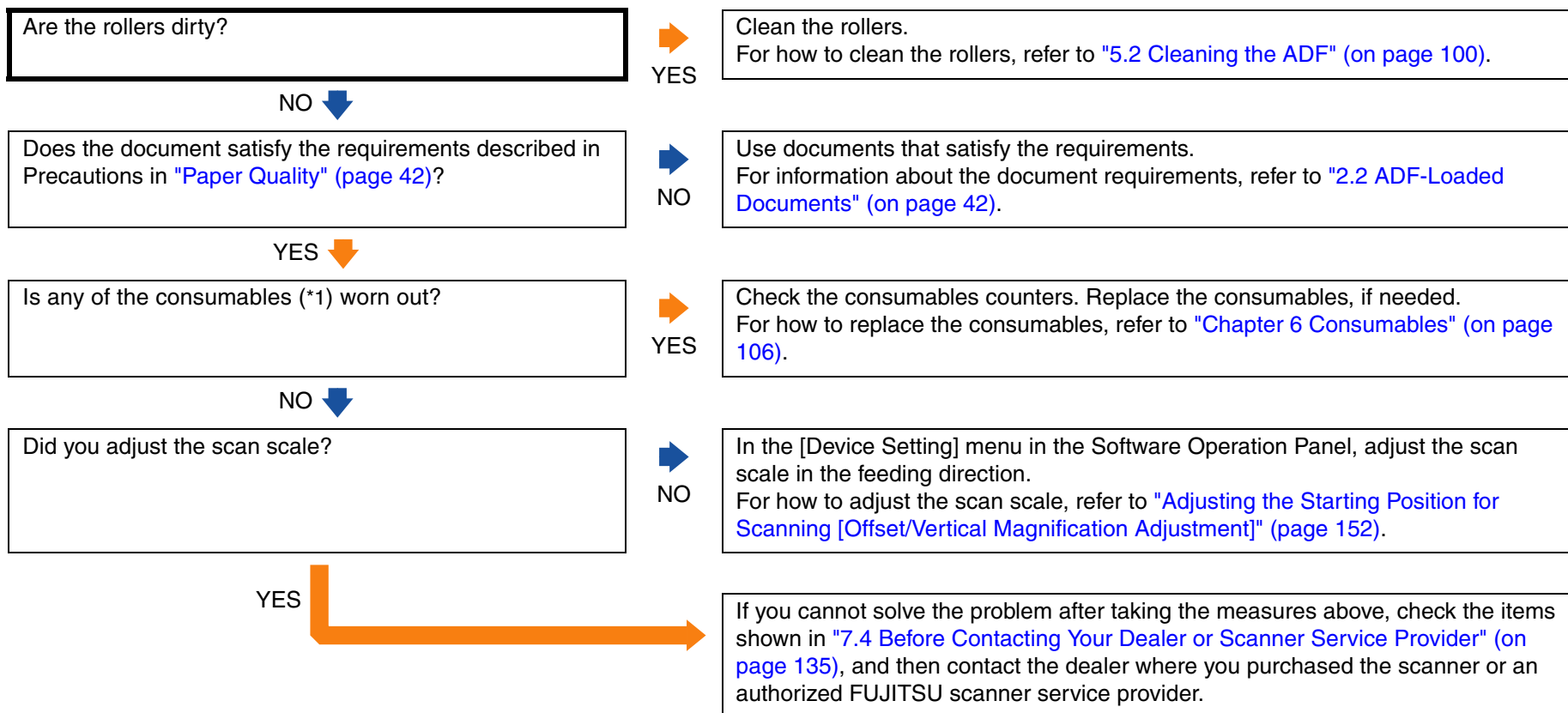

*1 : Pick Rollers and Brake Rollers

There is a shadow on leading edge of scanned image.

Did you adjust the offset (starting position for scanning the document)?

NO

In the [Device Setting] menu in the Software Operation Panel, adjust the scan scale in the vertical scanning direction.
For how to adjust the scan scale, refer to ["Adjusting the Starting Position for Scanning \[Offset/Vertical Magnification Adjustment\]"](#) (page 152).

YES

If you cannot solve the problem after taking the measures above, check the items shown in ["7.4 Before Contacting Your Dealer or Scanner Service Provider"](#) (on page 135), and then contact the dealer where you purchased the scanner or an authorized FUJITSU scanner service provider.

The scanner is not recognized by your computer when Kofax VRS is used.

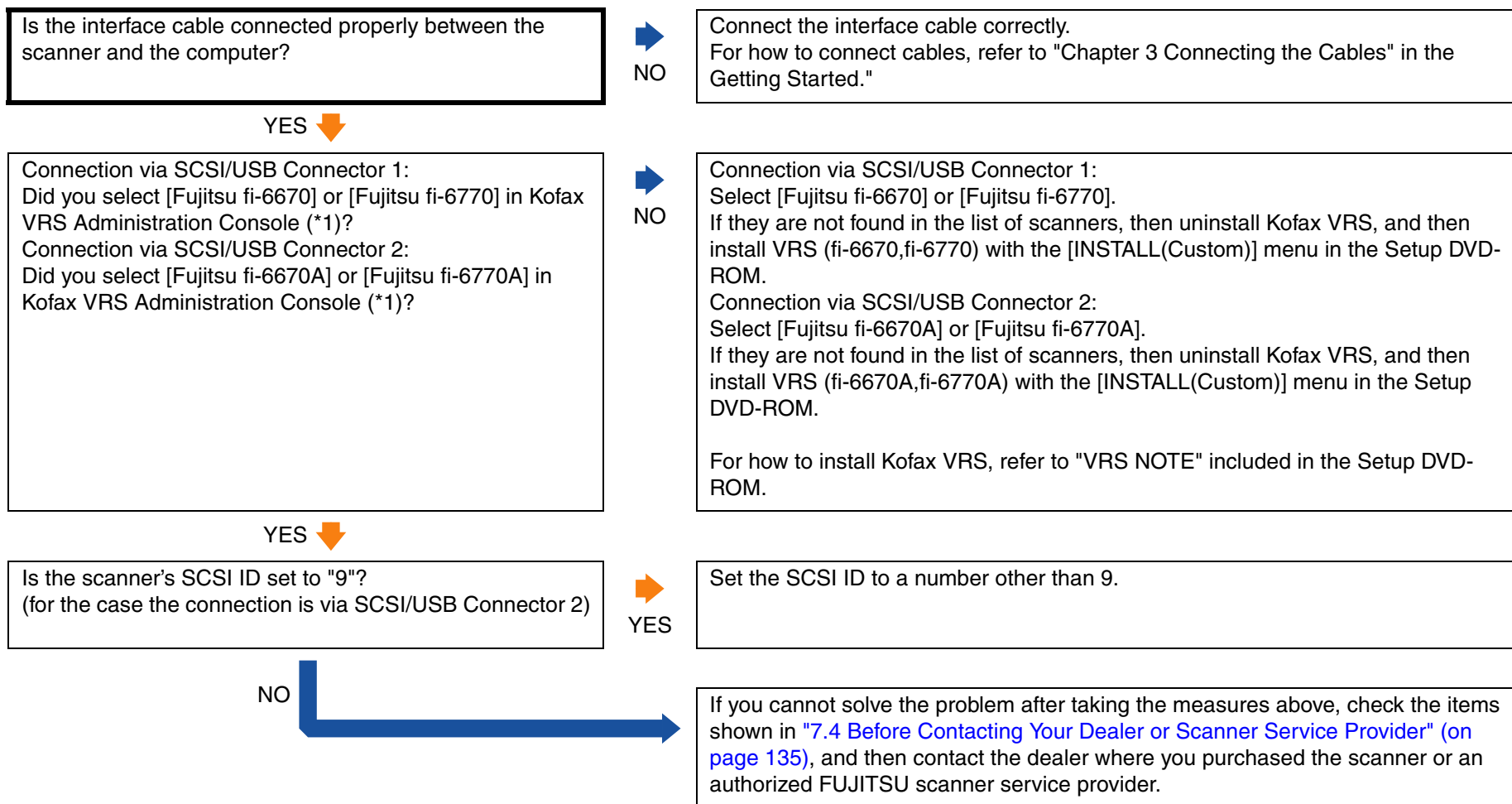

*1 : To start up the Kofax VRS Administration Console, select [Start] menu
⇒ [All Programs] ⇒ [Kofax VRS] ⇒ [Kofax VRS Administration Console].

7.4 Before Contacting Your Dealer or Scanner Service Provider

Check the following items before contacting the dealer where you bought the scanner or an authorized FUJITSU scanner service provider.

General Details

Item	Findings
Scanner model name	Example: fi-6670 For the scanner model names, refer to "7.5 Checking Labels on the Scanner" (on page 137).
Serial No.	Example: 000001 For the serial numbers, refer to "7.5 Checking Labels on the Scanner" (on page 137).
Production date	Example: 2008-05 (May 2008) For the production date, refer to "7.5 Checking Labels on the Scanner" (on page 137).
Date of purchase	
Symptom	
Frequency of trouble	
Do you have warranty for this product?	
Name of option used	Example: fi-667PR For the options, refer to "A.4 Scanner Options" (on page 180).

Troubles

■ Troubles at personal computer connection

Item	Findings
OS version (Windows)	
Displayed error message	
Type of interface	Example: SCSI interface
Type of interface controller	Example: Adaptec's SCSI Card AHA-2940AU

■ Feeding system troubles

Item	Findings
Document type	
Main purpose of use	
Last cleaning date	
Last consumables replacement date	
Operator panel status	

TOP

Contents

Index

Introduction

Scanner
OverviewLoading
DocumentsScan
ParametersVarious
Documents

Daily Care

Consumables

Trouble-
shootingOperational
Settings

Appendix

Glossary

■ Imaging system troubles

Item	Findings
Scanner driver and its version	
Interface controller	Example: Adaptec's SCSI Card AHA-2940AU
OS version (Windows)	
Application software	Example: ScandAll PRO, Adobe Acrobat
Scan type	Example: Front Side, Back Side, Duplex
Resolution	Example: 600 dpi, 75 dpi
Image mode	Example: Color, Grayscale, Binary (black&white)

■ Other

Item	Findings
Can both the photograph showing the original document conditions and the scanned image be sent by e-mail or fax?	

TOP

Contents

Index

Introduction

Scanner
OverviewLoading
DocumentsScan
ParametersVarious
Documents

Daily Care

Consumables

Trouble-
shootingOperational
Settings

Appendix

Glossary

7.5 Checking Labels on the Scanner

This section describes how to check the labels on the scanner.

Positions of Labels on the Scanner

The following shows where the two labels are located on the scanner.

ADF Type:

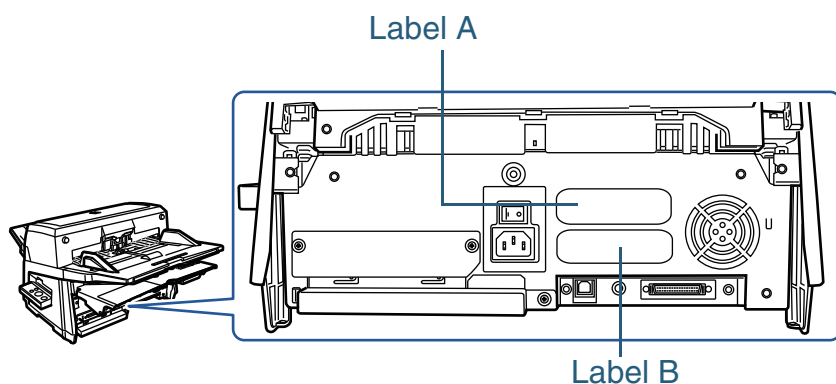

Flatbed Type:

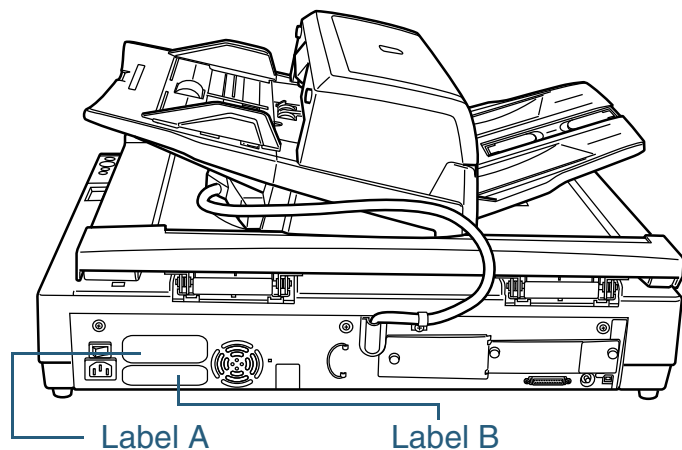

Label A (example): Indicates scanner information.

MODEL	fi-****	** V	** A	** kg							
PART NO.	*****-****	0	1	2	3	4	5	6	7	8	9
SER. NO.	*****	0	1	2	3	4	5	6	7	8	9
DATE	200*-**	Barcode printing area									
PFU Limited a Fujitsu company		MADE IN *****									

Label B (example): Indicates various standards that the scanner conforms with.



TOP

Contents

Index

Introduction

Scanner
OverviewLoading
DocumentsScan
ParametersVarious
Documents

Daily Care

Consumables

Trouble-
shootingOperational
Settings

Appendix

Glossary

Chapter 8 Operational Settings

This chapter explains how settings are made for the scanner using the Software Operation Panel.

Here, Windows Vista screen samples are used to explain the operations. The screens and operations may differ slightly if the OS that you are using is other than Windows vista.

8.1 Starting Up the Software Operation Panel	139
8.2 Configurable Items	140
8.3 Settings Related to Consumables and Useful Life Counters...	148
8.4 Settings Related to Scanning	152
8.5 Settings Related to Multifeed Detection	163
8.6 Settings Related to Wait Time	169
8.7 Settings Related to Power ON/OFF Control	171
8.8 Overscan Control.....	172
8.9 Paper feeding retry times.....	173

TOP

Contents

Index

Introduction

Scanner
Overview

Loading
Documents

Scan
Parameters

Various
Documents

Daily Care

Consumables

Trouble-
shooting

Operational
Settings

Appendix

Glossary

8.1 Starting Up the Software Operation Panel

The Software Operation Panel (SOP) is installed together with the scanner drivers (TWAIN and ISIS).

With this application, you can configure various settings for operating the scanner and for managing its consumables.

- 1 Confirm if the scanner is connected correctly to your computer, then power on the scanner.
For how to turn on the scanner, refer to "1.4 Turning the Scanner ON and OFF" (on page 31).

- 2 Select the [start] menu ⇒ [All Programs] ⇒ [Scanner Utility for Microsoft Windows] ⇒ [Software Operation Panel].

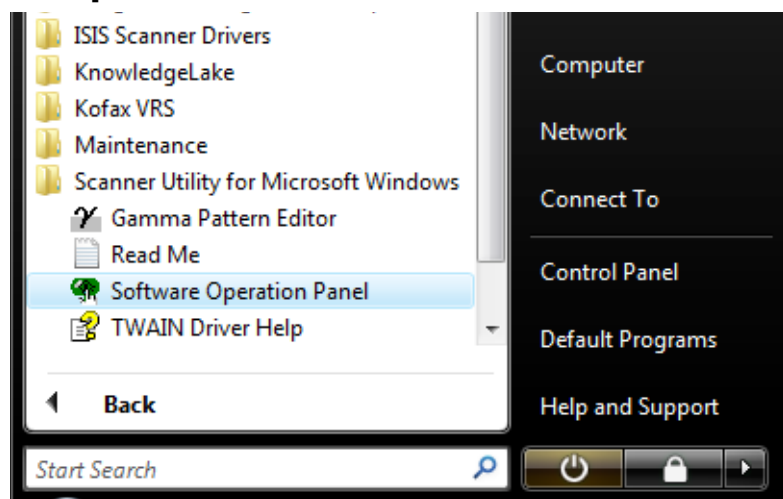

⇒ The [FUJITSU Software Operation Panel] dialog box appears.

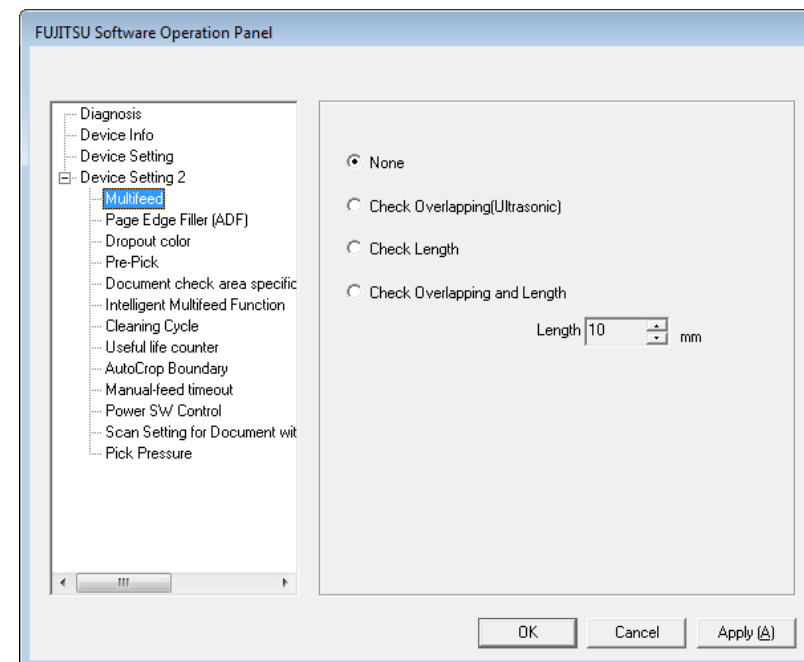

TOP

Contents

Index

Introduction

Scanner
OverviewLoading
DocumentsScan
ParametersVarious
Documents

Daily Care

Consumables

Trouble-
shootingOperational
Settings

Appendix

Glossary

8.2 Configurable Items

Using the Software Operation Panel, you can configure the following settings for the scanner that is connected to a computer.

Device Setting

- 1 Start up the Software Operation Panel.
Refer to "8.1 Starting Up the Software Operation Panel" (on page 139).
- 2 From the tree listing on the left, select [Device Setting].

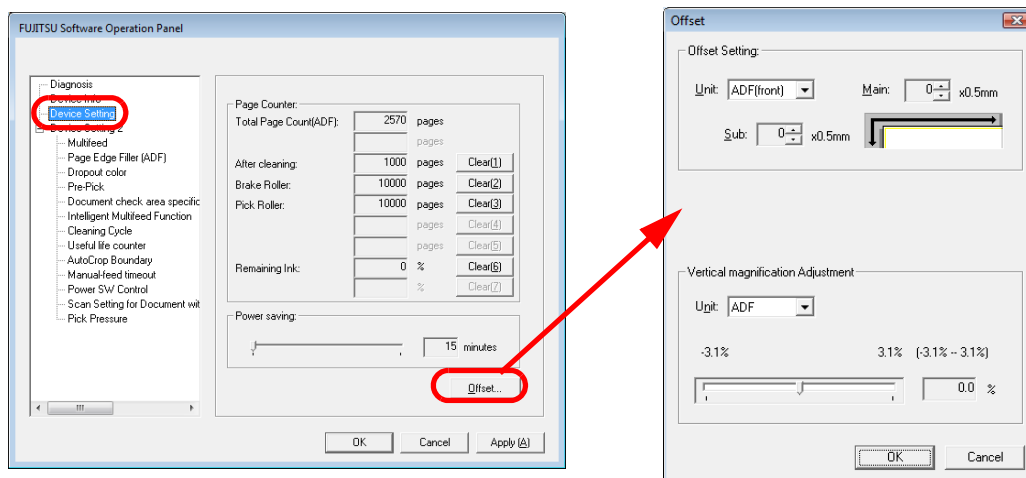

Item	Explanation	Selectable Parameters	Default	Connection via SCSI/USB Connector 1	Connection via SCSI/USB Connector 2
Page Counter (Consumables counters)	For evaluating the consumable replacement cycle. Use this function to reset the counters after replacing the consumables.	After cleaning/Brake Roller/Pick Roller Remaining Ink (only when the imprinter option for fi-6670/fi-6670A is installed)	0 pages Shown only when the imprinter option for fi-6670/fi-6670A is installed.	Yes	Yes
Power saving	Specify the waiting time before entering the Power saving mode.	Setting range: 15 to 55 min. (in steps of 5 min.)	15 min.	Yes	Yes
Offset	Adjust the starting position for the document scanning.	Unit: For connection via SCSI/USB Connector 1: ADF (Front), ADF (Back) (fi-6670/fi-6670A/fi-6770/fi-6770A only) Flat Bed (Flatbed type only) For connection via SCSI/USB Connector 2: ADF (Back), Flat Bed (fi-6770/fi-6770A only) Main/Sub: -2 mm to 3 mm (in steps of 0.5 mm)	Main/Sub: 0 mm	Yes	Yes
Vertical magnification Adjustment	Adjust the magnification in the feeding direction on the scanning side specified for [Unit].	Unit: ADF, Flat Bed (Flatbed type only) Setting range: -3.1 to 3.1% (in steps of 0.1%)	0%	Yes	Yes

Yes: Configurable

Device Setting 2

- 1 Start up the Software Operation Panel.
Refer to "8.1 Starting Up the Software Operation Panel" (on page 139).
- 2 From the tree listing on the left, select [Device Setting 2].

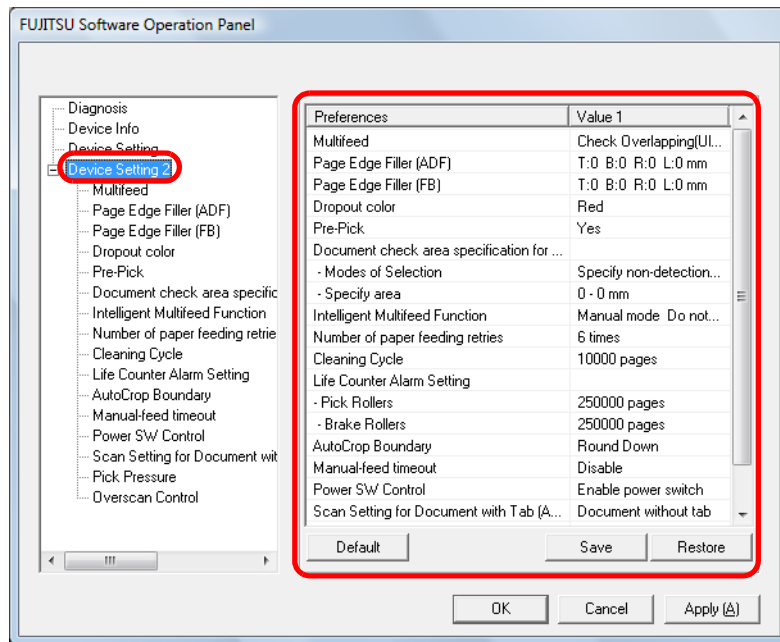

Clicking a desired item on the tree listing one the list shows its related parameters on the right.

TOP

Contents

Index

Introduction

Scanner
OverviewLoading
DocumentsScan
ParametersVarious
Documents

Daily Care

Consumables

Trouble-
shootingOperational
Settings

Appendix

Glossary

Selecting each item displays detailed settings (parameters) in the right part of the dialog box.

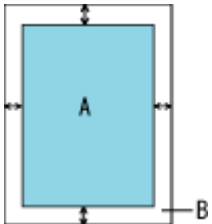
Item	Explanation	Selectable Parameters	Default	Connection via SCSI/USB Connector 1	Connection via SCSI/USB Connector 2
				Yes: Configurable No: Not configurable	
Multifeed	Select the method to detect multi-feeds. Check either of overlapping or document length, or both. Can also be specified from the scanner driver's setting dialog box. Note the setting with the scanner driver is given a priority.	None/Check Overlapping [Ultrasonic]/ Check Length/Check Overlapping and Length Selectable length (to be detected as length difference): 10, 15 or 20 mm	Check Overlapping [Ultrasonic]	Yes	Yes
Page Edge Filler (ADF) Page Edge Filler (FB)	Fill the specified width of the end sections on the scanned image with white or black color. When the backing (background) color is white, the end sections are filled with white; and when the background color is black, filled with black. Can also be specified from the scanner driver's setting dialog box. Note the setting with a larger value is given a priority. The setting here is not applied when Kofax VRS is used.	ADF: Top/Left/Right: 0 to 15 mm Bottom: -7 to 7 mm (in increments of 1 mm) FB: Top/Bottom/Left/Right: 0 to 15 mm  (A: Image area, B: Filled area, A+B: Output area)	Top/Bottom/Left/Right: 0 mm	Yes	No
Dropout color	Drop out a preselected color for the scanned image (binary black & white/grayscale mode only). Can also be specified from the scanner driver's setting dialog box. Note the setting with the scanner driver is given a priority.	Red/Green/Blue/White	Green	Yes	No

Item	Explanation	Selectable Parameters	Default	Connection via SCSI/USB Connector 1	Connection via SCSI/USB Connector 2
				Yes: Configurable No: Not configurable	
Pre-pick	To give a higher priority to processing speed, select [Yes], if not, select [No]. Can also be specified from the scanner driver's setting dialog box. Note the setting with the scanner driver is given a priority.	Yes/No	Yes	Yes	No
Document check area specification for Multifeed Detection	Selected range: Check this item when limiting the range of detecting multifeeds. You can determine if multifeed detection is enabled or disabled for the specified area.	Check or do not check "Selected range"	Do not check	Yes	Yes
		Enable/Disable (when "Selected range" is checked)	Disable		
	Start: Specify the start point of the check area in length (mm) from the top edge of the document.	0 to 510 mm (in increments of 2 mm)	0 mm		
	End: Specify the end point of the check area in length (mm) from the top edge of the document.	0 to 510 mm (in increments of 2 mm)	0 mm		
Intelligent Multi-feed Function	Bypass multifeed detection by remembering the pattern (size and location) of glued paper on the document. Note that you need to select "Check Overlapping" beforehand by referring to " Multifeed Detection " (on page 163).	Manual Mode/Auto Mode 1/Auto Mode 2	Manual Mode	Yes	Yes
	Select whether to memorize the multifeed pattern at power-off or not.	Remember/Do not remember	Do not remember		

Item	Explanation	Selectable Parameters	Default	Connection via SCSI/USB Connector 1	Connection via SCSI/USB Connector 2
				Yes: Configurable No: Not configurable	
Cleaning Cycle	Displays the time to clean the consumables. When the number of sheets scanned exceeds the value of this counter, the background color of the counter turns yellow and a cleaning instruction is prompted from the scanner driver. The cleaning instruction is not displayed when Kofax VRS is used.	1,000 to 255,000 sheets (in increments of 1,000) Show cleaning instructions: Check/Do not check	10,000 sheets Do not check	Yes	Yes
Useful life counter	When the value of the page counter (consumables counter) (refer to "8.3 Settings Related to Consumables and Useful Life Counters" (on page 148)) exceeds a value specified here, the background color of the counter turns yellow, and a replacing instruction is displayed from the scanner driver.	10,000 to 2,550,000 sheets (in increments of 10,000) for each consumable	200,000 sheets	Yes	Yes
SCSI Bus Width	Specify the data transfer width when the connection is via SCSI Connector 2 on the CGA board.	16 bit (Wide)/8 bit	16 bit (Wide)	No	Yes
AutoCrop Boundary	Select whether to round up or down the fractional part of scanned image data.	Round Up/Round Down	Round Down	Yes	No

Item	Explanation	Selectable Parameters	Default	Connection via SCSI/USB Connector 1	Connection via SCSI/USB Connector 2
				Yes: Configurable No: Not configurable	
Manual-feed timeout	Specify the waiting time to disable manual feeding.	Disable/Enable Waiting time setting when this option is enabled: For connection via SCSI/USB Connector 1: 5, 10, 20, 30, 40, 50, 60, 70, 80, 90, 100, 110, 120, 180, 240, 300, 360, 420, 480, 540, 600, 900, 1200, 1500, 1800, 1999 (in seconds) For connection via SCSI/USB Connector 2: 5, 10, 20, 30 (in seconds)	Disable	Yes	Yes
Power SW Control	Specify whether or not to enable power switch by using the [Power] button on the Operator Panel.	Enable power switch/Disable power switch	Enable power switch	Yes	Yes
Scan Setting for Document with Tab	For a document that includes index sheets or a document with index stickers (or tabs) attached at its bottom edge, you can specify whether or not to include the index portion (or tab) images during scanning with Auto Paper Size Detection setting. When "Document with tab" is selected, the tab (index) image is included in the document page image. Scanning speed with this setting, however, slows down to a certain degree. Once this setting is enabled, the the [Scan Setting for Document in Dark Background Color] option will automatically be disabled.	For connection via SCSI/USB Connector 1: Document with tab/Document without tab/Non-rectangular document For connection via SCSI/USB Connector 2: Document with tab/Document without tab	Document without tab	Yes	Yes

Item	Explanation	Selectable Parameters	Default	Connection via SCSI/USB Connector 1	Connection via SCSI/USB Connector 2
				Yes: Configurable No: Not configurable	
Scan Setting for Document in Dark Background Color	Specify whether or not to detect the edge of document in a dark background color during scanning. You can specify a density of background color so the edge will be detected correctly. Once this option is enabled, the settings for scanning documents with tabs will automatically be disabled.	Disable/Enable Density of background color: 1 to 5 levels	Disable	No	Yes
Overcrop/Undercrop	Adjust the output image scanned by enabling the Automatic Page Size Detection option.	Overcrop: 0 mm to 3 mm (in increments of 1 mm) Undercrop: -3 mm to 0 mm (in increments of 1 mm)	0 mm	No	Yes
Pick Pressure	Specify the pick pressure for feeding documents.	Low/Mid/High	Mid	Yes	Yes
Overscan Control	Specify whether to expand the scannable area or not at overscan.	Normal/Expand	Normal	Yes	No
Paper feeding retry times	Specify how many times the scanner retries feeding (picking) paper.	1 to 8 times	6 times	Yes	Yes

[Default] button

Resets the scanner settings to the factory default.

[Save] button

Backs up the scanner settings and saves it to your computer. (This button is useful when you want to configure the same settings to the other fi-6770/6750S/6670 scanner.)



"Save" is to write the EEPROM values on the scanner to a file. If any values are changed just before, click the [Apply] button and then click the [Save] button.

[Restore] button

Restores the settings from your computer to the scanner.

8.3 Settings Related to Consumables and Useful Life Counters

Confirming and Resetting the Counters

■ Confirming the counters

- 1 Start up the Software Operation Panel.
Refer to "8.1 Starting Up the Software Operation Panel" (on page 139).
- 2 From the tree listing on the left, select [Device Setting].

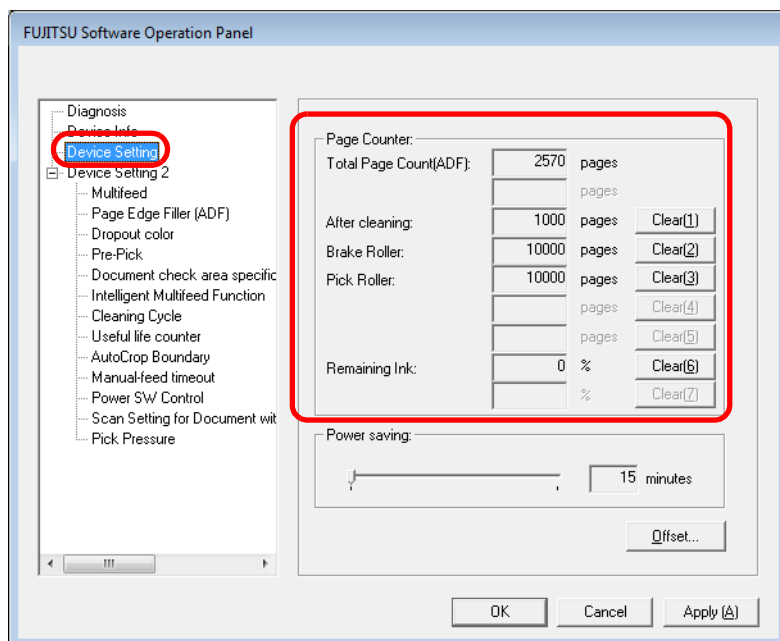

In this dialog box, you can confirm the following items:

Item	Description
Total Page Count (ADF)	Total sheets scanned using the ADF
Total Page Count (FB)	Total sheets scanned using the Flatbed
After cleaning	Total sheets scanned after last cleaning
Brake Roller	Number of sheets scanned since last replacement of Brake Rollers
Pick Roller	Number of sheets scanned since last replacement of Pick Rollers
Remaining Ink	Remaining ink in the imprinter's (sold separately) print cartridge. (Displayed only when the imprinter option is mounted.)

■ Resetting the counters

Reset the consumables counter(s) every time you replace the consumable(s). Follow the procedure below.

- 1 Click the [Clear] button beside the replaced consumable.

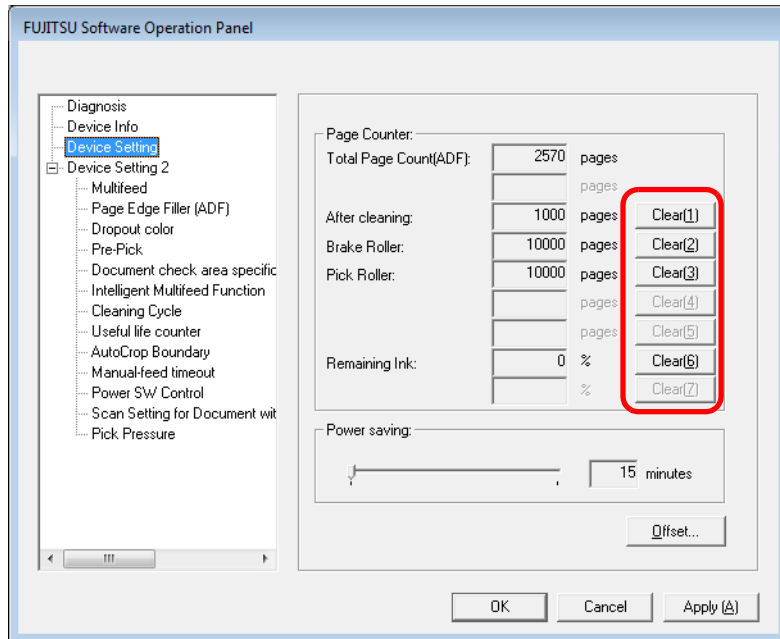

- 2 Click the [OK] button on the confirmation message displayed.

⇒ The counter is reset to 0.
The remaining ink indication (percentage) is reset to 100.

- 3 In the Software Operation Panel, click the [OK] button.

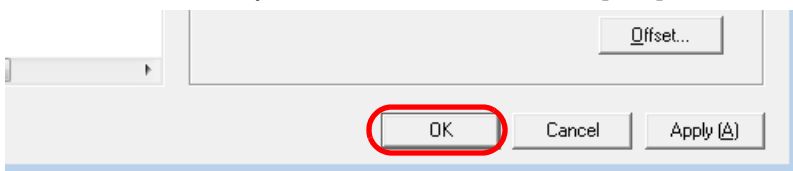

■ Replacing and Cleaning Instructions

The following may sometimes appear while using the scanner:
Replacing instruction:

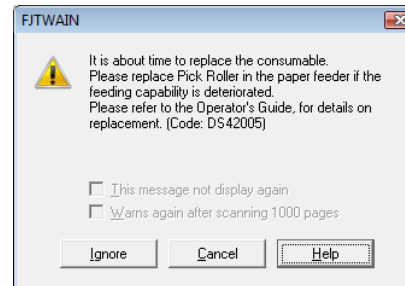

Cleaning instruction:

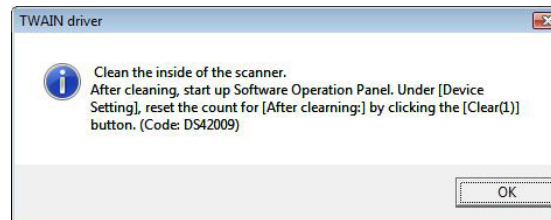

According to the instruction displayed, clean the scanner or replace the consumables.

When you click the [Ignore] button, the cleaning instruction disappears and the scanning continues. You may be able to continue the scanning for a while, however, it is recommended that you replace the consumable(s) as soon as possible. To stop the scanning and replace the consumable(s) right away, click the [Cancel] button.

For how to replace the consumables, refer to the following sections:

Pick Roller; see "6.2 Replacing the Pick Rollers" (on page 108).

Brake Roller; see "6.3 Replacing the Brake Roller" (on page 110).

For how to clean the scanner, refer to "Chapter 5 Daily Care" (on page 97).

Cycle for Cleaning the Scanner [Cleaning Cycle]

You can specify the cycle for cleaning the scanner.
If the value of the page counter (consumables counter) exceeds a value specified here, the background color of the counter will turn yellow. You can also specify whether or not to receive a cleaning instruction ([on page 149](#)).

- 1 Start up the Software Operation Panel.
Refer to "8.1 Starting Up the Software Operation Panel" ([on page 139](#)).
- 2 From the tree listing on the left, select [Device Setting 2] ⇒ [Cleaning Cycle].

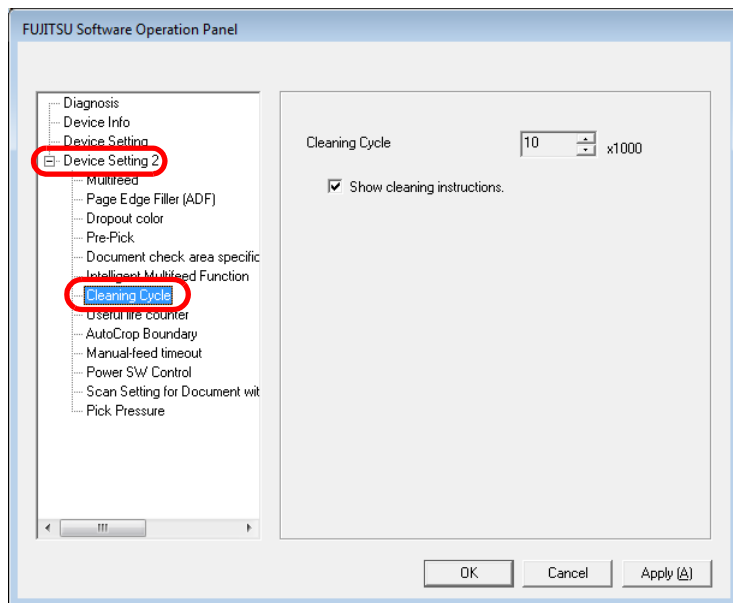

- 3 Specify a value to determine when to clean the scanner.
The specifiable value is from 1,000 to 255,000 in increments of 1,000.
You can specify whether or not to receive a cleaning instruction.



The cleaning instruction does not appear when Kofax VRS is used.

TOP

Contents

Index

Introduction

Scanner
OverviewLoading
DocumentsScan
ParametersVarious
Documents

Daily Care

Consumables

Trouble-
shootingOperational
Settings

Appendix

Glossary

Cycle for Replacing the Consumables [Useful life counter]

You can change the cycle for replacing the consumables. If the value of the page counter (consumables counter) exceeds a value specified here, the background color of the counter will turn yellow, and a replacing instruction (on page 149) will appear.

- 1 Start up the Software Operation Panel.
Refer to "8.1 Starting Up the Software Operation Panel" (on page 139).
- 2 From the tree listing on the left, select [Device Setting 2] ⇒ [Useful life counter].

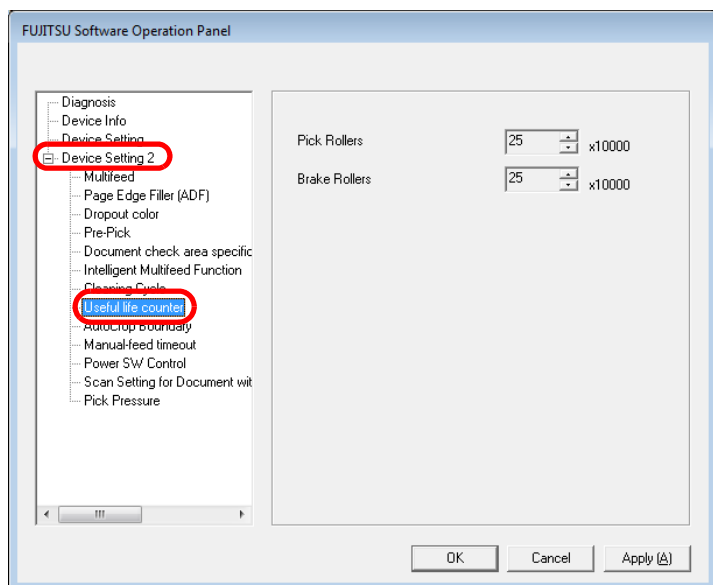

- 3 Specify a value for the life cycle for replacing each consumable (Pick Roller and Brake Roller).
You can specify a value ranging from 10,000 to 255,000 in increments of 10,000.

8.4 Settings Related to Scanning

Adjusting the Starting Position for Scanning [Offset/Vertical Magnification Adjustment]

When the position of the scanned image is not correct or the image looks elongated in a vertical direction, use the following procedure to adjust the offset and the scan scale for correction.



The factory default settings are appropriate, so normally there is no need to make any adjustment.

- 1 Start up the Software Operation Panel.
Refer to "8.1 Starting Up the Software Operation Panel" (on page 139).
- 2 From the tree listing on the left, select [Device Setting] and then click the [Offset] button.

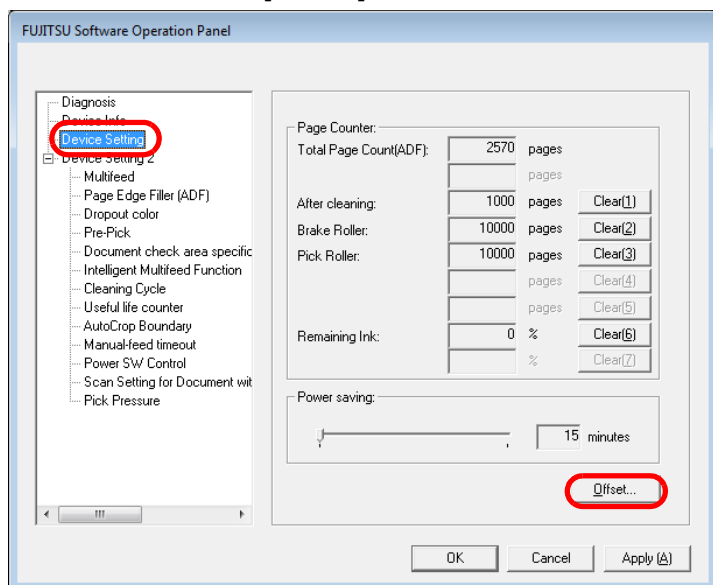

- 3 Adjust the offset/scan scale as necessary.

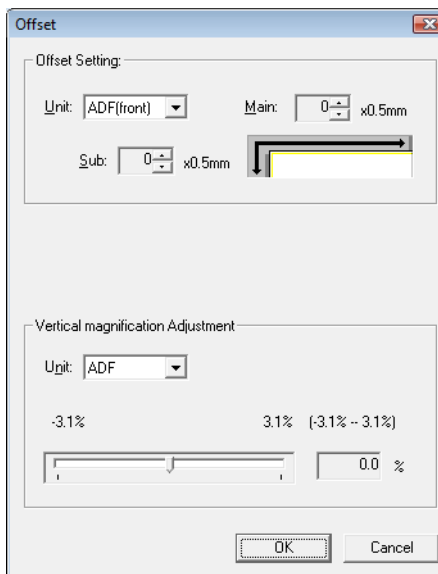

Offset Setting	Description
Unit	Select [ADF (front)] or [ADF (back)] (fi-6670/fi-6670A/fi-6770/fi-6770A only), or [Flat Bed] (flatbed type only) as the target of offset adjustment. When the connection is via SCSI/USB Connector 2, the offset for scanning with the ADF is adjustable for the back-side pages only.
Main	Adjusts the horizontal (widthwise) offset. The setting range is from -2 mm to +3 mm in steps of 0.5 mm.
Sub	Adjusts the vertical (lengthwise) offset. The setting range is from -2 mm to +3 mm in steps of 0.5 mm.

Vertical magnification Adjustment	Description
Unit	Select [ADF] or [Flatbed] (flatbed type only) as the target of vertical magnification adjustment.
Vertical (lengthwise) magnification adjustment	Adjusts the vertical (lengthwise) magnification. The setting range is from -3.1% to 3.1% in steps of 0.1%.

- TOP
- Contents
- Index
- Introduction
- Scanner Overview
- Loading Documents
- Scan Parameters
- Various Documents
- Daily Care
- Consumables
- Trouble-shooting
- Operational Settings**
- Appendix
- Glossary

Eliminating Shadows or Stripes on the Scanned Image Edge

[Page Edge Filler]

Depending on the type of document you scan, some shadow of the document sheet edge may be reflected onto its scanned image, and may turn out to be black thin lines on the image. If this is the case, you can improve the output image by using the "Page Edge Filler" function. This function fills the edge portion of the image so that it looks clean.

- 1 Start up the Software Operation Panel.
Refer to "8.1 Starting Up the Software Operation Panel" (on page 139).
- 2 From the tree listing on the left, select [Device Setting 2] ⇒ [Paper Edge Filter (ADF)] or [Page Edge Filler (FB)].

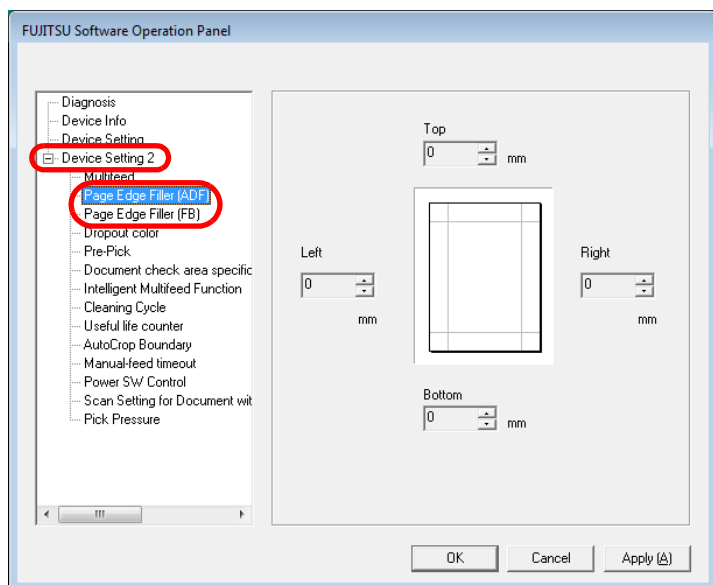

- 3 Specify the length for each margin; top, bottom, right, and left, to fill it.

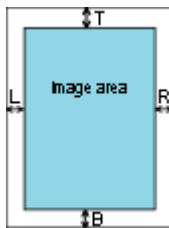

ADF

T: Top = 0 to 15 mm
B: Bottom = -7 to 7 mm
R: Right = 0 to 15 mm
L: Left = 0 to 15 mm

FB

T: Top = 0 to 15 mm
B: Bottom = 0 to 15 mm
R: Right = 0 to 15 mm
L: Left = 0 to 15 mm
(in 1 mm units)

The specified area is filled with white when the backing (or the background of document) is white, and with black when the backing is black.



Note that if the target range of the Page Edge Filler is too wide, some characters in the vicinity of the boundary may be cut out.



- Unless otherwise specified, the background color is white. You can also change it to "Black background" using the scanner driver. If you are using the TWAIN scanner driver, do the following to change the backing color to black: Select the [Option] button, and then select [Black background] from [Automatic Size and Skew detection] on the [Rotation] tab.
- This setting can also be specified from the scanner driver's setting dialog box. Note the setting with a larger value is given a priority.
- This setting is not applied when Kofax VRS is used.

Scanning with Particular Color(s) Dropped Out [Dropout color]

By using the "Dropout Color" function, you can scan documents with the specified color removed from the light's three primary colors, i.e., red, green, and blue. (This function is available for the binary black and white setting as well as the grayscale setting.)

For example, when you scan a document containing black text with a green background, you can output an image of black text only.

- 1 Start up the Software Operation Panel.
Refer to "8.1 Starting Up the Software Operation Panel" (on page 139).
- 2 From the tree listing on the left, select [Device Setting 2] ⇒ [Dropout color].

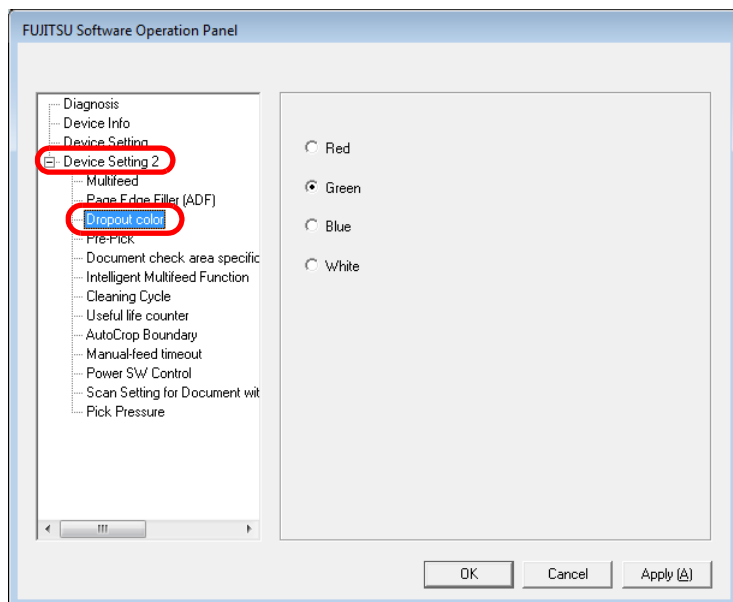

- 3 Select a color to drop out.
Red, Green, Blue: Red, green, or blue is dropped out.
White: No color is dropped out.



The Software Operation Panel allows you to select colors of red, green, and blue only. If you want to drop out other colors, configure settings in the scanner driver. For how to configure settings using the scanner driver, refer to "Excluding Color(s) from Images (Dropout Color)" (on page 67).



This setting can also be specified from the scanner driver's setting dialog box. Note the setting with the scanner driver is given a priority.

TOP

Contents

Index

Introduction

Scanner
OverviewLoading
DocumentsScan
ParametersVarious
Documents

Daily Care

Consumables

Trouble-
shootingOperational
Settings

Appendix

Glossary

Shorting the Scanning Intervals [Pre-Pick]

In the case of consecutive scanning, you can direct the scanner to previously pick the document to be scanned next. This operation is called Pre-Pick.

By enabling "Pre-Pick," the time interval between the scanning of two separate documents can be shortened.

- 1 Start up the Software Operation Panel.
Refer to "8.1 Starting Up the Software Operation Panel" (on page 139).
- 2 From the tree listing on the left, select [Device Setting 2] ⇒ [Pre-Pick].

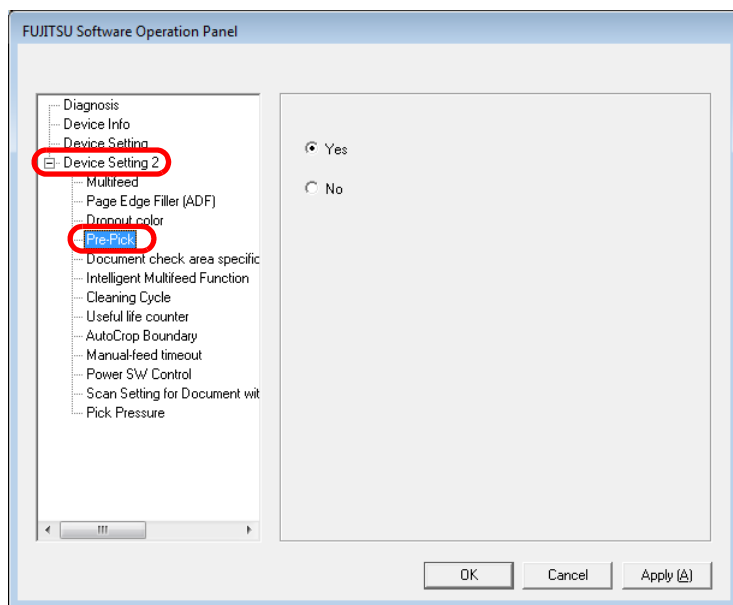

- 3 Configure settings for pre-picking.
Select [Yes] to enable Pre-pick, and select [No] to disable it.



- While Pre-Pick is enabled, if you cancel the scanning in process, you will have to eject all the pre-picked document sheets and reload them.
- This setting can also be specified from the scanner driver's setting dialog box. Note the setting with the scanner driver is given a priority.

TOP

Contents

Index

Introduction

Scanner
OverviewLoading
DocumentsScan
ParametersVarious
Documents

Daily Care

Consumables

Trouble-
shootingOperational
Settings

Appendix

Glossary

Cropping the Image Boundary [AutoCrop Boundary]

Some fractional data may be generated in scanned images in the process of scanning when [Auto Page Size Detection] is on.

You can specify whether to include or exclude such fractional data by specifying [AutoCrop Boundary].

- 1 Start up the Software Operation Panel.
Refer to "8.1 Starting Up the Software Operation Panel" (on page 139).
- 2 From the tree listing on the left, select [Device Setting 2] ⇒ [AutoCrop Boundary].

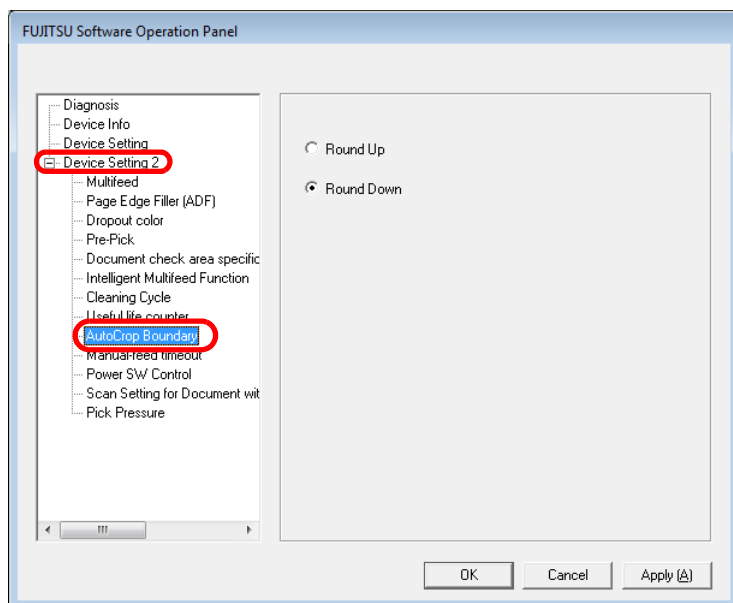

- 3 Select whether to include or exclude the fractional data. Select "Round Up" to prevent any exclusion of fractional data from scanned images, and select "Round Down" to cut it off.



- When scanning a document with text just across its bottom edge while "Round Down" is selected, some pixel data there may be lost.
- Selecting "Round Up" can prevent data loss, but it may generate black lines near the bottom edge, instead.
- For how to specify Auto Paper Size Detection, refer to "Automatically Correcting Skewed Document Images" (on page 77).



This setting is not applied when Kofax VRS is used.

TOP

Contents

Index

Introduction

Scanner
OverviewLoading
DocumentsScan
ParametersVarious
Documents

Daily Care

Consumables

Trouble-
shootingOperational
Settings

Appendix

Glossary

Configuring the Data Transfer Width [SCSI Bus Width]

You can configure the width of data transfer when your computer is connected to the scanner via SCSI Connector 2 on the CGA Board.

- 1 Start up the Software Operation Panel.
Refer to "8.1 Starting Up the Software Operation Panel" (on page 139).
- 2 From the tree listing on the left, select [Device Setting 2] ⇒ [SCSI Bus Width].

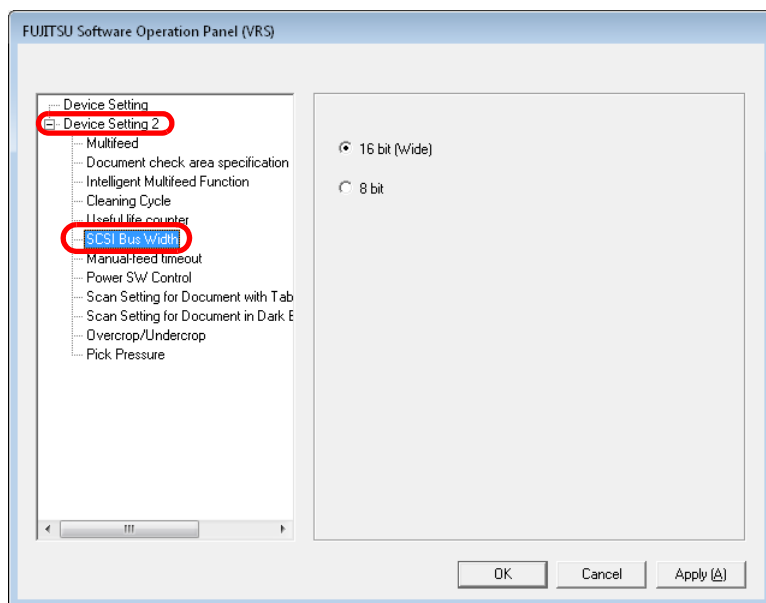

- 3 Select [16 bit(Wide)] or [8 bit].



Select [8 bit] if using any SCSI card or SCSI cable that does not support Ultra Wide SCSI.

Scan Setting for Documents with Tabs or Non-Rectangular Documents [Scan Setting for Documents with Tab (Automatic Paper Size Detection)]

When configuring settings to scan a non-rectangular document with a tab (index) or tab (index) sticker at the its bottom, you can scan and include such a tab or tab sticker in the scanned image when [Automatic Paper Size Detection] is selected.

- 1 Start up the Software Operation Panel.
Refer to "8.1 Starting Up the Software Operation Panel" (on page 139).
- 2 From the tree listing on the left, select [Device Setting 2] ⇒ [Scan Setting for Documents with Tab (Automatic Paper Size Detection)].

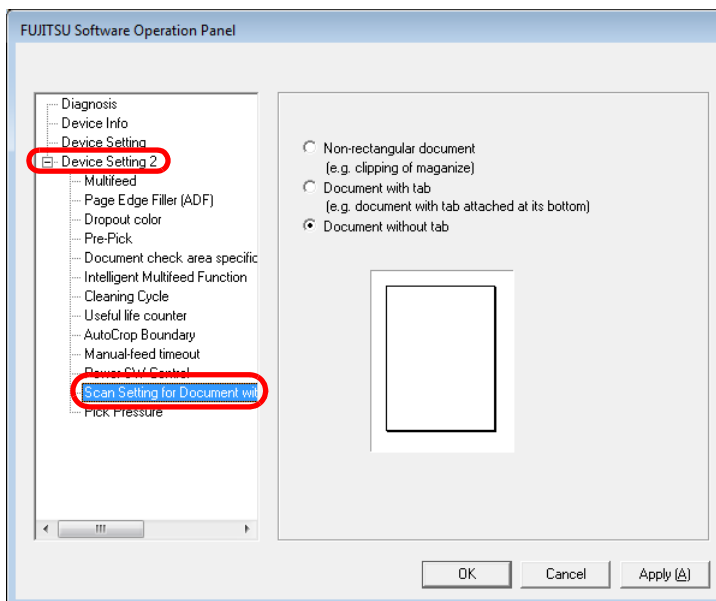

- 3 Select [Non-rectangular document], [Document with tab], or [Document without tab].

Item	Description
Non-rectangular document	Scan extra 120 mm from the detected bottom edge of the document.
Document with tab	Scan extra 20 mm from the detected bottom edge of the document.
Document without tab	Terminates scanning at the time the bottom edge of the document is detected.



- The scanning speed slows down if [Document with tab] or [Non-rectangular document] is selected.
- When scanning a document with tab or a non-rectangular document, refer to "[Loading Documents with Tabs or Non-Rectangular Documents](#)" (on page 45).
- For how to specify "Auto Paper Size Detection," refer to "[Automatically Correcting Skewed Document Images](#)" (on page 77).
- When the connection is via SCSI/USB Connector 2, note that:
 - You cannot select [Non-rectangular document].
 - If you scan a document having a tab, which is smaller than A5, the tab image (in part or whole) may be lost.
 - you cannot enable this setting together with [Scan Setting for Document in Dark Background Color]. If you enable this setting, the setting for [Scan Setting for Document in Dark Background Color] will automatically be disabled.

Scan Setting for The Document Whose One Side Is in Dark Background Color

[Scan Setting for Document in Dark Background Color]

You can specify whether or not to detect the edge of document in a dark background color during scanning.

You can specify a density of background color so the edge will be detected correctly.

If this option is enabled, the settings for scanning documents with tabs will automatically be disabled.

- 1 Start up the Software Operation Panel.
Refer to "[8.1 Starting Up the Software Operation Panel](#)" (on page 139).
- 2 From the tree listing on the left, select [Device Setting 2] ⇒ [Scan Setting for Document in Dark Background Color] ⇒ [Enable].

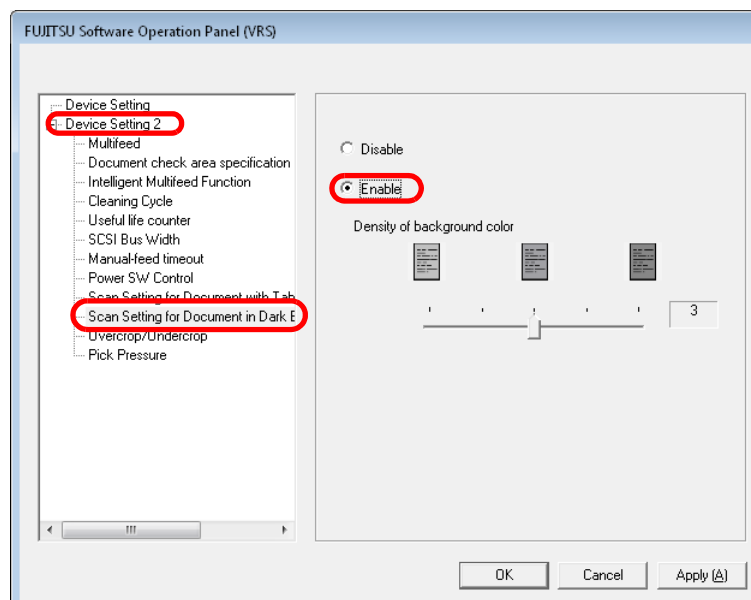

3 Specify the density of background color.



- Increasing the density level may cause incorrect edge detection due to some dust in the paper feeding path.
- You cannot enable this setting together with [Scan Setting for Documents with Tab (Automatic Paper Size Detection)]. If you enable this setting, the setting for [Scan Setting for Documents with Tab (Automatic Paper Size Detection)] will automatically be disabled.

Adjusting the Scanned Document Output Images [Overcrop/Undercrop]

You can adjust the size of the scanned document output image detected with the [Automatic Paper Size Detection] option.

- 1 Start up the Software Operation Panel.
Refer to "8.1 Starting Up the Software Operation Panel" (on page 139).
- 2 From the tree listing on the left, select [Device Setting 2] ⇒ [Overcrop/Undercrop].

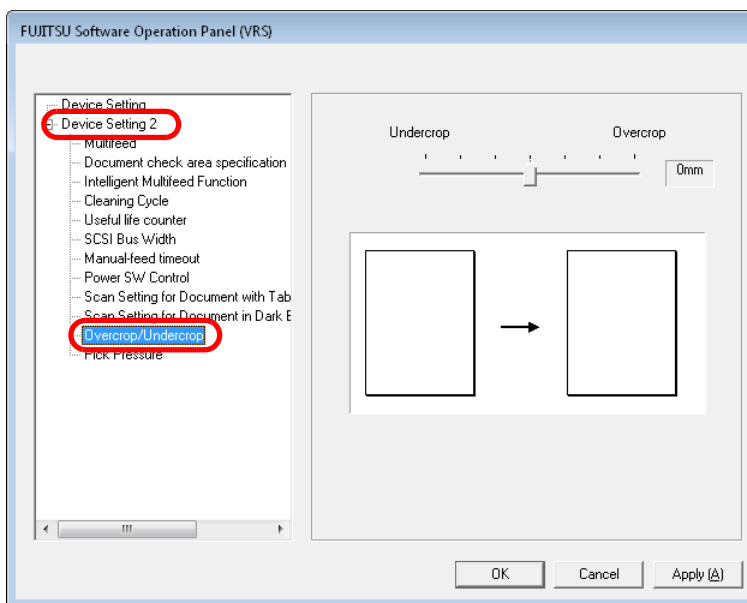

- 3** Use the slider control to adjust the scanned document output image.

Item	Description
Overcrop	Crops the scanned document image a little larger than the actual size, leaving black background margins outside the image so that the data on the edge of the image will not be lost. The specifiable range is from 0 mm to 3 mm in increments of 1 mm.
Undercrop	Crops the scanned document image a little smaller than the actual size, leaving no black margins on the edge of the image. The specifiable range is from -3 mm to 0 mm in increments of 1 mm.



With the Overcrop option on; if the document you scanned is wide, the black margins outside the document may not be included in the scanned image.



The scanned document output image will not be adjusted if 0 mm has been selected using the slider control.

Adjusting the Paper Picking Pressure [Pick Pressure]

Scanning a thick document at a regular paper picking pressure may force the Feed Rollers of the scanner to spin free without catching the document properly, causing scanning retries.

To avoid this, you can use this option to adjust the pick pressure to scan such documents.

- 1 Start up the Software Operation Panel.
Refer to "8.1 Starting Up the Software Operation Panel" (on page 139).
- 2 From the tree listing on the left, select [Device Setting 2] ⇒ [Pick Pressure].

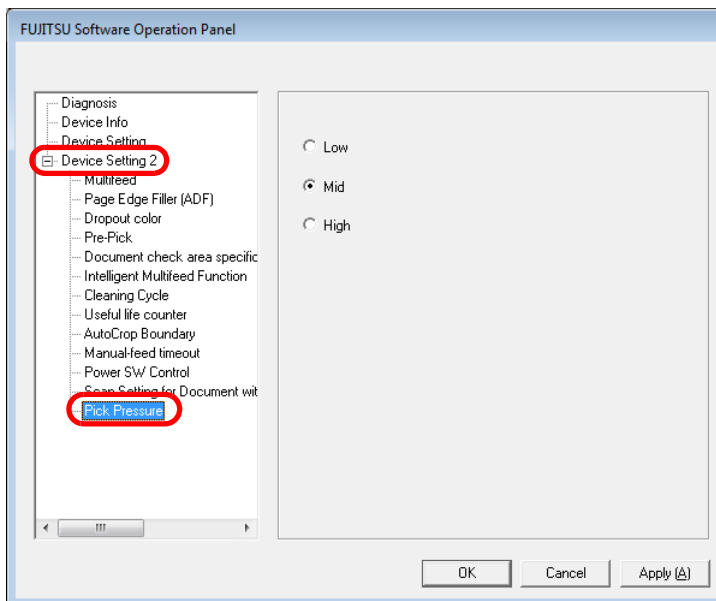

3 Specify the pick pressure for feeding your document.



- Scanning thin paper with [High] may cause a paper jam.
- Scanning thick paper with [Low] may not feed the paper properly, just making the Feed Rollers to repeat rotating freely.



- Specifying [High] strengthens the feeding force of the Feed Rollers, feeding hard-to-feed documents quickly.
- The [High] option is effective for scanning relatively-thick documents.
- Specifying [Low] can scan even thin, delicate paper. However, if you want to scan such thin document (if not recommended), you must test-scan using a dummy paper of the same paper quality beforehand to prove that the paper can be scanned properly.
- The [Low] option is effective for scanning relatively-thin documents.

8.5 Settings Related to Multifeed Detection

Multifeed Detection

A "multifeed" is a feeding error that occurs when two or more sheets in the ADF paper chute are fed simultaneously into the scanner.

If you continue scanning document without knowing this multifeed error, you could skip some of important data while scanning the document.

This scanner has the Multifeed Detection function to prevent such troubles.

With the Multifeed Detection enabled, the scanner indicates an error message and halts the scanning immediately at a multifeed error.

Note that the Multifeed Detection is not available for the range about 30 mm from the leading edge of document.

- 1 Start up the Software Operation Panel.
Refer to "8.1 Starting Up the Software Operation Panel" (on page 139).

- 2 From the tree listing on the left, select [Device Setting 2] ⇒ [Multifeed].

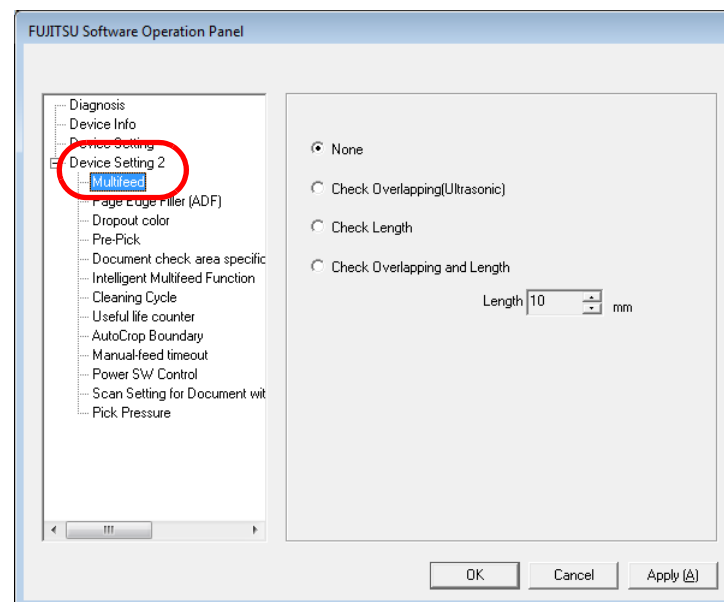

- 3 Select one of the following detection methods.

Detection Method	Description
None	Does not detect multifeeds.

TOP

Contents

Index

Introduction

Scanner
OverviewLoading
DocumentsScan
ParametersVarious
Documents

Daily Care

Consumables

Trouble-
shootingOperational
Settings

Appendix

Glossary

Detection Method	Description
Check Overlapping (Ultrasonic)	<p>Detects multifeeds by checking for document overlapping.</p> <p>When this option is selected, the following two more detection options can be set:</p> <ul style="list-style-type: none"> You can specify the multifeed detection range by the length from the leading edge of document. Go to "Specifying the Multifeed Detection Range [Document Check Area Specification for Multifeed Detection]" (on page 165). If two or more sheets of paper of the same size are stuck on the same position of the document, you can cancel the Multifeed Detection for that area. Go to "Bypassing Multifeed Detection for a Fixed Format" (on page 93).
Check Length	Detects multifeeds by monitoring the difference of the document length.
Check Overlapping and Length	Detects multifeeds when both [Check Overlapping(Ultrasonic)] and [Check Length] are selected.
Length	Select 10, 15, or 20 mm as the document length difference, which is to be considered as a Multifeed, when [Check Length] is selected. If the detected document length does not reach the selected length, it will be recognized just as an error, and thus will not be recognized as a multifeed.

 • When scanning documents of different lengths together in the same stack, select [Checking Overlapping(Ultrasonic)].

• If something like a stamp, memo or photo is glued to the document, specifying [Checking Overlapping(Ultrasonic)] may wrongly detect the glued section as an overlap error. When scanning such a document, select [Checking Length] instead. Note you can also select [Checking Overlapping(Ultrasonic)] by limiting the detection range.

 You can also use the scanner driver to configure the settings above. In this case, the settings in the scanner driver are given a priority.

- TOP
- Contents
- Index
- Introduction
- Scanner Overview
- Loading Documents
- Scan Parameters
- Various Documents
- Daily Care
- Consumables
- Troubleshooting
- Operational Settings**
- Appendix
- Glossary

Specifying the Multifeed Detection Range [Document Check Area Specification for Multifeed Detection]

The following settings are available only when [Check Overlapping(Ultrasonic)] is selected.

- From the tree listing on the left, select [Device Setting 2] ⇒ [Document check area specification for Multifeed Detection]. Then, select the [Selected range] checkbox.

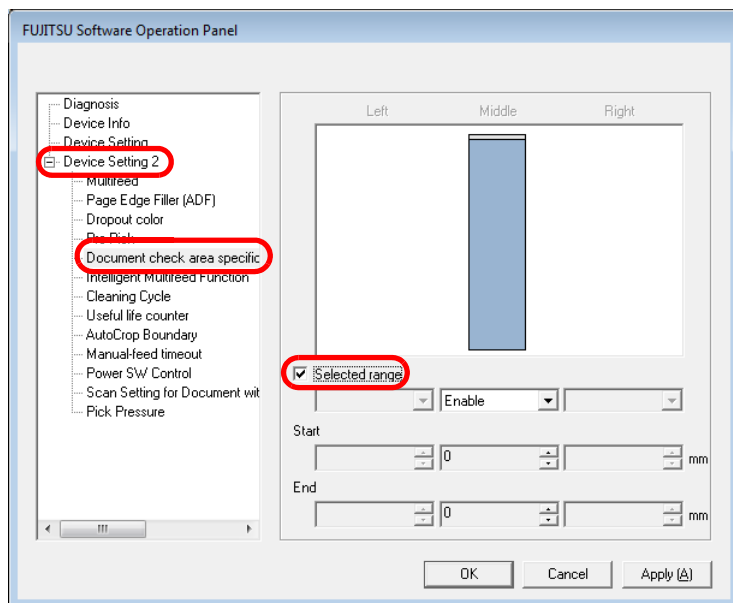

- Specify the detection range.

Detection Range	Description
Selected range	<p>Must be checked to specify the detection range.</p> <p>Mark this checkbox to enable the settings configured in this dialog box. Otherwise, let the checkbox unmarked. Clearing this checkbox sets both the starting and ending positions to "0," making the whole range of the document to be checked for multifeeds.</p>
None	Disables the Multifeed Detection for the specified range.
Enable	Enables the Multifeed Detection for the specified range.
Start	Specify the starting position of the detection range from the leading edge of the document. The configurable area is from 0 to 510 mm in 2 mm increments, where the starting position is less than the ending position.
End	Specify the ending position of the detection range from the leading edge of the document. The configurable area is from 0 to 510 mm in 2 mm increments, where the starting position is less than the ending position.



- Once the starting and ending positions are set to "0," the whole range of the document will be checked for multifeeds regardless of whether "Enable" or "Disable" is selected under [Selected range].
- To disable the Multifeed Detection for the entire document, select [Disable] and configure the settings so the starting position will be "0," and the ending position be equal to or not smaller than the "document length."
- If the starting position is set larger than the document length; with [Disable], the whole range covering the entire document length will be checked; with [Enable], the Multifeed Detection will be disabled.
- To detect multifeeds, the detection range should be at least 5 mm in length. Configure the settings so the ending position minus the starting position be 6 mm or more.
- You can also specify the starting and ending positions in either of the following ways:
 - Create a square or rectangle to indicate the detection range by dragging your mouse pointer within the displayed image in the dialog box.
 - Drag the handle for the detection range to change the starting and ending positions using the mouse pointer within the displayed image in the dialog box.

Setting Example 1: Selected range = Enable, Start = 50 mm, End = 200 mm

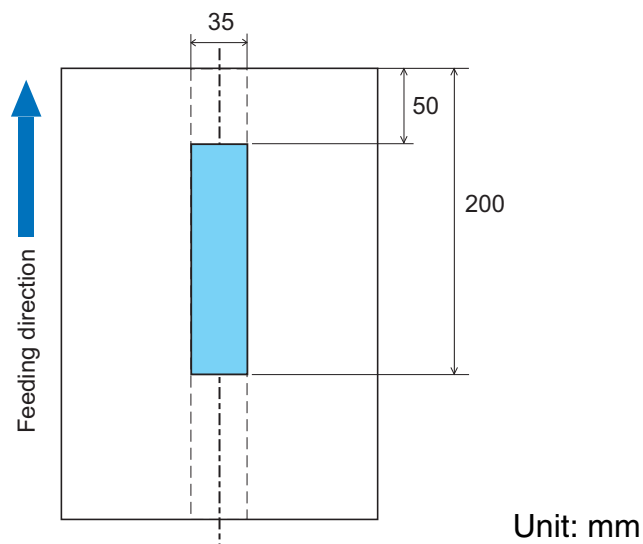

A multifeed error will be detected only for the blue-shaded area in the figure above.

TOP

Contents

Index

Introduction

Scanner
OverviewLoading
DocumentsScan
ParametersVarious
Documents

Daily Care

Consumables

Trouble-
shootingOperational
Settings

Appendix

Glossary

Setting Example 2 : Selected range = Enable, Start = 0 mm, End =0 mm

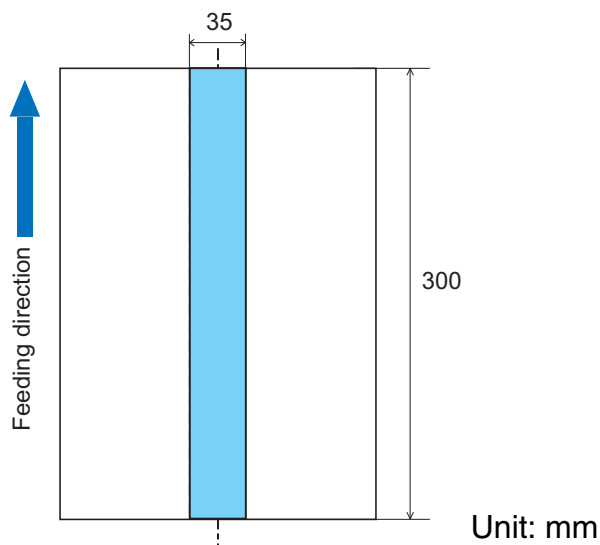

A multifeed error will be detected only for the blue-shaded area in the figure above.



When [Check Overlapping(Ultrasonic)] is selected, the multi-feed detection ratio may drop if the document sheet(s) are glued or electrostatically adhered to each other.

Setting Example 3 (Bad Example): Selected range = Enable, Start = 100 mm, End =102 mm

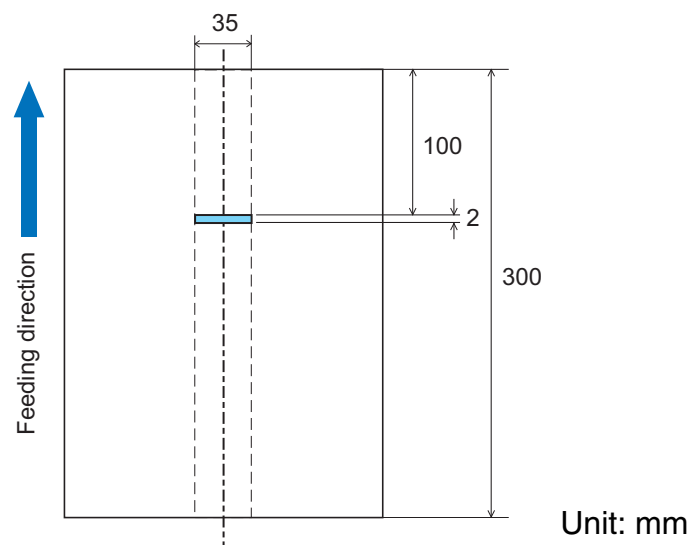

Since the detection range (length) is less than the minimum value (5 mm), the Multifeed Detection cannot be performed correctly.

Setting A Non-Multifeed-Detection Range [Intelligent Multifeed Function]

You can bypass multifeed detection by letting the scanner remembering the pattern (size and location) of glued paper on the document.

Note that you need to select "Check Overlapping" beforehand by referring to ["Multifeed Detection"](#) (on page 163).

- 1 Start up the Software Operation Panel.
Refer to ["8.1 Starting Up the Software Operation Panel"](#) (on page 139).
- 2 From the tree listing on the left, select [Device Setting 2] ⇒ [Intelligent Multifeed Function].

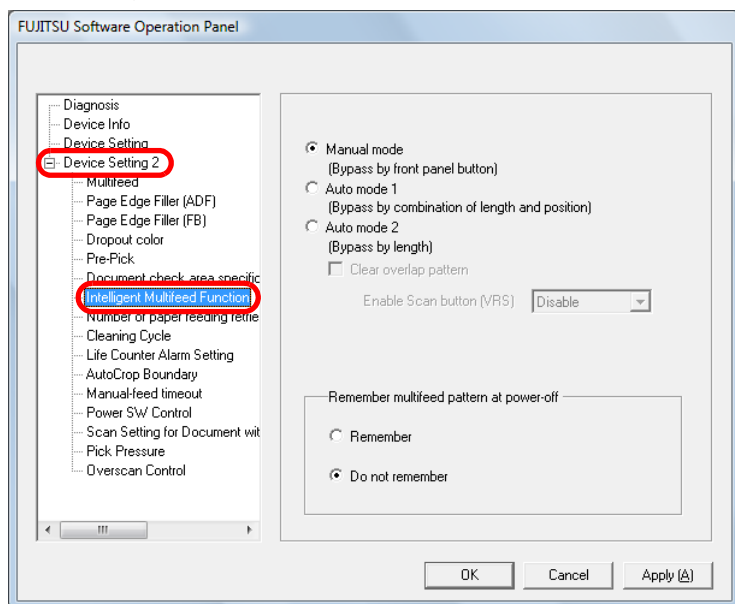

- 3 Select a desired operation mode, and then click the [OK] button.

Operation Mode	Description
Manual Mode	The scanner stops scanning each time a multi-feed error is detected. You can resume scanning after reloading the multifeed document. The scanner does not remember the size and location of paper glued on the document.
Auto Mode 1	The scanner remembers the size and location of paper glued on the document when a multi-feed error occurs and you reload the multifeed document on the ADF Paper Chute. Multifeed Detection for this pattern is disabled from the next scanning on.
Auto Mode 2	The scanner remembers the size of paper glued on the document when a multifeed error occurs and you reload the multifeed document on the ADF Paper Chute. Multifeed Detection for this pattern is disabled from the next scanning on.

- 4 Select whether to let the scanner memorize the multifeed pattern at power-off or not on the [Remember multifeed pattern at power-off]. If you select [Remember], you can use the multifeed pattern which is memorized before power-off even after re-turning the power on. (Eight patterns at power-off can be memorized.)



Selecting the [Clear overlap pattern] checkbox clears the overlapping pattern (size and/or location) memorized in Auto Mode.

If you change the current mode to another, the remembered pattern (size and/or location) will automatically be cleared.

To how to work further with the Intelligent Multifeed function, refer to ["Bypassing Multifeed Detection for a Fixed Format"](#) (on page 93).

8.6 Settings Related to Wait Time

Timeout for Manual Feeding [Manual-feed timeout]

In Manual Feeding mode where you manually load documents sheet by sheet, you can scan multiple batches of documents continuously as a single file when you load the second stack of document before the timeout time after loading the first batch.

When the time has elapsed, the scanning terminates automatically, canceling manual feeding.

You can cancel the Manual Feeding mode immediately by pressing the [Send to] button within the timeout period specified.

- 1 Start up the Software Operation Panel.
Refer to "8.1 Starting Up the Software Operation Panel" (on page 139).

- 2 From the tree listing on the left, select [Device Setting 2] ⇒ [Manual-feed timeout].

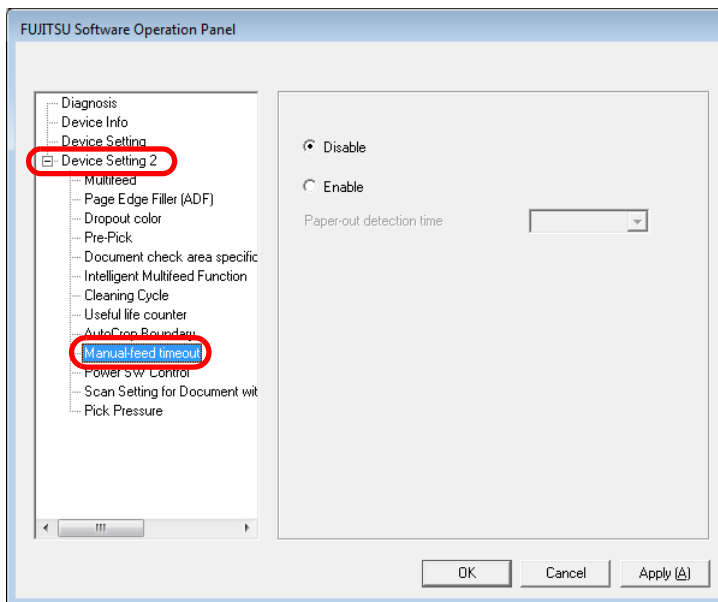

- 3 Select whether to enable or disable [Manual feed timeout]. To enable the timeout setting, select the timeout period for manual feeding until loading the next document after the previous one.



When [Manual feed timeout] is enabled, the scanner waits for the document to be loaded within the specified timeout period, even if scanning starts with no document loaded in the ADF Paper Chute.

TOP

Contents

Index

Introduction

Scanner
OverviewLoading
DocumentsScan
ParametersVarious
Documents

Daily Care

Consumables

Trouble-
shootingOperational
Settings

Appendix

Glossary

Setting the Wait Time in Power Saving Mode [Power saving]

This scanner switches to power saving mode automatically to save power when it remains unused for a certain period of time.

- 1 Start up the Software Operation Panel.
Refer to "8.1 Starting Up the Software Operation Panel" (on page 139).
- 2 From the tree listing on the left, select [Device Setting].

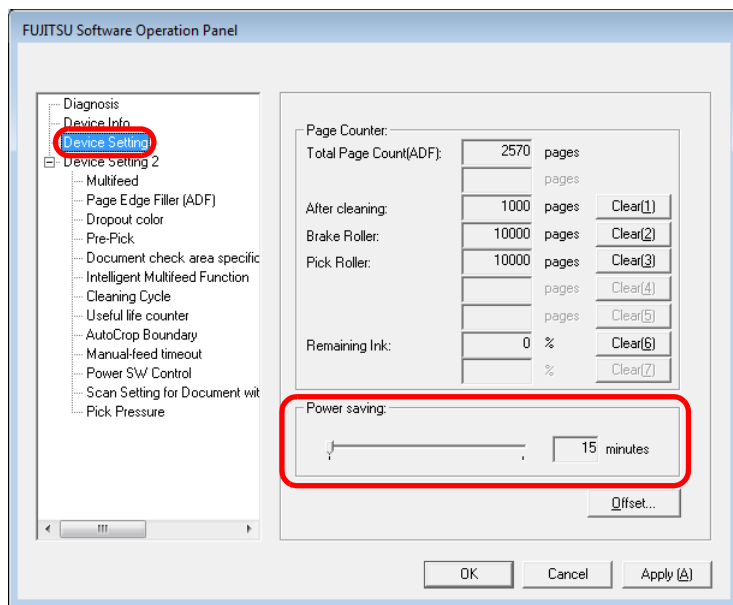

- 3 Use the slide control bar to set the waiting time before entering into power saving mode.
You can specify the waiting time in the range of 15 to 55 minutes (in increments of 5 minutes).

TOP

Contents

Index

Introduction

Scanner
OverviewLoading
DocumentsScan
ParametersVarious
Documents

Daily Care

Consumables

Trouble-
shootingOperational
Settings

Appendix

Glossary

8.7 Settings Related to Power ON/OFF Control

Power ON/OFF Control [Power SW Control]

This option is used to specify how to turn on/off the scanner. You can select whether or not to power the scanner on/off by using the [Power] button.

When this is disabled, use the main power switch.

- 1 Start up the Software Operation Panel.
Refer to "8.1 Starting Up the Software Operation Panel" (on page 139).
- 2 From the tree listing on the left, select [Device Setting 2] ⇒ [Power SW Control].

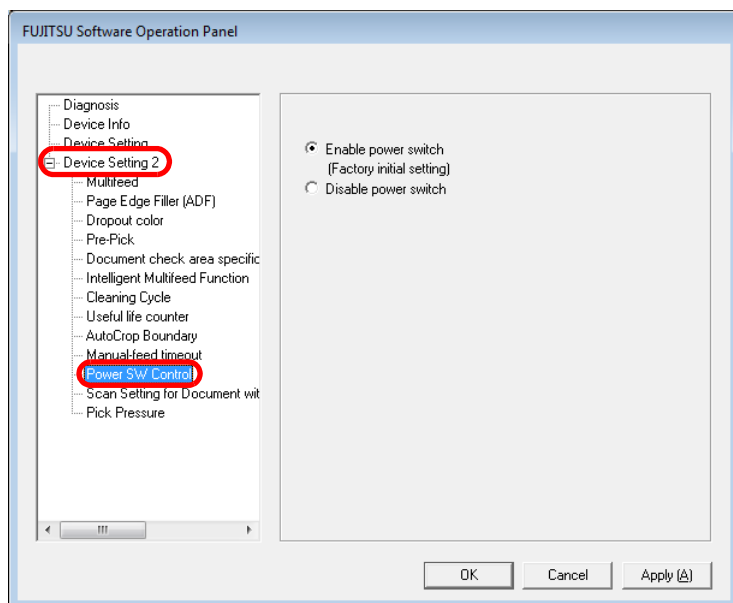

- 3 Select to enable or disable power on/off using the [Power] button.
Select [Enable power switch] to enable the [Power] button; [Disable power switch] to disable it.

[TOP](#)[Contents](#)[Index](#)[Introduction](#)[Scanner Overview](#)[Loading Documents](#)[Scan Parameters](#)[Various Documents](#)[Daily Care](#)[Consumables](#)[Troubleshooting](#)[Operational Settings](#)[Appendix](#)[Glossary](#)

8.8 Overscan Control

Specify [Expand] when you use Overscan and the image is partially missing due to an abnormal skew.

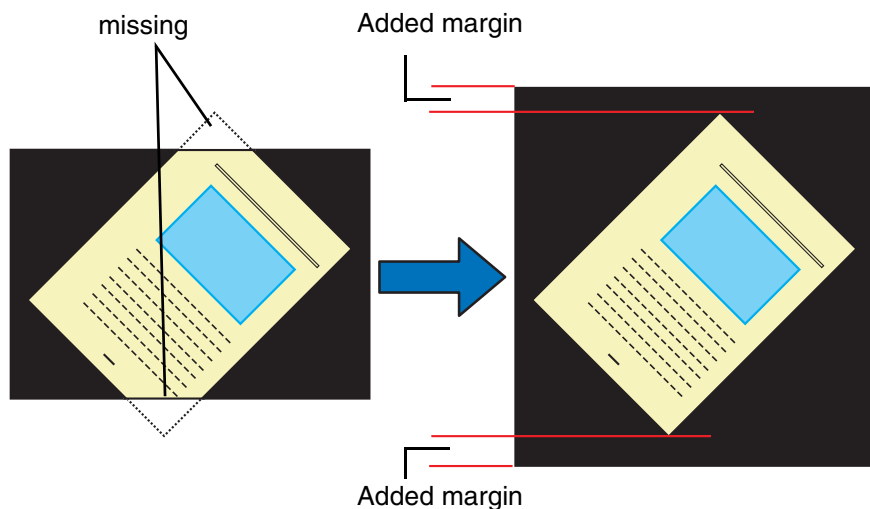

When parts of the image are missing

When [Expand] is specified

Configure the settings for Overscan Control as follows.

- 1 Start up the Software Operation Panel.
Refer to "8.1 Starting Up the Software Operation Panel" (on page 139).

- 2 Select [Device Setting 2] from left side list in the window, select [Overscan Control] from its lower level, then select [Expand].

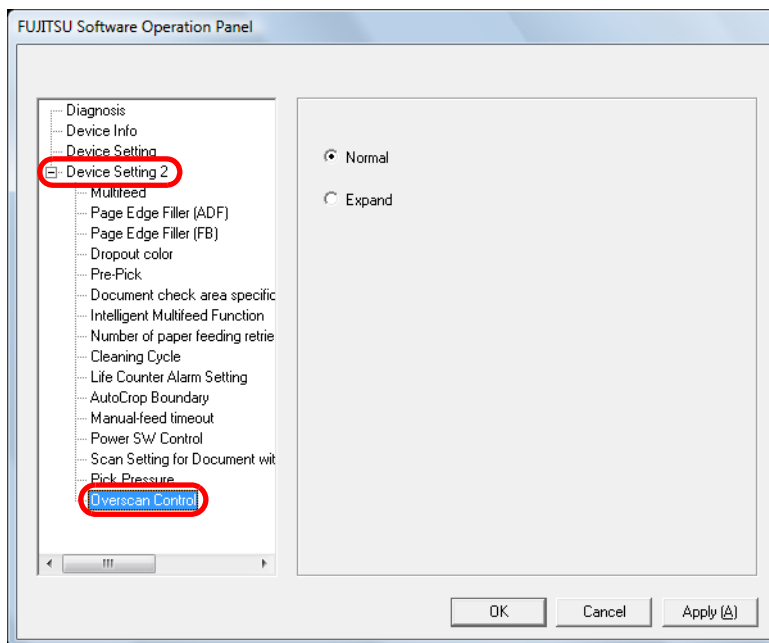

This setting does NOT appear when Kofax VRS is used.



- The scanning speed slows down when this function is enabled.
- It is recommended to specify the maximum size of scannable documents.

8.9 Paper feeding retry times

Specify the paper feeding (picking) retry times.

- 1 Start up the Software Operation Panel.
Refer to "8.1 Starting Up the Software Operation Panel" (on page 139).
- 2 From the tree listing on the left, select [Device Setting 2]
⇒ [Number of paper feeding retries].

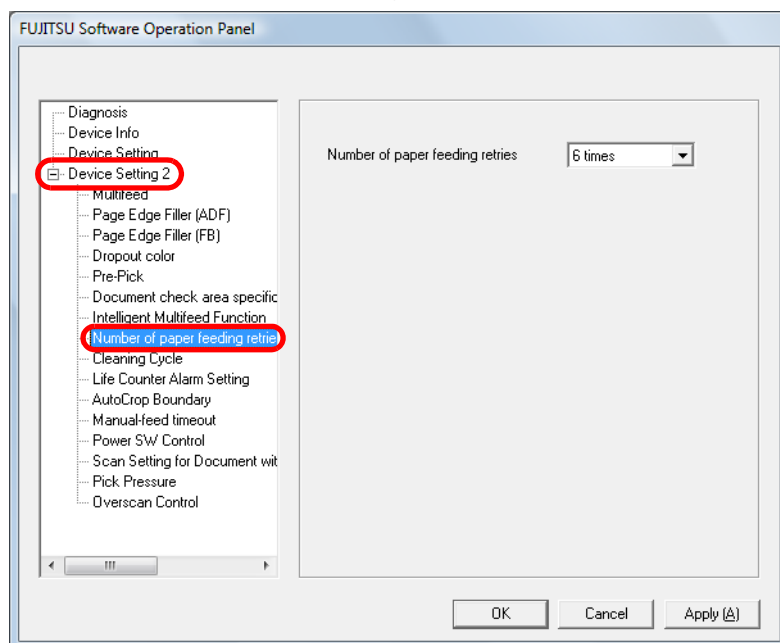

- 3 Specify retry times from 1 to 8.

Appendix

This section provides the following information:

A.1 Basic Specification	175
A.2 Installation Specification.....	177
A.3 Outer Dimensions	178
A.4 Scanner Options	180
A.5 Uninstalling the Software	181

[TOP](#)

[Contents](#)

[Index](#)

[Introduction](#)

[Scanner
Overview](#)

[Loading
Documents](#)

[Scan
Parameters](#)

[Various
Documents](#)

[Daily Care](#)

[Consumables](#)

[Trouble-
shooting](#)

[Operational
Settings](#)

[Appendix](#)

[Glossary](#)

A.1 Basic Specification

Item		Specification			Note
Scanner model		fi-6670/fi-6670A	fi-6770/fi-6770A	fi-6750S	--
Scanner type		ADF (automatic document feeder)	ADF+ flatbed	ADF+ flatbed	--
Image sensor		Color CCD x 2 (Front, Back)	Color CCD x 3 (Front, Back, Flatbed)	Color CCD x 2 (Front, Flatbed)	--
Light source		White cold cathode fluorescent lamp x 2 (Front, Back)	White cold cathode fluorescent lamp x 3 (Front, Back, Flatbed)	White cold cathode fluorescent lamp x 2 (Front, Flatbed)	--
Scanning area	Minimum	ADF	A8 portrait (*1)		127 to 209 g/m ² (34 to 56.1 lb)
	Maximum	ADF	A3 or Double Letter		--
		Long page	118.11 in. or 3 m		(*2)
		Flatbed	--	12.00 x 180.00 in. (304.8 x 457.2 mm)	
Paper weight		A4/Letter or smaller: 31 to 209 g/m ² (8.3 to 56.1 lb) Size larger than A4/Letter: 52 to 209 g/m ² (14.0 to 56.1 lb) A8: 127 to 209 g/m ² (34 to 56.1 lb)			(*3)
Scanning speed (A4/Letter, landscape) (*4)	Binary (monochrome)	Simplex: 90 sheets/min.; Duplex: 180 pages/min.		Simplex: 72 sheets/min.	at 200 dpi
	Grayscale				
	Color				
	Binary (monochrome)	Simplex: 80 sheets/min.; Duplex: 160 pages/min.		Simplex: 72 sheets/min.	at 300 dpi
	Grayscale				
	Color				

Item		Specification			Note
Scanner model		fi-6670/fi-6670A	fi-6770/fi-6770A	fi-6750S	--
Capacity of ADF		200 sheets			A4/Letter, 80 g/m ² (20 lb) (*5)
Optical resolution		600 dpi			--
Output resolution	Binary (monochrome)	50 to 600 dpi			Scalable in 1 dpi increments
	Grayscale	50 to 600 dpi			Scalable in 1 dpi increments
	Color	50 to 600 dpi			Scalable in 1 dpi increments
Grayscale level		8 bits per color			10 bits per color for internal processing
Halftone pattern		Dither/error diffusion			--
Interface (*6) (*7)		USB2.0/1.1 (*8)			B type
		Ultra SCSI	--		Shielded 50-pin high-density type
		Ultra Wide SCSI (fi-6670A/fi-6770A only)	--		Shielded 68-pin high-density type
Other function		Hardware real-time JPEG compression			Grayscale/color

*1 : For scanning with the ADF only. With the Flatbed, there is no minimum size limitation.

*2 : For a document longer than 864 mm or 34.02 inches, you need to specify a resolution of 200 dpi or less.

*3 : Values measured when using the ADF. There is no limit of paper weight when document is scanned with the Flatbed.

*4 : The maximum hardware limitation. Software processing time such as data transfer time is added to the actual scanning time.

*5 : The maximum capacity varies depending on the paper weight. For details, refer to ["2.2 ADF-Loaded Documents" \(on page42\)](#).

*6 : You cannot use both SCSI and USB 2.0/1.1 interfaces at the same time.

*7 : You cannot connect multiple computers to the scanner using each type of interface cables at the same time.

*8 : If you connect the scanner with USB 2.0, it is required that the USB port and the Hub are compliant with USB2.0. The scanning speed may slow down when you connect the scanner with USB1.1.

A.2 Installation Specification

Item		Specification		
Scanner model		fi-6670/fi-6670A	fi-6770/fi-6770A	fi-6750S
Outer dimensions (width x depth x height) (*1)		641 x 432 x 300 mm ("2) (25.2 x 17.0 x 11.8 in.)	690 x 500 x 342 mm (27.2 x 19.7 x 13.5 in.)	
Installation space (width x depth x height) (*3)		1179 x 686 x 390 mm (46.4 x 27.0 x 15.4 in.)	1030 x 700 x 640 mm (40.6 x 27.6 x 25.2 in.)	
Weight		17 kg (37.5 lb)	35 kg (77.2 lb)	
Input power	Voltage range	100 to 240 Vac \pm 10%		
	Phase	Single phase		
	Frequency range	50/60 \pm 3 Hz		
Power consumption	Operating	216 W or less		
	Power saving	fi-6670 : 6 W or less fi-6670A : 9.1 W or less	fi-6770 : 6 W or less fi-6770A : 9.1 W or less	fi-6750S : 6 W or less
Ambient condition	Temperature	Operating : 5 to 35°C (41 to 95°F); Non-operating: -20 to 60°C (-4 to +140°F)		
	Humidity	Operating: 20 to 80%; Non-operating: 8 to 95%		
Calorific value	Operating	186 Kcal/Hr or less		
	Power saving	fi-6670 : 5.2 Kcal/Hr or less fi-6670A : 7.8 Kcal/Hr or less	fi-6770 : 5.2 Kcal/Hr or less fi-6770A : 7.8 Kcal/Hr or less	fi-6750S : 5.2 Kcal/Hr or less
Shipping weight		25 kg (55. 1 lb)	44 kg (97.0 lb)	

*1 : The depth excludes the ADF Paper Chute and Stacker dimensions.

*2 : The width excludes the Operator Panel dimensions.

*3 : Reference values necessary for scanning A4/Letter sized documents.

A.3 Outer Dimensions

The outer dimensions are as follows:

ADF type

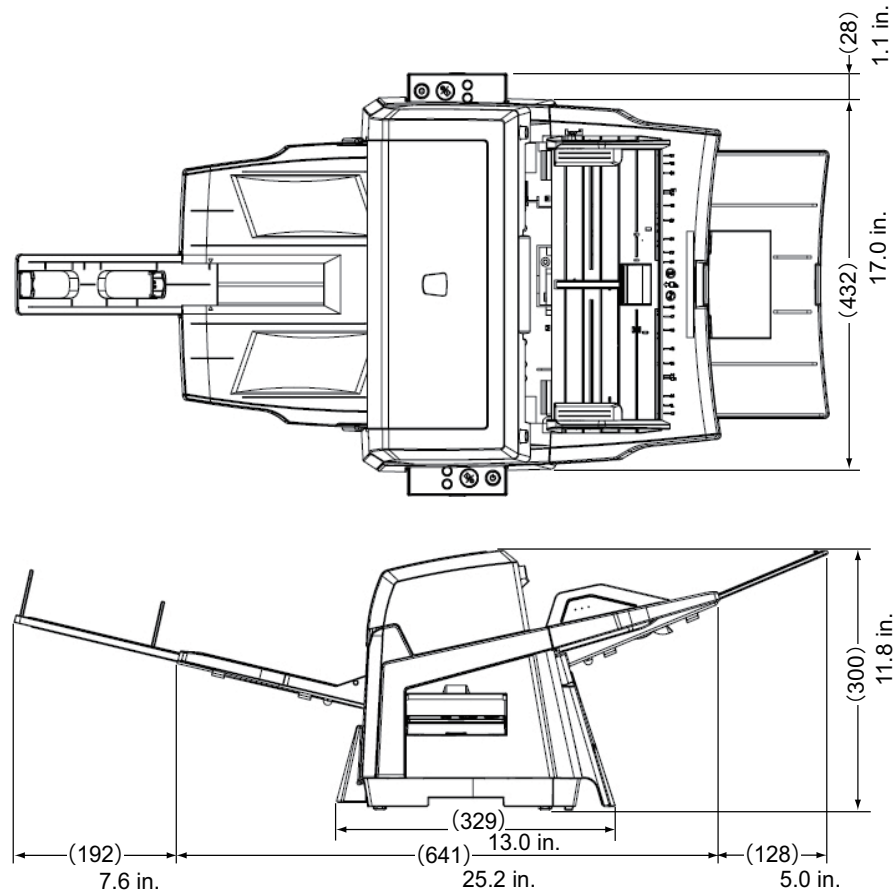

(Unit: mm/inches)

TOP

Contents

Index

Introduction

Scanner
Overview

Loading
Documents

Scan
Parameters

Various
Documents

Daily Care

Consumables

Trouble-
shooting

Operational
Settings

Appendix

Glossary

Flatbed type

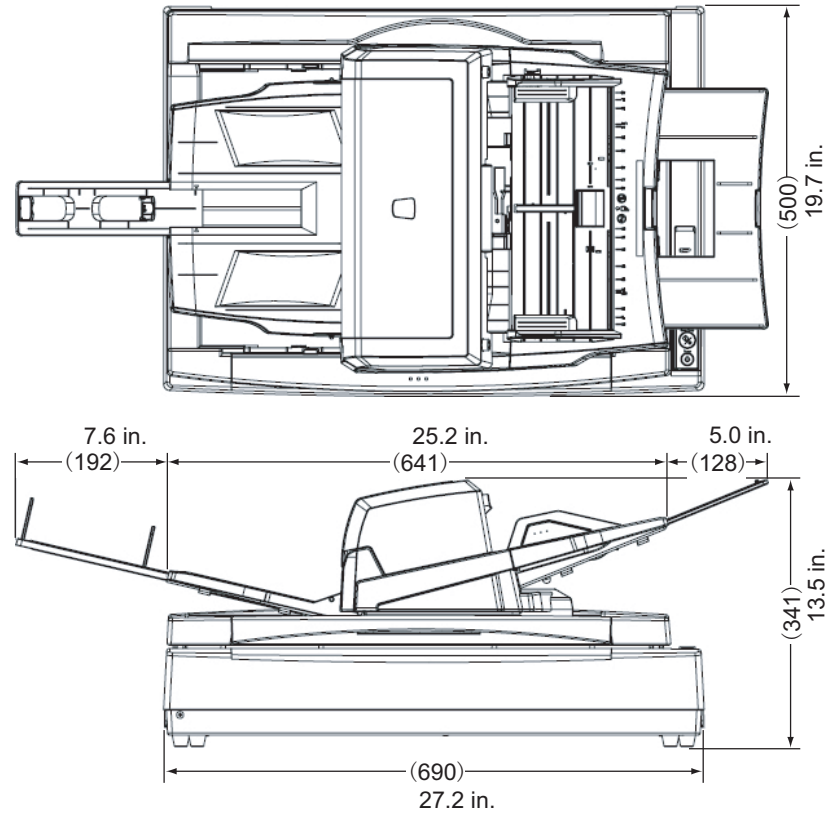

(Unit: mm/inches)

TOP

Contents

Index

Introduction

Scanner Overview

Loading Documents

Scan Parameters

Various Documents

Daily Care

Consumables

Troubleshooting

Operational Settings

Appendix

Glossary

A.4 Scanner Options

Product Name	Model	P/N	Scanner	Description
Imprinter	FI-667PR	PA03576-D101	fi-6670 fi-6670A	An imprinter option available for the ADF-type scanner model. Prints alphanumeric character string onto the back side of scanned document. Use of this imprinter prints user's name, date, and/or serial number for file management.
Black Document Pad	FI-575BK	PA03338-D960	fi-6770 fi-6770A fi-6750S	A quick-replacement-type document pad useful for scanning documents in black background when loading from the flatbed.
VRS option	FI-677CGA	PA03576-K001	fi-6670 fi-6770	An image processing hardware option for FUJITSU image scanner fi-series. Combined use of this with dedicated application "Kofax® VRS" achieves advanced image processing at a high speed. Built into the fi-6670A/fi-6770A as the standard feature.

For details, contact the store where you purchased the scanner or an authorized FUJITSU scanner service provider.

TOP

Contents

Index

Introduction

Scanner
OverviewLoading
DocumentsScan
ParametersVarious
Documents

Daily Care

Consumables

Trouble-
shootingOperational
Settings

Appendix

Glossary

A.5 Uninstalling the Software

1 Start your computer.



Be sure to log on as a user with "Administrator" privileges.

2 Exit all applications.

3 Select the [start] menu ⇒ [Control Panel] ⇒ [Uninstall a program].

⇒ In the [Uninstall or change a program] window, you can view a list of installed applications.



Displays may vary depending on the operating system you are using. Follow the on-screen instructions on your desktop.

Windows 2000:

- [Uninstall a program] ⇒ [Add/Remove Applications]
- [Uninstall] or [Uninstall/Change] button ⇒ [Add/Remove] button

Windows XP:

- [Uninstall a program] ⇒ [Add or Remove Programs]
- [Uninstall] or [Uninstall/Change] button ⇒ [Change/Remove] button

4 Select the target application as follows:

- To remove the TWAIN scanner driver, select: [Scanner Utility for Microsoft Windows]
- To remove ScandAll PRO, select: [Fujitsu ScandAll PRO]
After ScandAll PRO and ScandAll PRO ScanSnap mode Add-in, you can also remove Scan to Microsoft SharePoint and ABBYY FineReader for ScanSnap™.

- ScandAll PRO ScanSnap mode Add-in: [Fujitsu ScandAll PRO ScanSnap mode Add-in]
- To remove Scan to Microsoft SharePoint, select: [Scan to Microsoft SharePoint]
- ABBYY FineReader for ScanSnap™: [ABBYY FineReader for ScanSnap(TM)]
- To remove the ISIS scanner driver, select: [ISIS Driver Bundle Installer for fi Series Scanners]
- To remove the Error Recovery Guide, select: [Error Recovery Guide for fi-6670(A)/fi-6770(A)/fi-6750S]
- To remove the Software Operation Panel, select: [Software Operation Panel]
(Installed automatically when the TWAIN and ISIS scanner drivers are installed.)
- To remove the Kofax VRS, select: [Kofax VRS]
- To remove the manuals, select: [fi-Scanner manuals fi-6670(A)/fi-6770(A)/fi-6750S]
- To remove Quick Scan Pro™, select: [Quick Scan]
- Scanner Central Admin Agent: Uninstall by referring to the Scanner Central Admin 4.0 User's Guide.
- To remove Adobe Acrobat, select: [Adobe Acrobat Standard]



For how to uninstall Image Processing Software Option (Trial version), refer to "Image Processing Software Option User's Guide."

5 Click the [Uninstall] or [Uninstall/Change] button.

6 When you see a confirmation message, click the [OK] button or the [Yes] button.

⇒ Upon clicking the button, uninstallation is started.

Glossary

A

A4 size
 A5 size
 A6 size
 A7 size
 A8 size
 ADF (Automatic Document Feeder)
 Automatic separation
 Automatic size/skew detection

B

Brake roller
 Brightness

C

Canadian DOC Regulations
 CCD (Charged Coupling Device) Image Sensor
 Color balance

D

Default settings
 Density
 Dither
 Document jam
 Dpi
 Driver software
 Dropout color
 Duplex reading mode

E

Eject rollers
 Energy Star
 Equipment Error
 Error diffusion

F

FCC
 Feed rollers
 Filtering
 Flat bed

G

Gamma
 Gray scale

H

Halftone processing

I

Image emphasis
 Image processing
 Interface
 Inversion (Reverse-image reading)
 IPC preset mode
 ISIS (Image Scanner Interface Specification)

J

Jaggy images
 Job separation sheet

L

Landscape
 Landscape orientation
 Letter size
 Linedrawing mode

M

Mirror image
 Moire Patterns
 Multifeed detection

N

Noise removal

O

OCR (optical character recognition)
 Operating temperature/humidity
 Operator Panel
 Optical sensor
 Outline extraction

[TOP](#)
[Contents](#)
[Index](#)
[Introduction](#)
[Scanner Overview](#)
[Loading Documents](#)
[Scan Parameters](#)
[Various Documents](#)
[Daily Care](#)
[Consumables](#)
[Troubleshooting](#)
[Operational Settings](#)
[Appendix](#)
[Glossary](#)

P

Pad ASSY (Pad Assembly)

Photograph mode (White level follower OFF)

Pick roller

Pick start time

Pixel (Picture Element)

Portrait

Portrait orientation

R

Resolution

S

SCSI (Small Computer System Interface)

SCSI-ID

Separation roller

Simplex reading mode

Smoothing

Storage temperature/humidity

T

Temporary Error

Terminator

Third Party Interface

Threshold

TÜV

TWAIN (Technology Without Any Interesting Name)

U

Ultrasonic sensor

USB (Universal Serial Bus)

W

White level follower

White Reference Stripe

Numbers

11 x 17 inches

[TOP](#)

[Contents](#)

[Index](#)

[Introduction](#)

[Scanner Overview](#)

[Loading Documents](#)

[Scan Parameters](#)

[Various Documents](#)

[Daily Care](#)

[Consumables](#)

[Troubleshooting](#)

[Operational Settings](#)

[Appendix](#)

[Glossary](#)

A

A4 size

A standard paper size. Paper size is 210 x 297 mm.

A5 size

A standard paper size. Paper size is 148 x 210 mm.

A6 size

A standard paper size. Paper size is 105 x 148 mm.

A7 size

A standard paper size. Paper size is 74 x 105 mm.

A8 size

A standard paper size. Paper size is 53 x 74 mm.

ADF (Automatic Document Feeder)

A unit that allows the user to scan a number of pages consecutively. Fed documents are transported from the ADF paper chute (or hopper) to the Stacker. Actual scanning operation is executed by the mechanism inside of this unit.

Automatic separation

An image processing method in which the scanner automatically detects difference between text and photos, and chooses the threshold accordingly. This function allows the scanner to switch between line mode and half tone mode in one pass.

Automatic size/skew detection

A function that automatically detects the documents' page size and adjusts output data to the detected page size. Document skewing is automatically detected and corrected for the output image.

[TOP](#)[Contents](#)[Index](#)[Introduction](#)[Scanner
Overview](#)[Loading
Documents](#)[Scan
Parameters](#)[Various
Documents](#)[Daily Care](#)[Consumables](#)[Trouble-
shooting](#)[Operational
Settings](#)[Appendix](#)[Glossary](#)

B

Brake roller

A roller that prevents two or more sheets of paper from being fed simultaneously into the ADF.

Brightness

Refers to the brightness of scanned images in this manual.

C

Canadian DOC Regulations

"A standard issued by Industry Canada, a department of the Canadian government, which sets out the technical requirements relative to the radiated and conducted radio noise emissions from digital apparatus."

CCD (Charged Coupling Device) Image Sensor

A semiconductor device inside the scanner that registers light reflected from the original image and converts it into a digitized (electronic) form. CCD technology is the basis of high-quality image acquisition in scanners, cameras, and other specialized devices.

Color balance

Balance of colors in images.

D

Default settings

Pre-set values for optional menus.

Density

Scale of color's depths in images. In this manual, refers to a measurement of the depth of the display.

Dither

The process by which a group of dots is arranged to represent a shade of gray. The predetermined dot pattern simulates shades of gray. This scanning process offers the advantage of reduce memory requirements compared to multilevel gray.

Document jam

A warning that appears when document is jammed in the transport unit, or transportation is interrupted because the paper is slipping.

Dpi

Dots per inch. Number of dots lined along one inch. A measurement of resolution normally used for scanners and printers. Higher dpi means better resolution.

Driver software

In this manual, driver software refers to software that allows the scanning application software to communicate with the scanner.

Dropout color

A color which is used in the document but does not appear in the read image.

Duplex reading mode

A mode for scanning both sides of the document in one pass.

E

Eject rollers

Rollers that transport documents from the ADF onto the Stacker.

Energy Star

ENERGY STAR is an international standard for energy-efficient electronic equipment. It was created by the US Environment Protection Agency (EPA) in 1992. The standard program has now been adopted by several countries around the world.

Equipment Error

An error that cannot be fixed by the operator. The operator should call the manufacturer for service.

Error diffusion

High-quality halftone (pseudo-grayscale) image production based on black-and-white pixel binarization. A pixel's optical density and that of adjacent pixels are summed, with black pixels relocated in their order of density as they relate to adjacent pixels. The purpose of this technique is to minimize the average error between read and printed densities. Density data for

adjacent pixels is modified by diffusing errors on the objective pixel into several pixels, which are then binarized. This maintains high grayscale levels and resolution during reading, while suppressing more patterns by dotted halftone images such as newspaper photographs.

F

FCC

Acronym for "The Federal Communications Commission", an independent United States government agency which is in charge of regulating interstate and international communications via radio, television, wire, satellite and cable. The Part 15 of the FCC regulations mentioned in this manual is designed to prevent harmful interferences on radio communication of radio receivers and other devices which radiate radio frequency energy, and provides for the certification of radio receivers. It also provides the certification of low power transmitters and the operation of certificated transmitters without a license.

Feed rollers

Rollers that feed documents through the ADF.

Filtering

A correction method that improves the read quality of handwritten documents. The read quality of images written in pencil or ball-pointed pen depends on the reflective light characteristics of the specific ink or lead used. Dropped pixels may produce outlines, gaps, or thin, barely connected lines due to uneven optical density. Filtering detects areas lighter than their surroundings and increases their density to improve image clarity.

Flat bed

An input device of the scanner, where documents are placed and scanned. Generally used for scanning pages out of a book, or paper that is out of the feeding specification of the ADF. Also used to scan a small volume of documents by manual operation.

G

Gamma

A unit of changes of images' brightness. It is expressed as a function of the electric input power to devices (scanner, display, etc.) and an image's brightness. If the gamma rate is larger than 1, the brightness of an image increases and vice versa. In order to adjust the brightness of an image close to the original, generally the gamma value is set to 1.

Gray scale

A method for realizing the gradation from black to white on the scanned image. For example, when scanning monochrome documents, the computer recognizes the documents as sets of black and white dots. In the Gray scale method, each dot contains data regarding density of black. The original gradation of the documents is realized as the gradation of the density data.B

H

Halftone processing

Any method used to reproduce a photograph which includes a shade as an image composed of dots, namely, a binary image. Dithering and error diffusion processing are examples of halftone processing.

I

Image emphasis

Density is decreased for lighter but not completely white areas adjacent to black areas. Weakening this emphasis eliminates spot noise or produces softened images.

Image processing

An image is scanned with specified parameters.

Interface

The connection that allows communication from the computer to the scanner.

Inversion (Reverse-image reading)

In reverse-image reading, data is changed from black to white and vice versa.

IPC preset mode

While reading binary images, it is necessary to set the scanner according to the quality of the sheet to be read. In this mode, these settings can be performed in advance by corresponding each setting to a pattern number.

ISIS (Image Scanner Interface Specification)

A standard of API (Application Program Interface) or protocol for imaging devices (scanners, digital cameras, etc.) developed by Pixel Translations, a division of Captiva Software. In order to use imaging devices designed on the ISIS standard, it is necessary to install the driver software of the same standard.

J

Jaggy images

Images that have sharp projections or irregular shape on their edges.

Job separation sheet

A sheet inserted between documents in a batch for separating different jobs.

L

Landscape

A document is transported and read with the Short side parallel to the moving direction.

Landscape orientation

A document is transported and scanned with the long side vertical to the moving direction.

Letter size

A standard paper size used in the U.S.A. and other countries. Paper size is 8-1/2 x 11 inches.

Linedrawing mode

Selecting linedrawing mode makes threshold and contrast settings effective but prevents brightness from being set. The specified threshold value determines whether black or white pixels are scanned. Line drawing mode is therefore appropriate for scanning text and line art images.

M

Mirror image

The read image is symmetrically flipped to produce a mirror image of the original detected in the main scanning direction.

Moire Patterns

Recurrent patterns on scanned images caused by incorrect settings of angles.

Multifeed detection

A scanner function which detects accidental feeding of multiple sheets into the ADF. This can be set as both enabled/disabled.

N

Noise removal

Isolated noise from an image appearing as black spots in white areas and voids in black areas is removed to improve image quality. Common noise includes toner and fax particles. Noise reduction works via an algorithm that removes pixels up to 5 x 5 dots apart. A dot is 1/400 inch. A particle can be distinguished from a character as it is not connected to another dot within 5 pixels.

O

OCR (optical character recognition)

Devices or technologies for identifying characters on documents and converting them into text data that can be manipulated. The documents are checked by light and the differences of light reflection are recognized as character shapes.

Operating temperature/humidity

The temperature and humidity levels needed to assure the proper operation of the scanner.

Operator Panel

A panel consists of indicators and buttons. The operator panel is used to control scanner operations such as, selecting features, and changing settings.

Optical sensor

A type of sensor for detecting multi feeding by light transmission. It also detects multi feeding by recognizing differences in length of documents.

Outline extraction

The boundary between black and white areas is traced and the outline extracted for closed areas.

P

Pad ASSY (Pad Assembly)

This part is used to separate a sheet of paper from a batch before feeding documents into the ADF. This assembly is made out of rubber.

Photograph mode (White level follower OFF)

Selecting photograph mode makes brightness and contrast settings effective but prevents the threshold from being set. With photograph mode, the darkness of image corresponds to the black-pixel density, making it suitable in scanning images such as photographs having gradations.

Pick roller

Roller(s) that picks the page from the batch of paper in the paper chute and feed it into the ADF.

Pick start time

The period from the manual insertion of the document until picking starts after the document passes the hopper empty sensor.

Pixel (Picture Element)

The tiny dots that make up a scanned image.

Portrait

Orientation of documents or images. Documents/images are set or displayed vertically.

Portrait orientation

A document is transported and read with the long side parallel to the moving direction.

R

Resolution

The measure of the details or grain of images displayed on a computer screen. As a metric of the resolution, dpi is customarily used.

S

SCSI (Small Computer System Interface)

An abbreviation for "Small Computer System Interface". SCSI is a standard for interfaces, used to connect devices such as hard disks, scanners, etc. Up to seven devices can be connected through this interface (daisy chain). The data transfer rates are different between "Fast SCSI" (Max. 10MB/sec.) and "Wide SCSI" (Max. 20MB/sec.).

SCSI-ID

Used to specify a particular SCSI device when the initiator selects a target or the target reconnects to the initiator.

Separation roller

A roller that separates the sheets of paper from each other.

Simplex reading mode

A mode for scanning only the front side of the document.

Smoothing

A process that eliminates "jaggies" from slanted lines and curves. Irregular convexities are deleted and irregular concavities filled in. This is useful in OCR applications, for example.

Storage temperature/humidity

The temperature and humidity levels necessary for proper storage of the scanner.

T

Temporary Error

An error that can be fixed by the operator.

Terminator

Devices with a SCSI interface can be daisy-chained. A resistor that includes terminal circuits needs to be placed at both ends of the SCSI chain when devices are daisy-chained. If a device (such as a scanner) is the last device in a chain, leaving an interface connector unused, a Terminator therefore must be attached to provide those terminal circuits.

Third Party Interface

Used to install optional board provided by Fujitsu or interface board manufactured by a third party.

Threshold

A value used as a metric for judging a color as black or white. For scanning an image with gray gradation, this value must be defined. The threshold setting determines which pixels are converted to black and which will become white.

TÜV

"An institution that controls products for conformity with various standards of security, usability and environmental matters."

TWAIN (Technology Without Any Interesting Name)

A standard for API (Application Program Interface) or protocol for imaging devices (scanners, digital cameras, etc.) developed by TWAIN Working Group. In order to use devices that comply with this standard, it is necessary to install driver software based on the same standard.

U

Ultrasonic sensor

A type of sensor for detecting multi feeding by ultrasonic sound. Scanners detect multi feeding by recognizing differences in the amount of ultrasonic waves that penetrates the documents.

USB (Universal Serial Bus)

An abbreviation for "Universal Serial Bus". A standard for interfaces used to connect devices such as key boards, scanners, etc. Up to 127 devices can be connected through this interface. USB devices can be plugged/unplugged without turning off their power. Data transfer rates are different between the "Low speed mode" (1.5Mbps) and "High speed mode" (Max. 12Mbps).

W

White level follower

A function to correct the difference between white colors in unbleached paper (e.g. wood containing paper, etc.) and in scanned images.

White Reference Stripe

The white part located in the ADF that defines the lightest area in an image, causing all other areas to be adjusted accordingly.

Numbers

11 x 17 inches

A standard paper size used in the U.S.A. and other countries. Paper size is 11 x 17 inches.

TOP

Contents

Index

Introduction

Scanner
Overview

Loading
Documents

Scan
Parameters

Various
Documents

Daily Care

Consumables

Trouble-
shooting

Operational
Settings

Appendix

Glossary

Index

A		
	ADF-Loaded Documents	42
	Advanced Scanning.....	67
B		
	Basic Flow of Scanning Documents.....	33
	Basic Specification	175
	Before Contacting Your Dealer or Scanner Service Provider.....	135
C		
	Changing the ADF Position	48
	Checking Labels on the Scanner.....	137
	Cleaning Materials and Locations Requiring Cleaning...	98
	Cleaning the ADF	100
	Cleaning the Flatbed (Flatbed Type Only).....	105
	Configurable Items	140
	Consumables.....	106
	Consumables and the Replacement Cycles.....	107
	Conventions.....	8
	Customizing the Hardware Settings	90
D		
	Daily Care.....	97
E		
	Errors Indicated on the Operator Panel.....	115
F		
	Features	21
	Functions of the Operator Panels.....	28
H		
	How to Use This Manual	2
I		
	Installation Specification.....	177
	Introduction.....	3
	ISIS Scanner Driver.....	55
L		
	Loading Documents	38
	Loading Documents on the ADF	39
	Loading Documents on the Flatbed (Flatbed Type Only)	50
O		
	Options	180
	Outer Dimensions.....	178
	Overscan Control	172
P		
	Paper feeding retry times	173
	Paper Jams	113
	Power ON/OFF Control	171
	Power Save Mode	32
	Power SW Control.....	171
	Precautions	10

TOP

Contents

Index

Introduction

Scanner
OverviewLoading
DocumentsScan
ParametersVarious
Documents

Daily Care

Consumables

Trouble-
shootingOperational
Settings

Appendix

Glossary

R

Regulatory Information	6
Replacing the Brake Roller	110
Replacing the Pick Rollers.....	108

S

Safety Information	12
Scan Parameters	51
Scanner Overview	20
Scanner Parts and Their Functions	22
Scanning Documents of Different Types or Sizes	63
Setting Post-Scan Operations and Handling	77
Settings Related to Consumables and Useful Life Counters	148
Settings Related to Multifeed Detection	163
Settings Related to Power ON/OFF Control.....	171
Settings Related to Scanning	152
Settings Related to Wait Time	169
Starting Up the Software Operation Panel	139
Summary	62

T

Troubleshooting.....	112, 119
Turning the Scanner On and Off	31
TWAIN Scanner Driver	52

U

Uninstalling the Software.....	181
--------------------------------	-----

V

Various Scans	61
---------------------	----

[TOP](#)[Contents](#)[Index](#)[Introduction](#)[Scanner
Overview](#)[Loading
Documents](#)[Scan
Parameters](#)[Various
Documents](#)[Daily Care](#)[Consumables](#)[Trouble-
shooting](#)[Operational
Settings](#)[Appendix](#)[Glossary](#)

fi-6670(A)/fi-6770(A)/fi-6750S Image Scanner

Operator's Guide

P3PC-2252-05ENZ0

Issue Date: October 2011

Issued by: PFU LIMITED

- Copying of the contents of this manual in whole or in part and copying of the scanner applications is prohibited under the copyright.
- The contents of this manual are subject to change without notice.
- PFU LIMITED is not liable whatsoever for any damages resulting from use of this scanner and procedures described in this manual, profit due to defects, and any claims by a third party.