

ScanSnap
iX500

Basic Operation Guide

(Windows)

Contents

| | |
|--|----|
| About This Manual | 4 |
| Safety Information..... | 5 |
| Manuals | 6 |
| Trademarks..... | 10 |
| Manufacturer..... | 11 |
| Symbols Used in This Manual..... | 12 |
| Arrow Symbols in This Manual..... | 13 |
| Screen Examples in This Manual | 14 |
| Abbreviations Used in This Manual | 15 |
| What You Can Do with the ScanSnap | 17 |
| Scanning a Document..... | 19 |
| Scanning a Long Page..... | 25 |
| Scanning Documents of Different Widths or Lengths in One Batch..... | 29 |
| ScanSnap Overview..... | 35 |
| Parts and Functions | 36 |
| System Requirements | 38 |
| Overview of the Software Related to the ScanSnap..... | 40 |
| How to Install the Software..... | 41 |
| ScanSnap Manager Icon..... | 42 |
| Right-Click Menu | 43 |
| ScanSnap Setup Window | 45 |
| Turning the ScanSnap On or Off..... | 46 |
| Turning the ScanSnap On..... | 47 |
| Turning the ScanSnap Off..... | 49 |
| Sleep Mode..... | 50 |
| Automatic Power OFF | 51 |
| Connecting the ScanSnap via Wireless LAN..... | 52 |
| Preparation | 53 |
| Setting a Wireless LAN Using the ScanSnap Wireless Setup Tool..... | 54 |
| Connecting the ScanSnap to a Computer..... | 55 |
| Connecting the ScanSnap to a Mobile Device..... | 57 |
| Reconnecting to a Wireless Access Point Using the ScanSnap WPS Button..... | 58 |
| Documents to Scan..... | 60 |
| Documents That Can Be Loaded Directly into the ScanSnap..... | 61 |
| Documents That Can Be Scanned Using the Carrier Sheet | 63 |
| What You Can Do with Related Software | 65 |
| What You Can Do with the ScanSnap Organizer..... | 66 |
| Basic Operation Procedure of ScanSnap Organizer | 67 |
| Managing Files..... | 69 |
| Using Files..... | 71 |
| What You Can Do with CardMinder | 72 |
| Basic Operation Procedure of CardMinder | 74 |
| Linking Card Data with Other Applications..... | 77 |
| Searching Card Data with the Basic Search Toolbar..... | 78 |

| | |
|---|------------|
| Searching Card Data with CardMinder Viewer | 79 |
| Attaching a File to Card Data | 80 |
| Useful Usages | 81 |
| Managing Paper Documents by Folder on a Computer | 82 |
| Saving Business Cards to a Computer | 85 |
| Scanning Documents Larger Than A4 or Letter Size | 87 |
| Scanning Documents Such as Photographs and Clippings | 91 |
| Troubleshooting | 95 |
| How to Find Your Solution | 96 |
| If Your First Attempt to Install Failed | 97 |
| If You Have Installed the Software Before | 98 |
| Uninstalling the Software | 99 |
| Removing the Installation Information | 100 |
| Installing the Software from the [ScanSnap Setup] Window | 104 |
| Installing One Software at a Time | 105 |
| When the ScanSnap Manager Icon Does Not Appear | 106 |
| Displaying the ScanSnap Manager Icon | 107 |
| When ScanSnap Manager Does Not Operate Normally | 108 |
| Removing Unnecessary Icons from the Notification Area | 109 |
| Checking the Connection between the ScanSnap and the Computer | 110 |
| Checking If ScanSnap Manager Is Operating Normally | 111 |
| Removing the ScanSnap's Connection Information | 114 |
| When You Cannot Uninstall the Software | 116 |
| Cleaning | 117 |
| Cleaning Materials | 118 |
| Cleaning the Outside of the ScanSnap | 119 |
| Cleaning the Inside of the ScanSnap | 120 |
| Cleaning the Carrier Sheet | 124 |
| Consumables | 125 |
| Part Numbers and Replacement Cycle of Consumables | 126 |
| Checking the Status of Consumables | 127 |
| Replacing Consumables | 128 |
| Appendix | 134 |
| Updating the Software | 135 |
| Uninstalling the Software | 136 |
| Specifications of the Carrier Sheet | 138 |
| Specifications of Wireless LAN | 139 |
| Specifications of the ScanSnap | 140 |
| About Customer Support and Maintenance | 142 |

About This Manual

- "Safety Information" (page 5)
- "Manuals" (page 6)
- "Trademarks" (page 10)
- "Manufacturer" (page 11)
- "Symbols Used in This Manual" (page 12)
- "Arrow Symbols in This Manual" (page 13)
- "Screen Examples in This Manual" (page 14)
- "Abbreviations Used in This Manual" (page 15)

Safety Information

The attached "Safety Precautions" manual contains important information about the safe and correct use of the ScanSnap. Make sure that you read and understand it before using the ScanSnap.

Manuals

Read the following manuals according to your needs when using the ScanSnap.



Before Using the ScanSnap

| Manual | Description and Location |
|--------------------|---|
| Safety Precautions | <p>This manual contains important information about the safe use of the ScanSnap. Make sure you read this manual before using the ScanSnap.</p> <p>This manual is included in the package.</p> <p>In addition, after installing the software you can refer to this manual in the following procedure:</p> <ul style="list-style-type: none"> ● Windows 10 Select [Start] menu → [All apps] → [ScanSnap Manuals] → [iX500 Safety Precautions]. ● Windows 8.1 Click  on the lower left side of the Start screen, and select [iX500 Safety Precautions] under [ScanSnap Manuals] on the All apps screen. ● Windows 8 Right-click the Start screen, and select [All apps] on the app bar → [ScanSnap Manuals] → [iX500 Safety Precautions]. ● Windows 7/Windows Vista/Windows XP Select [Start] menu → [All Programs] → [ScanSnap Manuals] → [iX500 Safety Precautions]. |



When Setting Up the ScanSnap



| Manual | Description and Location |
|--------------------------------|---|
| ScanSnap iX500 Getting Started | <p>This manual explains the setup procedure from the moment you open the package to testing the operations.</p> <p>Getting Started is included in the package.</p> <p>In addition, after installing the software you can refer to this manual in the following procedure:</p> <ul style="list-style-type: none"> ● Windows 10 Select [Start] menu → [All apps] → [ScanSnap Manuals] → [iX500 Getting Started]. ● Windows 8.1 Click  on the lower left side of the Start screen, and select [iX500 Getting Started] under [ScanSnap Manuals] on the All apps screen. ● Windows 8 Right-click the Start screen, and select [All apps] on the app bar → [ScanSnap Manuals] → [iX500 Getting Started]. ● Windows 7/Windows Vista/Windows XP Select [Start] menu → [All Programs] → [ScanSnap Manuals] → [iX500 Getting Started]. |

When Operating the ScanSnap

| Manual | Description and Location |
|--|---|
| ScanSnap iX500 Basic Operation Guide (this manual) | This manual explains the basic operations and cleaning procedure for the ScanSnap. |
| ScanSnap Advanced Operation Guide | This manual describes operations including various scanning methods and useful usages of the ScanSnap. You can refer to this manual at the following website. http://www.pfu.fujitsu.com/imaging/downloads/manual/advanced/v62/en/common/index.html |
| ScanSnap Manager Help | This Help file describes the windows, operational troubles and the solutions, as well as messages of the ScanSnap Manager. This manual can be accessed by one of the following methods: <ul style="list-style-type: none"> ● Right-click the ScanSnap Manager icon  in the notification area located at the far right of the taskbar, and select [Help] → [Help] from the "Right-Click Menu" (page 43). ● Click the Help button () for ScanSnap Manager. ● Press the [F1] key on the keyboard while a window is displayed. ● Click the [Help] button in any window. |
| ScanSnap Wireless Setup Tool Help | This Help file explains about operations, operational troubles and their solutions, windows, and messages of the ScanSnap Wireless Setup Tool. This Help file can be accessed by one of the following methods: <ul style="list-style-type: none"> ● Press the [F1] key on the keyboard while a window is displayed. ● Click [About this screen] or [About this message] on each screen. |

When Saving Scanned Images to a Mobile Device



| Manual | Description and Location |
|---|---|
| ScanSnap Connect Application User's Guide (iOS) | This manual describes operations to be performed on an iOS-based mobile device when you save scanned images to the mobile device. This manual can be accessed by the following method: <ol style="list-style-type: none"> 1. Start up ScanSnap Connect Application on the mobile device. <ul style="list-style-type: none"> ⇒ The [File List] screen appears. 2. Tap the  button or the  button. <ul style="list-style-type: none"> ⇒ The [Information] screen appears. 3. Tap the [Help] button. |

| Manual | Description and Location |
|---|--|
| ScanSnap Connect Application User's Guide (Android) | <p>This manual describes operations to be performed on an Android-based mobile device when you save scanned images to the mobile device.</p> <p>This manual can be accessed by the following method:</p> <ol style="list-style-type: none"> 1. Start up ScanSnap Connect Application on the mobile device. <ul style="list-style-type: none"> ⇒ The [File List] screen appears. 2. Open the menu. <p>Perform one of the following operations:</p> <ul style="list-style-type: none"> ● Press the [Menu] button on the mobile device. ● Tap the [Menu] button displayed on the screen of the mobile device. ⇒ The menu appears. 3. Tap the  button or [Information]. <ul style="list-style-type: none"> ⇒ The [Information] screen appears. 4. Tap the [Help] button. |
| Scan to Mobile Help | <p>This Help file describes the operations, windows, and messages of Scan to Mobile. This Help file can be accessed by one of the following methods:</p> <ul style="list-style-type: none"> ● The [Scan to Mobile] icon is displayed in the menu that appears when you click  in the notification area located at the far right of the taskbar. Right-click the [Scan to Mobile] icon, and select [Help] from the menu that appears. ● Press the [F1] key on the keyboard while a window is displayed. ● Click the [Help] button in any window. |

When Updating the Software

| Manual | Description and Location |
|-----------------------------|---|
| ScanSnap Online Update Help | <p>This Help file describes the operations, windows, and messages of ScanSnap Online Update.</p> <p>This Help file can be accessed by one of the following methods:</p> <ul style="list-style-type: none"> ● Press the [F1] key on the keyboard while a window is displayed. ● Click the Help button in any window. |

When Using Related Applications

| Manual | Description and Location |
|-------------------------|--|
| ScanSnap Organizer Help | <p>This Help file describes the operations, windows, and messages of ScanSnap Organizer.</p> <p>This Help file can be accessed by one of the following methods:</p> <ul style="list-style-type: none"> ● Click the Help button () for ScanSnap Organizer. ● Press the [F1] key on the keyboard while a window is displayed. ● Click the [Help] button in any window. |
| CardMinder Help | <p>This Help file describes the operations, windows, and messages of CardMinder.</p> <p>This Help file can be accessed by one of the following methods:</p> <ul style="list-style-type: none"> ● Click the Help button () next to the Basic Search Toolbar. ● Press the [F1] key on the keyboard while a window is displayed. ● Click the [Help] button in any window. |

| Manual | Description and Location |
|--|---|
| ABBYY FineReader for ScanSnap User's Guide | This manual describes the overview and operations of ABBYY FineReader for ScanSnap. This Help file can be accessed by one of the following methods: <ul style="list-style-type: none">● Press the [F1] key on the keyboard while a window is displayed.● Click the [Help] button in any window. |
| Adobe Acrobat Help | This Help file can be accessed by selecting [Help] in the menu bar → [Online Support] in Adobe Acrobat. |

Trademarks

Microsoft, Windows, Windows Vista, Excel, PowerPoint, Outlook, SharePoint, Windows Live, Internet Explorer, and Entourage are either registered trademarks or trademarks of Microsoft Corporation in the United States and/or other countries.

Word is the product of Microsoft Corporation in the United States.

Apple, App Store, the Apple logo, Mac, Mac OS, OS X, iPad, iPhone, iPhoto, iPod touch, and iTunes are trademarks of Apple Inc.

Adobe, Acrobat, and Reader are either registered trademarks or trade names of Adobe Systems Incorporated in the United States and/or other countries.

Intel and Intel Core are registered trademarks or trademarks of Intel Corporation in the United States and other countries.

ABBYY™ FineReader™ Engine © ABBYY. OCR by ABBYY

ABBYY and FineReader are trademarks of ABBYY Software, Ltd. which may be registered in some jurisdictions.

Evernote is a registered trademark or trademark of Evernote Corporation.

Google, Google Docs, Android, and Google Play are registered trademarks or trademarks of Google Inc.

Salesforce, the Salesforce logo, and Salesforce CRM are registered trademarks or trademarks of salesforce.com, inc. in the United States and other countries.

Wi-Fi, Wi-Fi Protected Setup, and the Wi-Fi Protected Setup logo are trademarks of Wi-Fi Alliance.

Amazon is a trademark of Amazon.com, Inc. or its affiliates.

Besides the software authored by the product developer (PFU LIMITED), the ScanSnap contains other free software, such as software copyrighted under the GNU General Public License (GPL) or the GNU Lesser General Public License (LGPL). For details concerning the conditions of the licenses, refer to "Terms and Conditions for End User License" (file name: OSS_License.pdf) contained in the Setup DVD-ROM.

ScanSnap, the ScanSnap logo, ScanSnap Manager, ScanSnap Organizer, CardMinder, and Rack2-Filer are registered trademarks or trademarks of PFU LIMITED in Japan.

Other company names and product names are the registered trademarks or trademarks of the respective companies.

Manufacturer



PFU LIMITED

YOKOHAMA i-MARK PLACE, 4-4-5 Minatomirai, Nishi-ku, Yokohama, Kanagawa, 220-8567, Japan

© PFU LIMITED 2014-2015

Symbols Used in This Manual

The following indications are used in this manual to obviate any chance of accident or damage to you and people near you, and your property. Warning labels indicate the warning level and statements. The symbols indicating warning levels and their meanings are as follows.

| Indication | Description |
|---|--|
|  | This indication alerts operators of an operation that, if not strictly observed, may result in severe injury or death. |
|  | This indication alerts operators of an operation that, if not strictly observed, may result in safety hazards to personnel or damage to the product. |

Arrow Symbols in This Manual

Right-arrow symbols (→) are used to connect icons or menu options you should select in succession.

Example: Select [Start] menu → [Computer].



Screen Examples in This Manual



Microsoft product screenshots are reprinted with permission from Microsoft Corporation.

The screenshots used in this manual are of Windows 7.

The actual windows and operations may differ depending on the operating system.

Icon in the Notification Area

The ScanSnap Manager icon  is displayed in the menu which appears when you click  in the notification area.

To have the ScanSnap Manager icon  always displayed in the notification area, drag the icon  and drop it onto the notification area.

The notification area is located at the far right of the taskbar.

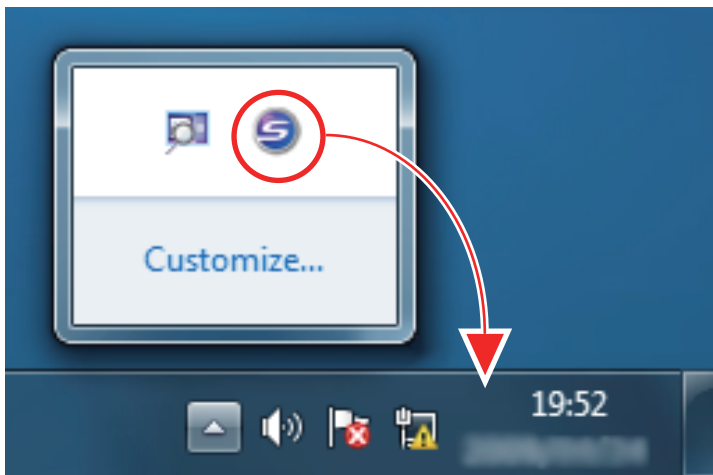

The explanations in this manual use the case in which the ScanSnap Manager icon  is always displayed in the notification area.

Abbreviations Used in This Manual

Also, the following abbreviations are used in this manual.

| Abbreviation Used | Designation |
|-------------------|---|
| Windows 10 | Windows® 10 Home operating system, English Version Windows® 10 Pro operating system, English Version Windows® 10 Enterprise operating system, English Version Windows® 10 Education operating system, English Version |
| Windows 8.1 | Windows® 8.1 operating system, English Version Windows® 8.1 Pro operating system, English Version Windows® 8.1 Enterprise operating system, English Version |
| Windows 8 | Windows® 8 operating system, English Version Windows® 8 Pro operating system, English Version Windows® 8 Enterprise operating system, English Version |
| Windows 7 | Windows® 7 Starter operating system, English Version Windows® 7 Home Premium operating system, English Version Windows® 7 Professional operating system, English Version Windows® 7 Enterprise operating system, English Version Windows® 7 Ultimate operating system, English Version |
| Windows Vista | Windows Vista® Home Basic operating system, English Version Windows Vista® Home Premium operating system, English Version Windows Vista® Business operating system, English Version Windows Vista® Enterprise operating system, English Version Windows Vista® Ultimate operating system, English Version |
| Windows XP | Windows® XP Home Edition operating system, English Version Windows® XP Professional operating system, English Version |
| Windows | Windows 10, Windows 8.1, Windows 8, Windows 7, Windows Vista, or Windows XP operating system |
| Microsoft Office | Microsoft® Office |
| Word | Microsoft® Word 2013 Microsoft® Word 2010 Microsoft® Office Word 2007 Microsoft® Office Word 2003 |
| Excel | Microsoft® Excel® 2013 Microsoft® Excel® 2010 Microsoft® Office Excel® 2007 Microsoft® Office Excel® 2003 |
| PowerPoint | Microsoft® PowerPoint® 2013 Microsoft® PowerPoint® 2010 Microsoft® Office PowerPoint® 2007 Microsoft® Office PowerPoint® 2003 |

| Abbreviation Used | Designation |
|-------------------------------|---|
| SharePoint | Microsoft® SharePoint® Server 2010, English Version Microsoft® Office SharePoint® Server 2007, English Version Microsoft® Office SharePoint® Portal Server 2003, English Version Microsoft® SharePoint® Foundation 2010, English Version Microsoft® Windows® SharePoint® Services 2.0/3.0, English Version |
| Internet Explorer | Windows® Internet Explorer® Microsoft® Internet Explorer® |
| Microsoft Edge | Microsoft® Edge |
| .NET Framework | Microsoft® .NET Framework |
| Adobe Acrobat | Adobe® Acrobat® Adobe® Acrobat® DC |
| ABBYY FineReader for ScanSnap | ABBYY FineReader for ScanSnap™ All the descriptions in this manual assume the usage of ABBYY FineReader for ScanSnap bundled with the ScanSnap. Unless otherwise specified, the term ABBYY FineReader for ScanSnap refers to the ABBYY FineReader for ScanSnap bundled with the ScanSnap. Note that ABBYY FineReader for ScanSnap may be upgraded without notice. If the descriptions in this manual differ from the actual displayed screens, refer to the ABBYY FineReader for ScanSnap User's Guide. |
| Google Docs | Google Docs™ |
| Android | Android™ |
| WPS | Wi-Fi Protected Setup™ |
| Wireless access point | Wireless access point Wireless router |
| ScanSnap | Color Image Scanner ScanSnap iX500 |
| Carrier Sheet | ScanSnap Carrier Sheet |

What You Can Do with the ScanSnap

Scanning Multiple Documents

A document stack with a thickness of 5 mm (0.2 in.) or less (for A4 or smaller sizes: up to 50 sheets with 80 g/m² [20 lb] paper weight) can be loaded into the ScanSnap for scanning.

For details, refer to ["Scanning a Document" \(page 19\)](#).

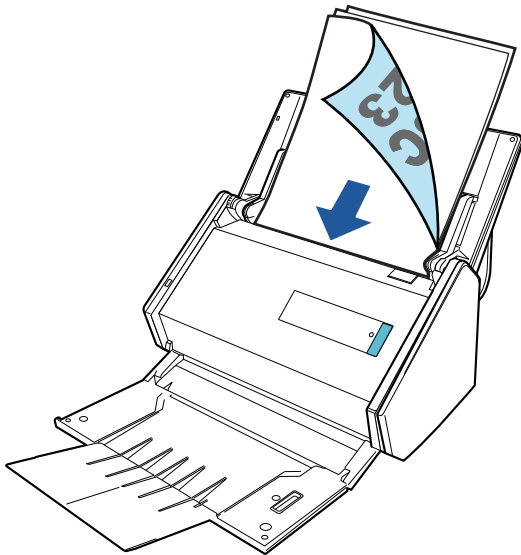

Scanning Documents That Cannot Be Loaded Directly in the ScanSnap

You can use the optional Carrier Sheet to scan the following documents.

- Documents that are larger than A4/Letter size and not larger than A3 size

For details, refer to ["Scanning Documents Larger Than A4 or Letter Size" \(page 87\)](#).

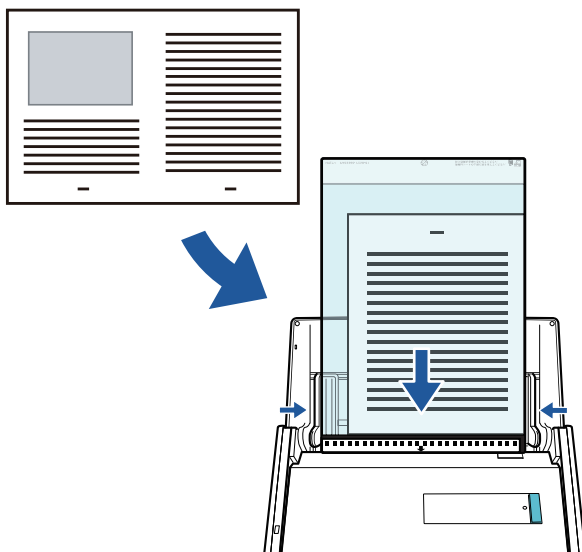

- Documents that can be damaged quite easily such as photographs, or non-standard size documents such as clippings

For details, refer to "Scanning Documents Such as Photographs and Clippings" (page 91).

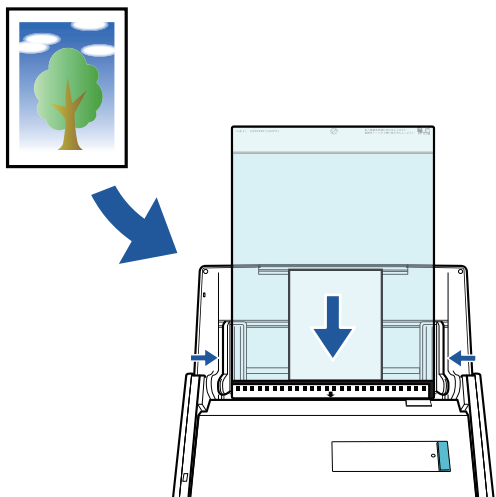

Connecting the ScanSnap via Wireless LAN

You can connect the ScanSnap and a computer or mobile device via wireless LAN.

To configure the wireless settings for the ScanSnap, use the ScanSnap Wireless Setup Tool, which is installed together with ScanSnap Manager.

For details, refer to "Connecting the ScanSnap via Wireless LAN" (page 52).

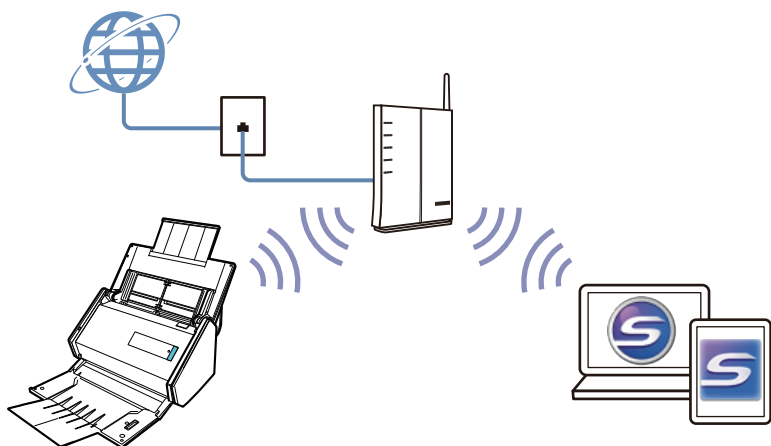

Scanning a Document

You can load documents such as handouts for meetings or business cards directly in the ScanSnap for scanning.

For details about documents that can be scanned, refer to "[Documents That Can Be Loaded Directly into the ScanSnap](#)" (page 61).

1. If you are loading multiple sheets, check the number of sheets.

The maximum number of sheets in the ScanSnap is as follows:

For A4 or smaller sizes: Up to 50 sheets can be loaded (with paper weight of 80 g/m² [20 lb] and thickness of the document stack under 5 mm [0.2 in.]).

ATTENTION

If you try to scan more than the maximum amount that can be loaded, the following problems may occur:

- Files cannot be properly created due to excessive file size.
- Paper jams occur during scanning.

2. Fan the documents.

1. Hold both ends of the documents and fan them a few times.

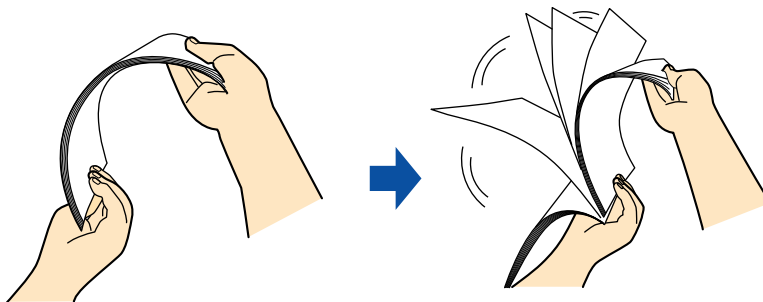

2. Rotate the documents 90 degrees and fan them in the same manner.

3. Straighten the edges of the documents and slightly displace the top edges at an angle.

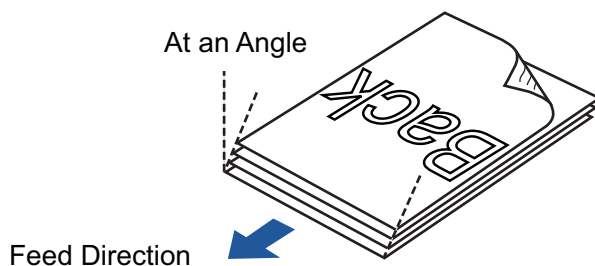



ATTENTION

Paper jams or damage to documents may occur if you scan the documents without aligning the edges first.

4. Open the ADF paper chute (cover) of the ScanSnap.

⇒ The [Scan] button flashes in blue. The button returns to being lit normally when document scanning is enabled.

In addition, the ScanSnap Manager icon in the notification area located at the far right of the taskbar changes from  to .

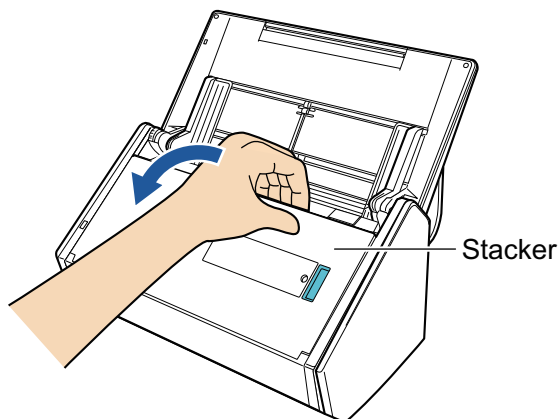
5. Pull the stacker towards you.**6. Depending on documents to scan, pull out the extension on the ADF paper chute (cover) and open the stacker.**

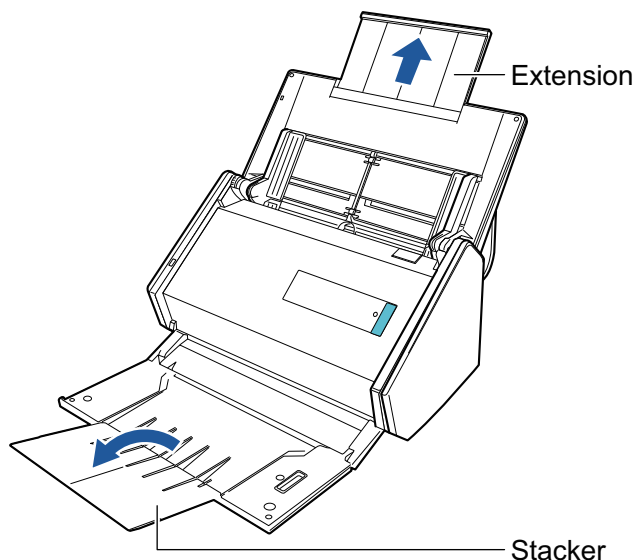

7. Load the documents in the ADF paper chute (cover).

Load the documents face-down and top-first with their back facing you. Adjust the number of documents so that they do not go beyond the reference marks and are kept within the side guides when they are loaded.

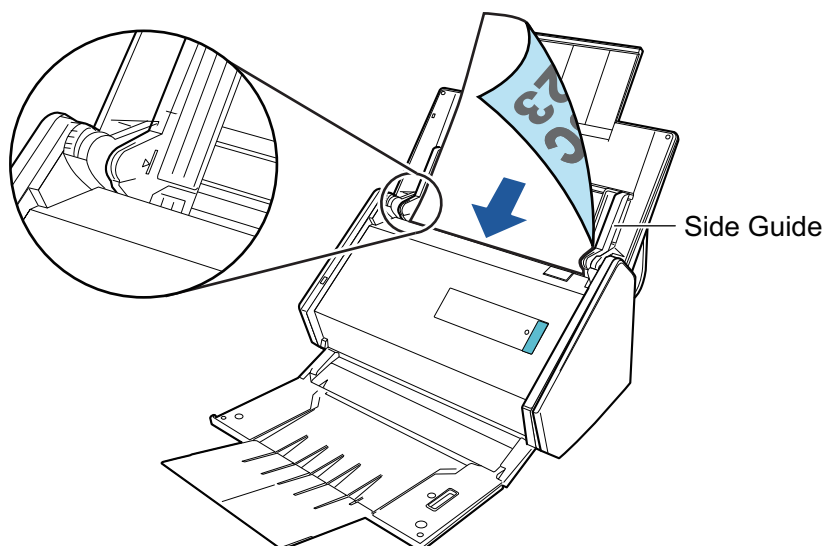

ATTENTION

- Do not accumulate more than 50 sheets (with paper weight of 80 g/m² [20 lb]) in the stacker.
- When the [Place document face up] checkbox is selected in the [Scanning mode option] window, load the documents face-up and bottom edge down.

To open the [Scanning mode option] window, click the [Option] button in the [Scanning] tab of the "ScanSnap Setup Window" (page 45).

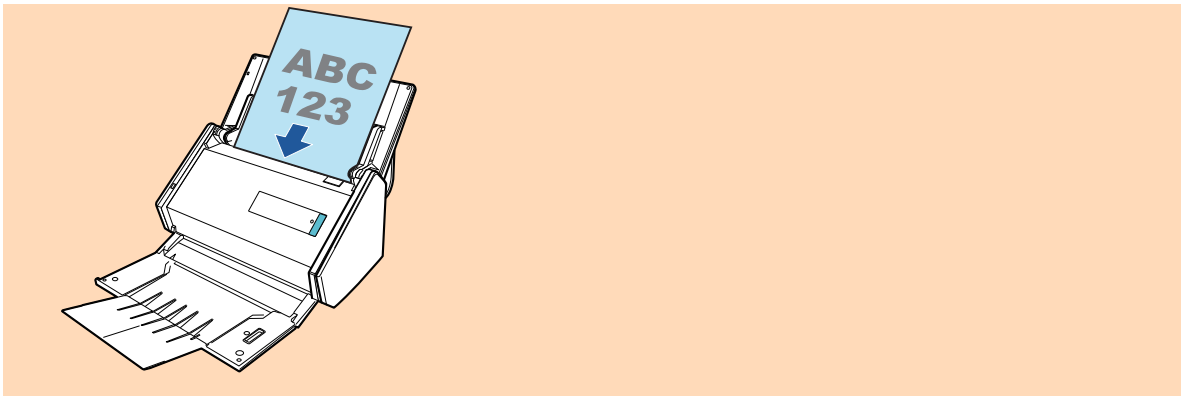

8. Adjust the side guides to the width of the documents.

Hold each side guide in the middle to adjust them. Otherwise, the documents may be fed skewed.

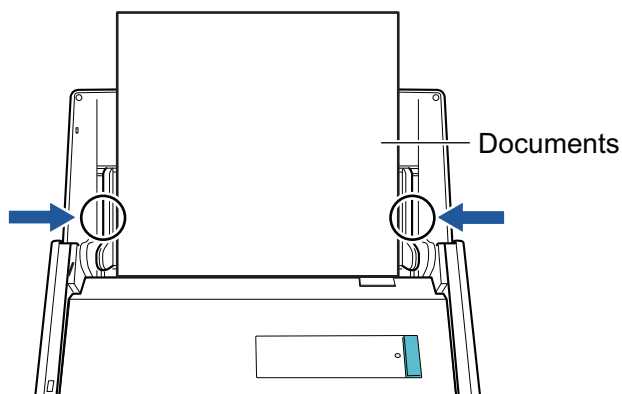

9. Press the [Scan] button on the ScanSnap to start a scan.

ATTENTION

Do not perform the following operations during scanning. Doing so will stop scanning.

- Connect or disconnect the ScanSnap and other USB devices.
- Close the ADF paper chute (cover).
- Switch users.
- Allow the computer to enter sleep mode.

⇒ The [Scan] button on the ScanSnap flashes in blue while the documents are being scanned.

The [ScanSnap Manager - Image scanning and file saving] window appears.

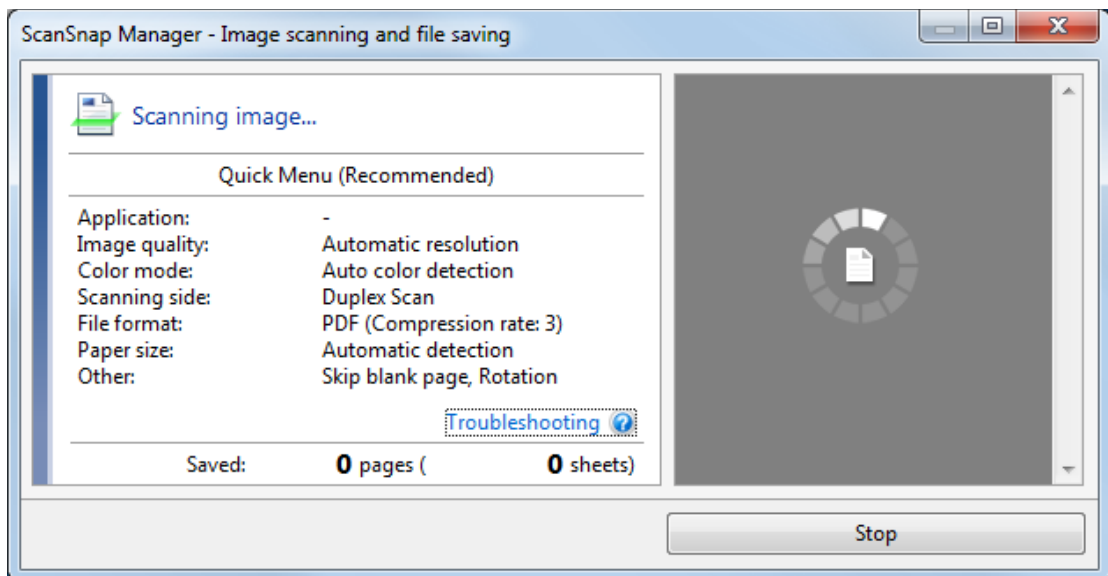

⇒ The Quick Menu appears when the scanning is completed.

10. In the Quick Menu, click the icon of the application to link with ScanSnap Manager.

For details about linking the following applications with ScanSnap Manager, refer to "[Useful Usages](#)" (page 81).

- ScanSnap Organizer
- CardMinder

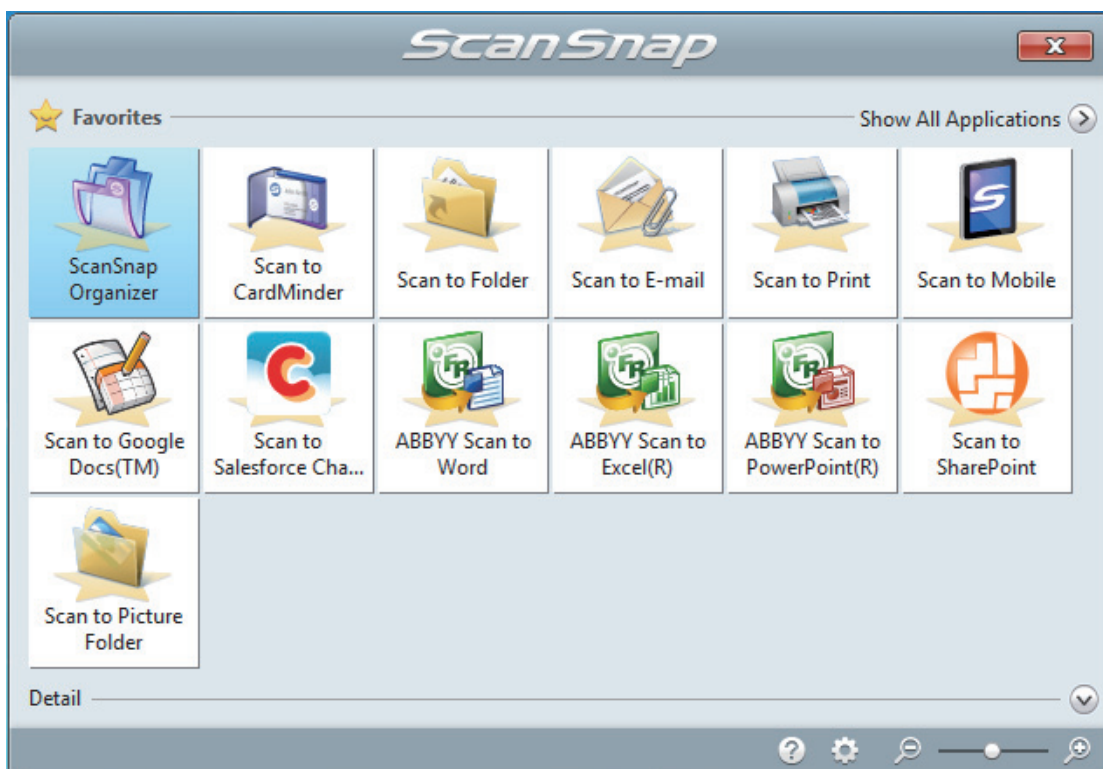

⇒ The selected application starts up. For details, refer to the Advanced Operation Guide.

ATTENTION

- You cannot start scanning when the Quick Menu is displayed. Either select an icon from the Quick Menu and finish the process, or close the Quick Menu before you perform the next scan.

- Do not move, delete, or rename scanned images using other applications while the Quick Menu is displayed.

HINT

- Clicking  displays the description of an application. Placing the mouse cursor over the icon of another application displays the description of the application.
 - Performing a scan while an application that can be automatically linked with is active automatically starts the linkage between ScanSnap Manager and the application.
- For details, refer to the Advanced Operation Guide.

Scanning a Long Page

Documents up to 863 mm (34 in.) in length can be scanned.

For details about documents that can be scanned, refer to "Documents That Can Be Loaded Directly into the ScanSnap" (page 61).

HINT

For details about how to load documents that are 360 mm (14.17 in.) or less in length, refer to "Scanning a Document" (page 19).

1. Open the ADF paper chute (cover) of the ScanSnap.

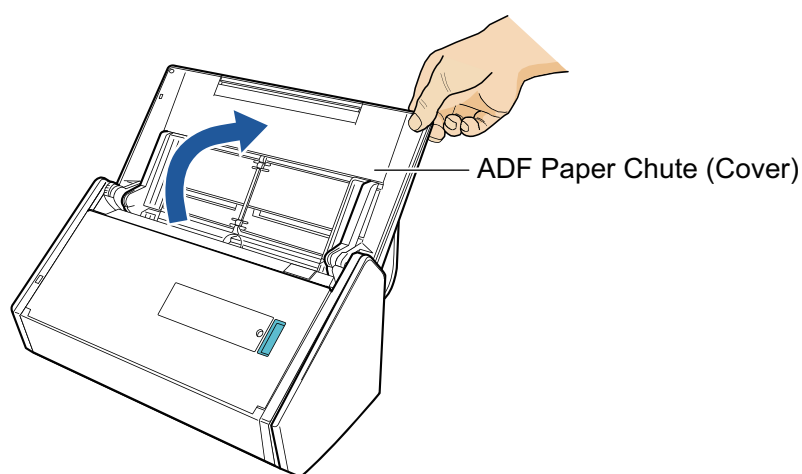

⇒ The [Scan] button flashes in blue. The button returns to being lit normally when document scanning is enabled.

In addition, the ScanSnap Manager icon in the notification area located at the far right of the taskbar changes from to .

2. Pull the stacker towards you.

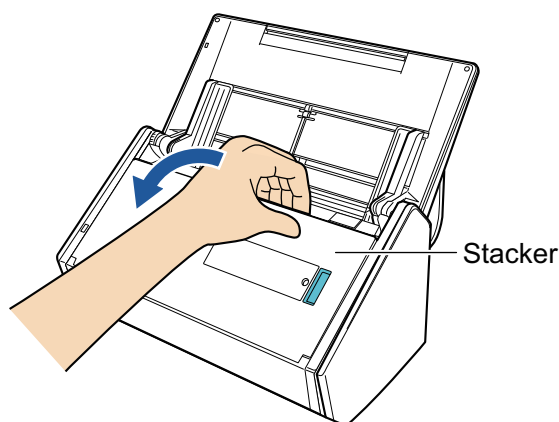

3. Pull out the extension on the ADF paper chute (cover) and open the stacker.

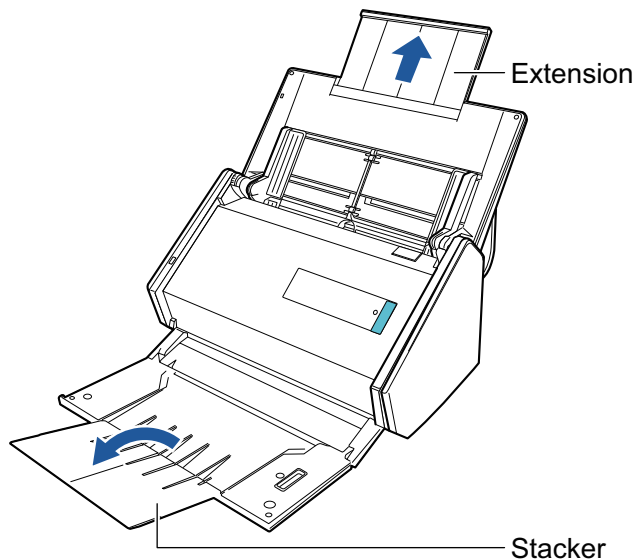

4. Load only one document in the ADF paper chute (cover).

Hold the document with your hand so that it does not fall out of the ADF paper chute (cover).

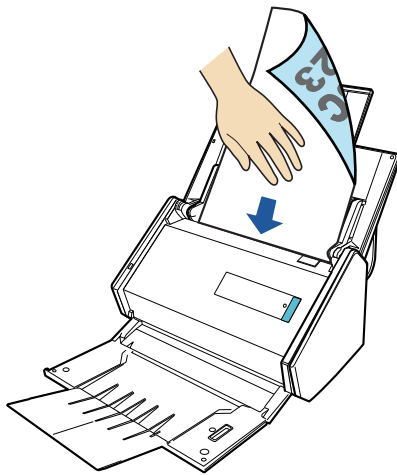

5. Press the [Scan] button on the ScanSnap (for three seconds or longer) until the button flashes in blue to start a scan.

ATTENTION

- Secure enough space where the scanned documents are ejected from the ScanSnap, and pick up the documents with your hands to prevent them from falling off the unit where the ScanSnap is placed on.

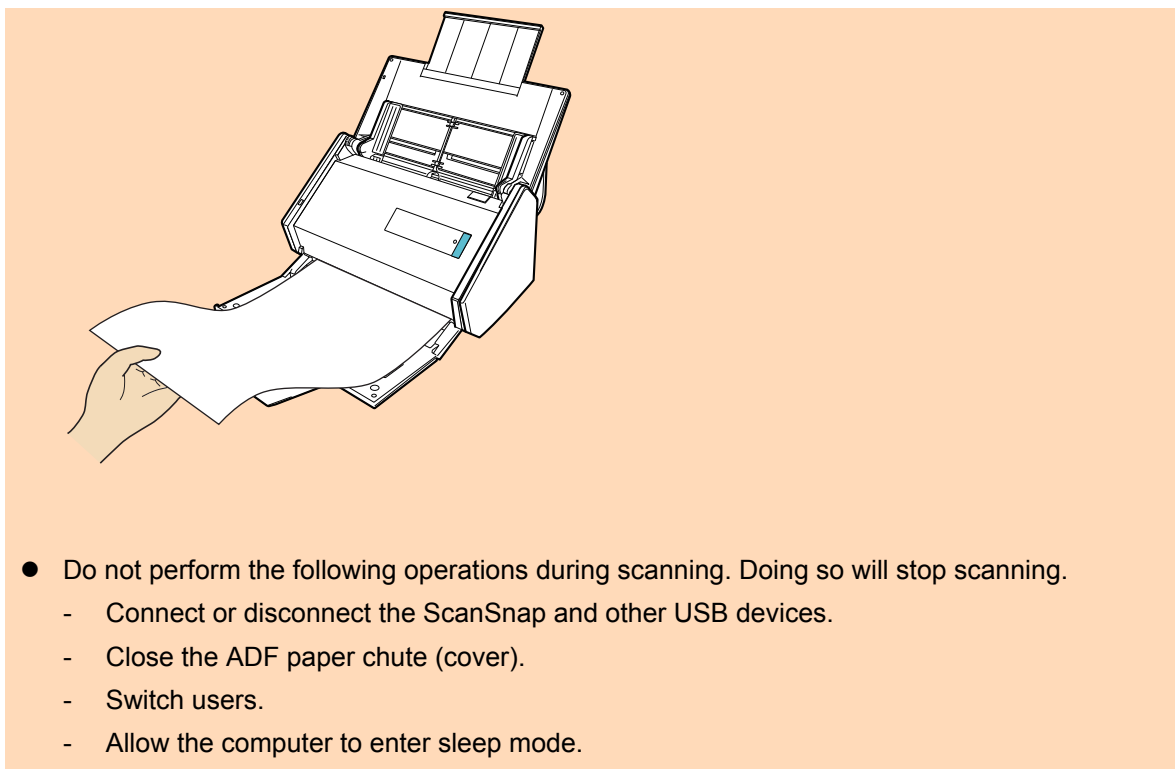

HINT

When you scan the first page as a long page and continue scanning, the subsequent documents are also scanned as long pages.

⇒ The [Scan] button on the ScanSnap flashes in blue while the documents are being scanned.

The [ScanSnap Manager - Image scanning and file saving] window appears.

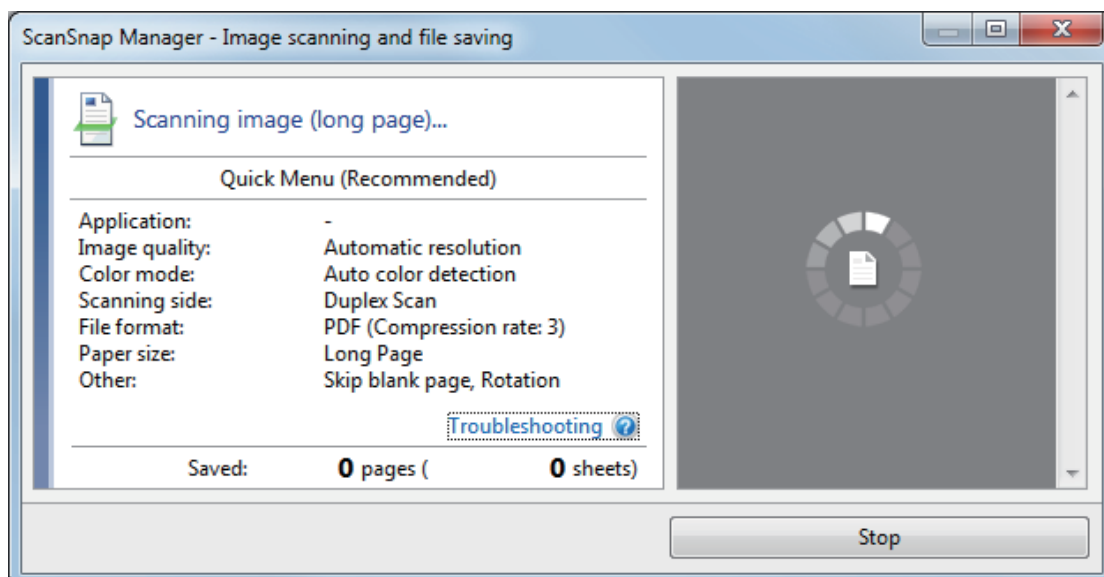

⇒ The Quick Menu appears when the scanning is completed.

6. In the Quick Menu, click the icon of the application to link with ScanSnap Manager.



When you select , you can manage scanned images by folder with ScanSnap Organizer.

For details, refer to "Managing Paper Documents by Folder on a Computer" (page 82).



⇒ The selected application starts up. For details, refer to the Advanced Operation Guide.

ATTENTION

- You cannot start scanning when the Quick Menu is displayed. Either select an icon from the Quick Menu and finish the process, or close the Quick Menu before you perform the next scan.
- Do not move, delete, or rename scanned images using other applications while the Quick Menu is displayed.

HINT

- Clicking  displays the description of an application. Placing the mouse cursor over the icon of another application displays the description of the application.
- Performing a scan while an application that can be automatically linked with is active automatically starts the linkage between ScanSnap Manager and the application.
For details, refer to the Advanced Operation Guide.

Scanning Documents of Different Widths or Lengths in One Batch



Documents of different widths or lengths can be scanned in one batch.

For details about documents that can be scanned, refer to "[Documents That Can Be Loaded Directly into the ScanSnap](#)" (page 61).

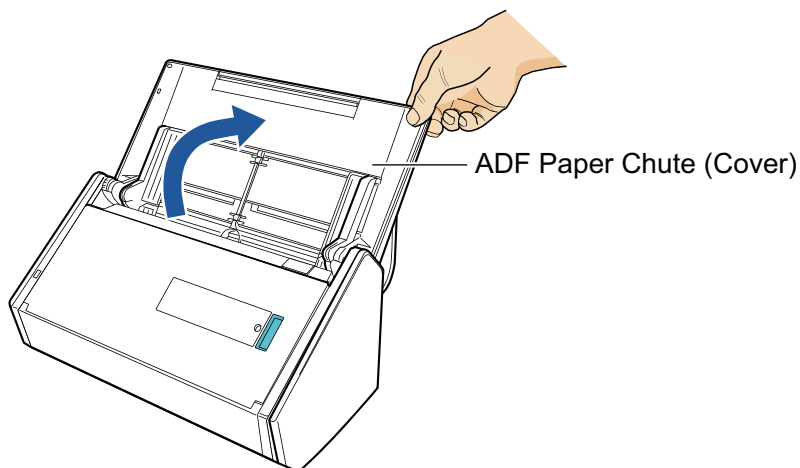
1. Open the ADF paper chute (cover) of the ScanSnap.



⇒ The [Scan] button flashes in blue. The button returns to being lit normally when document scanning is enabled.

In addition, the ScanSnap Manager icon in the notification area located at the far right of the taskbar changes from  to .

2. Pull the stacker towards you.

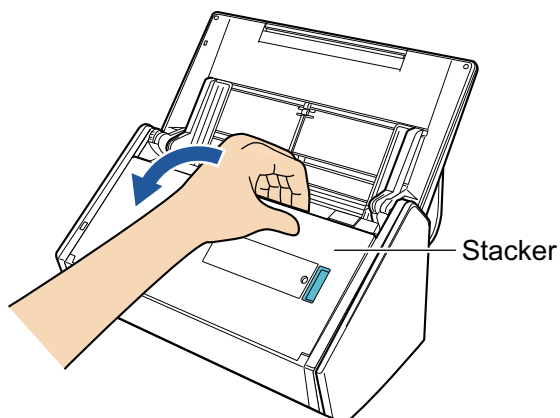

3. Depending on documents to scan, pull out the extension on the ADF paper chute (cover) and open the stacker.

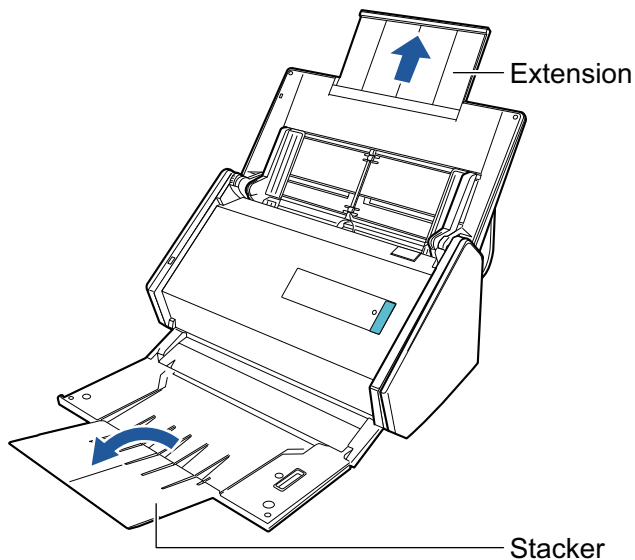

4. Right-click the ScanSnap Manager icon  in the notification area located at the far right of the taskbar, and select the [Scan Button Settings] from the "Right-Click Menu" (page 43).
⇒ The ScanSnap setup window appears.

5. In the [Paper] tab, select [Automatic detection] in [Paper size].

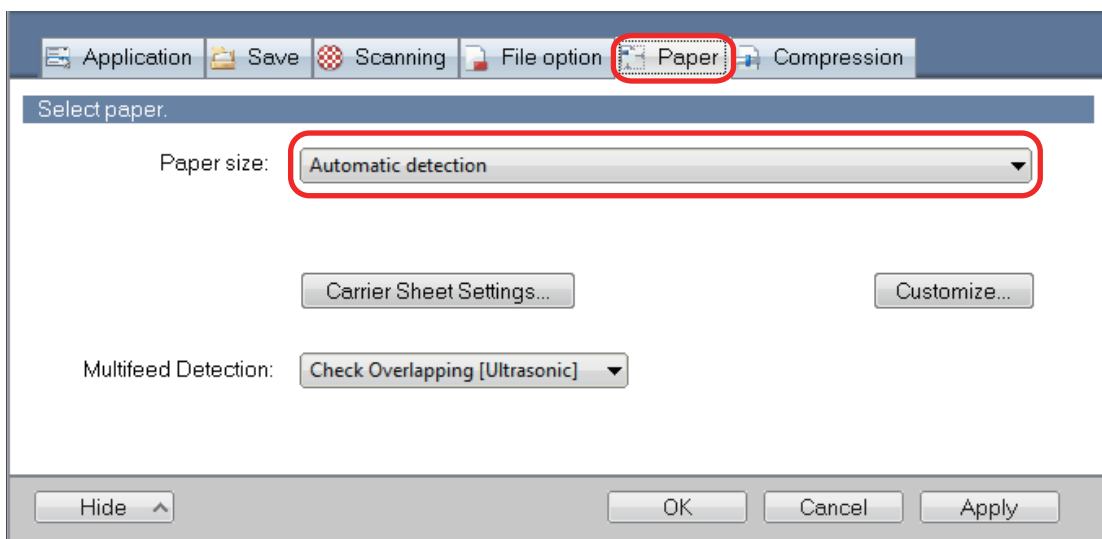

6. Select [None] in [Multifeed Detection].

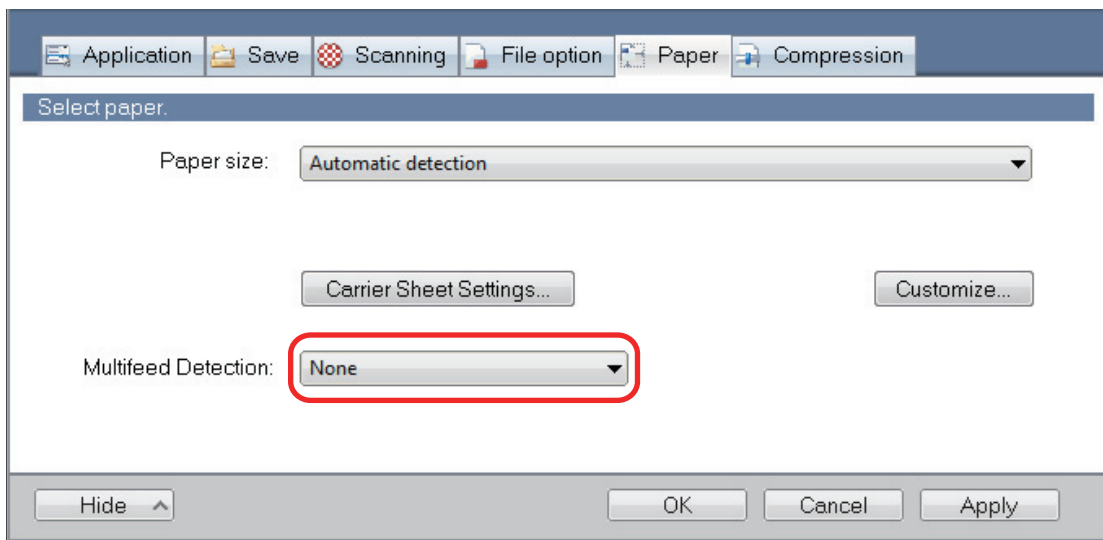

7. Click the [OK] button to close the ScanSnap setup window.

8. Load documents in the ScanSnap.

1. Align the edges of the documents.

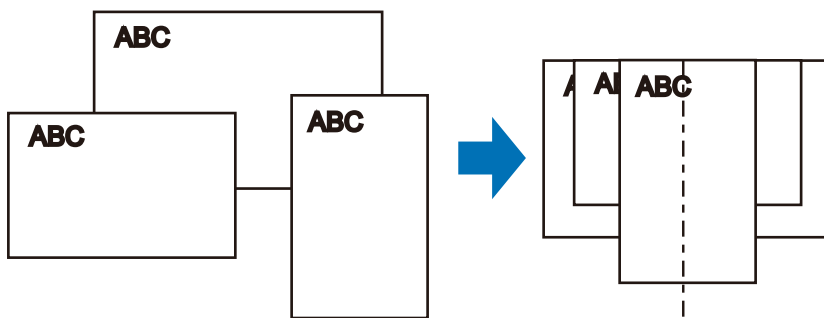

2. Load the documents at the center of the ADF paper chute (cover).

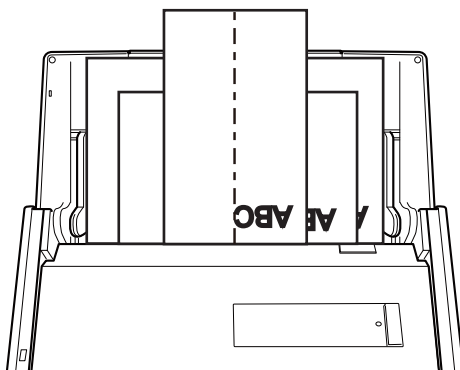

ATTENTION

- Load all documents over one another above the pick roller (center). Documents that are not loaded above the pick roller cannot be fed.

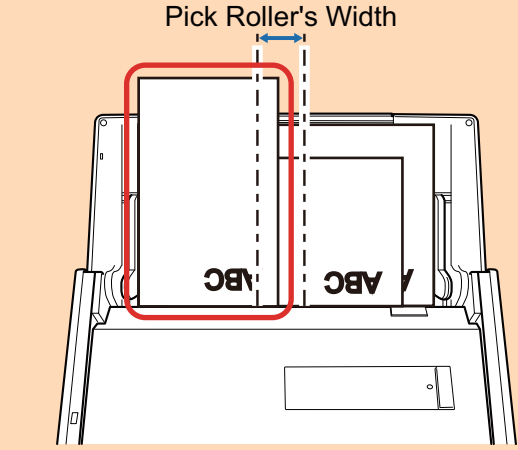

Incorrect

- Adjust the side guides to the widest document. If the side guides are not adjusted properly, a paper jam may occur.
- Load smaller documents so that they can be scanned straight.
 - If the documents are skewed during scanning, the following problems may occur:
 - Part of the document does not appear in the scanned image
 - Slant lines appear in the scanned image
 - The documents are scanned in a wrong paper size

If the documents are not scanned straight, it is recommended that you select the [Continue scanning after last page] checkbox in the [Scanning] tab of the "[ScanSnap Setup Window](#)" (page 45), separate the documents by their widths, and scan them in different batches.

9. Press the [Scan] button on the ScanSnap to start a scan.

ATTENTION

Do not perform the following operations during scanning. Doing so will stop scanning.

- Connect or disconnect the ScanSnap and other USB devices.
- Close the ADF paper chute (cover).
- Switch users.
- Allow the computer to enter sleep mode.

⇒ The [Scan] button on the ScanSnap flashes in blue while the documents are being scanned.

The [ScanSnap Manager - Image scanning and file saving] window appears.

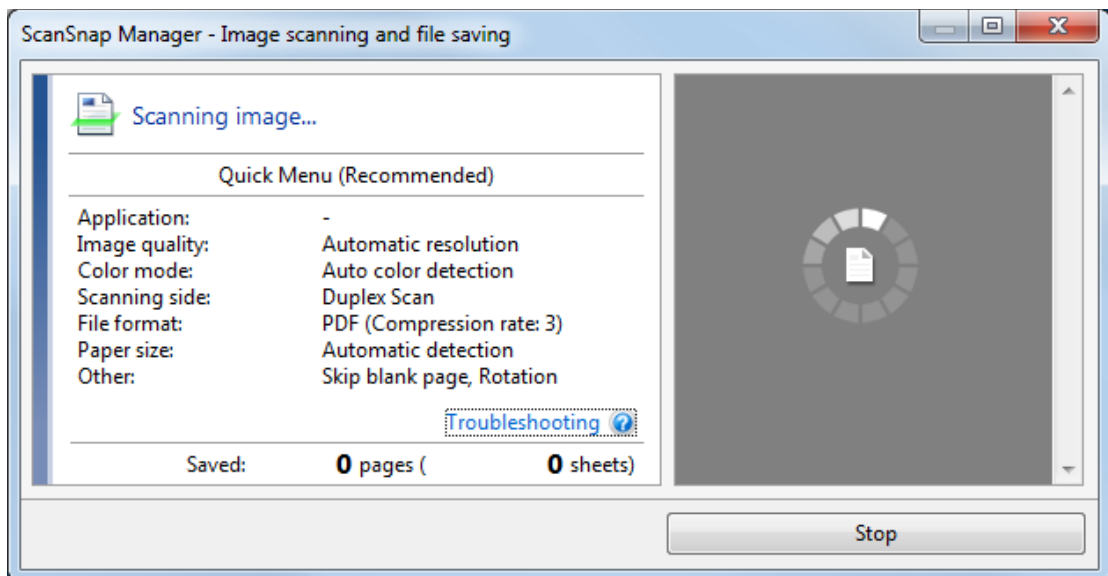

⇒ The Quick Menu appears when the scanning is completed.

10. In the Quick Menu, click the icon of the application to link with ScanSnap Manager.



When you select , you can manage scanned images by folder with ScanSnap Organizer.

For details, refer to "Managing Paper Documents by Folder on a Computer" (page 82).

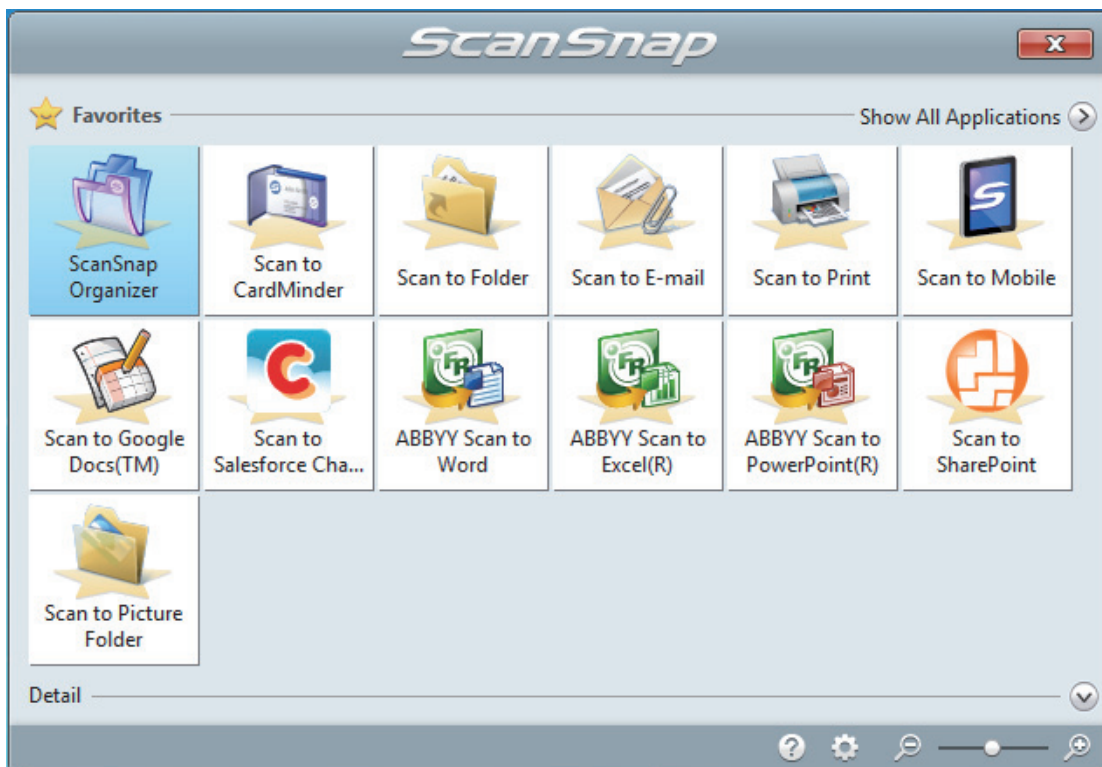

⇒ The selected application starts up. For details, refer to the Advanced Operation Guide.

ATTENTION

- You cannot start scanning when the Quick Menu is displayed. Either select an icon from the Quick Menu and finish the process, or close the Quick Menu before you perform the next scan.
- Do not move, delete, or rename scanned images using other applications while the Quick Menu is displayed.

HINT

- Clicking  displays the description of an application. Placing the mouse cursor over the icon of another application displays the description of the application.
- Performing a scan while an application that can be automatically linked with is active automatically starts the linkage between ScanSnap Manager and the application.
For details, refer to the Advanced Operation Guide.

ScanSnap Overview

This section provides an overview that you should be aware of before operating ScanSnap.

- ["Parts and Functions" \(page 36\)](#)
- ["System Requirements" \(page 38\)](#)
- ["Overview of the Software Related to the ScanSnap" \(page 40\)](#)
- ["How to Install the Software" \(page 41\)](#)
- ["ScanSnap Manager Icon" \(page 42\)](#)
- ["Right-Click Menu" \(page 43\)](#)
- ["ScanSnap Setup Window" \(page 45\)](#)
- ["Turning the ScanSnap On or Off" \(page 46\)](#)
- ["Connecting the ScanSnap via Wireless LAN" \(page 52\)](#)
- ["Documents to Scan" \(page 60\)](#)

Parts and Functions

This section explains the names and functions of the ScanSnap parts.

Front

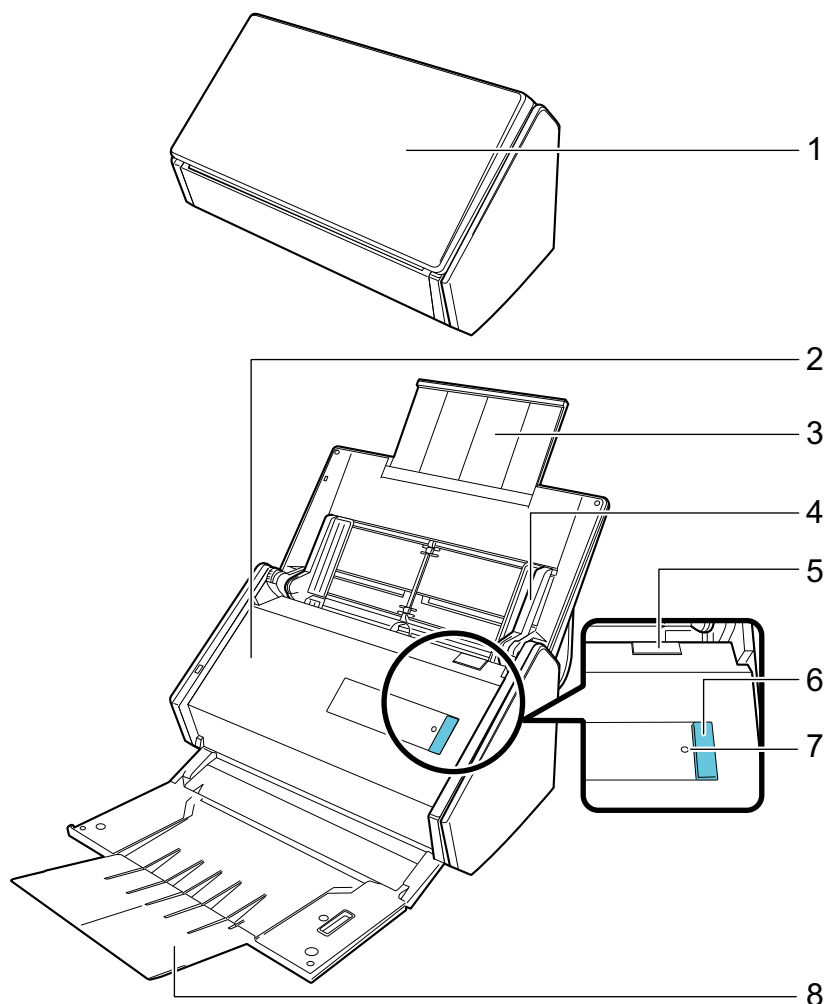

| No. | Name | Description |
|-----|------------------------------|--|
| 1 | ADF paper chute (cover) (*1) | Open it to use the ScanSnap. Opening it turns on the ScanSnap. Then, you can load a document on it. |
| 2 | ADF top section | Open it to remove jammed documents, replace the Roller Set, or clean the inside of the ScanSnap. |
| 3 | Extension | Pull out when scanning long documents. |
| 4 | Side guide | Adjust to the width of documents to prevent them from getting skewed. |
| 5 | ADF release tab | Pull this tab to open the ADF top section. |
| 6 | [Scan] button (*1) | Starts scanning. Can be pressed even when the stacker is closed. Indicates the status of the ScanSnap as follows: Blue (lit): Ready Blue (flashing): Scanning Orange (flashing): Error |

| No. | Name | Description |
|-----|-----------------|---|
| 7 | Wi-Fi indicator | Indicates the connection status between the ScanSnap and your wireless access point as follows: Blue (lit): Ready Blue (flashing): Standby Orange (lit): Not Connectable Orange (flashing): Not Connectable (WPS error) |
| 8 | Stacker | Open to use the stacker. Stacks up the ejected documents. |

*1: When the ScanSnap has turned off automatically because of the automatic power off function, either press the [Scan] button (this will not start scanning), or close the ADF paper chute (cover), then open it again to turn the ScanSnap back on.

For details, refer to ["Automatic Power OFF" \(page 51\)](#).

Back

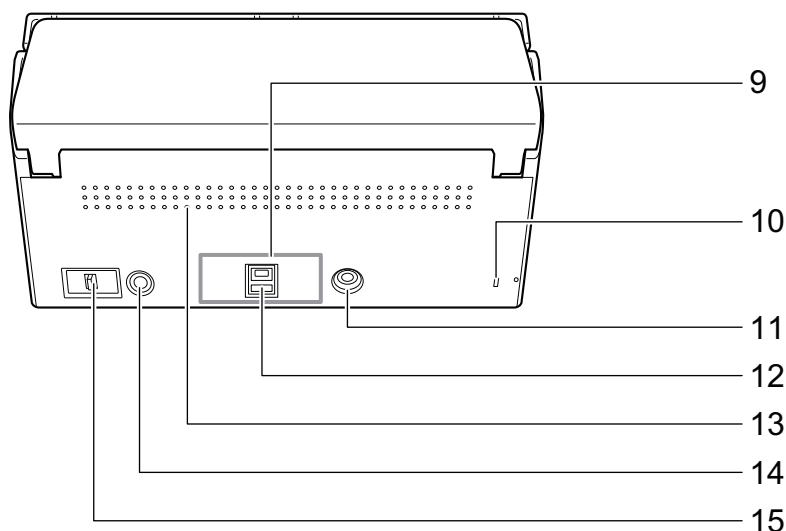

| No. | Name | Description |
|-----|---------------------|---|
| 9 | Tape seal | Remove this tape seal after installing the software. |
| 10 | Security cable slot | Used to connect an anti-theft security cable (commercially available). |
| 11 | Power connector | Used to connect a power cable. |
| 12 | USB connector | Used to connect a USB cable. |
| 13 | Ventilation port | Holes for ventilating hot air from inside the ScanSnap. |
| 14 | WPS button | Press this button to connect to a WPS compatible wireless access point by using the push button method. |
| 15 | Wi-Fi switch | Turn this switch on to connect the ScanSnap to a wireless LAN. |

System Requirements

The ScanSnap has the following system requirements.

For the latest information on requirements, please visit the ScanSnap Support Site at:

<http://scansnap.fujitsu.com/g-support/en/>

| | |
|--------------------------------|--|
| Operating system | Windows 10 (32-bit/64-bit) (*1) Windows 8.1 (32-bit/64-bit) (*1) Windows 8 (32-bit/64-bit) (*1) Windows 7 (32-bit/64-bit) Windows Vista (32-bit/64-bit) (*2) Windows XP (32-bit) (*3) |
| CPU | Intel® Core™ i5 2.5 GHz or higher |
| Memory | 4 GB or more |
| Display resolution (*4) | Windows 10/Windows 8.1/Windows 8: 1024 × 768 pixels or higher Windows 7/Windows Vista/Windows XP: 800 × 600 pixels or higher |
| Disk space | Free space required to install the software bundled with the ScanSnap is as follows: (*5) <ul style="list-style-type: none"> ● ScanSnap Manager: 700 MB ● ScanSnap Organizer: 670 MB ● CardMinder: 660 MB ● ABBYY FineReader for ScanSnap: 620 MB ● ScanSnap Online Update: 10 MB ● Scan to Microsoft SharePoint: 40 MB ● ScanSnap iX500 Basic Operation Guide: 10 MB |
| USB port | USB 3.0(*6)/USB 2.0/USB 1.1 |

*1: The software bundled with the ScanSnap operates as a desktop application.

*2: Service Pack 2 or later is required.

*3: Service Pack 3 or later is required.

*4: When the font size is large, some screens may not be displayed correctly.

In such a case, use a smaller font size.

*5: To save scanned images, more free space is required.

For details about estimated image data size, refer to the ScanSnap Manager Help.

*6: When the ScanSnap is connected to a USB 3.0 port, the ScanSnap may not be recognized by some computers.

For the latest USB 3.0 information, refer to the ScanSnap Support Site (<http://scansnap.fujitsu.com/g-support/en/>).

ATTENTION

- If the system requirements above are not satisfied, the ScanSnap may not operate.
- If a USB port on the keyboard or on the monitor is in use, the ScanSnap may not operate.
- When using a commercially available USB hub, use a type that is powered from an electrical power supply (and that comes with an adapter).
- Scanning speed decreases in the following cases:
 - The CPU or the memory does not meet the recommended specifications.
 - The version of the USB port or the USB hub is USB 1.1.

- The actual disk space used for the installation of the software and the disk space required for the installation may be different because of the disk management in your Windows system.
- To scan a document, a disk space that is approximately three times larger than the size of the file to be saved is required.
- If characters are not correctly displayed when using CardMinder, Scan to Mobile, Scan to Salesforce Chatter, or Scan to Dropbox, perform the following.
 - Windows XP
 - Select [Control Panel] → [Regional and Language Options] → [Install files for East Asian languages] in the [Language] tab.
 - Install the universal font (Arial Unicode MS) from the setup disk of Microsoft Office 2000 or later.
 - Windows Vista/Windows 7/Windows 8/Windows 8.1/Windows 10
Install the universal font (Arial Unicode MS) from the setup disk of Microsoft Office 2003 or later.

HINT

- For Windows 7, Windows Vista, or Windows XP, when the following software programs are installed, .NET Framework 4 or an in-place update for .NET Framework 4 (which requires 2 GB of free disk space at most) may be installed:
 - ScanSnap Manager
 - ScanSnap OrganizerAfter installing .NET Framework, apply the updates in Windows Update.
- For Windows 10, Windows 8.1, Windows 8, Windows Vista, or Windows XP, when the following software programs are installed, .NET Framework 3.5 SP1 (which requires 500 MB of free disk space at most) may be installed at the same time:
 - ScanSnap Manager
 - ScanSnap Organizer
 - CardMinder
- For Windows XP, when Scan to Microsoft SharePoint is installed, .NET Framework 2.0 (which requires 280 MB of free disk space at most) may be installed at the same time.

Overview of the Software Related to the ScanSnap

This section gives an overview of each bundled software and their functions. You can edit, manage, and arrange the scanned image by using the following software:

ScanSnap Manager

This scanner driver is required to scan documents with the ScanSnap. Scanned images can be saved as PDF or JPEG files to a computer.

You need to have ScanSnap Connect Application installed on your mobile device to save PDF or JPEG files to your mobile device.

You can download ScanSnap Connect Application for your mobile device from its application market.

ScanSnap Organizer

You can use this application to display image data (PDF or JPEG files) without opening them, create folders and arrange files as you like.

CardMinder

You can use this application to efficiently digitalize a large number of business cards.

Text recognition can be performed on business cards and you can create a database to facilitate card data management and searches. Data in the database can be printed and linked with various applications.

ABBYY FineReader for ScanSnap

This application can perform text recognition on the scanned images using OCR (Optical Character Recognition) to convert the image data to Word, Excel, or PowerPoint files that can be edited.

ScanSnap Online Update

This application checks whether the latest updates or software programs are available on the download server. When the latest updates or software programs are available, you can automatically apply updates or download and install the software programs manually.

Scan to Microsoft SharePoint

You can easily save files in SharePoint using the ScanSnap.

Evernote for Windows

You can easily save files in Evernote using the ScanSnap.

Dropbox for Windows

You can easily save files to your Dropbox folder using the ScanSnap.

Adobe Acrobat Standard DC

This is a global standard application for creating, editing, managing, and utilizing PDF format electronic documents.

How to Install the Software

When you insert the Setup DVD-ROM into the DVD-ROM drive on your computer, the [ScanSnap Setup] window appears.

ATTENTION

- Do not connect the ScanSnap to the computer before installing the software. Doing so may cause the ScanSnap not to be recognized by the computer. In that case, install the software, and then reconnect the ScanSnap to the computer.
- If a DVD-ROM drive is not available, the installers for the software programs can be downloaded from the following web page.

<http://scansnap.fujitsu.com/g-support/en/>

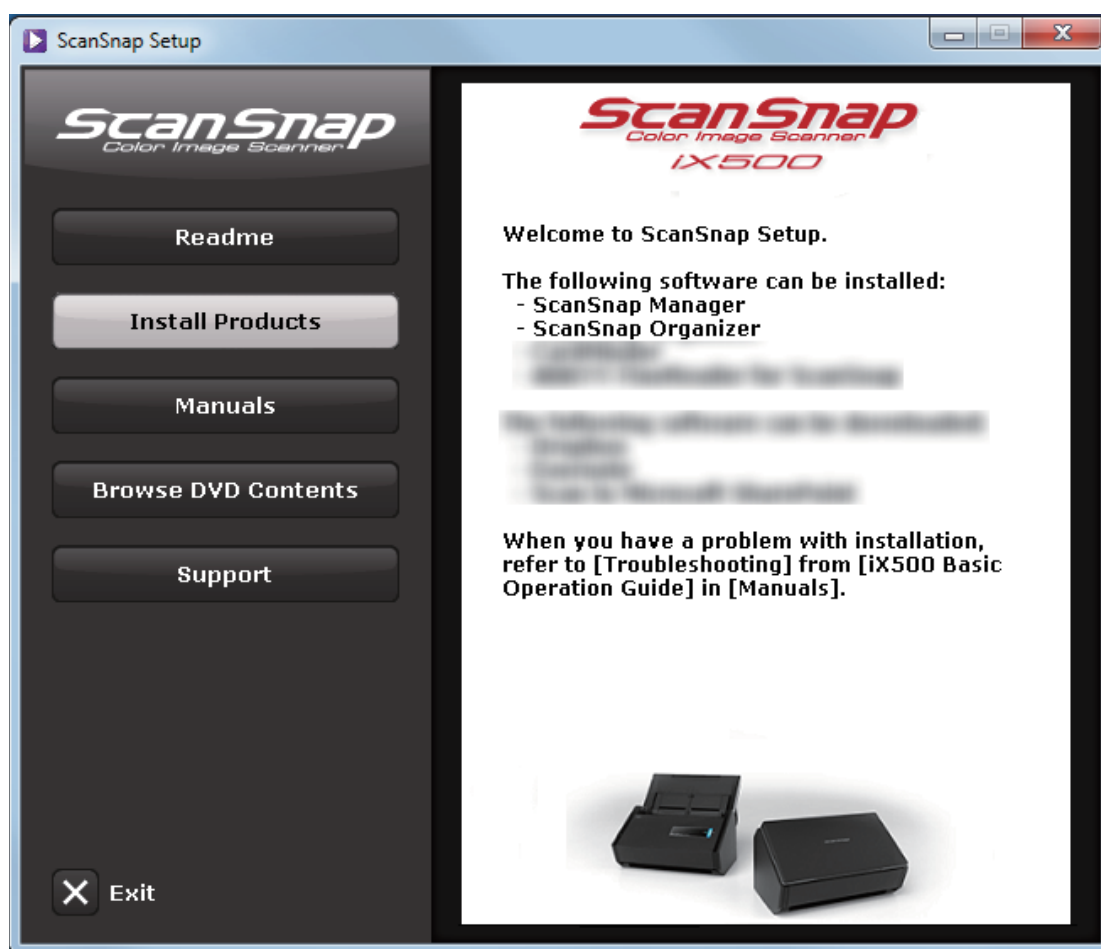

The functions of each button in the [ScanSnap Setup] window are as follows.





| Button | Function |
|---------------------|---|
| Readme | Displays the [Readme] window. You can refer to the Readme file of each software in this window. |
| Install Products | Displays the [Install Products] window. You can start installing software. |
| Manuals | Displays the [Manuals] window. You can refer to Safety Precautions, Getting Started, the Basic Operation Guide (this manual), and the manual of each software program in this window. |
| Browse DVD Contents | Opens Windows Explorer to display the files from the Setup DVD-ROM. |
| Support | Displays contact information for customer support. |

ScanSnap Manager Icon

When ScanSnap Manager is running, the ScanSnap Manager icon is displayed in the notification area. The notification area is located at the far right of the taskbar.

The ScanSnap Manager icon indicates whether or not ScanSnap Manager is successfully communicating with the ScanSnap. The appearance of the icon changes according to the communication status as shown below.

This manual assumes that the ScanSnap is connected to a computer with a USB cable.

| Communication Status | ScanSnap Manager Icon |
|----------------------|---|
| Communicating | <p>When the ScanSnap is connected to a computer with a USB cable</p>  <p>When the ScanSnap is connected to a computer via wireless LAN</p>  |
| Not communicating |  <p>When the ScanSnap is connected to a mobile device via wireless LAN</p>  |

HINT

Turn the ScanSnap on to begin communication between ScanSnap Manager and the ScanSnap. For details about how to turn on the ScanSnap, refer to "[Turning the ScanSnap On](#)" (page 47).

You can display the menu for scanning documents and ScanSnap Manager settings from the ScanSnap Manager icon.

- Right-clicking
Displays the "[Right-Click Menu](#)" (page 43).
- Left-clicking
Displays the Left-Click Menu.
For details, refer to the Advanced Operation Guide.

Right-Click Menu

This menu appears when you right-click the ScanSnap Manager icon  in the notification area located at the far right of the taskbar.

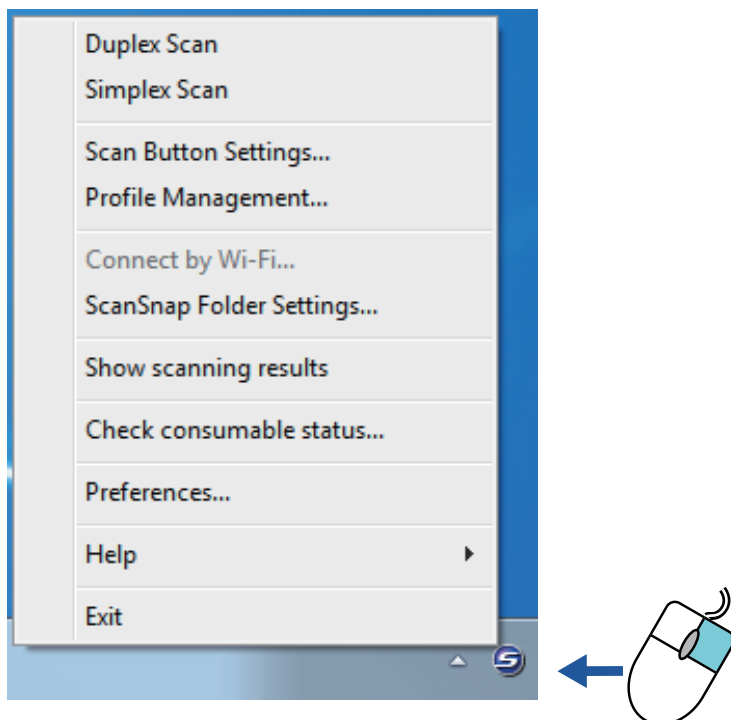

| Item | Function |
|--------------------------|---|
| Duplex Scan | Scans both sides of the document. Follows the settings configured in [Scan Button Settings]. |
| Simplex Scan | Scans only one side of the document. Follows the settings configured in [Scan Button Settings]. |
| Scan Button Settings | Displays the "ScanSnap Setup Window" (page 45). You can configure the scan settings in this window. |
| Profile Management | Displays the [ScanSnap Manager - Profile Management] window. You cannot select [Profile Management] when the [Use Quick Menu] checkbox is selected in the ScanSnap setup window. For details, refer to the Advanced Operation Guide. |
| Connect by Wi-Fi | Displays the [ScanSnap Manager - Connect by Wi-Fi] window. You can connect the ScanSnap to a computer via wireless LAN. This cannot be selected when the ScanSnap is connected to a computer via a USB cable. For details, refer to "Connecting the ScanSnap via Wireless LAN" (page 52). |
| ScanSnap Folder Settings | Displays the ScanSnap setup window. You can configure the scan settings for using ScanSnap Folder in this window. For details, refer to the Advanced Operation Guide. |

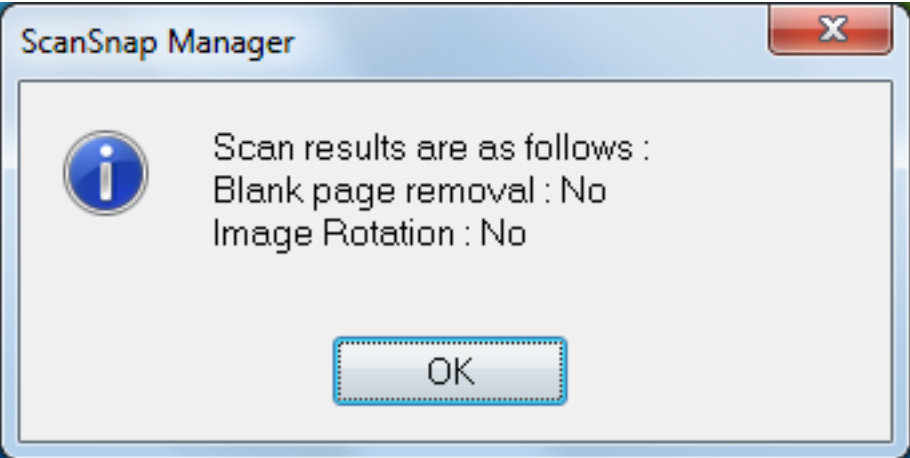
| Item | Function |
|-------------------------|--|
| Show scanning results | <p>After scanning is completed, a message appears to inform you whether the image is rotated.</p>  |
| Check consumable status | <p>Displays the [ScanSnap Manager - Check consumable status] window. You can reset the consumable counters after replacing the consumables.</p> |
| Preferences | <p>Displays the [ScanSnap Manager - Preferences] window.</p> |
| Help | <p>Displays the following menu:</p> <ul style="list-style-type: none"> ● Help Opens the ScanSnap Manager Help. ● Troubleshooting Displays [Troubleshooting] in the ScanSnap Manager Help. ● ScanSnap Portal Site Opens the ScanSnap global homepage (http://scansnap.fujitsu.com). ● About ScanSnap Manager Displays the [ScanSnap Manager - Version Information] window. ● ScanSnap information Displays the [ScanSnap Manager - Scanner and driver information] window. Displayed when the ScanSnap and computer are connected. ● Online Update Starts the ScanSnap Online Update. For details, refer to "Updating the Software" (page 135). |
| To establish connection | <p>Displayed when ScanSnap Manager is not communicating with the ScanSnap correctly.</p> |
| Exit | <p>Exits ScanSnap Manager.</p> |

ScanSnap Setup Window

When you right-click the ScanSnap Manager icon  in the notification area located at the far right of the taskbar, and select [Scan Button Settings] from the "Right-Click Menu" (page 43), the following ScanSnap setup window appears.

In the ScanSnap setup window, you can use the [Use Quick Menu] checkbox to specify whether or not to use the Quick Menu. You can also use the profile buttons and detail setting tabs to specify scan settings according to your scanning needs.

For details, refer to the ScanSnap Manager Help.

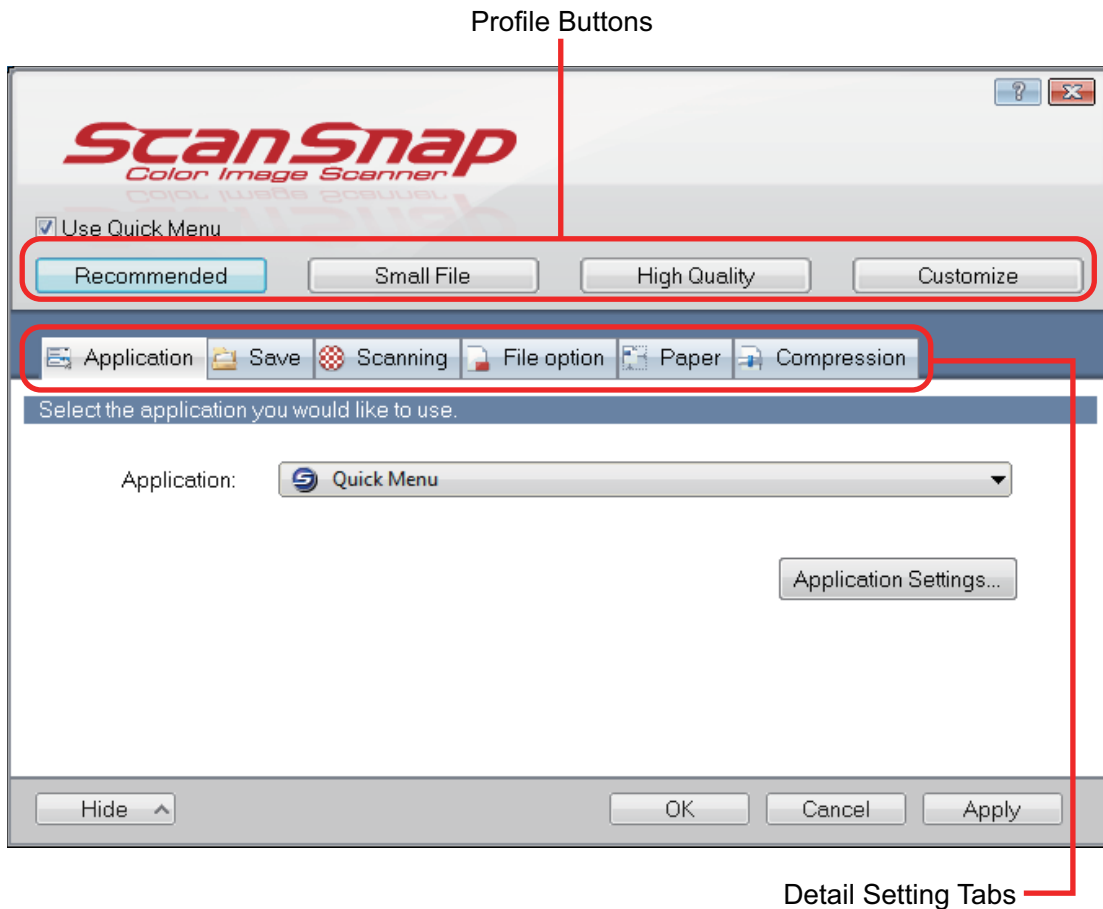

Turning the ScanSnap On or Off

This section explains how to turn the ScanSnap on or off.

- ["Turning the ScanSnap On" \(page 47\)](#)
- ["Turning the ScanSnap Off" \(page 49\)](#)
- ["Sleep Mode" \(page 50\)](#)
- ["Automatic Power OFF" \(page 51\)](#)

Turning the ScanSnap On

1. Turn on the computer.



HINT

If you connect the ScanSnap and a mobile device via a wireless LAN and then scan a document, you do not have to turn on the computer.

- ⇒ The computer starts up and the ScanSnap Manager icon  appears in the notification area located at the far right of the taskbar.



HINT

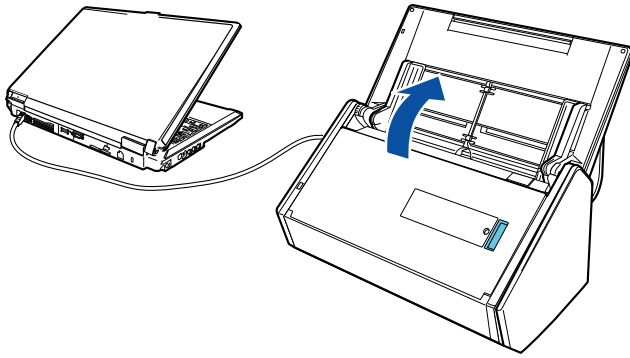

- If the ScanSnap Manager icon  is not displayed in the notification area, start ScanSnap Manager. Start ScanSnap Manager in the following procedure.
 - Windows 10
Select [Start] menu → [All apps] → [ScanSnap Manager] → [ScanSnap Manager].
 - Windows 8.1
Click  on the lower left side of the Start screen, and select [ScanSnap Manager] under [ScanSnap Manager] on the All apps screen.
 - Windows 8
Right-click the Start screen, and select [All apps] on the app bar → [ScanSnap Manager] under [ScanSnap Manager].
 - Windows 7/Windows Vista/Windows XP
Select [Start] menu → [All Programs] → [ScanSnap Manager] → [ScanSnap Manager].
- If ScanSnap Manager does not automatically start when you log on to your computer, change the setting in the following procedure:
 1. Right-click the ScanSnap Manager icon  in the notification area and select [Preferences] from the "Right-Click Menu" (page 43).
⇒ The [ScanSnap Manager - Preferences] window appears.
 2. In the [Auto Startup] list, select the [Start up ScanSnap Manager when you log on] checkbox.

2. Open the ADF paper chute (cover) of the ScanSnap to turn the power on.



Example: When a USB cable is used for connection

⇒ The [Scan] button flashes in blue. The button returns to being lit normally when document scanning is enabled.

In addition, the ScanSnap Manager icon in the notification area changes from  to .

ATTENTION

With some computers, the initialization of the ScanSnap may be performed several times when the computer is started up.

HINT

- It may take more time for the ScanSnap Manager icon in the notification area to change to  depending on computer performance, operating environment, or loading, for example, when many software programs are running at the same time.
- When the ScanSnap is turned on, a notification informs you of the ScanSnap's communication status.

To disable notifications of the ScanSnap's communication status, change the setting in the following procedure:

1. Right-click the ScanSnap Manager icon  in the notification area and select [Preferences] from the "Right-Click Menu" (page 43).
⇒ The [ScanSnap Manager - Preferences] window appears.
2. Clear the [Notify of the communication status] checkbox in the [Status Display] list.

Turning the ScanSnap Off

1. Close the ADF paper chute (cover).

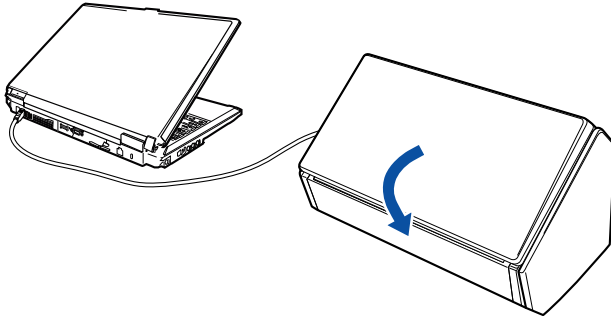

Example: When a USB cable is used for connection

⇒ The ScanSnap is turned off and the ScanSnap Manager icon in the notification area changes from to .

ATTENTION

- Close the ADF paper chute (cover) after putting the extension back.
- If moving the ScanSnap, first turn the power off and remove all cables.

The bottom part of the ScanSnap may become hot when the ScanSnap is being used but this does not affect ScanSnap operation or cause any physical harm. Be careful not to drop the ScanSnap when carrying it.

HINT

- If the Wi-Fi switch is off, the power of the ScanSnap and the computer operate together. If you keep the ScanSnap connected to the computer, you do not have to worry about turning the power ON/OFF.
- With some computers, it may take 2 to 3 minutes until the light of the [Scan] button goes out after the computer is turned off.
- When the ScanSnap is turned off, a notification informs you of the ScanSnap's communication status.

To disable notifications of the ScanSnap's communication status, change the setting in the following procedure:

1. Right-click the ScanSnap Manager icon in the notification area and select [Preferences] from the "Right-Click Menu" (page 43).
⇒ The [ScanSnap Manager - Preferences] window appears.
2. Clear the [Notify of the communication status] checkbox in the [Status Display] list.

Sleep Mode

When the ScanSnap is on and has not been used for 14 minutes, it enters sleep (power saving) mode.

Automatic Power OFF

When the ScanSnap is turned on and left unused for the specified time (default is "4 hours"), it will turn itself off automatically.

To turn the ScanSnap back on, perform one of the following operations:

- Press the [Scan] button on the ScanSnap (this will not start scanning)
- Close the ADF paper chute (cover) and open it again

HINT

- To continue using the ScanSnap, reset the time until auto power-off by performing one of the following:
 - Load a document in the ScanSnap
 - Press the [Scan] button on the ScanSnap
 - Close the ADF paper chute (cover) and open it again
- You can change the time of the ScanSnap to turn off automatically or change the setting so that it will not turn off automatically. Set according to the following procedures:
 1. Right-click the ScanSnap Manager icon  in the notification area and select [Preferences] from the "Right-Click Menu" (page 43).
 - ⇒ The [ScanSnap Manager - Preferences] window appears.
 2. In the [Power] list, change the settings for [Power setting] based on how it is connected.
- A notification informs you 5 minutes before the ScanSnap turns off automatically.

Connecting the ScanSnap via Wireless LAN

By connecting the ScanSnap to a computer or a mobile device via wireless LAN, you can scan documents.

This section explains how to connect the ScanSnap via wireless LAN.

- ["Preparation" \(page 53\)](#)
- ["Setting a Wireless LAN Using the ScanSnap Wireless Setup Tool" \(page 54\)](#)
- ["Connecting the ScanSnap to a Computer" \(page 55\)](#)
- ["Connecting the ScanSnap to a Mobile Device" \(page 57\)](#)
- ["Reconnecting to a Wireless Access Point Using the ScanSnap WPS Button" \(page 58\)](#)

Preparation

To connect the ScanSnap via wireless LAN, prepare the following:

- An environment in which a wireless LAN is available

When connecting the ScanSnap to a wireless access point, you may need information such as an SSID (network name) and a security key (password).

For details, refer to the manual for the wireless access point.

ATTENTION

Do not place the following within 100 mm (3.9 in.) of the ScanSnap, or near your wireless access point.

- Obstacles that block radio waves (such as walls and metal plates)
- Devices that may cause signal interference (such as microwaves and cordless phones) and wireless devices

- ScanSnap Connect Application

To connect the ScanSnap and a mobile device, you need to install ScanSnap Connect Application on your mobile device.

Download ScanSnap Connect Application for the mobile device from the following application stores:

- App Store
- Google Play
- Amazon Appstore

Setting a Wireless LAN Using the ScanSnap Wireless Setup Tool

The ScanSnap Wireless Setup Tool is an application to configure the wireless settings required for connecting your ScanSnap via wireless LAN in a wizard format. The ScanSnap Wireless Setup Tool can be used to configure and check the following wireless LAN settings and connection.

- Connecting the ScanSnap to a wireless access point
- Registering the computer that will be connected to the ScanSnap via wireless LAN
- Setting the IP address, name, and password for the ScanSnap
- Checking the connection between the ScanSnap and the mobile device

Follow the procedure below to start the ScanSnap Wireless Setup Tool and configure the wireless settings.

1. Start the ScanSnap Wireless Setup Tool.

- Windows 10
Select [Start] menu → [All apps] → [ScanSnap Manager] → [ScanSnap Wireless Setup Tool].
 - Windows 8.1
Click  on the lower left side of the Start screen, and select [ScanSnap Wireless Setup Tool] under [ScanSnap Manager] on the All apps screen.
 - Windows 8
Right-click the Start screen, and select [All apps] on the app bar → [ScanSnap Wireless Setup Tool] under [ScanSnap Manager].
 - Windows 7/Windows Vista/Windows XP
Select [Start] menu → [All Programs] → [ScanSnap Manager] → [ScanSnap Wireless Setup Tool].
- ⇒ The ScanSnap Wireless Setup Tool will start running.



2. Click the [Wireless Network Setup Wizard] button in the main menu.

- ⇒ The Wireless Network Setup Wizard appears.

3. Follow the instructions in the Wireless Network Setup Wizard to configure the wireless settings.

HINT

- For details and operation of ScanSnap Wireless Setup Tool, refer to the ScanSnap Wireless Setup Tool Help.
- The ScanSnap Wireless Setup Tool is also started up when the ScanSnap software is installed.

Connecting the ScanSnap to a Computer

You can use the ScanSnap Wireless Setup Tool Wizard to complete the preparation for connecting the ScanSnap to a computer.

For details, refer to "[Setting a Wireless LAN Using the ScanSnap Wireless Setup Tool](#)" (page 54).

The following explains how to connect the ScanSnap and a computer when the wireless settings have already been configured by using the ScanSnap Wireless Setup Tool Wizard.

1. Disconnect the USB cable connecting the ScanSnap to the computer.

ATTENTION

If the ScanSnap Manager icon is , exit ScanSnap Connect Application on the mobile device.

⇒ The ScanSnap is automatically connected to a computer via wireless LAN and the ScanSnap Manager icon changes to .

If the icon does not change, go to step 2.

HINT

- If the [Connect automatically to the last connected ScanSnap by Wi-Fi] checkbox is selected and the last connected ScanSnap is available, the computer is connected to the ScanSnap automatically.
- The computer can be connected to only one ScanSnap.
- Only one computer can be connected to the ScanSnap.
- When you automatically connect a computer and the ScanSnap that had been connected via wireless LAN before, if the password for the ScanSnap to be connected is changed, a notification informs you of the status.

2. Right-click the ScanSnap Manager icon in the notification area located at the far right of the taskbar and select [Connect by Wi-Fi] from the "Right-Click Menu" (page 43).

⇒ The [ScanSnap Manager - Connect by Wi-Fi] window appears.

3. From the list of the ScanSnap units to be connected, select the ScanSnap that you want to connect, and click the [Connect] button.

ATTENTION

- If the [ScanSnap Manager - Enter Destination Password] window appears, enter the password to connect.

The default password is the last four digits of the ScanSnap serial number.

The password can be changed with the ScanSnap Wireless Setup Tool. For details, refer to the ScanSnap Wireless Setup Tool Help.

- If the intended ScanSnap for connection does not appear in the list of the ScanSnap units to be connected, refer to the ScanSnap Manager Help.

⇒ The ScanSnap is connected to the computer via wireless LAN and the ScanSnap Manager icon changes to .

HINT

When the ScanSnap and a computer are connected via wireless LAN, a notification informs you of the communication status.

Connecting the ScanSnap to a Mobile Device

By using the ScanSnap Wireless Setup Tool Wizard, you can configure and check the connection between the ScanSnap and a mobile device.

For details, refer to "[Setting a Wireless LAN Using the ScanSnap Wireless Setup Tool](#)" (page 54).

The following explains how to connect the ScanSnap and a mobile device when the wireless settings have already been configured by using the ScanSnap Wireless Setup Tool Wizard.

1. Start ScanSnap Connect Application on your mobile device.

- ⇒ The mobile device will automatically be connected to an available ScanSnap on the same network.

HINT

- If more than one available ScanSnap is detected, or if ScanSnap Connect Application is set not to connect a mobile device to a ScanSnap automatically, then tap the ScanSnap that you want by name, in order to connect to the mobile device, under [ScanSnap] on the [Connect to] screen. For details, refer to the ScanSnap Connect Application User's Guide for your mobile device.
- A notification appears in the following cases:
 - When the ScanSnap and the mobile device are connected via wireless LAN, and the communication with ScanSnap Manager is disconnected
 - When you log onto the computer which is connected to the ScanSnap with the ScanSnap and the mobile device already connected via wireless LAN

Reconnecting to a Wireless Access Point Using the ScanSnap WPS Button

If the Wi-Fi indicator lights up or flashes in orange, reconnect the ScanSnap to a WPS compatible wireless access point. The reconnection can be established easily by pressing the WPS button on the ScanSnap.

ATTENTION

Perform the following before you connect using the WPS button.

- If the ScanSnap Wireless Setup Tool is running while the ScanSnap is being connected to the computer with a USB cable, exit the ScanSnap Wireless Setup Tool.
- If scanning is currently being performed from ScanSnap Manager or a mobile device, end the scanning operation.

HINT

Button names and operating procedures may differ depending on the wireless access point. For details, refer to the manual for your wireless access point.

1. Turn on the ScanSnap.

For details, refer to "[Turning the ScanSnap On](#)" (page 47).

2. Turn on the Wi-Fi switch on the back of the ScanSnap.

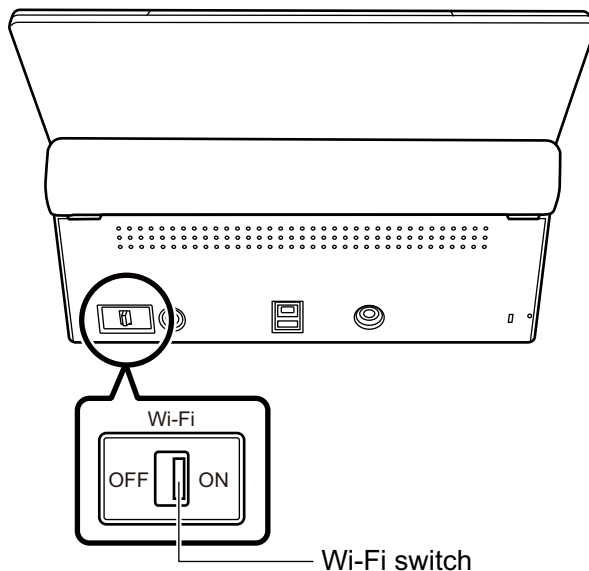

⇒ After blinking blue, the Wi-Fi indicator lights up in blue or orange.

3. Press the WPS button of the wireless access point.

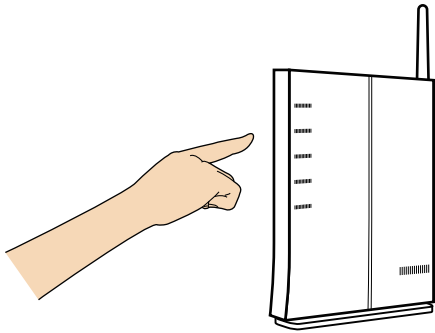

- 4. Press and hold (3 seconds or longer) the WPS button on the back of the ScanSnap within 2 minutes after pressing the WPS button of the wireless access point.**

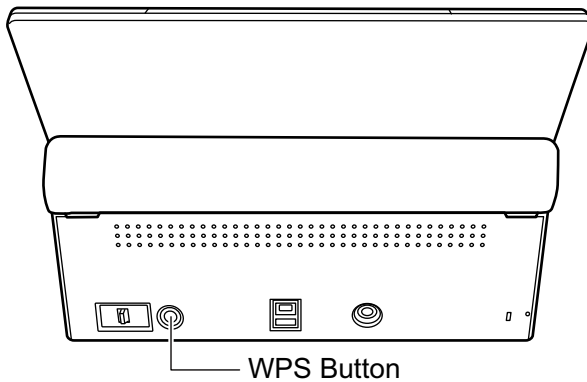

⇒ The ScanSnap is connected to the wireless access point and the Wi-Fi indicator lights up in blue.

If connection cannot be established, the Wi-Fi indicator blinks or lights up in orange.

ATTENTION

If you cannot connect the ScanSnap to a wireless access point, refer to "Troubleshooting" in the ScanSnap Manager Help.

HINT

For details about the Wi-Fi indicator status, refer to "Parts and Functions" (page 36).

Documents to Scan

This section explains about the conditions for documents that can be loaded directly into the ScanSnap and the conditions for documents that can be scanned using the Carrier Sheet.

- ["Documents That Can Be Loaded Directly into the ScanSnap" \(page 61\)](#)
- ["Documents That Can Be Scanned Using the Carrier Sheet" \(page 63\)](#)

Documents That Can Be Loaded Directly into the ScanSnap

Conditions for documents that can be loaded directly into the ScanSnap are as follows:

| | |
|----------------------|---|
| Document type | Office paper, postcards, business cards Plastic cards conforming to the ISO781A ID-1 type (54 × 86 mm/2.1 × 3.4 in.) |
| Paper weight | 40 to 209 g/m ² (10.7 to 55.7 lb) Long page documents 52 to 127 g/m ² (13.9 to 33.9 lb) A8 size (52 × 72 mm) or less 127 to 209 g/m ² (33.9 to 55.7 lb) Plastic cards 0.76 mm (0.03 in.) or less (embossed cards can be used) |
| Paper size | Width 50.8 to 216 mm (2 to 8.5 in.) Length 50.8 to 360 mm (2 to 14.17 in.) For long page (*1), up to 863 mm (34 in.) |

*1: Scanning starts when you hold down the [Scan] button on the ScanSnap for 3 seconds or longer.



If you scan a magnetic card or IC card, do not bring the black magnetic part in contact with the magnetic part of the ADF top section. Otherwise, the data on the card may be lost.

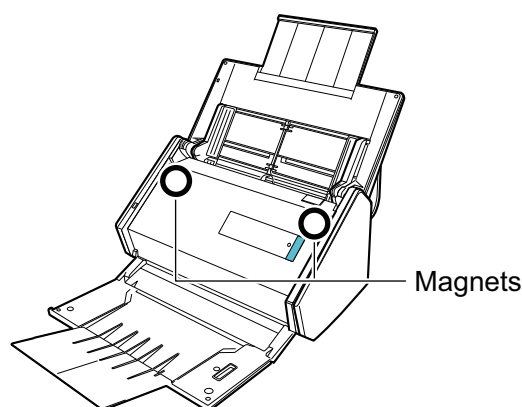

ATTENTION

- The following types of documents must not be scanned:
 - Documents attached with the metals such as paper clips or staples that can damage the inside of the ScanSnap
Remove the metals for scanning.
 - Documents on which the ink is still wet
Wait until the ink dries completely to scan these documents.

- Documents larger than 216 × 863 (mm)/8.5 × 34 (in.) (width × length)
- Documents other than paper such as fabric, metal foil and OHP film
- When you scan picture postcards, be aware that the picture side may get damaged. It is the responsibility of the customer to scan picture postcards.
- When you scan plastic cards, in [Multifeed Detection] of the [Paper] tab of the "[ScanSnap Setup Window](#)" (page 45), select [None] or [Check Length].
- Be careful of the following when you scan plastic cards:
 - Cards that are bent may not be fed properly.
 - If the surface of the card is dirty with grease marks such as fingerprints, perform scanning after wiping the dirt off.
 - When you scan plastic cards with strong luster, some parts of the image may appear lighter or darker than the original.

Example: gold colored credit card

- When you scan embossed cards, put the embossed side down, and load the card in landscape orientation.
- If the embossed characters are not coated in gold or silver and the background color of the card and the color of the embossed characters are similar, it may be difficult for the ScanSnap to recognize embossed characters.

In which case, performing the following may result in an improvement.

1. Click the [Option] button in the [Scanning] tab of the "[ScanSnap Setup Window](#)" (page 45).
 - ⇒ The [Scanning mode option] window appears.
2. Select the [Increase text contrast] checkbox.

Documents That Can Be Scanned Using the Carrier Sheet

The bundled Carrier Sheet is a sheet designed to transport documents through the ScanSnap.

You can scan documents that are larger than A4/Letter size, photographs, and clippings.

Conditions for documents that can be scanned using the Carrier Sheet are as follows:



- Do not use a damaged Carrier Sheet. Otherwise, it may damage or cause the ScanSnap to malfunction.
- Be careful not to cut your finger on the edge of the Carrier Sheet.

| | |
|----------------------|---|
| Document type | Documents that cannot be loaded directly into the ScanSnap |
| Paper weight | Up to 209 g/m ² (55.7 lb) When scanning documents folded in half: Up to 104.5 g/m ² (27.9 lb) |
| Paper size | Carrier Sheet size (216 × 297 mm) A3 (297 × 420 mm) (*1) A4 (210 × 297 mm) A5 (148 × 210 mm) A6 (105 × 148 mm) B4 (257 × 364 mm) (*1) B5 (182 × 257 mm) B6 (128 × 182 mm) Postcard (100 × 148 mm) Business card (90 × 55 mm, 55 × 90 mm) Letter (8.5 × 11 in. (216 × 279.4 mm)) 11 × 17 in. (279.4 × 431.8 mm) (*1) Custom size Width: 25.4 to 216 mm (1 to 8.5 in.) Length: 25.4 to 297 mm (1 to 11.69 in.) |

*1: Fold in half to scan.

Documents for Which the Carrier Sheet is Recommended for Scanning

It is recommended that you use the Carrier Sheet to scan the following documents.

- Documents written in pencil

Because there may be black traces left on the documents, it is recommended that you use the Carrier Sheet to scan such documents.

When you scan such documents directly without using a Carrier Sheet, dirt will accumulate on the rollers, which may cause feeding errors. Clean the rollers occasionally.

For details about how to perform cleaning, refer to "[Cleaning the Inside of the ScanSnap](#)" (page 120).

- Carbonless paper

Because carbonless paper may contain chemicals that can harm the ScanSnap internal rollers, it is recommended that you use the Carrier Sheet to scan such documents.

Make sure to clean the rollers occasionally to maintain the scanner performance when scanning carbonless paper directly without using the Carrier Sheet. For details about how to perform cleaning, refer to "[Cleaning the Inside of the ScanSnap](#)" (page 120).

Depending on the type of carbonless paper, the life span of the scanner may be shortened compared to scanning office paper.

- Scanning the following types of documents without using the Carrier Sheet can result in documents being damaged or scanned incorrectly
 - Documents smaller than 50.8 × 50.8 (mm)/2 × 2 (in.) (width × length)
 - Documents whose paper weight is less than 40 g/m² (10.7 lb)
 - Documents with an uneven surface (such as envelopes and paper sheets with attached materials)
 - Wrinkled or curled documents
 - Folded or torn documents
 - Tracing paper
 - Coated paper
 - Photographs (photographic paper)
 - Perforated or punched documents
 - Documents that are not rectangular or square
 - Carbon paper or thermal paper
 - Documents with memo papers or sticky notes attached

ATTENTION

- Using the Carrier Sheet

Be careful of the following when you use the Carrier Sheet:

- Do not stain, or cut the end with a black & white pattern. Otherwise, the Carrier Sheet will not be recognized properly.
- Do not place the Carrier Sheet upside down. Otherwise, a paper jam may occur and damage the Carrier Sheet and the document inside.
- Do not fold or pull the Carrier Sheet.
- Paper jams may occur when several small size documents such as photographs and postcards are placed inside the Carrier Sheet to be scanned at once. It is recommended that you scan such documents one at a time.
- If paper jams occur frequently, feed about 50 sheets of PPC paper (recycled paper) before scanning with the Carrier Sheet. The PPC paper can either be blank or printed.

- Storing the Carrier Sheet

Be careful of the following when you store the Carrier Sheet:

- Do not leave your document inside the Carrier Sheet for a long time. Otherwise, the ink on the document may be transferred onto the Carrier Sheet.
- Do not leave the Carrier Sheet in high temperature places such as under direct sunlight or near a heating apparatus for a long time. Also, do not use the Carrier Sheet in high temperature places. The Carrier Sheet may be deformed.
- To avoid deformation, store the Carrier Sheet on a flat surface without any weight on it.

What You Can Do with Related Software

This section explains the basic operation procedure of software related to the ScanSnap and gives an overview of its functions.

- ["What You Can Do with the ScanSnap Organizer" \(page 66\)](#)
- ["What You Can Do with CardMinder" \(page 72\)](#)

What You Can Do with the ScanSnap Organizer

ScanSnap Organizer is an application used for displaying, organizing, and managing image data (PDF or JPEG files) scanned with the ScanSnap.

You can use this application to display image data (PDF or JPEG files) without opening them, create folders and arrange files for various uses.

Pages of a PDF file can also be flipped through in thumbnails to verify the scanned image data.

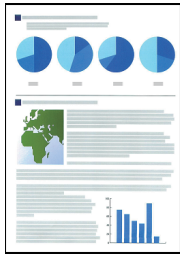

Scan documents with the ScanSnap

Main Window

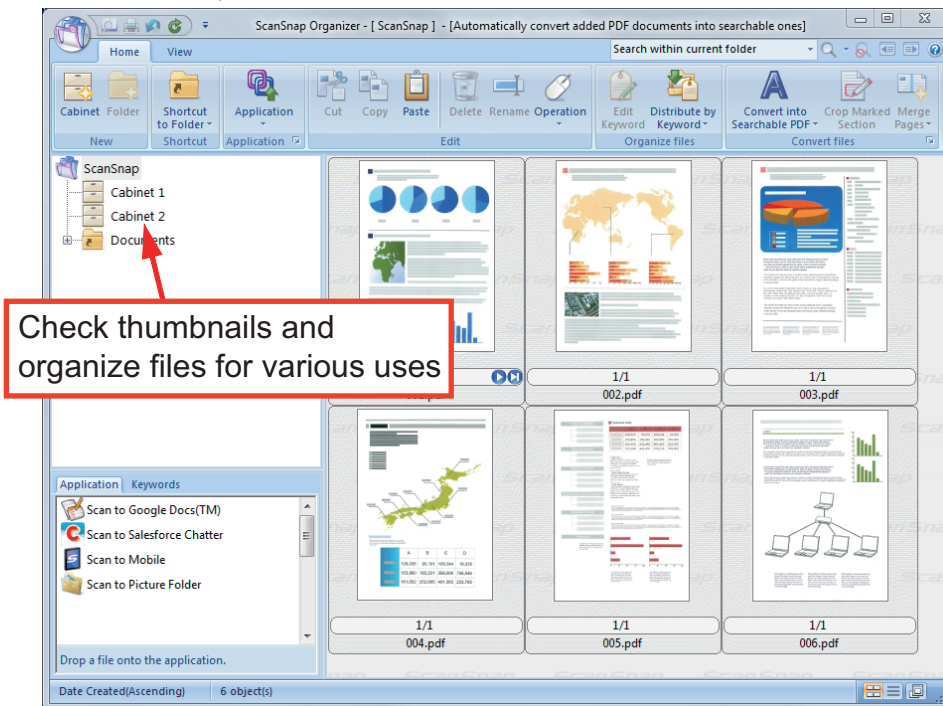

- "Basic Operation Procedure of ScanSnap Organizer" (page 67)
- "Managing Files" (page 69)
- "Using Files" (page 71)

Basic Operation Procedure of ScanSnap Organizer

This section explains the basic operation procedure of ScanSnap Organizer.

1. Start up ScanSnap Organizer.

Start up ScanSnap Organizer by double-clicking the [ScanSnap Organizer] icon on the desktop.

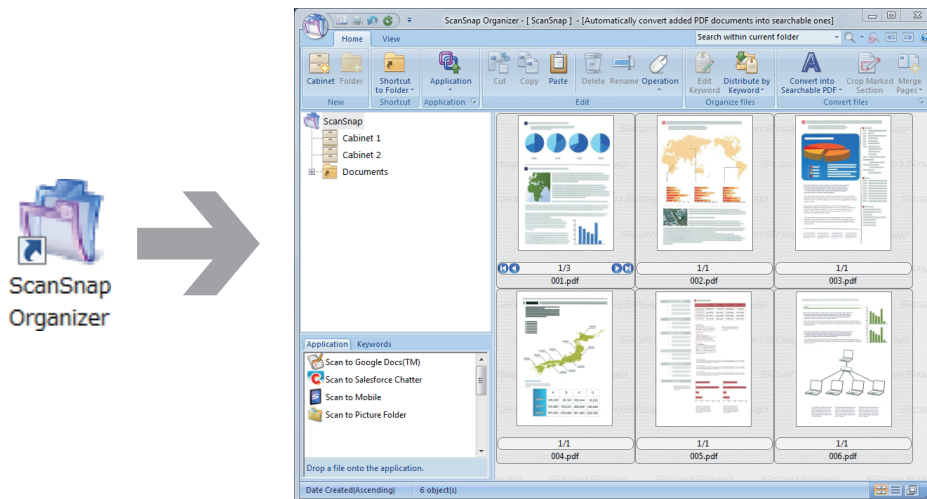

2. Scan documents with the ScanSnap.

⇒ A list of scanned images is displayed in ScanSnap Organizer.

3. Start up ScanSnap Organizer Viewer.

Double-click a scanned image to start up the Viewer Window for displaying and editing scanned images.

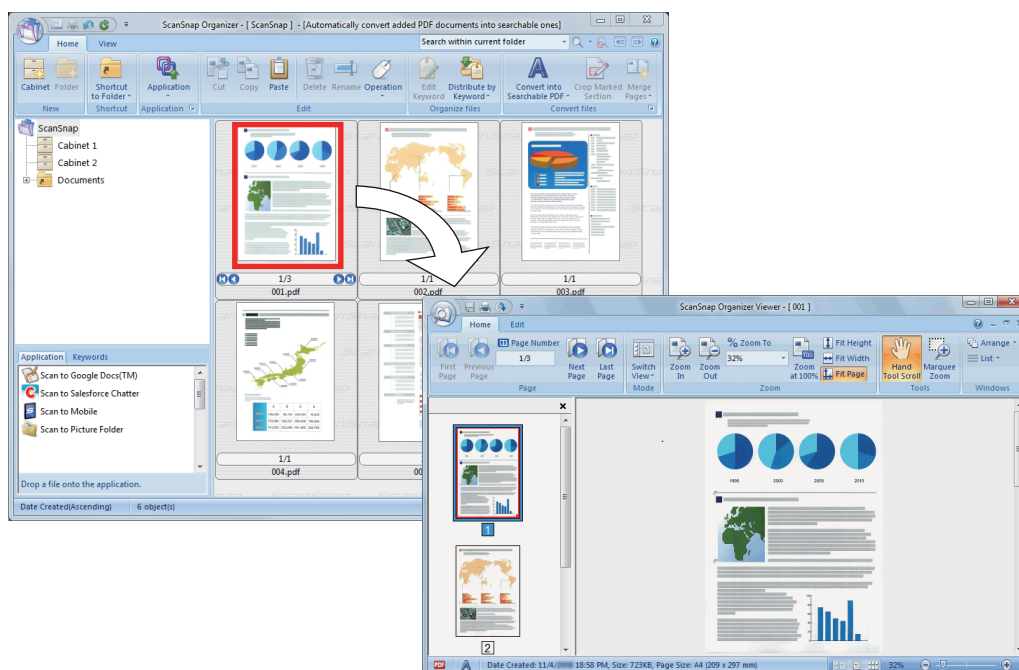

4. In the Viewer Window, check the orientation of scanned images, and check for unnecessary pages.

Rotate any scanned images that are not oriented correctly. Delete any unnecessary pages. Make other edits such as inserting a page where necessary.

5. Exit ScanSnap Organizer Viewer.

To exit ScanSnap Organizer Viewer, click the Application button and then click the [Exit] button in the menu that appears.

Managing Files

For details about operations, refer to the ScanSnap Organizer Help.

Setting Keywords for a File

You can set a character string (keyword) indicating the content of a PDF file so that you can immediately recognize the file without opening it.

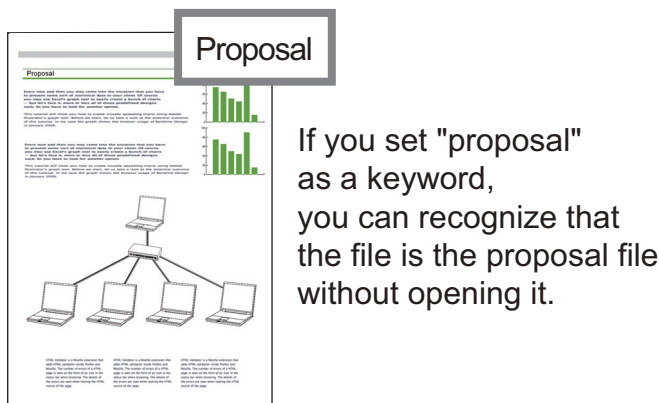

Setting a Marked Character String as a Keyword

Keywords can be set to a PDF file by using the keyword setting function.

These keywords can be used when you search for PDF files.

When black and white documents that have been marked are scanned by the ScanSnap, the marked character strings are set as keywords for the PDF file.

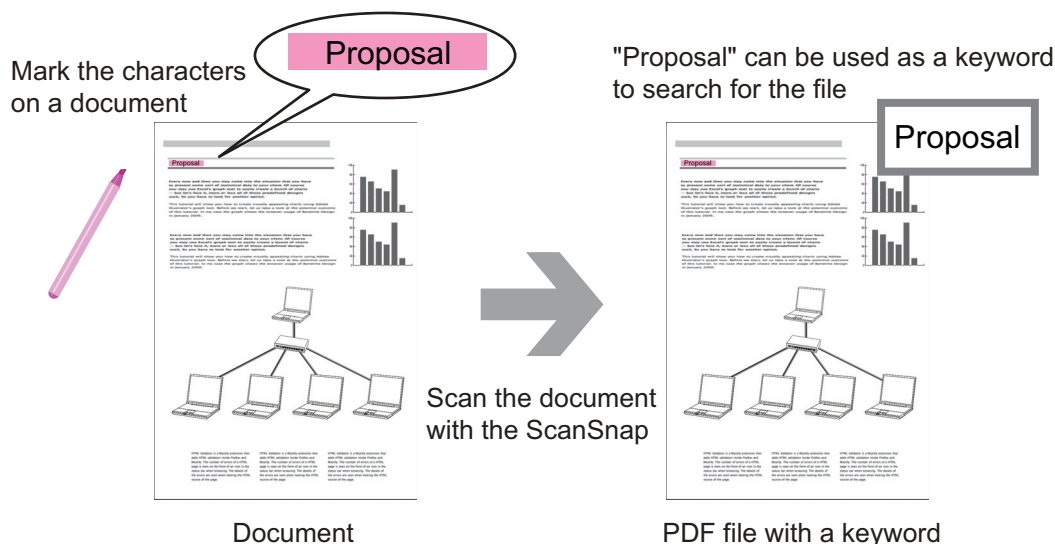

For other keyword setting methods, refer to ScanSnap Organizer Help.

Recognizing a Character String in a Page to Embed It into the Page

By using text recognition (OCR) software, you can embed character strings into the page of a PDF file scanned by the ScanSnap, and then search the PDF file using the character strings.

OCR recognizes "proposal" as textual information.

Proposal

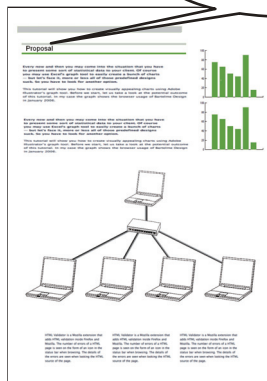

PDF file



"Proposal" can be used as a keyword to search for the file

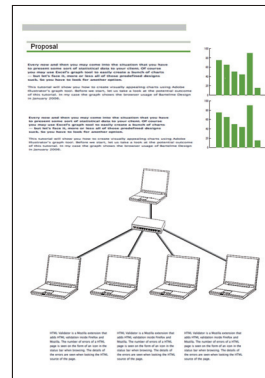

Searching Files

You can search files that are managed in ScanSnap Organizer.

There are two search methods of Adobe Acrobat search and Windows Desktop Search.

Automatically Distributing Files According to Set Conditions

You can use the keyword distribution function so that PDF files are automatically distributed into cabinets and folders according to the keywords that have been set.

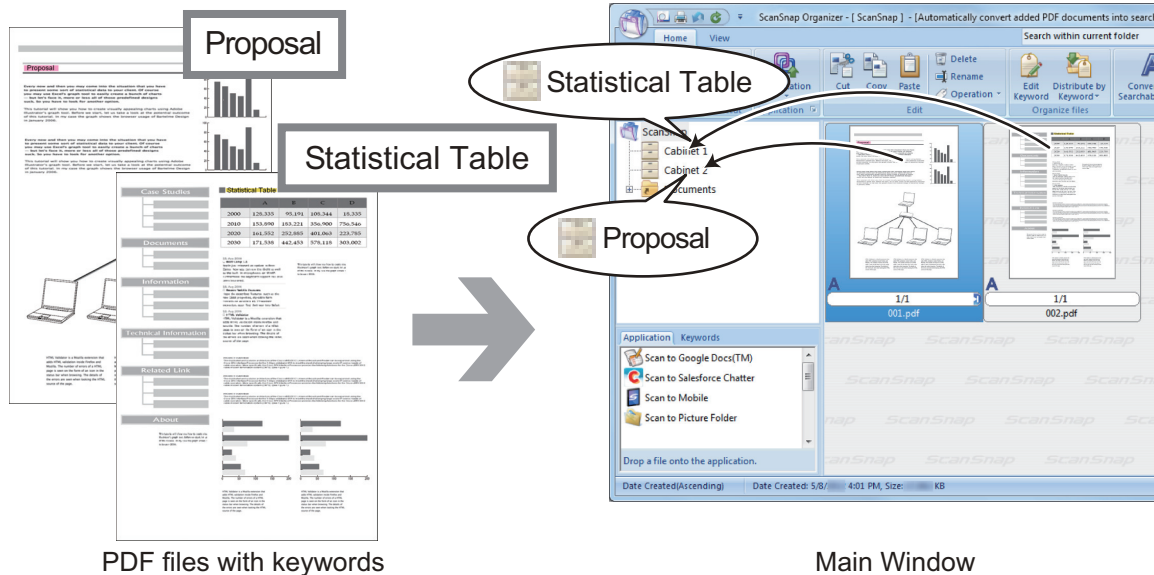

Using Files

For details about operations, refer to the ScanSnap Organizer Help.

Linking Files with Other Applications

You can use files with a variety of applications.

The applications that can be used are displayed in the Application List Pane at the lower left corner of the Main Window.

Sending Files by E-mail

Files can be sent by e-mail.

Clipping Important Items from Documents

You can use the marked section cropping function to clip important items from documents.

Mark the necessary sections of a black & white document and scan it with the ScanSnap to create a new PDF or JPEG file that contains only the marked section.

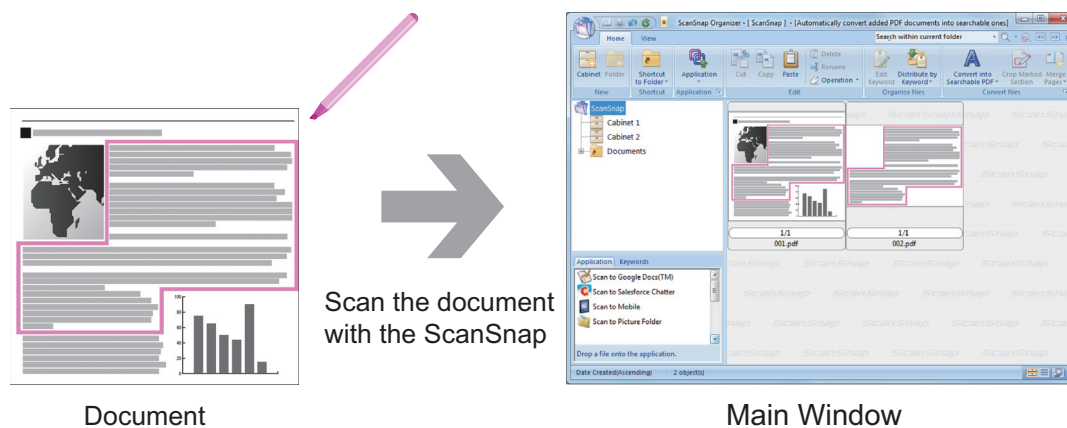

What You Can Do with CardMinder

CardMinder is an application used for displaying, organizing, and managing card image data scanned with a scanner.

This application digitalizes large amounts of business cards into images at a high speed and recognizes text on those cards, thus allowing you to search for your clients' business cards from those data quickly, and create your client databases conveniently. CardMinder uses an Optical Character Recognition (OCR) engine to recognize text on cards and shares the data with Personal Information Manager (PIM) applications.

CardMinder contains two separate functions: CardMinder Viewer to enable business card data to be quickly searched from other applications, and CardMinder Mobile Viewer to enable scanned business card data to be viewed on a computer in which CardMinder is not installed.

Card



Scan

CardMinder Window

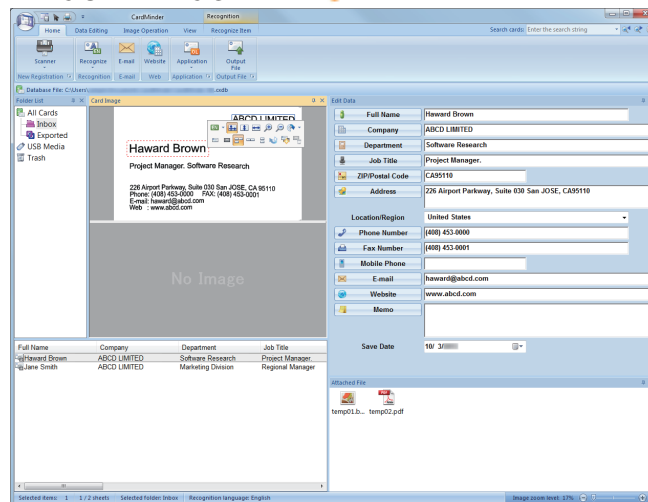

Recognized data

PIM Window
(Example: Windows Mail (*))



*: This is the Windows Vista example.

- "Basic Operation Procedure of CardMinder" (page 74)
- "Linking Card Data with Other Applications" (page 77)
- "Searching Card Data with the Basic Search Toolbar" (page 78)
- "Searching Card Data with CardMinder Viewer" (page 79)
- "Attaching a File to Card Data" (page 80)

Basic Operation Procedure of CardMinder

This section explains the basic operation procedure of CardMinder.

1. Start CardMinder.

Start up CardMinder by double-clicking the [CardMinder] icon on the desktop.

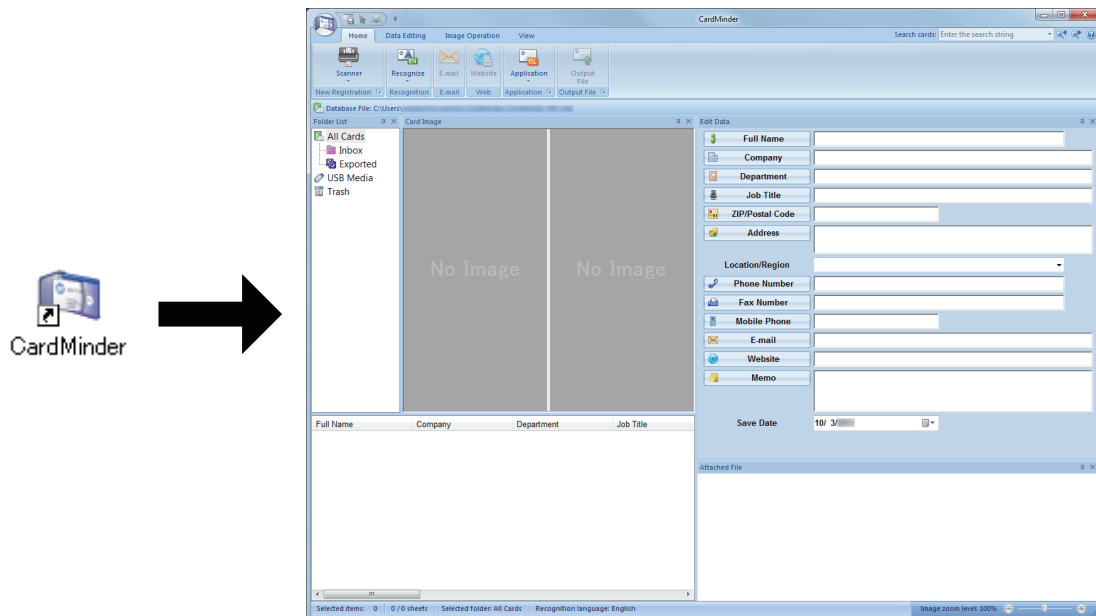

2. Scan a card with the scanner.

Click the [Scanner] button on the [Home] tab to start scanning a card.

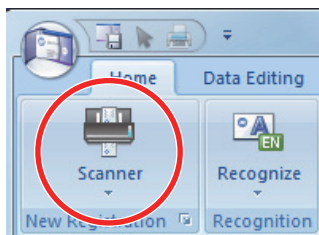

When scanning is complete, the information printed on the card (such as name, company, and address) is automatically recognized as text and displayed in the Edit Data pane.

The image data scanned from the card is displayed in the Card Image pane.

ATTENTION

ScanSnap Manager must be installed on your computer when you want to recognize the following languages:

- Chinese (simplified)
- Chinese (traditional)
- Korean

3. Check the card data.

Make sure that the front and back card images are correct, and that the text on the card images are displayed correctly in the Edit Data pane.

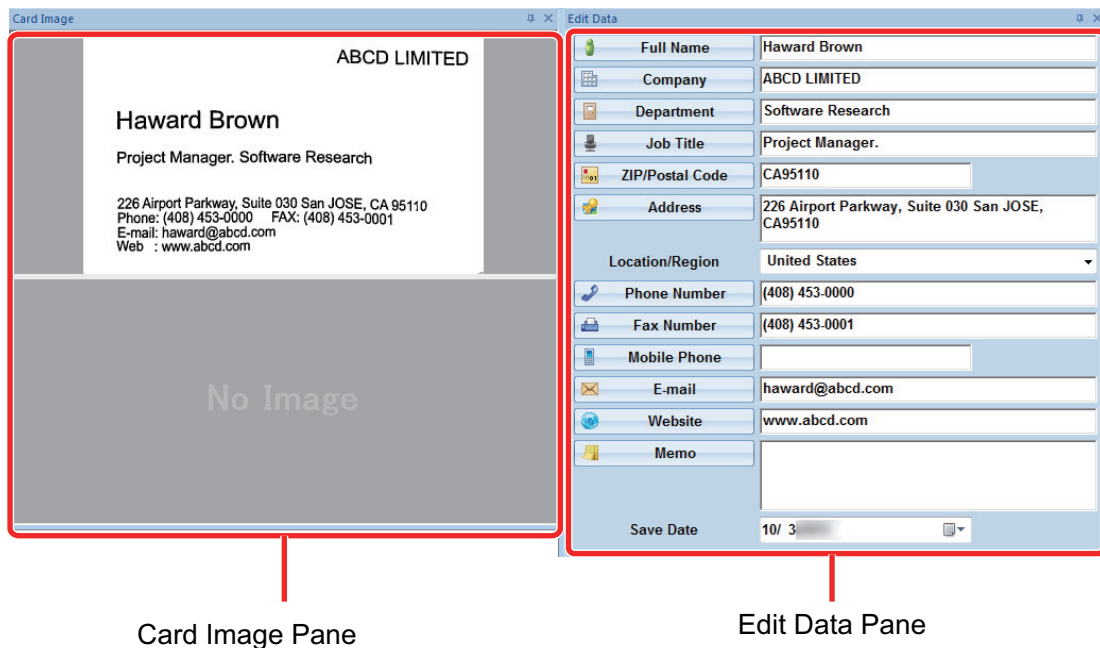

Card Image Pane

Edit Data Pane

4. If the language to be used for text recognition is different, perform text recognition again in the following procedure:

1. Click  on the [Home] tab.
 - ⇒ The recognized languages are displayed.
2. Select a language for the character strings to be recognized.
 - ⇒ The icon for the [Recognize] button changes to the selected language.
3. Click the icon for the [Recognize] button.



Example: To recognize English, click .

⇒ A confirmation message for the recognition process is displayed.

4. Click the [Yes] button.
 - ⇒ Character strings on the card data will be recognized as the selected language.

5. Correct the card data, if necessary.

The card data can be corrected in the following ways. For details, refer to the CardMinder Help.

- Redoing the recognition process on the character strings in the selected areas
- Entering text directly in the Edit Data pane
- Correcting the orientation of the card image or switching the front and back images

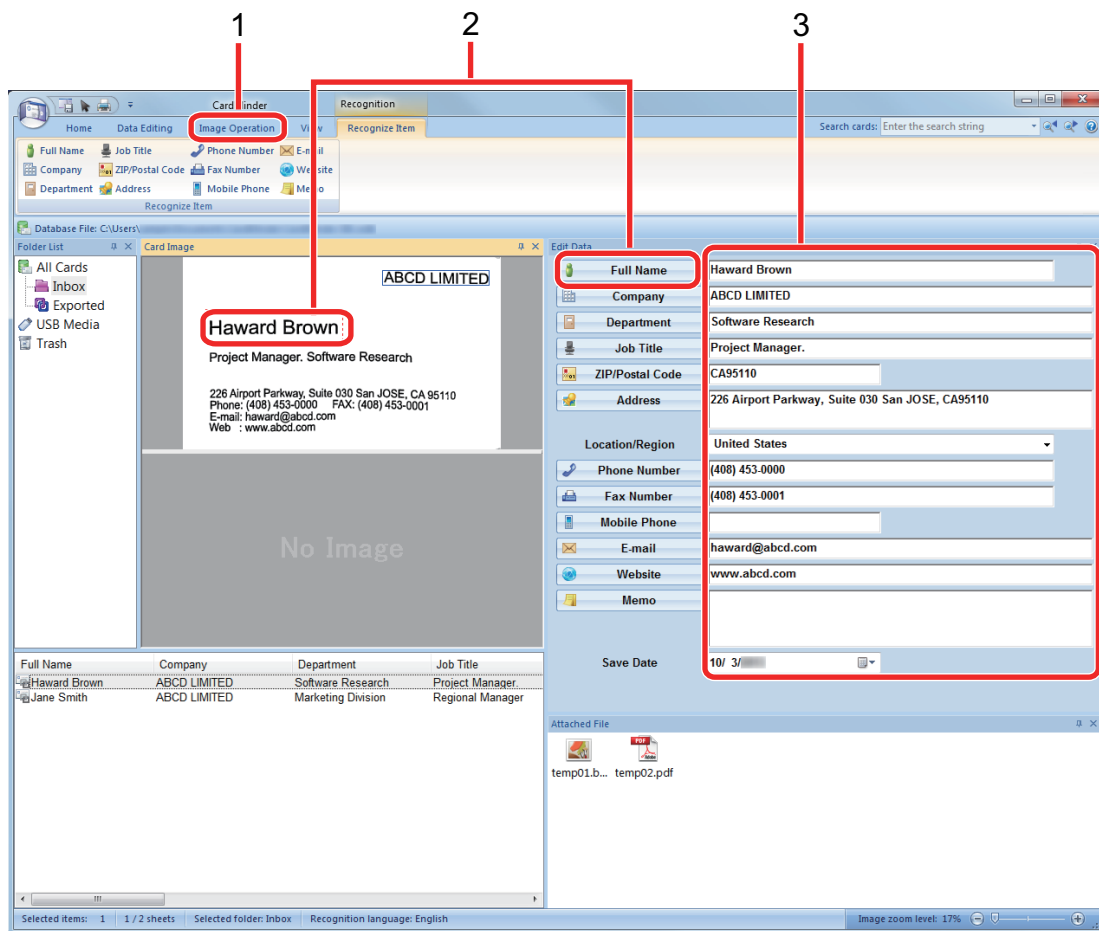

| No. | Description |
|-----|---|
| 1 | In the [Image Operation] tab, you can perform corrections, such as rotating the card image or switching the front and back images. |
| 2 | By selecting character strings in the card image and then clicking the buttons of the appropriate fields in the Edit Data pane, you can redo the recognition process on the selected areas. |
| 3 | You can directly correct the text of each field in the Edit Data pane. |

6. Exit CardMinder.

To exit CardMinder, click the application button and then click the [Exit] button in the menu that appears.

Linking Card Data with Other Applications

Click the following buttons on the [Home] tab to use card data in a variety of applications.

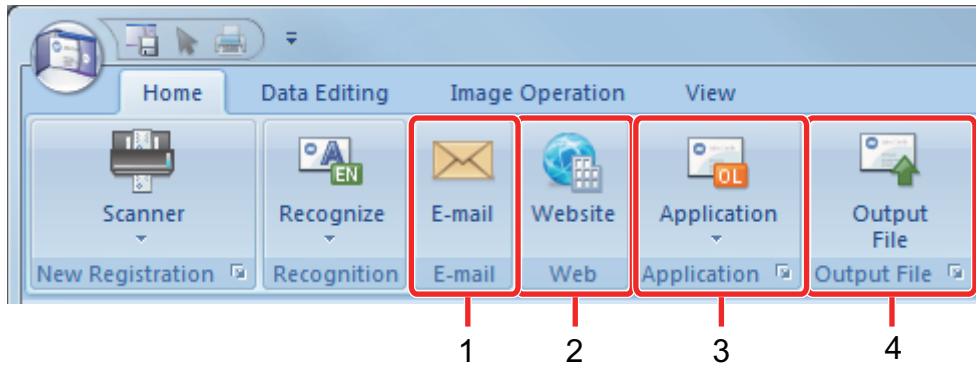

| No. | Item | Description |
|-----|--|--|
| 1 | E-mail | You can start an e-mail program, using the e-mail address specified in [E-mail] for the card data as the destination address. |
| 2 | Internet search | You can search the URL specified in [Website] for the card data with a web browser. |
| 3 | Linking card data with another application | You can link card data with another application such as Outlook Express or Salesforce CRM to use the card data in the linked application. You can also link card data with USB media to use the card data on a different computer. |
| 4 | Outputting card data in a different format | You can output card data in the vCard, CSV, text, or ContactXML format. |

For details, refer to CardMinder Help.

Searching Card Data with the Basic Search Toolbar

This section explains how to search card data with the CardMinder Basic Search Toolbar.

Search cards (Basic Search Toolbar)

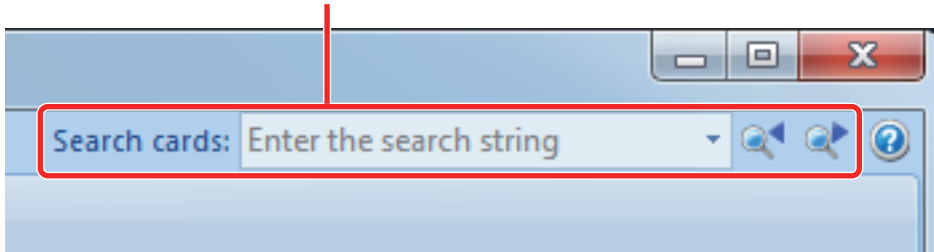

To search card data, type in a search term (such as an individual name or a company name) in the Basic Search Toolbar.

The search results are displayed in the main window.

If multiple cards match the search conditions, click  to display the next result of the search in the main window.

Searching Card Data with CardMinder Viewer

This section explains how to search card data with CardMinder Viewer.

Even when CardMinder is not running, you can search card data by using a character string in another application (such as Microsoft Notepad) as the keyword for searching.

- 1. Drag the mouse to select a character string you want to search for.**
- 2. Press [Alt] + [F3] keys on the keyboard at the same time.**
 - ⇒ CardMinder Viewer starts and the card data found, based on the search conditions entered (such as an individual name and a company name), is displayed in the window.

If multiple cards match the search conditions, click  to display the next result of the search in the CardMinder Viewer window.

HINT

Click  to display in the CardMinder window the details of the card data selected in the CardMinder Viewer window.

Attaching a File to Card Data

A file can be attached to card data easily by dragging and dropping it.

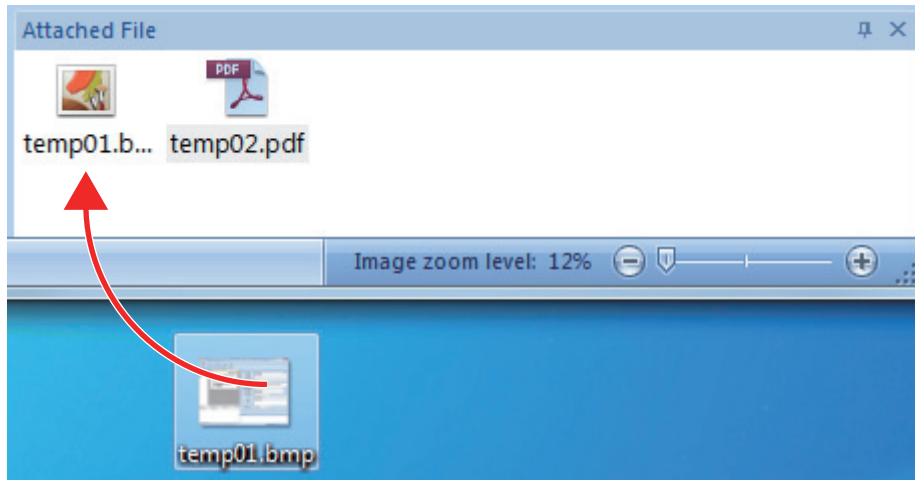

Useful Usages

This section explains how to use related software for the scanned image that is created after a document is scanned with the ScanSnap and how to scan a document with a setting other than the default setting.

- ["Managing Paper Documents by Folder on a Computer" \(page 82\)](#)
- ["Saving Business Cards to a Computer" \(page 85\)](#)
- ["Scanning Documents Larger Than A4 or Letter Size" \(page 87\)](#)
- ["Scanning Documents Such as Photographs and Clippings" \(page 91\)](#)

Managing Paper Documents by Folder on a Computer

This section explains how to digitize paper documents and manage the data by folder in ScanSnap Organizer.

1. Scan a paper document with the ScanSnap.

For details about scanning a document, refer to "Scanning a Document" (page 19).

⇒ The Quick Menu appears.

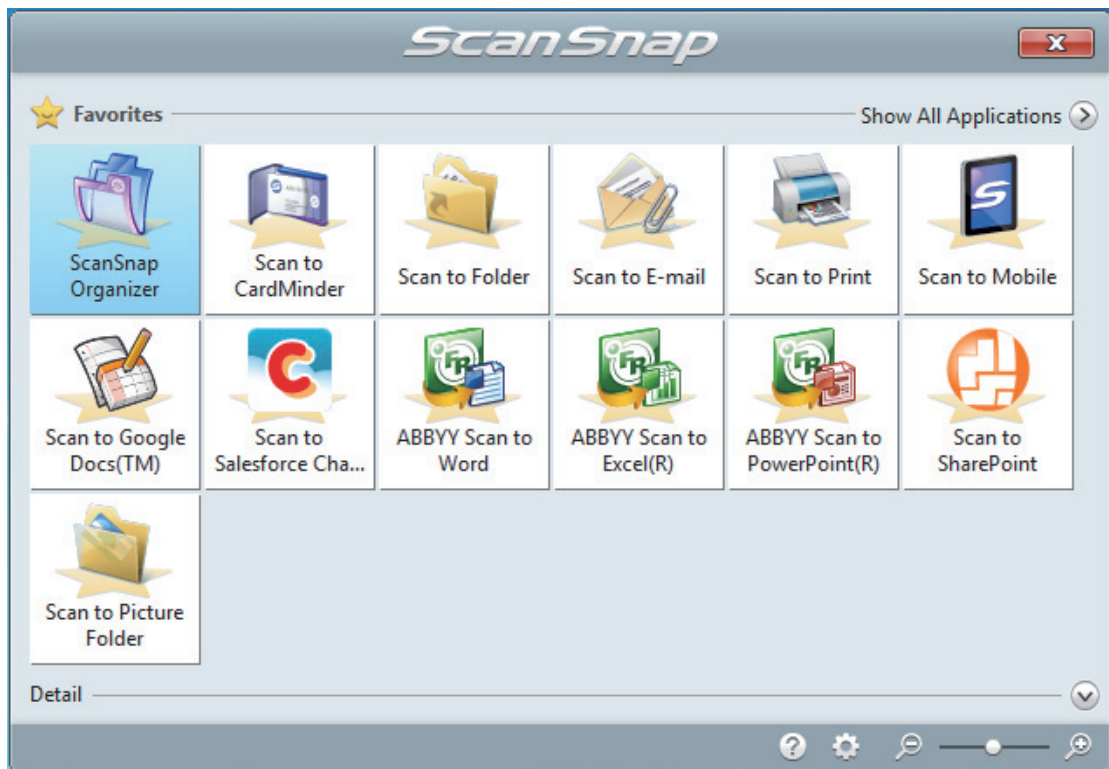

2. Click the [ScanSnap Organizer] icon in the Quick Menu.

⇒ The [ScanSnap Organizer] window appears.

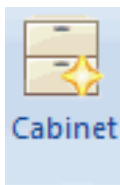
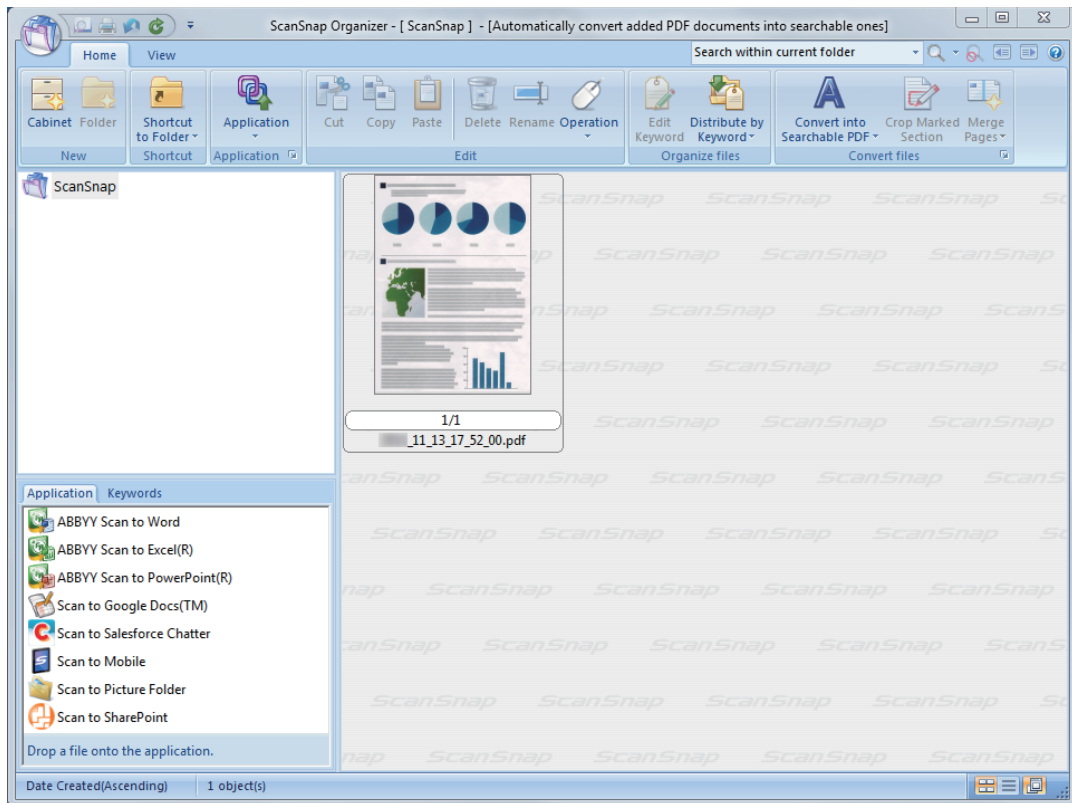

3. Click **Cabinet** on the [Home] tab.
⇒ A new cabinet is created in the folder list.

4. **Rename the created cabinet.**

HINT
To create multiple cabinets, repeat steps 3 to 4.

5. **Select the scanned image from the file list, and drag and drop it to the cabinet.**

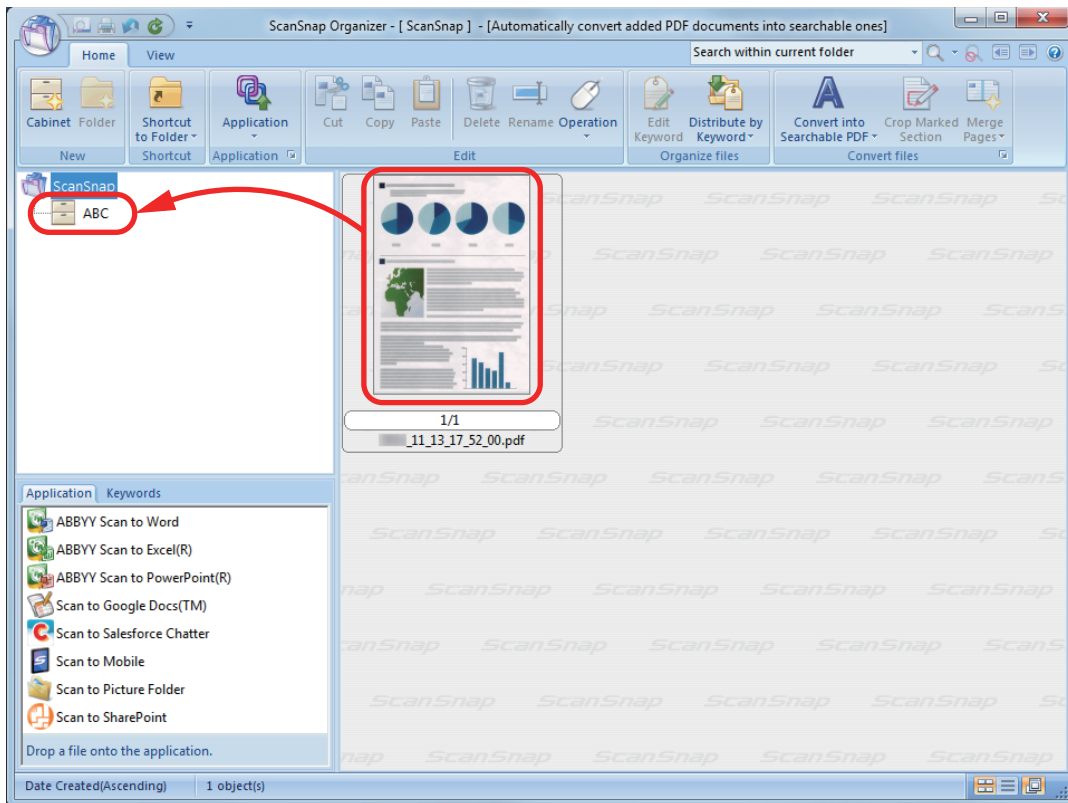

⇒ The scanned image is moved to the cabinet.

HINT

ScanSnap Organizer has various functions for using saved files.
For details, refer to the ScanSnap Organizer Help.

Saving Business Cards to a Computer

This section explains how to digitize business cards and save the card data in CardMinder.

ATTENTION

If you do not log on as a user with Administrator privileges, you may not be able to link the ScanSnap with another application properly.

1. Scan business cards with the ScanSnap.

For details about scanning business cards, refer to "Scanning a Document" (page 19).

⇒ The Quick Menu appears.



2. Click the [Scan to CardMinder] icon in the Quick Menu.

⇒ The [CardMinder] window appears.

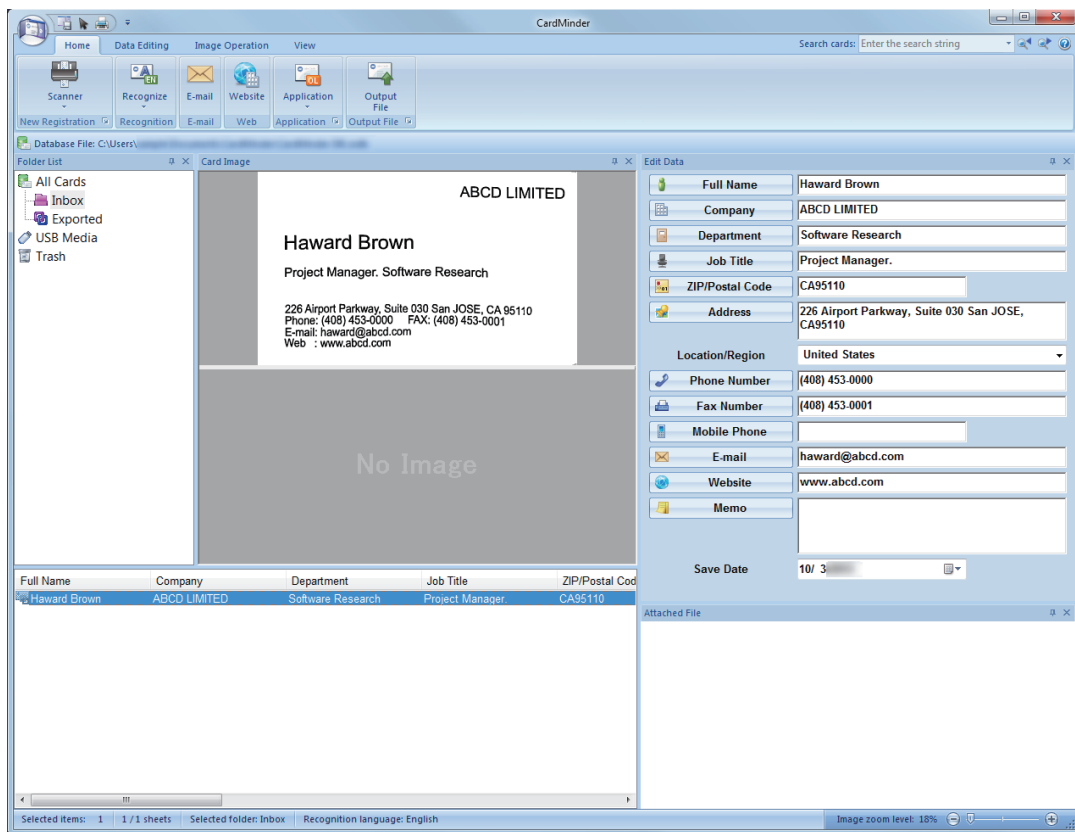

3. Check the card data.

Make sure that the text on the card images are displayed correctly in the Edit Data pane. If the card data must be corrected, click the text to be corrected and then directly edit it.

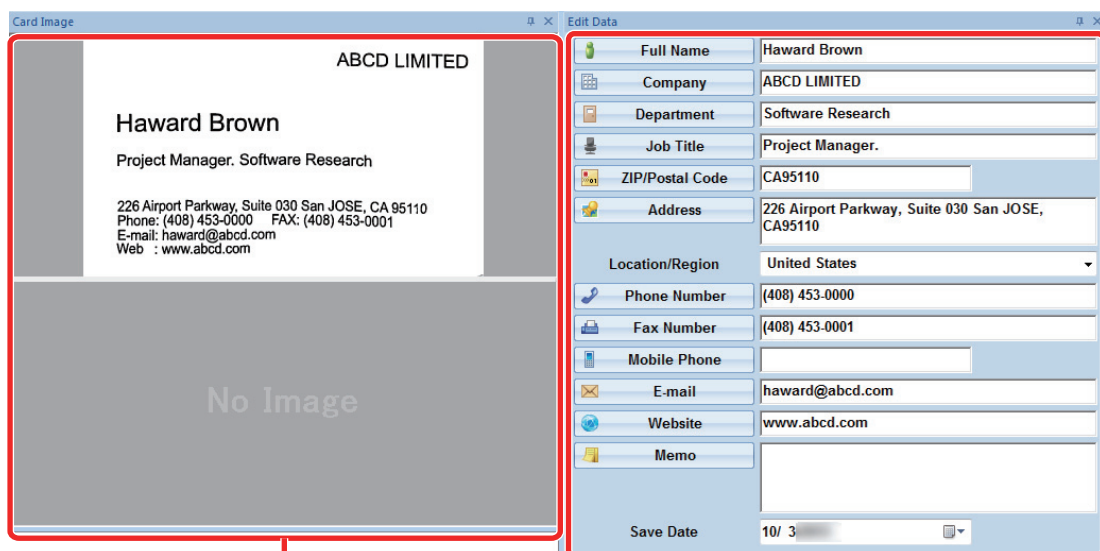

Card Image Pane

Edit Data Pane

HINT

When you scan double-sided business cards, you must scan one side of each card and edit the card data in CardMinder.

For details, refer to the CardMinder Help.

Scanning Documents Larger Than A4 or Letter Size

Documents larger than A4/Letter size (such as A3, 11 × 17 in. and B4) can be scanned with the Carrier Sheet. By folding the document in half and scanning in duplex mode, the two sides are merged into a single image.

For details about documents that can be loaded, refer to ["Documents That Can Be Scanned Using the Carrier Sheet"](#) (page 63).

ATTENTION

The [Deskew by text on document] checkbox in the [Scanning mode option] window will be disabled. To open the [Scanning mode option] window, click the [Option] button in the [Scanning] tab of the ["ScanSnap Setup Window"](#) (page 45).

HINT

Both sides of a double-sided A4/Letter size document or smaller can also be scanned and merged into a single image.

1. **Right-click the ScanSnap Manager icon  in the notification area located at the far right of the taskbar, and select the [Scan Button Settings] from the "Right-Click Menu" (page 43).**
⇒ The ScanSnap setup window appears.
2. **In the [Paper] tab, select [Automatic detection] in [Paper size], and then click the [Carrier Sheet Settings] button.**

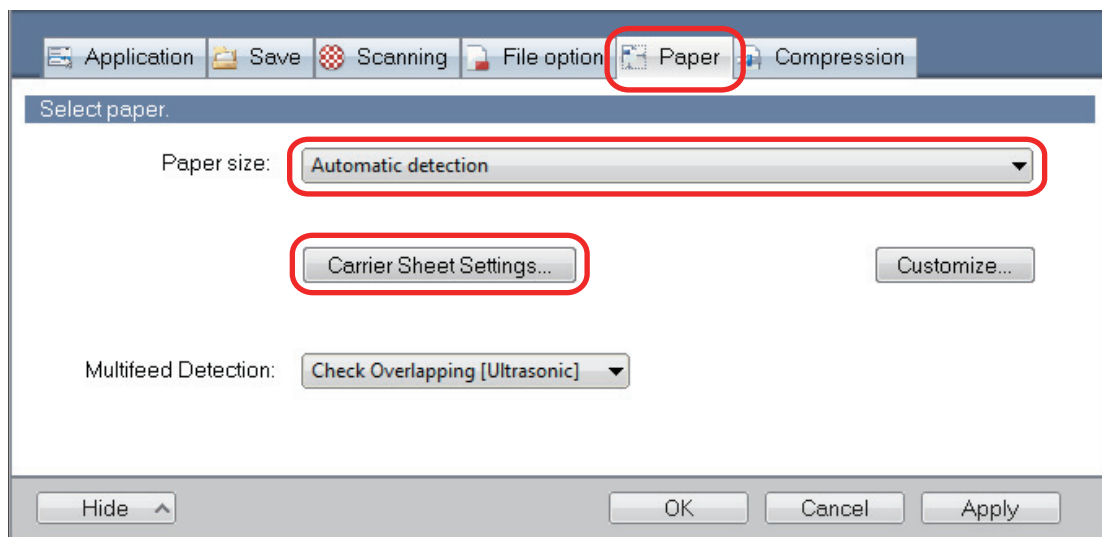

⇒ The [Carrier Sheet Settings] window appears.

3. **Select [one double-page spread image] in [Save as] and click the [OK] button.**

For details, refer to the ScanSnap Manager Help.

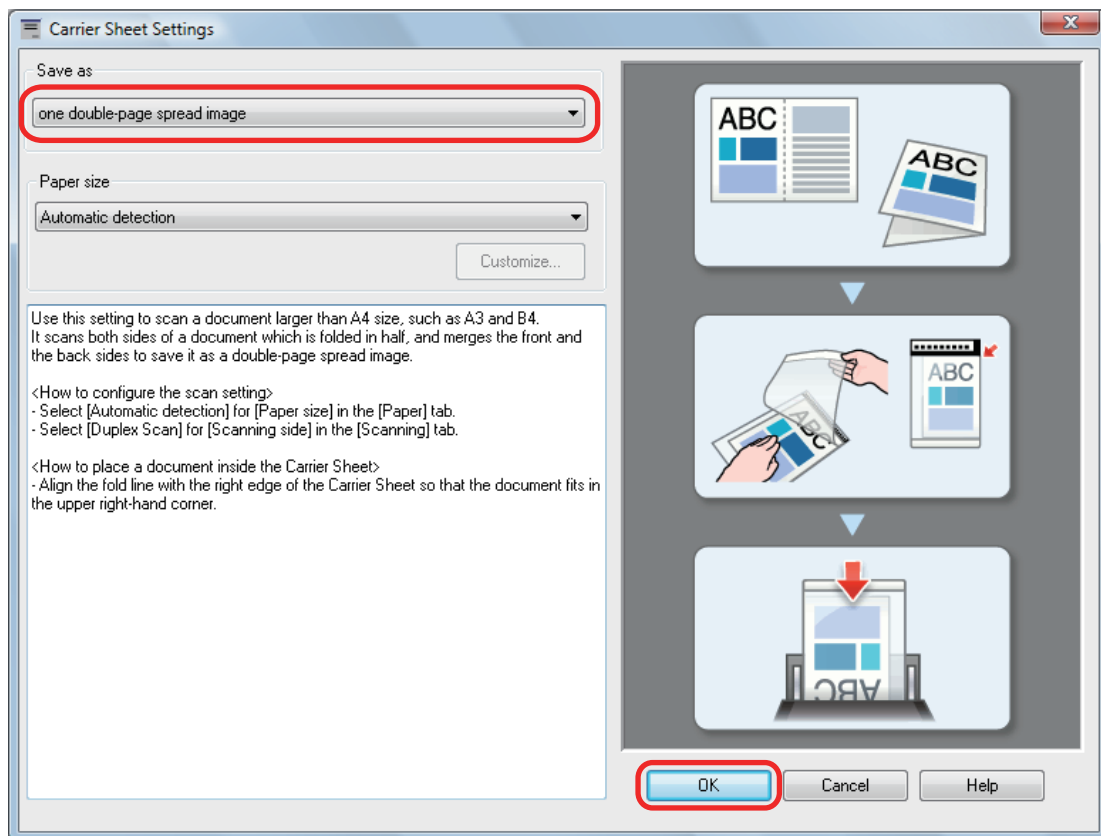

4. In [Scanning side] in the [Scanning] tab, select [Duplex Scan (Double-sided)] and click the [OK] button.

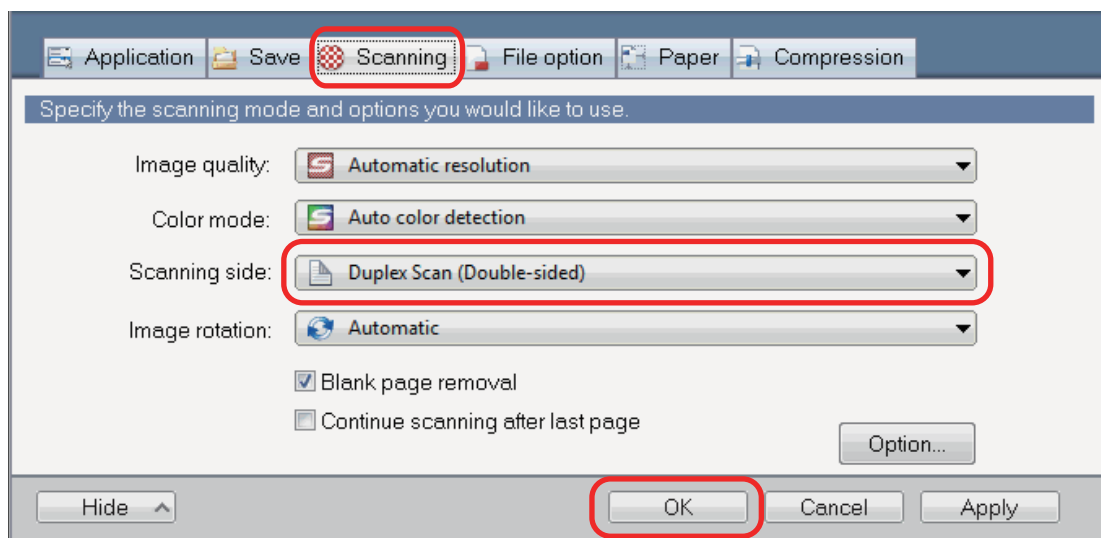

ATTENTION

If [Simplex Scan (Single-sided)] is selected, the ScanSnap outputs the same result as performing a simplex scan in [two separate images (front and back)] mode.

5. Place the document inside the Carrier Sheet.

1. Fold the document in half with the sides to be scanned facing out.
Fold it tightly and smooth out any creases.

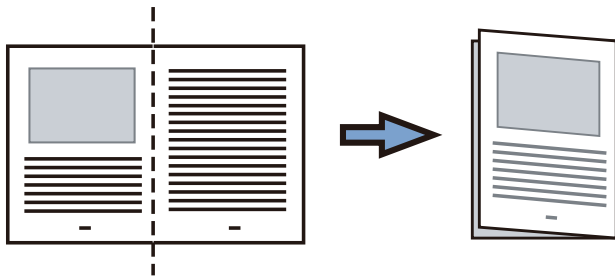

2. Open the Carrier Sheet to bind the document.

Align the fold line with the right edge of the Carrier Sheet so that the document fits in the upper right-hand corner of the Carrier Sheet.

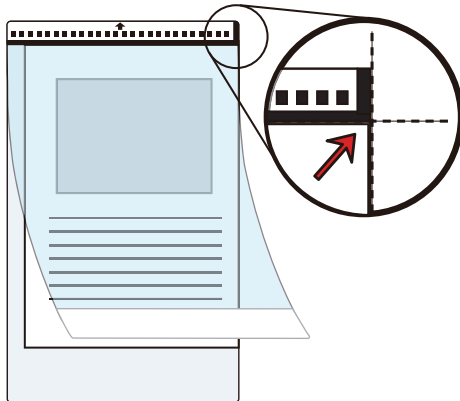

HINT

Note that the front side of the Carrier Sheet has a black and white pattern at the top and a thick vertical line in the upper right-hand corner.

- 6. Place the end with the black and white pattern as the leading edge in the direction of the arrow.**

Secure the Carrier Sheet with the side guides to avoid skewing.

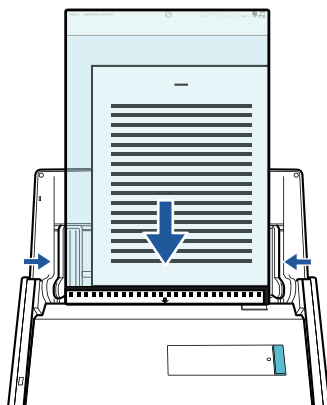

- 7. Press the [Scan] button on the ScanSnap to start a scan.**

⇒ Both sides of the document are scanned and saved as one double-page spread image.

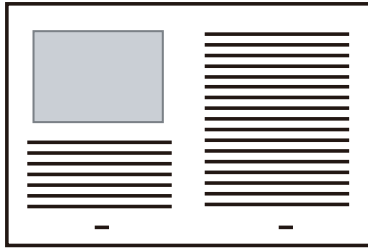

ATTENTION

- There may be a line or a gap appearing between the front and back side images. Also when you scan a thick document in the Carrier Sheet, the scanned image on the left and the scanned image on the right of a double-page spread image may skew towards each other from the top.

These symptoms may be improved when you place the document in the Carrier Sheet as follows:

- Fold the document properly
- Neatly align the edges of the document with the edges of the Carrier Sheet
- Turn over the Carrier Sheet to the other (reverse) side
- If [Automatic detection] is specified for [Paper size] in the [Carrier Sheet Settings] window, an optimal size will be selected automatically from the available standard sizes (A3, B4, or 11 × 17 in.) in [Paper size]. Note that the size of the image may become smaller than the original document depending on the document.

Example: When characters and illustrations are printed to fit in A4 size in the center of an A3 size document, the scanned image is output in B4 size.

To output the scanned image in its original size, specify the document size in [Paper size].

- Part of the scanned image around where the document is folded may appear missing. In that case, place the document so that its edge is about 1 mm (0.04 in.) inside from the edge of the Carrier Sheet.

HINT

Multiple Carrier Sheets can be loaded in the ADF paper chute (cover) and scanned.

Scanning Documents Such as Photographs and Clippings

Using the Carrier Sheet allows you to scan documents that can be damaged quite easily such as photographs, or non-standard size documents that are difficult to load directly such as clippings.

For details about documents that can be loaded, refer to ["Documents That Can Be Scanned Using the Carrier Sheet"](#) (page 63).

ATTENTION

The [Deskew by text on document] checkbox in the [Scanning mode option] window will be disabled.

To open the [Scanning mode option] window, click the [Option] button in the [Scanning] tab of the ["ScanSnap Setup Window"](#) (page 45).

1. Right-click the ScanSnap Manager icon  in the notification area located at the far right of the taskbar, and select the [Scan Button Settings] from the ["Right-Click Menu"](#) (page 43).

⇒ The ScanSnap setup window appears.

2. In the [Paper] tab, select [Automatic detection] in [Paper size], and then click the [Carrier Sheet Settings] button.

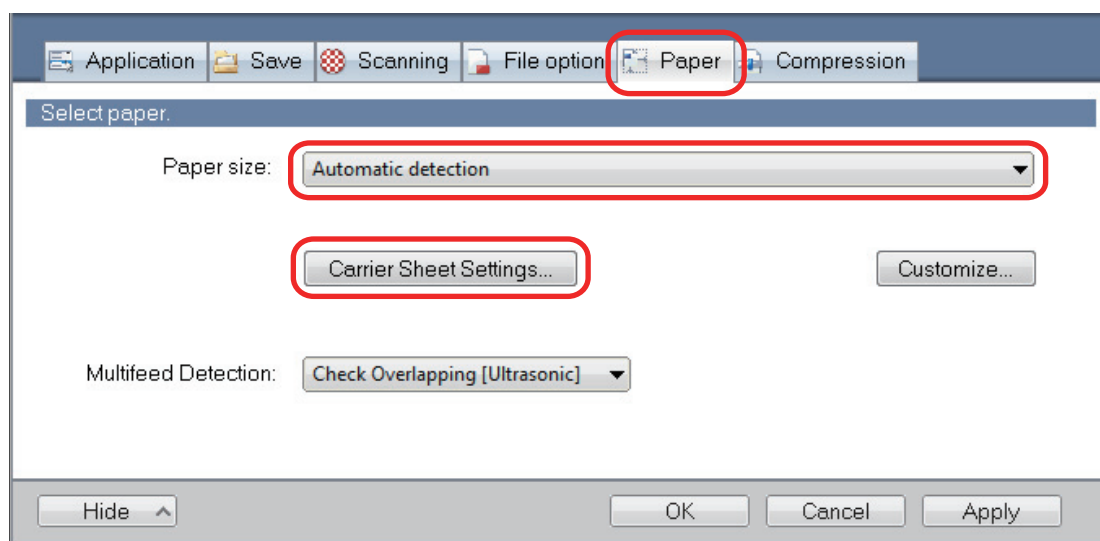

⇒ The [Carrier Sheet Settings] window appears.

3. Select [two separate images (front and back)] in [Save as] and click the [OK] button.

For details, refer to the ScanSnap Manager Help.

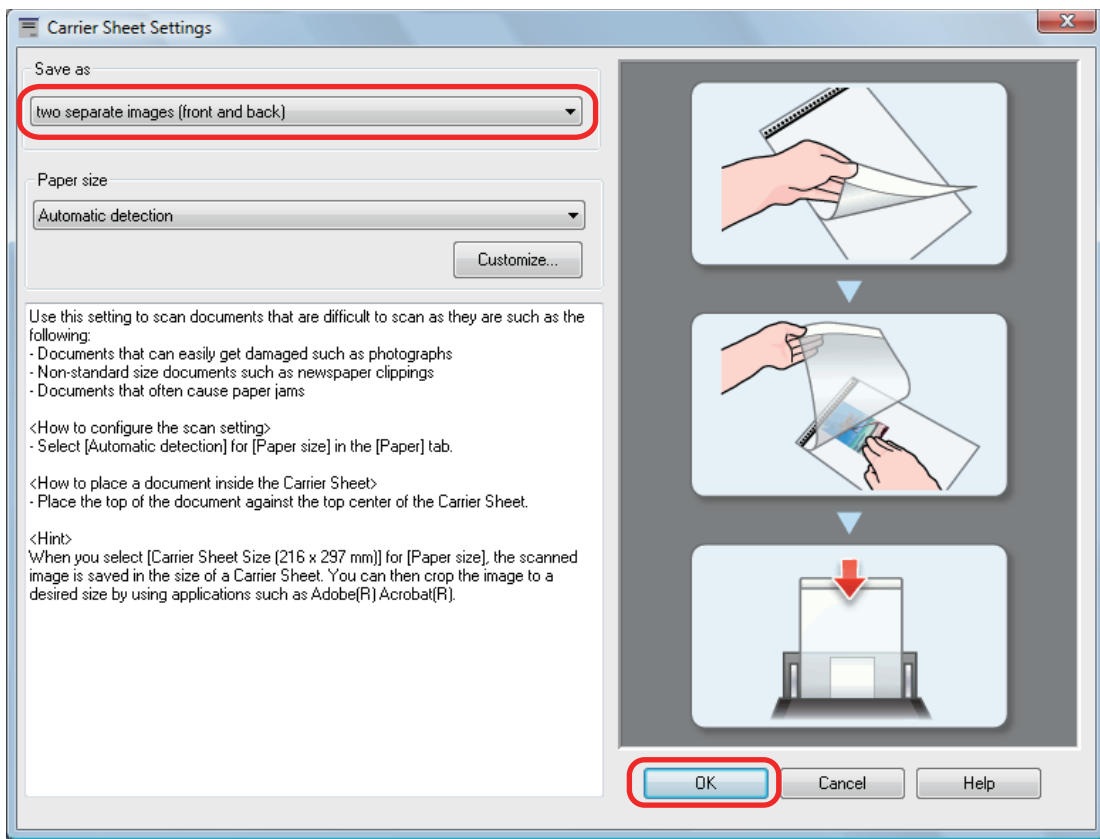

4. Click the [OK] button to close the ScanSnap setup window.

5. Place the document inside the Carrier Sheet.

Open the Carrier Sheet and place the top of the document against the top center of the Carrier Sheet.

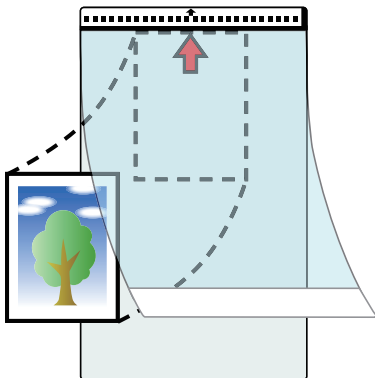

6. Place the end with the black and white pattern as the leading edge in the direction of the arrow.

Place the back side of the document towards you.

Secure the Carrier Sheet with the side guides to avoid skewing.

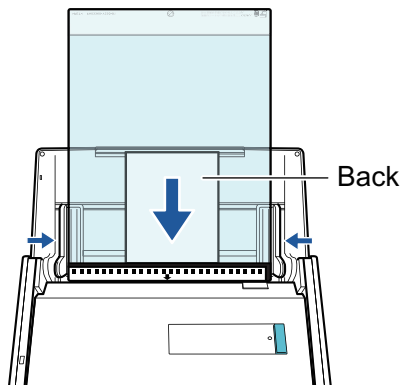

ATTENTION

When the [Place document face up] checkbox is selected in the [Scanning mode option] window, place the document in the Carrier Sheet face-up and bottom edge down.

To open the [Scanning mode option] window, click the [Option] button in the [Scanning] tab of the "ScanSnap Setup Window" (page 45).

7. Press the [Scan] button on the ScanSnap to start a scan.

⇒ When scanning is completed, the scanned image is saved.

ATTENTION

- The scanned image is output at the center of the page in the size specified for [Paper size] in the [Carrier Sheet Settings] window.
- If [Automatic detection] is specified for [Paper size] in the [Carrier Sheet Settings] window, an optimal size will be selected automatically from the available standard sizes (A3, B4, or 11 × 17 in.) in [Paper size]. Note that the size of the image may become smaller than the original document depending on the document scanned, or part of the image may appear missing.

Example: When the contents are printed to fit in A5 size in the center of an A4 size document, the scanned image is output in A5 size.

To output the scanned image in its original size, specify the document size in [Paper size].

HINT

- In the following cases, place a blank (white) sheet of paper underneath the document when scanning:
 - The scanned image is not saved in the correct size (when [Automatic detection] is selected for [Paper size] in the [Carrier Sheet Settings] window)
 - Shadows appear around the edges of the scanned image
 - Black lines appear around the edges of a uniquely shaped cutting

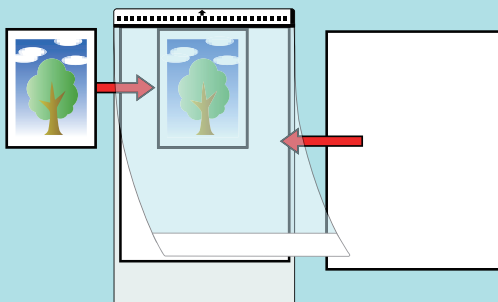

- Multiple Carrier Sheets can be loaded in the ADF paper chute (cover) and scanned.

Troubleshooting

This section explains how to solve troubles you may encounter upon installing or uninstalling the software related to the ScanSnap.

- "How to Find Your Solution" (page 96)
- "If Your First Attempt to Install Failed" (page 97)
- "If You Have Installed the Software Before" (page 98)
- "When the ScanSnap Manager Icon Does Not Appear" (page 106)
- "When ScanSnap Manager Does Not Operate Normally" (page 108)
- "When You Cannot Uninstall the Software" (page 116)

For details about the troubles you may encounter and the solutions while using the ScanSnap, refer to the following:

- "Troubleshooting" in the ScanSnap Manager Help

To display this section, right-click the ScanSnap Manager icon  in the notification area, and select [Help] → [Troubleshooting] from the "Right-Click Menu" (page 43).

- ScanSnap Support Site (<http://scansnap.fujitsu.com/g-support/en/>)

If you cannot solve the problem after referring to the above section, contact your FUJITSU scanner dealer or an authorized FUJITSU scanner service provider.

How to Find Your Solution

When software installation fails, or the ScanSnap does not operate normally after installation is complete, refer to the flow chart below for troubleshooting.

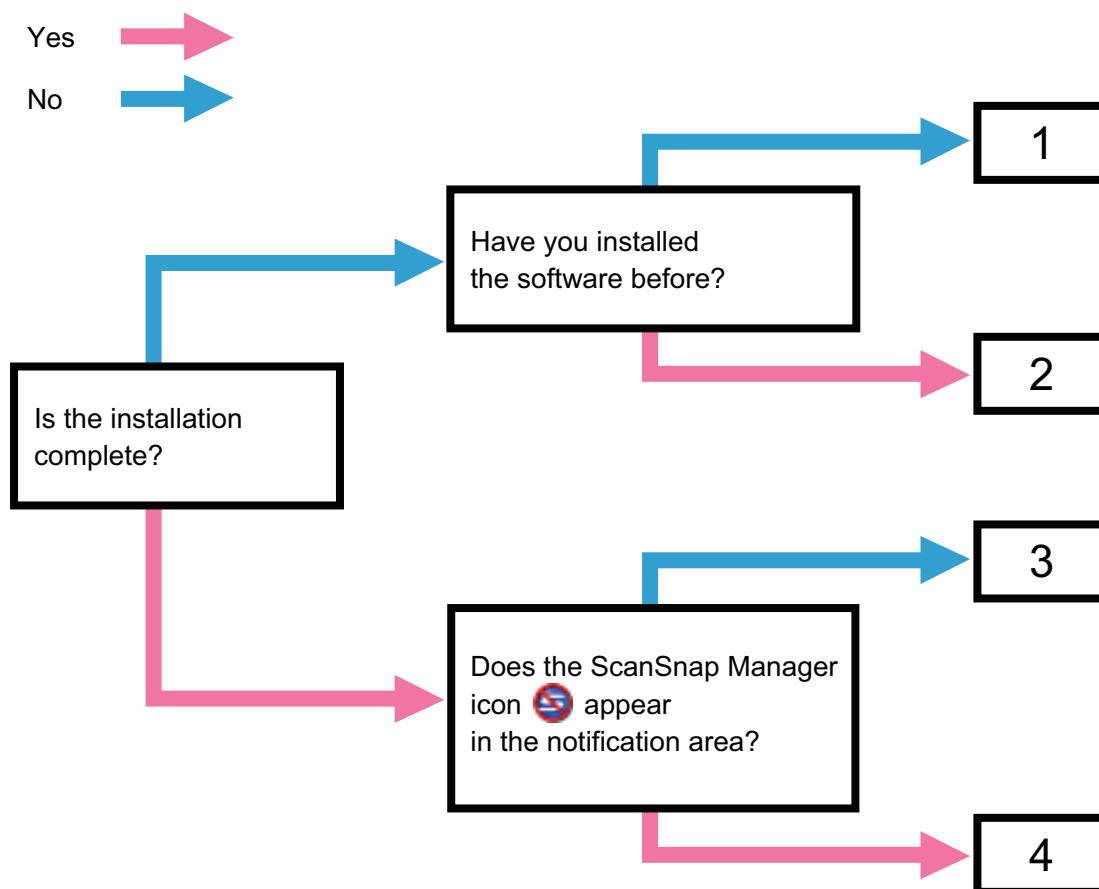

| No. | Topic to Be Referred to |
|-----|--|
| 1 | "If Your First Attempt to Install Failed" (page 97) |
| 2 | "If You Have Installed the Software Before" (page 98) |
| 3 | "When the ScanSnap Manager Icon Does Not Appear" (page 106) |
| 4 | "When ScanSnap Manager Does Not Operate Normally" (page 108) |

If Your First Attempt to Install Failed

This section explains how to troubleshoot when the first attempt to install the software related to the ScanSnap failed.

If any software related to the ScanSnap (including models other than iX500) has been installed before, refer to ["If You Have Installed the Software Before"](#) (page 98).

- 1. Restart the computer and log on as a user with Administrator privileges.**
- 2. Reinstall the software.**

For details, refer to ["How to Install the Software"](#) (page 41).

If You Have Installed the Software Before

This section explains how to troubleshoot if your attempt to reinstall the software related to the ScanSnap (including models other than iX500) failed.

- ["Uninstalling the Software" \(page 99\)](#)
- ["Removing the Installation Information" \(page 100\)](#)
- ["Installing the Software from the \[ScanSnap Setup\] Window" \(page 104\)](#)
- ["Installing One Software at a Time" \(page 105\)](#)

Uninstalling the Software

Uninstall the software that is already installed.

The uninstallation procedure is as follows.

- 1. If the ScanSnap is connected to the computer, unplug the USB cable from the computer.**
- 2. Log on as a user with Administrator privileges.**
- 3. If anti-virus software is running, disable the software temporarily.**

ATTENTION

If you cannot disable the anti-virus software, check if the software is set to lock the application.

- 4. Uninstall the software.**

The following software programs must be uninstalled:

- ScanSnap Manager
- ScanSnap Organizer
- CardMinder

For details, refer to "[Uninstalling the Software](#)" (page 136).

- If the software was successfully uninstalled, proceed to "[Installing the Software from the \[ScanSnap Setup\] Window](#)" (page 104).
- If the software still remains in the list, proceed to the next topic "[Removing the Installation Information](#)" (page 100).

Removing the Installation Information

If the name of the software that you tried to uninstall still remains in the list in [Programs and Features] of the Control Panel, or if the software cannot be uninstalled for some reason, the installation information needs to be removed.

Remove the installation information in the following procedure.

ATTENTION

If you cannot successfully remove the installation information, contact your FUJITSU scanner dealer or an authorized FUJITSU scanner service provider.

- 1. Log on as a user with Administrator privileges.**
- 2. Insert the Setup DVD-ROM into the DVD-ROM drive.**
 - ⇒ The [ScanSnap Setup] window appears.
- 3. Click the [Close] button to close the [ScanSnap Setup] window.**
- 4. Start up the tool for removing the installation information.**
 - Windows 10/Windows 8.1/Windows 8/Windows 7/Windows Vista
 1. From Windows Explorer, open the [Tool] folder in the Setup DVD-ROM.
 2. Right-click "SSClean.exe" and select [Run as administrator] from the displayed menu.
 - ⇒ The [User Account Control] window appears.
 3. Click the [Yes] button ([Continue] button in Windows Vista).
 - ⇒ The [Remove Installation Information] window appears.
 - Windows XP
 1. From Windows Explorer, open the [Tool] folder in the Setup DVD-ROM and double-click "SSClean.exe".
 - ⇒ The [Remove Installation Information] window appears.
- 5. Select the software from which you want to remove the installation information.**
 - ScanSnap Manager
 1. Select [ScanSnap Manager] and click the [Remove] button.

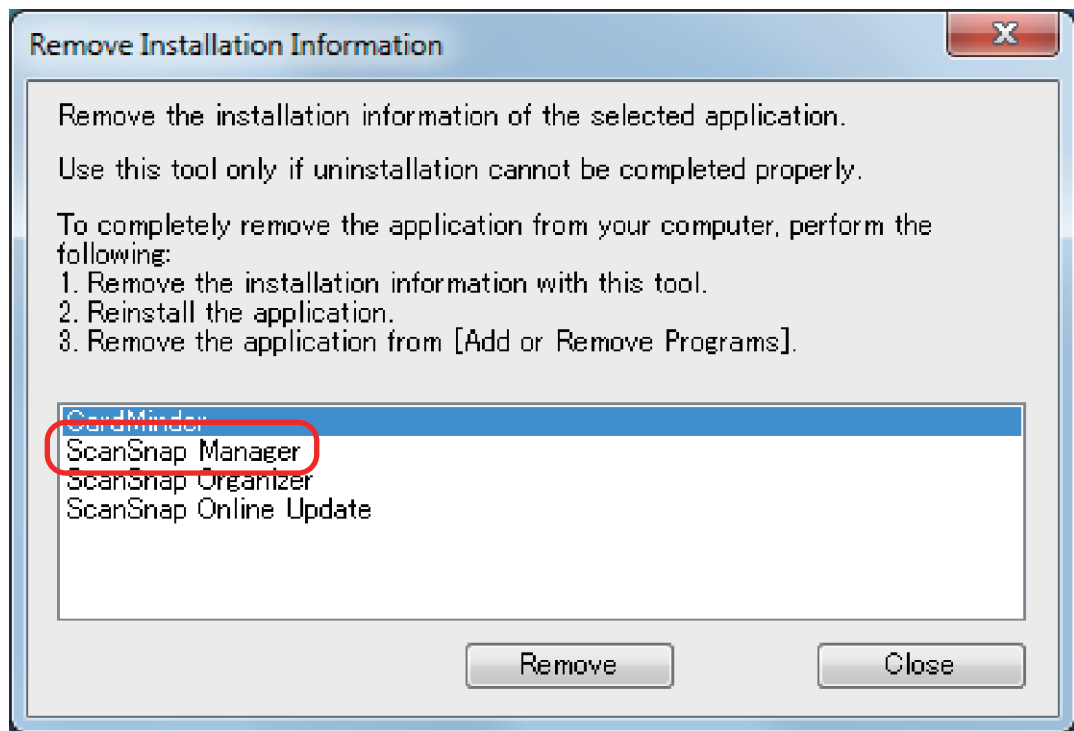

⇒ A confirmation message appears.

2. Click the [Yes] button.

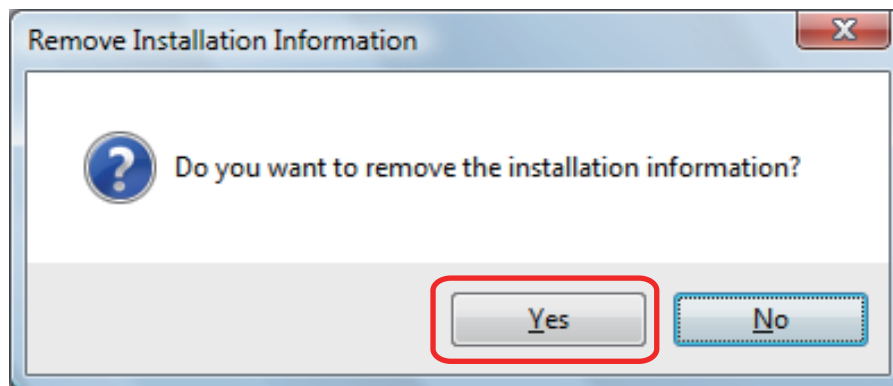

⇒ A message appears to check whether or not to remove the profile information.

3. Click the [Yes] button to remove and the [No] button to keep the profile information.

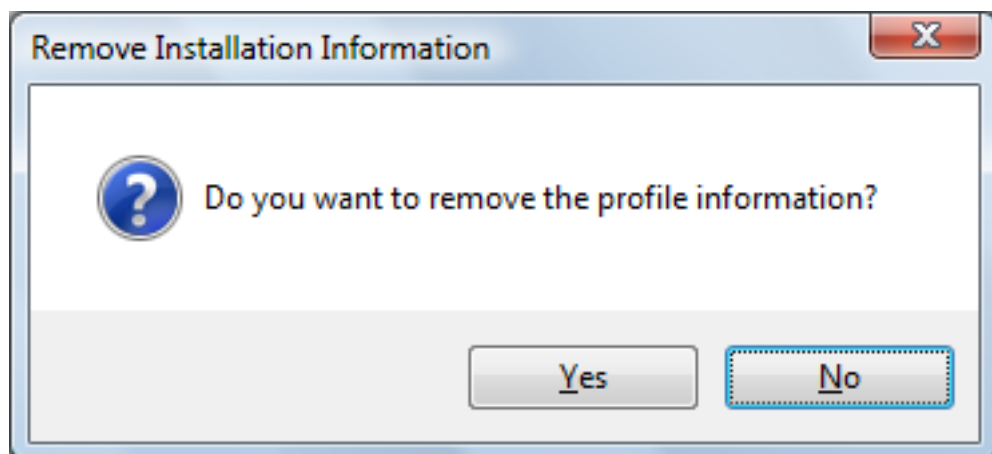

ATTENTION

If the problem persists when you kept the profile information then reinstalled the software, try again after removing the profile information.

⇒ The installation information is removed, and the following message appears.

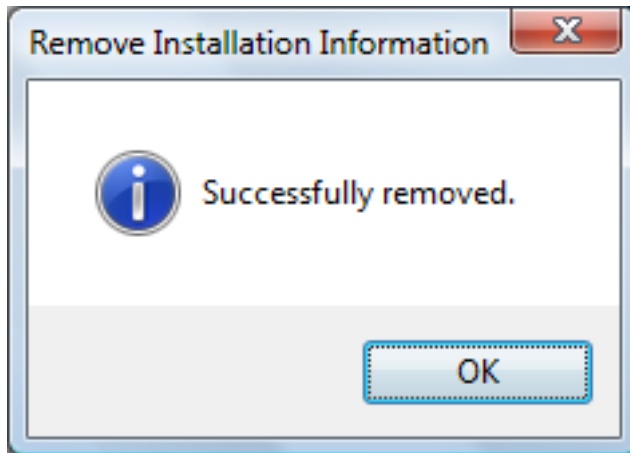

4. Click the [OK] button to close the [Remove Installation Information] window.
- ScanSnap Organizer/CardMinder/ScanSnap Online Update
 1. Select [ScanSnap Organizer], [CardMinder], or [ScanSnap Online Update], and click the [Remove] button.

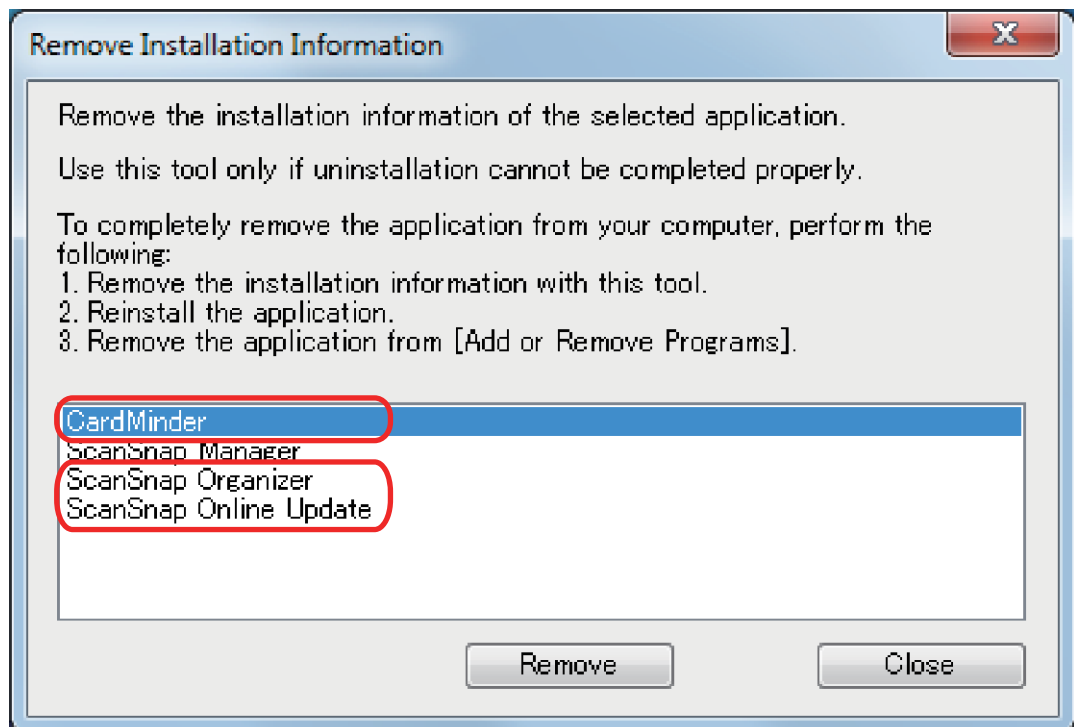

⇒ A confirmation message appears.

2. Click the [Yes] button.

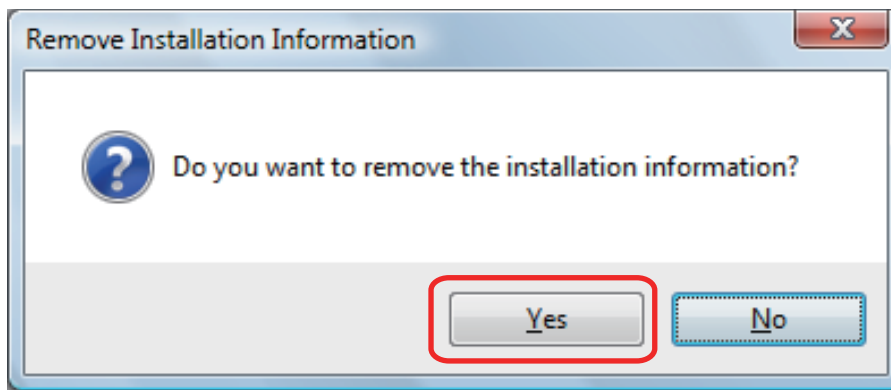

⇒ The installation information is removed, and the following message appears.

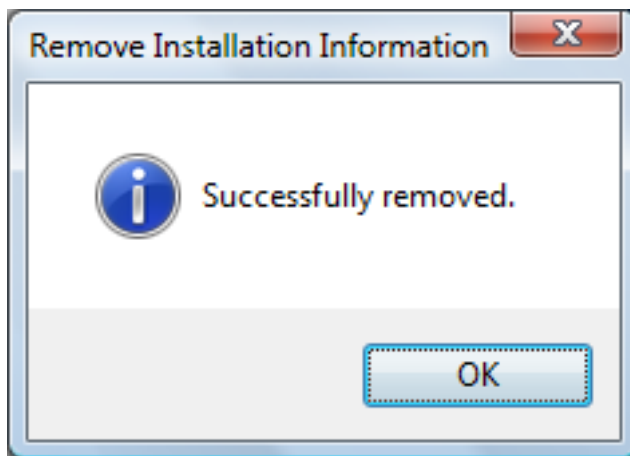

3. Click the [OK] button to close the [Remove Installation Information] window.
- 6. By repeating step 5, remove the installation information of all the software listed in the [Remove Installation Information] window.**
- 7. Click the [Close] button to close the [Remove Installation Information] window.**
- 8. Confirm that the installation folder no longer exists.**

If the [ScanSnap] folder remains in the following location, rename the folder (such as [-ScanSnap]). This folder can later be deleted once the installation is successfully completed.

Path: *DriveName (such as C):\Program Files\PFU*

After completing the procedure, proceed to "Installing the Software from the [ScanSnap Setup] Window" (page 104).

Installing the Software from the [ScanSnap Setup] Window

Once the software is uninstalled or the installation information is removed, install the software from the [ScanSnap Setup] window.

Install the software in the following procedure.

- 1. Restart the computer.**
- 2. Log on as a user with Administrator privileges.**
- 3. If anti-virus software is running, disable the software temporarily.**

ATTENTION

If you cannot disable the anti-virus software, check if the software is set to lock the application.

- 4. Install the software.**

For details, refer to "[How to Install the Software](#)" (page 41).

If you did not perform the procedure in "[Removing the Installation Information](#)" (page 100) and then failed to install the software, perform the following procedures again:

- "[Uninstalling the Software](#)" (page 99)
- "[Removing the Installation Information](#)" (page 100)
- "[Installing the Software from the \[ScanSnap Setup\] Window](#)" (page 104)

If you still could not reinstall the software after performing the above procedures, proceed to "[Installing One Software at a Time](#)" (page 105).

Installing One Software at a Time

Install the software one by one in the following procedure.

- 1. Restart the computer.**
- 2. Log on as a user with Administrator privileges.**
- 3. If anti-virus software is running, disable the software temporarily.**

ATTENTION

If you cannot disable the anti-virus software, check if the software is set to lock the application.

- 4. Insert the Setup DVD-ROM into the DVD-ROM drive.**
⇒ The [ScanSnap Setup] window appears.
- 5. Click the [Close] button to close the [ScanSnap Setup] window.**
- 6. Install the software.**

Open the Setup DVD-ROM from Windows Explorer, and run the "setup.exe" of each software.

- ScanSnap Manager
DVD-ROMDrive:\Software\ScanSnap\setup.exe
- ScanSnap Organizer
DVD-ROMDrive:\Software\Organizer\setup.exe
- CardMinder
DVD-ROMDrive:\Software\Card\setup.exe

Install one of the software above, and then install the following application.

- ScanSnap Online Update
DVD-ROMDrive:\Software\Online Update\setup.exe

⇒ The setup window appears.

Follow the instructions on the screen to continue with the installation.

If you cannot proceed further because a message appears to indicate that the software is already installed, start over again from the procedure in "[Uninstalling the Software](#)" (page 99).

ATTENTION

If the "setup.exe" for a software program is not included in the Setup DVD-ROM, download the installer for the software program from the following web page, then install it.

<http://scansnap.fujitsu.com/g-support/en/>

- 7. Restart the computer.**

When the ScanSnap Manager Icon Does Not Appear

This section explains how to troubleshoot when the ScanSnap Manager icon  does not appear in the notification area even though the software is installed and the ScanSnap is connected to the computer.

- ["Displaying the ScanSnap Manager Icon" \(page 107\)](#)

Displaying the ScanSnap Manager Icon

1. Start ScanSnap Manager.

- Windows 10
Select [Start] menu → [All apps] → [ScanSnap Manager] → [ScanSnap Manager].
- Windows 8.1
Click  on the lower left side of the Start screen, and select [ScanSnap Manager] under [ScanSnap Manager] on the All apps screen.
- Windows 8
Right-click the Start screen, and select [All apps] on the app bar → [ScanSnap Manager] under [ScanSnap Manager].
- Windows 7/Windows Vista/Windows XP
Select [Start] menu → [All Programs] → [ScanSnap Manager] → [ScanSnap Manager].

HINT

If the problem is solved, you can change the setting so that ScanSnap Manager will start up automatically from the next time you log on to the computer. The procedure is as follows.

1. Right-click the ScanSnap Manager icon  in the notification area located at the far right of the task bar and select [Help] → [Preferences] from the "Right-Click Menu" (page 43).
⇒ The [ScanSnap Manager - Preferences] window appears.
2. In the [Auto Startup] list, select the [Start up ScanSnap Manager when you log on] checkbox.

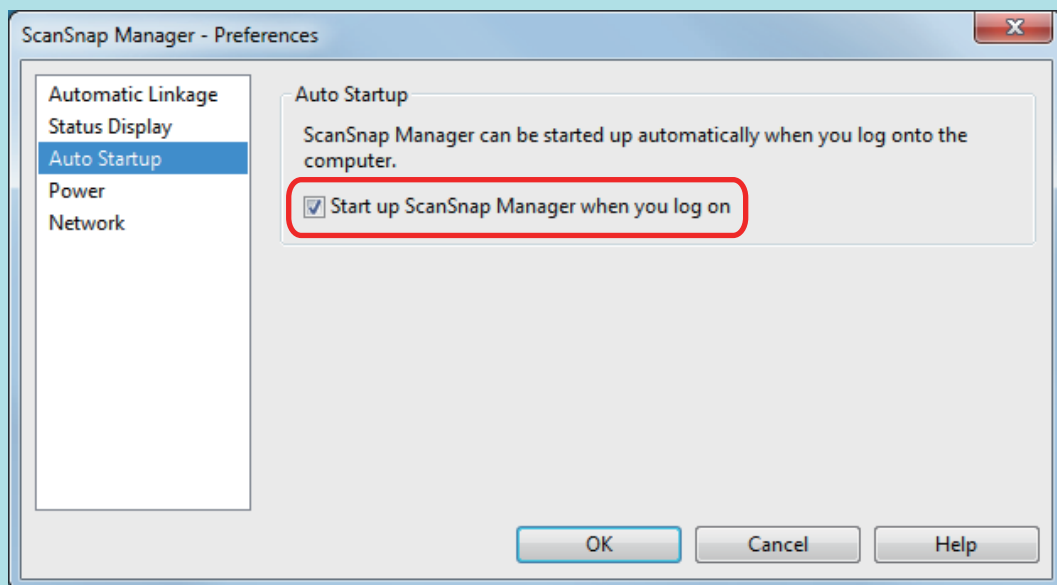

If the problem persists, refer to "When ScanSnap Manager Does Not Operate Normally" (page 108).

When ScanSnap Manager Does Not Operate Normally

If the ScanSnap Manager icon in the notification area located at the far right of the taskbar is displayed as  even though the software is installed and the ScanSnap is connected to the computer, perform the following procedures.

- ["Removing Unnecessary Icons from the Notification Area" \(page 109\)](#)
- ["Checking the Connection between the ScanSnap and the Computer" \(page 110\)](#)
- ["Checking If ScanSnap Manager Is Operating Normally" \(page 111\)](#)
- ["Removing the ScanSnap's Connection Information" \(page 114\)](#)

Removing Unnecessary Icons from the Notification Area

- 1. Check the software icons in the notification area, and exit the software that you are not using.**
 - ⇒ The icon is removed from the notification area.

- 2. Right-click the ScanSnap Manager icon  in the notification area and select [Exit] from the "Right-Click Menu" (page 43).**

- 3. Start ScanSnap Manager.**
 - Windows 10
Select [Start] menu → [All apps] → [ScanSnap Manager] → [ScanSnap Manager].
 - Windows 8.1
Click  on the lower left side of the Start screen, and select [ScanSnap Manager] under [ScanSnap Manager] on the All apps screen.
 - Windows 8
Right-click the Start screen, and select [All apps] on the app bar → [ScanSnap Manager] under [ScanSnap Manager].
 - Windows 7/Windows Vista/Windows XP
Select [Start] menu → [All Programs] → [ScanSnap Manager] → [ScanSnap Manager].

If the problem persists, refer to "[Checking the Connection between the ScanSnap and the Computer](#)" (page 110).

Checking the Connection between the ScanSnap and the Computer

- 1. Unplug the USB cable from the computer and the ScanSnap, then plug it back in.**

Make sure to leave at least 5 seconds between unplugging and plugging the cable.

If you are using a USB hub, connect the USB cable to the computer directly.

If the problem persists, refer to "[Checking If ScanSnap Manager Is Operating Normally](#)" (page 111).

Checking If ScanSnap Manager Is Operating Normally

1. Turn off the ScanSnap and then turn it on again.

Make sure to leave at least 5 seconds between turning off and on the ScanSnap.

If the problem persists, proceed to step 2.

2. If you are using a USB hub, connect the ScanSnap to the computer directly with a USB cable.

If the problem persists, proceed to step 3.

3. If there is more than one USB port on the computer, connect the USB cable to a different USB port.

If the problem persists, proceed to step 4.

4. If a USB device other than the ScanSnap is connected to the computer, disconnect it.

If the problem persists, proceed to step 5.

5. If anti-virus software is running, disable the software temporarily.

ATTENTION

If you cannot disable the anti-virus software, check if the software is set to lock the application.

If the problem persists, proceed to step 6.

6. Check the privileges to access the installation files.

1. Start the ScanSnap Support Tool.

- Windows 10

Select [Start] menu → [All apps] → [ScanSnap Manager] → [ScanSnap Support Tool].

- Windows 8.1

Click  on the lower left side of the Start screen, and select [ScanSnap Support Tool] under [ScanSnap Manager] on the All apps screen.

- Windows 8

Right-click the Start screen, and select [All apps] on the app bar → [ScanSnap Support Tool] under [ScanSnap Manager].

- Windows 7/Windows Vista/Windows XP

Select [Start] menu → [All Programs] → [ScanSnap Manager] → [ScanSnap Support Tool].

⇒ The [ScanSnap Support Tool] window appears.

- Click the [Check] button on the [Recover] tab, and proceed by following the instructions displayed on the screen.

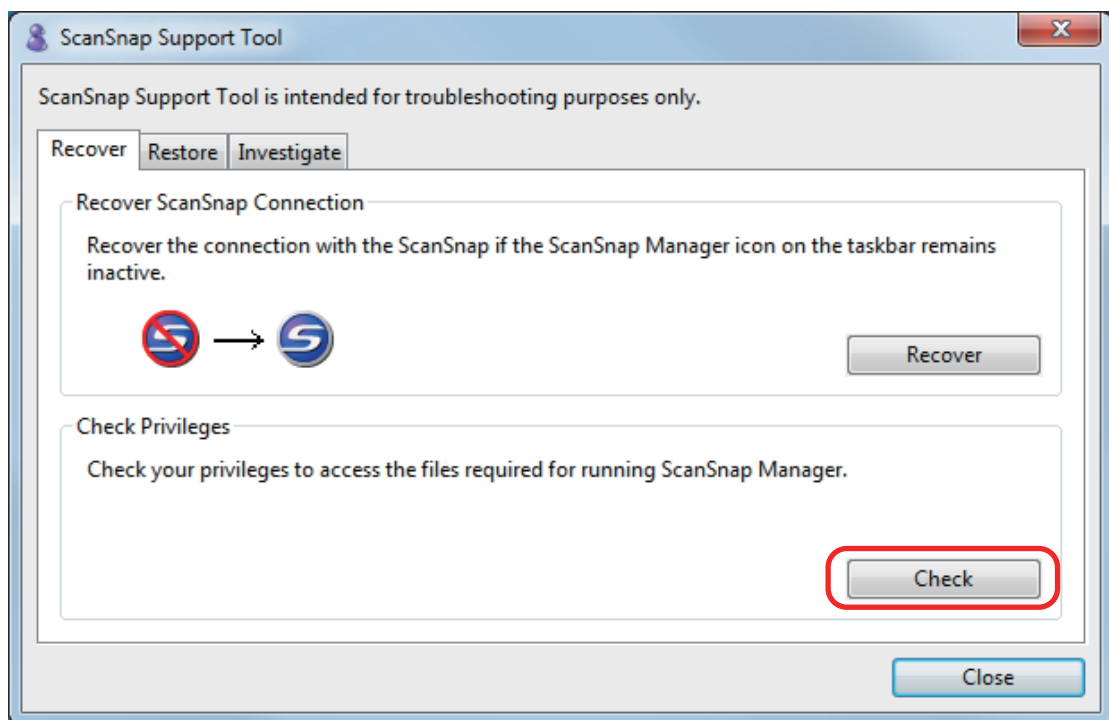

- ⇒ If the message "The recommended privileges have been applied." appears, turn off the ScanSnap and then turn it on again. Make sure to leave at least 5 seconds between turning off and on the ScanSnap.

If the message "Failed to change the privileges. Uninstall ScanSnap Manager then install it again." appears or the problem still persists, proceed to step 7.

7. Recover the connection with the ScanSnap.

- Start the ScanSnap Support Tool.
 - Windows 10
Select [Start] menu → [All apps] → [ScanSnap Manager] → [ScanSnap Support Tool].
 - Windows 8.1
Click  on the lower left side of the Start screen, and select [ScanSnap Support Tool] under [ScanSnap Manager] on the All apps screen.
 - Windows 8
Right-click the Start screen, and select [All apps] on the app bar → [ScanSnap Support Tool] under [ScanSnap Manager].
 - Windows 7/Windows Vista/Windows XP
Select [Start] menu → [All Programs] → [ScanSnap Manager] → [ScanSnap Support Tool].

⇒ The [ScanSnap Support Tool] window appears.
- Click the [Recover] button on the [Recover] tab, and proceed by following the instructions displayed on the screen.

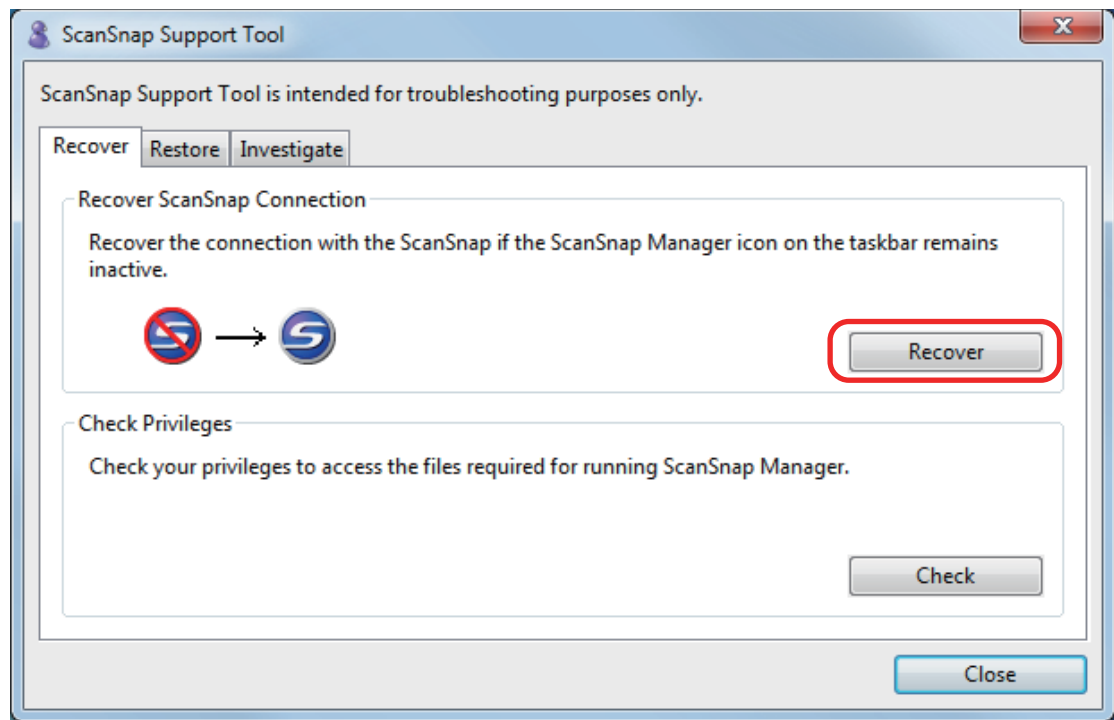



8. Turn off the ScanSnap and restart the computer.

If the problem persists, refer to ["Removing the ScanSnap's Connection Information"](#) (page 114).

Removing the ScanSnap's Connection Information

The ScanSnap might have been connected to the computer before the software was installed. In this case, the ScanSnap's connection information needs to be removed. Remove the ScanSnap's connection information in the following procedure.

- 1. Connect the ScanSnap to the computer, and turn on the ScanSnap.**
- 2. Open Device Manager.**
 - Windows 10
Right-click the [Start] menu and select [Device Manager].
 - Windows 8.1
Click  on the lower left side of the Start screen → [Control Panel] under [Windows System] → [Hardware and Sound] → [Device Manager].
 - Windows 8
Right-click the Start screen, and select [All apps] on the app bar → [Control Panel] under [Windows System] → [Hardware and Sound] → [Device Manager].
 - Windows 7
Select [Start] menu → [Control Panel] → [Hardware and Sound] → [Device Manager].
 - Windows Vista
Select [Start] menu → [Control Panel] → [System and Maintenance] → [Device Manager].
 - Windows XP
Select [start] menu → [Control Panel] → [Performance and Maintenance] → [System] → [Hardware] tab → [Device Manager] button.
- 3. Select [Imaging devices] and right-click on [ScanSnap iX500] (or [Other devices] → [ScanSnap iX500]), and then select [Uninstall] from the displayed menu.**
- 4. If other USB ports have been used to connect to the ScanSnap, perform steps 1 to 3 for each of the ports.**
- 5. Turn off the ScanSnap.**
- 6. Unplug the USB cable from the computer.**
- 7. Restart the computer.**
- 8. Connect the USB cable to the computer.**
- 9. Turn on the ScanSnap.**
 - ⇒ The ScanSnap Manager icon appears in the notification area. Make sure that the displayed icon is .

If the problem persists, refer to ["If You Have Installed the Software Before"](#) (page 98).

If the problem still persists, perform the procedures described in ["When ScanSnap Manager Does Not Operate Normally"](#) (page 108) once again.

If the above procedures do not solve the problem, please attach the data of your system information to an email and send it to your FUJITSU scanner dealer or an authorized FUJITSU scanner service provider. For details about how to collect system information, refer to "Troubleshooting" in the ScanSnap Manager Help.

When You Cannot Uninstall the Software

This section explains how to troubleshoot when you cannot uninstall the following software programs:

- ScanSnap Manager
- ScanSnap Organizer
- CardMinder
- ScanSnap Online Update

1. Restart the computer and log on as a user with Administrator privileges.

2. Remove the installation information.

⇒ For details, refer to ["Removing the Installation Information"](#) (page 100).

3. Install the software.

⇒ For details, refer to ["How to Install the Software"](#) (page 41).

4. Uninstall the software.

⇒ For details, refer to ["Uninstalling the Software"](#) (page 136).

Cleaning

This section explains about the cleaning materials and how to clean the ScanSnap.



ATTENTION

The bottom part of the ScanSnap may become hot when the ScanSnap is being used but this does not affect ScanSnap operation or cause any physical harm. Be careful not to drop the ScanSnap when carrying it.

- ["Cleaning Materials" \(page 118\)](#)
- ["Cleaning the Outside of the ScanSnap" \(page 119\)](#)
- ["Cleaning the Inside of the ScanSnap" \(page 120\)](#)
- ["Cleaning the Carrier Sheet" \(page 124\)](#)

Cleaning Materials

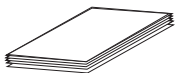
Cleaning materials and their part numbers are as below.

| Product Name | Part No. | Unit | Note |
|--|------------------------|----------|--------------|
| Cleaner F1  | PA03950-0352 | 1 bottle | Size: 100 ml |
| Cleaning Paper (*1)  | CA99501-0012 | 1 pack | 10 sheets |
| Cleaning Wipe (*2)  | PA03950-0419 | 1 pack | 24 packets |
| Lint-free dry cloth (*3) | Commercially available | - | - |

*1: Used with Cleaner F1.

*2: The cleaning wipes are wet tissues that have been soaked with Cleaner F1. In place of this product, you can use a cloth soaked with Cleaner F1.

*3: Any lint-free cloth can be used.

Contact your FUJITSU scanner dealer or an authorized FUJITSU scanner service provider for details about purchasing the cleaning materials.

For details, refer to the following web page:

<http://scansnap.fujitsu.com/>

Cleaning the Outside of the ScanSnap

Clean the outside of the ScanSnap, the ADF paper chute (cover), the ADF top section, and the stacker in the following procedure.

- 1. Unplug the cables from the ScanSnap.**
- 2. Clean the outside of the ScanSnap with a dry cloth, or a cloth moistened with Cleaner F1/mild detergent.**

ATTENTION

- Never use paint thinner or any other organic solvents. The shape or color may be changed.
- When cleaning the ScanSnap, prevent liquids from entering the ScanSnap.
- It may take a long time for Cleaner F1 to dry if an excessive amount is used. Moisten the cloth with moderate quantity. Wipe off the cleaner completely with a soft cloth to leave no residue on the cleaned parts.

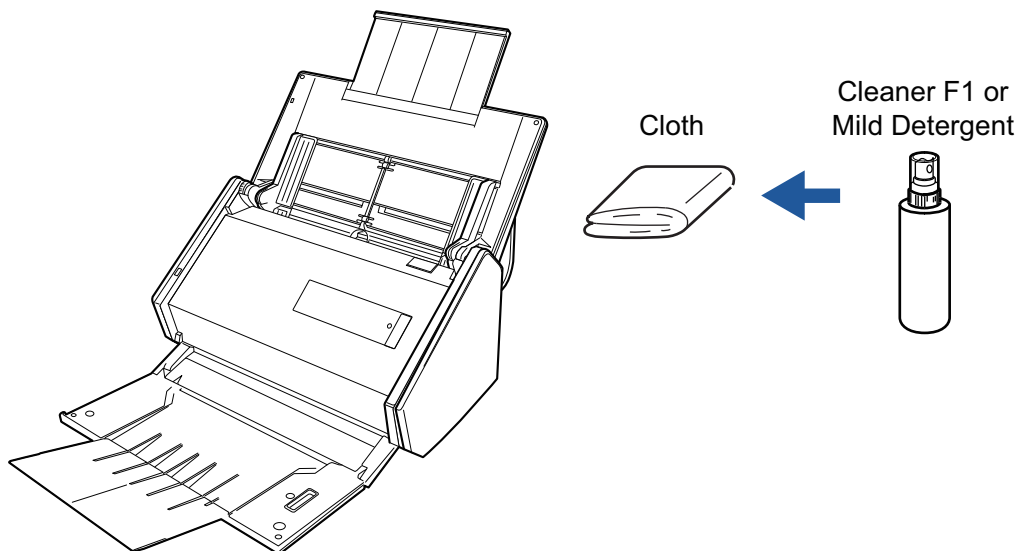

Cleaning the Inside of the ScanSnap

Scanning repeatedly may cause dust and paper dust to accumulate inside the ScanSnap resulting in a scanning error.

As a guideline, the inside of the ScanSnap should be cleaned every 1,000 sheets scanned. Note that this guideline varies depending on the types of documents you scan. For instance, it may be necessary to clean the scanner more frequently when you scan documents on which the toner is not sufficiently fused.



WARNING

- Before cleaning the ScanSnap, you must turn off the ScanSnap and unplug the power cable from the AC outlet. Not doing so may cause fire or electrical shock.
- Do not place internal parts such as the brake roller and the pick roller within reach of small children. Doing so may cause injury.
- When the ScanSnap is operating, the internal glass surface will be hot. Before you clean the inside of the ScanSnap, you must unplug the power cable from the AC outlet and leave the ScanSnap for 15 minutes or more.



CAUTION

Do not use aerosol spray or spray that contains alcohol to clean the scanner. Paper dust and other dust blown up by strong air from the spray may enter the inside of the scanner which may cause scanner failure or malfunction.

Also note that sparks generated by static electricity may cause a fire.

ATTENTION

- Do not use water or mild detergent to clean the inside of the ScanSnap.
- It may take a long time for Cleaner F1 to dry if an excessive amount is used. Moisten the cloth with moderate quantity.

Wipe off the cleaner completely to leave no residue on the cleaned parts.

HINT

To check the number of sheets scanned with the ScanSnap, see [Total Page Count] in the [ScanSnap Manager - Check consumable status] window.

To open the [ScanSnap Manager - Check consumable status] window, right-click the ScanSnap

Manager icon  in the notification area located at the far right of the taskbar, and select [Check consumable status] from the "Right-Click Menu" (page 43).

1. Clean the following items:

- Brake roller
 - Idler roller
 - Glass
 - Pick roller
 - Ultrasonic sensor
1. Unplug the power cable from the AC outlet.
 2. Pull the ADF release tab to open the ADF top section.

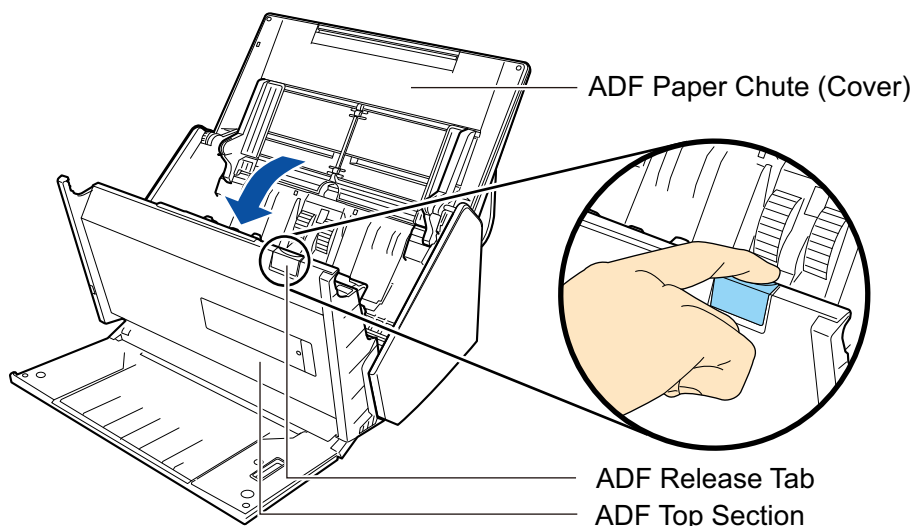

3. Clean the following locations with a cloth moistened with Cleaner F1.

ATTENTION

When cleaning, be careful not to damage the document sensor with a cloth.

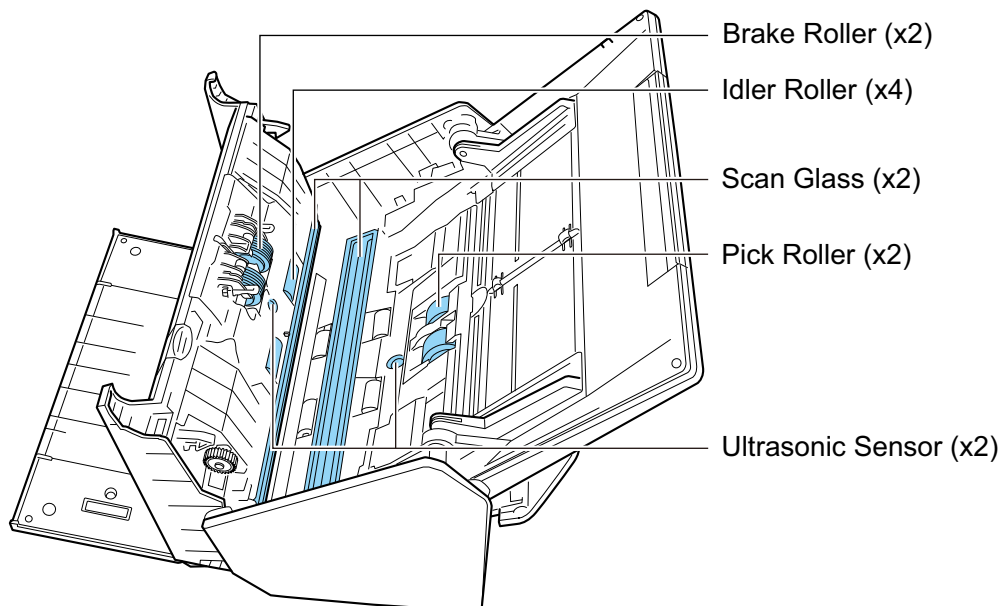
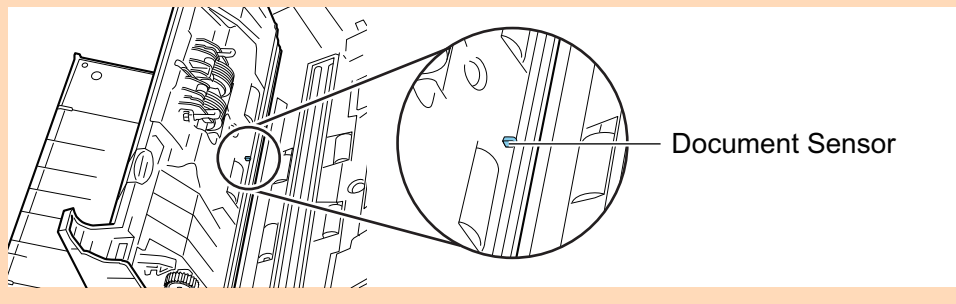

- Brake roller (× 2)

Remove the brake rollers from the ScanSnap to clean them.

For details about how to remove the brake rollers, refer to "[Replacing Consumables](#)" (page 128).

Gently wipe off the dirt and dust along the grooves on the roller surface. Be careful not to damage the surface of the rollers.

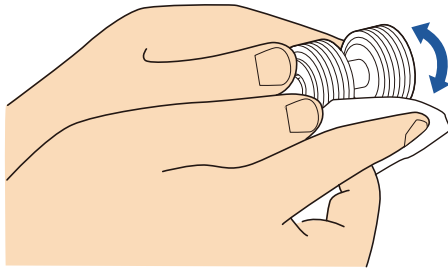

- Idler roller (× 4)

Gently wipe the dirt and dust off the rollers as you rotate them manually. Be careful not to damage the surface of the rollers. Make sure that they are cleaned properly because residue on the rollers will affect the feeding performance.

- Glass (× 2)

Gently wipe the dirt and dust off the surface of the glass sections. Make sure that they are cleaned properly because dirty glass sections may cause vertical lines on scanned images.

- Pick roller (× 2)

Gently wipe off the dirt and dust along the grooves on the surface of rollers as you manually rotate them downward. Be careful not to damage the surface of the rollers. Make sure that they are cleaned properly because residue on the rollers will affect the feeding performance.

- Ultrasonic sensor (× 2)

Gently wipe the dirt and dust off the surface of the ultrasonic sensor. If it is difficult to clean the ultrasonic sensor, use cotton swabs.

2. Clean the feed rollers and eject rollers.

1. Connect the power cable to the AC outlet and press the [Scan] button for three seconds with the ADF top section open.

ATTENTION

Connect the power cable to the AC outlet only when cleaning the feed rollers and eject rollers.

2. Clean the following locations with a cloth moistened with Cleaner F1.

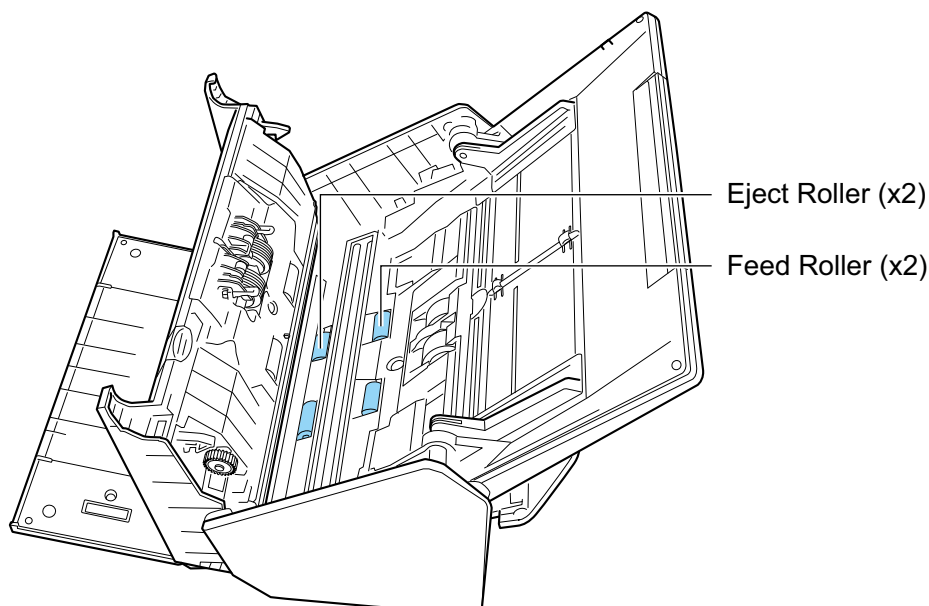

- Feed roller (× 2)/eject roller (× 2)

Press the [Scan] button to rotate the rollers. Gently wipe the dirt and dust off while taking care not to damage the surface of each roller. Make sure that they are cleaned properly because residue on the rollers will affect the feeding performance.

HINT

Pressing the [Scan] button seven times will rotate the feed rollers and the eject rollers one revolution.

3. Close the ADF top section.

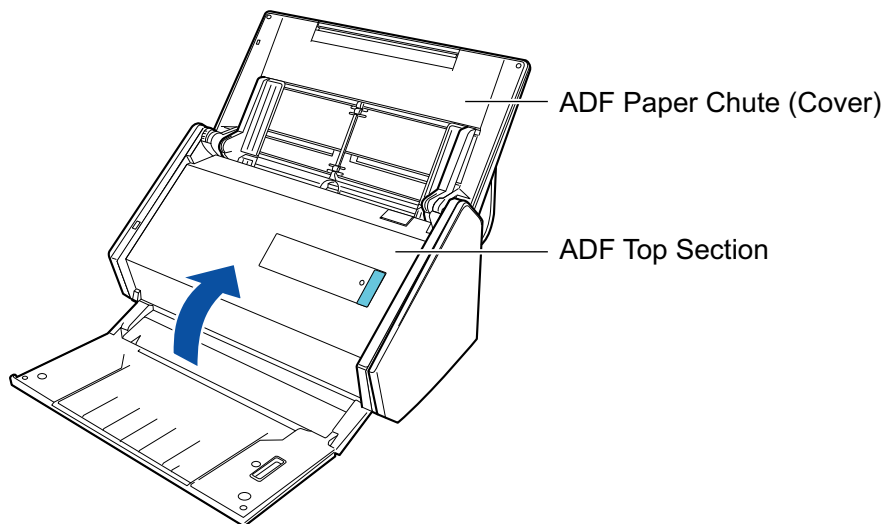

⇒ It clicks when it returns to its original position.

ATTENTION

Make sure that the ADF top section is completely closed.
Otherwise, paper jams or other feeding errors, or image faults may occur.

Cleaning the Carrier Sheet

As you keep using the Carrier Sheet, dirt and dust will accumulate on the surface and the inside.

Clean the Carrier Sheet regularly because it may result in scanning errors.

The procedure for cleaning the Carrier Sheet is as follows.

Cleaning

Gently wipe the dirt and dust off the surface and the inside of the Carrier Sheet with a dry cloth, or a cloth moistened with Cleaner F1/mild detergent.

ATTENTION

- Do not use paint thinner or any other organic solvents.
- Do not use force to rub. The Carrier Sheet may be damaged or deformed.
- Be careful not to leave any crease on the Carrier Sheet.
- After cleaning the inside of the Carrier Sheet with a cloth moistened with Cleaner F1/mild detergent, make sure that it is completely dry before closing the Carrier Sheet.
- The Carrier Sheet should be replaced approximately every 500 scans.

Consumables

This section explains about the consumable part numbers, replacement cycles and how to replace the consumables.



- Before replacing consumables, you must turn off the ScanSnap and unplug the power cable from the AC outlet. Not doing so may cause fire or electrical shock.
- Do not place internal parts such as the brake roller and the pick roller within reach of small children. Doing so may cause injury.

ATTENTION

The bottom part of the ScanSnap may become hot when the ScanSnap is being used but this does not affect ScanSnap operation or cause any physical harm. Be careful not to drop the ScanSnap when carrying it.

- ["Part Numbers and Replacement Cycle of Consumables" \(page 126\)](#)
- ["Checking the Status of Consumables" \(page 127\)](#)
- ["Replacing Consumables" \(page 128\)](#)

Part Numbers and Replacement Cycle of Consumables

The following table shows the part number of the consumables and the suggested replacement cycles.

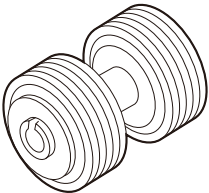
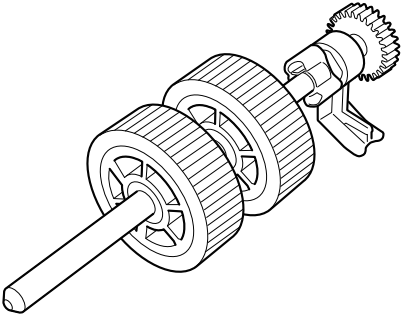
| Product Name | Part No. | Suggested replacement cycle |
|--|--------------|-----------------------------|
| Roller Set ● Brake roller  ● Pick roller  | PA03656-0001 | 200,000 sheets or one year |

Note that the suggested replacement cycles are guidelines for using A4 (80 g/m² [20 lb]) wood-free paper, as these cycles vary depending on the type of documents scanned.

Only use the specified consumables.

Contact your FUJITSU scanner dealer or an authorized FUJITSU scanner service provider for details about purchasing the consumables.

For details, refer to the following portal site:

<http://scansnap.fujitsu.com/>

Checking the Status of Consumables

You can check the status of each consumable in the following procedure.

1. **Right-click the ScanSnap Manager icon  in the notification area located at the far right of the task bar and select [Check consumable status] from the "Right-Click Menu" (page 43).**

⇒ The [ScanSnap Manager - Check consumable status] window appears.

2. **Check the status of each consumable.**

Refer to [Suggested replacement cycle] as a guideline and replace the consumables.

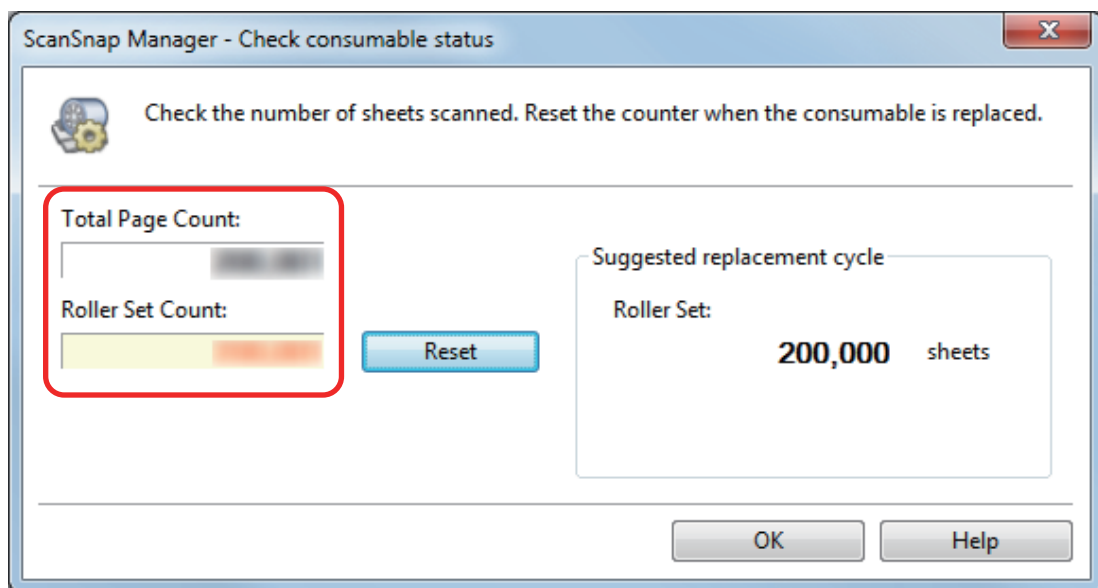

Replacing Consumables

The Roller Set consists of the brake roller and pick roller.

Replace each roller in the following procedure:

- 1. Unplug the power cable from the AC outlet.**
- 2. Remove any documents from the ADF paper chute (cover).**
- 3. Pull the ADF release tab to open the ADF top section.**

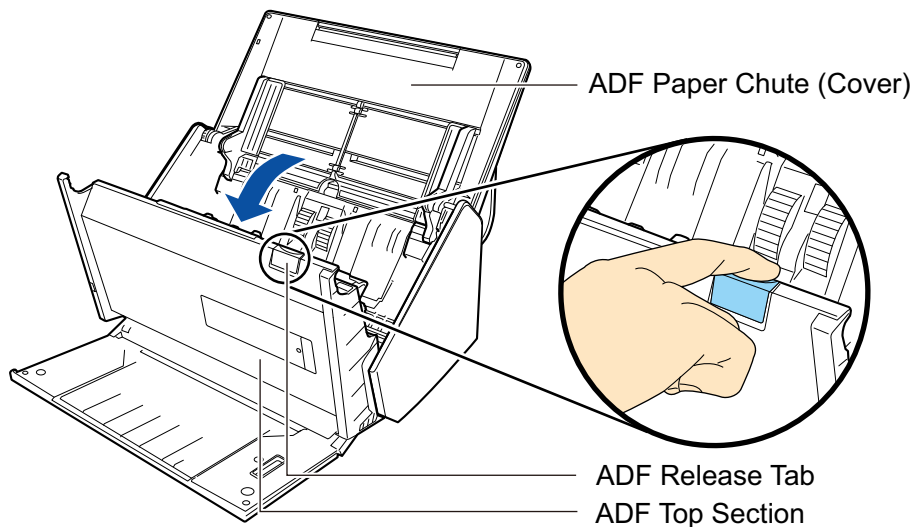

4. Replace the brake roller.

1. Open the brake roller cover.

By holding the both ends of the brake roller cover, open it in the direction of the arrow.

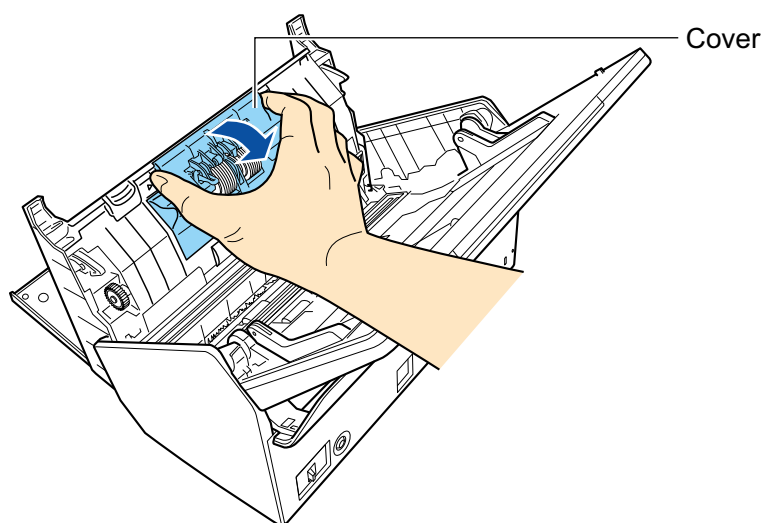

2. Remove the shaft of the brake roller from the ScanSnap.

Lift the brake roller to remove the right side of the shaft, and then pull out the shaft from the hole on the left.

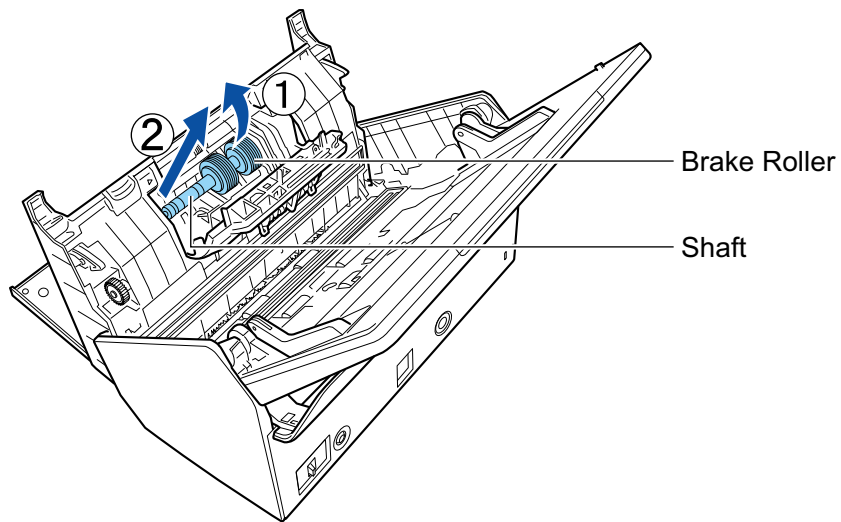

3. Remove the brake roller from the shaft.

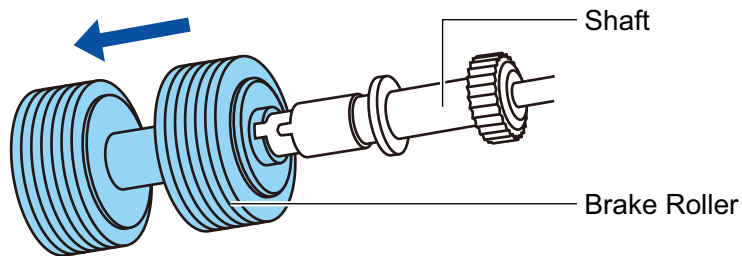

4. Attach the new brake roller to the shaft.

Insert the shaft to the brake roller by aligning the protrusion on the shaft with the slot on the brake roller.

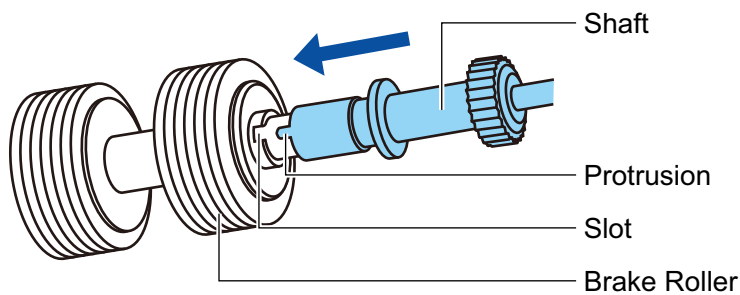

5. Attach the shaft to the ScanSnap.

Insert the left end of the shaft in the hole properly, and then attach the right side of the shaft into place.

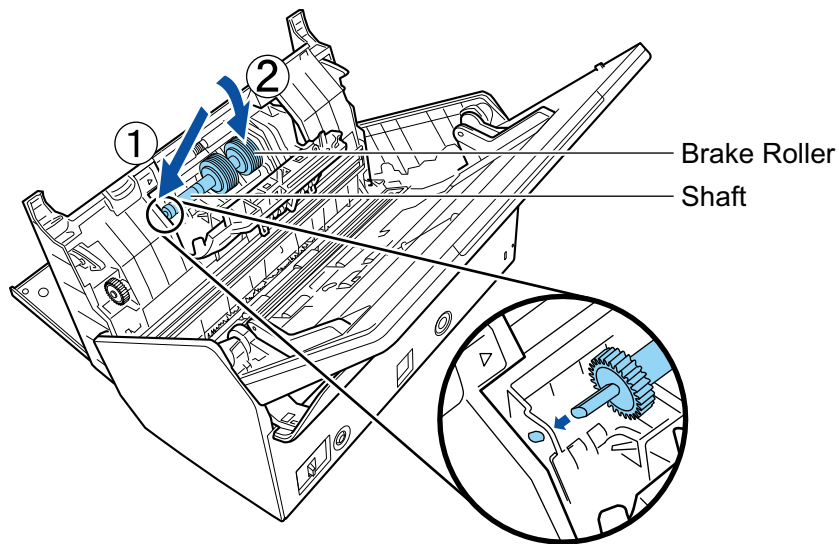

6. Close the brake roller cover.

ATTENTION

Make sure that the shaft is attached firmly. Otherwise, paper jams or other feeding errors may occur.

5. Replace the pick roller.

1. Open the sheet guide.

Slide the side guides all the way. Open the sheet guide by hooking your finger in the dip of the sheet guide.

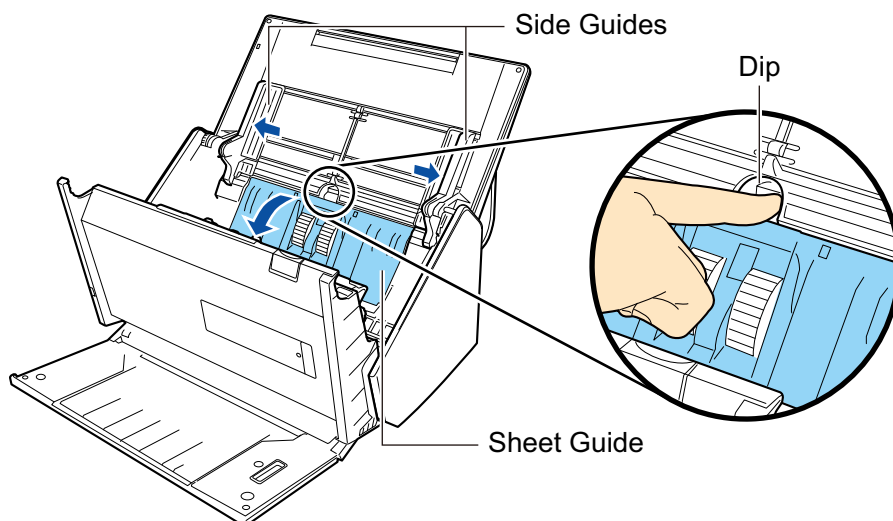

2. Turn the bushing in the direction of the arrow.

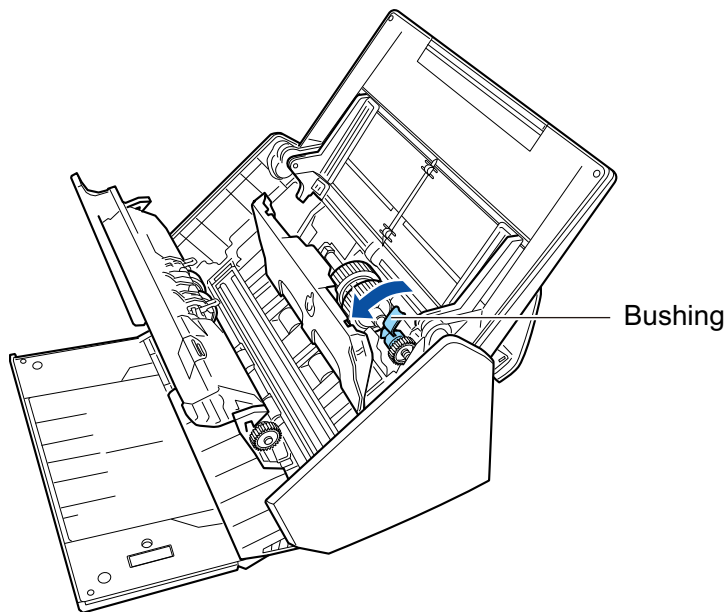

3. Remove the pick roller.

Lift the right side of the bushing slightly (about 5 mm), move it toward the right, and then lift it upward to pull out the pick roller.

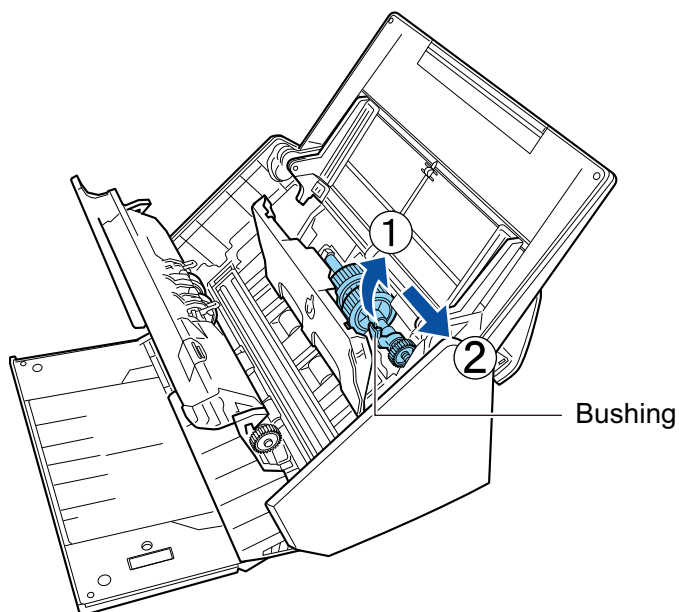

ATTENTION

Be careful not to touch the grease on the gear near the bushing.

4. Attach the new pick roller to the ScanSnap.

Insert the left end of the shaft into the left-side hole, and then slowly attach the right end of the shaft into place.

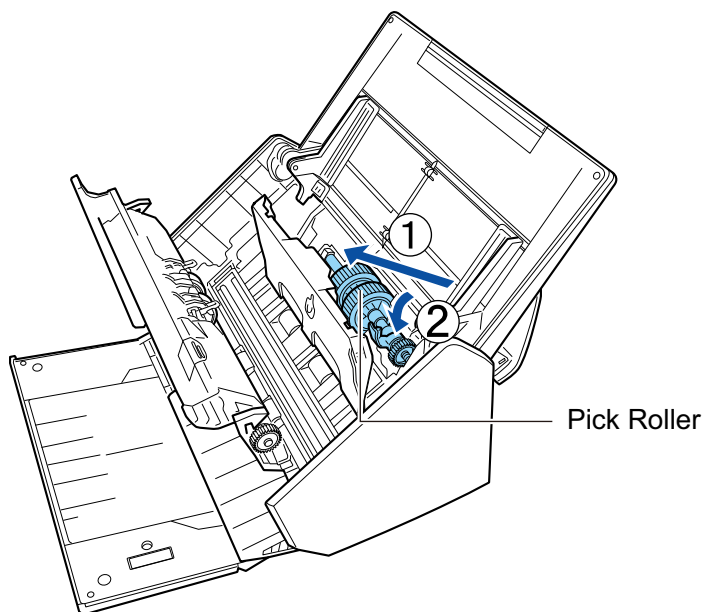

5. Turn the bushing in the direction of the arrow.

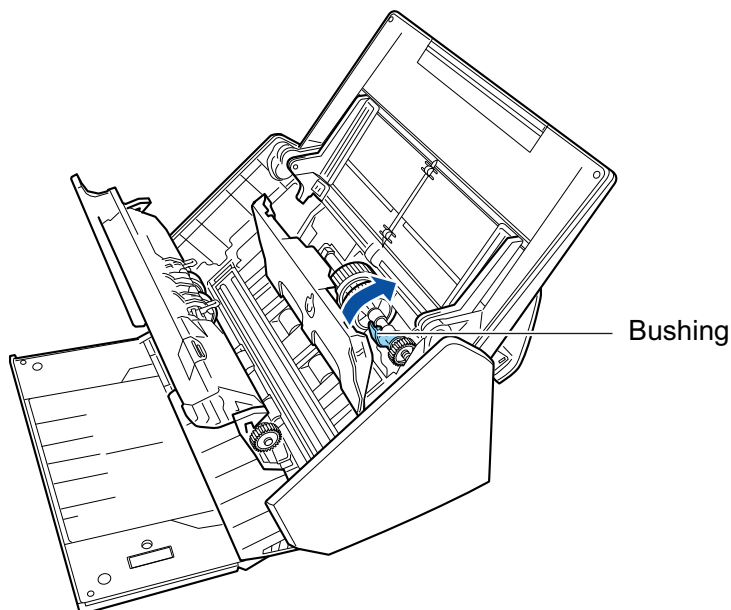

ATTENTION

Make sure that the pick roller is attached firmly. Otherwise, paper jams or other feeding errors may occur.

6. Close the sheet guide.
Make sure that both sides of the sheet guide are locked firmly.

6. Close the ADF top section.

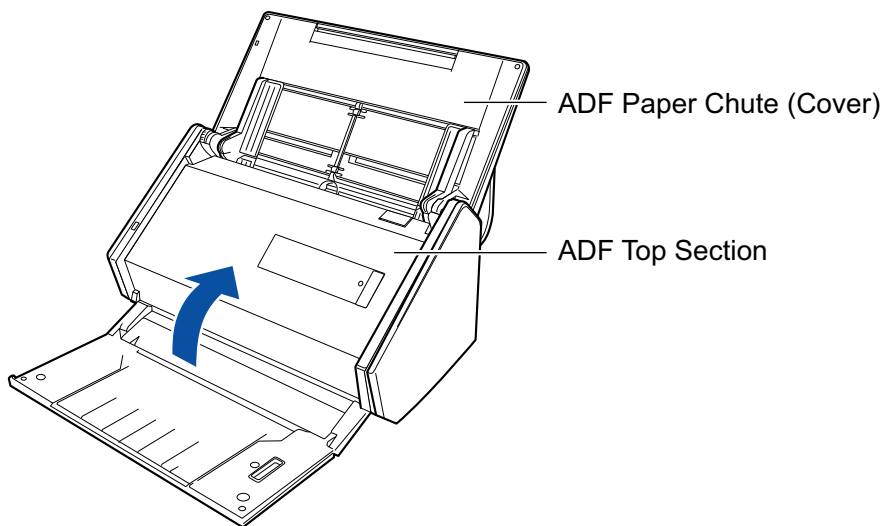

⇒ It clicks when it returns to its original position.

7. Connect the power cable to the AC outlet, and turn on the ScanSnap.

8. Reset the roller set count.

1. Right-click the ScanSnap Manager icon  in the notification area located at the far right of the task bar and select [Check consumable status] from the "Right-Click Menu" (page 43).

⇒ The [ScanSnap Manager - Check consumable status] window appears.
2. Click the [Reset] button for [Roller Set Count].

⇒ A confirmation window appears.
3. Click the [Yes] button.

⇒ [Roller Set Count] is reset to 0.

Appendix

- ["Updating the Software" \(page 135\)](#)
- ["Uninstalling the Software" \(page 136\)](#)
- ["Specifications of the Carrier Sheet" \(page 138\)](#)
- ["Specifications of Wireless LAN" \(page 139\)](#)
- ["Specifications of the ScanSnap" \(page 140\)](#)

Updating the Software

Latest updates for ScanSnap related software are available for free from our download server. This is called ScanSnap Online Update.

It is recommended that you apply latest updates to enhance security, operability and functions.

For the software programs that can be updated, refer to the following:

<http://www.fujitsu.com/global/support/computing/peripheral/scanners/software/online-setup-help.html>

ScanSnap Online Update checks the download server periodically.

When the latest version of ScanSnap is available, a notification appears.

To install the update, click on the notification and follow the instructions on the window that appears.

For details, refer to the ScanSnap Online Update Help.

You can also manually check from ScanSnap Manager whether a newer version of the program is available and run the update.

- 1. Right-click the ScanSnap Manager icon  in the notification area located at the far right of the task bar and click [Help] → [Online Update] from the "Right-Click Menu" (page 43).**

⇒ ScanSnap Online Update checks whether a newer version of ScanSnap Manager is available. Proceed with the update as you follow the instructions.

For details, refer to the ScanSnap Online Update Help.

ATTENTION

- To run the online update for ScanSnap Manager, you need to have access to the Internet.
- Log on as a user with Administrator privileges.

HINT

For details about updates of ScanSnap Manager, visit the following web pages:

<http://scansnap.fujitsu.com/g-support/en/>

Uninstalling the Software

This section explains how to uninstall the following software programs:

- ScanSnap Manager
- ScanSnap Organizer
- CardMinder
- ABBYY FineReader for ScanSnap
- Scan to Microsoft SharePoint

HINT

If all of the following software programs are uninstalled, ScanSnap Online Update is also uninstalled at the same time:

- ScanSnap Manager
- ScanSnap Organizer
- CardMinder

The procedure is as follows.

- 1. Turn on the computer and log on as a user with Administrator privileges.**
- 2. Exit all running software programs.**
- 3. Show the [Programs and Features] window.**

- Windows 10

Right-click the [Start] menu and select [Programs and Features].

- Windows 8.1

Click  on the lower left side of the Start screen → [Control Panel] under [Windows System] → [Uninstall a program] under [Programs].

- Windows 8

Right-click the Start screen, and select [All apps] on the app bar → [Control Panel] under [Windows System] → [Uninstall a program] under [Programs].

- Windows 7/Windows Vista/Windows XP

Select [Start] menu → [Control Panel] → [Uninstall a program] under [Programs].

⇒ The [Uninstall or change a program] window appears with a list of currently installed software programs.

- 4. Select a software program to uninstall.**

HINT

To uninstall more than one software program, repeat steps 4 to 6 for each software program.

- 5. Click the [Uninstall] button.**

⇒ A confirmation message appears.

6. Click the [Yes] button.

⇒ The software program is uninstalled.

ATTENTION

- Screen displays may vary slightly depending on the operating system that you are using. In that case, follow the instructions by the operating system.

Example:

- [Programs and Features]
In Windows XP: [Add or Remove Programs]
- [Uninstall] button
In Windows XP: [Remove] button
- If you cannot successfully uninstall the following software programs, refer to "[When You Cannot Uninstall the Software](#)" (page 116):
 - ScanSnap Manager
 - ScanSnap Organizer
 - CardMinder
 - ScanSnap Online Update

Specifications of the Carrier Sheet

The product name and part number of the Carrier Sheet are as follows.

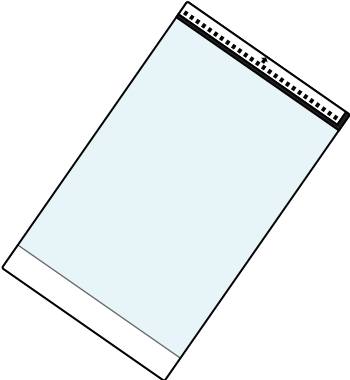
| Product Name | Qty. | Part No. |
|--|----------|--------------|
| ScanSnap Carrier Sheets  | 5 sheets | PA03360-0013 |

The Carrier Sheet should be replaced approximately every 500 scans.

However, replace it if damage or dirt is noticeable.

Contact your FUJITSU scanner dealer or an authorized FUJITSU scanner service provider for details about purchasing the Carrier Sheet.

For details, refer to the following portal site:

<http://scansnap.fujitsu.com/>

Specifications of Wireless LAN

The following table summarizes the wireless LAN specifications of the ScanSnap.

| Item | Specification |
|---|---|
| Model name | iX500 |
| Observed standards | IEEE802.11b/IEEE802.11g/IEEE802.11n |
| Frequency range | 2.412 GHz to 2.472 GHz |
| Channels | 1 to 13 ch |
| Transfer speed (standard) | IEEE802.11b Max.: 11 Mbps IEEE802.11g Max.: 54 Mbps IEEE802.11n Max.: 72.2 Mbps (Only supports 20 MHz bandwidth) (*1) |
| Communication mode | Infrastructure mode (*2) |
| Communication distance (line of sight) | Indoors, 50 m (Recommended: indoors, within 25 m) (*3) |
| Security | WPA-PSK (TKIP/AES), WPA2-PSK (TKIP/AES), WPA (TKIP/AES), WPA2 (TKIP/AES), WEP (64-bit/128-bit) |
| Easy installation | WPS 2.0 supported (button/PIN code) (*4) |

*1: The values indicated on these standards are the maximum value, and do not indicate actual communication speed.

*2: To use the wireless function, you need a wireless access point that supports the same standards.

*3: The specifications may vary based on the connected wireless access point and the surrounding environment.

*4: You need a wireless access point that supports the WPS function.

Specifications of the ScanSnap

The following table summarizes the specifications of the ScanSnap.

| Item | | Specification |
|---|-------------------------|--|
| Product Name | | ScanSnap iX500 |
| Scanning method | | Automatic Document Feeder (ADF), simultaneous duplex scanning |
| Scanning color mode | | Simplex/duplex, color/gray/black and white/auto (automatic color, gray, and B&W detection) |
| Optical system/image sensor | | Selfoc lens equal-magnification optics/color CIS × 2 (front × 1, back × 1) |
| Light source | | 3 color LED (Red/Green/Blue) |
| Scanning speed (A4 portrait) | | Automatic resolution/normal/better/best 25 sheets/minute Excellent 7 sheets/minute |
| Scan area | | Refer to "Documents to Scan" (page 60) |
| Document thickness | | |
| Number of sheets allowed to be loaded | | Up to 50 sheets A4: 80 g/m ² (20 lb) |
| Interface | USB | USB 3.0 (*1)/USB 2.0/USB 1.1 (connector: B type) |
| | Wireless LAN (*2) | Refer to "Specifications of Wireless LAN" (page 139) |
| Input power | Voltage | 100 to 240 V ±10% |
| | Phase | Single phase |
| | Frequency range | 50/60 Hz |
| Power consumption | USB connection | During operation: 20 W or less During sleep mode: 1.6 W or less |
| | Wireless LAN connection | During operation: 20 W or less During sleep mode: 2.5 W or less |
| Temperature/humidity allowable ranges | Temperature | During operation: 5 to 35 degrees C/41 to 95 degrees F During standby: -20 to 60 degrees C/-4 to 140 degrees F During storage/transportation: -20 to 60 degrees C/-4 to 140 degrees F |
| | Humidity | During operation: 20 to 80% During standby: 8 to 95% During storage/transportation: 8 to 95% |
| Outer dimensions (Width × Depth × Height) | | Min.: 292 × 159 × 168 mm/11.50 × 6.26 × 6.61 in. (when the ADF paper chute (cover) is closed) Max.: 292 × 484 × 293 mm/11.50 × 19.06 × 11.54 in. (when the ADF paper chute (cover) is open and the extension is extended) |
| Weight | | 3.0 kg (approx. 6.62 lb) |
| Environmental specification | | Compliant with the International Energy Star Program, and RoHS Directive |

| Item | | Specification |
|------------------|-----------------------------------|-------------------------------|
| Related Software | Scanner driver | ScanSnap Manager |
| | File management | ScanSnap Organizer |
| | Business card management | CardMinder |
| | Text recognition | ABBYY FineReader for ScanSnap |
| | Update management and application | ScanSnap Online Update |
| | ECM linkage | Scan to Microsoft SharePoint |
| | PDF editing | Adobe Acrobat Standard DC |

*1: When the ScanSnap is connected to a USB 3.0 port, the ScanSnap may not be recognized by some computers.

For the latest USB 3.0 information, refer to the ScanSnap Support Site (<http://scansnap.fujitsu.com/g-support/en/>).

*2: IPv6 is not supported.

About Customer Support and Maintenance

Customer Support

- Adobe Acrobat

Refer to the following web page:

<http://www.adobe.com/support/>

- ABBYY FineReader for ScanSnap

- Windows 10

From the [Start] menu, select [All apps] → [ABBYY FineReader for ScanSnap(TM) 5.0] → [User's Guide] → [Technical Support].

- Windows 8.1

Click  on the lower left side of the Start screen, and select [User's Guide] under [ABBYY FineReader for ScanSnap(TM) 5.0] on the All apps screen → [Technical Support].

- Windows 8

Right-click the Start screen, and select [All apps] on the app bar → [User's Guide] under [ABBYY FineReader for ScanSnap(TM) 5.0] → [Technical Support].

- Windows 7/Windows Vista/Windows XP

Select [Start] menu → [All Programs] → [ABBYY FineReader for ScanSnap(TM) 5.0] → [User's Guide] → [Technical Support].

- Evernote

Refer to the following web page:

<http://www.evernote.com/about/contact/support/>

- Google Docs

Refer to the Google Docs editors Help Center or the Google Docs Help Forum.

To open them, select [Help] in Google Docs.

- Salesforce

Contact the system administrator of your Salesforce.

- Dropbox

Refer to the following web page:

<http://www.dropbox.com/contact>

- ScanSnap

For other inquiries on the ScanSnap, refer to the ScanSnap Support Site.

<http://scansnap.fujitsu.com/g-support/en/>

If your problem cannot be solved after referring to the above web pages, visit the following web page to check the contact information of a suitable Fujitsu office and contact the Fujitsu office.

<http://imagescanner.fujitsu.com/warranty.html>

Suppliers of Consumables/Optional Parts

<http://scansnap.fujitsu.com/>

Maintenance

Contact your FUJITSU scanner dealer or an authorized FUJITSU scanner service provider for repairs on this product.

For details, refer to the following portal site:

<http://imagescanner.fujitsu.com/warranty.html>

ATTENTION

For safety reasons, never attempt repairs by yourself.