

fi-6130Z/fi-6230Z/fi-6140Z/fi-6240Z

Image Scanner

Operator's Guide

Thank you for purchasing the fi-Series color image scanner. This manual explains about the basic operations and handling of the scanner. For information on scanner installation, connection and software installation, refer to "Getting Started".

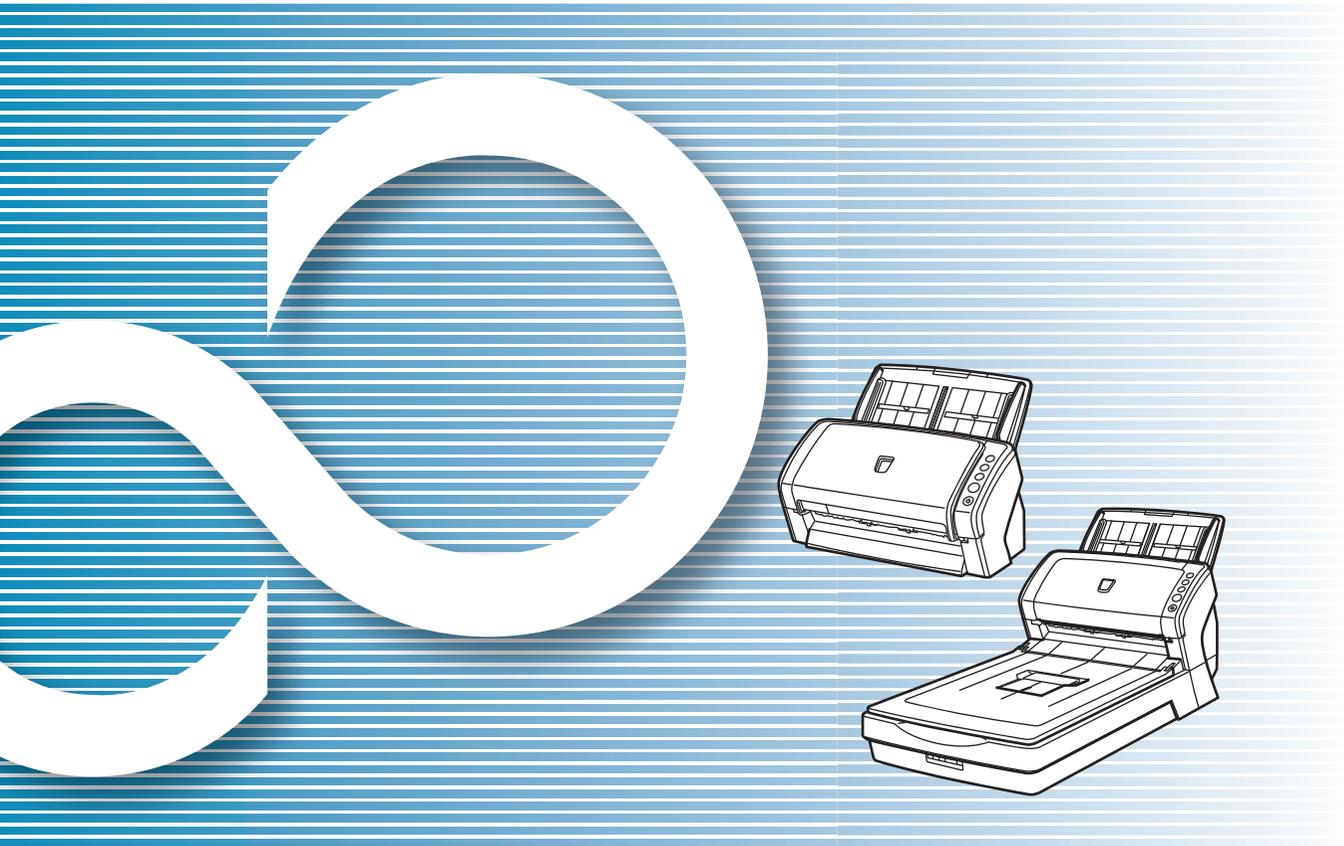

	TOP
	Contents
	Index
	Introduction
Explains the names and functions of parts and basic scanner operation.	Scanner Overview
Explains how to load documents on the scanner.	How to Load Documents
Explains about the setting items in the scanner drivers.	Configuring the Scan Settings
Explains how to use the Operator Panel.	How to Use the Operator Panel
Explains about various ways of scanning.	Various Ways to Scan
Explains how to clean the scanner.	Daily Care
Explains how to replace the consumables.	Replacing the Consumables
Explains about troubleshooting.	Troubleshooting
Explains how to configure settings in the Software Operation Panel.	Operational Settings
	Appendix
	Glossary

How to Use This Manual

The following shows the tips for using this manual.

- To display or print this manual, either Adobe® Acrobat® (7.0 or later) or Adobe® Reader® (7.0 or later) is required.
 - In this manual, you can use the Search tool of Adobe® Acrobat® or Adobe® Reader®.
For details, refer to the Adobe® Acrobat® or Adobe® Reader® Help.
 - Use the [Page Up] key to return to the previous page, and the [Page Down] key to go to the next page.
 - Click a blue character string, tab or contents/index title (where the mouse cursor changes into a shape such as ) to jump to the link.
- Common for all pages

Jumps to the first page of each chapter.
This tab is on every page.

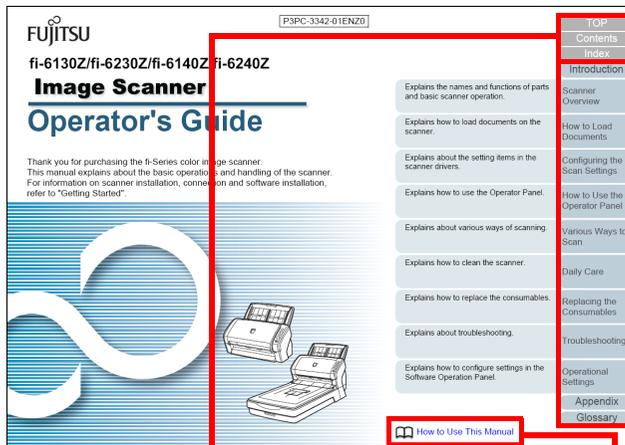

TOP : Jumps to the cover page.
 Contents: Jumps to the contents page.
 Index : Jumps to the index page.
 This tab is on every page.

- Contents page

Contents	
How to Use This Manual	2
Introduction	3
Conventions	5
Chapter 1 Before Using the Scanner	15
1.1 Main Features	16
1.2 Parts and Functions	17
fi-6130Z/6140Z	17
fi-6230Z/6240Z	20
1.3 Turning the Power ON/OFF	24
How to Turn the Power ON	24
How to Turn the Power OFF	24
1.4 Opening/Closing the ADF	25
How to Open the ADF	25
How to Close the ADF	25
1.5 Opening/Closing the Document Cover (fi-6230Z/6240Z)	26
How to Open the Document Cover	26
How to Close the Document Cover	26
1.6 Setting Up the ADF Paper Chute	27
1.7 Setting Up the Stacker	28
fi-6130Z/6140Z	28
fi-6230Z/6240Z	31
1.8 Resuming from Power Saving Mode	32
1.9 Basic Flow of Scanning Operation	33
1.10 Centralized Management of Scanners	36

Click on a title to jump to the link.

- Index page

Index	
A	ADF paper chute setup 27
	How to Open the ADF 25
	How to Close the ADF 25
	advanced scanning 89
B	basic flow of scanning operation 33
	basic specification 189
	Before Using the Operator Panel 63
	Before Using the Scanner 15
	before you contact the scanner service provider 149
C	centralized scanner management 36
	cleaning
	ADF (with Cleaning Paper) 110
	ADF (with cloth) 111
	Carrier Sheet 115
	flatbed 114
	inside 110
	outside 109
	Cleaning (ADF with cloth) 111
	Cleaning (inside) 110
	cleaning materials 108
	Configuration Items 100
	configuring the scan settings 50
	consumables 117
	brake roller 118
	conventions 5
	customizing the scanner settings 100
D	daily care 107
E	Error Indicators on Operator Panel 126
H	how to close the document cover 26
	how to open the document cover 26
	how to turn the power off 24
	how to turn the power on 24
	How to Use the Operator Panel 62
	how to use this manual 2
I	Installation Specification 192
	Introduction 3
	ISIS driver 55
L	loading
	ADF 39
	flatbed 41
	loading (ADF) 39
	loading documents 38, 40
	Locations that require cleaning 108

Click on a page number to jump to the link.

- TOP
- Contents
- Index
- Introduction
- Scanner Overview
- How to Load Documents
- Configuring the Scan Settings
- How to Use the Operator Panel
- Various Ways to Scan
- Daily Care
- Replacing the Consumables
- Troubleshooting
- Operational Settings
- Appendix
- Glossary

Introduction

Thank you for purchasing our fi-Series color image scanner.

About This Product

"This product" refers to four scanner models, which are fi-6130Z, fi-6230Z, fi-6140Z, and fi-6240Z.

Each scanner is equipped with an Automatic Document Feeder (ADF) that allows duplex (double-sided) scanning, and supports USB interface.

The following table shows the differences between each model.

Model	Scanner type		Interface		Scanning speed (*2)
	ADF	Flatbed (*1)	USB	SCSI	
fi-6130Z	✓	-	✓	-	30 ppm/60 ipm
fi-6230Z	✓	✓	✓	-	30 ppm/60 ipm
fi-6140Z	✓	-	✓	✓	40 ppm/80 ipm
fi-6240Z	✓	✓	✓	✓	40 ppm/80 ipm

✓ : Available

- : Not available

*1 : Flatbed allows you to scan thin paper and thick documents such as a book.

*2 : When scanning A4 size documents at 300 dpi with JPEG compression.

Manuals

The following manuals are included for this product. Read them as needed.

Manual	Description
Safety Precautions (paper)	Contains important information about the safe use of this product. Make sure to read this manual before using the scanner.
Getting Started (PDF)	Outlines the procedures from installation to operation of the scanner. Included in the Setup DVD-ROM.
Operator's Guide (this manual) (PDF)	Provides detailed information on how to operate and maintain the scanner daily, how to replace the consumables, and how to troubleshoot problems. Included in the Setup DVD-ROM.
ScandAll PRO V2.0 User's Guide (PDF)	Provides information on how to scan documents by using ScandAll PRO. Included in the Setup DVD-ROM.
fi-614PR Imprinter Operator's Guide (PDF)	Provides detailed information on how to operate and maintain the option fi-614PR imprinter daily, how to replace the consumables, and how to troubleshoot problems. Included in the Setup DVD-ROM.
FUJITSU TWAIN User's Guide (PDF)	Explains how to install and operate the FUJITSU TWAIN driver. Included in the Setup DVD-ROM.

Manual	Description
Kofax VRS Installation Guide (PDF) (*1)	Explains about the precautions for installing Kofax VRS and other features such as the VRS Professional features. Included in the Setup DVD-ROM.
Image Processing Software Option User's Guide (PDF)	Explains how to install and operate the Image Processing Software Option. Included in the Setup DVD-ROM.
Scanner Central Admin 4.0 User's Guide (PDF)	Explains about the overview, installation, operation and maintenance of Scanner Central Admin. Included in the Setup DVD-ROM.
Error Recovery Guide (HTML Help)	Details the status of the scanner and explains how to resolve problems encountered. Contains movies that explain how to clean and replace the consumables. Included in the Setup DVD-ROM.
Help (scanner driver)	Explains how to use and configure the settings for the scanner drivers. Can be referenced from each scanner driver.
Help (application)	Explains how to use and configure the settings for the application software. Can be referenced from each application.

*1 : Kofax VRS Professional (hereinafter referred to as "Kofax VRS") is bundled with this product.

Trademarks

Microsoft, Windows, Windows Server, Windows Vista, and SharePoint are either registered trademarks or trademarks of Microsoft Corporation in the United States and/or other countries.

ISIS and Quick Scan are either registered trademarks or trademarks of EMC Corporation in the United States. Adobe, the Adobe logo, Acrobat, and Adobe Reader are either registered trademarks or trade names of Adobe Systems Incorporated in the United States and/or other countries. ABBYY™ FineReader™ Engine © 2011 ABBYY. OCR by ABBYY

ABBYY and FineReader are trademarks of ABBYY. Kofax and VRS are registered trademarks or trademarks of Kofax, Inc.

Other company names and product names are the registered trademarks or trademarks of the respective companies.

Manufacturer

PFU LIMITED

International Sales Dept., Imaging Business Division,
Products Group
Solid Square East Tower,
580 Horikawa-cho, Saiwai-ku, Kawasaki, Kanagawa
212-8563, JAPAN.

Phone: (81-44) 540-4538

© PFU LIMITED 2011-2012

TOP

Contents

Index

Introduction

Scanner
Overview

How to Load
Documents

Configuring the
Scan Settings

How to Use the
Operator Panel

Various Ways to
Scan

Daily Care

Replacing the
Consumables

Troubleshooting

Operational
Settings

Appendix

Glossary

Conventions

Safety Information

The attached "Safety Precautions" manual contains important information about the safe and correct use of this product. Make sure that you read and understand it before using the scanner.

Symbols Used in This Manual

The following indications are used in this manual to obviate any chance of accident or damage to you, people near you, and your property. Warning labels consist of a symbol indicating the severity and a warning statement. The symbols and their meanings are as follows.



This indication alerts operators to an operation that, if not strictly observed, may result in severe injury or death.



This indication alerts operators to an operation that, if not strictly observed, may result in safety hazards to personnel or damage to the product.

Besides warning indicators, the following symbols are used in this manual.



This symbol alerts operators to particularly important information. Be sure to read this information.



This symbol alerts operators to helpful advice regarding operation.

Abbreviations Used in This Manual

The operating systems and products in this manual are indicated as follows.

Name	Indication
<ul style="list-style-type: none"> ● Windows® XP Home Edition ● Windows® XP Professional ● Windows® XP Professional x64 Edition 	Windows XP (*1)
<ul style="list-style-type: none"> ● Windows Server® 2003, Standard Edition ● Windows Server® 2003, Standard x64 Edition ● Windows Server® 2003 R2, Standard Edition ● Windows Server® 2003 R2, Standard x64 Edition 	Windows Server 2003 (*1)
<ul style="list-style-type: none"> ● Windows Vista® Home Basic (32/64-bit) ● Windows Vista® Home Premium (32/64-bit) ● Windows Vista® Business (32/64-bit) ● Windows Vista® Enterprise (32/64-bit) ● Windows Vista® Ultimate (32/64-bit) 	Windows Vista (*1)
<ul style="list-style-type: none"> ● Windows Server® 2008 Standard (32/64-bit) ● Windows Server® 2008 R2 Standard (64-bit) 	Windows Server 2008 (*1)
<ul style="list-style-type: none"> ● Windows® 7 Home Premium (32/64-bit) ● Windows® 7 Professional (32/64-bit) ● Windows® 7 Enterprise (32/64-bit) ● Windows® 7 Ultimate (32/64-bit) 	Windows 7 (*1)

Name	Indication
<ul style="list-style-type: none"> ● Microsoft® Office SharePoint® Portal Server 2003 ● Microsoft® Office SharePoint® Server 2007 ● Microsoft® SharePoint® Server 2010 	SharePoint Server
ScandAll PRO ScanSnap mode Add-in	ScanSnap mode
ScanSnap Carrier Sheet	Carrier Sheet

*1: Where there is no distinction between the different versions of the above operating system, the general term "Windows" is used.

Arrow Symbols in This Manual

Right-arrow symbols (→) are used to separate icons or menu options you should select in succession.

Example: Click the [Scan] menu → [Scanner Setting].

Screen Examples in This Manual

The screen examples in this manual are subject to change without notice in the interest of product improvement.

If the actual displayed screen differs from the screen examples in this manual, operate by following the actual displayed screen while referring to the user's manual of the scanner application that you are using.

The screen examples used in this manual are of the TWAIN driver, ISIS driver, and ScandAll PRO (image scanning application).

This manual uses screenshots from Windows 7. The windows that appear and the operations differ by the operating system that you are using. Also note that with some scanner models, the screens and operations may differ from this manual when you update the TWAIN driver or the ISIS driver. In that case, refer to the manual provided upon updating the driver.

Contents

How to Use This Manual	2
Introduction	3
Conventions	5
Chapter 1 Scanner Overview	14
1.1 Main Features	15
1.2 Parts and Functions	16
fi-6130Z/fi-6140Z	16
fi-6230Z/fi-6240Z	19
1.3 Turning the Power ON/OFF	23
How to Turn the Power ON	23
How to Turn the Power OFF	23
1.4 Opening/Closing the ADF	24
How to Open the ADF	24
How to Close the ADF	24
1.5 Opening/Closing the Document Cover (fi-6230Z/fi-6240Z)	25
How to Open the Document Cover	25
How to Close the Document Cover	25
1.6 Setting Up the ADF Paper Chute	26
1.7 Setting Up the Stacker	27
fi-6130Z/fi-6140Z	27
fi-6230Z/fi-6240Z	30
1.8 Power Saving Mode	31
1.9 Basic Flow of Scanning Operation	32
1.10 Image Scanning Application	35

TOP
Contents
Index
Introduction
Scanner Overview
How to Load Documents
Configuring the Scan Settings
How to Use the Operator Panel
Various Ways to Scan
Daily Care
Replacing the Consumables
Troubleshooting
Operational Settings
Appendix
Glossary

1.11	Centralized Management of Scanners	36
Chapter 2	How to Load Documents	37
2.1	Loading Documents in the ADF	38
	Preparation.....	38
	How to Load Documents	39
2.2	Loading Documents on the Flatbed (fi-6230Z/fi-6240Z)	40
2.3	Documents for Scanning (ADF)	41
	Paper Size.....	41
	Conditions	41
	Loading Capacity.....	44
	Area Not to be Perforated	45
	Conditions for Multifeed Detection	45
	Conditions for Mixed Batch Scanning	47
	Conditions for Automatic Page Size Detection.....	49
	Conditions for Using the Carrier Sheet.....	50
Chapter 3	Configuring the Scan Settings	51
3.1	TWAIN Driver	52
	[Resolution]	53
	[Scan Type]	53
	[Paper Size].....	53
	[Image Mode]	53
	[Scan] Button.....	53
	[Preview] Button	54
	[Close] / [OK] Button.....	54
	[Reset] Button.....	54
	[Help] Button.....	54
	[About] Button.....	54

TOP
Contents
Index
Introduction
Scanner Overview
How to Load Documents
Configuring the Scan Settings
How to Use the Operator Panel
Various Ways to Scan
Daily Care
Replacing the Consumables
Troubleshooting
Operational Settings
Appendix
Glossary

[Option] Button	54
[Advance] Button	55
[Config] Button	55
[Browse] Button	55
3.2 ISIS Driver	56
[Main] Tab	57
[Layout] Tab	57
[Image Processing] Tab	58
[Paper Handling] Tab	59
[Gamma] Tab	59
[Color Dropout] Tab	60
[Compression] Tab	60
[Imprinter] Tab	61
[Blank Page Deletion] Tab	61
[About] Tab	62
Chapter 4 How to Use the Operator Panel	63
4.1 Operator Panel	64
Names and Functions	64
Indications on Function Number Display	65
Chapter 5 Various Ways to Scan	66
5.1 Summary	67
5.2 Scanning Documents of Different Types and Sizes	68
Scanning Both Sides at Once	68
Documents with Different Widths	69
Documents Larger than A4/Letter Size	70
Scanning Photographs and Clippings	73
Long Page Scanning	76

TOP
Contents
Index
Introduction
Scanner Overview
How to Load Documents
Configuring the Scan Settings
How to Use the Operator Panel
Various Ways to Scan
Daily Care
Replacing the Consumables
Troubleshooting
Operational Settings
Appendix
Glossary

Scanning a Book (fi-6230Z/fi-6240Z)	78
Scanning a Large Document on the Flatbed (fi-6230Z/fi-6240Z)	80
5.3 Advanced Scanning	82
Removing a Color from the Scanned Image (Dropout Color)	82
Skipping Blank Pages	85
Removing Punch Holes	86
Scanning the Image Brighter	88
Feeding Documents Manually in the ADF	90
5.4 Configuring Post-Scan Operations and Handling	91
Automatically Correcting Skewed Images	91
Automatically Correcting the Page Orientation	93
Splitting the Scanned Image in Two	95
Using the Multi Image Output	97
Automatically Detecting Color/Monochrome Documents	99
5.5 Customizing the Scanner Settings	101
Using a Button on the Scanner to Start Scanning	101
Detecting Multifeed Errors	103
Ignoring Multifeed for a Set Pattern	105
Chapter 6 Daily Care	108
6.1 Cleaning Materials and Locations that Require Cleaning	109
Cleaning Materials	109
Location and Frequency	109
6.2 Cleaning the Outside	110
fi-6130Z/fi-6140Z	110
fi-6230Z/fi-6240Z	110
6.3 Cleaning the Inside	111
Cleaning the ADF (with Cleaning Paper)	111
Cleaning the ADF (with cloth)	112

TOP
Contents
Index
Introduction
Scanner Overview
How to Load Documents
Configuring the Scan Settings
How to Use the Operator Panel
Various Ways to Scan
Daily Care
Replacing the Consumables
Troubleshooting
Operational Settings
Appendix
Glossary

Cleaning the Flatbed (fi-6230Z/fi-6240Z)	115
6.4 Cleaning the Carrier Sheet	116
Chapter 7 Replacing the Consumables	117
7.1 Consumables and Replacement Cycles	118
7.2 Replacing the Brake Roller	119
7.3 Replacing the Pick Roller	121
Chapter 8 Troubleshooting	124
8.1 Paper Jam	125
8.2 Error Indications on Operator Panel	126
Temporary Errors	127
Device Errors.....	128
8.3 Troubleshooting	130
Scanner cannot be powered ON.....	131
The Function Number Display switches OFF.....	132
Scanning does not start.....	133
Image quality is poor when scanning pictures/photos in black & white.....	134
Quality of scanned text or lines is unsatisfactory.....	135
Images are distorted or not clear.....	136
Vertical streaks appear on the scanned image.....	137
"E" (or other number/letter) is already displayed on the Function Number Display after power-on.....	138
Multifeed error occurs frequently.....	139
Situation in which the document is not fed into the ADF occurs frequently.....	141
Paper jams/pick errors occur frequently.....	142
Scanned images turn out elongated.....	143
A shadow appears at the top or the bottom of the scanned image.....	144
There are black traces on the document.....	145
The Carrier Sheet is not fed smoothly. / Paper jams occur.....	146

TOP
Contents
Index
Introduction
Scanner Overview
How to Load Documents
Configuring the Scan Settings
How to Use the Operator Panel
Various Ways to Scan
Daily Care
Replacing the Consumables
Troubleshooting
Operational Settings
Appendix
Glossary

Part of the image appears missing when using the Carrier Sheet	148
8.4 Before You Contact the Scanner Service Provider	149
General.....	149
Error Status	150
8.5 Checking the Product Labels	151
Location.....	151
Chapter 9 Operational Settings	152
9.1 Starting Up the Software Operation Panel	153
9.2 Password Setting	154
Setting a Password	154
Setting the [View Only mode]	155
Clearing the [View Only mode].....	156
Changing the Password	157
Clearing the Password	158
Resetting the Password	159
9.3 Configuration Items	160
Device Setting	160
Device Setting 2	162
9.4 Settings Related to Page Counters	166
Checking and Resetting the Counters.....	166
Replacement Cycle of Consumables [Life Counter Alarm Setting]	168
9.5 Settings Related to Scanning	169
Adjusting the Position to Start the Scan [Offset/Vertical magnification Adjustment]	169
Removing Shadows/Streaks that Appear around the Scanned Image [Page Edge Filler (ADF)] / [Page Edge Filler (FB)] (fi-6230Z/fi-6240Z).....	171
Removing a Color from the Scanned Image [Dropout color].....	173
Shortening the Scanning Intervals [Pre-Pick].....	174
Number of Paper Feeding Retries.....	175

TOP
Contents
Index
Introduction
Scanner Overview
How to Load Documents
Configuring the Scan Settings
How to Use the Operator Panel
Various Ways to Scan
Daily Care
Replacing the Consumables
Troubleshooting
Operational Settings
Appendix
Glossary

Cropping the Image Boundary [AutoCrop Boundary]	176
Protecting the Documents from Being Damaged [Paper Protection]	177
Specifying the Sensitivity Level for Paper Protection [Paper Protection Sensitivity]	178
Scanning Thick Plastic Cards [Feed Mode] (fi-6140Z/fi-6240Z).....	179
9.6 Settings Related to Multifeed Detection	180
Specifying a Multifeed Detection Method [Multifeed]	180
Specifying the Area to Detect Multifeed [Document check area specification for Multifeed Detection].....	182
Specifying an Area Not to Detect Multifeed [Intelligent Multifeed Function].....	185
9.7 Settings Related to Waiting Time	186
Waiting Time in Manual Feed Mode [Manual-feed timeout].....	186
Waiting Time to Enter Power Saving Mode [Power saving]	187
9.8 Settings Related to Power ON/OFF	188
Method of Turning the Scanner ON/OFF [Power SW Control].....	188
Appendix	189
A.1 Basic Specification	190
A.2 Installation Specification	193
A.3 Outer Dimensions	195
fi-6130Z/fi-6140Z	195
fi-6230Z/fi-6240Z	195
A.4 Scanner Options	196
A.5 Uninstalling the Software	197
Glossary	198
Index	209

TOP
Contents
Index
Introduction
Scanner Overview
How to Load Documents
Configuring the Scan Settings
How to Use the Operator Panel
Various Ways to Scan
Daily Care
Replacing the Consumables
Troubleshooting
Operational Settings
Appendix
Glossary

Chapter 1 Scanner Overview

This chapter explains about the names and functions of the scanner components, as well as the methods for basic operations.

1.1 Main Features.....	15
1.2 Parts and Functions.....	16
1.3 Turning the Power ON/OFF	23
1.4 Opening/Closing the ADF	24
1.5 Opening/Closing the Document Cover (fi-6230Z/fi-6240Z)	25
1.6 Setting Up the ADF Paper Chute	26
1.7 Setting Up the Stacker.....	27
1.8 Power Saving Mode	31
1.9 Basic Flow of Scanning Operation	32
1.10 Image Scanning Application.....	35
1.11 Centralized Management of Scanners	36

1.1 Main Features

This section explains about the main features of this product. The scanner is equipped with the following features:

High speed scanning

Realizes a scanning speed of 30 ppm/60 ipm (fi-6130Z/fi-6230Z), or 40 ppm/80 ipm (fi-6140Z/fi-6240Z) (*1). Furthermore, you can load up to 50 sheets of documents for continuous scanning which allows you to quickly digitize a large volume of documents.

Capable of scanning photographs, clippings, and documents larger than A4/Letter size

The bundled "Carrier Sheet" allows you to scan documents that are larger than A4/Letter size, as well as non-standard size documents such as photographs and clippings. You can load multiple Carrier Sheets or mix it with regular documents in the same batch.

Function Number Display

The scanner mounts a "Function Number Display" which displays error indications. It is used to easily check the status of the scanner.

Improved efficiency for pre-scan work

The scanner can perform "batch scanning" which allows you to scan documents with different paper weights and sizes at once, simplifying the process of sorting the documents before scanning.

Reduced work loss caused by multifeeds

The scanner mounts an ultrasonic multifeed sensor that accurately detects "multifeed" errors where two or more sheets are fed through the scanner at once. This multifeed detection is reliable even when scanning a mixed batch of documents with different paper weights and sizes, avoiding potential work loss.

Intelligent Multifeed function

When there is paper of the same size attached to a designated location on the page, the Intelligent Multifeed function enables the scanner to recognize the location of the attachment. This allows you to continue scanning instead of pausing the scan by detecting every paper attachment as multifeed. Furthermore, the "paper protection" function will reduce the risk of damaging your valuable documents.

Advanced image processing function

The scanner's automatic detection function outputs images in color or monochrome by the document content.

Imprinter option

Imprinter is available as an option, which is often demanded for managing/verifying documents. Having the capability to print on the scanned documents could drastically improve usability.

The imprinter can be installed on fi-6130Z or fi-6140Z.

Scanning on black background

Black document pad is available as an option, which allows you to perform scanning on black background when using the flatbed. It can be used to automatically correct skewed images or accurately detect the size of the scanned document.

The black document pad can be used on fi-6230Z or fi-6240Z.

Centralized management of multiple scanners

The bundled "Scanner Central Admin Agent" application allows you to manage multiple scanners together, for example, to update the scanner settings and drivers, as well as to monitor the operating status of each scanner.

*1: When scanning A4 size documents at 300 dpi with JPEG compression.

1.2 Parts and Functions

This section shows the names of the scanner parts.

fi-6130Z/fi-6140Z

■ Front

Side guide

Guides the documents in width direction as they are fed into the scanner.

ADF (Automatic Document Feeder)

Pulls and feeds the documents one sheet at a time from the ADF paper chute. Open to replace consumables or clean the inside of the scanner.

Stacker

Stacks up the ejected documents.

Stacker extension 1

Slide out to adjust to the document length.

Stacker extension 2

Lift up to adjust to the document length.

Stacker extension 3

Lift up to adjust to the document length.

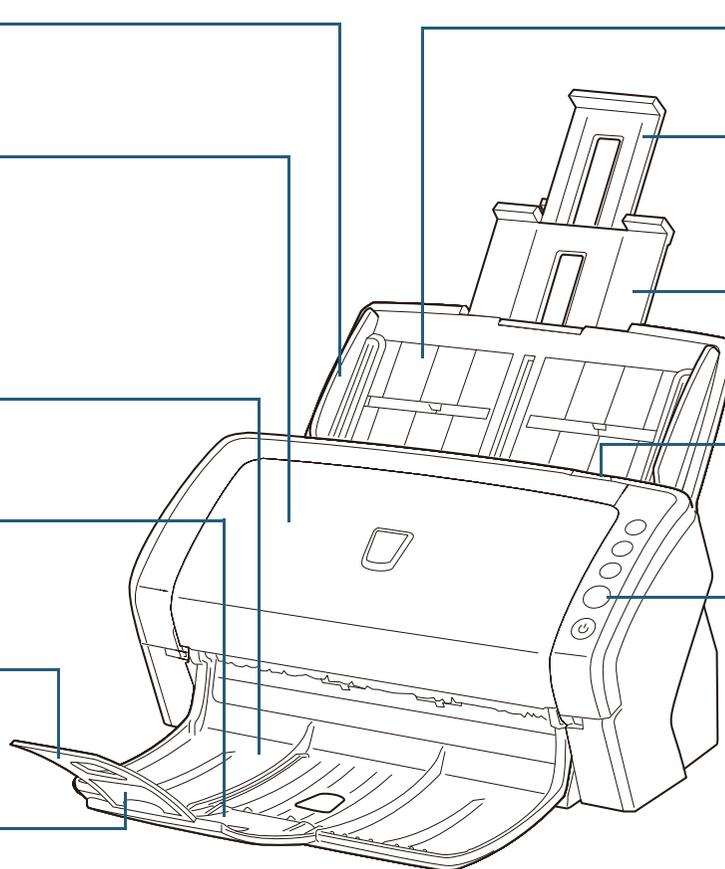

ADF paper chute

Holds the documents to be scanned.

Chute extension 2

Pull out to adjust to the document length.

Chute extension 1

Pull out to adjust to the document length.

ADF release tab

Pull this tab to open the ADF.

Operator panel

Consists of the Function Number Display, buttons, and LED indicator. Can be used to operate the scanner or check the status. For details, refer to ["Chapter 4 How to Use the Operator Panel"](#) (page 63).

TOP

Contents

Index

Introduction

Scanner
OverviewHow to Load
DocumentsConfiguring the
Scan SettingsHow to Use the
Operator PanelVarious Ways to
Scan

Daily Care

Replacing the
Consumables

Troubleshooting

Operational
Settings

Appendix

Glossary

■ Back

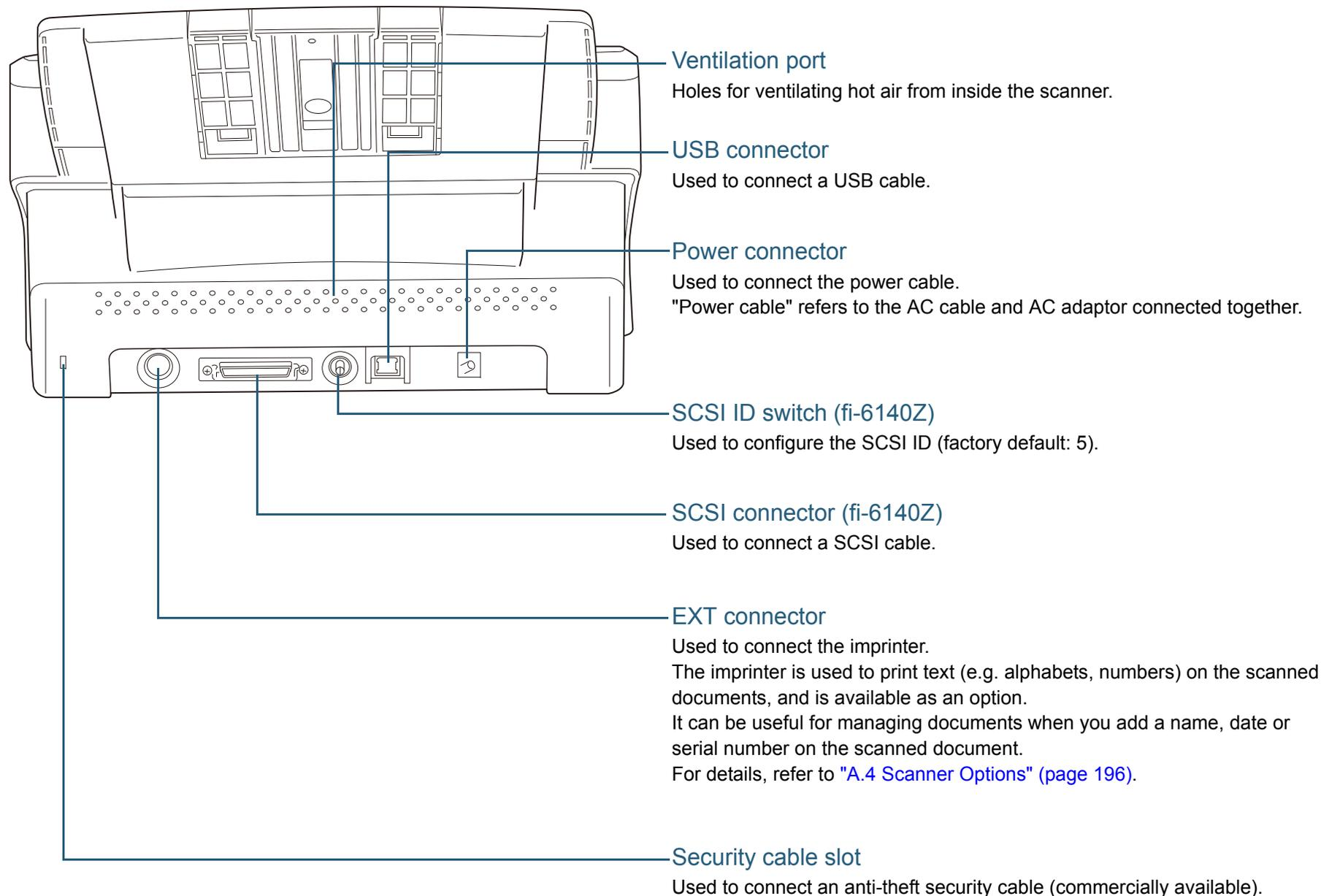

- TOP
- Contents
- Index
- Introduction
- Scanner Overview**
- How to Load Documents
- Configuring the Scan Settings
- How to Use the Operator Panel
- Various Ways to Scan
- Daily Care
- Replacing the Consumables
- Troubleshooting
- Operational Settings
- Appendix
- Glossary

Removable Parts

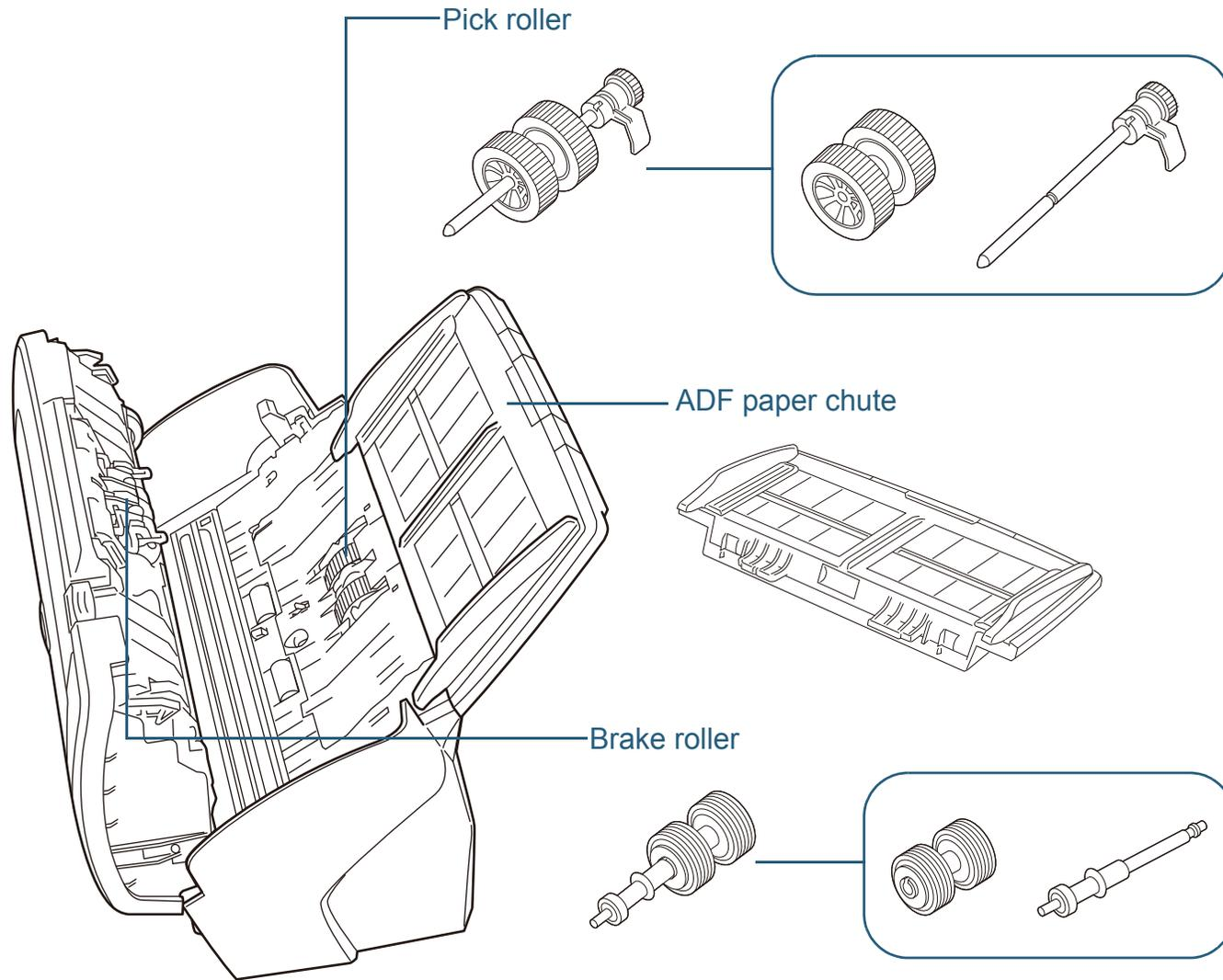

TOP

Contents

Index

Introduction

Scanner Overview

How to Load Documents

Configuring the Scan Settings

How to Use the Operator Panel

Various Ways to Scan

Daily Care

Replacing the Consumables

Troubleshooting

Operational Settings

Appendix

Glossary

fi-6230Z/fi-6240Z

■ Front

Side guide

Guides the documents in width direction as they are fed into the scanner.

ADF (Automatic Document Feeder)

Pulls and feeds the documents one sheet at a time from the ADF paper chute. Open to replace consumables or clean the inside of the scanner.

Stacker

Stacks up the ejected documents.

Stacker extension

Lift up to adjust to the document length.

Flatbed

For scanning documents (e.g. thin paper, books) that cannot be scanned with the ADF.

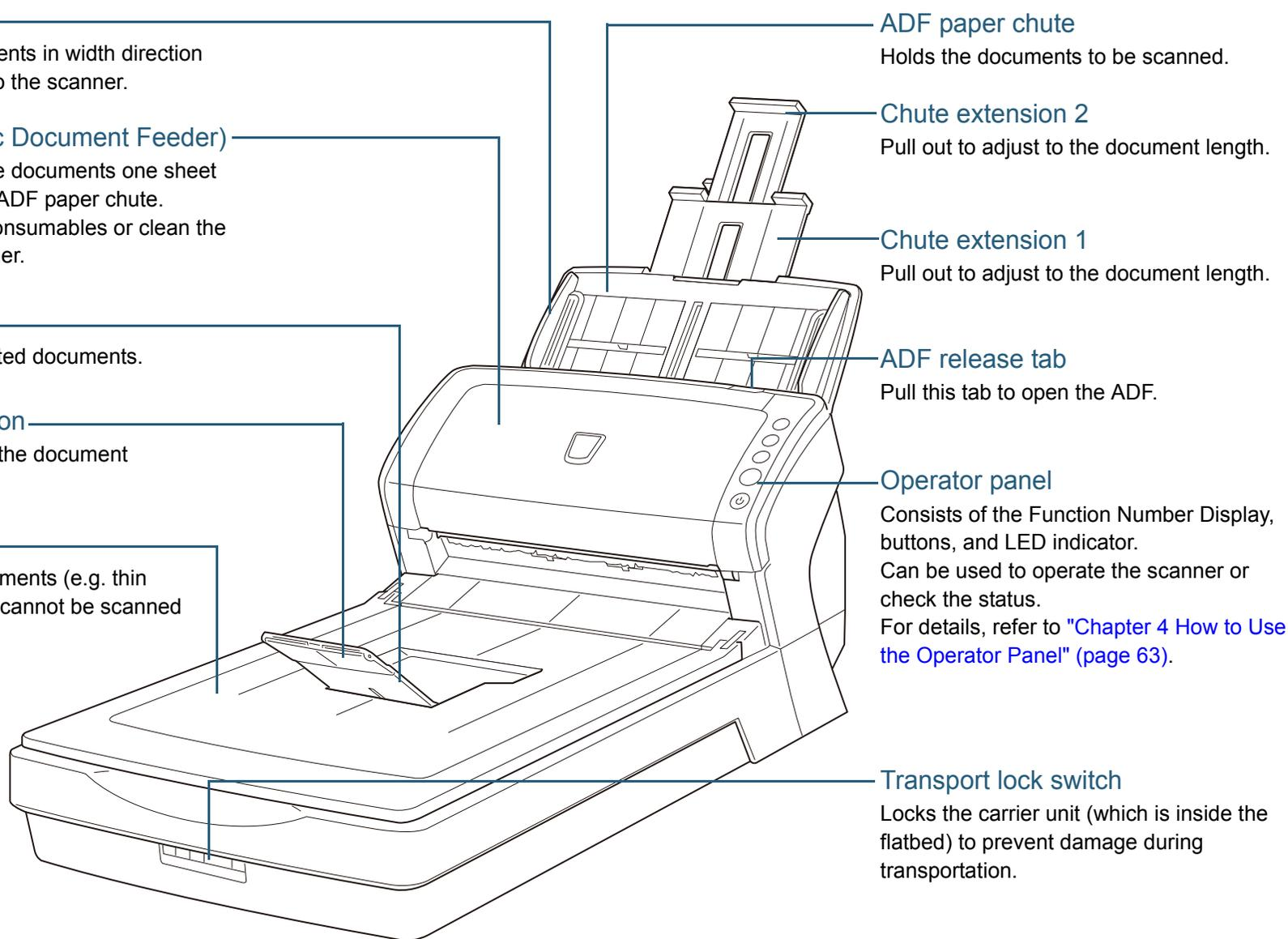

ADF paper chute

Holds the documents to be scanned.

Chute extension 2

Pull out to adjust to the document length.

Chute extension 1

Pull out to adjust to the document length.

ADF release tab

Pull this tab to open the ADF.

Operator panel

Consists of the Function Number Display, buttons, and LED indicator. Can be used to operate the scanner or check the status. For details, refer to "[Chapter 4 How to Use the Operator Panel](#)" (page 63).

Transport lock switch

Locks the carrier unit (which is inside the flatbed) to prevent damage during transportation.

TOP

Contents

Index

Introduction

Scanner Overview

How to Load Documents

Configuring the Scan Settings

How to Use the Operator Panel

Various Ways to Scan

Daily Care

Replacing the Consumables

Troubleshooting

Operational Settings

Appendix

Glossary

■ Inside

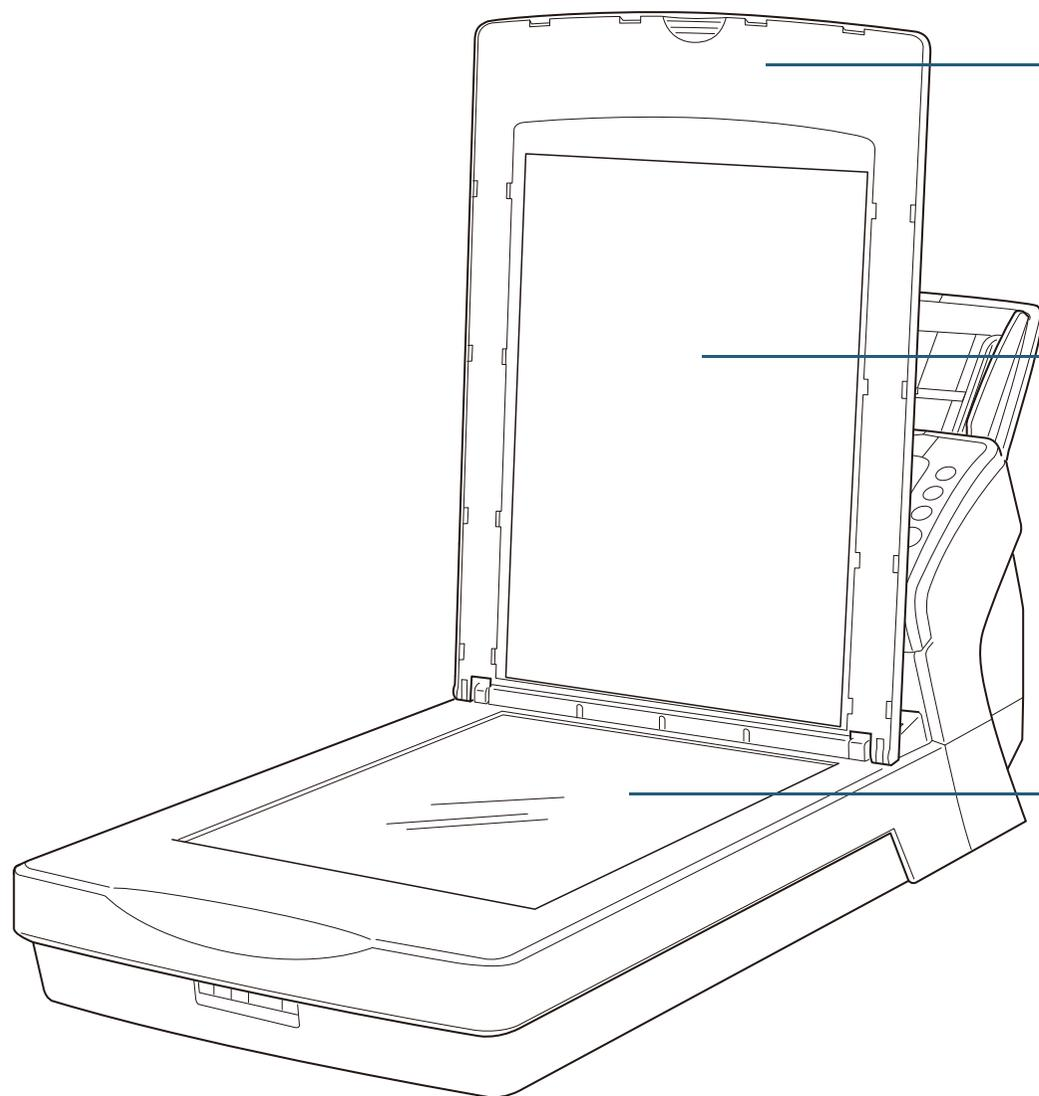

Document cover

Close it to hold the document in place.

Document pad

Holds the document down against the document bed. Document cover with a black document pad is also available as an option.

Use it to perform scanning in black background on the flatbed.

For details, refer to "[A.4 Scanner Options](#)" (page 196).

Document bed

Place a document on the glass section.

TOP

Contents

Index

Introduction

Scanner Overview

How to Load Documents

Configuring the Scan Settings

How to Use the Operator Panel

Various Ways to Scan

Daily Care

Replacing the Consumables

Troubleshooting

Operational Settings

Appendix

Glossary

■ Back

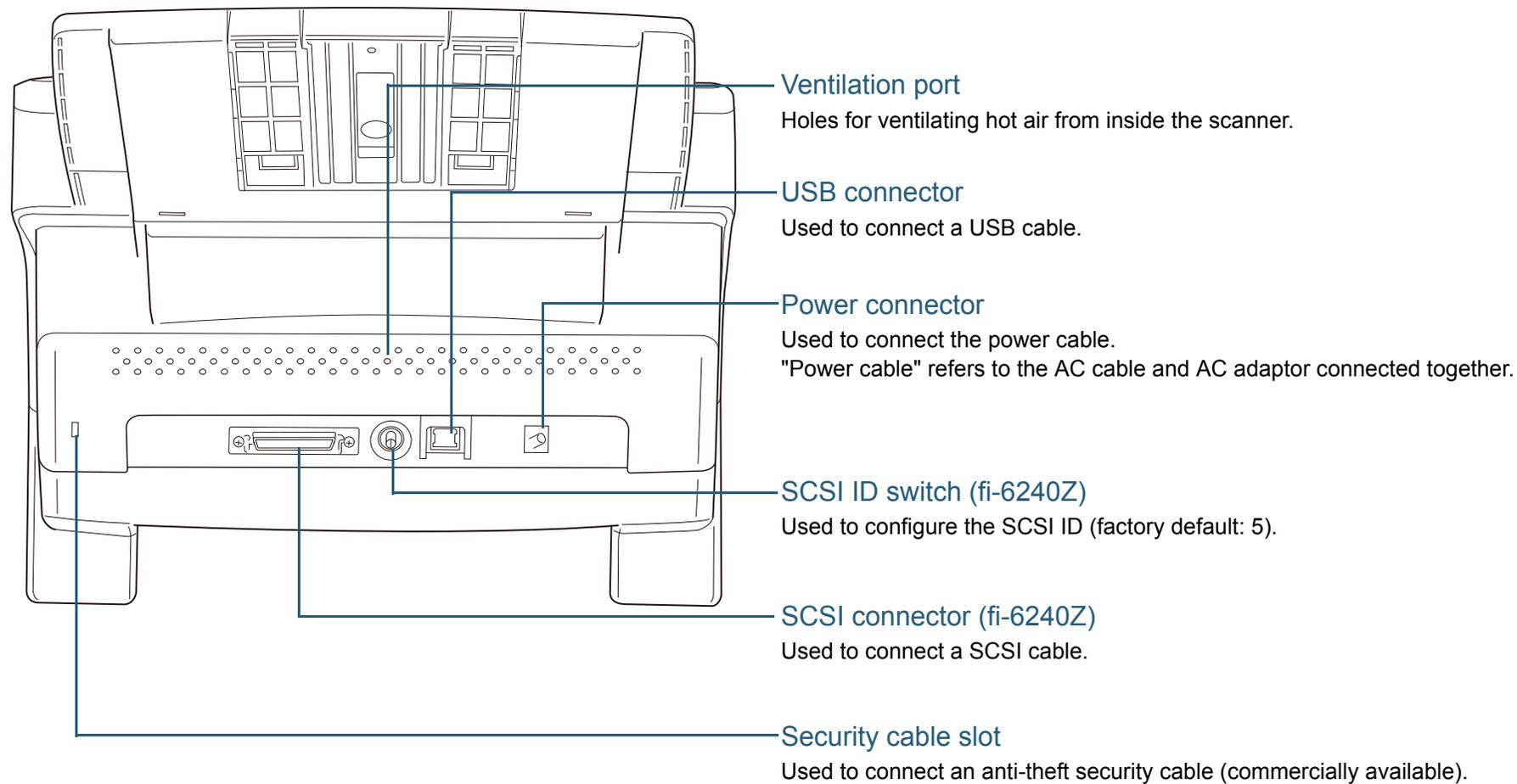

- TOP
- Contents
- Index
- Introduction
- Scanner Overview**
- How to Load Documents
- Configuring the Scan Settings
- How to Use the Operator Panel
- Various Ways to Scan
- Daily Care
- Replacing the Consumables
- Troubleshooting
- Operational Settings
- Appendix
- Glossary

Removable Parts

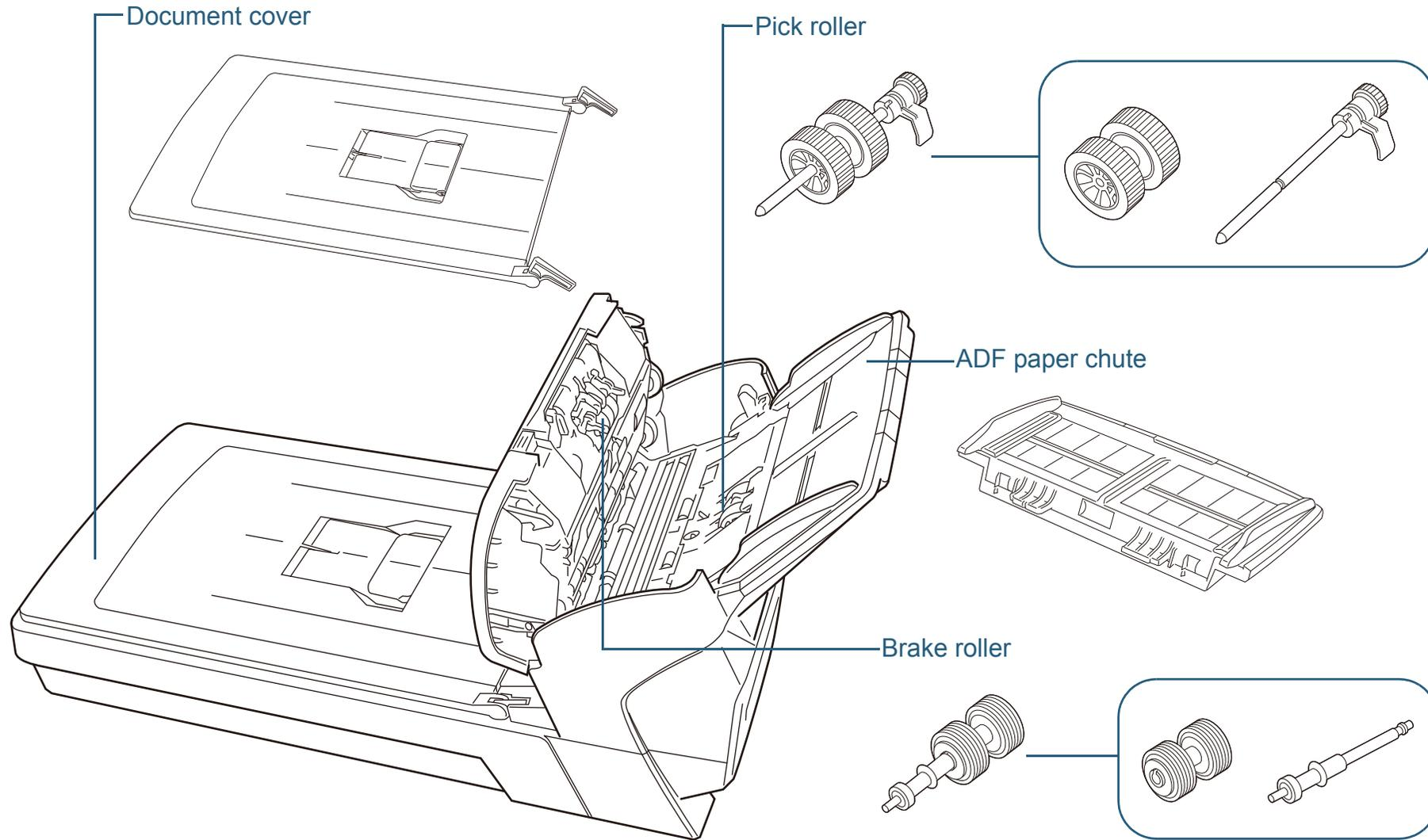

TOP

Contents

Index

Introduction

Scanner Overview

How to Load Documents

Configuring the Scan Settings

How to Use the Operator Panel

Various Ways to Scan

Daily Care

Replacing the Consumables

Troubleshooting

Operational Settings

Appendix

Glossary

1.3 Turning the Power ON/OFF

This section explains how to power on/off the scanner.



The method by which the scanner is powered on/off can be specified from one of the following:

- Press the [Power] button on the operator panel
- Unplug the power cable then plug it back in
- Have the scanner turn on/off in sync with the computer's power

For details, refer to "[Method of Turning the Scanner ON/OFF \[Power SW Control\]](#)" (page 188).

How to Turn the Power ON



When connected via SCSI, turn on the scanner and confirm that "1" is displayed on the Function Number Display before you turn on the computer.

- 1 Press the [Power] button on the operator panel.

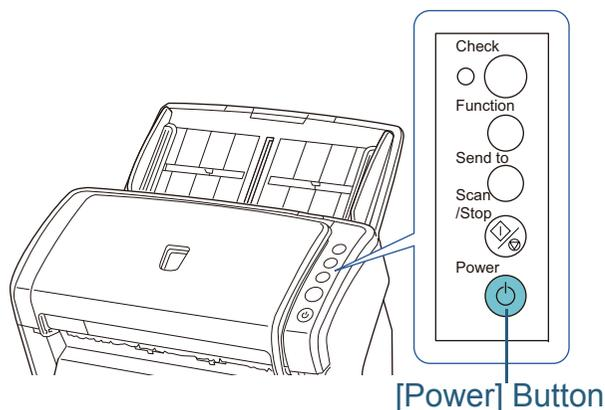

- ⇒ The scanner is turned on, and the [Power] button lights in green. During initialization, the Function Number Display changes in the following order: "8" → "P" → "0" → "1". "1" indicates that the scanner is ready.



When you press the [Power] button, the LED indicator will flash once. Note that this is an initial diagnosis and not a malfunction.

How to Turn the Power OFF

- 1 Press the [Power] button on the operator panel for more than 2 seconds.
 - ⇒ The scanner is turned off, and the [Power] button switches off.

1.4 Opening/Closing the ADF

This section describes how to open and close the ADF.

How to Open the ADF

- 1 Remove all documents from the ADF paper chute.
- 2 Pull the ADF release tab towards you to open the ADF.

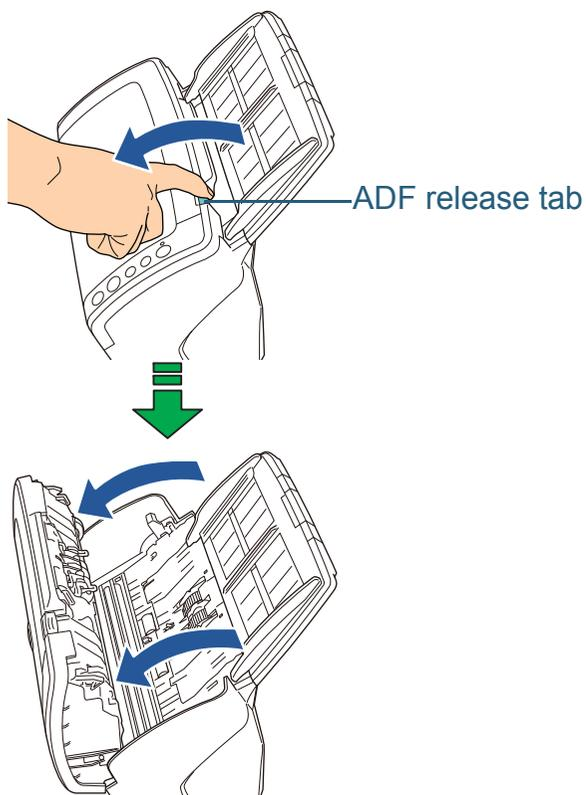

Be careful not to have your fingers caught when the ADF closes.

How to Close the ADF

- 1 Close the ADF.
Push the center of the ADF until it locks in place.

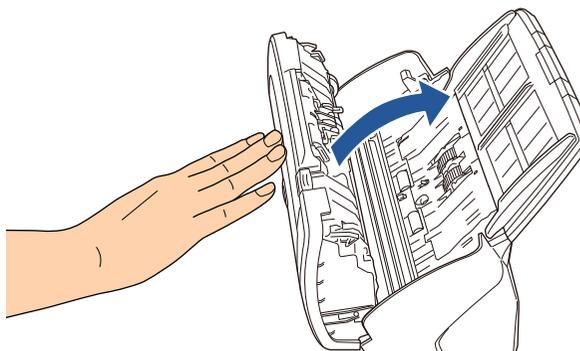

Be careful not to have your fingers caught when the ADF closes.



Make sure that there is no foreign matter caught inside the ADF.

1.5 Opening/Closing the Document Cover (fi-6230Z/fi-6240Z)

This section describes how to open and close the document cover.

How to Open the Document Cover

- 1 Open the document cover.

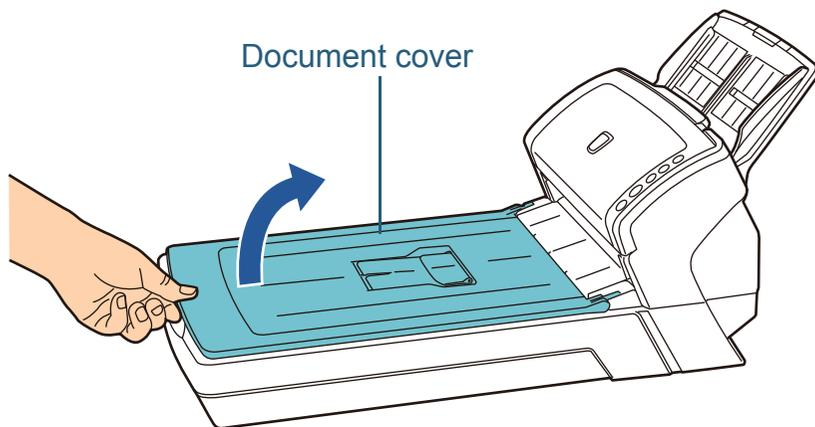

How to Close the Document Cover

- 1 Gently close the document cover.

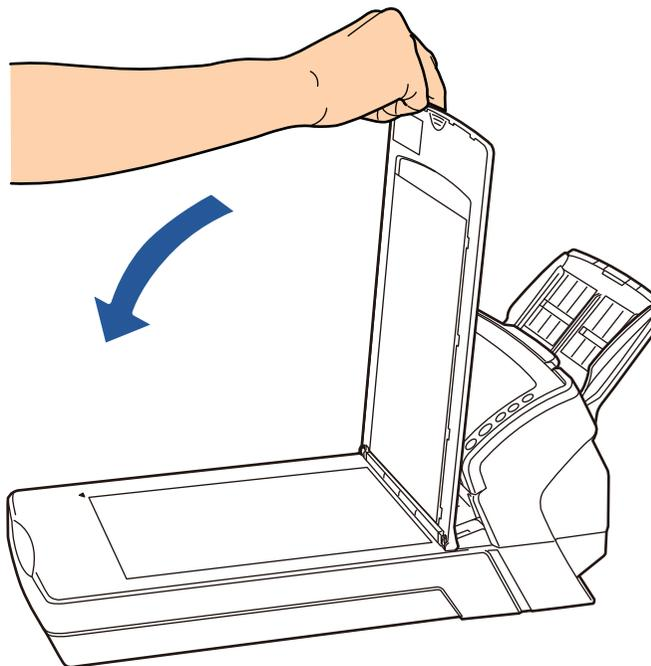

1.6 Setting Up the ADF Paper Chute

Documents loaded in the ADF paper chute are fed into the ADF one by one.

Using the chute extensions will keep the documents straight and feed them smoothly.

1 Pull out chute extension 1.

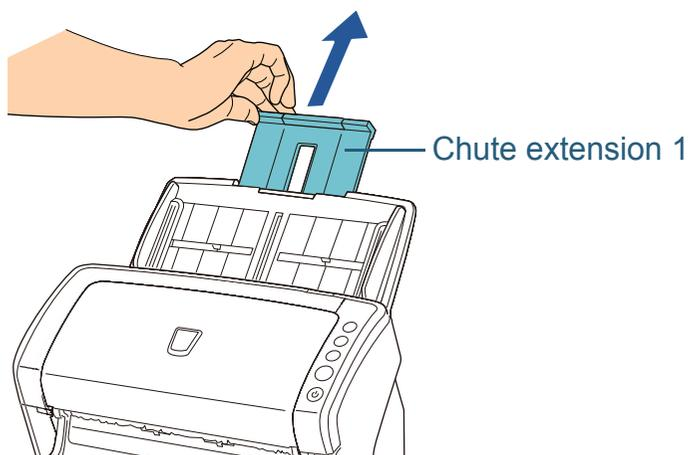

Make sure to hold the scanner while you pull out the chute extension.

2 Pull out chute extension 2.

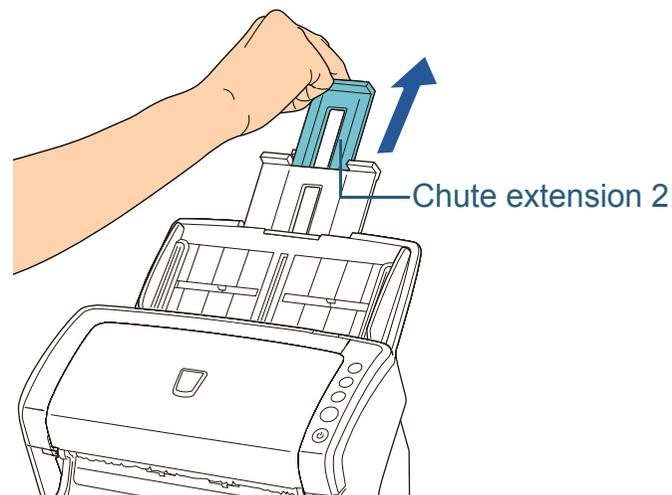

Make sure to hold the scanner while you pull out the chute extension.

1.7 Setting Up the Stacker

Documents loaded in the ADF paper chute are ejected onto the stacker one by one.

Using the stacker and stacker extensions will keep the documents straight and stack them neatly.

fi-6130Z/fi-6140Z

■ A6 (landscape) or larger

- 1 Bring down the stacker from the top towards you.

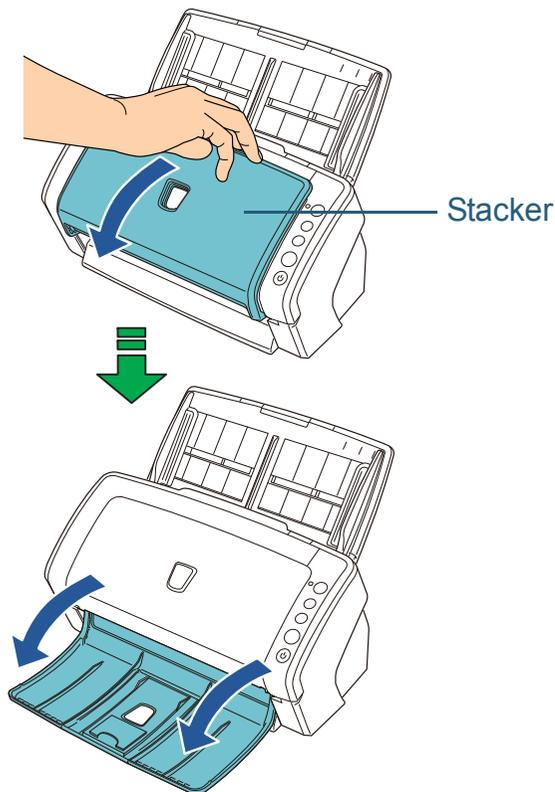

- 2 Slide out the stacker extension 1 towards you.

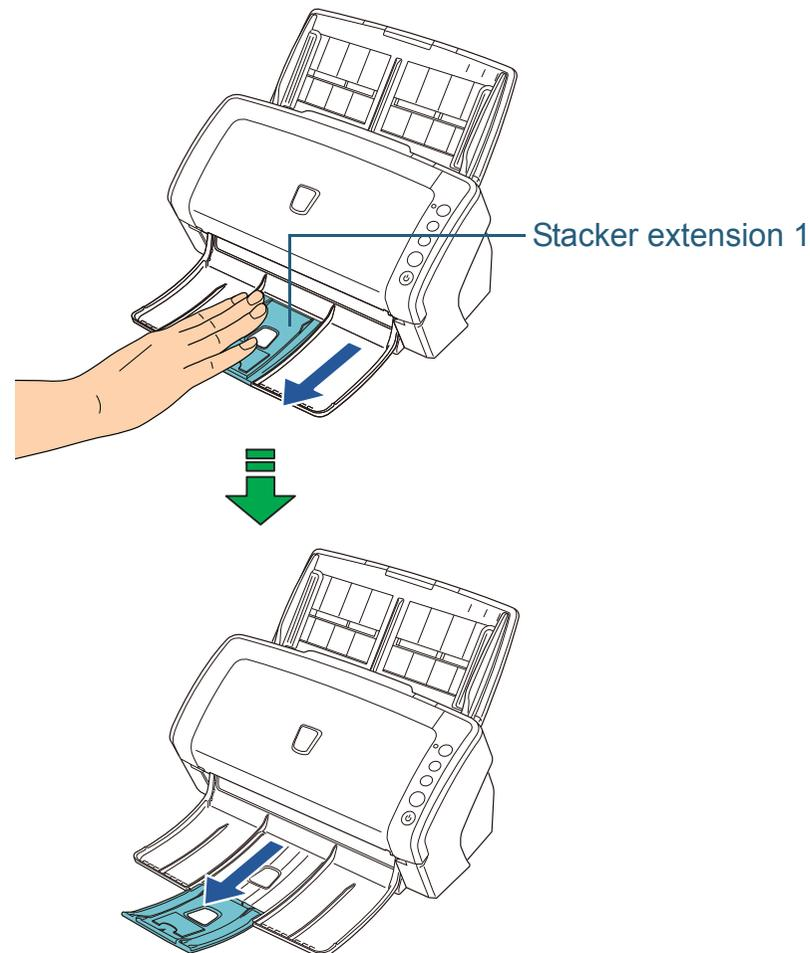

3 Lift up the stacker extension 2 towards you.

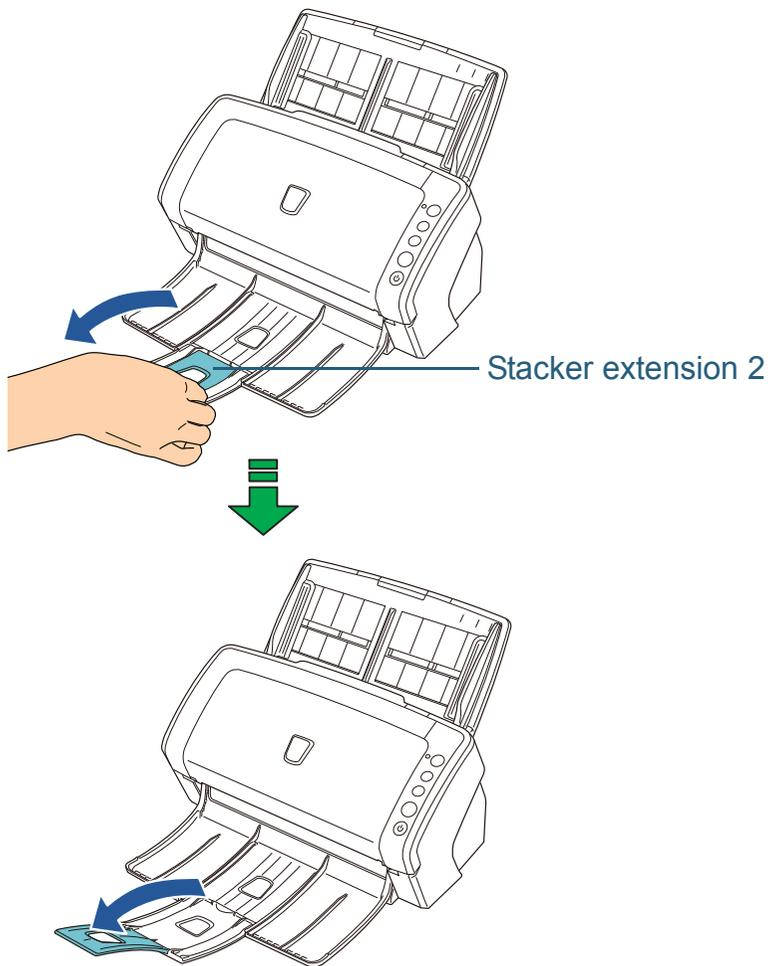

TOP

Contents

Index

Introduction

Scanner Overview

How to Load Documents

Configuring the Scan Settings

How to Use the Operator Panel

Various Ways to Scan

Daily Care

Replacing the Consumables

Troubleshooting

Operational Settings

Appendix

Glossary

■ A7 (landscape) or smaller

1 Bring down the stacker from the top towards you.

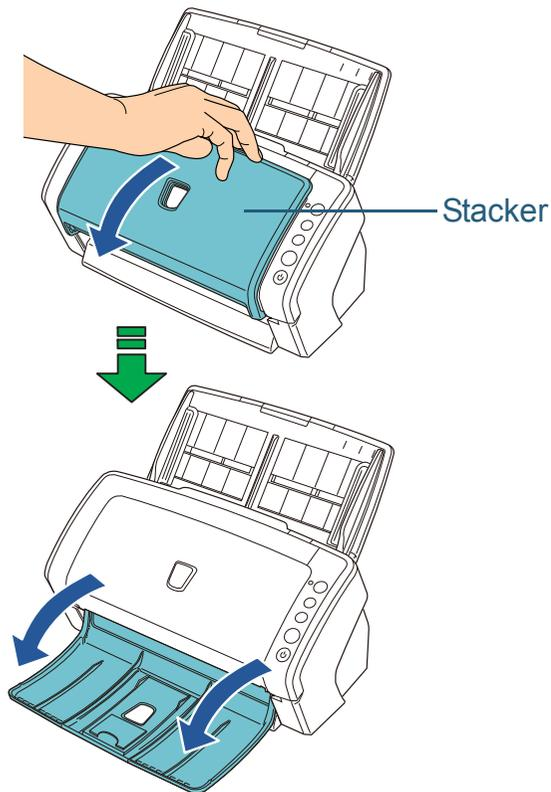

2 Lift up the stacker extension 3.

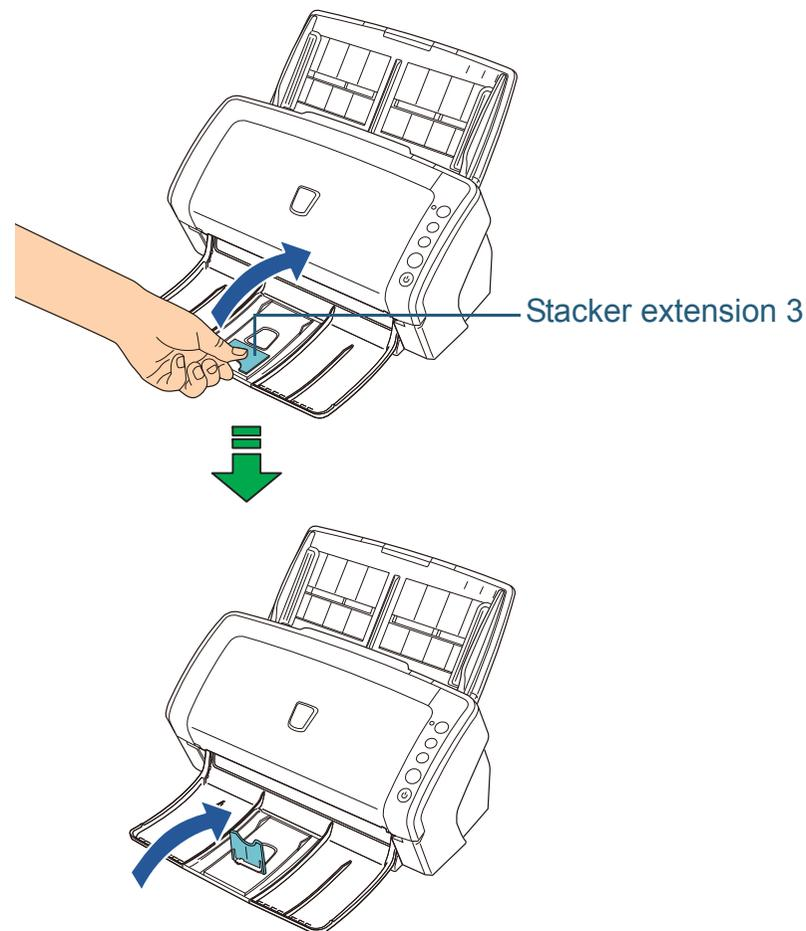

Do not bend the stacker extension more than 90 degrees, because it may break.

TOP

Contents

Index

Introduction

Scanner Overview

How to Load Documents

Configuring the Scan Settings

How to Use the Operator Panel

Various Ways to Scan

Daily Care

Replacing the Consumables

Troubleshooting

Operational Settings

Appendix

Glossary

fi-6230Z/fi-6240Z

■A5 (portrait) or larger

- 1 Lift up the stacker towards you.

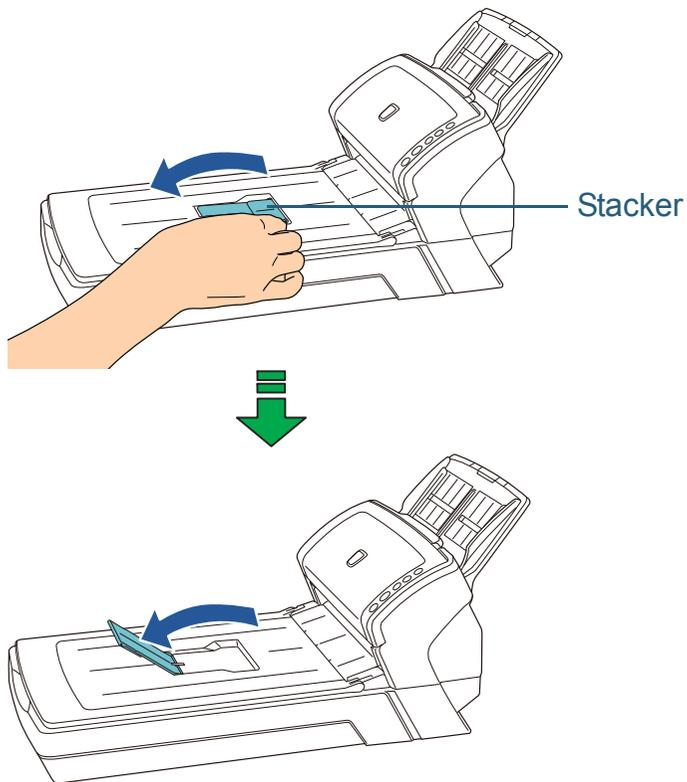

■A6 (portrait)/A5 (landscape) or smaller

- 1 Lift the stacker extension.

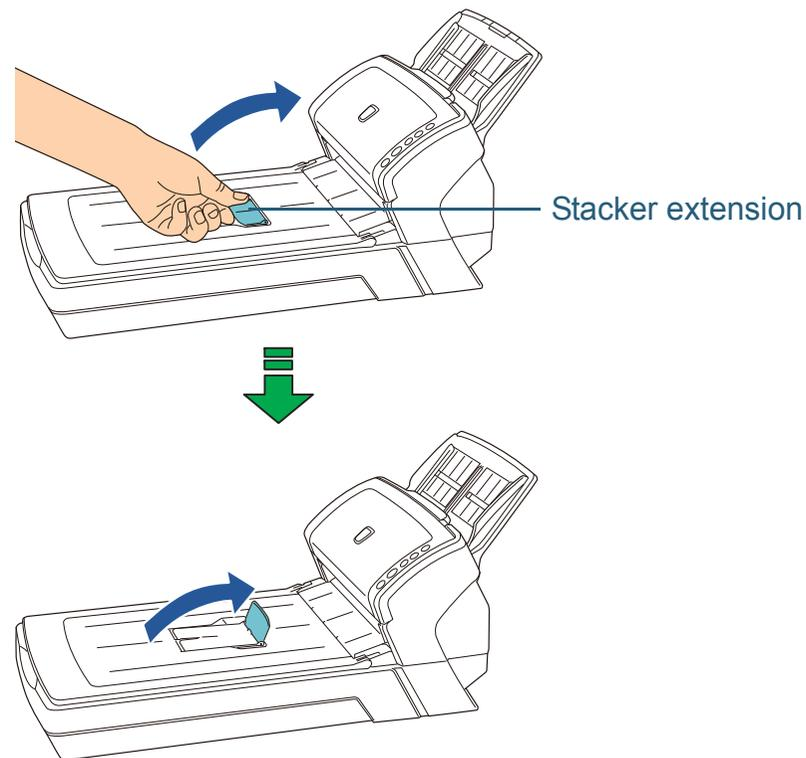

Do not bend the stacker extension more than 90 degrees, because it may break.

TOP

Contents

Index

Introduction

Scanner Overview

How to Load Documents

Configuring the Scan Settings

How to Use the Operator Panel

Various Ways to Scan

Daily Care

Replacing the Consumables

Troubleshooting

Operational Settings

Appendix

Glossary

1.8 Power Saving Mode

Power saving mode keeps the power consumption low when the scanner has not been used for a certain period of time.

If the scanner is left powered on for 15 minutes without being used, it automatically enters power saving mode.

When it enters power saving mode, the Function Number Display switches off but the [Power] button remains lit in green.

To resume from power saving mode, perform one of the following:

- Load a document in the ADF paper chute
- Press any button on the operator panel
Note that pressing the [Power] button for more than 2 seconds will turn the power off.
- Perform scanning from an application



The scanner may not enter power saving mode if there was a document remaining on the paper path.
For details about how to remove documents, refer to ["8.1 Paper Jam" \(page 125\)](#).



The waiting time for entering power saving mode can be changed in the Software Operation Panel.
For details, refer to ["Waiting Time to Enter Power Saving Mode \[Power saving\]" \(page 187\)](#).

TOP

Contents

Index

Introduction

Scanner
OverviewHow to Load
DocumentsConfiguring the
Scan SettingsHow to Use the
Operator PanelVarious Ways to
Scan

Daily Care

Replacing the
Consumables

Troubleshooting

Operational
Settings

Appendix

Glossary

1.9 Basic Flow of Scanning Operation

This section explains about the basic flow of performing a scan.

In order to perform a scan, you need a scanner driver and an application that supports the scanner driver.

This product bundles the TWAIN driver and the ISIS driver (compliant to the respective standards), Kofax VRS, and an application called "ScandAll PRO" which supports both drivers and Kofax VRS.



- For details about the scanner drivers, refer to:
 - ["Chapter 3 Configuring the Scan Settings" \(page 51\)](#)
 - TWAIN driver Help
 - ISIS driver Help
- For details about Kofax VRS, refer to:
 - Kofax VRS Help
- For details about ScandAll PRO, refer to:
 - ScandAll PRO V2.0 User's Guide
 - ScandAll PRO Help

The following describes the normal procedure for scanning.

- 1 Turn on the scanner.
For details, refer to ["1.3 Turning the Power ON/OFF" \(page 23\)](#).
- 2 Load a document face-down in the ADF paper chute.

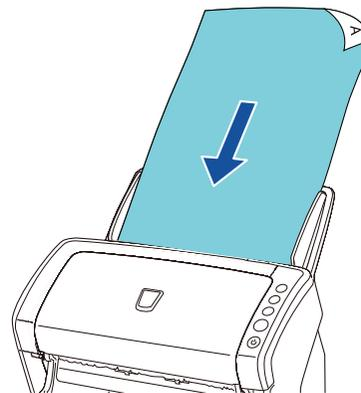

For details, refer to ["Chapter 2 How to Load Documents" \(page 37\)](#).

[TOP](#)[Contents](#)[Index](#)[Introduction](#)[Scanner Overview](#)[How to Load Documents](#)[Configuring the Scan Settings](#)[How to Use the Operator Panel](#)[Various Ways to Scan](#)[Daily Care](#)[Replacing the Consumables](#)[Troubleshooting](#)[Operational Settings](#)[Appendix](#)[Glossary](#)

- 3 Start an application for scanning. ScandAll PRO will be used here as an example to explain the procedure.



For details about how to start up ScandAll PRO, refer to "ScandAll PRO V2.0 User's Guide".

- 4 Select a scanner driver.

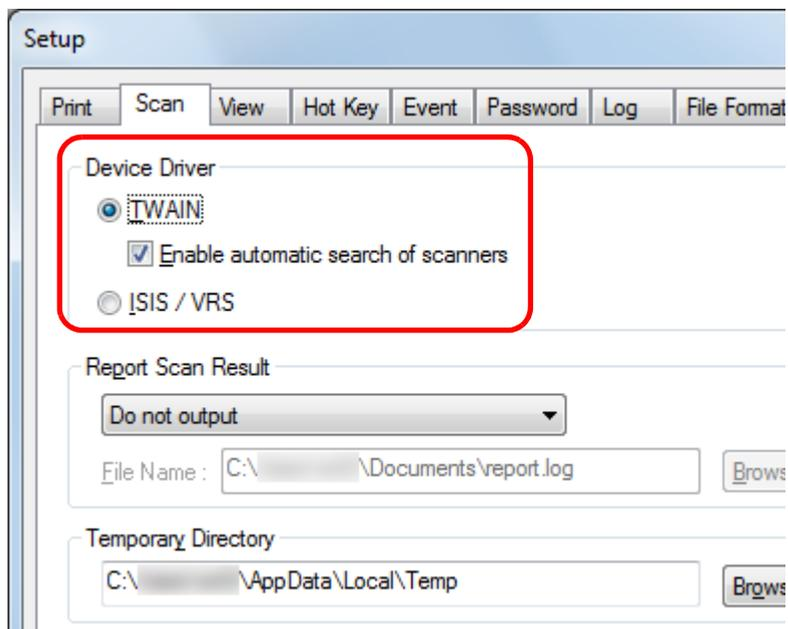

- 5 Select a scanner.

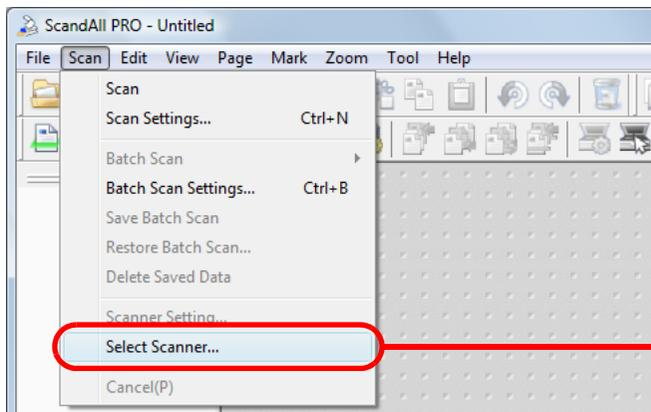

TWAIN driver:

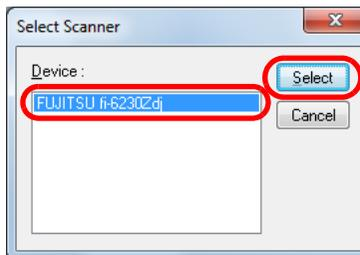

ISIS driver:

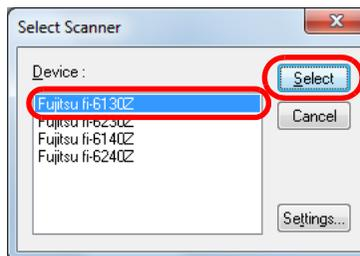

Kofax VRS:

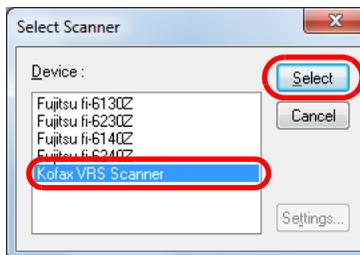

- TOP
- Contents
- Index
- Introduction
- Scanner Overview
- How to Load Documents
- Configuring the Scan Settings
- How to Use the Operator Panel
- Various Ways to Scan
- Daily Care
- Replacing the Consumables
- Troubleshooting
- Operational Settings
- Appendix
- Glossary

6 Launch the scanner driver from the application.

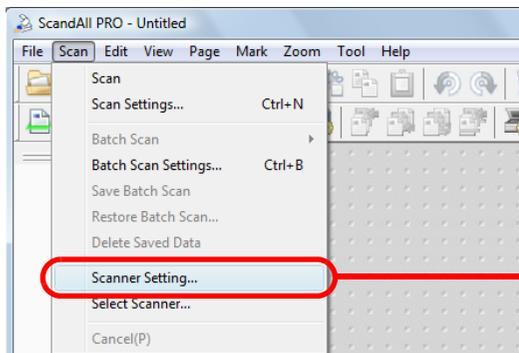

TWAIN driver:

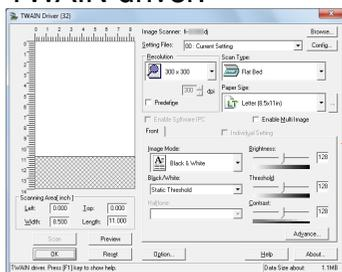

ISIS driver:

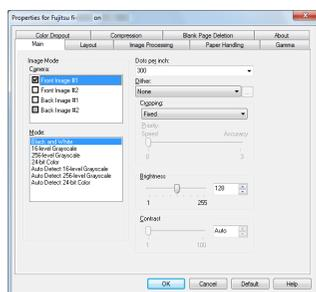

Kofax VRS:

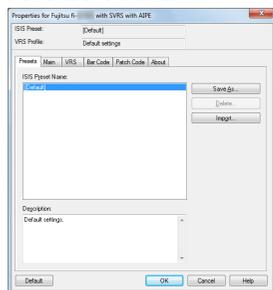

7 In the scanner driver's setup dialog box, configure the scan settings.

8 In ScandAll PRO, select the [Scan] menu → [Scan].

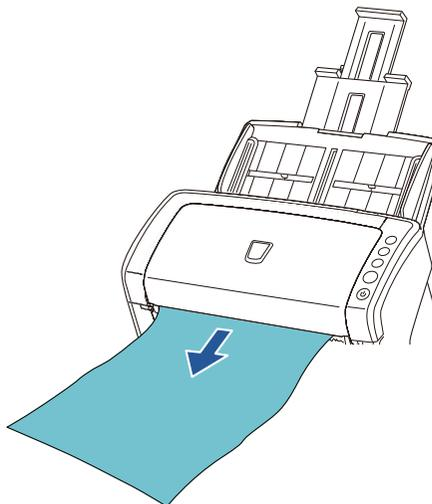

For details about scanning with ScandAll PRO, refer to "ScandAll PRO V2.0 User's Guide".

9 Save the scanned image to a file.

 Do not unplug the USB cable or log off the user account when the scanner and the computer are communicating, for instance, during scanning.

 Procedures and operations slightly vary depending on the application used. For more details about scanning with ScandAll PRO, refer to "ScandAll PRO V2.0 User's Guide". To perform scanning with other applications, refer to the manual bundled with the application.

1.10 Image Scanning Application

This section explains about the bundled “ScandAll PRO” image scanning application, which is used as an example to explain the procedures in this manual.

ScandAll PRO supports both TWAIN and ISIS drivers. By defining scan settings as profiles, you can customize the settings according to your preference.

When ScandAll PRO is installed, you can also install “ScanSnap mode”. This is an add-in application which provides a different set of driver settings as an alternative to using ScandAll PRO. TWAIN driver is required to use this application. Using the ScanSnap mode enables easy scanning with a single button.



You cannot use ScanSnap mode in the following cases:

- When the scanner is connected to fi-5000N
- When the scanner is connected with a SCSI cable

["Chapter 5 Various Ways to Scan" \(page 66\)](#) explains how to scan different types of documents by using examples of the TWAIN driver started via ScandAll PRO.

For more details about ScandAll PRO, refer to “ScandAll PRO V2.0 User’s Guide”.

[TOP](#)[Contents](#)[Index](#)[Introduction](#)[Scanner Overview](#)[How to Load Documents](#)[Configuring the Scan Settings](#)[How to Use the Operator Panel](#)[Various Ways to Scan](#)[Daily Care](#)[Replacing the Consumables](#)[Troubleshooting](#)[Operational Settings](#)[Appendix](#)[Glossary](#)

1.11 Centralized Management of Scanners

This section explains about managing a large number of scanners in a unified manner by providing the following capabilities.

- Simultaneously update settings for multiple scanners and their drivers.
Because there is no need to update each scanner one by one, a significant reduction is achieved in the time required to update a large number of scanners.
- Monitor scanners to check for any consumable parts that require replacement, or the occurrence of errors.
The alerts for consumable part replacement and errors are provided by scanners, which provides an easy way of checking the operating status of scanners.

To enable the above functions, "Scanner Central Admin" is required which consists of four applications bundled with this product:

- **Scanner Central Admin Server**
Install this application in the main computer that is used for the centralized management of scanners.
By registering scanners on the Scanner Central Admin Server, you can build a system to run a unified management for all scanners.
- **Scanner Central Admin Console**
Install this application in a computer to upload update modules and to monitor the operating status of the scanners.
The administrators can perform these tasks from the Scanner Central Admin Console window, where they can also check the alerts for consumable replacement and errors sent from the scanners.
- **Scanner Central Admin Agent**
Install this application in a computer connected to a scanner. It allows scanners to link with the Scanner Central Admin Server.
Linking with the Scanner Central Admin Server will enable you to apply updates on scanner settings, and the scanner can also send alerts on consumable replacement and errors.

- **SCAModule Creator**

Use this application to create update modules to upload onto the Scanner Central Admin Server.

It is only required for creating update modules.

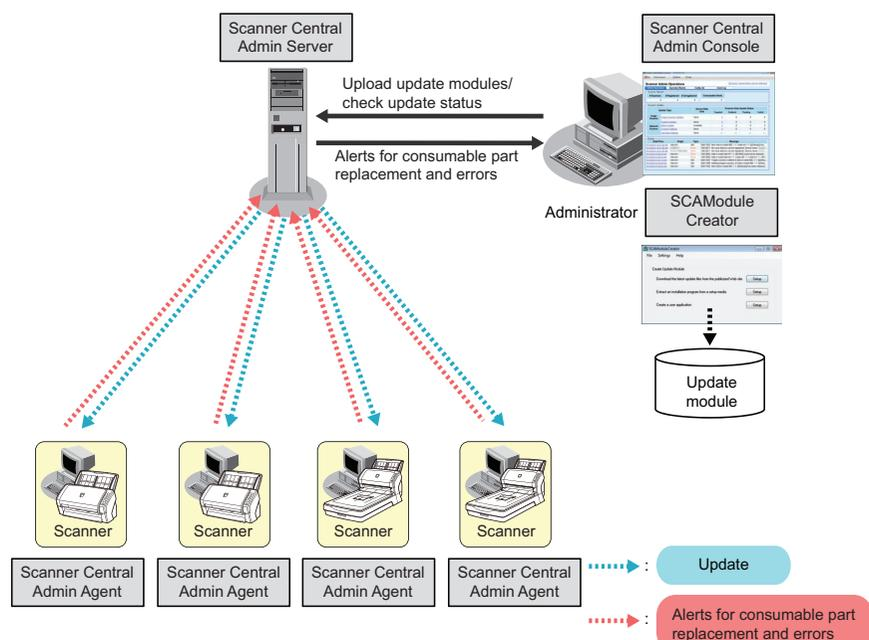

For more details, refer to the **Scanner Central Admin 4.0 User's Guide**.

Chapter 2 How to Load Documents

This chapter explains how to load documents on the scanner.

2.1 Loading Documents in the ADF.....	38
2.2 Loading Documents on the Flatbed (fi-6230Z/fi-6240Z).....	40
2.3 Documents for Scanning (ADF).....	41

2.1 Loading Documents in the ADF

This section explains how to load documents in the ADF.

Preparation



For details about the paper size and quality required for normal operations, refer to ["2.3 Documents for Scanning \(ADF\)" \(page 41\)](#).

1 If you are loading multiple sheets, check the documents.

- 1 Check if the documents to be loaded are of the same width or different widths.

Ways to load documents differ depending on whether they are the same width or not.

If the document width varies, refer to ["Conditions for Mixed Batch Scanning" \(page 47\)](#) or ["Documents with Different Widths" \(page 69\)](#).

- 2 Check the number of sheets.

Up to 50 sheets can be loaded (with paper weight of 80 g/m² [20 lb] and thickness of the document stack under 5 mm).

For details, refer to ["Loading Capacity" \(page 44\)](#).

2 Fan the documents.

- 1 Grab a stack of documents, which should be 5 mm or less.
- 2 Hold both ends of the documents and fan them a few times.

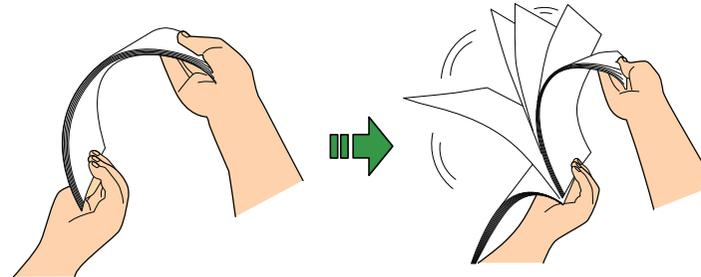

- 3 Rotate the documents by 90 degrees and fan them in the same manner.
- 4 Perform steps 1 to 3 for all documents.
- 5 Align the edges of the documents.



For more details about how to fan documents, refer to the Error Recovery Guide. The Error Recovery Guide is included in the Setup DVD-ROM. For details about installation, refer to "Installing the Software" in Getting Started.

How to Load Documents

- 1** Pull out the chute extensions according to the length of the document.
For details, refer to ["1.6 Setting Up the ADF Paper Chute"](#) (page 26).
- 2** Lift the stacker and stacker extension according to the length of the document.
For details, refer to ["1.7 Setting Up the Stacker"](#) (page 27).
- 3** Load the document face-down in the ADF paper chute.

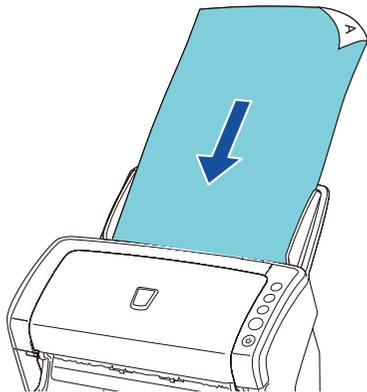

Remove all paper clips and staples. Reduce the number of sheets if a multifeed or pick error occurs.

- 4** Adjust the side guides to the width of the document.
Do not leave space between the side guides and the document.
Otherwise, the document may be fed skewed.

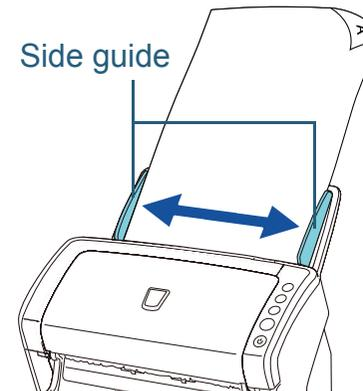

- 5** Start up an application for scanning and perform a scan.
For details about the scanning procedure in ScandAll PRO, refer to ["ScandAll PRO V2.0 User's Guide"](#).

2.2 Loading Documents on the Flatbed (fi-6230Z/fi-6240Z)

- 1** Open the document cover.
For details, refer to "1.5 Opening/Closing the Document Cover (fi-6230Z/fi-6240Z)" (page 25).
- 2** Load a document on the document bed.
Place the document face-down to align its top left-hand corner with the reference point.
- 3** Close the document cover.
For details, refer to "1.5 Opening/Closing the Document Cover (fi-6230Z/fi-6240Z)" (page 25).
- 4** Start up an application for scanning and perform a scan.
For details about the scanning procedure in ScandAll PRO, refer to "ScandAll PRO V2.0 User's Guide".

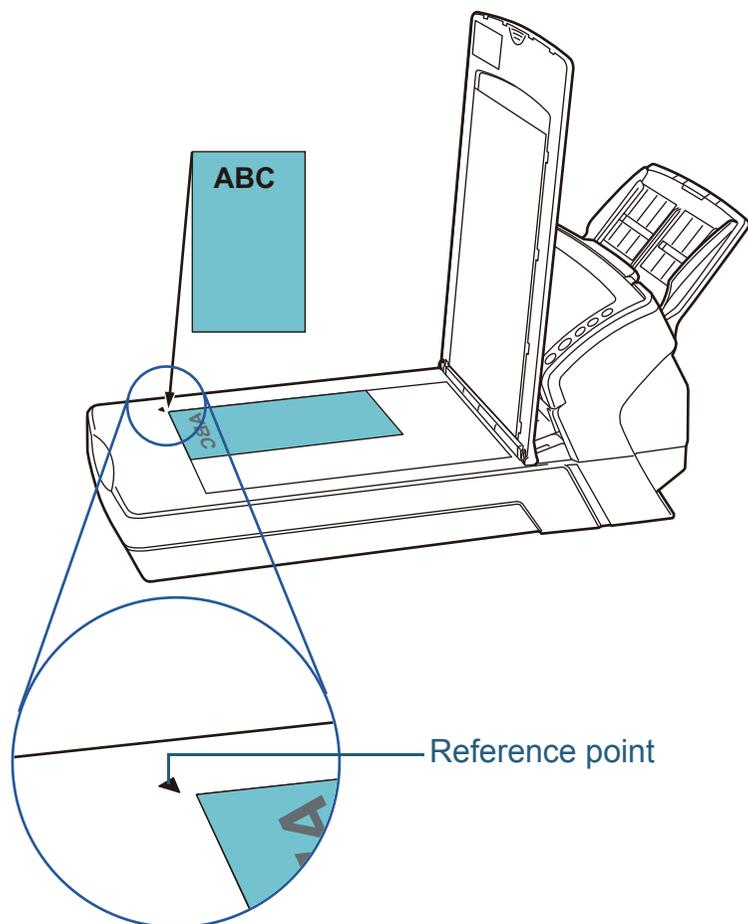

2.3 Documents for Scanning (ADF)

Paper Size

The following paper sizes can be scanned.

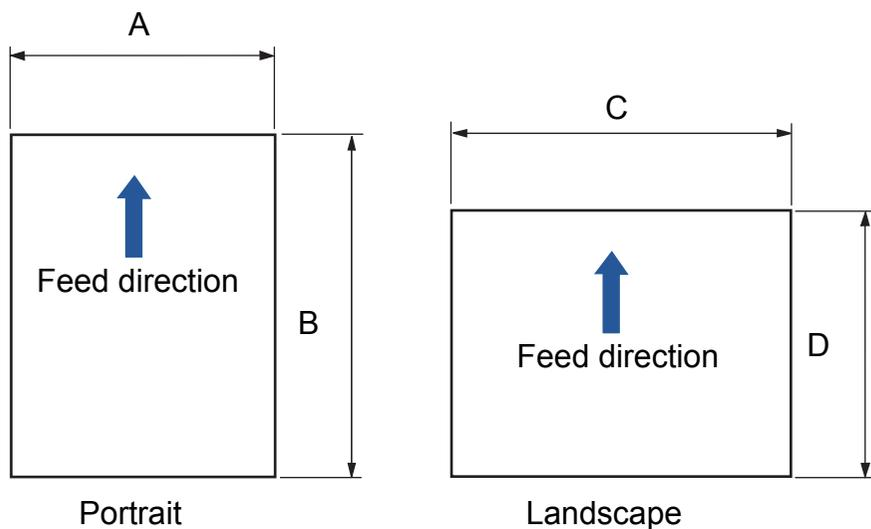

A: 52 to 216 mm (2.1 to 8.5 in.)

B: 74 to 355.6 mm (2.9 to 14.0 in.) (*1)

C: 74 to 216 mm (2.9 to 8.5 in.)

D: 52 to 355.6 mm (2.1 to 14.0 in.) (*1)

*1: Long page scanning supports documents with a length up to 3,048 mm (120 in.).

Conditions

Paper type

The following paper types are recommended:

- Wood-free paper
- Wood-containing paper
- PPC paper (recycled)
- Plastic card

When using paper types other than the above, make sure to test with the same type of paper first to check if the document can be scanned.

Paper weight (thickness)

The following paper weights can be used:

- 41 to 209 g/m² (11 to 56 lb)
- 127 to 209 g/m² (34 to 56 lb) for A8 size
- 1.4 mm or less for plastic cards (*1)

*1: Up to 1.25 mm is supported for scanning at 200 dpi (60 ppm) in landscape when using fi-6140Z/fi-6240Z. This setting can be changed in the Software Operation Panel to scan plastic cards with a thickness up to 1.4 mm. For details, refer to "[Scanning Thick Plastic Cards \[Feed Mode\] \(fi-6140Z/fi-6240Z\)](#)" (page 179).

Precautions

The following types of documents may not be scanned successfully:

- Documents of non-uniform thickness (e.g. envelopes, documents with attachments)
- Wrinkled or curled documents
- Folded or torn documents
- Tracing paper
- Coated paper
- Carbon paper
- Photosensitive paper
- Perforated documents
- Documents that are not square or rectangular
- Thin paper (less than 41 g/m²)
- Photographs (photographic paper)

The following types of documents must not be scanned:

- Paper-clipped or stapled documents
- Documents on which the ink is still wet
- Documents smaller than A8 size (portrait)
- Documents wider than 216 mm (8.5 in.)
- Documents other than paper/plastic card such as fabric, metal foil and OHP film
- Important documents such as certificates and cash vouchers which must not be damaged



- Since carbonless papers contain chemical substances that may harm the rollers (e.g. pick roller), take note of the following.

Cleaning : If paper jams occur frequently, clean the brake roller and pick roller.
For details about cleaning, refer to "[Chapter 6 Daily Care](#)" (page 108).

Consumable : The life of the brake roller and pick roller replacement may end sooner compared to scanning wood-containing papers.

- When scanning wood-containing papers, the life of the brake roller and pick roller may end sooner compared to scanning wood-free papers.
- Brake roller and pick roller may be damaged when a photo/sticky note on the document contacts these parts during scanning.
- The surface of the document may be damaged when scanning gloss papers such as photographs.

TOP

Contents

Index

Introduction

Scanner
Overview

How to Load
Documents

Configuring the
Scan Settings

How to Use the
Operator Panel

Various Ways to
Scan

Daily Care

Replacing the
Consumables

Troubleshooting

Operational
Settings

Appendix

Glossary



- When you scan plastic cards, take note of the following.
 - Up to three plastic cards can be loaded in the ADF paper chute. Note that you can only load one card at a time if the plastic card is embossed.

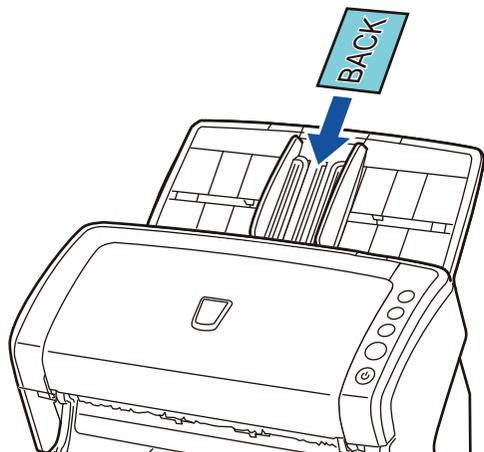

- It is recommended to place the card face-down in the ADF paper chute.
- Cards should be within the following specifications: ISO7810 ID-1 type compliant

Size	: 85.6 × 53.98 mm
Thickness	: 1.4 mm or less (*1)
Material	: PVC (polyvinyl chloride) or PVCA (polyvinyl chloride acetate)

Make sure to check if the card can be scanned first.

- *1: Up to 1.25 mm is supported for scanning at 200 dpi (60 ppm) in landscape when using fi-6140Z/fi-6240Z. This setting can be changed in the Software Operation Panel to scan plastic cards with a thickness up to 1.4 mm. For details, refer to "[Scanning Thick Plastic Cards \[Feed Mode\] \(fi-6140Z/fi-6240Z\)](#)" (page 179).
- Rigid cards may not be fed properly.
- If the surface of the card is dirty with grease marks (e.g. fingerprints) and such, perform scanning after wiping the dirt off.

- Plastic cards cannot be scanned when the imprinter is connected.
- Scanning thick documents such as plastic cards will be falsely detected as multifeed. In that case, disable multifeed detection.



- When scanning semi-transparent documents, increase the brightness for scanning to avoid bleed-through.
- When you scan documents written in lead pencil, make sure to clean the rollers frequently. Otherwise, the rollers will be contaminated which may leave black traces on the document or cause feeding errors. For details about cleaning, refer to "[Chapter 6 Daily Care](#)" (page 108).
- If multifeeds, pick errors or paper jams occur frequently, refer to "[8.3 Troubleshooting](#)" (page 130).
- When you scan documents with the ADF, all documents must be flat on the leading edge. Make sure that curls on the leading edge of the documents are kept within the following range.

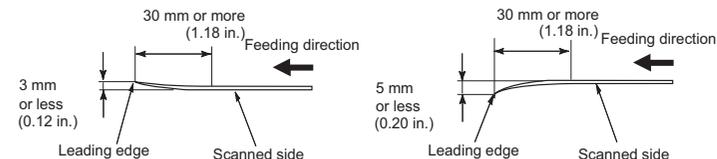

Loading Capacity

The number of sheets that can be loaded in the ADF paper chute is determined by the paper size and paper weight.

See the graph below.

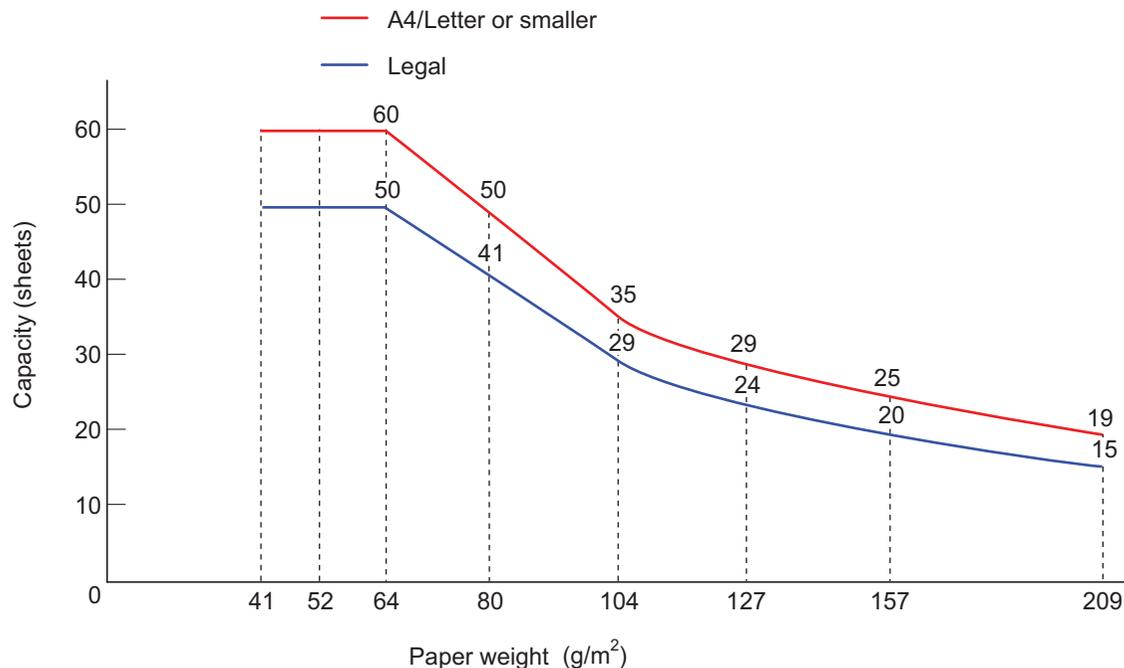

Unit	Conversion									
g/m²	41	52	64	75	80	90	104	127	157	209
lb	11	14	17	20	21	24	28	34	42	56
kg	35	45	55	64.5	69	77.5	90	110	135	180

Area Not to be Perforated

An error may occur when there are punched holes in the shaded area in the following figure. Such documents can be scanned by using the flatbed (fi-6230Z/fi-6240Z).

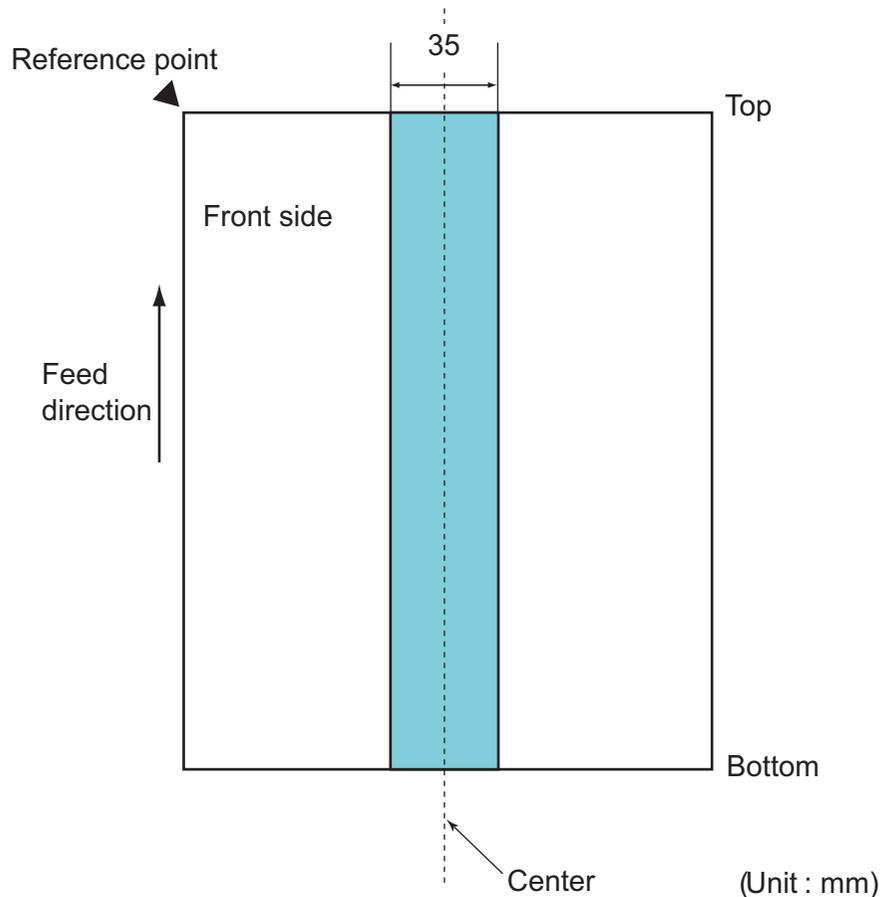

The above condition applies when the document is set to the center of the pick roller width.



If there are any holes in the 35 mm-wide central column, you can move the document to the left or right to avoid an error.

Conditions for Multifeed Detection

Multifeed is an error where two or more sheets are fed through the ADF at once. It is also called a multifeed when a different document length is detected.

Multifeed detection is performed by either checking the overlapping of documents, length of the documents, or the combination of both. The following conditions are required for an accurate detection.

Detection by overlapping

- Load documents of the same paper weight in the ADF paper chute.
- Paper weight: 41 to 209 g/m² (11 to 56 lb)
- Do not punch holes within 35 mm (1.38 in.) over the center of the document. See Fig.1.
- Do not attach other documents within 35 mm (1.38 in.) over the center of the document. See Fig.1.

Detection by length

- Load documents of the same length in the ADF paper chute.
- Variance in document lengths: 1% or less
- Do not punch holes within 35 mm (1.38 in.) over the center of the document. See Fig.1.

Detection by overlapping and length

- Load documents of the same paper weight and length in the ADF paper chute.
- Paper weight: 41 to 209 g/m² (11 to 56 lb)
- Variance in document lengths: 1% or less
- Do not punch holes within 35 mm (1.38 in.) over the center of the document. See Fig.1.
- Do not attach other documents within 35 mm (1.38 in.) over the center of the document. See Fig.1.

TOP

Contents

Index

Introduction

Scanner
OverviewHow to Load
DocumentsConfiguring the
Scan SettingsHow to Use the
Operator PanelVarious Ways to
Scan

Daily Care

Replacing the
Consumables

Troubleshooting

Operational
Settings

Appendix

Glossary

Fig. 1

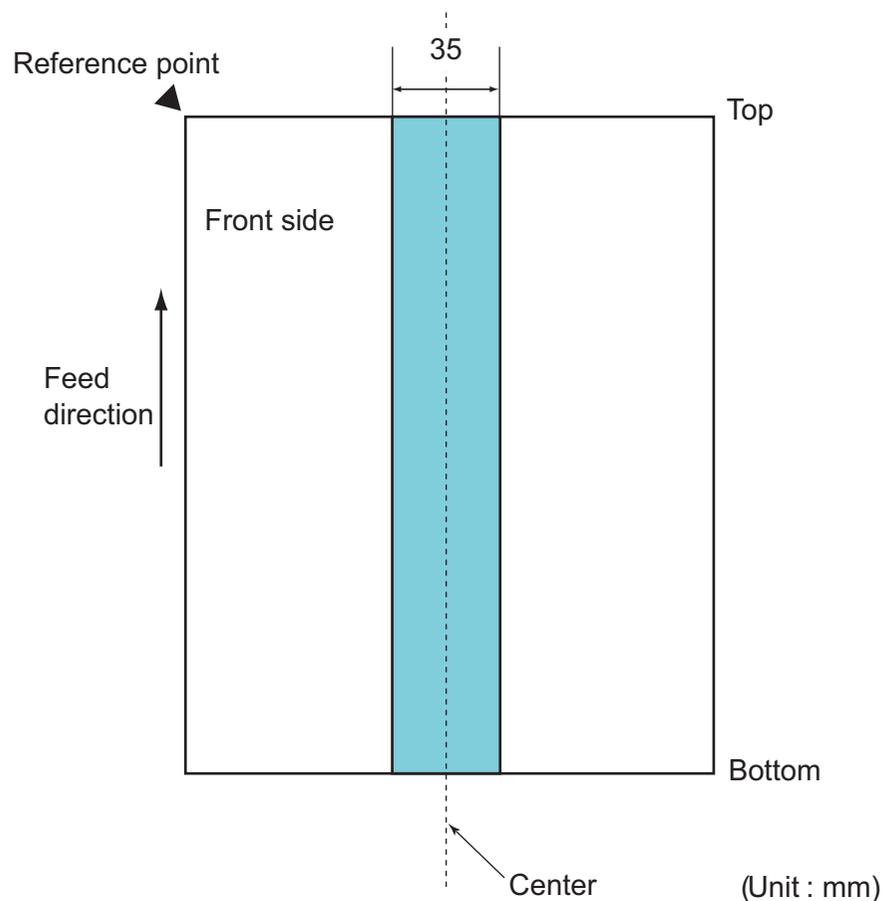

 Accuracy of multifeed detection may drop with some documents. Multifeed cannot be detected for the top 30 mm of a document.

● For the shaded area in Fig. 1, you can also specify a length not to detect multifeeds in the Software Operation Panel. For details, refer to ["9.6 Settings Related to Multifeed Detection"](#) (page 180).

 The above condition applies when the document is set to the center of the pick roller width.

● When you use detection by overlapping, scanning thick documents such as plastic cards will be falsely detected as multifeed. In that case, disable multifeed detection.

- TOP
- Contents
- Index
- Introduction
- Scanner Overview
- How to Load Documents
- Configuring the Scan Settings
- How to Use the Operator Panel
- Various Ways to Scan
- Daily Care
- Replacing the Consumables
- Troubleshooting
- Operational Settings
- Appendix
- Glossary

Conditions for Mixed Batch Scanning

The following conditions apply when scanning a mixed batch of documents with different paper weights/friction coefficients/sizes. Make sure to test a few sheets first to check if the documents can be scanned.

For details about scanning, refer to ["Documents with Different Widths" \(page 69\)](#).

Paper direction

Align the direction of the paper fiber with the feed direction.

Paper weight

The following paper weights can be used:
41 to 209 g/m² (11 to 56 lb)

Friction coefficient

It is recommended to use the same type of paper from the same manufacturer.

When papers of different manufacturers/brands are mixed, it affects the feeding performance as the difference in the friction coefficient increases.

The following friction coefficients are recommended:
0.35 to 0.60 (reference value for paper friction coefficient)

Document position

Use paper sizes that fit the 39 mm width of the pick roller in the center.

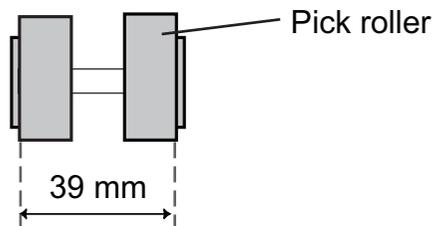

Paper size

When you scan a mixed batch with different sizes, not feeding the documents straight may cause paper jams or part of the image to appear missing.

It is recommended to check the documents thoroughly before scanning and also check the image if the document was skewed.



- When scanning a mixed batch with different sizes, documents are more likely to skew because the side guides do not contact every sheet.
- Do not use [Check Length] or [Check Overlapping and Length] for multifeed detection.

Documents that cannot be scanned in a mixed batch

The following types of documents cannot be mixed in the same batch:

- Carbonless paper
- Bond paper
- Perforated documents
- Thermal paper
- Carbon-backed paper
- OHP film
- Tracing paper

Combinations of standard paper sizes in a mixed batch

Refer to the table below for a guideline of the range available for mixed batch scanning.

However, note that not feeding the documents straight may cause paper jams or part of the image to appear missing.

It is recommended to check the documents thoroughly before scanning and also check the image if the document was skewed.

Maximum size		LTR (P) Carrier Sheet	A4 (P) A5 (L)	B5 (P) B6 (L)	A5 (P) A6 (L)	B6 (P) B7 (L)	A6 (P) A7 (L)	B7 (P) B8 (L)	A7 (P) A8 (L)	B8 (P)	A8 (P)
Width (mm) (*1)		216	210	182	149	129	105	91	74.3	64.3	52.5
Minimum size	LTR (P) Carrier Sheet	216									
	A4 (P) A5 (L)	210									
	B5 (P) B6 (L)	182	Available range								
	A5 (P) A6 (L)	149									
	B6 (P) B7 (L)	129									
	A6 (P) A7 (L)	105									
	B7 (P) B8 (L)	91									
	A7 (P) A8 (L)	74.3									
	B8 (P)	64.3									
	A8 (P)	52.5									

LTR: Letter size
(P) : Portrait
(L) : Landscape

TOP

Contents

Index

Introduction

Scanner
OverviewHow to Load
DocumentsConfiguring the
Scan SettingsHow to Use the
Operator PanelVarious Ways to
Scan

Daily Care

Replacing the
Consumables

Troubleshooting

Operational
Settings

Appendix

Glossary

*1: The following picture shows how to set the widest and the narrowest documents of the batch between the side guides.

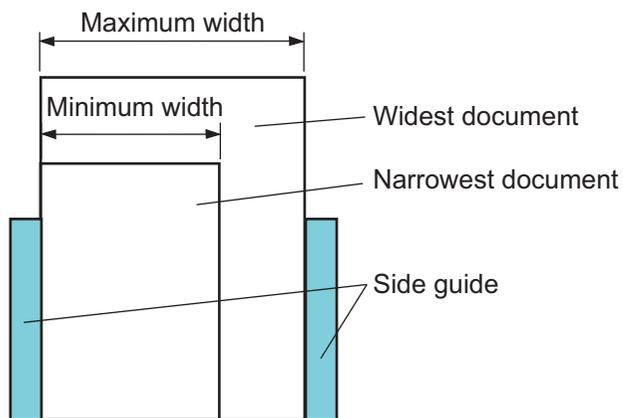

 B8 (portrait) and A8 (portrait) cannot be scanned with other paper sizes.

Conditions for Automatic Page Size Detection

[Automatic Page Size Detection] does not work with the following types of documents:

- Non-rectangular documents
- Documents with black background/edges

[Automatic Page Size Detection] may not work with the following types of documents:

- Thin paper (52 g/m² [14 lb] or less)
- Documents with dark background/edges

- TOP
- Contents
- Index
- Introduction
- Scanner Overview
- How to Load Documents
- Configuring the Scan Settings
- How to Use the Operator Panel
- Various Ways to Scan
- Daily Care
- Replacing the Consumables
- Troubleshooting
- Operational Settings
- Appendix
- Glossary

Conditions for Using the Carrier Sheet

Paper size

The following paper sizes can be scanned:

- Carrier Sheet (216 × 297 mm)
- A3 (297 × 420 mm)(*1)
- A4 (210 × 297 mm)
- A5 (148 × 210 mm)
- A6 (105 × 148 mm)
- B4 (257 × 364 mm)(*1)
- B5 (182 × 257mm)
- B6 (128 × 182 mm)
- Post card (100 × 148 mm)
- Business card (91 × 55 mm, 55 × 91 mm)
- Letter (8.5 × 11 in./216 × 279.4 mm)
- Double Letter (11 × 17 in./279.4 × 431.8 mm)(*1)
- Custom size
 - Width : 25.4 to 216 mm (1 to 8.5 in.)
 - Length : 25.4 to 297 mm (1 to 11.69 in.)

*1: Fold in half for scanning.

Conditions

Paper type

The following paper type is recommended:

- Standard office paper

Paper weight

The following paper weights can be used:

- Up to 127 g/m² (34 lb)
- Up to 63.5 g/m² (17 lb) when folded in half

Precautions

Take note of the following:

- Up to three Carrier Sheets can be loaded at once.
- Depending on the amount of memory used by running applications, there may be insufficient memory to scan a double-page spread document with the Carrier Sheet in high resolution. In that case, specify a lower resolution and try scanning again.
- Do not write on, color, stain, or cut the end with a black and white pattern on the Carrier Sheet.
- Do not place the Carrier Sheet upside down. Otherwise, a paper jam may occur and damage the Carrier Sheet and the document inside.
- Do not leave your document inside the Carrier Sheet for a long time. Otherwise, the ink on the document may be transferred onto the Carrier Sheet.
- To avoid deformation, do not use or leave the Carrier Sheet in high temperature places such as under direct sunlight or near a heating apparatus for a long time.
- Do not fold or pull the Carrier Sheet.
- Do not use a damaged Carrier Sheet because it may damage or cause the scanner to malfunction.
- To avoid deformation, keep the Carrier Sheet on a flat surface without any weight on it.
- Be careful not to cut your finger on the edge of the Carrier Sheet.
- If paper jams occur frequently, feed about 50 sheets of PPC paper (recycled paper) before scanning with the Carrier Sheet. The PPC paper can either be blank or printed.
- Paper jams may occur when you place several small documents (e.g. photos, postcards) in the Carrier Sheet for scanning. It is recommended to place only one document at a time in the Carrier Sheet.

TOP

Contents

Index

Introduction

Scanner
OverviewHow to Load
DocumentsConfiguring the
Scan SettingsHow to Use the
Operator PanelVarious Ways to
Scan

Daily Care

Replacing the
Consumables

Troubleshooting

Operational
Settings

Appendix

Glossary

Chapter 3 Configuring the Scan Settings

This chapter explains about the scan parameters of the scanner drivers.

3.1 TWAIN Driver.....	52
3.2 ISIS Driver	56

3.1 TWAIN Driver

The TWAIN driver is a driver that conforms to the TWAIN standard. It can be used with an application that supports TWAIN to perform scanning.

Normally, the scanner driver is launched via an application, and then the scan settings are configured in the setup dialog box of the driver (some applications may not display the setup dialog box).



Ways to launch the scanner driver differ depending on the application. For more details, refer to the manual or the Help files of the application.

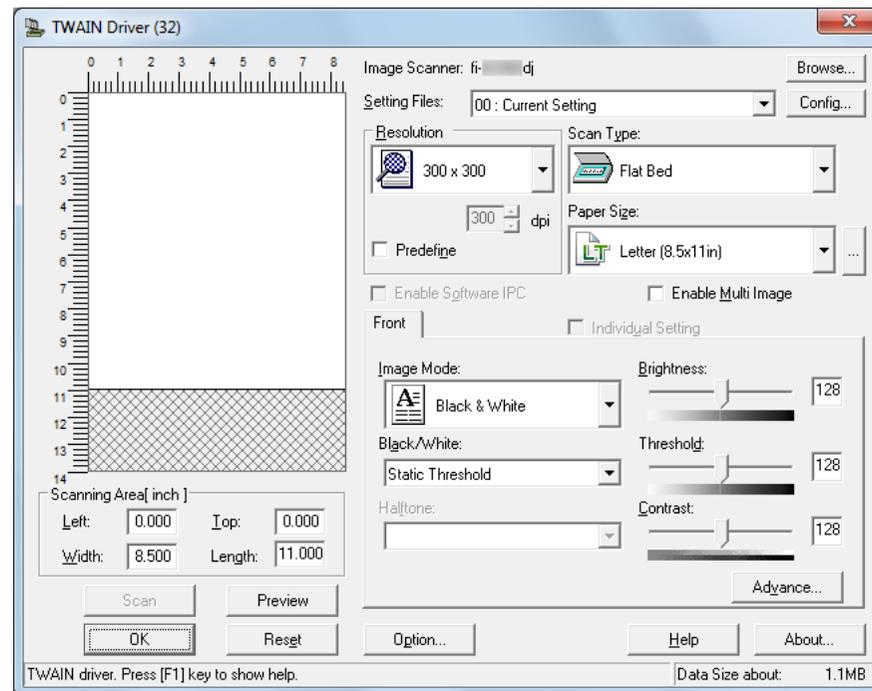

Settings for TWAIN driver are configured in the above dialog box.

The following are descriptions of the main configuration items. For details, refer to the TWAIN driver Help.

[Resolution]

Specify the resolution for scanning.

You can either select a predefined value from the list, or specify a custom resolution which can range between 50 dpi and 600 dpi (in increments of 1 dpi).

Also, selecting the [Predefine] check box allows you to perform scanning easily by selecting a predefined resolution from [Best], [Better] and [Normal].

Values in [Predefine] can be changed by clicking the [...] button.

[Scan Type]

Specify the scanning side(s) from the following:

- ADF Front Side
- ADF Duplex
- Long Page (Front side)
- Long Page (Duplex)
- Flatbed (fi-6230Z/fi-6240Z)
- ADF Back Side
- Double-page spread
- Clipping (Front)
- Clipping (Duplex)

[Paper Size]

Select a paper size from the drop-down list.

Up to three custom sizes can be added to the list by using the [...] button.

You can also change the order in which the items (sizes) are listed.

[Image Mode]

Specify the type of scanned image.

Item	Description
Black & White	Scans in binary (black & white) mode.
Halftone	Scans via halftone processing in binary (black & white) mode.
Grayscale	Scans in gradations from black to white. Select [Grayscale] (256) or [4bit Grayscale] (16 grayscale).
Color	Scans in color mode. Select [24bit Color], [256 Color] or [8 Color].

[Scan] Button

Click this button to start scanning by the current settings.

[Preview] Button

Allows you to preview the scanned image. Perform a test scan by the current settings and display the result in the preview window.

[Close] / [OK] Button

Click this button to save the current settings and close the window.

[Reset] Button

Click this button to undo the changes made.

[Help] Button

Displays the TWAIN driver Help which can also be displayed by the [F1] key.

[About] Button

Displays the version information of TWAIN driver.

[Option] Button

Configure the optional settings in the following window.

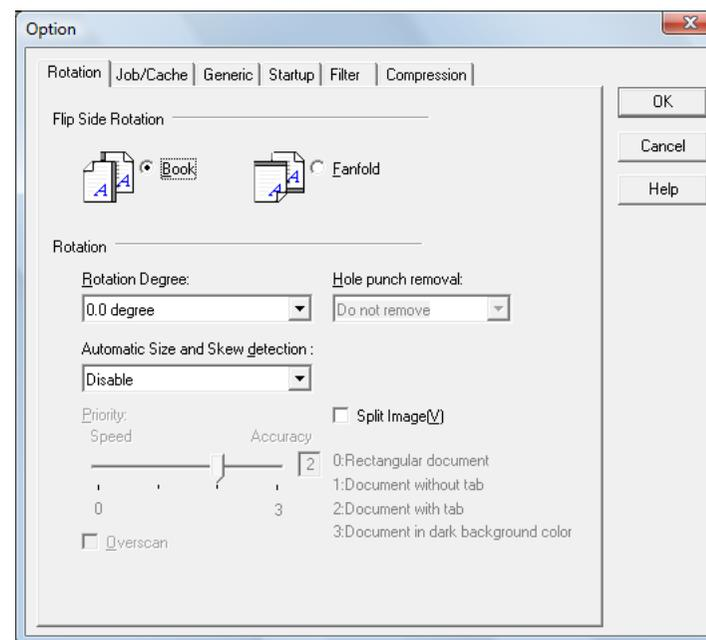

- [Rotation] Tab
Includes the binding direction of double-sided documents, image rotation, deskew, page size detection, end of page detection, overscan, hole punch removal, and image split.
- [Job/Cache] Tab
Includes caching, multifeed detection, and blank page skip.
- [Imprinter (Endorser)] Tab
Includes print settings for the imprinter which is available separately. Displayed only when the imprinter is installed.
- [Generic] Tab
Specify the measurement unit to display in the [TWAIN Driver (32)] dialog box.
Select from inch, mm, and pixel.
- [Startup] Tab
Includes settings related to the operator panel on the scanner.

- [Filter] Tab

Select the filter for image processing.

Item	Description
Digital Endorser	Adds alphanumeric character strings on the scanned image data.
Page Edge Filler	Fills in the margins of the scanned image in a specified color.

- [Compression] Tab

Specify the compression rate for JPEG transfer.

[Advance] Button

Click this button to configure detailed settings related to image processing.

Items such as gamma pattern, dropout color, reverse and edge extract can be configured.

[Config] Button

Click this button to manage the setup files.

Scan settings can be changed easily if you save the settings configured in the [TWAIN Driver (32)] dialog box onto a file under [Setting Files].

[Browse] Button

Click this button to view a list of connected scanners.

3.2 ISIS Driver

The ISIS driver is a driver that conforms to the ISIS standard. It can be used with an application that supports ISIS to perform scanning.

Normally, the scanner driver is launched via an application, and then the scan settings are configured in the setup dialog box of the driver (some applications may not display the setup dialog box).



Ways to launch the scanner driver differ depending on the application. For more details, refer to the manual or the Help files of the application.

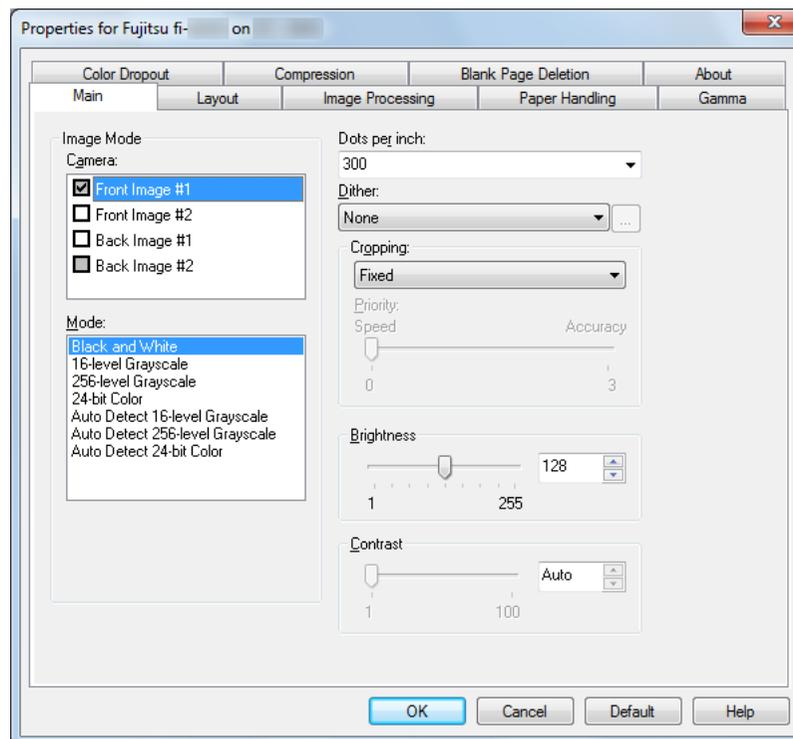

Settings for ISIS driver are configured in the above dialog box. For details, refer to the ISIS driver Help.

TOP

Contents

Index

Introduction

Scanner
OverviewHow to Load
DocumentsConfiguring the
Scan SettingsHow to Use the
Operator PanelVarious Ways to
Scan

Daily Care

Replacing the
Consumables

Troubleshooting

Operational
Settings

Appendix

Glossary

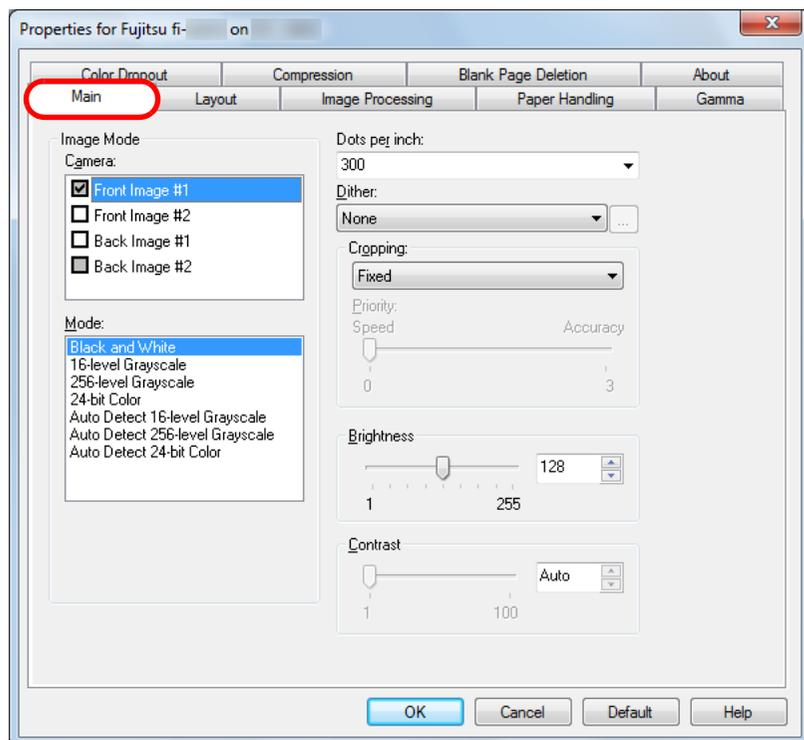
[Main] Tab

Includes settings such as the scanning side(s), color mode (color/grayscale/black & white), resolution, brightness and contrast.

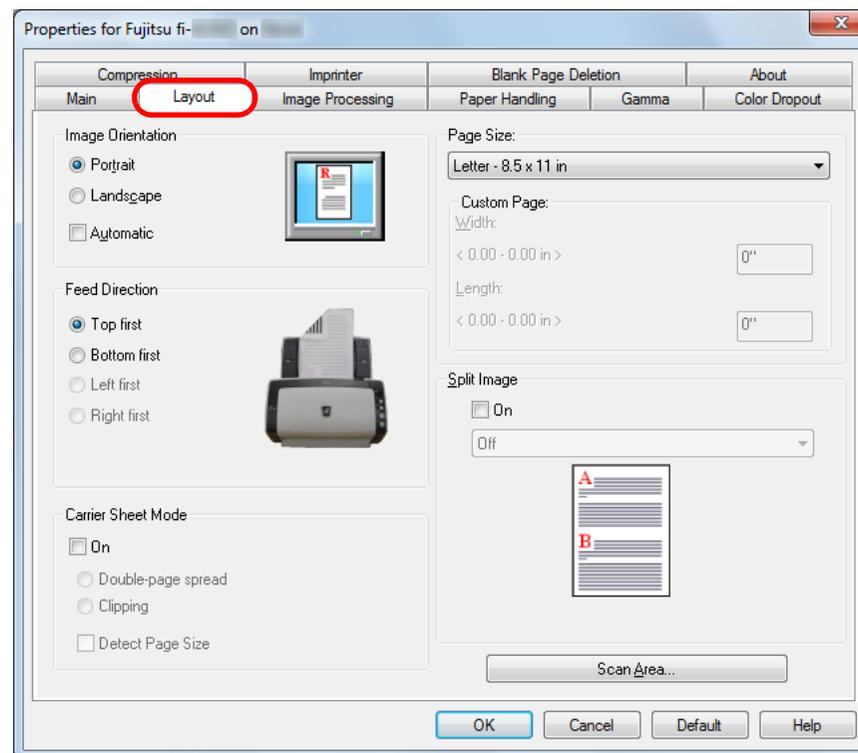
[Layout] Tab

Includes settings such as the page orientation, feeding direction, Carrier Sheet mode, paper size and image split. Clicking the [Scan Area] button displays the [Scan Area] dialog box.



Note that [Automatic] in [Image Orientation] is available only when ScandAll PRO is installed.

TOP

Contents

Index

Introduction

Scanner
OverviewHow to Load
DocumentsConfiguring the
Scan SettingsHow to Use the
Operator PanelVarious Ways to
Scan

Daily Care

Replacing the
Consumables

Troubleshooting

Operational
Settings

Appendix

Glossary

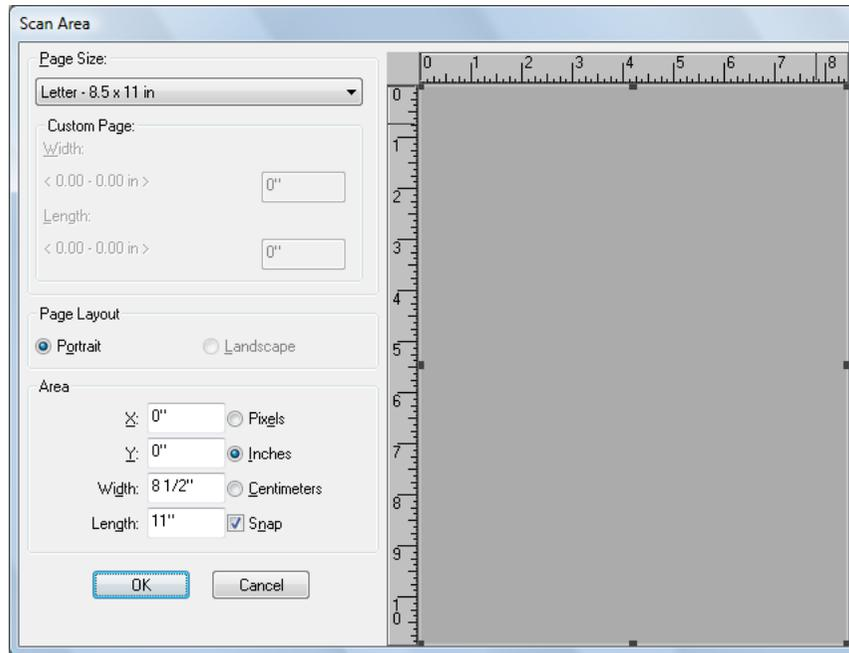
[Scan Area] Dialog Box

The scanning area for the specified paper size can be selected.

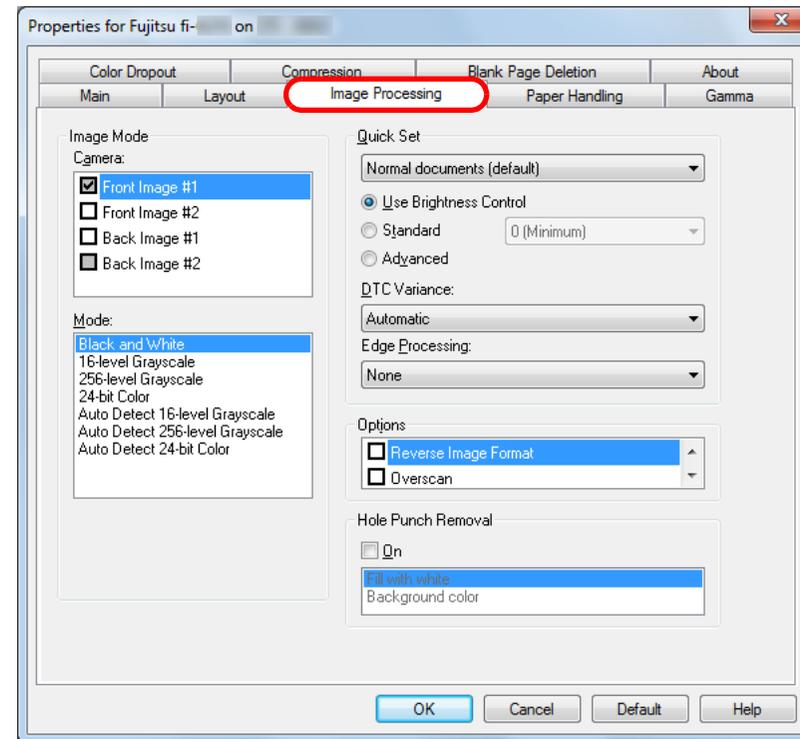
[Image Processing] Tab

You can select a configuration pattern that is used frequently for scanning. This tab also includes a setting for hole punch removal.

TOP

Contents

Index

Introduction

Scanner
OverviewHow to Load
DocumentsConfiguring the
Scan SettingsHow to Use the
Operator PanelVarious Ways to
Scan

Daily Care

Replacing the
Consumables

Troubleshooting

Operational
Settings

Appendix

Glossary

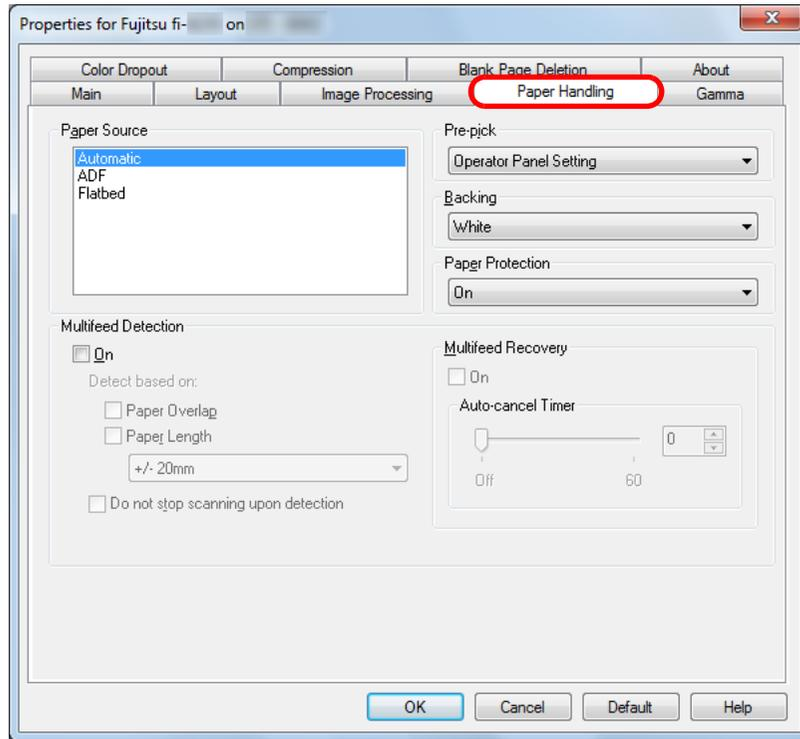
[Paper Handling] Tab

Includes settings related to document feeding.

Select a method from the following:

- Automatic (fi-6230Z/fi-6240Z)
- ADF
- Flatbed (fi-6230Z/fi-6240Z)

This tab also includes settings such as pre-pick (i.e. feeding the document to the starting position before scanning), paper protection and multifeed detection.

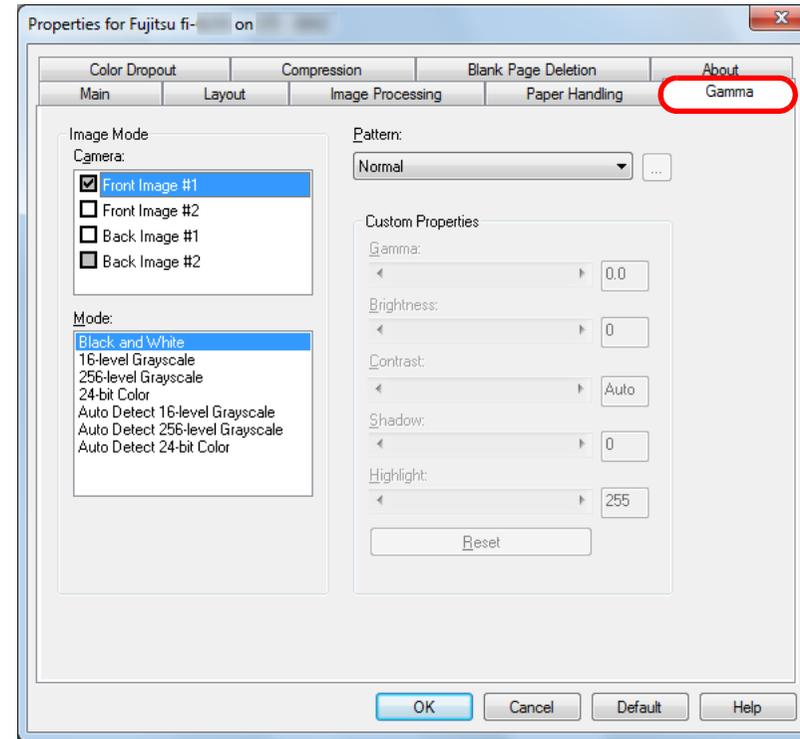
[Gamma] Tab

Includes settings related to gamma pattern. You can also customize detail settings such as the gamma value and brightness.

TOP

Contents

Index

Introduction

Scanner
OverviewHow to Load
DocumentsConfiguring the
Scan SettingsHow to Use the
Operator PanelVarious Ways to
Scan

Daily Care

Replacing the
Consumables

Troubleshooting

Operational
Settings

Appendix

Glossary

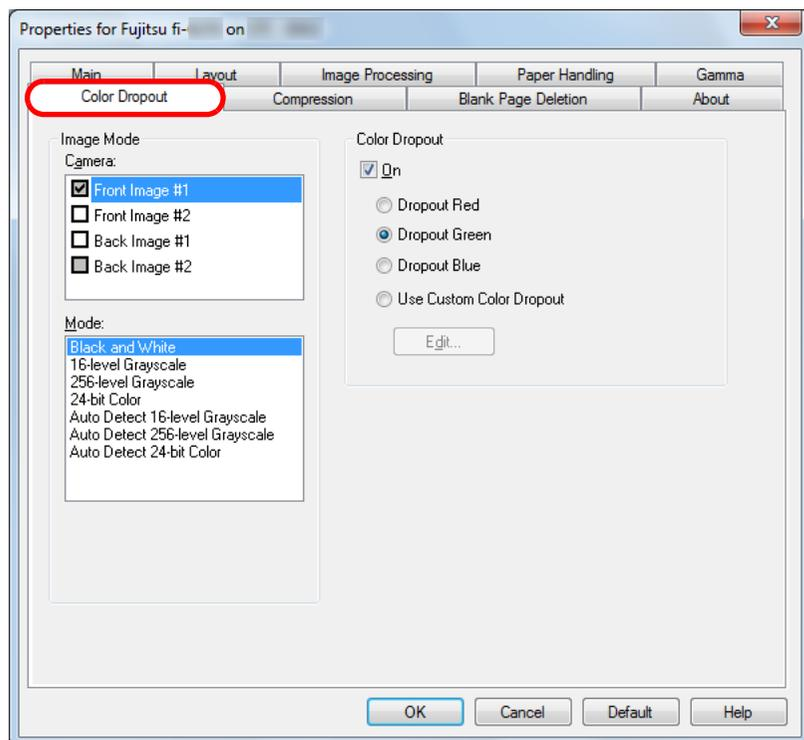
[Color Dropout] Tab

Select a color to remove from the scanned image.

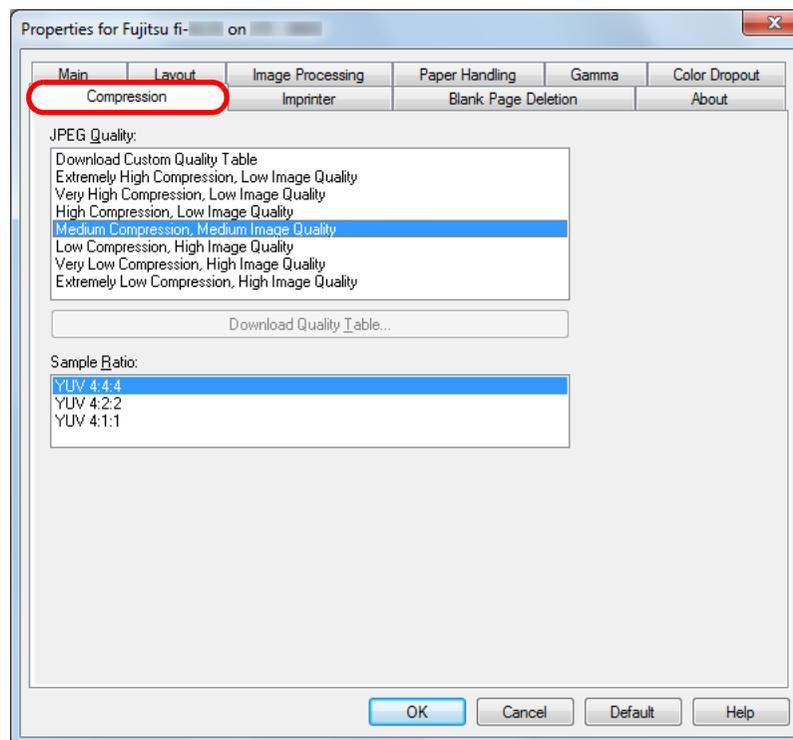
[Compression] Tab

Select a compression rate and the image quality for scanning in color/grayscale.

You can also configure a sample ratio used for compression.

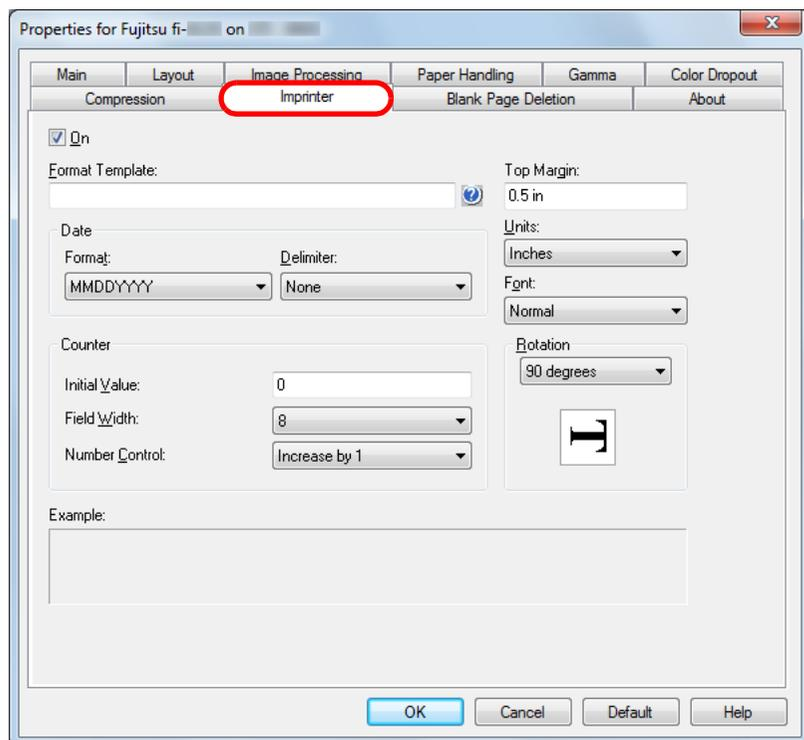
[Imprinter] Tab

Includes print settings for the imprinter which is available separately.

Displayed only when the imprinter is installed.

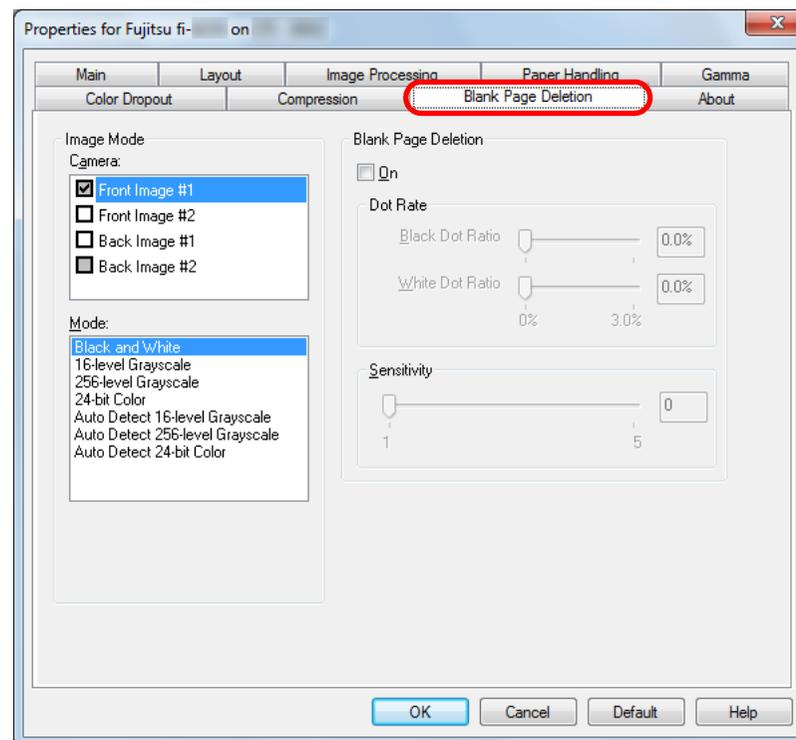
[Blank Page Deletion] Tab

Includes settings for deleting blank pages.

When scanning in black & white, you can use the dot ratio to process the blank page(s) for white and black backgrounds separately.

When scanning in grayscale/color, you can use the sensitivity to process the blank page(s) for white and black backgrounds together.

[About] Tab

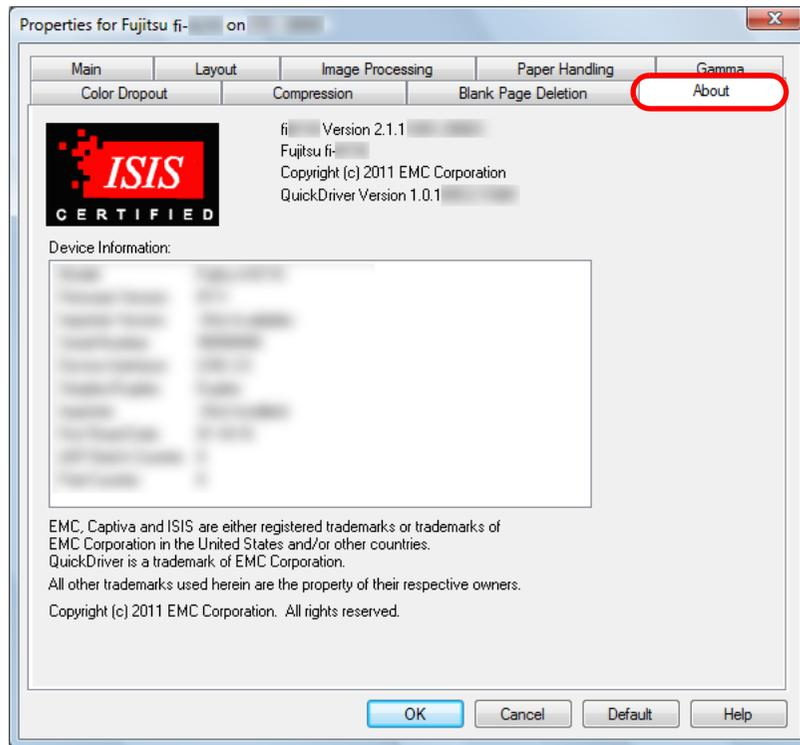

Select this tab to view information related to the version of the ISIS driver as well as the scanner connected to the computer.

TOP

Contents

Index

Introduction

Scanner
Overview

How to Load
Documents

Configuring the
Scan Settings

How to Use the
Operator Panel

Various Ways to
Scan

Daily Care

Replacing the
Consumables

Troubleshooting

Operational
Settings

Appendix

Glossary

Chapter 4 How to Use the Operator Panel

This chapter explains how to use the operator panel.

4.1 Operator Panel	64
--------------------------	----

TOP

Contents

Index

Introduction

Scanner
Overview

How to Load
Documents

Configuring the
Scan Settings

**How to Use the
Operator Panel**

Various Ways to
Scan

Daily Care

Replacing the
Consumables

Troubleshooting

Operational
Settings

Appendix

Glossary

4.1 Operator Panel

The operator panel consists of the Function Number Display, buttons, and LED indicator.

Names and Functions

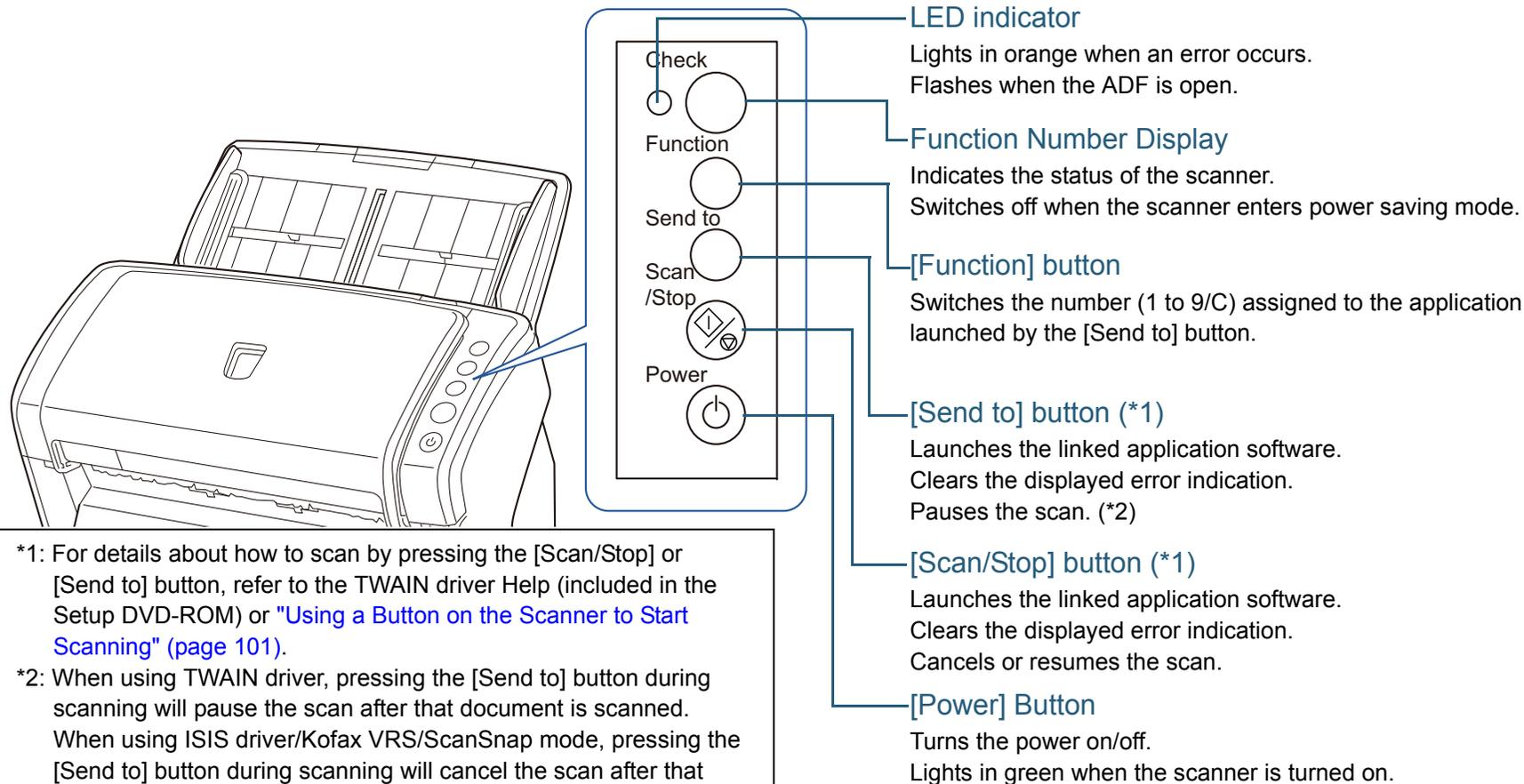

*1: For details about how to scan by pressing the [Scan/Stop] or [Send to] button, refer to the TWAIN driver Help (included in the Setup DVD-ROM) or "Using a Button on the Scanner to Start Scanning" (page 101).

*2: When using TWAIN driver, pressing the [Send to] button during scanning will pause the scan after that document is scanned. When using ISIS driver/Kofax VRS/ScanSnap mode, pressing the [Send to] button during scanning will cancel the scan after that document is scanned.



Do not use the operator panel while the Software Operation Panel is running.

TOP

Contents

Index

Introduction

Scanner
OverviewHow to Load
DocumentsConfiguring the
Scan SettingsHow to Use the
Operator PanelVarious Ways to
Scan

Daily Care

Replacing the
Consumables

Troubleshooting

Operational
Settings

Appendix

Glossary

Indications on Function Number Display

Display	Description
8	Displayed when the scanner has just been powered on.
P	Processing initialization.
0	Initialization is almost complete.
1	Ready to start scanning. Indicates that the initialization was successfully completed. This is referred to as "ready" status.
Function number (flash)	A function number will flash after detecting a multifeed. This indication prompts whether or not to memorize the overlap pattern. For details, refer to "Ignoring Multifeed for a Set Pattern" (page 105) .
c (flash)	Indicates that the ADF was opened when the status was ready ("1"). Note that the LED indicator will also flash. To return to ready ("1") status, close the ADF by For details, refer to "1.4 Opening/Closing the ADF" (page 24) . If the display does not return to ready ("1") after closing the ADF, turn the power off then back on. If the problem still persists, contact your FUJITSU scanner dealer or an authorized FUJITSU scanner service provider.
P (flash)	Indicates that the scan was paused by pressing the [Send to] button. Press the [Scan/Stop] button to resume the scan.
J U	Indicates that a temporary error occurred during scanning. The display will switch between either "J" or "U", and an "error number". For information about the error details, refer to "Temporary Errors" (page 127) . The display will return to ready ("1") if the [Scan/Stop] or [Send to] button is pressed.

Display	Description
E F C H A L	Indicates that a device error (alarm) occurred during initialization or scanning. The display will switch between either "E", "F", "C", "H", "A" or "L", and an "alarm number". For information about the error details, refer to "Device Errors" (page 128) . The display will return to ready ("1") if the [Scan/Stop] or [Send to] button is pressed. When this alarm occurs, turn the power off then back on. If the problem persists after turning the power back on, contact your FUJITSU scanner dealer or an authorized FUJITSU scanner service provider.
None	The display switches off when the scanner enters power saving mode.

TOP

Contents

Index

Introduction

Scanner
OverviewHow to Load
DocumentsConfiguring the
Scan SettingsHow to Use the
Operator PanelVarious Ways to
Scan

Daily Care

Replacing the
Consumables

Troubleshooting

Operational
Settings

Appendix

Glossary

Chapter 5 Various Ways to Scan

This chapter explains how to scan documents in various ways, by using examples of the TWAIN driver started via ScandAll PRO.

5.1 Summary	67
5.2 Scanning Documents of Different Types and Sizes.....	68
5.3 Advanced Scanning.....	82
5.4 Configuring Post-Scan Operations and Handling.....	91
5.5 Customizing the Scanner Settings	101

5.1 Summary

The following lists various ways of scanning documents.

Scanning documents of different types and sizes

- ["Scanning Both Sides at Once" \(page 68\)](#)
- ["Documents with Different Widths" \(page 69\)](#)
- ["Documents Larger than A4/Letter Size" \(page 70\)](#)
- ["Scanning Photographs and Clippings" \(page 73\)](#)
- ["Long Page Scanning" \(page 76\)](#)
- ["Scanning a Book \(fi-6230Z/fi-6240Z\)" \(page 78\)](#)
- ["Scanning a Large Document on the Flatbed \(fi-6230Z/fi-6240Z\)" \(page 80\)](#)

Advanced scanning

- ["Removing a Color from the Scanned Image \(Dropout Color\)" \(page 82\)](#)
- ["Skipping Blank Pages" \(page 85\)](#)
- ["Removing Punch Holes" \(page 86\)](#)
- ["Scanning the Image Brighter" \(page 88\)](#)
- ["Feeding Documents Manually in the ADF" \(page 90\)](#)

Configuring post-scan operations and handling

- ["Automatically Correcting Skewed Images" \(page 91\)](#)
- ["Automatically Correcting the Page Orientation" \(page 93\)](#)
- ["Splitting the Scanned Image in Two" \(page 95\)](#)
- ["Using the Multi Image Output" \(page 97\)](#)
- ["Automatically Detecting Color/Monochrome Documents" \(page 99\)](#)

Customizing the scanner settings

- ["Using a Button on the Scanner to Start Scanning" \(page 101\)](#)
- ["Detecting Multifeed Errors" \(page 103\)](#)
- ["Ignoring Multifeed for a Set Pattern" \(page 105\)](#)

For information on how to scan documents in the following methods, refer to "ScandAll PRO V2.0 User's Guide".

- [Saving Scanned Image in PDF File Format](#)
- [Dividing a Multipage Document Using Patch Codes](#)
- [Dividing a Multipage Document Using Barcodes](#)
- [Specifying the Result of Zone OCR as a File Name](#)
- [Specifying the Result of Barcode Recognition as a File Name](#)
- [Creating Saving Folders for Each Batch Scan](#)
- [Saving Scanned Images from a Batch Scan to Microsoft SharePoint Server](#)
- [Restarting a Suspended Batch Scan](#)
- [Outputting Indexing Information File and Linking with an Application](#)

[TOP](#)[Contents](#)[Index](#)[Introduction](#)[Scanner Overview](#)[How to Load Documents](#)[Configuring the Scan Settings](#)[How to Use the Operator Panel](#)[Various Ways to Scan](#)[Daily Care](#)[Replacing the Consumables](#)[Troubleshooting](#)[Operational Settings](#)[Appendix](#)[Glossary](#)

5.2 Scanning Documents of Different Types and Sizes

Scanning Both Sides at Once

- 1 Load the document in the ADF paper chute.
For details, refer to "[Chapter 2 How to Load Documents](#)" (page 37).
- 2 Start up ScandAll PRO and select the [Scan] menu → [Scanner Setting].
⇒ The [TWAIN Driver (32)] dialog box appears.



If the [TWAIN Driver (32)] dialog box does not appear, check the setting in ScandAll PRO by selecting the [Tool] menu → [Preferences] to open the [Setup] dialog box, then confirm that [TWAIN] is selected for [Device Driver] in the [Scan] tab.

- 3 Select [ADF (Duplex)] for [Scan Type].

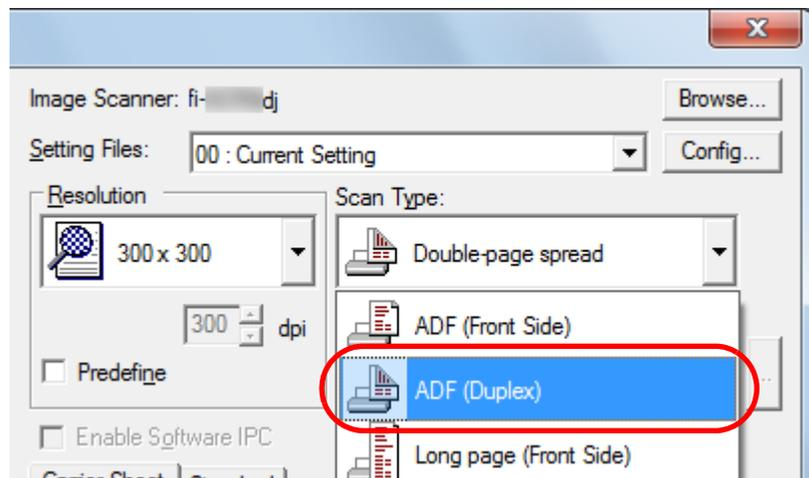

- 4 Configure other settings such as [Paper Size].
- 5 Click the [OK] button.
⇒ The changes are applied.
- 6 Scan the document by selecting the [Scan] menu → [Scan] in ScandAll PRO.

TOP

Contents

Index

Introduction

Scanner
OverviewHow to Load
DocumentsConfiguring the
Scan SettingsHow to Use the
Operator PanelVarious Ways to
Scan

Daily Care

Replacing the
Consumables

Troubleshooting

Operational
Settings

Appendix

Glossary

Documents with Different Widths



When you scan a mixed batch with different widths, some of the smaller documents may be skewed or not fed into the ADF. In that case, separate the documents by their widths, and scan them in different batches.



For more details about scanning a mixed batch of documents, refer to "[Conditions for Mixed Batch Scanning](#)" (page 47).

- 1 To avoid skewed images and detect the paper size automatically, select [Automatic Page Size Detection] in [Automatic Size and Skew Detection].
For details, refer to "[Automatically Correcting Skewed Images](#)" (page 91).

- 2 Align the top of the documents.

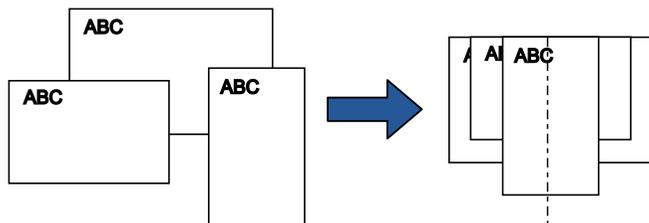

- 3 Place the documents at the center of the ADF paper chute, and adjust the side guides to the widest document in the batch.
For details, refer to "[Chapter 2 How to Load Documents](#)" (page 37).



Make sure that all documents are placed underneath the pick roller. Otherwise, some documents may be skewed or not fed into the ADF.

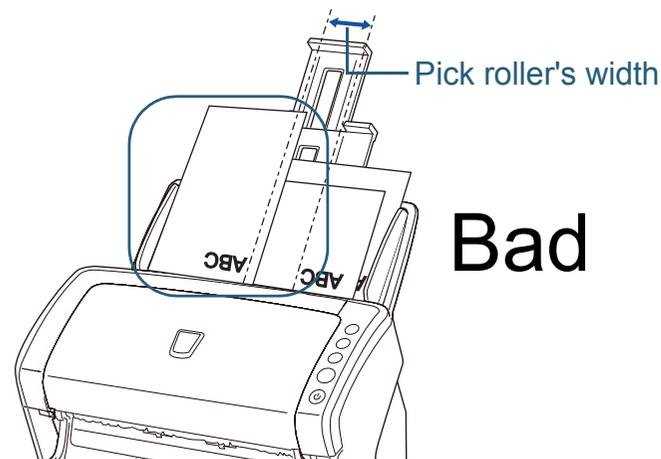
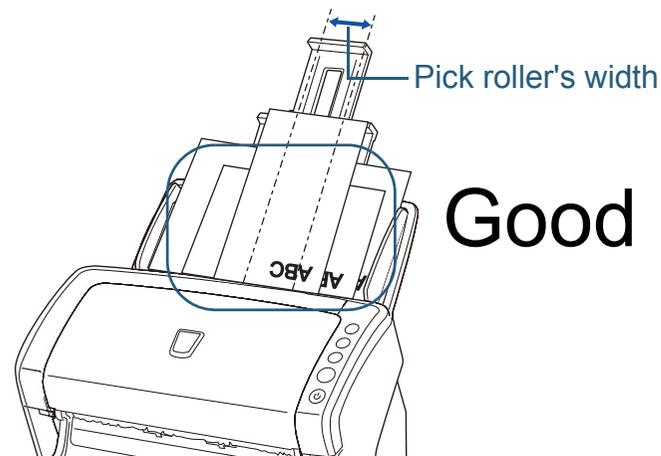

- 4 Scan the document by selecting the [Scan] menu → [Scan] in ScandAll PRO.

TOP

Contents

Index

Introduction

Scanner
OverviewHow to Load
DocumentsConfiguring the
Scan SettingsHow to Use the
Operator PanelVarious Ways to
Scan

Daily Care

Replacing the
Consumables

Troubleshooting

Operational
Settings

Appendix

Glossary

Documents Larger than A4/Letter Size

The Carrier Sheet can be used to scan documents larger than A4/Letter size, such as A3 and B4. By folding the document in half and scanning in duplex mode, the two sides are merged into a single image.



Part of the image around where the document is folded may appear missing. Using the Carrier Sheet is not recommended for obtaining high quality image.



You can also scan a double-sided document that is smaller than A4 size, and output the image as a double-page spread image.

1 Place the document inside the Carrier Sheet.

- 1 Fold the document in half so that the sides to be scanned are facing out. Fold it tightly and smooth out any creases. Otherwise, it may cause the document to skew during feeding.

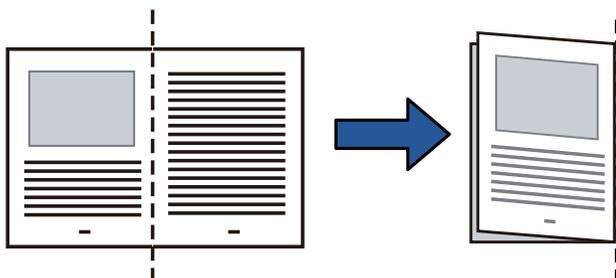

- 2 Place the document inside the Carrier Sheet. Align the fold line with the right edge of the Carrier Sheet so that the document fits in the upper right-hand corner.

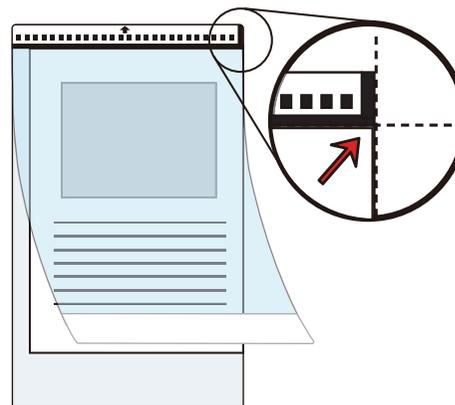

The front side of the Carrier Sheet has a thick vertical line on the right side of the black & white pattern.

2 Load the Carrier Sheet face-down in the ADF paper chute.

Secure the Carrier Sheet with the side guides to avoid skewing.

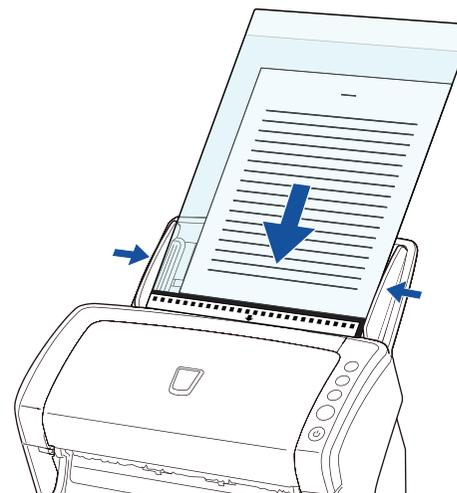

- 3** Start up ScandAll PRO and select the [Scan] menu → [Scanner Setting].

⇒ The [TWAIN Driver (32)] dialog box appears.



If the [TWAIN Driver (32)] dialog box does not appear, check the setting in ScandAll PRO by selecting the [Tool] menu → [Preferences] to open the [Setup] dialog box, then confirm that [TWAIN] is selected for [Device Driver] in the [Scan] tab.

- 4** Select [Double-page spread] for [Scan Type].

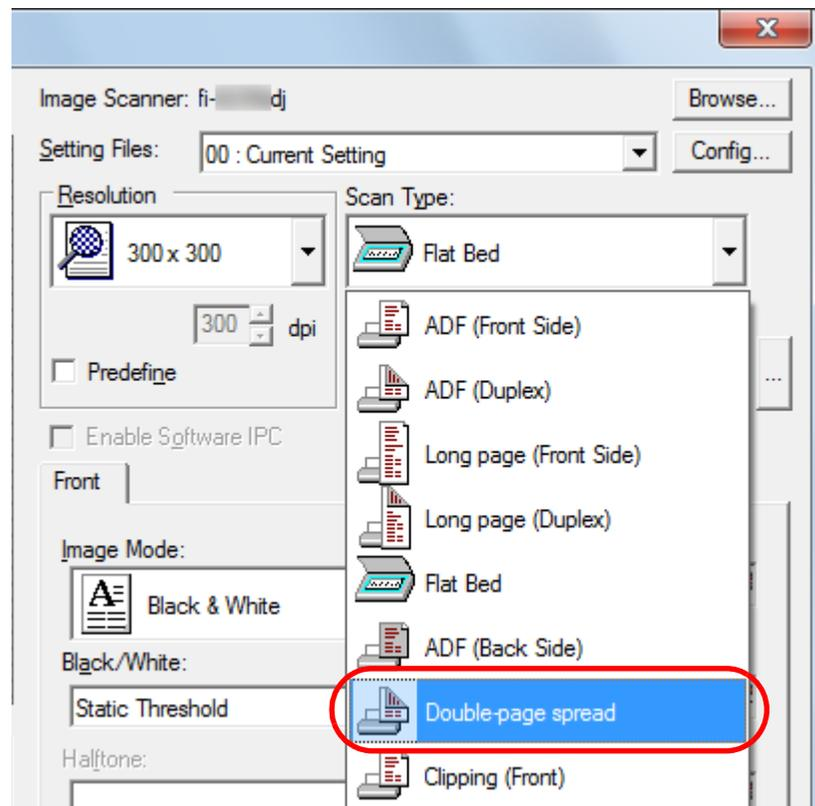

- 5** Click the [Carrier Sheet] tab and configure settings such as [Image Mode].

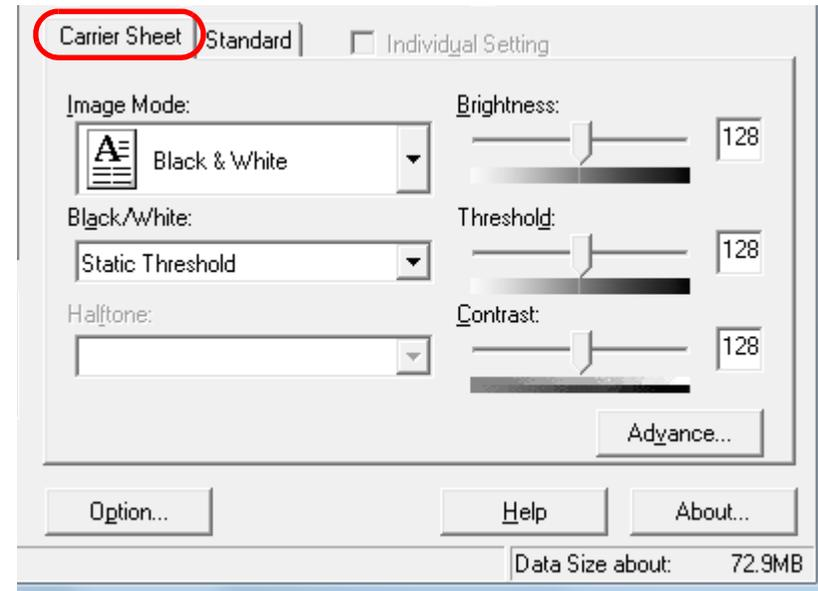

- 6** Click the [OK] button.

⇒ The settings are saved.

- 7** Scan the document by selecting the [Scan] menu → [Scan] in ScandAll PRO.

⇒ The images on the front and back are merged into a single image.

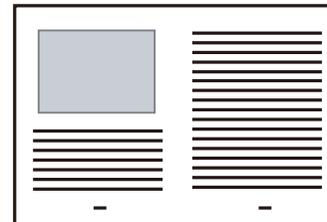



- There may be a line or a gap appearing between the front and back side images.
Also when you scan thick papers, images on both left and right may skew towards each other from the top. These symptoms may be improved when you perform the following:
 - Fold the document tightly
 - Align the edges of the document neatly with the edges of the Carrier Sheet
 - Turn over the Carrier Sheet to the other (reverse) side
- When [Automatic detection] is specified for [Paper Size], the closest standard size (A3, A4 or Double Letter) is selected from the same drop-down list. Note that the size of the image may become smaller than the original document depending on the document scanned.
Example: When you scan an A3 size document whose content is printed to fit A4 size in the center
⇒The image is output in B4 size.
To output the scanned image in the actual size of the document, specify the document size for [Paper size].
- Part of the image around where the document is folded may appear missing. In that case, set the document so its edge is about 1 mm inside from the edge of the Carrier Sheet.
- When [Black & White] is specified for [Image Mode], the edges around the image may appear in black from the shadow of the document.

Scanning Photographs and Clippings

Using the Carrier Sheet allows you to scan documents that can be damaged quite easily such as photographs, or documents that are difficult to load directly such as newspaper clippings.

- 1 Place the document inside the Carrier Sheet.
Place it against the top center of the Carrier Sheet.

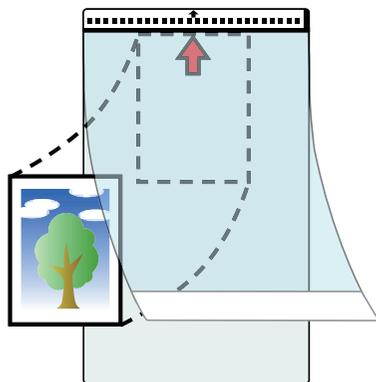

- 2 Load the Carrier Sheet face-down in the ADF paper chute, as shown below.
Secure the Carrier Sheet with the side guides to avoid skewing.

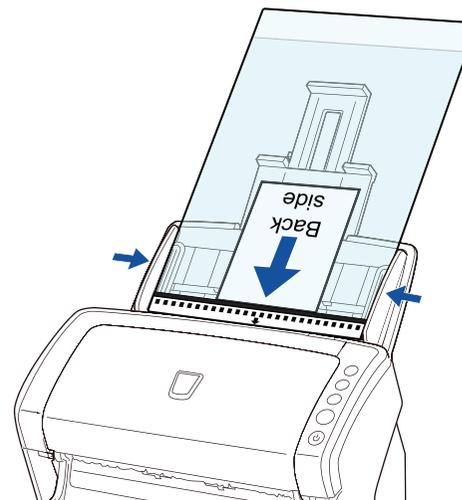

- 3 Start up ScandAll PRO and select the [Scan] menu → [Scanner Setting].
⇒ The [TWAIN Driver (32)] dialog box appears.



If the [TWAIN Driver (32)] dialog box does not appear, check the setting in ScandAll PRO by selecting the [Tool] menu → [Preferences] to open the [Setup] dialog box, then confirm that [TWAIN] is selected for [Device Driver] in the [Scan] tab.

4 Select [Clipping (Front)] or [Clipping (Duplex)] for [Scan Type].

Select [Clipping (Front)] for simplex scanning and [Clipping (Duplex)] for duplex scanning.

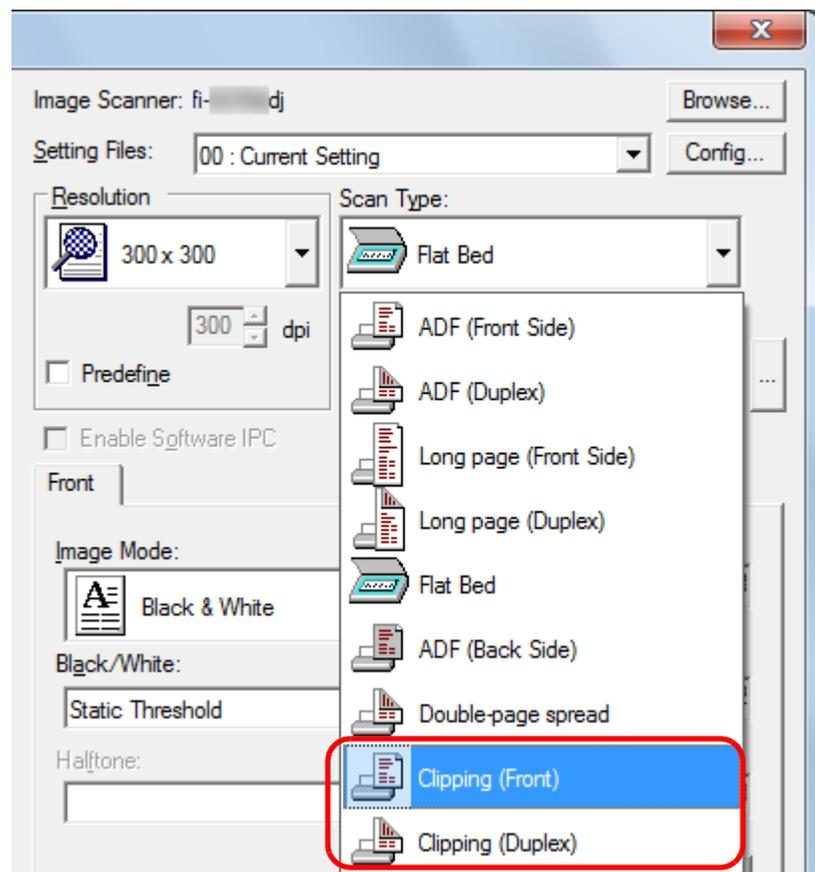

5 Click the [Carrier Sheet] tab and configure settings such as [Image Mode].

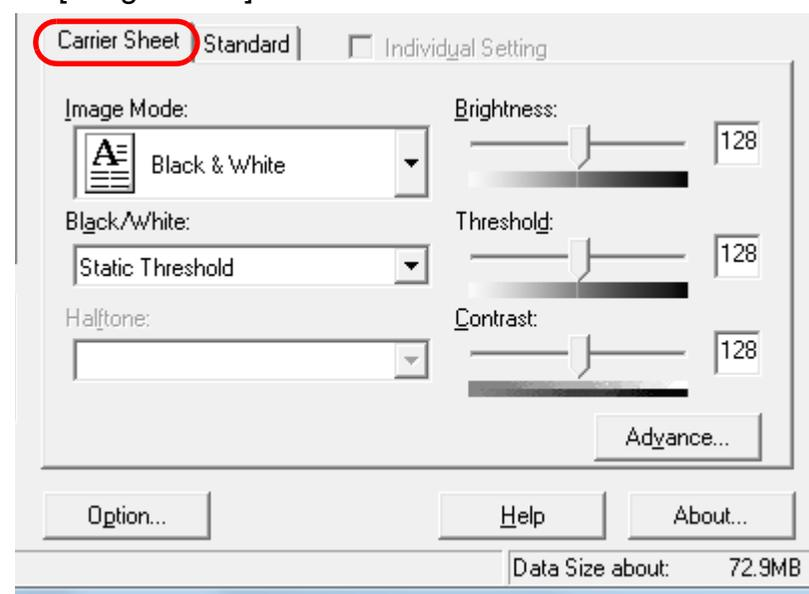

6 Click the [OK] button. ⇒ The settings are saved.

7 Scan the document by selecting the [Scan] menu → [Scan] in ScandAll PRO.



- The image is output at the center of the page in the size specified in [Paper Size].
- When [Automatic detection] is specified for [Paper Size], the closest standard size is selected from the same drop-down list. Note that the size of the image may become smaller than the original document depending on the document scanned, or part of the image may appear missing.
Example: When an A5 size image is printed in the center of an A4 size document
⇒ The image is output in A5 size.
To output the scanned image in the actual size of the document, specify the document size for [Paper size].



In the following cases, place a blank (white) sheet of paper underneath the document when scanning.

- The scanned image is not output in the correct size when [Automatic detection] is selected in the [Paper size] drop-down list
- Shadows appear around the edges of the scanned image
- Black lines appear around the edges of a uniquely shaped cutting
- Colors outside the document appear on the scanned image

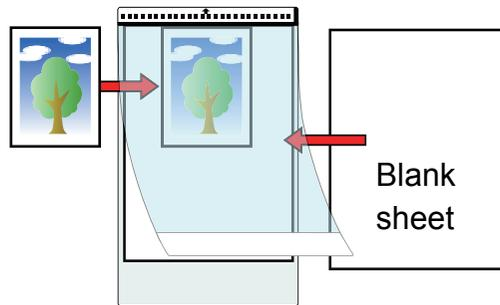

Long Page Scanning

Documents with a length up to 3,048 mm (120 in.) can be scanned by long page scanning.

- 1 Load the document in the ADF paper chute.
For details, refer to "[Chapter 2 How to Load Documents](#)" (page 37).



- Long page documents should be loaded one sheet at a time in the ADF paper chute.
- When you scan long pages, take note of the following.
 - Loading
Hold the document with your hand so it does not fall out of the ADF paper chute.

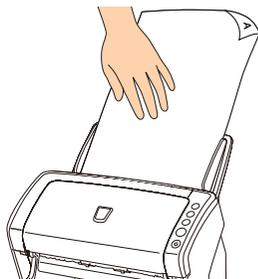

- Removing
Secure enough space around the stacker to prevent the ejected sheet from falling off the stacker.

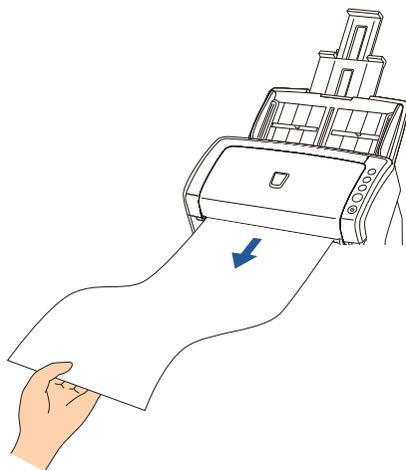

To scan documents longer than A4/Letter size, perform the following:

- Pull out the chute extensions all the way.
For details, refer to "[1.6 Setting Up the ADF Paper Chute](#)" (page 26).
- Lift the stacker and stacker extension towards you.
For details, refer to "[1.7 Setting Up the Stacker](#)" (page 27).

- 2 Start up ScandAll PRO and select the [Scan] menu → [Scanner Setting].

⇒ The [TWAIN Driver (32)] dialog box appears.



If the [TWAIN Driver (32)] dialog box does not appear, check the setting in ScandAll PRO by selecting the [Tool] menu → [Preferences] to open the [Setup] dialog box, then confirm that [TWAIN] is selected for [Device Driver] in the [Scan] tab.

- 3** In [Scan Type], select [Long page (Front Side)] or [Long page (Duplex)].

Select [Long page (Front Side)] for simplex scanning and [Long page (Duplex)] for duplex scanning.

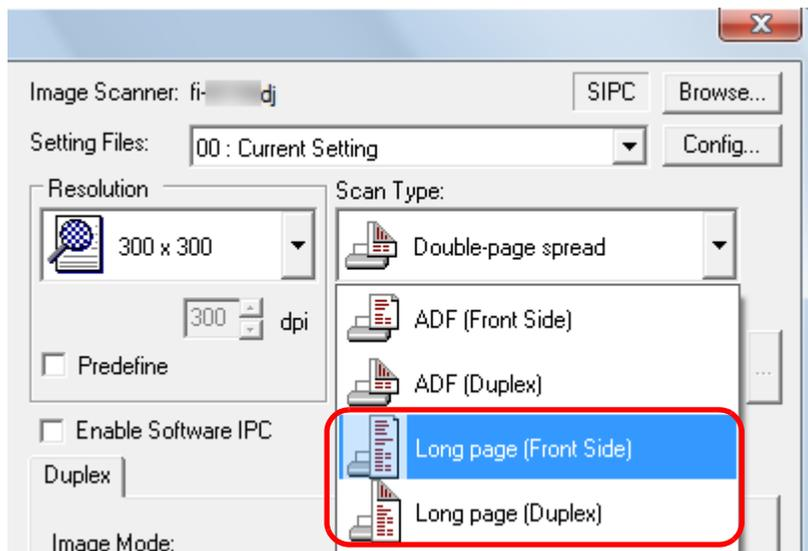

⇒ The [Long Page Paper Size Setting] dialog box appears.

- 4** Specify the paper size and click the [OK] button.

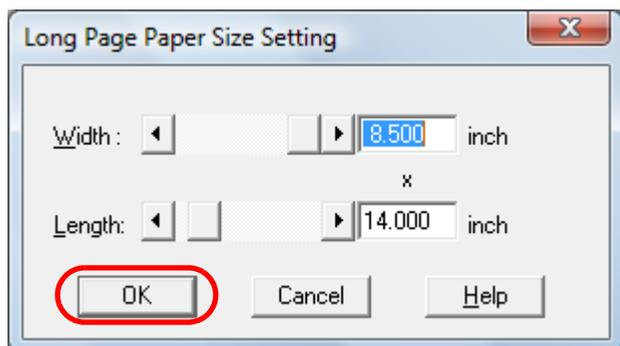

- 5** Click the [OK] button.

⇒ The changes are applied.

- 6** Scan the document by selecting the [Scan] menu → [Scan] in ScandAll PRO.



- To scan documents longer than 864 mm (34 in.), set the resolution to 200 dpi or lower.
- Depending on the application or scan settings (e.g. paper size), there may be insufficient memory to perform scanning.

Scanning a Book (fi-6230Z/fi-6240Z)

- 1 Open the document cover.
For details, refer to "1.5 Opening/Closing the Document Cover (fi-6230Z/fi-6240Z)" (page 25).

- 2 Remove the document cover by pulling it out in the direction of the arrow.

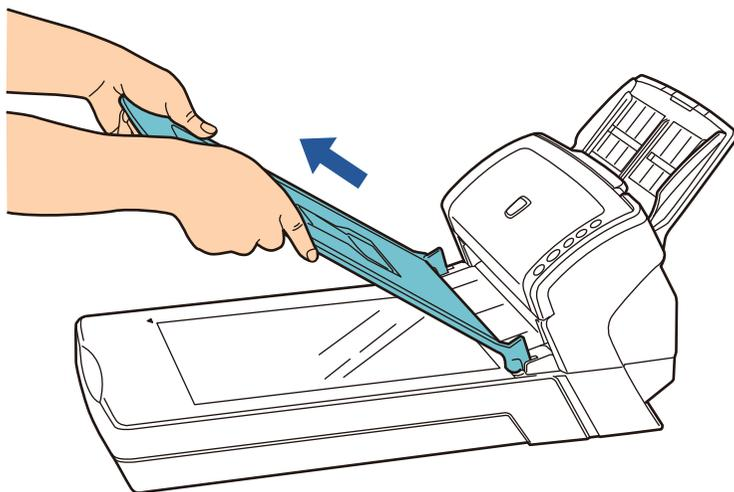

- 3 Load the document on the document bed.
Place the document face-down to align its top left-hand corner with the reference point.

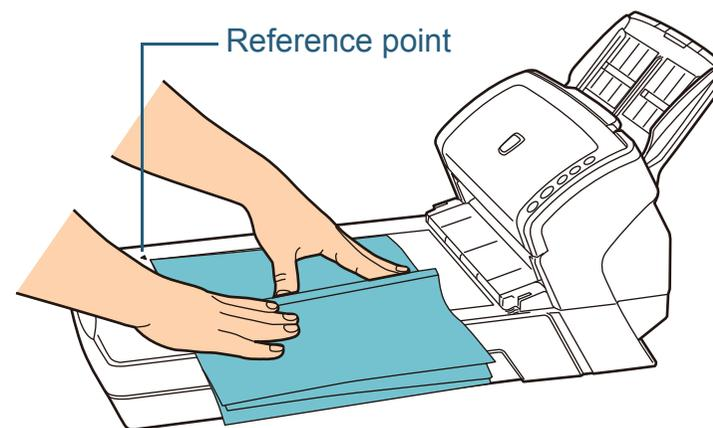

- 4 Start up ScandAll PRO and select the [Scan] menu → [Scanner Setting].
⇒ The [TWAIN Driver (32)] dialog box appears.



If the [TWAIN Driver (32)] dialog box does not appear, check the setting in ScandAll PRO by selecting the [Tool] menu → [Preferences] to open the [Setup] dialog box, then confirm that [TWAIN] is selected for [Device Driver] in the [Scan] tab.

5 Select [Flat Bed] for [Scan Type].

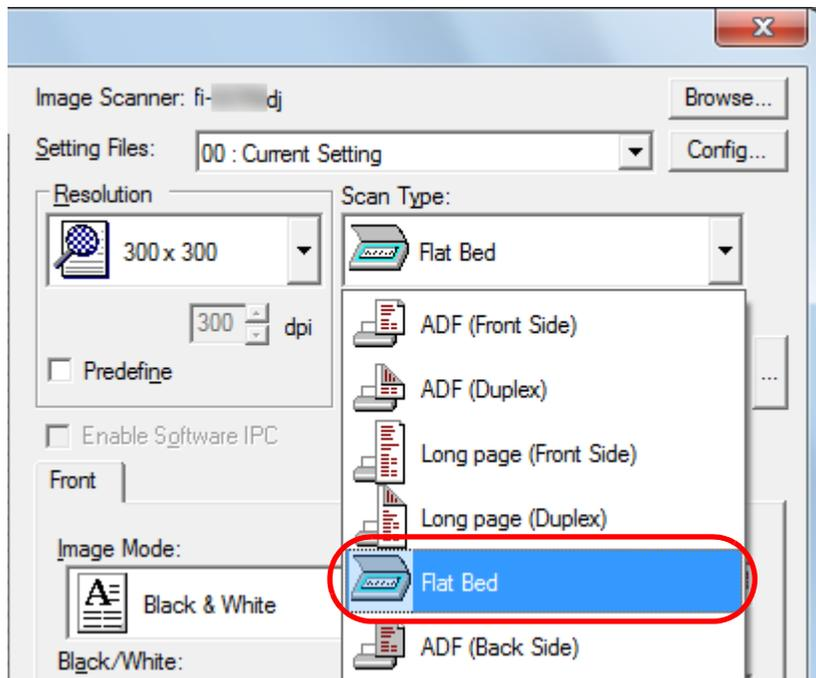

6 Click the [OK] button.
⇒ The changes are applied.

7 Scan the document by selecting the [Scan] menu → [Scan] in ScandAll PRO.

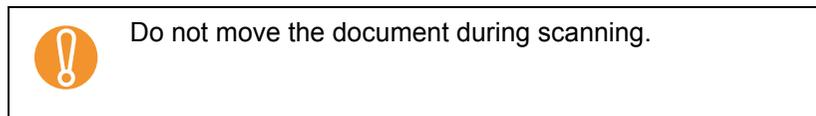
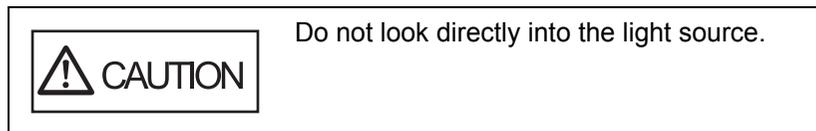

8 Attach the document cover.

9 Close the document cover.
For details, refer to "[1.5 Opening/Closing the Document Cover \(fi-6230Z/fi-6240Z\)](#)" (page 25).

- TOP
- Contents
- Index
- Introduction
- Scanner Overview
- How to Load Documents
- Configuring the Scan Settings
- How to Use the Operator Panel
- Various Ways to Scan**
- Daily Care
- Replacing the Consumables
- Troubleshooting
- Operational Settings
- Appendix
- Glossary

Scanning a Large Document on the Flatbed (fi-6230Z/fi-6240Z)

- 1 Open the document cover.
For details, refer to "1.5 Opening/Closing the Document Cover (fi-6230Z/fi-6240Z)" (page 25).

- 2 Remove the document cover by pulling it out in the direction of the arrow.

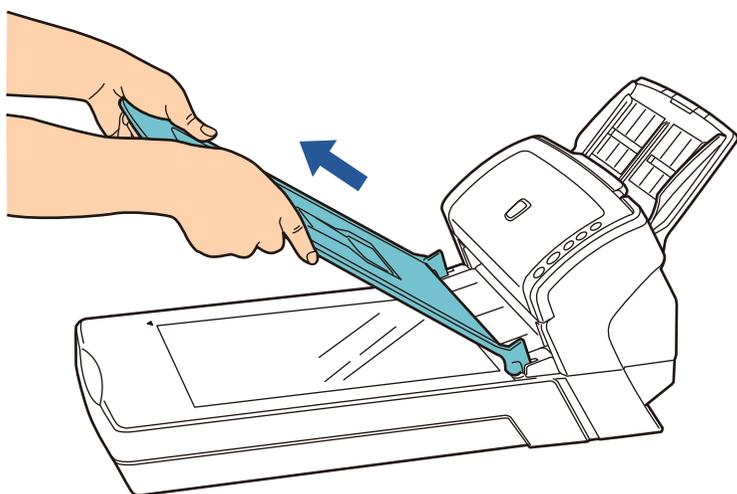

- 3 Load the document on the document bed.
Place the document face-down to align its top left-hand corner with the reference point.

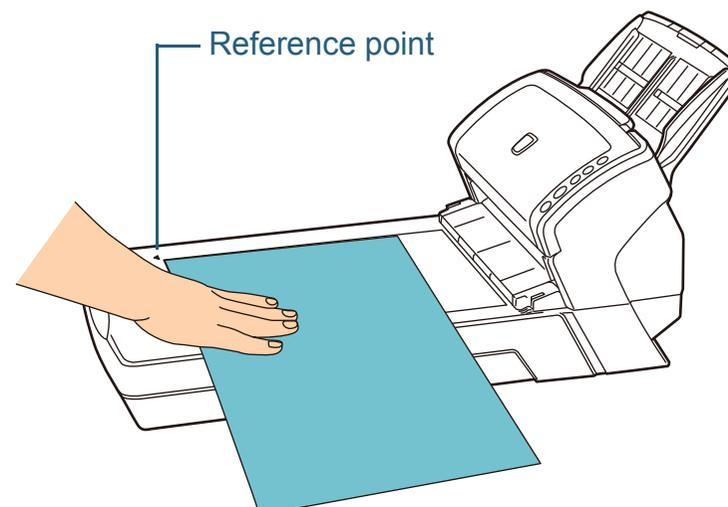

- 4 Start up ScandAll PRO and select the [Scan] menu → [Scanner Setting].
⇒ The [TWAIN Driver (32)] dialog box appears.



If the [TWAIN Driver (32)] dialog box does not appear, check the setting in ScandAll PRO by selecting the [Tool] menu → [Preferences] to open the [Setup] dialog box, then confirm that [TWAIN] is selected for [Device Driver] in the [Scan] tab.

5 Select [Flat Bed] for [Scan Type].

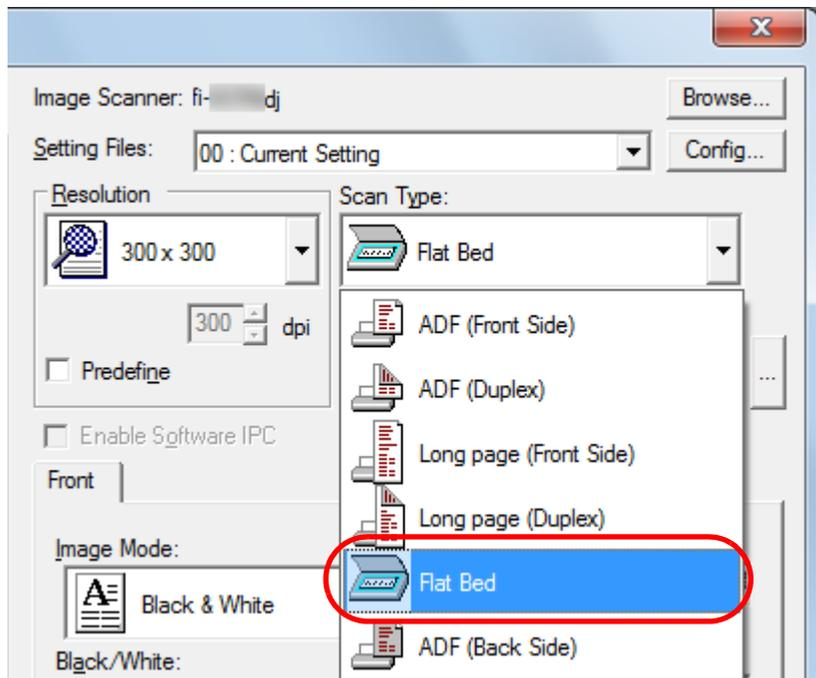

6 Click the [OK] button.
⇒ The changes are applied.

7 Scan the document by selecting the [Scan] menu → [Scan] in ScandAll PRO.

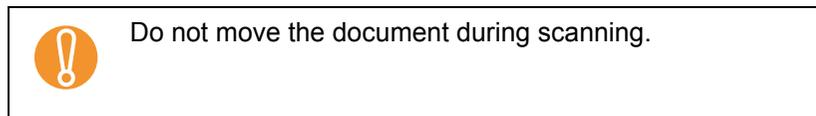
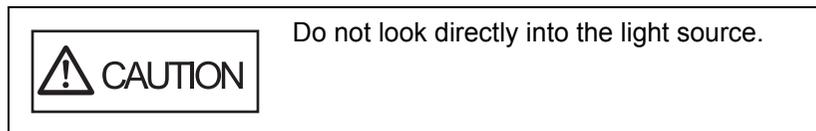

8 Attach the document cover.

9 Close the document cover.
For details, refer to "1.5 Opening/Closing the Document Cover (fi-6230Z/fi-6240Z)" (page 25).

- TOP
- Contents
- Index
- Introduction
- Scanner Overview
- How to Load Documents
- Configuring the Scan Settings
- How to Use the Operator Panel
- Various Ways to Scan**
- Daily Care
- Replacing the Consumables
- Troubleshooting
- Operational Settings
- Appendix
- Glossary

5.3 Advanced Scanning

Removing a Color from the Scanned Image (Dropout Color)

You can select either green, red, blue (primary colors), or a color of your choice to remove the details of the selected color from a scanned image.

For example, if a document with black characters and a green background is scanned, only the black characters will appear on the scanned image if [Green] is selected.

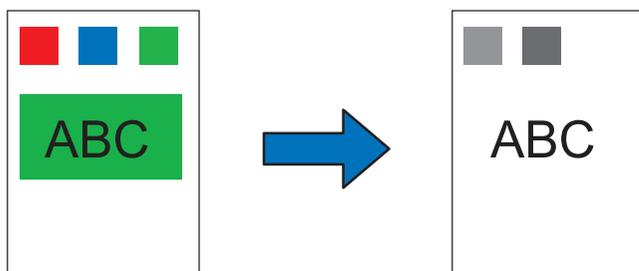

Example: When [Green] is selected for dropout color



Dropout works the best with light (low intensity) colors, and dark colors may not drop out.



Dropout color is only available in black & white or grayscale mode.

1 Load the document.

For details, refer to "[Chapter 2 How to Load Documents](#)" (page 37).

2 Start up ScandAll PRO and select the [Scan] menu → [Scanner Setting].

⇒ The [TWAIN Driver (32)] dialog box appears.



If the [TWAIN Driver (32)] dialog box does not appear, check the setting in ScandAll PRO by selecting the [Tool] menu → [Preferences] to open the [Setup] dialog box, then confirm that [TWAIN] is selected for [Device Driver] in the [Scan] tab.

3 Click the [Advance] button.

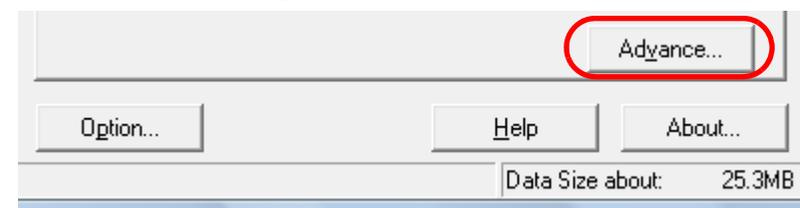

⇒ The [Advance] dialog box appears.

- 4 Click the [Gray] tab, and then select a color from [Dropout Color] under [More].

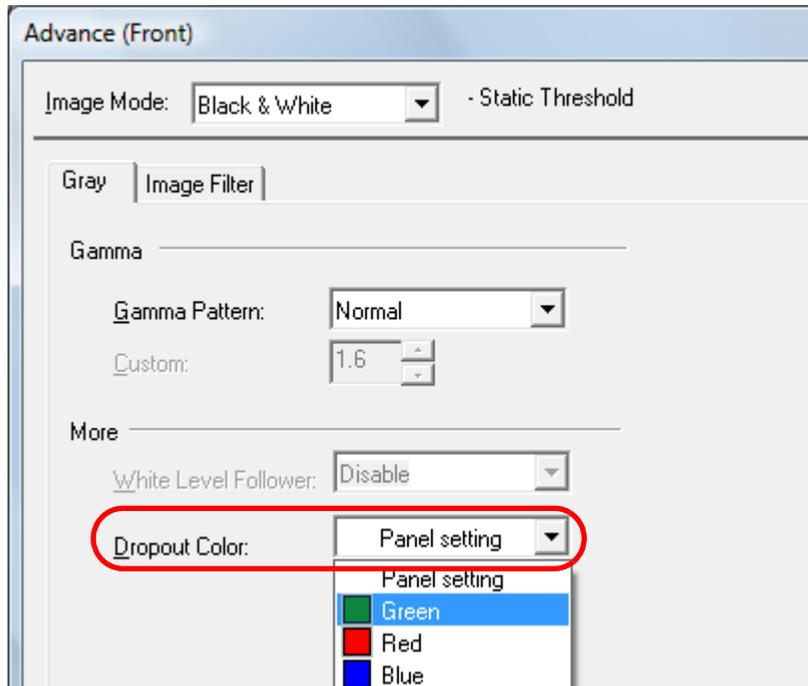

If you select [Panel setting], the setting of the Software Operational Panel is enabled.

No color is dropped out when you select [None].

To drop out a color of your choice, select either [Custom], [Custom 2] or [Custom 3].

When you select [Custom], [Custom 2], or [Custom 3], the [Select Dropout Color] dialog box is displayed where you can select up to three colors of your choice.

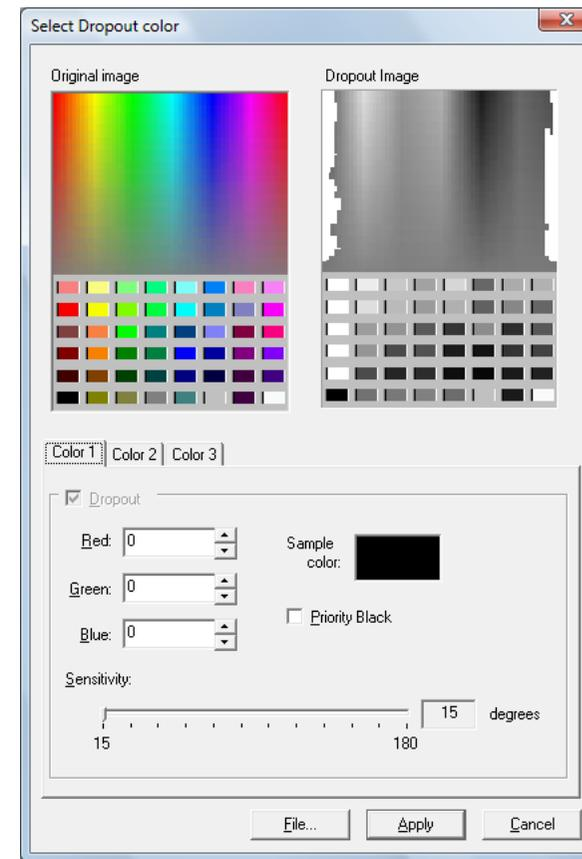

- [Original image]
A sample of the color is displayed. Click to select the color.
- [Dropout image]
The image after removing the details of the color is displayed.

- [Color 1], [Color 2] and [Color 3] tabs
Specify the color(s) to be dropped out.
Up to three colors can be selected at once.
 - [Dropout] check box
Select this check box in the [Color 2] or [Color 3] tab when two or more dropout colors are specified.
 - [Red] / [Green] / [Blue]
The specified colors are displayed in numerical values. Either type in the value directly or use the [▲] / [▼] button to change the value.
 - [Sample color]
The specified color is displayed.
- [Priority Black] check box
Select this check box when you do not want any text/characters to be dropped out.
This option saves low intensity colors such as black (generally used for characters) from being removed.
- [Sensitivity]
Specify the allowable range for the selected dropout color.
Range: 15 to 180 degrees
The larger the value is set, the wider the color range becomes.
- [File] Button
You can select an image file (*.bmp) to be displayed for [Original image], and then specify the color to be dropped out.
- [Apply] Button
Applies the configured settings and closes the dialog box.
- [Cancel] Button
Cancels the configured settings and closes the dialog box.

5 Click the [OK] button.

⇒ It returns to the [TWAIN Driver (32)] dialog box.

6 Click the [OK] button in the [TWAIN Driver (32)] dialog box.

⇒ The settings are saved.

7 Scan the document by selecting the [Scan] menu → [Scan] in ScandAll PRO.

Skipping Blank Pages

Blank pages (black or white) in the documents can be detected and automatically deleted during scanning. For example, when you scan a mixed batch of double-sided and single-sided documents in duplex mode, the images are generated without the back sides of the single-sided documents (blank pages).

- 1 Load the documents in the ADF paper chute.
For details, refer to "[Chapter 2 How to Load Documents](#)" (page 37).
- 2 Start up ScandAll PRO and select the [Scan] menu → [Scanner Setting].
⇒ The [TWAIN Driver (32)] dialog box appears.



If the [TWAIN Driver (32)] dialog box does not appear, check the setting in ScandAll PRO by selecting the [Tool] menu → [Preferences] to open the [Setup] dialog box, then confirm that [TWAIN] is selected for [Device Driver] in the [Scan] tab.

- 3 Click the [Option] button.

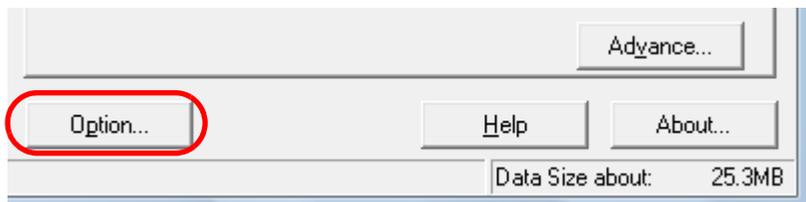

⇒ The [Option] dialog box appears.

- 4 Click the [Job/Cache] tab and select the [Blank Page Skip] check box.

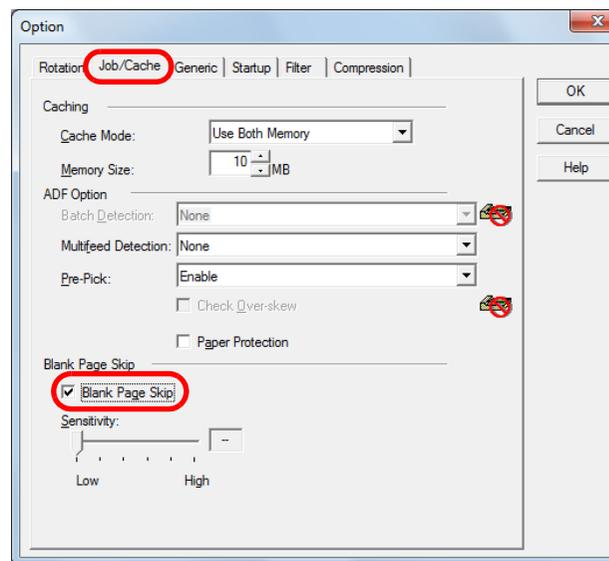

⇒ The cache mode automatically switches to [Ram cache] or [Use Both Memory].

- 5 Use the slider to adjust the sensitivity.

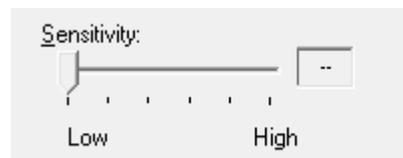

Select from five levels. The larger the value is set, the more likely for the pages to be detected as blank. Blank pages will not be deleted if you select [--].

- 6 Click the [OK] button.
⇒ It returns to the [TWAIN Driver (32)] dialog box.
- 7 Click the [OK] button in the [TWAIN Driver (32)] dialog box.
⇒ The settings are saved.
- 8 Scan the document by selecting the [Scan] menu → [Scan] in ScandAll PRO.

Removing Punch Holes

You can remove punch holes from the output scanned image.

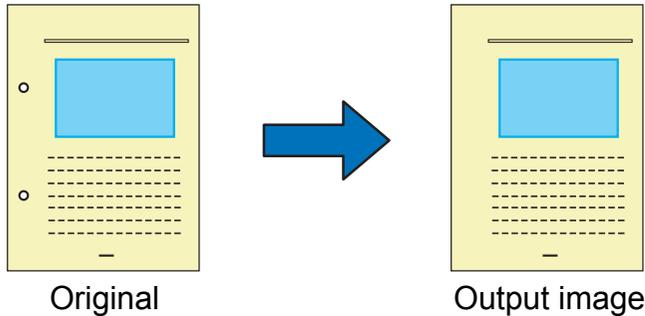

Punch holes cannot be removed when:

- The holes are not aligned along the edge of the document
- The size and gap between the holes vary
- The hole is near the edge of the document
- The document is not rectangular
- The document has a dark background color
- There are characters/pictures over the edge or the holes
- [Automatic Page Size Detection] is specified and the scanned document is larger than the selected paper size
- [Black Background] is specified and the scanned document does not match with the selected paper size.

1 Load the documents.

For details, refer to "[Chapter 2 How to Load Documents](#)" (page 37).

2 Start up ScandAll PRO and select the [Scan] menu → [Scanner Setting].

⇒ The [TWAIN Driver (32)] dialog box appears.



If the [TWAIN Driver (32)] dialog box does not appear, check the setting in ScandAll PRO by selecting the [Tool] menu → [Preferences] to open the [Setup] dialog box, then confirm that [TWAIN] is selected for [Device Driver] in the [Scan] tab.

3 Click the [Option] button.

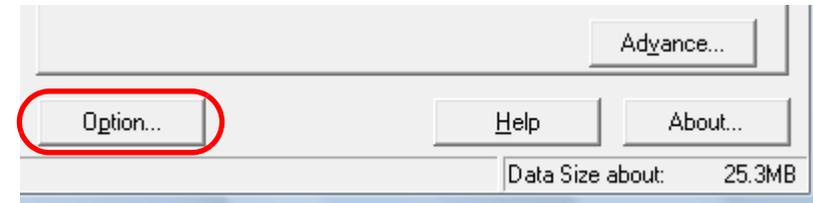

⇒ The [Option] dialog box appears.

4 Click the [Rotation] tab and select [Automatic Page Size Detection] or [Black Background] in the [Automatic Size and Skew detection] drop-down list.

The [Hole punch removal] function is disabled when a setting other than [Automatic Page Size Detection] or [Black Background] is specified.

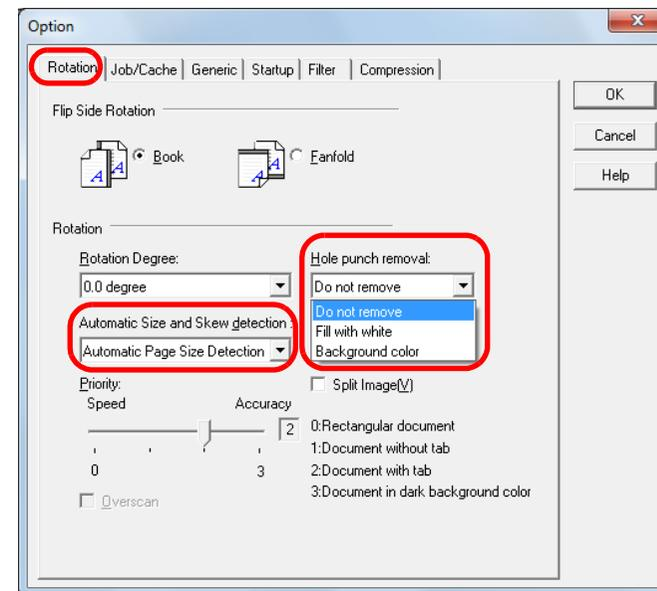

5 Select [Fill with white] or [Background color] under [Hole punch removal].

Select [Background color] when scanning a color document. If [Fill with white] is selected, the punch holes will appear as if they are filled with white squares.

- 6** Click the [OK] button.
⇒ It returns to the [TWAIN Driver (32)] dialog box.
- 7** Click the [OK] button in the [TWAIN Driver (32)] dialog box.
⇒ The settings are saved.
- 8** Scan the document by selecting the [Scan] menu → [Scan] in ScandAll PRO.



With some types of documents, the characters or graphics may be falsely detected as punch holes and filled with a color, or the punch holes may not be filled at all. In such cases, select [Automatic Page Size Detection] and specify "3" for [Priority] to improve the accuracy of hole punch removal.

Scanning the Image Brighter

The brightness of the scanned image can be increased for scanning in grayscale or color.

- 1 Load the document.
For details, refer to "Chapter 2 How to Load Documents" (page 37).
- 2 Start up ScandAll PRO and select the [Scan] menu → [Scanner Setting].
⇒ The [TWAIN Driver (32)] dialog box appears.



If the [TWAIN Driver (32)] dialog box does not appear, check the setting in ScandAll PRO by selecting the [Tool] menu → [Preferences] to open the [Setup] dialog box, then confirm that [TWAIN] is selected for [Device Driver] in the [Scan] tab.

- 3 Select grayscale or color in [Image Mode].

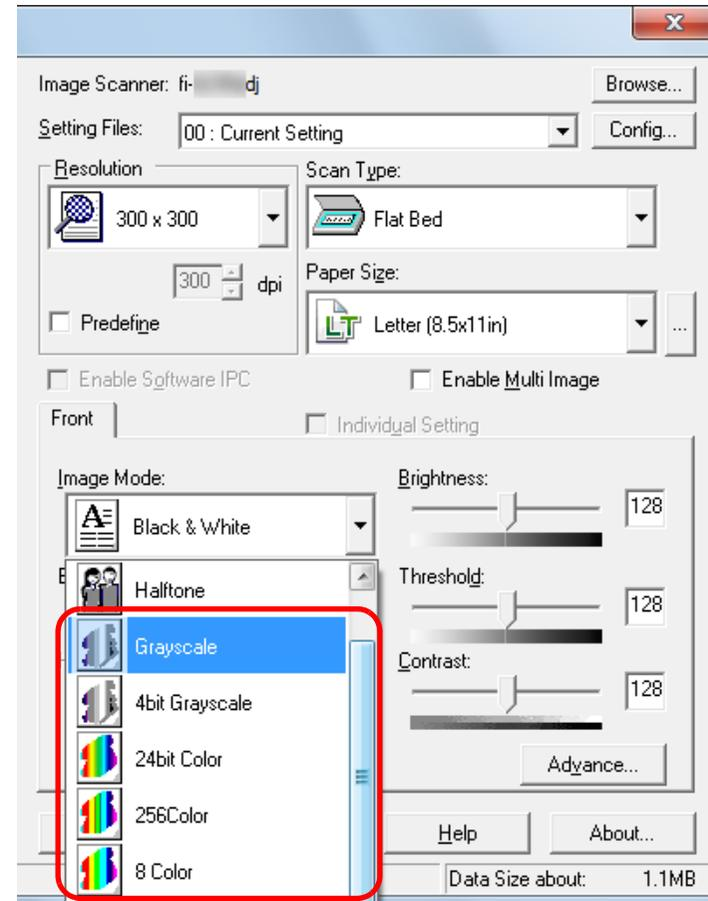

- 4 Click the [Advance] button.

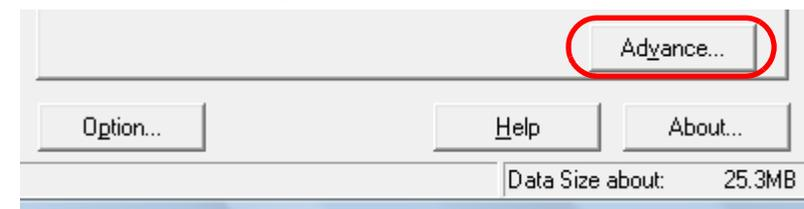

⇒ The [Advance] dialog box appears.

- Click the [Color] tab, and then select [Bright] in [Preset Gamma].

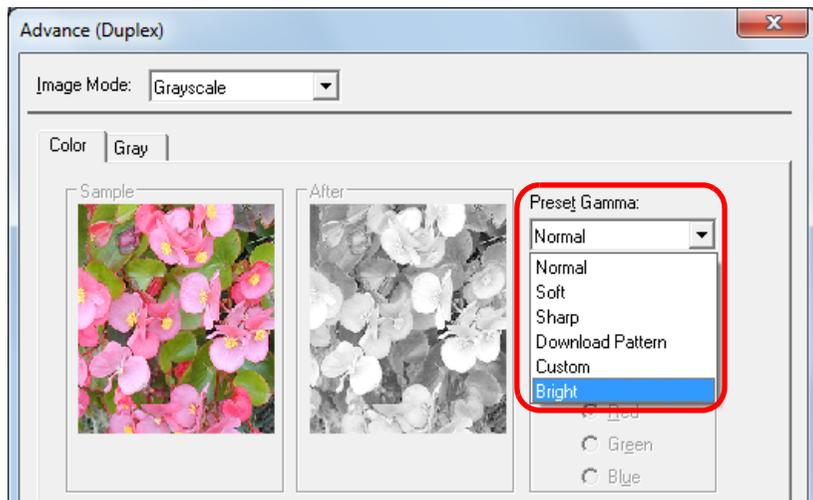

- Click the [OK] button.
⇒ It returns to the [TWAIN Driver (32)] dialog box.
- In the [TWAIN Driver (32)] dialog box, click the [OK] button.
⇒ The settings are saved.

- Scan the document by selecting the [Scan] menu → [Scan] in ScandAll PRO.



When using applications other than ScandAll PRO, you can also increase the default brightness of the TWAIN driver. Select [Tools] → [FtSwtGmm] → [Twain] in the Setup DVD-ROM and double-click "FtSwtGmm.exe", and then select [Bright] in the [Default scan setting (TWAIN)] dialog box.

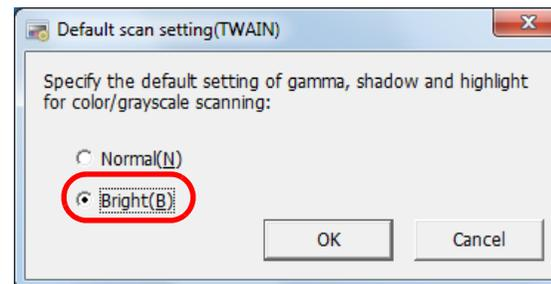

- TOP
- Contents
- Index
- Introduction
- Scanner Overview
- How to Load Documents
- Configuring the Scan Settings
- How to Use the Operator Panel
- Various Ways to Scan**
- Daily Care
- Replacing the Consumables
- Troubleshooting
- Operational Settings
- Appendix
- Glossary

Feeding Documents Manually in the ADF

Documents can also be loaded manually one sheet at a time in the ADF.

Normally, in automatic feeding, the scanner stops scanning once all the documents loaded in the ADF paper chute have been scanned.

In manual feeding, the scanner waits for the next document to be loaded within a specified time. Scanning will continue as long as another document is loaded within the set time, and stops if no document is loaded.

By using this method, you can perform scanning as you check the documents one by one.

Manual feeding is effective in the following cases.

- To scan as you check the contents of each sheet.
- To scan documents that cause multifeed or paper jam when loaded together in the same batch.
- To continue scanning documents such as magazine/newspaper clippings that cannot be loaded together.

1 Enable manual feeding in the Software Operation Panel.
For details, refer to "[Waiting Time in Manual Feed Mode \[Manual-feed timeout\]](#)" (page 186).

2 Load a document in the ADF paper chute.
For details, refer to "[Chapter 2 How to Load Documents](#)" (page 37).

3 Scan the document by selecting the [Scan] menu → [Scan] in ScandAll PRO.
⇒ After the document is scanned, the rollers inside the ADF keep rotating, waiting for the next document to be loaded for the time specified in the Software Operation Panel.

4 Load the next document in the ADF paper chute.
⇒ The document is scanned.

5 Repeat step 4 until all documents are scanned.
⇒ Scanning will stop if no document is loaded within the set time.



- Pressing the [Send to] button on the operator panel will stop the scan immediately.
- When [Manual-feed timeout] is enabled, the scanner will wait for the set time even if you start scanning with no document in the ADF paper chute.
- When you use manual feeding frequently, replacement cycle of the consumables may be shortened.

5.4 Configuring Post-Scan Operations and Handling

Automatically Correcting Skewed Images

When the documents are fed into the ADF skewed, the skewed images can be detected and straightened automatically.

Note that upon deskewing the images, the paper size of the documents are also detected automatically.

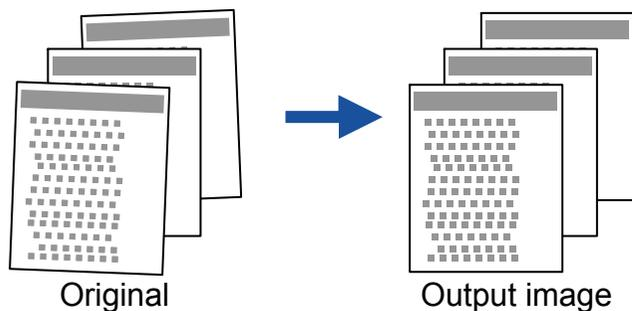

Note that the image may be output a few mm larger than the document to avoid any part of the image to appear missing.



For details about automatic page size detection, refer to "[Conditions for Automatic Page Size Detection](#)" (page 49).

- 1 Load the documents in the ADF paper chute.
For details, refer to "[Chapter 2 How to Load Documents](#)" (page 37).

- 2 Start up ScandAll PRO and select the [Scan] menu → [Scanner Setting].
⇒ The [TWAIN Driver (32)] dialog box appears.



If the [TWAIN Driver (32)] dialog box does not appear, check the setting in ScandAll PRO by selecting the [Tool] menu → [Preferences] to open the [Setup] dialog box, then confirm that [TWAIN] is selected for [Device Driver] in the [Scan] tab.

- 3 Click the [Option] button.

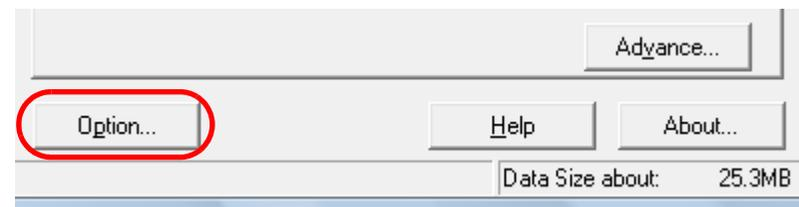

⇒ The [Option] dialog box appears.

TOP

Contents

Index

Introduction

Scanner
OverviewHow to Load
DocumentsConfiguring the
Scan SettingsHow to Use the
Operator PanelVarious Ways to
Scan

Daily Care

Replacing the
Consumables

Troubleshooting

Operational
Settings

Appendix

Glossary

- 4 Click the [Rotation] tab and select [Automatic Page Size Detection] in the [Automatic Size and Skew detection] drop-down list.

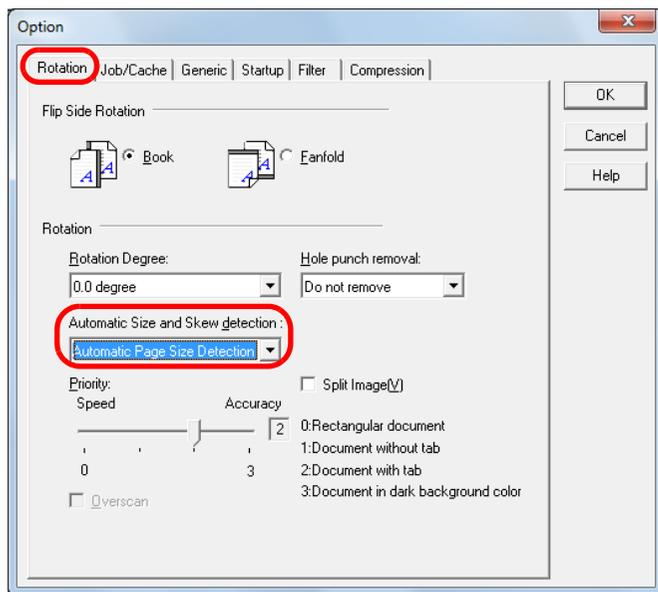

[Automatic Page Size Detection] may not work properly if the documents are severely skewed.



Selecting [Automatic Page Size Detection] may slow down the scanning speed.

- 5 Click the [OK] button.
⇒ It returns to the [TWAIN Driver (32)] dialog box.
- 6 Click the [OK] button in the [TWAIN Driver (32)] dialog box.
⇒ The settings are saved.
- 7 Scan the document by selecting the [Scan] menu → [Scan] in ScandAll PRO.

Automatically Correcting the Page Orientation

When you scan a batch of documents with mixed page orientations, the images can be adjusted to their correct page orientations automatically.

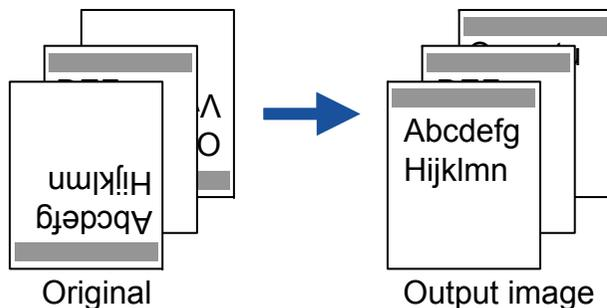

- 1 Load the documents in the ADF paper chute.
For details, refer to "[Chapter 2 How to Load Documents](#)" (page 37).
- 2 Start up ScandAll PRO and select the [Scan] menu → [Scanner Setting].
⇒ The [TWAIN Driver (32)] dialog box appears.



If the [TWAIN Driver (32)] dialog box does not appear, check the setting in ScandAll PRO by selecting the [Tool] menu → [Preferences] to open the [Setup] dialog box, then confirm that [TWAIN] is selected for [Device Driver] in the [Scan] tab.

- 3 Click the [Option] button.

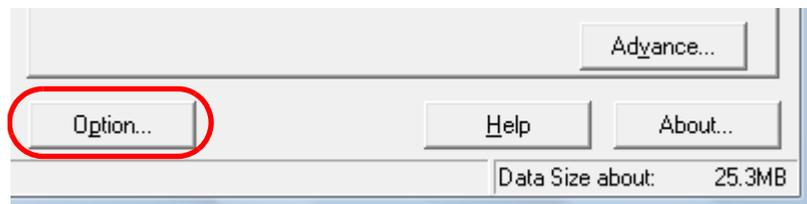

⇒ The [Option] dialog box appears.

- 4 Click the [Rotation] tab and select [Automatic] in the [Rotation Degree] drop-down list.

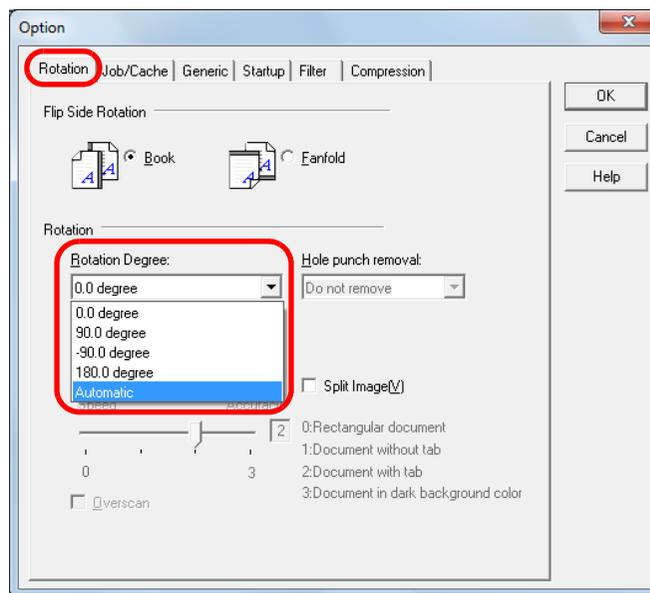

TOP

Contents

Index

Introduction

Scanner
OverviewHow to Load
DocumentsConfiguring the
Scan SettingsHow to Use the
Operator PanelVarious Ways to
Scan

Daily Care

Replacing the
Consumables

Troubleshooting

Operational
Settings

Appendix

Glossary



- The following types of documents may not be adjusted correctly because the page orientation is detected based on the characters printed on the document:
 - Documents scanned at a resolution of less than 200 dpi
 - Documents with many extremely large or small characters
 - Documents on which the pitches between lines or characters are extremely narrow, or characters are overlapped with each other
 - Documents with many photographs or figures and few characters
 - Documents with characters printed in various directions (e.g. drawings)
 - Documents written using only capital characters
 - Documents with handwritten characters
 - Skewed documents
 - Documents written in a language other than the supported languages: Japanese, English, French, German, Italian, Spanish, Chinese (Simplified and Traditional), Korean, Russian and Portuguese.
 - Documents with characters on patterned background
 - Documents with a complex layout
 - Documents with a large amount of image noise
- The language selected in the Windows [Regional and Language Options] is used for judging the text on the document.
- The image orientation may not be corrected properly depending on the scanner driver setting at scanning (e.g. dithering).
- If you cannot correct the image orientation properly, use the Edge Emphasis function of the driver to correct it.
- Shadows may remain on the edge of the scanned image.
- [Automatic] in [Rotation Degree] is available only when ScandAll PRO is installed.

- 5 Click the [OK] button.
⇒ It returns to the [TWAIN Driver (32)] dialog box.
- 6 Click the [OK] button in the [TWAIN Driver (32)] dialog box.
⇒ The settings are saved.
- 7 Scan the document by selecting the [Scan] menu → [Scan] in ScandAll PRO.

Splitting the Scanned Image in Two

Each page of the scanned image can be split horizontally into two separate pages.



This function may not work properly in some applications.

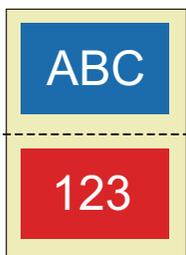

Original

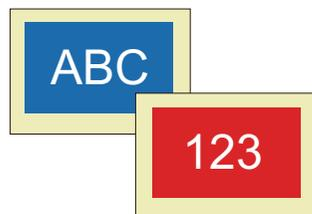

Output image

- 1 Load the document.
For details, refer to "[Chapter 2 How to Load Documents](#)" (page 37).
- 2 Start up ScandAll PRO and select the [Scan] menu → [Scanner Setting].
⇒ The [TWAIN Driver (32)] dialog box appears.



If the [TWAIN Driver (32)] dialog box does not appear, check the setting in ScandAll PRO by selecting the [Tool] menu → [Preferences] to open the [Setup] dialog box, then confirm that [TWAIN] is selected for [Device Driver] in the [Scan] tab.

- 3 Click the [Option] button.

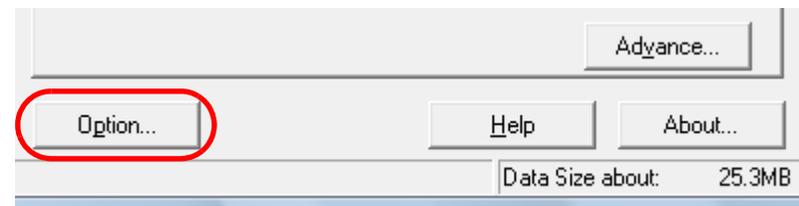

⇒ The [Option] dialog box appears.

- TOP
- Contents
- Index
- Introduction
- Scanner Overview
- How to Load Documents
- Configuring the Scan Settings
- How to Use the Operator Panel
- Various Ways to Scan**
- Daily Care
- Replacing the Consumables
- Troubleshooting
- Operational Settings
- Appendix
- Glossary

4 Click the [Rotation] tab and select the [Split Image] check box.

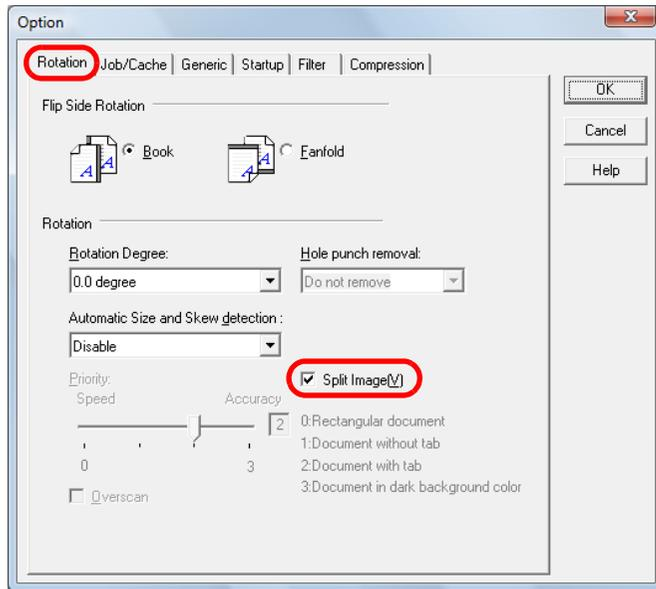

This option is not available with the following settings:

- Multi image output
- Auto color/monochrome detection
- Resolution set to 1200 dpi
- [Double-page spread], [Clipping (Front)] or [Clipping (Duplex)]



When scanning in duplex mode, the back of the image is output in the following order according to the [Flip Side Rotation] setting:

- Book: top → bottom
- Fanfold: bottom → top

5 Click the [OK] button.
⇒ It returns to the [TWAIN Driver (32)] dialog box.

6 Click the [OK] button in the [TWAIN Driver (32)] dialog box.
⇒ The settings are saved.

7 Scan the document by selecting the [Scan] menu → [Scan] in ScandAll PRO.

Using the Multi Image Output

"Multi image output" allows you to obtain both a color/grayscale image and a black & white image from a single scan.



This function may not work properly in some applications.

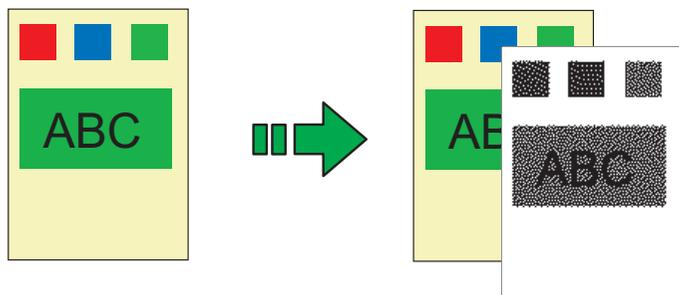

Original

Output image

Example: When a color document is scanned

- 1 Load the document.
For details, refer to "[Chapter 2 How to Load Documents](#)" (page 37).
- 2 Start up ScandAll PRO and select the [Scan] menu → [Scanner Setting].
⇒ The [TWAIN Driver (32)] dialog box appears.



If the [TWAIN Driver (32)] dialog box does not appear, check the setting in ScandAll PRO by selecting the [Tool] menu → [Preferences] to open the [Setup] dialog box, then confirm that [TWAIN] is selected for [Device Driver] in the [Scan] tab.

- 3 Select the [Enable Multi Image] check box.

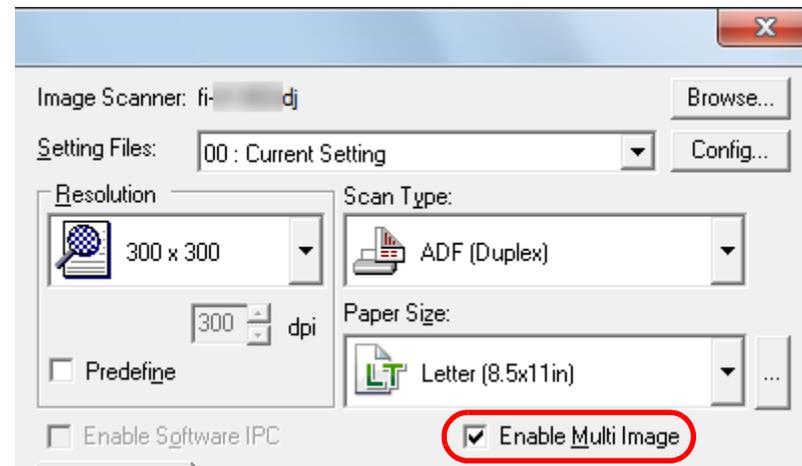

⇒ The [Multi Image] dialog box appears.

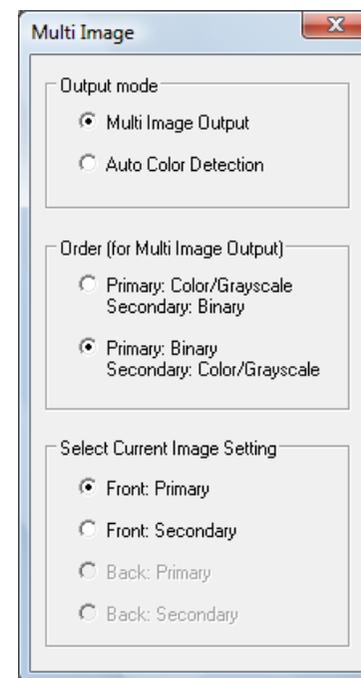

4 Select [Multi Image Output] for [Output mode].

5 In [Order (for Multi Image Output)], select the order in which the images are output.

Order	Description
Primary : Color/Grayscale Secondary : Binary	A color/grayscale image is output first, then a black & white image.
Primary : Binary Secondary : Color/Grayscale	A black & white image is output first, then a color/grayscale image.

6 Select a side in [Select Current Image Setting].
Configure the scan settings for [Primary] and then [Secondary] in the [TWAIN Driver (32)] dialog box.

7 Click the [OK] button in the [TWAIN Driver (32)] dialog box.
⇒ The settings are saved.

8 Scan the document by selecting the [Scan] menu → [Scan] in ScandAll PRO.

Automatically Detecting Color/Monochrome Documents

The color of the document can be automatically detected then output in color or grayscale for color documents, and in black & white for black & white documents.



This function may not work properly in some applications.

- 1 Load the documents.
For details, refer to "Chapter 2 How to Load Documents" (page 37).
- 2 Start up ScandAll PRO and select the [Scan] menu → [Scanner Setting].
⇒ The [TWAIN Driver (32)] dialog box appears.



If the [TWAIN Driver (32)] dialog box does not appear, check the setting in ScandAll PRO by selecting the [Tool] menu → [Preferences] to open the [Setup] dialog box, then confirm that [TWAIN] is selected for [Device Driver] in the [Scan] tab.

- 3 Select the [Enable Multi Image] check box.

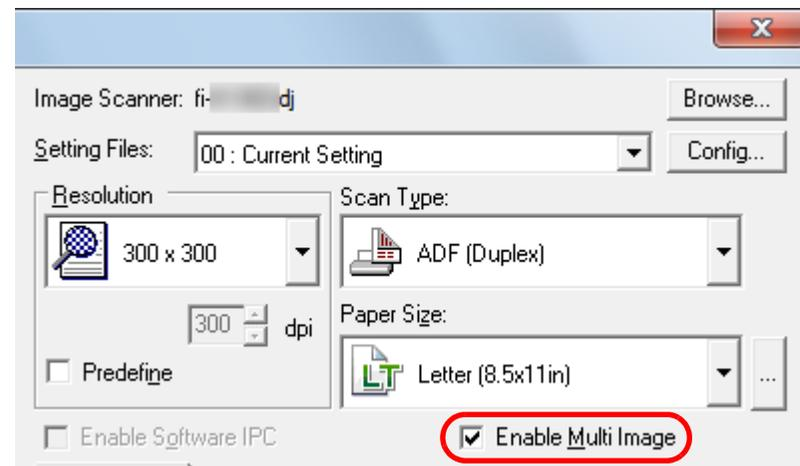

⇒ The [Multi Image] dialog box appears.

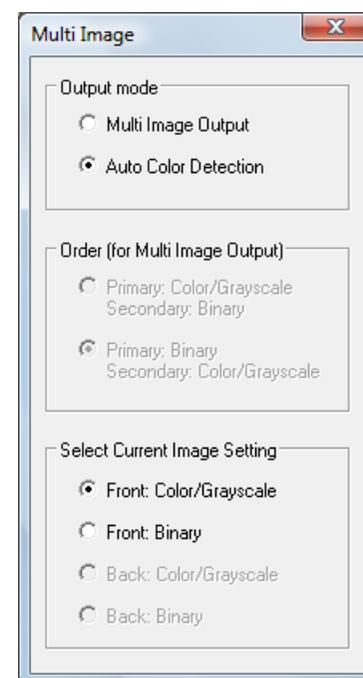

4 Select [Auto Color Detection] for [Output mode].

5 Select a side in [Select Current Image Setting].

You need to pre-configure the scan settings for each case when the document is recognized as [Color/Grayscale] or [Binary].

Configure the scan settings in the [TWAIN Driver (32)] dialog box.

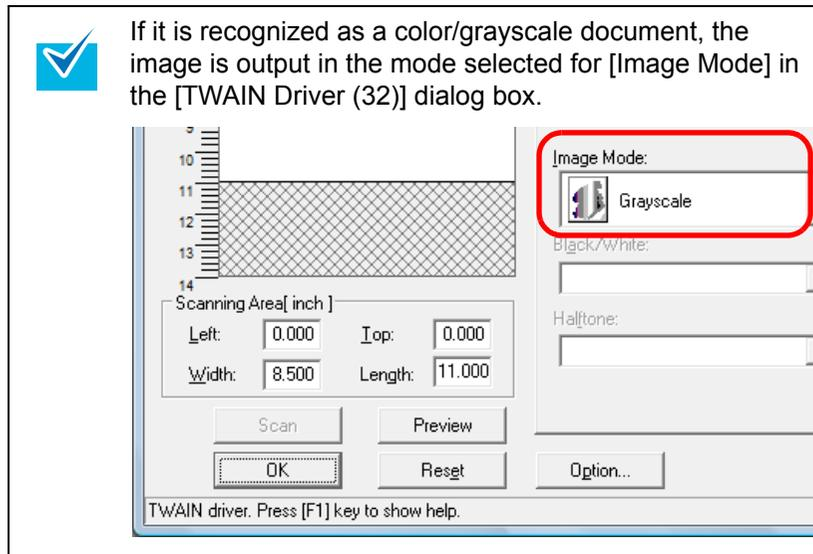

6 Click the [OK] button in the [TWAIN Driver (32)] dialog box.

⇒ The settings are saved.

7 Scan the document by selecting the [Scan] menu → [Scan] in ScandAll PRO.

5.5 Customizing the Scanner Settings

Using a Button on the Scanner to Start Scanning

The [Scan/Stop] and [Send to] buttons on the operator panel can be configured to perform scanning by simply pressing one of these buttons.

To configure this setting, you first need to assign an application to be launched from each button.

Computer setup

- 1 Confirm that the scanner is connected to the computer, then turn on the scanner.
⇒ For details, refer to “Connecting the Cables” in Getting Started.
- 2 Select the [Start] menu → [Control Panel].
⇒ The [Control Panel] dialog box appears.
- 3 Click [View devices and printers].
⇒ The [Devices and Printers] dialog box appears.
- 4 Right-click on the scanner icon, and select [Scan properties] from the displayed menu.
⇒ The properties dialog box of the scanner appears.

- 5 Click the [Events] tab and select an event.
From the [Select an event] drop-down list, select an event from which you want to launch an application.

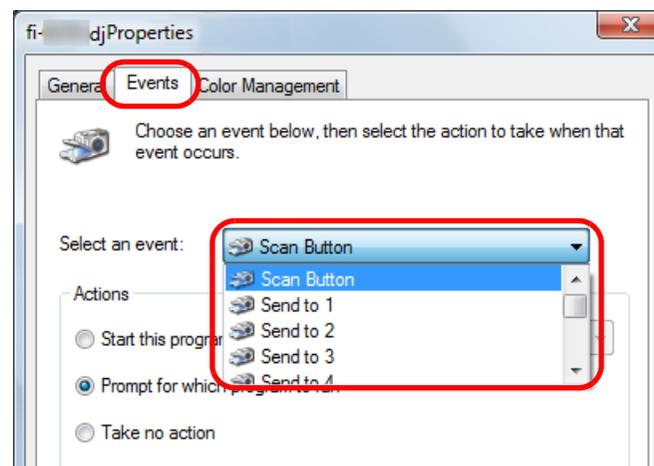

In this function, the following events can be specified:

- [Scan Button] (press the [Scan/Stop] button)
- [Send to 1] to [Send to 9] (press the [Send to] button while a number from 1 to 9 is displayed on the Function Number Display)

6 Select an action and an application to be launched by the scanner button event.

Click [Start this program] under [Actions], and select an application from the drop-down list on the right.

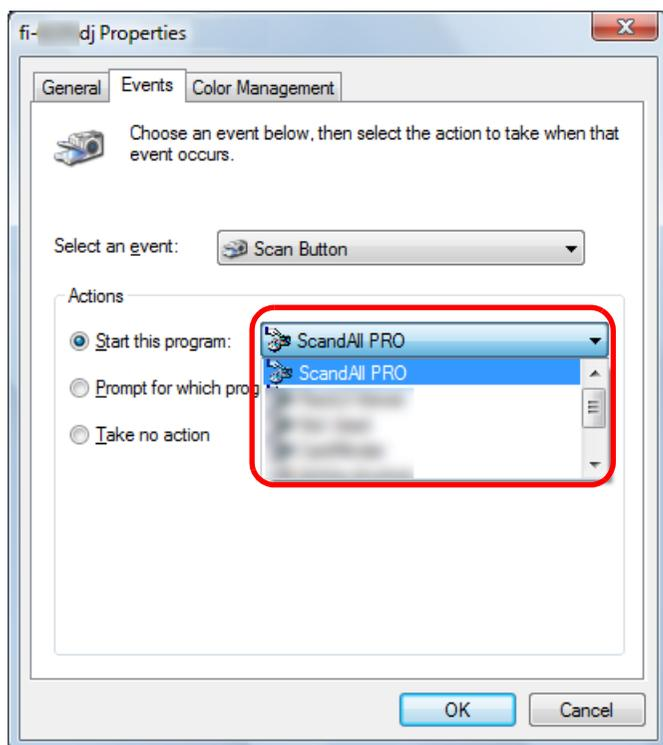

7 Click the [OK] button.

If you are using ScandAll PRO, refer to "ScandAll PRO V2.0 User's Guide".

If you are using an application other than ScandAll PRO, the setup of the computer is completed here. Proceed to configure the scanner settings.



- The windows that appear and the operations differ by the operating system that you are using.
- To configure multiple buttons, repeat steps 4 to 7.

Scanner setup

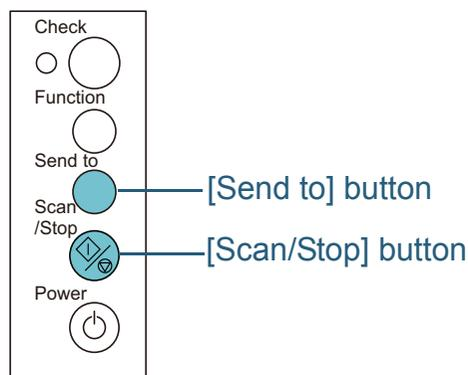

- [Scan/Stop] button
No particular setting is required.
⇒ The specified application is launched when you press the [Scan/Stop] button.
- [Send to] button
Press the [Function] button to change the number displayed on the Function Number Display.
Make this number match with the scanner button event configured in the computer ([Send to 1] to [Send to 9]).
For example, select "2" on the Function Number Display to perform the action configured for [Send to 2].
⇒ The specified application is launched when you press the [Send to] button.



- For details about the operator panel, refer to "[Chapter 4 How to Use the Operator Panel](#)" (page 63).
- The number on the Function Number Display will change in the following order: 1, 2, 3, ... 9, C, 1, 2, 3...
Numbers 1 to 9 correspond to the scanner button events from "Send to 1" to "Send to 9" configured in the computer. "C" corresponds to the Software Operation Panel (fixed setting).

Detecting Multifeed Errors

Multifeed is an error where two or more sheets are fed through the ADF at once. It is also called a multifeed when a different document length is detected.

You can have an error message appear when a multifeed occurs.

Settings for multifeed detection can be configured in the scanner driver or the Software Operation Panel.

For details about this setting in the Software Operation Panel, refer to "[Specifying a Multifeed Detection Method \[Multifeed\]](#)" (page 180).

- 1 Load the documents in the ADF paper chute.
For details, refer to "[Chapter 2 How to Load Documents](#)" (page 37).
- 2 Start up ScandAll PRO and select the [Scan] menu → [Scanner Setting].
⇒ The [TWAIN Driver (32)] dialog box appears.



If the [TWAIN Driver (32)] dialog box does not appear, check the setting in ScandAll PRO by selecting the [Tool] menu → [Preferences] to open the [Setup] dialog box, then confirm that [TWAIN] is selected for [Device Driver] in the [Scan] tab.

- 3 Click the [Option] button.

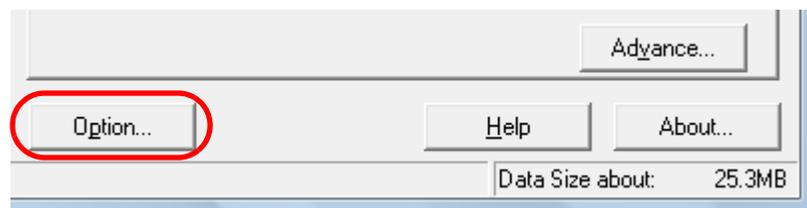

⇒ The [Option] dialog box appears.

- 4 Click the [Job/Cache] tab and specify the detection method in the [Multifeed Detection] drop-down list under [ADF Option].

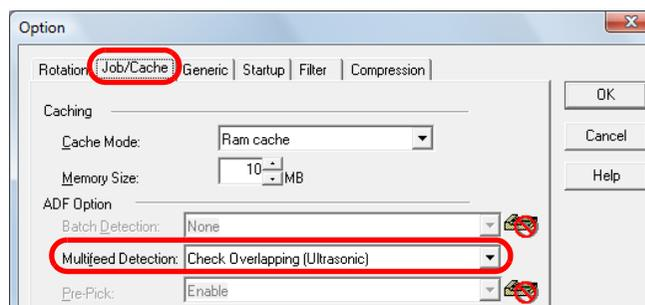

The following are the conditions of detecting multifeeds.

Condition	Description
None	Does not detect multifeed.
Hardware Setting	Enables the setting of the Software Operation Panel.
Check Overlapping (Ultrasonic)	Uses the ultrasonic sensors inside the ADF to monitor the documents during feeding and to identify multifeeds according to the deviation of the reflected ultrasonic waves.
Check length	Monitors the document length during feeding, and identifies multifeeds according to the deviation of detected lengths. Note that multifeeds cannot be detected accurately when scanning a mixed batch of different sizes.
Check Overlapping and length	Monitors both document overlapping and length to detect multifeeds. Note that multifeeds cannot be detected accurately when scanning a mixed batch of different sizes.

For more details about multifeed detection, refer to "[Conditions for Multifeed Detection](#)" (page 45).

- 5** Click the [OK] button.
⇒ It returns to the [TWAIN Driver (32)] dialog box.
- 6** Click the [OK] button in the [TWAIN Driver (32)] dialog box.
⇒ The settings are saved.
- 7** Scan the document by selecting the [Scan] menu → [Scan] in ScandAll PRO.

TOP

Contents

Index

Introduction

Scanner
Overview

How to Load
Documents

Configuring the
Scan Settings

How to Use the
Operator Panel

Various Ways to
Scan

Daily Care

Replacing the
Consumables

Troubleshooting

Operational
Settings

Appendix

Glossary

Ignoring Multifeed for a Set Pattern

If you attempt to scan a document with a sticky note, receipt, or photo attached while multifeed detection is enabled, the scanner may falsely recognize this as a multifeed error and stop the scan. To scan these types of documents, the "Intelligent Multifeed Function" is available.

There are two modes in this function. In one mode, you can suppress multifeeds forcibly by using the operator panel on the scanner. In the other mode, you can suppress multifeeds automatically by letting the scanner memorize the location and the length of the attachment.

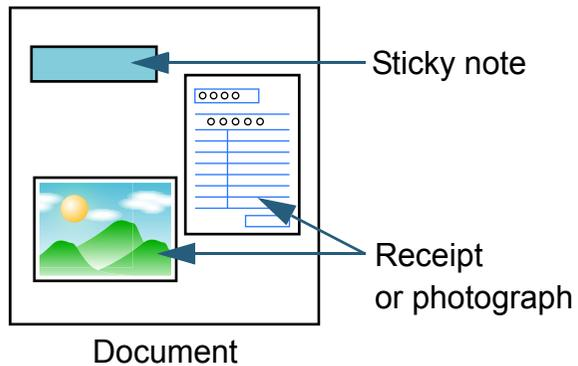

Intelligent Multifeed function

The following three modes are available:

Mode	Description
Manual mode (Bypass by front panel button)	Checks for any paper attached every time a multifeed occurs, and continues scanning.
Auto mode 1 (Bypass by combination of length and position)	Used to scan documents with paper of the same size attached in the same location.
Auto mode 2 (Bypass by length)	Used to scan documents with paper of different sizes attached in different locations.



Irregular images may be output when multifeeds occur.

The mode can be selected in the Software Operation Panel. For details, refer to "[Specifying an Area Not to Detect Multifeed \[Intelligent Multifeed Function\]](#)" (page 185).

Preparation before using this function

- 1 Start up ScandAll PRO, and select the [Scan] menu → [Scanner Setting].

⇒ The [TWAIN Driver (32)] dialog box appears.



If the [TWAIN Driver (32)] dialog box does not appear, check the setting in ScandAll PRO by selecting the [Tool] menu → [Preferences] to open the [Setup] dialog box, then confirm that [TWAIN] is selected for [Device Driver] in the [Scan] tab.

- 2 Click the [Option] button.

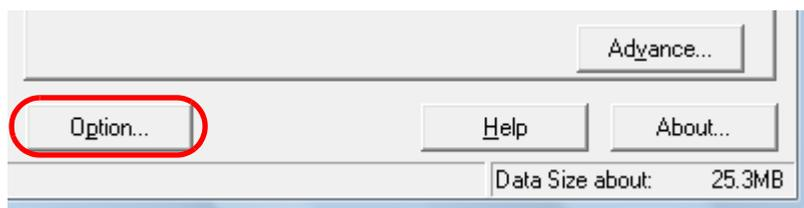

⇒ The [Option] dialog box appears.

- 3 Select the [Job/Cache] tab, and select [Check Overlapping (Ultrasonic)] or [Check Overlapping and length] for [Multifeed Detection] under [ADF Option].

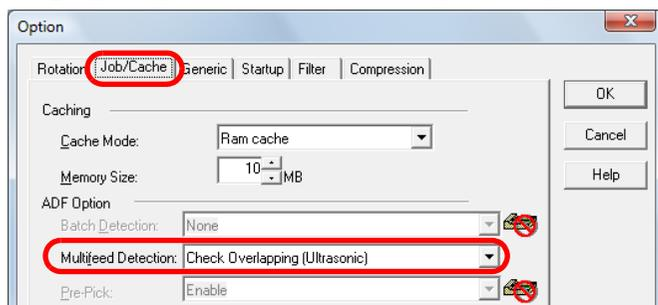

- 4 Click the [OK] button.

⇒ It returns to the [TWAIN Driver (32)] dialog box.

- 5 Click the [OK] button in the [TWAIN Driver (32)] dialog box.

⇒ The settings are saved.

Operational procedure

- 1 After a multifeed error occurs, either press the [Send to] button to eject the document from the paper path or open the ADF to remove the document.

- 2 Close the ADF.

For details, refer to "1.4 Opening/Closing the ADF" (page 24).

When you close the ADF, indication on the Function Number Display changes as follows.

- Alternates between "J" and "2" when a multifeed is detected.
- The function number flashes when ejecting the documents.



Confirm that the ADF is closed properly. Otherwise, the document may not be fed into the ADF.

- 3 Load the documents back in the ADF paper chute.

If a multifeed by difference in length is detected, either press the [Scan/Stop] button or perform a scan from the computer (do not press the [Function] button). If there is an attachment which is likely to be the cause of the multifeed error, then proceed to the next step.

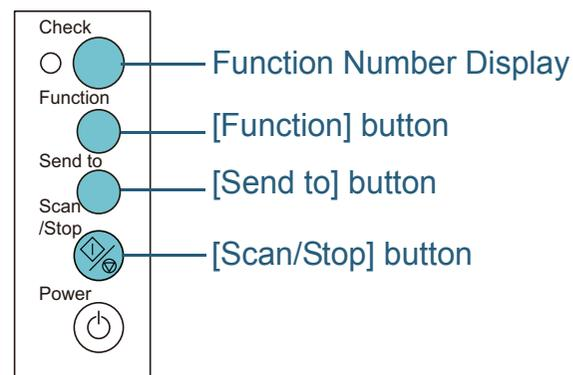

TOP
Contents
Index
Introduction
Scanner Overview
How to Load Documents
Configuring the Scan Settings
How to Use the Operator Panel
Various Ways to Scan
Daily Care
Replacing the Consumables
Troubleshooting
Operational Settings
Appendix
Glossary

- 4** Press the [Function] button and confirm that the function number is flashing faster, and then either press the [Scan/Stop] button or perform a scan from the computer.

From this point, note that the flashing speed of the Function Number Display switches between "slow" ↔ "fast" every time you press the [Function] button. When the flashing speed is fast, the scanner operates in each mode as follows:



Do not hold down the [Function] button for more than 5 seconds when switching the flashing speed, because it may erase the memorized multifeed patterns.

- Manual mode (Bypass by front panel button)
Scans the next sheet without multifeed detection, and from the second sheet, multifeeds are detected based on the setting configured in the scanner driver or the Software Operation Panel.
- Auto mode 1 (Bypass by combination of length and position)
Memorizes the length and location of the paper attachment that was detected as multifeed, and continues scanning. When a paper attachment of a similar pattern is detected, multifeed detection is automatically suppressed. (*1)(*2)
- Auto mode 2 (Bypass by length)
Memorizes the length of the longest paper attachment that was detected as multifeed, and continues scanning. When a paper attachment of the same length or shorter is detected, multifeed detection is automatically suppressed. (*1)(*2)
 - *1: 32 pages (up to 4 attachments per page) worth of overlap patterns can be memorized in this mode. When it exceeds this limit, the first pattern that was memorized is erased from the memory.
 - *2: To erase the memorized overlap patterns and the longest overlap length, hold down the [Function] button for more than 5 seconds while the function number is flashing. The Function Number Display will then display "□". This allows you to erase multifeed patterns and the longest overlap length that were not supposed to be memorized. Be careful with this operation because all memorized patterns will be erased.

Chapter 6 Daily Care

This chapter describes how to clean the scanner.



Do not use aerosol spray or spray that contains alcohol to clean the scanner. Dust blown up by strong air from the spray may enter inside the scanner which may cause the scanner to fail or malfunction.
Also note that sparks generated by static electricity may cause a fire.



The glasses inside the ADF become very hot when the scanner is being used.
Before you start cleaning the inside, make sure to turn off the power, unplug the power cable and wait at least 15 minutes for the ADF glass to cool down.

6.1 Cleaning Materials and Locations that Require Cleaning.....	109
6.2 Cleaning the Outside	110
6.3 Cleaning the Inside.....	111
6.4 Cleaning the Carrier Sheet	116

6.1 Cleaning Materials and Locations that Require Cleaning

Cleaning Materials

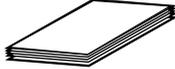
Name	Part No.	Notes
Cleaner F1 	PA03950-0352	100 ml Moisten a cloth or Cleaning Paper with this liquid to wipe the scanner clean. It may take a long time to dry if an excessive amount is used. Use it in small quantity. Wipe off the cleaner completely to leave no residue on the cleaned parts.
Cleaning Paper 	CA99501-0012	10 sheets Use this non-woven sheet with Cleaner F1.
Cleaning Wipe 	PA03950-0419	24 packets Pre-moistened with Cleaner F1. It can be used instead of moistening a cloth with Cleaner F1.
Cotton swab	Commercially available	
Dry cloth		



In order to use the cleaning materials safely and correctly, read the precautions on each product thoroughly.

For more information about the cleaning materials, contact your FUJITSU scanner dealer or an authorized FUJITSU scanner service provider.

Location and Frequency

Location		Frequency
ADF	Brake roller	Every 5,000 sheets
	Pick roller	
	Idler roller	
	Glass	
	Ultrasonic sensor	
	Feed roller	
	Eject roller	
Flatbed (fi-6230Z/ fi-6240Z)	Document pad	
	Document bed	
	Plastic frame	



Cleaning cycles may vary depending on the condition of the documents. Also, cleaning must be performed more frequently when the following types of documents are scanned:

- Smooth-faced documents such as coated paper
- Documents with printed text/graphics that almost cover the entire surface
- Chemically-treated documents such as carbonless paper
- Documents containing a large amount of calcium carbonate
- Documents written in lead pencil
- Documents on which the toner is not sufficiently fused

TOP

Contents

Index

Introduction

Scanner
OverviewHow to Load
DocumentsConfiguring the
Scan SettingsHow to Use the
Operator PanelVarious Ways to
Scan

Daily Care

Replacing the
Consumables

Troubleshooting

Operational
Settings

Appendix

Glossary

6.2 Cleaning the Outside

The outside of the scanner, including the ADF paper chute and the stacker, should be cleaned with either a piece of dry cloth, a cloth moistened with Cleaner F1/mild detergent, or a sheet of Cleaning Wipe.



- Never use paint thinner or any other organic solvents because it may result in deformation or discoloration.
- Be careful not to let any moisture or water inside the scanner during cleaning.
- It may take a long time to dry if an excessive amount of Cleaner F1/mild detergent is used. Use it in small quantity. Wipe off the cleaner completely to leave no residue on the cleaned parts.

fi-6130Z/fi-6140Z

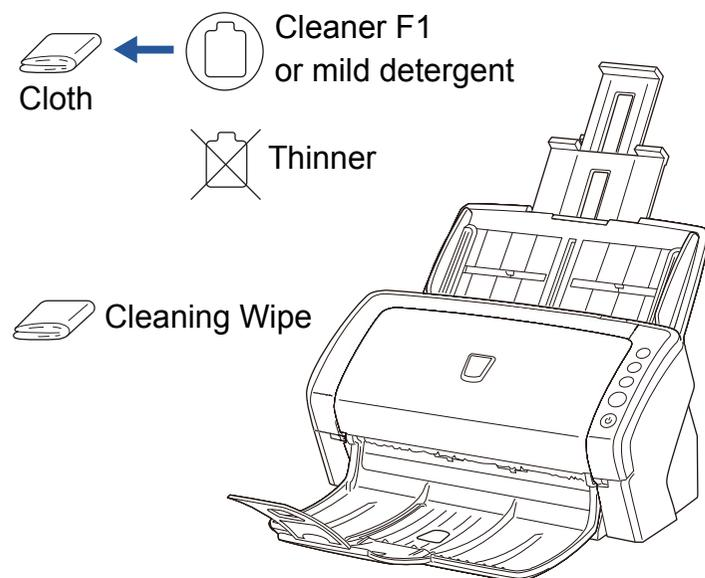

fi-6230Z/fi-6240Z

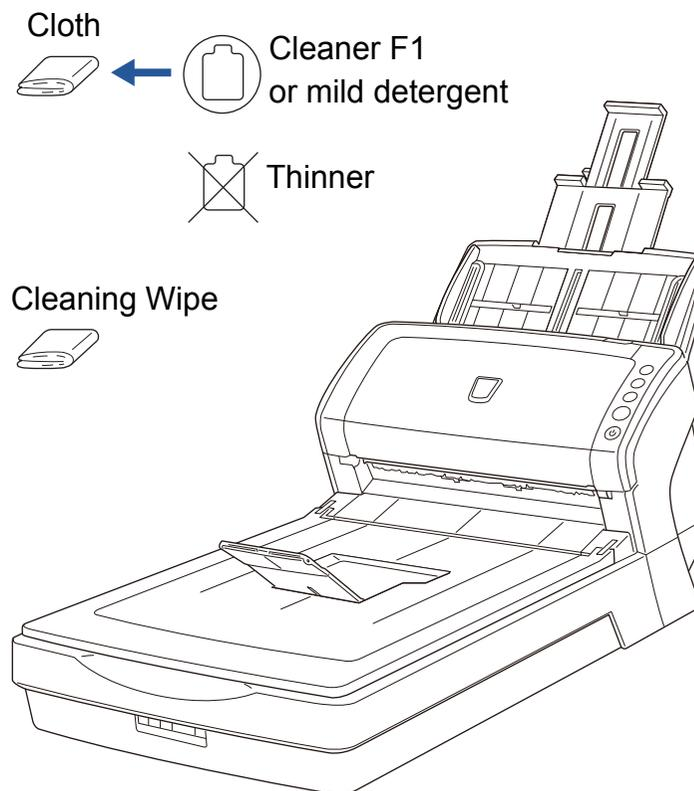

TOP

Contents

Index

Introduction

Scanner
OverviewHow to Load
DocumentsConfiguring the
Scan SettingsHow to Use the
Operator PanelVarious Ways to
Scan

Daily Care

Replacing the
Consumables

Troubleshooting

Operational
Settings

Appendix

Glossary

6.3 Cleaning the Inside

Cleaning the ADF (with Cleaning Paper)

The ADF can be cleaned with a sheet of Cleaning Paper moistened with Cleaner F1.

As the scanner continues to feed the documents, paper dust will accumulate inside the ADF and it may cause scanning errors.

Cleaning should be performed approximately every 5,000 sheets scanned. Note that this guideline varies depending on the types of documents you scan. For instance, it may be necessary to clean the scanner more frequently when you scan documents on which the toner is not sufficiently fused.



- Do not use water or mild detergent to clean the ADF.
- It may take a long time to dry if an excessive amount of Cleaner F1 is used. Use it in small quantity.

- 1 Turn on the scanner.
For details, refer to ["1.3 Turning the Power ON/OFF" \(page 23\)](#).
- 2 Spray the Cleaning Paper with Cleaner F1.
- 3 Pull out the chute extensions according to the length of the Cleaning Paper.
For details, refer to ["1.6 Setting Up the ADF Paper Chute" \(page 26\)](#).
- 4 Lift the stacker and stacker extension according to the length of the Cleaning Paper.
For details, refer to ["1.7 Setting Up the Stacker" \(page 27\)](#).

- 5 Load the Cleaning Paper in the ADF paper chute.

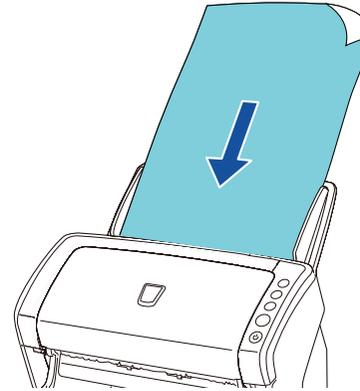

- 6 Adjust the side guides to the width of the Cleaning Paper. Do not leave space between the side guides and the Cleaning Paper. Otherwise, the Cleaning Paper may be fed skewed.

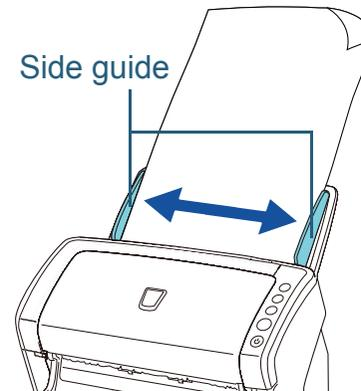

- 7 Start up an application for scanning and perform a scan.
For details about the scanning procedure in ScandAll PRO, refer to ["ScandAll PRO V2.0 User's Guide"](#).

TOP

Contents

Index

Introduction

Scanner
OverviewHow to Load
DocumentsConfiguring the
Scan SettingsHow to Use the
Operator PanelVarious Ways to
Scan

Daily Care

Replacing the
Consumables

Troubleshooting

Operational
Settings

Appendix

Glossary

Cleaning the ADF (with cloth)

The ADF can be cleaned with a piece of cloth moistened with Cleaner F1, or a sheet of Cleaning Wipe.

As the scanner continues to feed the documents, paper dust will accumulate inside the ADF and it may cause scanning errors.

Cleaning should be performed approximately every 5,000 sheets scanned. Note that this guideline varies depending on the types of documents you scan. For instance, it may be necessary to clean the scanner more frequently when you scan documents on which the toner is not sufficiently fused.



The glasses inside the ADF become very hot when the scanner is being used. Before you start cleaning the inside, make sure to turn off the power, unplug the power cable and wait at least 15 minutes for the ADF glass to cool down.



- Do not use water or mild detergent to clean the ADF.
- It may take a long time to dry if an excessive amount of Cleaner F1 is used. Use it in small quantity. Wipe off the cleaner completely to leave no residue on the cleaned parts.

1 Turn off the scanner and wait for at least 15 minutes. For details, refer to "1.3 Turning the Power ON/OFF" (page 23).

2 Open the ADF. For details, refer to "1.4 Opening/Closing the ADF" (page 24).



Be careful not to have your fingers caught when the ADF closes.

3 Clean the following locations with a cloth moistened with Cleaner F1 or a sheet of Cleaning Wipe.

Glass (×2)

Ultrasonic sensor (×2)

Brake roller (×2)

Feed roller (×2)

Eject roller (×2)

Pick roller (×2)

Idler roller (×4)

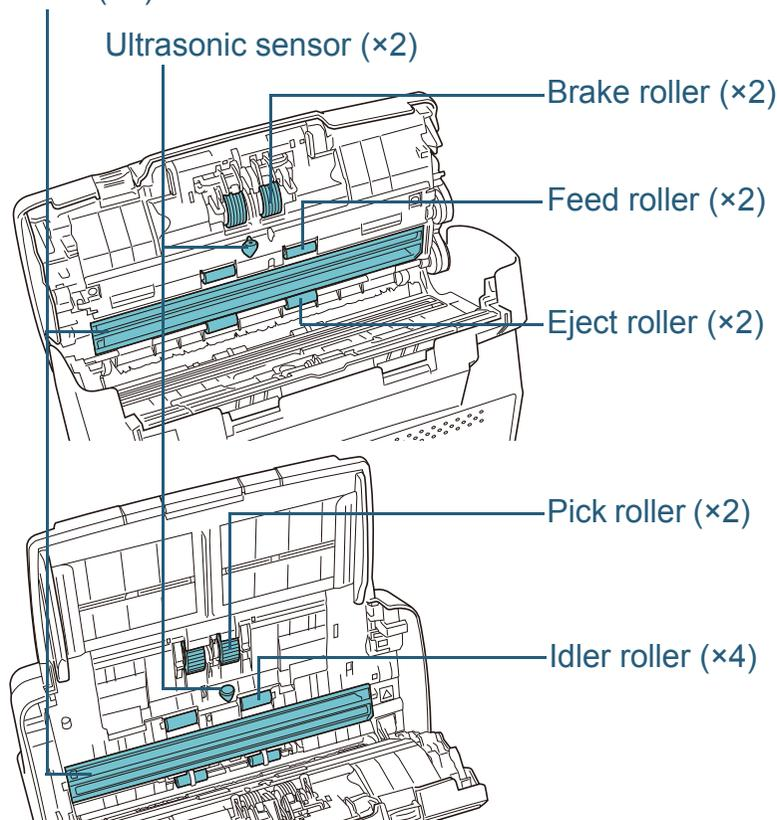

Make sure that the cloth does not get caught and damage the document sensors.

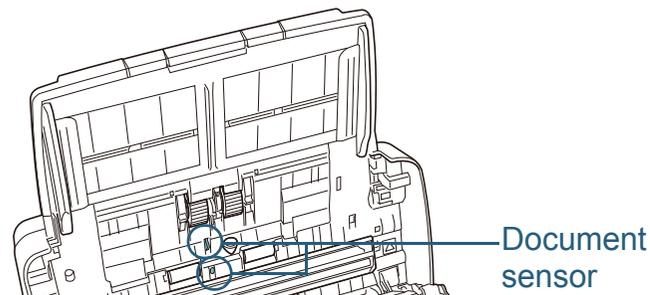

TOP

Contents

Index

Introduction

Scanner
OverviewHow to Load
DocumentsConfiguring the
Scan SettingsHow to Use the
Operator PanelVarious Ways to
Scan

Daily Care

Replacing the
Consumables

Troubleshooting

Operational
Settings

Appendix

Glossary

Brake roller (×2)

Remove the roller from the scanner.

For details about removing the brake roller, refer to ["7.2 Replacing the Brake Roller"](#) (page 119).

Gently wipe along the grooves, taking care not to damage the roller surface.

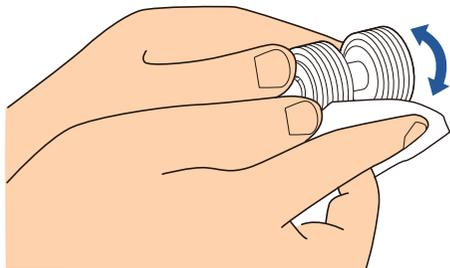
**Pick roller (×2)**

Gently wipe along the grooves as you rotate the roller manually, taking care not to damage the roller surface. Make sure that it is cleaned properly because residue on the roller will affect the feeding performance.

Idler roller (×4)

Gently wipe the surface of the rollers. Make sure that it is cleaned properly because residue on the roller will affect the feeding performance. Also be careful not to damage the sponge which is attached on each roller.

Glass (×2)

Gently wipe the dirt and dust off the surface of the glass sections.



Vertical streaks may appear on the scanned image when the glass is dirty.

Ultrasonic sensor (×2)

Gently wipe the dirt and dust off the surface of the ultrasonic sensors.

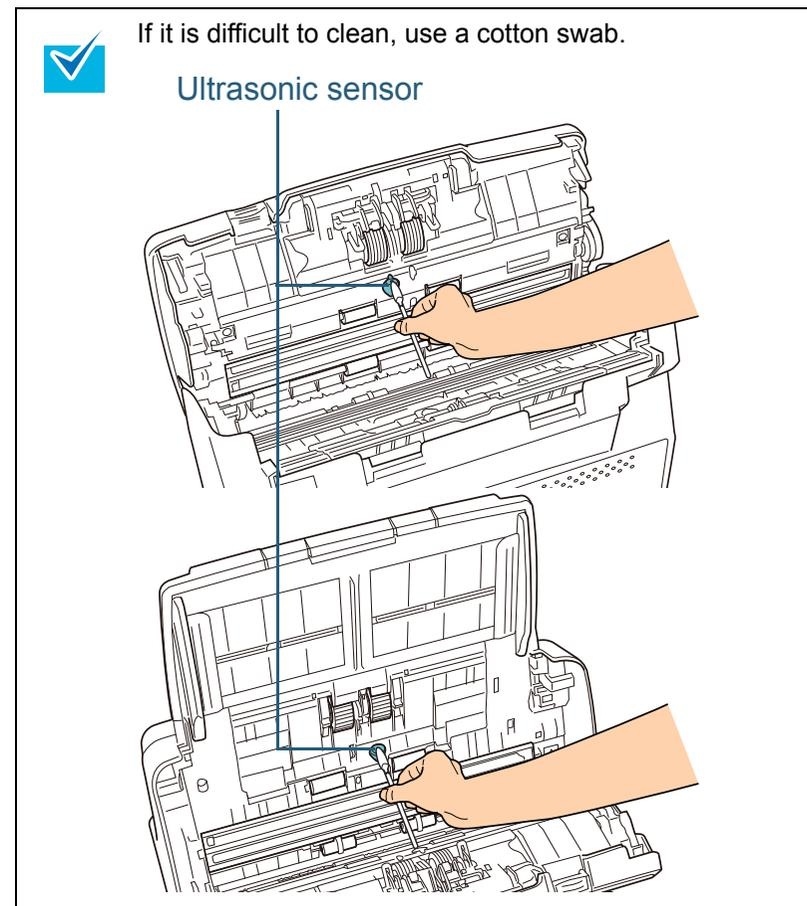
**Feed roller (×2) / Eject roller (×2)**

The power must be turned on to rotate the feed/eject rollers.

- 1 Turn on the scanner.
For details, refer to ["1.3 Turning the Power ON/OFF"](#) (page 23).
- 2 Open the ADF when "1" is displayed on the Function Number Display.
For details, refer to ["1.4 Opening/Closing the ADF"](#) (page 24).

- 3 When you press the [Send to] and [Scan/Stop] buttons at the same time, the feed/eject rollers rotate a certain amount.

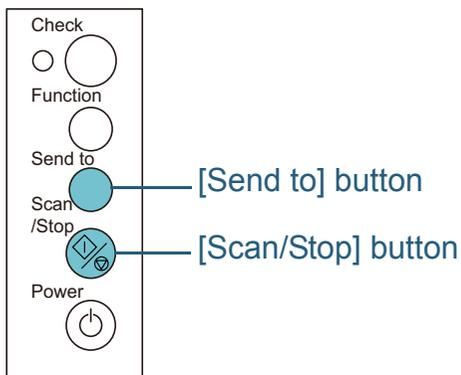



CAUTION Be careful not to touch the rollers with your hand while they are rotating.

- 4 Put a piece of cloth moistened with Cleaner F1 or a sheet of Cleaning Wipe against the roller surface, and wipe horizontally. Wipe the whole surface by pressing the [Send to] and [Scan/Stop] buttons at the same time to rotate the rollers. Make sure that it is cleaned properly because residue on the roller will affect the feeding performance. As a guideline, pressing the [Send to] and [Scan/Stop] buttons seven times will rotate the feed/eject rollers one revolution.

4 Close the ADF.

For details, refer to "[1.4 Opening/Closing the ADF](#)" (page 24).



Confirm that the ADF is closed properly. Otherwise, the document may not be fed into the ADF.

- TOP
- Contents
- Index
- Introduction
- Scanner Overview
- How to Load Documents
- Configuring the Scan Settings
- How to Use the Operator Panel
- Various Ways to Scan
- Daily Care**
- Replacing the Consumables
- Troubleshooting
- Operational Settings
- Appendix
- Glossary

Cleaning the Flatbed (fi-6230Z/fi-6240Z)

The flatbed should be cleaned with a piece of cloth moistened with Cleaner F1, or a sheet of Cleaning Wipe.

- 1 Open the document cover.
For details, refer to "1.5 Opening/Closing the Document Cover (fi-6230Z/fi-6240Z)" (page 25).
- 2 Clean the following locations with a cloth moistened with Cleaner F1 or a sheet of Cleaning Wipe.

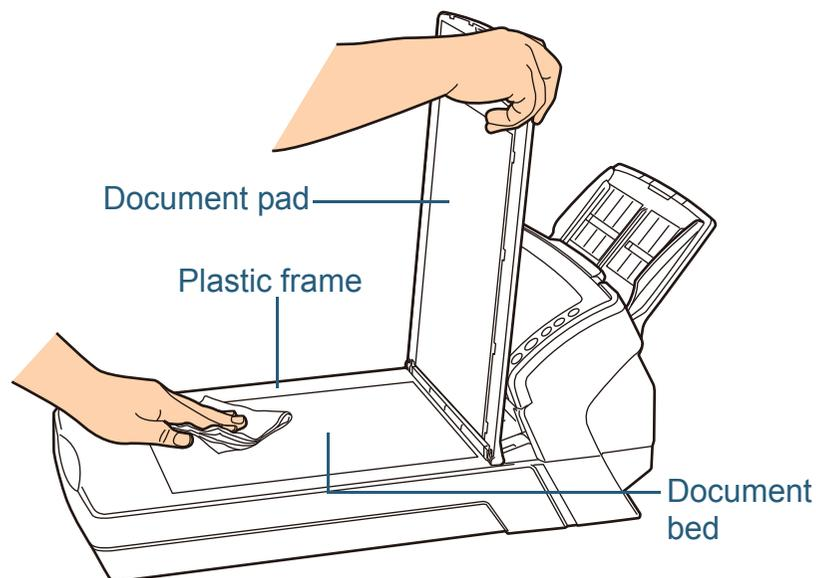

Be careful not to let the cleaner in between the document bed and the plastic frame.

- 3 Wait for the cleaned parts to dry.
- 4 Close the document cover.
For details, refer to "1.5 Opening/Closing the Document Cover (fi-6230Z/fi-6240Z)" (page 25).

6.4 Cleaning the Carrier Sheet

The Carrier Sheet should be cleaned with either a piece of dry cloth, a cloth moistened with Cleaner F1, or a sheet of Cleaning Wipe.

Gently wipe the dirt and dust off the surface and the inside of the Carrier Sheet.

As you keep using the Carrier Sheet, dirt and dust will accumulate on the surface and the inside.

Clean it regularly because it may result in scanning errors.



- To avoid deformation and discoloration, never use paint thinner or any other organic solvents.
- Do not use force to rub against the Carrier Sheet because it may be damaged or deformed.
- After cleaning the inside, do not close the Carrier Sheet until it is completely dry.
- The Carrier Sheet should be replaced approximately every 500 scans.

For information on purchasing the Carrier Sheet, contact your FUJITSU scanner dealer or an authorized FUJITSU scanner service provider.

[TOP](#)[Contents](#)[Index](#)[Introduction](#)[Scanner Overview](#)[How to Load Documents](#)[Configuring the Scan Settings](#)[How to Use the Operator Panel](#)[Various Ways to Scan](#)[Daily Care](#)[Replacing the Consumables](#)[Troubleshooting](#)[Operational Settings](#)[Appendix](#)[Glossary](#)

Chapter 7 Replacing the Consumables

This chapter describes how to replace the consumables for the scanner.

	<ul style="list-style-type: none">• The glasses inside the ADF become very hot when the scanner is being used.• Before you replace the consumables, make sure to turn off the power, unplug the power cable and wait at least 15 minutes for the ADF glass to cool down.
	
	

7.1 Consumables and Replacement Cycles.....	118
7.2 Replacing the Brake Roller.....	119
7.3 Replacing the Pick Roller	121

7.1 Consumables and Replacement Cycles

The following table shows the consumables used for the scanner.

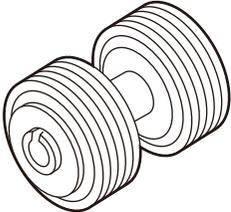
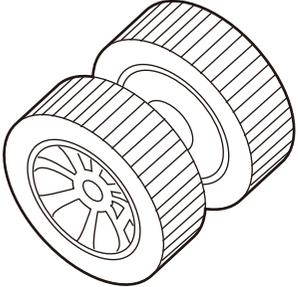
Name	Part No.	Suggested replacement cycle
BRAKE ROLLER 	PA03540-0001	200,000 sheets or one year
PICK ROLLER 	PA03540-0002	200,000 sheets or one year

Consumables need to be replaced periodically. It is recommended that you keep a stock of new consumables and replace them before it reaches the end of the consumable life.

The scanner records the page count (number of sheets scanned) after replacing the consumables, which allows you to check the status on each consumable (See ["9.4 Settings Related to Page Counters"](#) (page 166)).

Note that the suggested replacement cycles are guidelines for using A4 (80 g/m² [20 lb]) wood-free or wood-containing paper, as these cycles vary depending on the type of documents scanned and how often the scanner is used and cleaned.



Only use the specified consumables.

To purchase the consumables, contact your FUJITSU scanner dealer or an authorized FUJITSU scanner service provider.

7.2 Replacing the Brake Roller

Replace the brake roller in following procedure.

- 1 Remove all documents from the ADF paper chute.
- 2 Open the ADF.
For details, refer to "1.4 Opening/Closing the ADF" (page 24).



Be careful not to have your fingers caught when the ADF closes.

- 3 Remove the brake roller.
 - 1 Hold both ends of the cover, and open it in the direction of the arrow.

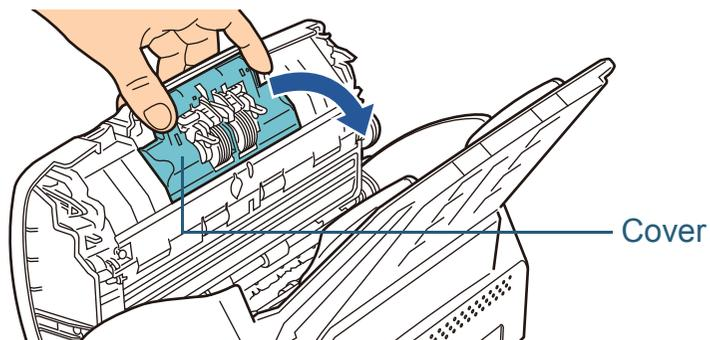

- 2 Lift the right side of the roller first, then pull out the shaft from the slot on the left.

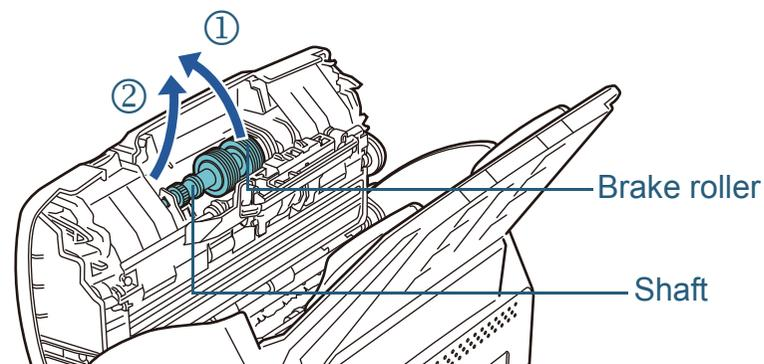

- 4 Remove the brake roller from its shaft.

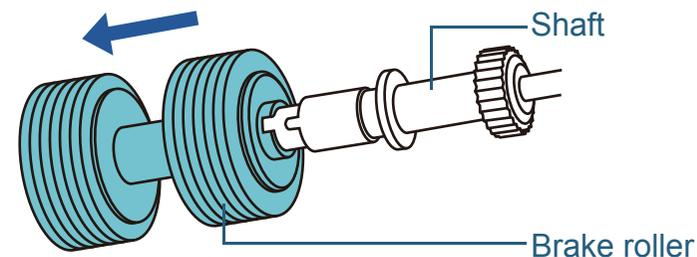

- 5 Attach a new brake roller on the shaft.
Insert the protrusion on the shaft into the slot.

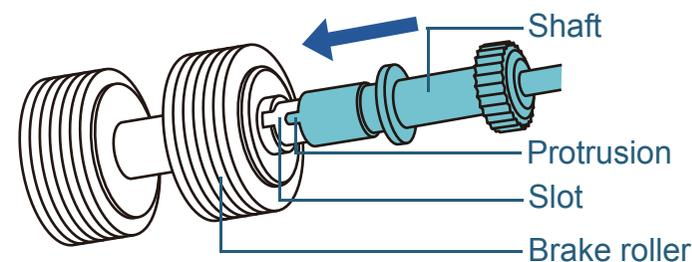

TOP

Contents

Index

Introduction

Scanner
OverviewHow to Load
DocumentsConfiguring the
Scan SettingsHow to Use the
Operator PanelVarious Ways to
Scan

Daily Care

Replacing the
Consumables

Troubleshooting

Operational
Settings

Appendix

Glossary

6 Attach the shaft.

- 1 Insert the shaft from the slot on the left side.

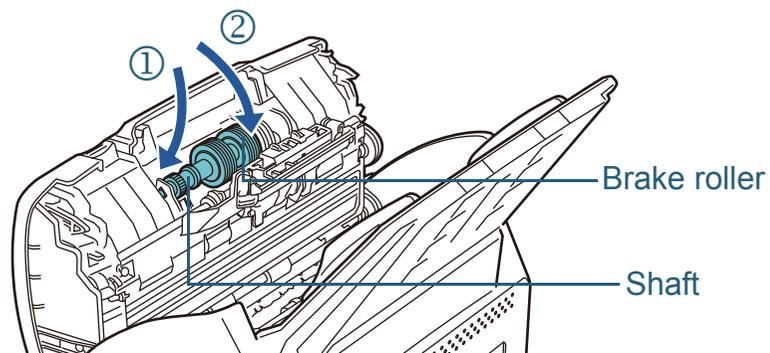

- 2 Close the cover.



Confirm that the brake roller is installed properly. Otherwise, it may cause feeding errors such as paper jams.

7 Close the ADF.

For details, refer to ["1.4 Opening/Closing the ADF" \(page 24\)](#).



Be careful not to have your fingers caught when the ADF closes.

8 Reset the consumable counter.

Start up the Software Operation Panel and reset the counter.

For details, refer to ["Resetting the counters" \(page 167\)](#).

7.3 Replacing the Pick Roller

Replace the pick roller in following procedure.

- 1 Remove all documents from the ADF paper chute.
- 2 Remove the ADF paper chute.
Hold both ends of the ADF paper chute, and lift ① then pull it out ② in the direction of the arrow.

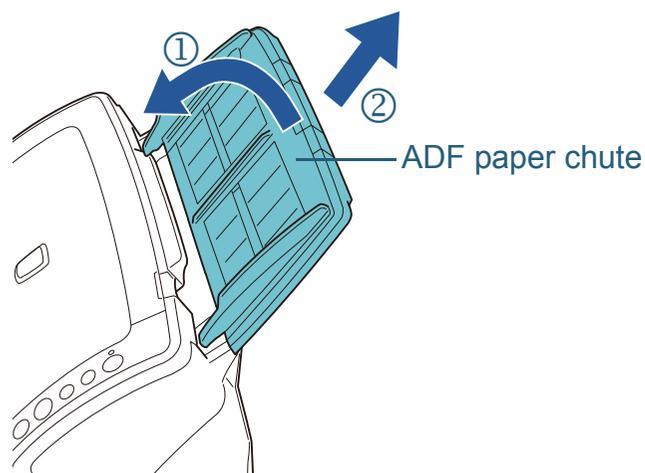

- 3 Open the ADF.
For details, refer to "1.4 Opening/Closing the ADF" (page 24).



Be careful not to have your fingers caught when the ADF closes.

- 4 Remove the pick roller.
 - 1 Open the sheet guide by lifting the tab.

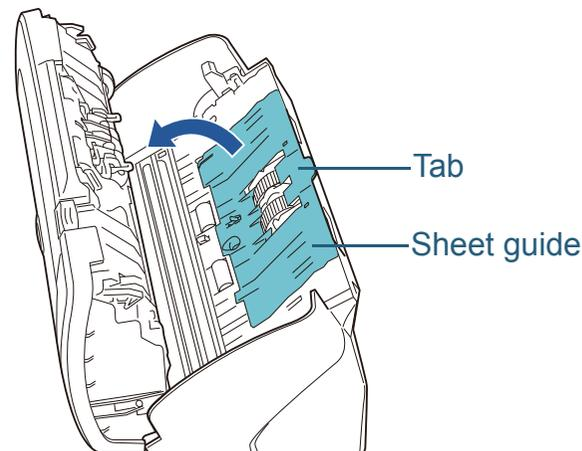

- 2 Rotate the bushing on the shaft.

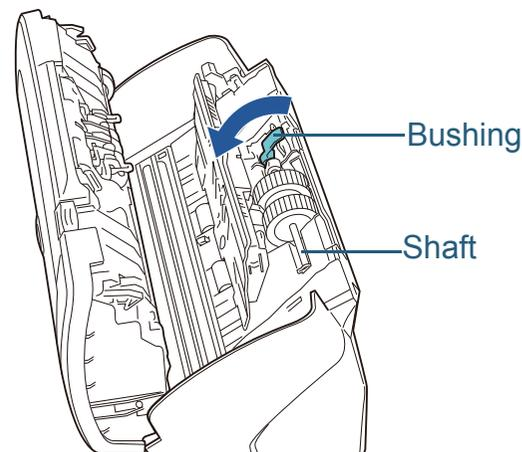

3 Lift the bushing first, then pull out the shaft.

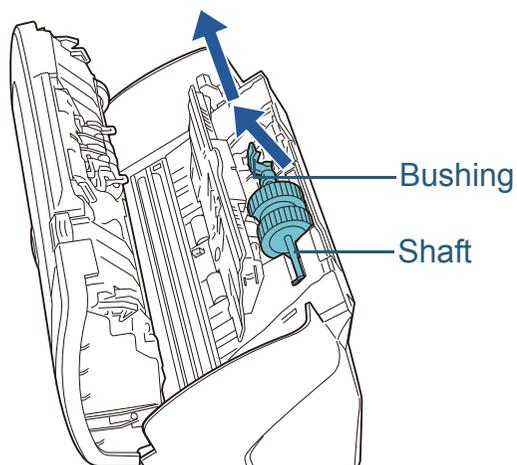

Be careful not to touch the gear near the bushing on the shaft as it contains grease.

5 Remove the pick roller from its shaft.
Pull out the shaft as you lift the retaining clip.

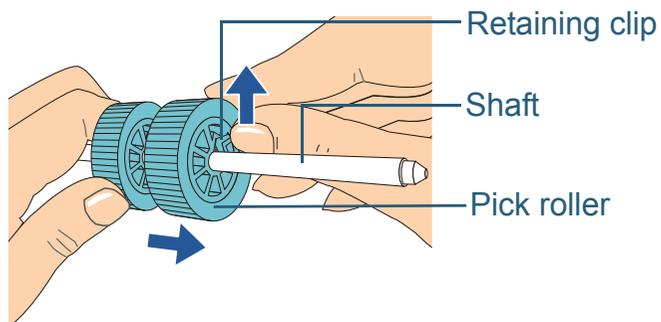

Lifting the retaining clip with your fingernail may hurt or damage your fingernail. Use a paper clip or something alike if you have trouble lifting it up.

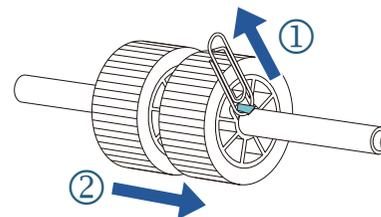

6 Attach a new pick roller on the shaft.
Insert the protrusion on the shaft into the slot.

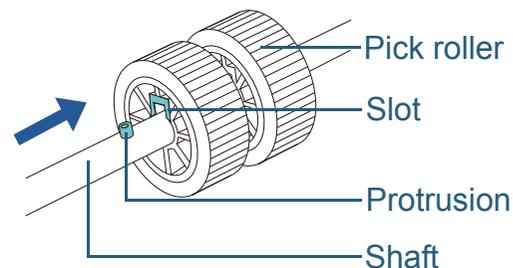

Confirm that the pick roller is installed properly. Otherwise, it may cause feeding errors such as paper jams. Make sure to insert the pick roller until it locks in place.

7 Attach the shaft.

- 1 Insert the right end of the shaft into the slot, and lower the other end gradually.

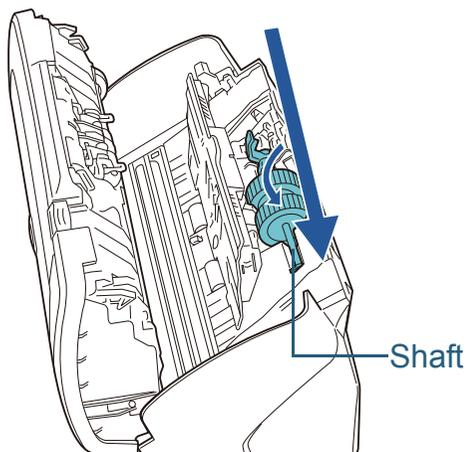

- 2 Rotate the bushing to lock the shaft.

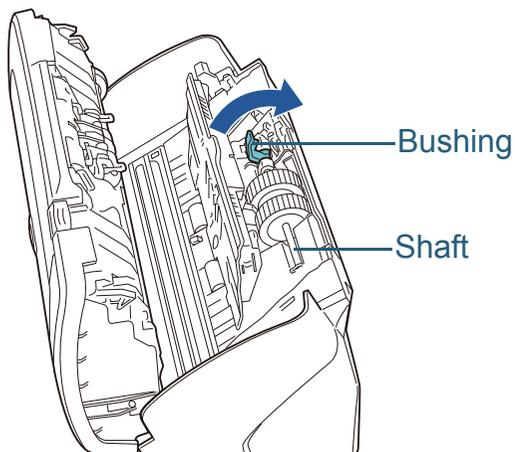

- 3 Close the sheet guide. Make sure that both ends of the sheet guide are locked firmly.



Confirm that the pick roller is installed properly. Otherwise, it may cause feeding errors such as paper jams.

8 Close the ADF.

For details, refer to ["1.4 Opening/Closing the ADF" \(page 24\)](#).



Be careful not to have your fingers caught when the ADF closes.

9 Attach the ADF paper chute.

Insert the tabs into the slots on the back of the scanner, and tilt the ADF paper chute backwards until it locks in place.

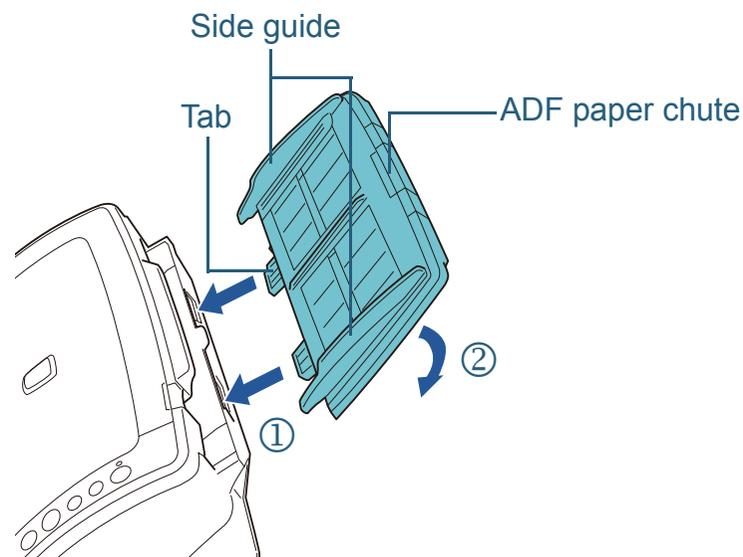

10 Reset the consumable counter.

Start up the Software Operation Panel and reset the counter. For details, refer to ["Resetting the counters" \(page 167\)](#).

Chapter 8 Troubleshooting

This chapter explains about the countermeasures against paper jams and other troubles, items to check before contacting your scanner service provider, and how to read the product labels on the scanner.



For details about errors/troubles not mentioned in this chapter, refer to the TWAIN driver Help, ISIS driver Help or Error Recovery Guide.

8.1 Paper Jam	125
8.2 Error Indications on Operator Panel	126
8.3 Troubleshooting	130
8.4 Before You Contact the Scanner Service Provider	149
8.5 Checking the Product Labels.....	151

8.1 Paper Jam

When your document is jammed inside the scanner, remove the document in the following procedure.



- Do not use force to pull out the jammed document, and make sure to open the ADF first.
- Be careful not to touch any sharp parts upon removing jammed documents.
- Be careful not to get your accessories (e.g. ties, necklaces) or hair caught inside the scanner.
- The glass surface may become extremely hot during operation.

1 Remove all documents from the ADF paper chute.

2 Open the ADF.

For details, refer to ["1.4 Opening/Closing the ADF" \(page 24\)](#).



Be careful not to have your fingers caught when the ADF closes.

3 Remove the jammed document.

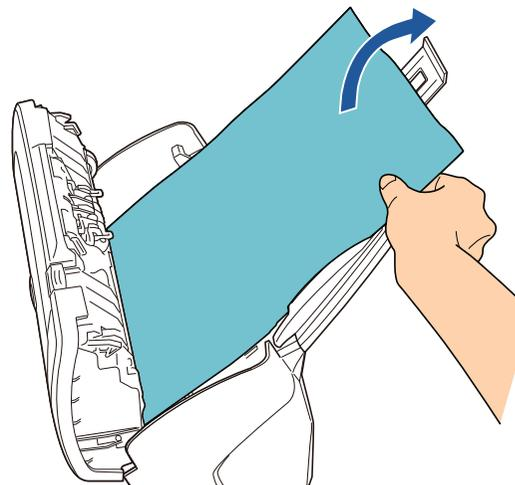

- Make sure to check the documents and the paper path thoroughly and remove all staples and paper clips as they cause paper jams.
- Be careful not to damage the glass surface and the guides when removing documents with staples or paper clips.

4 Close the ADF.

For details, refer to ["1.4 Opening/Closing the ADF" \(page 24\)](#).



- Confirm that the ADF is closed properly. Otherwise, the document may not be fed into the ADF.
- Occasionally when scanning is complete or canceled, documents may remain in the ADF without any error message displayed. In that case, remove the documents by following the above steps [1](#) to [4](#).

TOP

Contents

Index

Introduction

Scanner
Overview

How to Load
Documents

Configuring the
Scan Settings

How to Use the
Operator Panel

Various Ways to
Scan

Daily Care

Replacing the
Consumables

Troubleshooting

Operational
Settings

Appendix

Glossary

8.2 Error Indications on Operator Panel

When an error occurs, the LED indicator lights in orange. The Function Number Display alternates between either "J" or "U" and an "error number" for temporary errors, and either "E", "F", "C", "H", "A" or "U" and an "alarm number" for device errors. Temporary errors can be recovered by the operator, whereas device errors require a service engineer to perform recovery. The indication will return to "1" (ready) if the [Scan/Stop] or [Send to] button is pressed. Note that in case of a paper jam, the indication will be cleared automatically after a certain amount of time if no document is loaded.

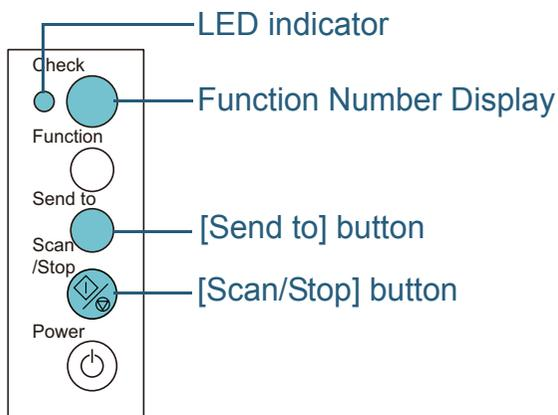

If the Error Recovery Guide is installed in your computer, the Error Recovery Guide window appears when the Windows operating system is started up. When an error or a malfunction occurs, the Error Recovery Guide window displays related information such as the name of the error and the error code (number).

Write down the information shown in the dialog box and click the [More Info] button to check for troubleshooting methods.

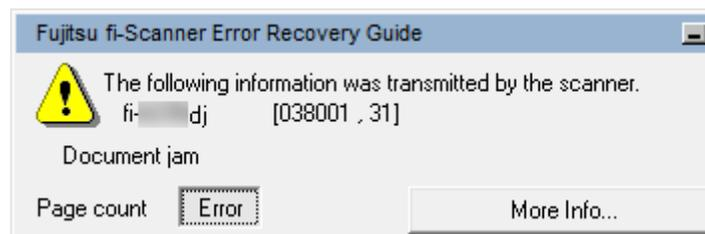

The Error Recovery Guide is included in the Setup DVD-ROM. For details about installation, refer to "Installing the Software" in Getting Started.

Temporary Errors

The following are lists of temporary errors which can be recovered by operators.

■ Paper feeding errors

"J" and "error number" are displayed back and forth.

Display	Item	Resolution
J0	Paper jam (paper protection)	1 Remove the jammed document. For details, refer to "8.1 Paper Jam" (page 125) .
J1	Paper jam	2 Check if the document is suitable for scanning by ADF. For details, refer to "2.3 Documents for Scanning (ADF)" (page 41) .
J2	Multifeed	When you press the [Send to] button on the operator panel, the documents are ejected.

■ Cover open and print errors

"U" and "error number" are displayed back and forth.

Display	Item	Resolution
U0	Transport lock error (fi-6230Z/fi-6240Z)	Unlock the transport lock switch. For details, refer to "Installing the Scanner" in Getting Started.
U4	Cover open (ADF)	Close the ADF and reload the documents.
U5	Cover open (Imprinter)	Close the print section of the imprinter, and load the document again.
U6	Print cartridge not installed	This error is related to the imprinter (option). For more details, refer to the fi-614PR Imprinter Operator's Guide.

Device Errors

The following are lists of device errors which require troubleshooting by a service engineer.

Internal and optical errors

"E" and "alarm number" are displayed back and forth.

Display	Item	Resolution
E0	Flatbed motor malfunction (fi-6230Z/fi-6240Z)	<ol style="list-style-type: none"> 1 Confirm that the transport lock switch is not locked. 2 Turn the scanner off then back on. If the problem persists, write down the displayed error code and contact your FUJITSU scanner dealer or an authorized FUJITSU scanner service provider.
E1	Optical error (Flatbed) (fi-6230Z/fi-6240Z)	
E2	Optical error (ADF Front)	<ol style="list-style-type: none"> 1 Clean the glass section. For details about cleaning, refer to "Chapter 6 Daily Care" (page 108). 2 Turn the scanner off then back on. If the problem persists, write down the displayed error code and contact your FUJITSU scanner dealer or an authorized FUJITSU scanner service provider.
E3	Optical error (ADF Back)	
E6	Operator panel error	Turn the scanner off then back on. If the problem persists, write down the displayed error code and contact your FUJITSU scanner dealer or an authorized FUJITSU scanner service provider.
E7	EEPROM error	
E8	SCSI error (fi-6140Z/fi-6240Z)	
E9	Memory error	

Overrun error

"F" and "alarm number" are displayed back and forth.

Display	Item	Resolution
F4	Background switching mechanism error	Turn the scanner off then back on. If the problem persists, write down the displayed error code and contact your FUJITSU scanner dealer or an authorized FUJITSU scanner service provider.

Chip error

"C" and "alarm number" are displayed back and forth.

Display	Item	Resolution
C0	LSI error	Turn the scanner off then back on. If the problem persists, write down the displayed error code and contact your FUJITSU scanner dealer or an authorized FUJITSU scanner service provider.

■ Motor circuit error

"H" and "alarm number" are displayed back and forth.

Display	Item	Resolution
H0	Motor circuit error	Turn the scanner off then back on. If the problem persists, write down the displayed error code and contact your FUJITSU scanner dealer or an authorized FUJITSU scanner service provider.
H6	Imprinter system malfunction	
H7	Lamp circuit error	
H8	Motor circuit error (background switching mechanism)	

■ Option error (when imprinter is installed)

"A" and "alarm number" are displayed back and forth.

Display	Item	Resolution
A0	Imprinter error (control board)	<ol style="list-style-type: none"> 1 Confirm that the EXT cable of the imprinter is connected properly to the EXT connector on the back of the scanner. For details, refer to the fi-614PR Operator's Guide. 2 Confirm that the print cartridge is installed correctly. For details, refer to the fi-614PR Operator's Guide. 3 Turn the scanner off then back on. If the problem persists, write down the displayed error code and contact your FUJITSU scanner dealer or an authorized FUJITSU scanner service provider.
A1	Imprinter error (communication time-out)	
A2	Imprinter error (print head)	
A3	Imprinter error (EEPROM)	
A4	Imprinter error (ROM)	

■ Sensor error

"L" and "alarm number" are displayed back and forth.

Display	Item	Resolution
L6	Sensor error	<ol style="list-style-type: none"> 1 Clear any dust around the ultrasonic sensors. 2 Turn the scanner off then back on. If the problem persists, write down the displayed error code and contact your FUJITSU scanner dealer or an authorized FUJITSU scanner service provider.

8.3 Troubleshooting

This section describes the resolutions for troubles that may occur while using the scanner. Please check the following items before you request a repair. If the problem persists, check each item in "8.4 Before You Contact the Scanner Service Provider" (page 149), and then contact your FUJITSU scanner dealer or an authorized FUJITSU scanner service provider.

The following are some examples of troubles that you may experience.

Symptoms
"Scanner cannot be powered ON." (page 131)
"The Function Number Display switches OFF." (page 132)
"Scanning does not start." (page 133)
"Image quality is poor when scanning pictures/photos in black & white." (page 134)
"Quality of scanned text or lines is unsatisfactory." (page 135)
"Images are distorted or not clear." (page 136)
"Vertical streaks appear on the scanned image." (page 137)
"E" (or other number/letter) is already displayed on the Function Number Display after power-on." (page 138)
"Multifeed error occurs frequently." (page 139)
"Situation in which the document is not fed into the ADF occurs frequently." (page 141)
"Paper jams/pick errors occur frequently." (page 142)

Symptoms
"Scanned images turn out elongated." (page 143)
"A shadow appears at the top or the bottom of the scanned image." (page 144)
"There are black traces on the document." (page 145)
"The Carrier Sheet is not fed smoothly. / Paper jams occur." (page 146)
"Part of the image appears missing when using the Carrier Sheet." (page 148)

TOP

Contents

Index

Introduction

Scanner
OverviewHow to Load
DocumentsConfiguring the
Scan SettingsHow to Use the
Operator PanelVarious Ways to
Scan

Daily Care

Replacing the
Consumables

Troubleshooting

Operational
Settings

Appendix

Glossary

Scanner cannot be powered ON.

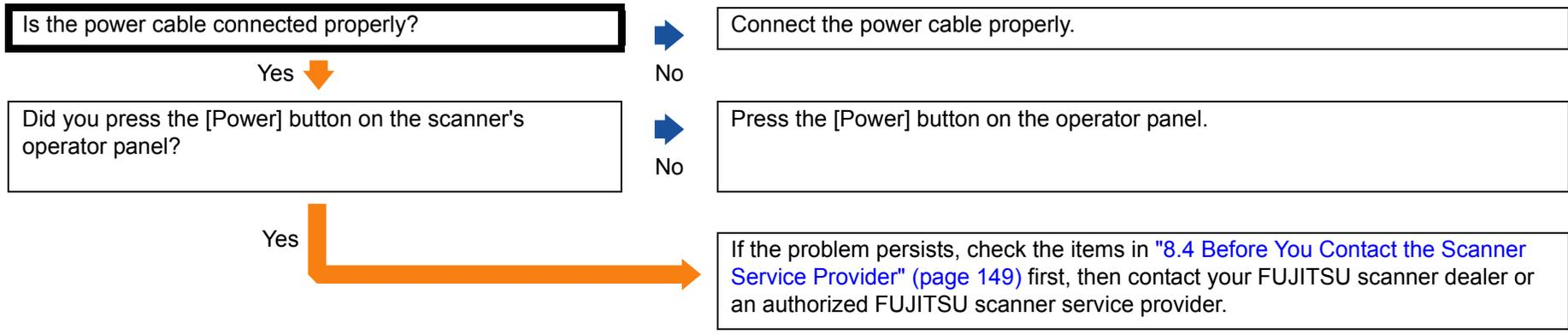

- TOP
- Contents
- Index
- Introduction
- Scanner Overview
- How to Load Documents
- Configuring the Scan Settings
- How to Use the Operator Panel
- Various Ways to Scan
- Daily Care
- Replacing the Consumables
- Troubleshooting**
- Operational Settings
- Appendix
- Glossary

The Function Number Display switches OFF.

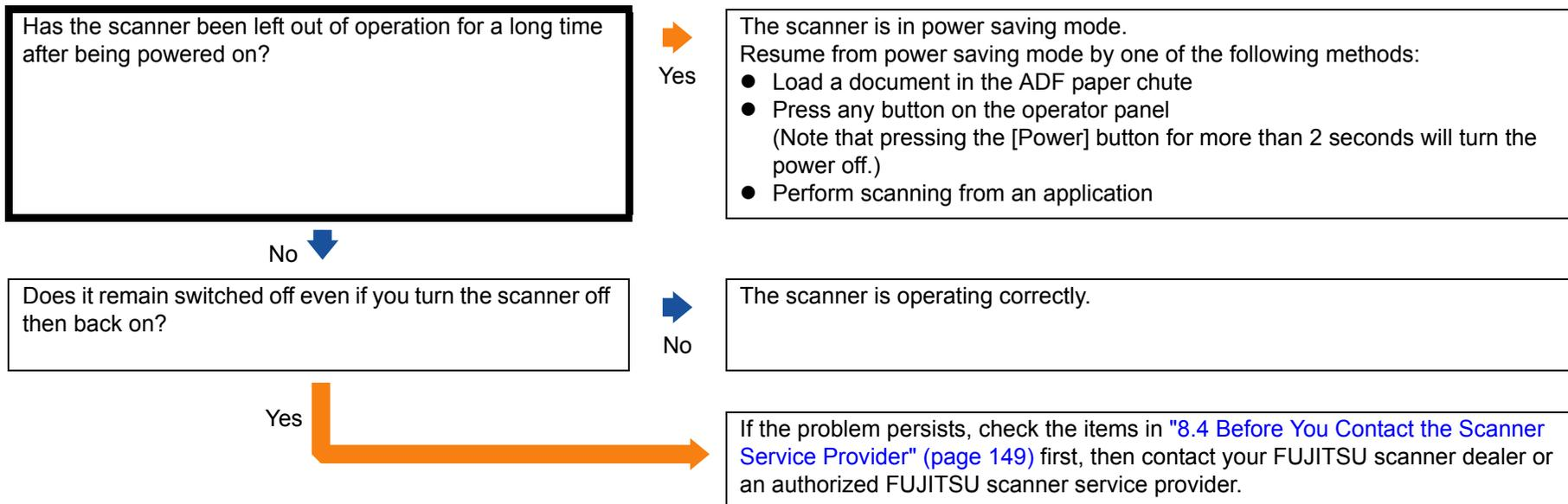

Scanning does not start.

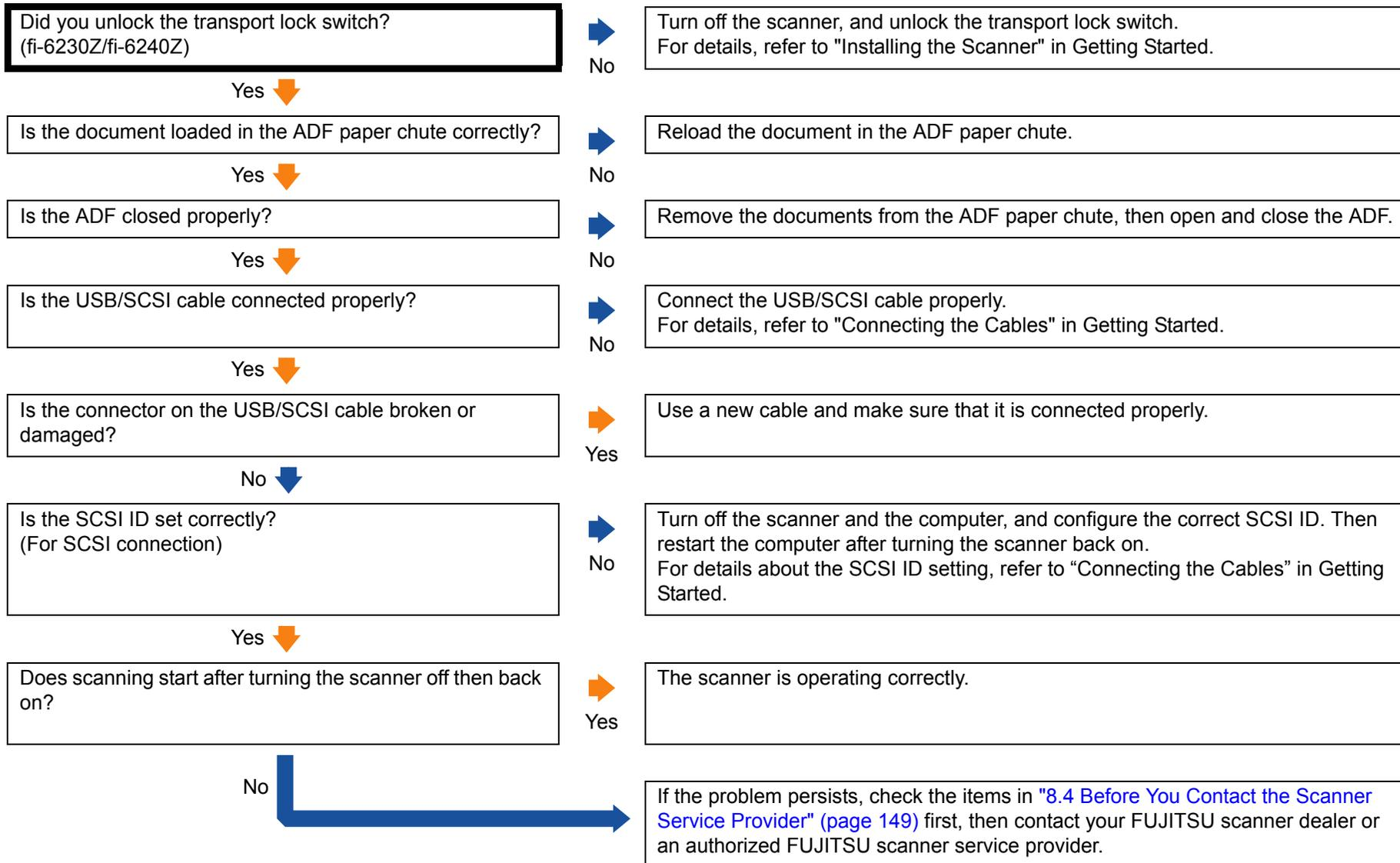
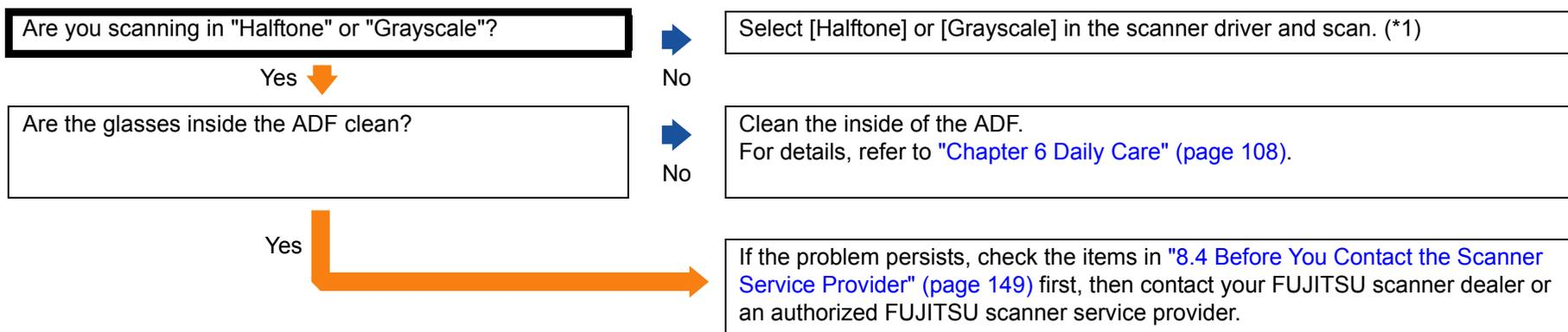
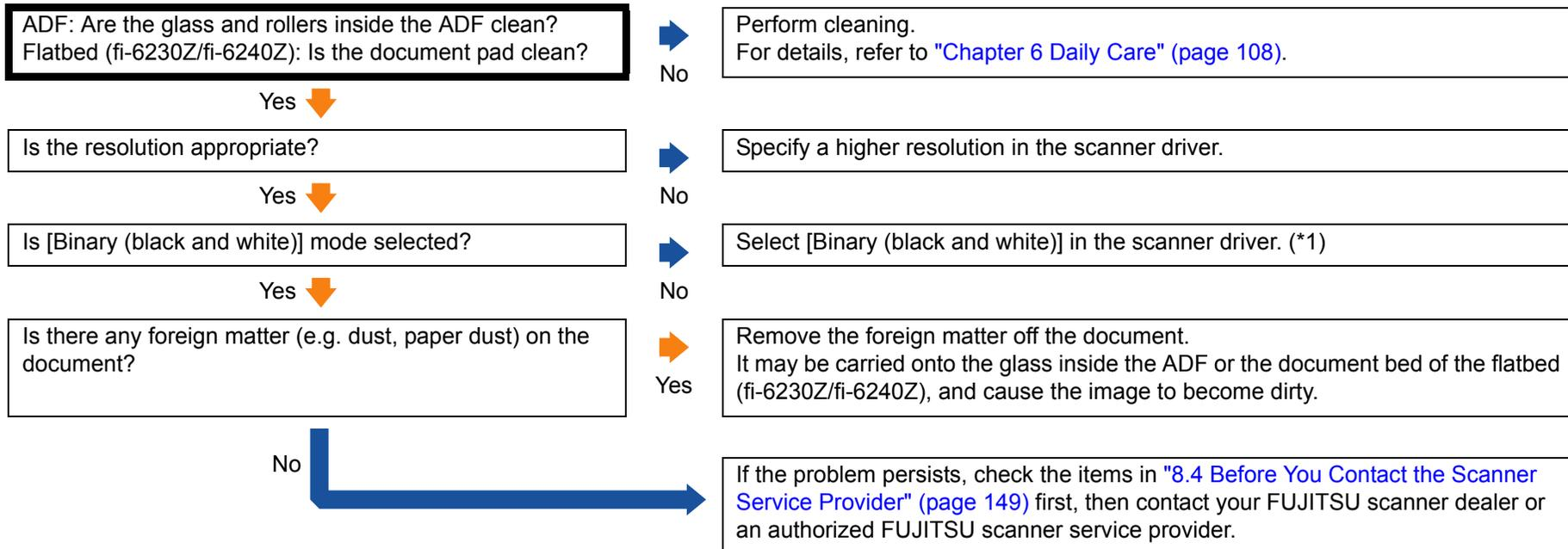

Image quality is poor when scanning pictures/ photos in black & white.



*1: The scanned image may differ from the original image significantly if you simply "binarize" (output in black & white) a picture or a photo. If the setting can be configured from the scanner driver's setup dialog box, set the image mode to [Halftone] or [Grayscale].

- TOP
- Contents
- Index
- Introduction
- Scanner Overview
- How to Load Documents
- Configuring the Scan Settings
- How to Use the Operator Panel
- Various Ways to Scan
- Daily Care
- Replacing the Consumables
- Troubleshooting
- Operational Settings
- Appendix
- Glossary

Quality of scanned text or lines is unsatisfactory.

*1: When scanning in halftone, grayscale or color, the scanned image may not become sharp and clear. If it can be configured in the scanner driver's setup dialog box, set the image mode to [Binary (black and white)].

Images are distorted or not clear.

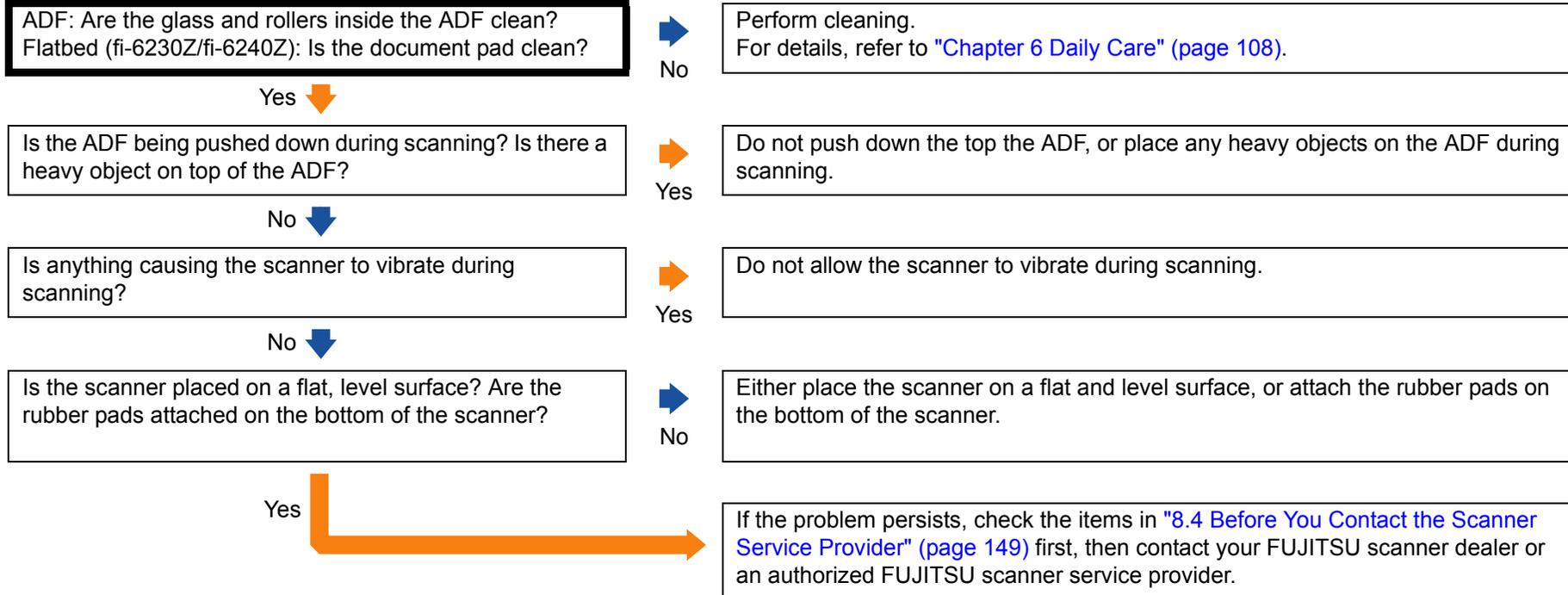

Vertical streaks appear on the scanned image.

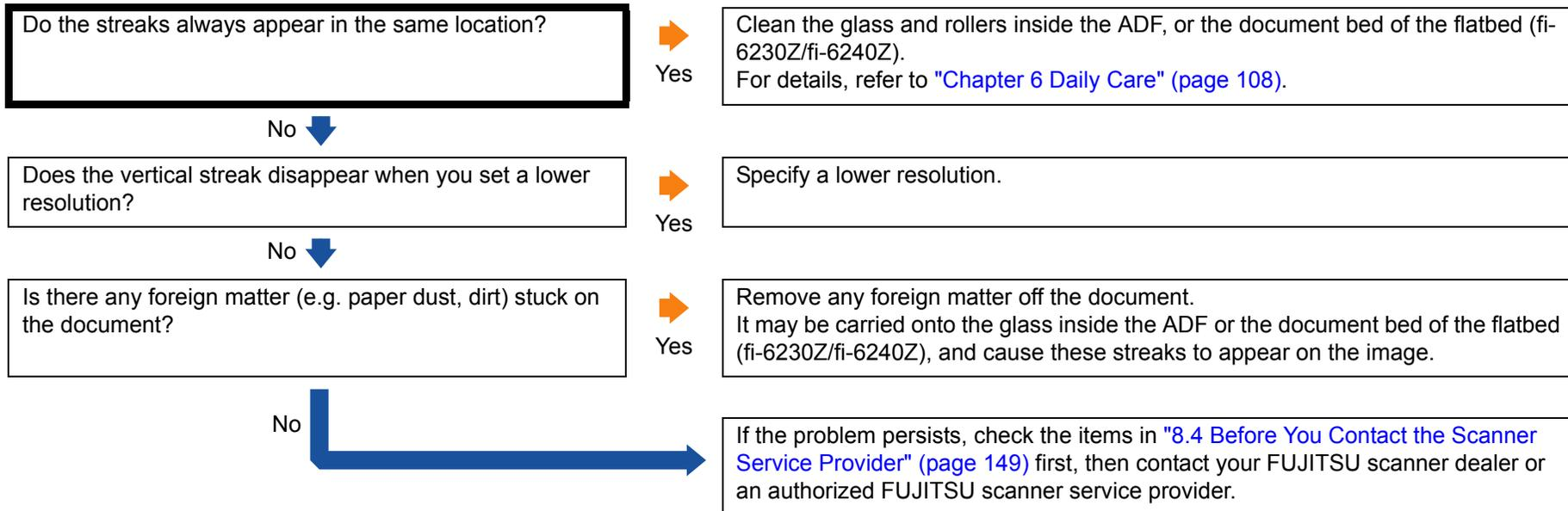

TOP

Contents

Index

Introduction

Scanner
OverviewHow to Load
DocumentsConfiguring the
Scan SettingsHow to Use the
Operator PanelVarious Ways to
Scan

Daily Care

Replacing the
Consumables

Troubleshooting

Operational
Settings

Appendix

Glossary

"E" (or other number/letter) is already displayed on the Function Number Display after power-on.

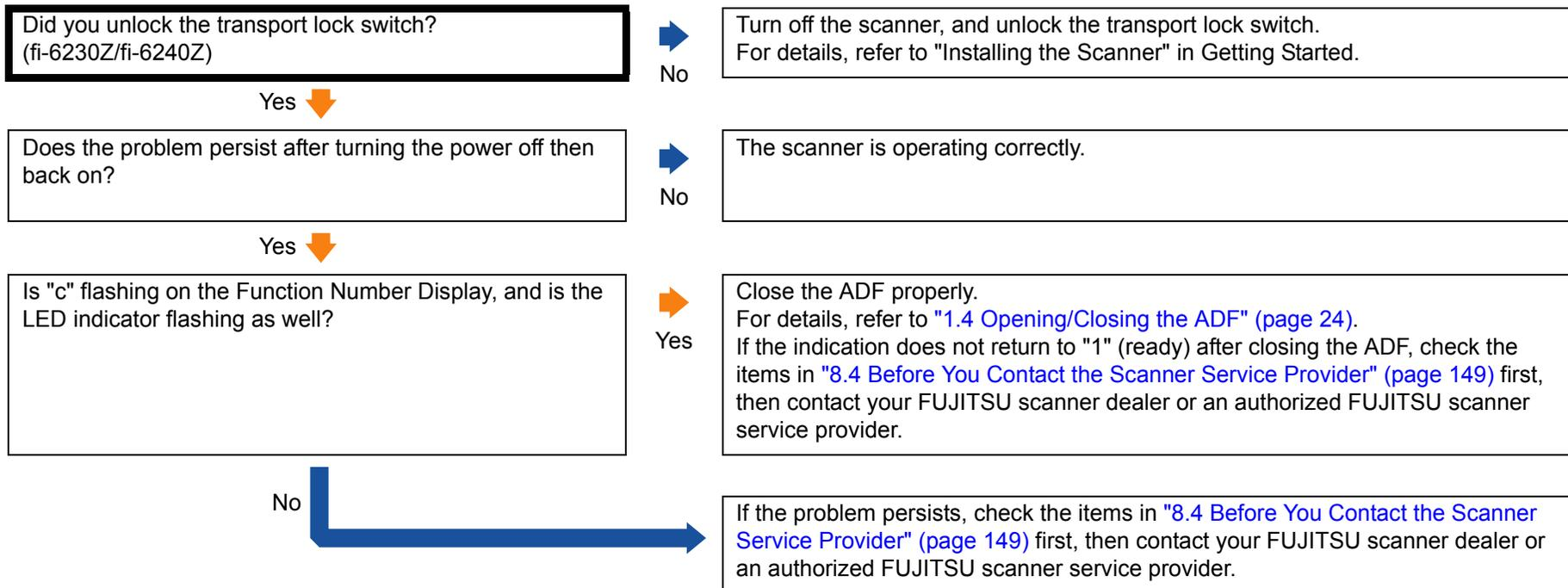

Multifeed error occurs frequently.

<p>Do the documents meet the requirements described in "Precautions" in "Conditions" (page 41)?</p> <p>Yes </p>	<p> No</p>	<p>Use documents that meet the requirements. For details, refer to "2.3 Documents for Scanning (ADF)" (page 41).</p>
<p>If you are using the Carrier Sheet, is [Double-page spread], [Clipping (Front)] or [Clipping (Duplex)] specified for [Scan Type] in the scanner driver's setup dialog box?</p> <p>Yes </p>	<p> No</p>	<p>Specify either [Double-page spread], [Clipping (Front)] or [Clipping (Duplex)]. For details, refer to "Documents Larger than A4/Letter Size" (page 70) or "Scanning Photographs and Clippings" (page 73).</p>
<p>If multifeed detection is enabled, is there any document in the batch that does not fulfill the conditions for an accurate detection?</p> <p>No </p>	<p> Yes</p>	<p>Fulfill the conditions for an accurate multifeed detection. For details, refer to "Conditions for Multifeed Detection" (page 45). Also specify the multifeed detection area if necessary ("Detecting Multifeed Errors" (page 103)).</p>
<p>Did you scan a plastic card or any other thick document?</p> <p>No </p>	<p> Yes</p>	<p>Disable multifeed detection.</p>
<p>Did you fan the documents before loading them?</p> <p>Yes </p>	<p> No</p>	<p>Fan the documents.</p>
<p>Have the documents just been printed out from a copy machine or a laser printer?</p> <p>No </p>	<p> Yes</p>	<p>Fan the documents a few times to remove static electricity.</p>
<p>Is the document stack thinner than 5 mm?</p> <p>Yes </p>	<p> No</p>	<p>Reduce the number of sheets.</p>
<p>Are the consumables (*1) installed correctly?</p> <p>Yes </p>	<p> No</p>	<p>Install the consumables correctly. For details, refer to "Chapter 7 Replacing the Consumables" (page 117).</p>
<p>Are the consumables dirty?</p> <p>No </p>	<p> Yes</p>	<p>Clean the consumables. For details, refer to "Chapter 6 Daily Care" (page 108).</p>

No (continued) ↓

Are the consumables worn out?

Yes

Check the consumable counters and replace them if necessary.
For details, refer to "[Chapter 7 Replacing the Consumables](#)" (page 117).

No

If the problem persists, check the items in "[8.4 Before You Contact the Scanner Service Provider](#)" (page 149) first, then contact your FUJITSU scanner dealer or an authorized FUJITSU scanner service provider.

*1: "Consumables" refers to the brake roller and the pick roller.

Situation in which the document is not fed into the ADF occurs frequently.

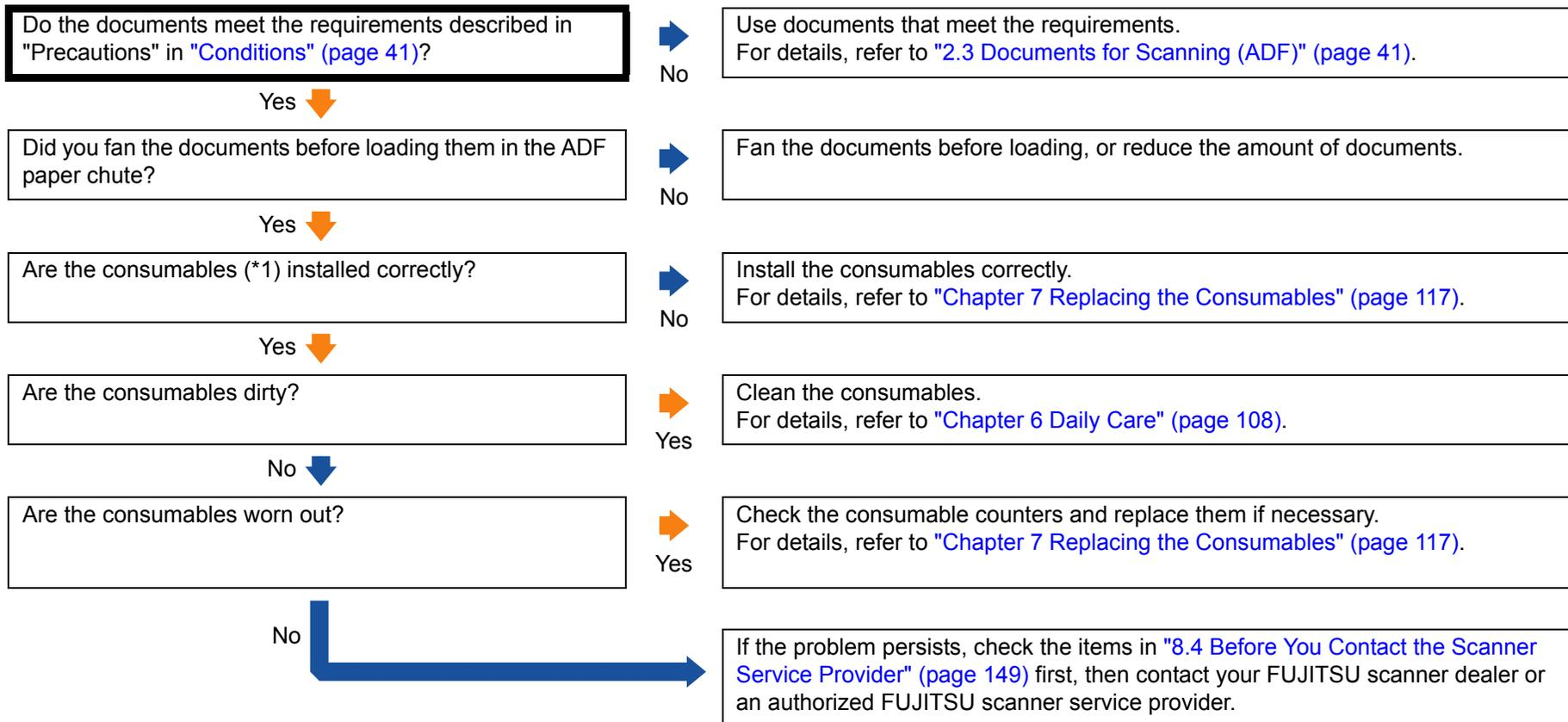

*1: "Consumables" refers to the brake roller and the pick roller.

Paper jams/pick errors occur frequently.

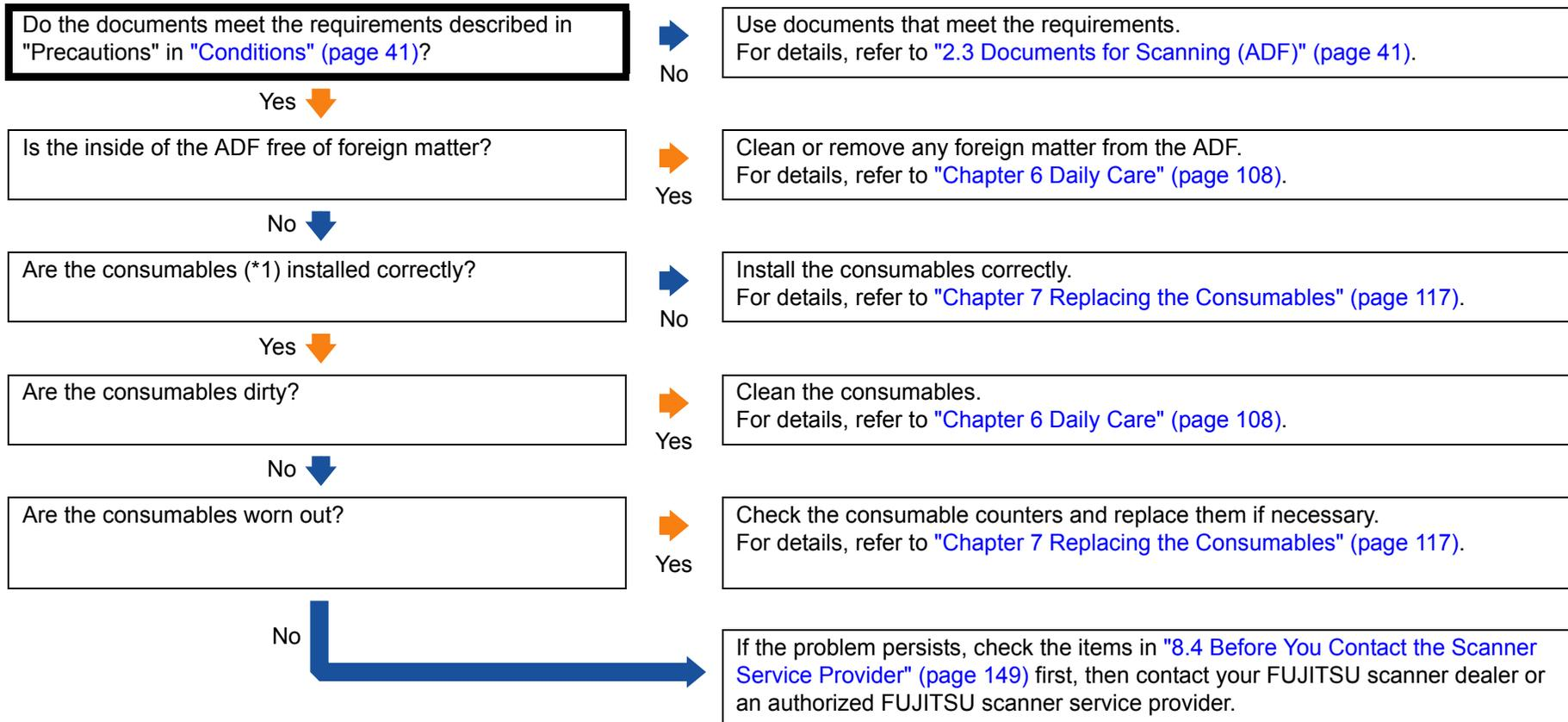

*1: "Consumables" refers to the brake roller and the pick roller.

TOP

Contents

Index

Introduction

Scanner
OverviewHow to Load
DocumentsConfiguring the
Scan SettingsHow to Use the
Operator PanelVarious Ways to
Scan

Daily Care

Replacing the
Consumables

Troubleshooting

Operational
Settings

Appendix

Glossary

Scanned images turn out elongated.

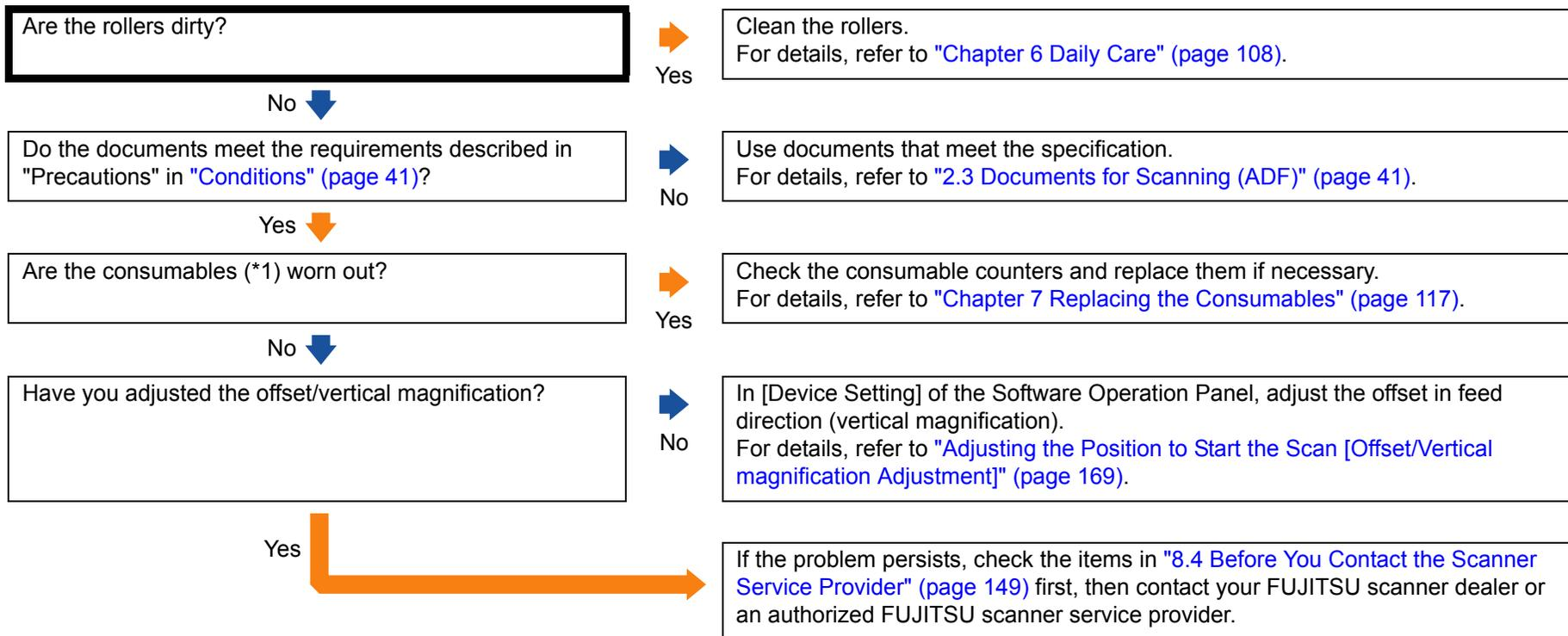

*1: "Consumables" refers to the brake roller and the pick roller.

A shadow appears at the top or the bottom of the scanned image.

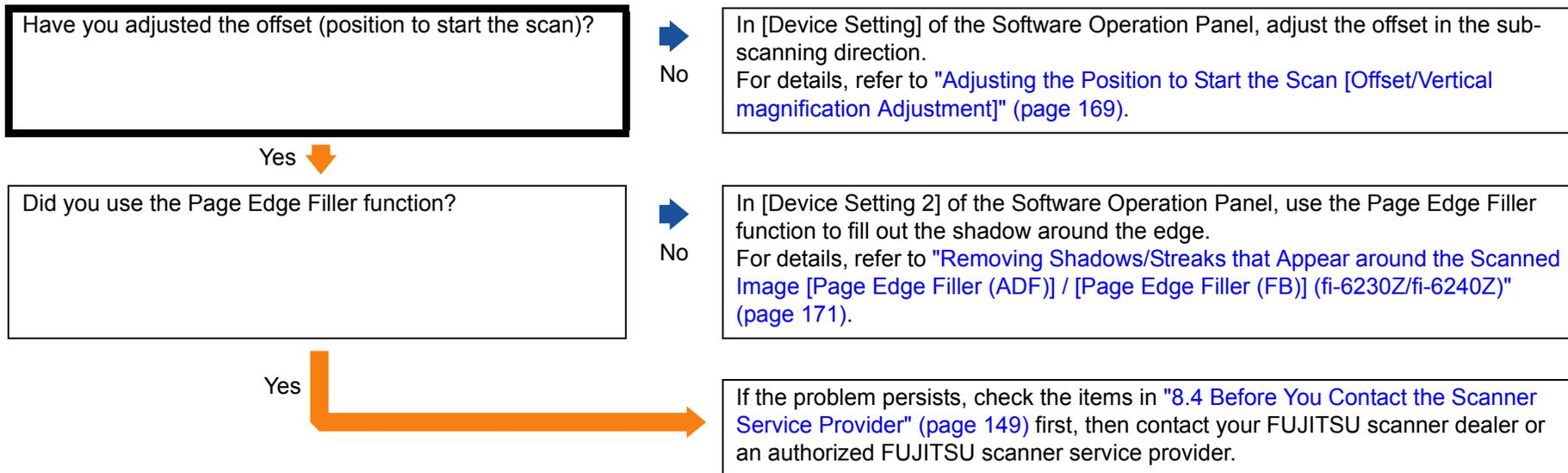

TOP

Contents

Index

Introduction

Scanner
OverviewHow to Load
DocumentsConfiguring the
Scan SettingsHow to Use the
Operator PanelVarious Ways to
Scan

Daily Care

Replacing the
Consumables

Troubleshooting

Operational
Settings

Appendix

Glossary

There are black traces on the document.

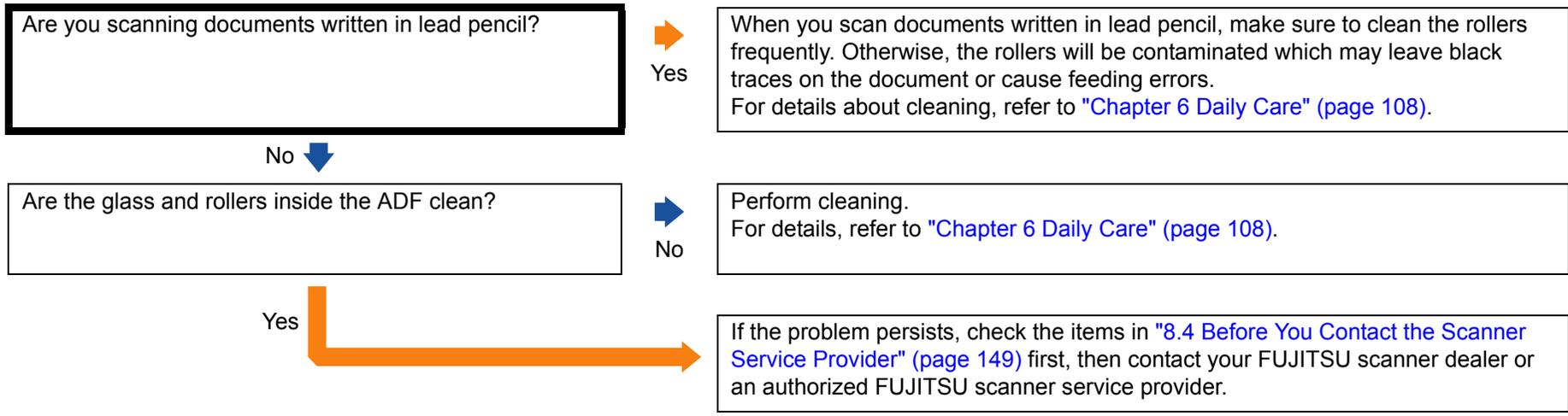

- TOP
- Contents
- Index
- Introduction
- Scanner Overview
- How to Load Documents
- Configuring the Scan Settings
- How to Use the Operator Panel
- Various Ways to Scan
- Daily Care
- Replacing the Consumables
- Troubleshooting**
- Operational Settings
- Appendix
- Glossary

The Carrier Sheet is not fed smoothly. / Paper jams occur.

<p>Did you scan just the Carrier Sheet continuously?</p>	<p>Yes</p>	<p>Feed about 50 sheets of PPC paper (recycled paper) before scanning with the Carrier Sheet. The PPC paper can either be blank or printed.</p>
<p>No ↓</p>		
<p>Is the Carrier Sheet clean?</p>	<p>No</p>	<p>Perform one of the following.</p> <ul style="list-style-type: none"> ● Clean the Carrier Sheet. For details about cleaning, refer to "Chapter 6 Daily Care" (page 108). ● Replace the Carrier Sheet. For information on purchasing the Carrier Sheet, refer to "A.4 Scanner Options" (page 196).
<p>Yes ↓</p>		
<p>Did you start the scan after loading the Carrier Sheet in the ADF paper chute?</p>	<p>No</p>	<p>Start the scan after loading the Carrier Sheet in the ADF paper chute. For details about loading the Carrier Sheet, refer to "Documents Larger than A4/Letter Size" (page 70) or "Scanning Photographs and Clippings" (page 73).</p>
<p>Yes ↓</p>		
<p>Are the glass and rollers inside the ADF clean?</p>	<p>No</p>	<p>Perform cleaning. For details, refer to "Chapter 6 Daily Care" (page 108).</p>
<p>Yes ↓</p>		
<p>Are the consumables (*1) worn out?</p>	<p>Yes</p>	<p>Check the consumable counters and replace them if necessary. For details, refer to "Chapter 7 Replacing the Consumables" (page 117).</p>
<p>No ↓</p>		
<p>Is there any foreign matter inside the ADF?</p>	<p>Yes</p>	<p>Remove the foreign matter and clean the ADF. For details, refer to "Chapter 6 Daily Care" (page 108).</p>
<p>No ↓</p>		

No (continued) ↓

Did you place a thick document inside the Carrier Sheet?

Yes

Some papers may be too thick to place inside the Carrier Sheet. For details about the thickness of documents that can be placed inside the Carrier Sheet, refer to "[Conditions for Using the Carrier Sheet](#)" (page 50).

No

If the problem persists, check the items in "[8.4 Before You Contact the Scanner Service Provider](#)" (page 149) first, then contact your FUJITSU scanner dealer or an authorized FUJITSU scanner service provider.

*1: "Consumables" refers to the brake roller and the pick roller.

Part of the image appears missing when using the Carrier Sheet.

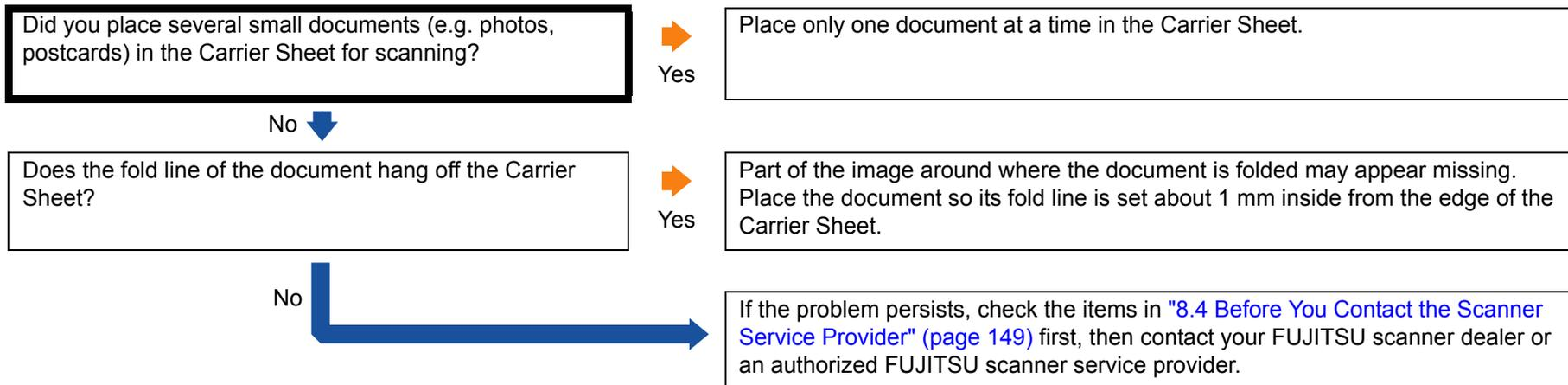

8.4 Before You Contact the Scanner Service Provider

Please check the following items before contacting your FUJITSU scanner dealer or an authorized FUJITSU scanner service provider.

General

Item	Findings
Scanner model name	Example: fi-6240Z For details, refer to "8.5 Checking the Product Labels" (page 151) .
Serial No.	Example: 000001 For details, refer to "8.5 Checking the Product Labels" (page 151) .
Date of manufacture	Example: 2011-06 (June 2011) For details, refer to "8.5 Checking the Product Labels" (page 151) .
Date of purchase	
Symptom	
Frequency of trouble	
Warranty	
Options used	Example: fi-614PR For details, refer to "A.4 Scanner Options" (page 196) .

TOP

Contents

Index

Introduction

Scanner
OverviewHow to Load
DocumentsConfiguring the
Scan SettingsHow to Use the
Operator PanelVarious Ways to
Scan

Daily Care

Replacing the
Consumables

Troubleshooting

Operational
Settings

Appendix

Glossary

Error Status

■ Computer connection issues

Item	Findings
Operating system (Windows)	
Error message	
Interface	Example: USB interface
Interface controller	

■ Feeding issues

Item	Findings
Paper type	
Main purpose of use	
Date of last cleaning	
Date of consumable replacement	
Operator panel status	

■ Image quality issues

Item	Findings
Scanner driver and version	
Interface controller	
Operating system (Windows)	
Application	Example: ScandAll PRO
Scanning side(s)	Example: front, back, both
Resolution	Example: 600 dpi, 75 dpi
Image mode	Example: color, grayscale, black & white

■ Other

Item	Findings
Can you send the output image and a photo that shows the paper condition by e-mail or fax?	

TOP

Contents

Index

Introduction

Scanner
OverviewHow to Load
DocumentsConfiguring the
Scan SettingsHow to Use the
Operator PanelVarious Ways to
Scan

Daily Care

Replacing the
Consumables

Troubleshooting

Operational
Settings

Appendix

Glossary

8.5 Checking the Product Labels

This section explains about the product labels on the scanner.

Location

The location of the two labels are as follows:

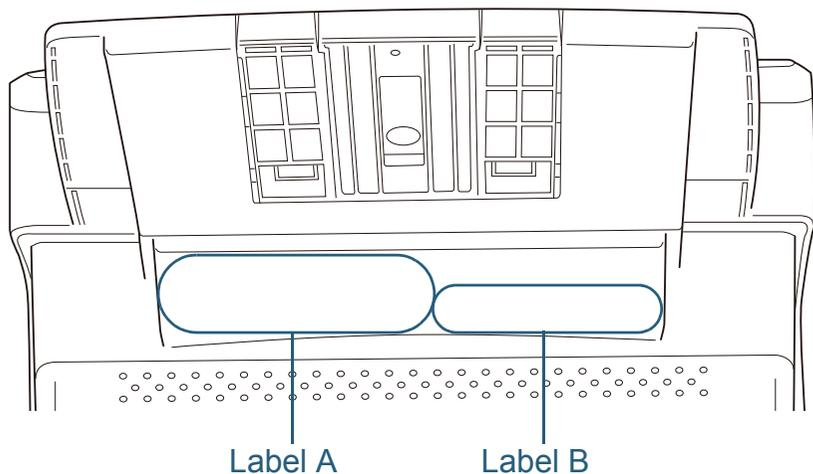

Label A (example): Shows the scanner information.

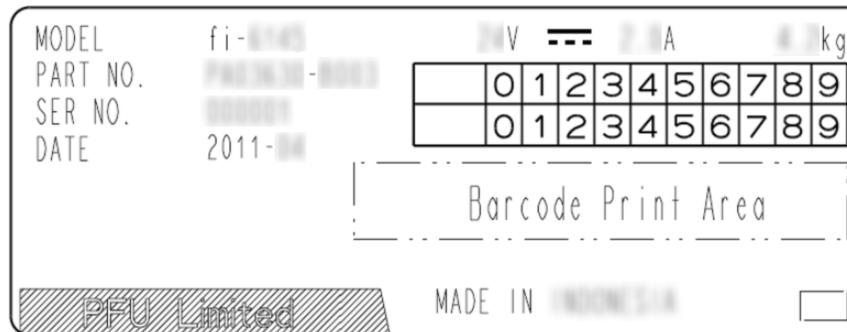

Label B (example): Shows the standards that the scanner conforms to.



Chapter 9 Operational Settings

This chapter explains how to use the Software Operation Panel to configure the scanner settings.

9.1 Starting Up the Software Operation Panel.....	153
9.2 Password Setting.....	154
9.3 Configuration Items	160
9.4 Settings Related to Page Counters	166
9.5 Settings Related to Scanning	169
9.6 Settings Related to Multifeed Detection	180
9.7 Settings Related to Waiting Time	186
9.8 Settings Related to Power ON/OFF	188

9.1 Starting Up the Software Operation Panel

The Software Operation Panel (SOP) is installed together with TWAIN driver, ISIS driver and Kofax VRS.

This application allows you to configure various settings such as the operation of the scanner and managing the consumables.



- Do not use the operator panel while the Software Operation Panel is running.
- If you connect multiple scanners, the second scanner and so forth will not be recognized. Connect only one scanner at a time.

1 Confirm that the scanner is connected to the computer, then turn on the scanner.

For details, refer to "1.3 Turning the Power ON/OFF" (page 23).

2 Select the [Start] menu → [All Programs] → [Scanner Utility for Microsoft Windows] → [Software Operation Panel].

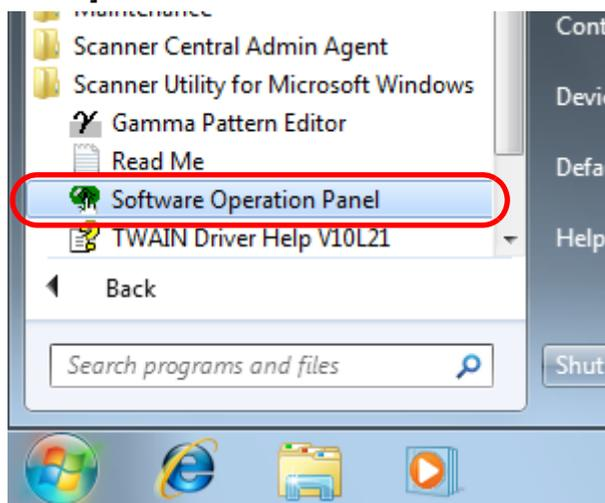

⇒ The [FUJITSU Software Operation Panel] dialog box appears.

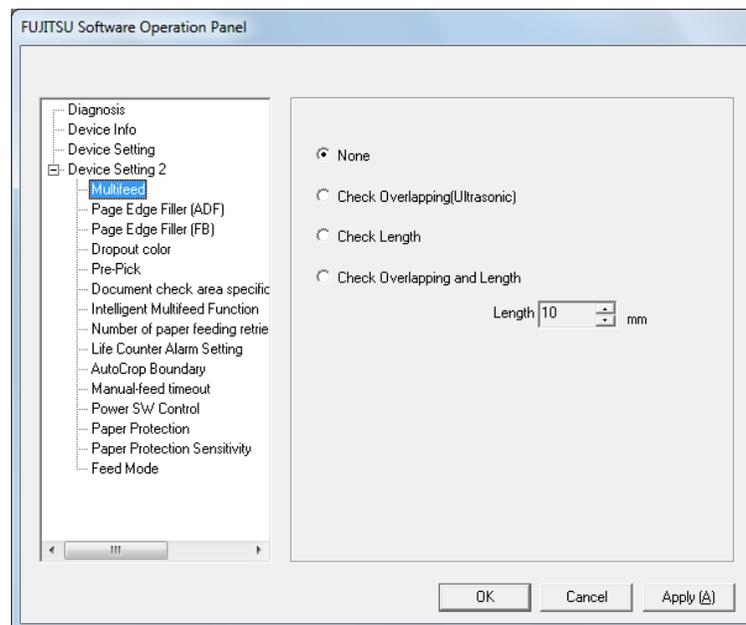

⇒ The Software Operation Panel icon is displayed in the menu that appears when you click  on the taskbar.

To have the Software Operation Panel icon always displayed on the taskbar, drag the icon and drop it onto the taskbar.

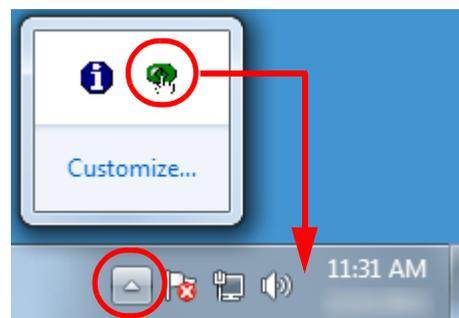

Procedures from here will be explained under the assumption that the Software Operation Panel is always displayed on the taskbar.

9.2 Password Setting

By setting a password, the Software Operation Panel can run in [View Only mode] which allows users to only view the scanner settings.

The scanner settings can be configured if no password is set. In order to prevent unnecessary changes to the settings, a password can be used to restrict user operations.

Setting a Password

Set a password in the following procedure.

- 1 Right-click the Software Operation Panel icon on the taskbar, and select [Password Setting] from the menu.

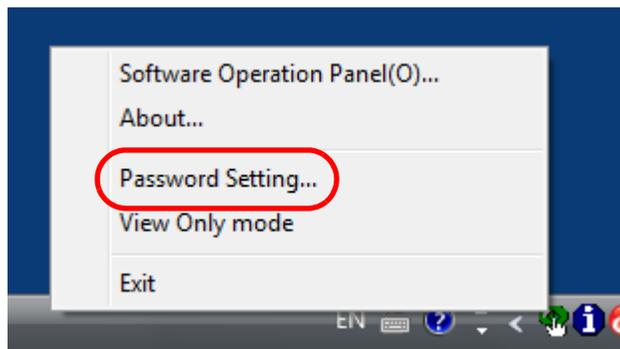

⇒ The [Password setting] dialog box appears.

- 2 Enter a new password then again to confirm, and click the [OK] button.

Up to 32 characters can be used for the password.

Note that only alphanumeric characters (a to z, A to Z, 0 to 9) are allowed.



⇒ A confirmation message appears.

- 3 Click the [OK] button.
- ⇒ The password is set.

Setting the [View Only mode]

Set the Software Operation Panel to [View Only mode] in the following procedure.

- 1 Set a password.
For details, refer to "Setting a Password" (page 154).
- 2 Right-click the Software Operation Panel icon on the taskbar, and select [View Only mode] from the menu.

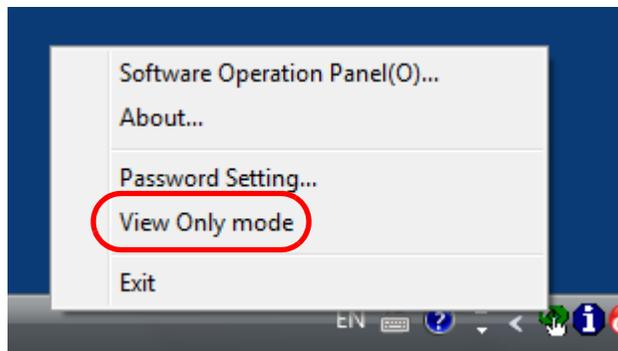

⇒ The Software Operation Panel enters the [View Only mode].

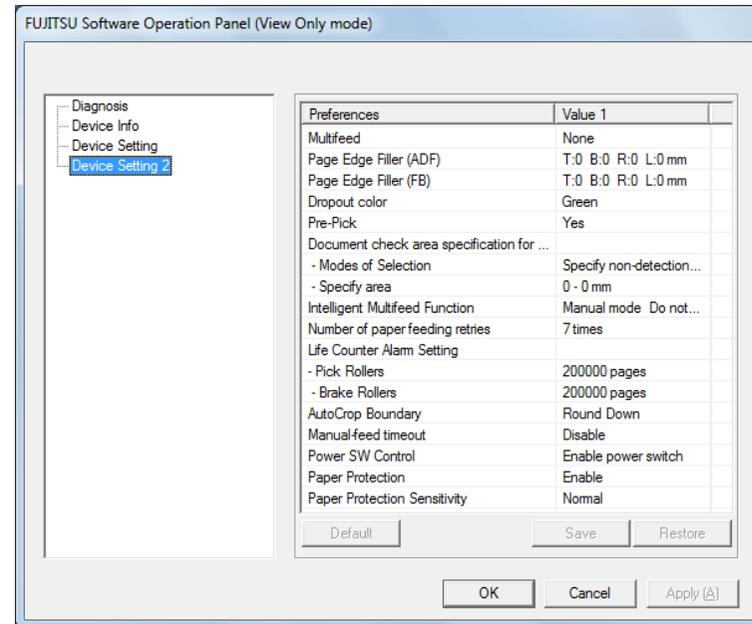

 In [View Only mode], a check mark appears next to [View Only mode] in the menu that is displayed by right-clicking the Software Operation Panel icon.

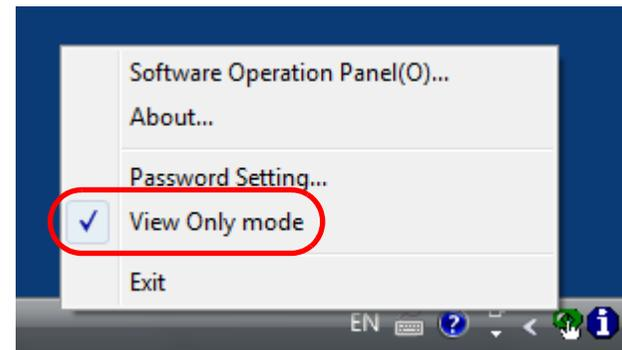

Clearing the [View Only mode]

Clear the [View Only mode] in the following procedure.

- 1 Right-click the Software Operation Panel icon on the taskbar, and select [View Only mode] from the menu.

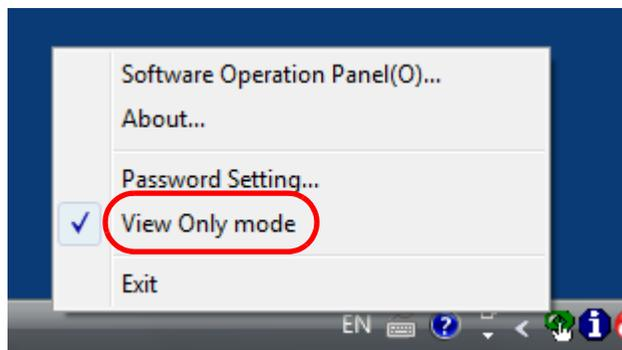

⇒ The [Password setting] dialog box appears.

- 2 Enter the current password and click the [OK] button.



⇒ [View Only mode] is cleared, and the scanner settings can now be changed.

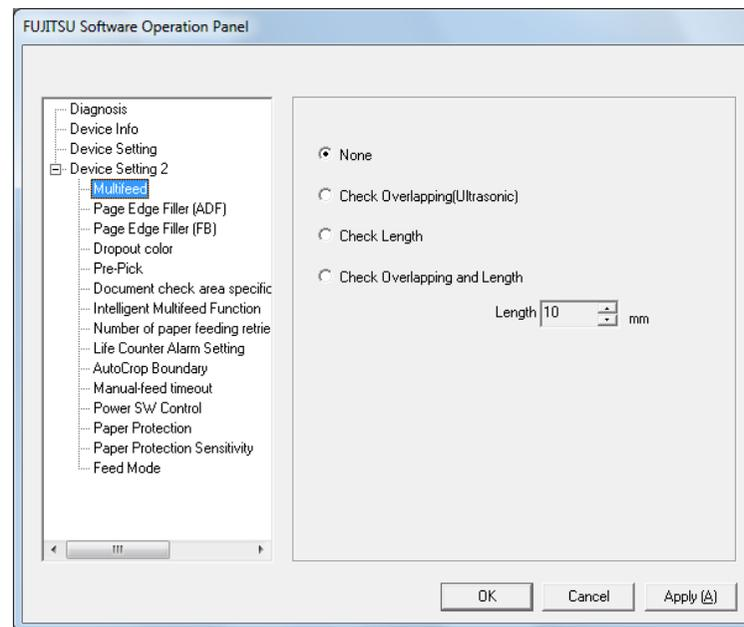

When you exit [View Only mode], the check mark next to [View Only mode] disappears from the menu that is displayed by right-clicking the Software Operation Panel icon.

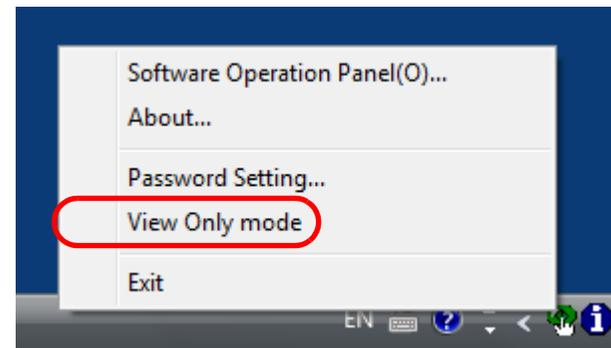

Changing the Password

Change the password in the following procedure.

- 1 Right-click the Software Operation Panel icon on the taskbar, and select [Password Setting] from the menu.

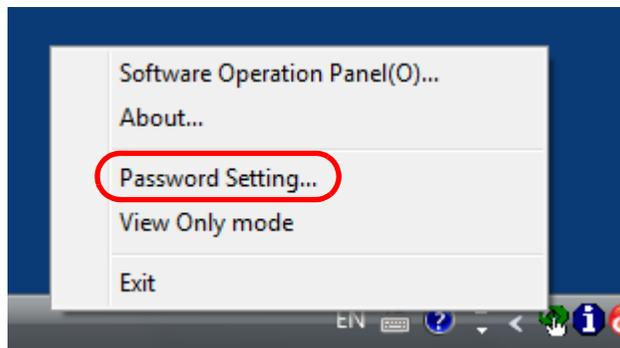

⇒ The [Password setting] dialog box appears.

- 2 Enter the current password and click the [OK] button.



⇒ The [Password setting] dialog box appears.

- 3 Enter a new password then again to confirm, and click the [OK] button.

Up to 32 characters can be used for the password.

Note that only alphanumeric characters (a to z, A to Z, 0 to 9) are allowed.



⇒ A confirmation message appears.

- 4 Click the [OK] button.
- ⇒ The password is set.

Clearing the Password

Clear the password in the following procedure.

- 1 Right-click the Software Operation Panel icon on the taskbar, and select [Password Setting] from the menu.

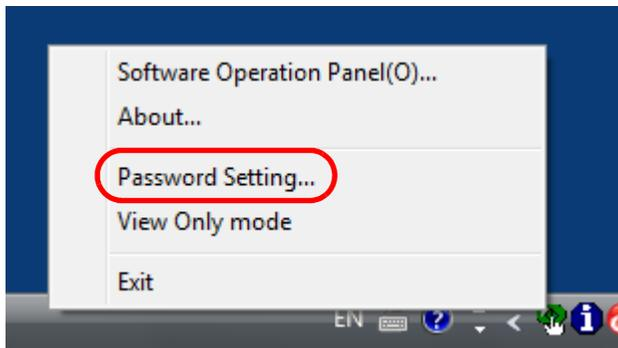

⇒ The [Password setting] dialog box appears.

- 2 Enter the current password and click the [OK] button.



⇒ The [Password setting] dialog box appears.

- 3 Leave both fields blank and click the [OK] button.

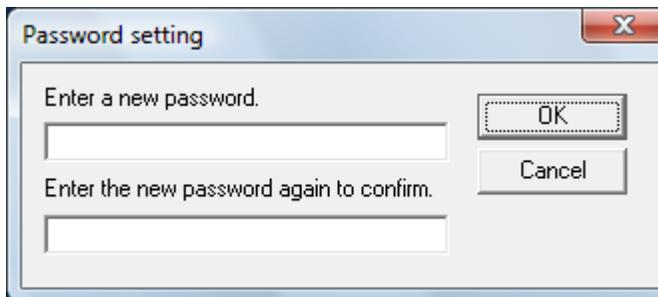

⇒ A confirmation message appears.

- 4 Click the [OK] button.
⇒ The password is cleared.

Resetting the Password

In case you forgot your password, it can be reset in the following procedure.

- 1 Right-click the Software Operation Panel icon on the taskbar, and select [Password Setting] from the menu.

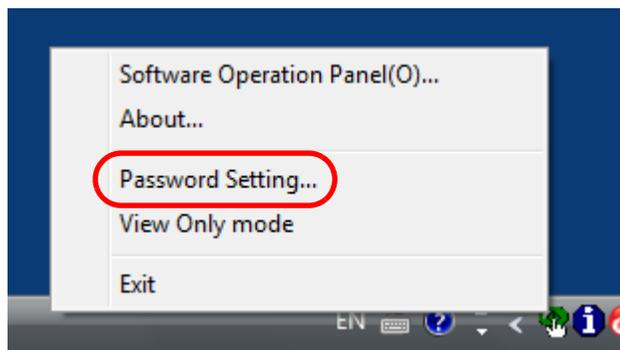

⇒ The [Password setting] dialog box appears.

- 2 Enter the default password which is "fi-scanner", and click the [OK] button.



⇒ The [Password setting] dialog box appears.

- 3 Enter a new password then again to confirm, and click the [OK] button.

Up to 32 characters can be used for the password.

Note that only alphanumeric characters (a to z, A to Z, 0 to 9) are allowed.



⇒ A confirmation message appears.

- 4 Click the [OK] button.

⇒ The password is set.

9.3 Configuration Items

The Software Operation Panel allows the configuration of the following settings for the scanner that is connected to the computer.

Device Setting

- 1 Start up the Software Operation Panel.
Refer to "9.1 Starting Up the Software Operation Panel" (page 153).
- 2 From the listing on the left, select [Device Setting].

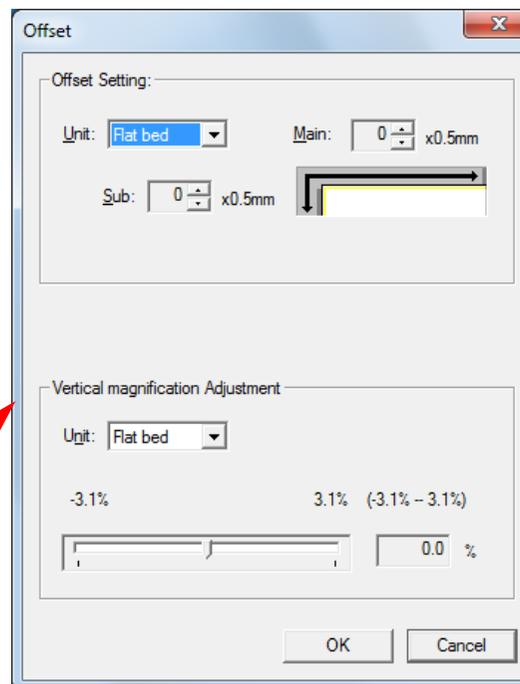
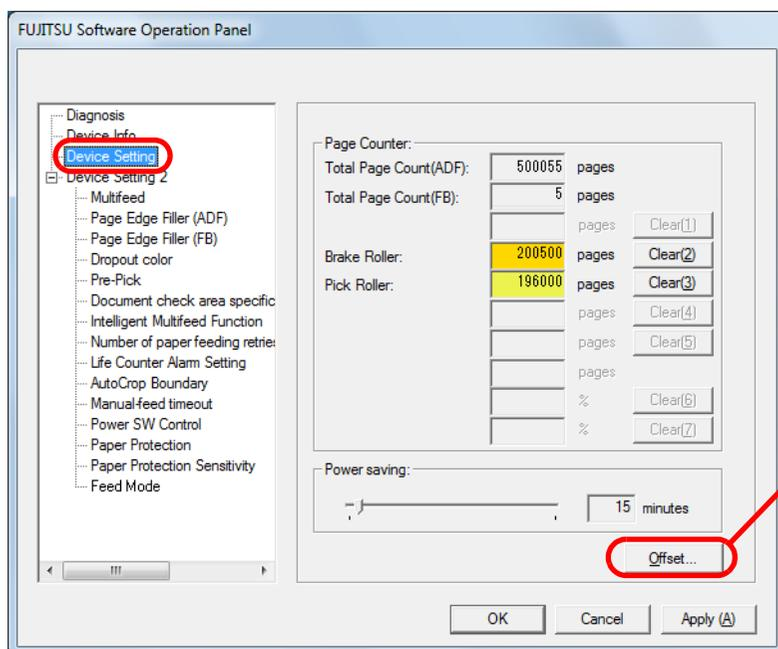

Items that can be configured in the above dialog box are shown in the next page.

Item	Description	Parameter/Value	Factory Default
Page Counter (page 166)	Check the counters to determine when to replace the consumables. Also use it to reset the counters after replacing the consumables.	Total Page Count(ADF) / Total Page Count(FB) (*1) / Brake Roller / Pick Roller	0
		Remaining Ink	(*2)
Power saving (page 187)	Specify the waiting time before entering power saving mode.	Range: 5 to 235 min. (in increments of 5)	15 min.
Offset Setting (page 169)	Adjust the position to start the scan on the selected scanning side(s).	Unit: Flat bed (*1) / ADF(front) / ADF(back) Main/Sub: -2 to +2 mm (in increments of 0.5)	Main/Sub: 0 mm
Vertical magnification Adjustment (page 169)	Adjust the magnification level in feed direction for the selected scanning method.	Unit: Flat bed (*1) / ADF Range: -3.1 to 3.1% (in increments of 0.1)	0%

*1: Displayed when using the fi-6230Z or fi-6240Z.

*2: Displayed when the imprinter is installed.

Device Setting 2

- 1 Start up the Software Operation Panel.
Refer to "9.1 Starting Up the Software Operation Panel" (page 153).
- 2 From the listing on the left, select [Device Setting 2].

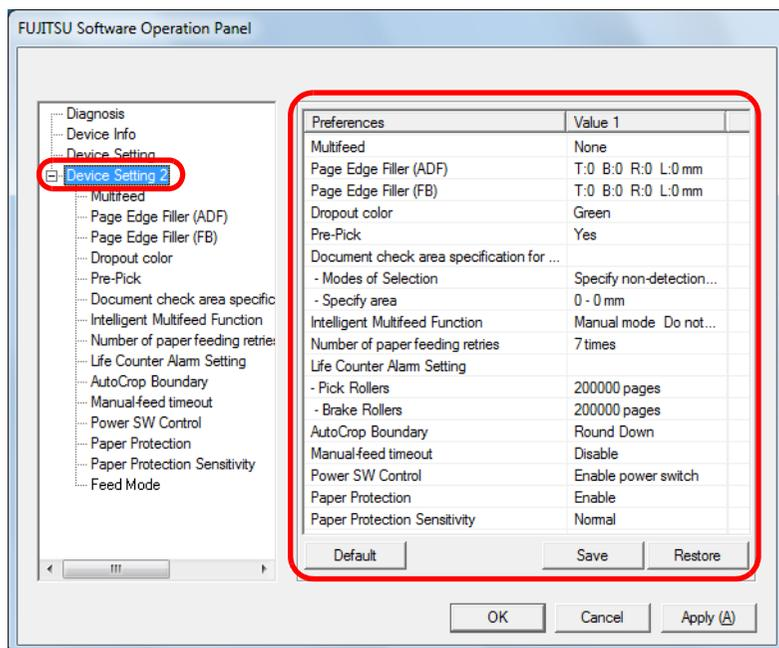

When you click on an item from the list, the details of the setting (parameters) are displayed on the right.

[Default] button resets the settings to factory default.

[Save] button saves the value configured in the Software Operation Panel to a file.

[Restore] button restores the file that contains the values configured in the Software Operation Panel.

Items that can be configured in the above dialog box are shown in the next page.

TOP

Contents

Index

Introduction

Scanner
OverviewHow to Load
DocumentsConfiguring the
Scan SettingsHow to Use the
Operator PanelVarious Ways to
Scan

Daily Care

Replacing the
Consumables

Troubleshooting

Operational
Settings

Appendix

Glossary

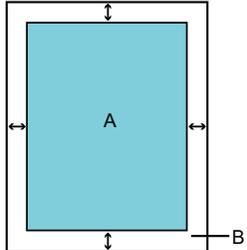
Item	Description	Parameter/Value	Factory Default
Multifeed (page 180)	Specify a method for multifeed detection. Detect multifeeds by monitoring the overlap, document length, or the combination of both. This setting can also be configured from the scanner driver's setup dialog box. Note that priority is given to the scanner driver setting.	None / Check Overlapping (Ultrasonic) / Check Length / Check Overlapping and Length Length (When [Check Length] is specified, select from 10/15/20 mm)	None Length: 10 mm
Page Edge Filler (ADF) Page Edge Filler (FB)(*1) (page 171)	Specify a width for the margin around the edge of the scanned image to fill in white or black, according to the background color. With TWAIN driver, this setting can also be configured from the scanner driver's setup dialog box. In that case, "Page Edge Filler" of the TWAIN driver is used on the output image.	ADF: Top / Left / Right: 0 to 15 mm Bottom: -7 to 7 mm (in increments of 1) FB (*1): Top / Bottom / Left / Right: 0 to 15 mm  (A: image, B: filled area, A+B: output)	Top/Bottom/Left/Right: 0 mm
Dropout color (page 173)	Select a color to be removed from the scanned image (only available in black & white or grayscale mode). With TWAIN driver, this setting can also be configured from the scanner driver's setup dialog box. Note that priority is given to the scanner driver setting. With ISIS driver, the scanner driver setting is enabled at all times.	Red / Green / Blue / None	Green
Pre-Pick (page 174)	Select [Yes] to prioritize the processing speed and [No] for otherwise. This setting can also be configured from the scanner driver's setup dialog box. Note that priority is given to the scanner driver setting.	Yes / No	Yes

Item	Description	Parameter/Value	Factory Default
Document check area specification for Multifeed Detection (page 182)	Selected range: Select this item to restrict the area to run multifeed detection.	[Selected range] check box	Not selected
	Enable / Disable (Middle): Specify whether to enable or disable multifeed detection in the selected area.	Enable / Disable (When [Selected range] is selected)	Disable
	Start (Middle): Specify the start position of the area in length (mm) from the leading edge of the document.	0 to 510 mm (in increments of 2)	0 mm
	End (Middle): Specify the end position of the area in length (mm) from the leading edge of the document.	0 to 510 mm (in increments of 2)	0 mm
Intelligent Multifeed Function (page 185)	When there is a paper of the same size attached to a designated location on the page, configure the scanner to memorize the location of the attachment and not detect multifeeds for that location. Note that you first need to select [Check Overlapping (Ultrasonic)] or [Check Overlapping and length] in either the scanner driver's setup dialog box or the multifeed detection setting in "Specifying a Multifeed Detection Method [Multifeed]" (page 180).	Manual mode / Auto mode 1 / Auto mode 2	Manual mode
	Select to clear the overlap pattern (length, location) memorized in Auto mode.	[Clear overlap pattern] check box	Not selected
	Specify whether or not to memorize the multifeed pattern upon power-off.	Remember / Do not remember	Do not remember
Number of paper feeding retries (page 175)	Configure this setting to change the number of feeding retries when a pick error occurs.	1 to 12 times	7 times
Life Counter Alarm Setting (page 168)	Specify the replacement cycle for the consumables.	Pick Rollers / Brake Rollers: 10,000 to 2,550,000 sheets (in increments of 10,000)	Pick Rollers: 200,000 sheets Brake Rollers: 200,000 sheets

Item	Description	Parameter/Value	Factory Default
AutoCrop Boundary (page 176)	Specify whether or not to optimize (round up/down) the fractional part of the scanned image data.	Optimize / Round Down	Optimize
Manual-feed timeout (page 186)	Select whether to disable or enable manual feeding.	Disable / Enable	Disable
	Paper-out detection time: Specify the waiting time to cancel manual feeding.	5, 10, 20, 30, 40, 50, 60, 70, 80, 90, 100, 110 (seconds)	10 seconds
Power SW Control (page 188)	Specify the method by which the scanner is powered on/off.	Enable power switch / Disable power switch / Enable USB power feeding	Enable power switch
Paper Protection (page 177)	Specify whether to enable or disable paper protection. Enabling this setting reduces the risk of having the documents damaged upon feeding errors, by stopping the scan when the scanner detects a document that is unusually warped. Paper protection is disabled in manual feed mode. This setting can also be configured from the scanner driver's setup dialog box. Note that priority is given to the scanner driver setting.	Enable / Disable	Enable
Paper Protection Sensitivity (page 178)	Specify the level of sensitivity to detect anomalies upon feeding the documents when paper protection is enabled.	Low / Normal / High	Normal
Feed Mode (*2) (page 179)	Configure this setting to scan plastic cards with a thickness up to 1.4 mm when using fi-6140Z/fi-6240Z (at 200 dpi (60 ppm) in landscape).	Normal / Thick cards (1.25 mm or more)	Normal

*1: Displayed when using the fi-6230Z or fi-6240Z.

*2: Displayed when using the fi-6140Z or fi-6240Z.

9.4 Settings Related to Page Counters

Checking and Resetting the Counters

■ Checking the counters

The status on each consumable part can be viewed to determine when to replace the consumables. The color of the counter changes to prompt replacement. The consumable counter turns light yellow when the page count after replacing the consumable reaches 95% of the value specified in "[Replacement Cycle of Consumables \[Life Counter Alarm Setting\]](#)" (page 168), and turns yellow when it reaches 100%. Note that the color does not change for ink counter (only displayed when imprinter is installed).

- 1 Start up the Software Operation Panel.
Refer to "[9.1 Starting Up the Software Operation Panel](#)" (page 153).
- 2 From the listing on the left, select [Device Setting].

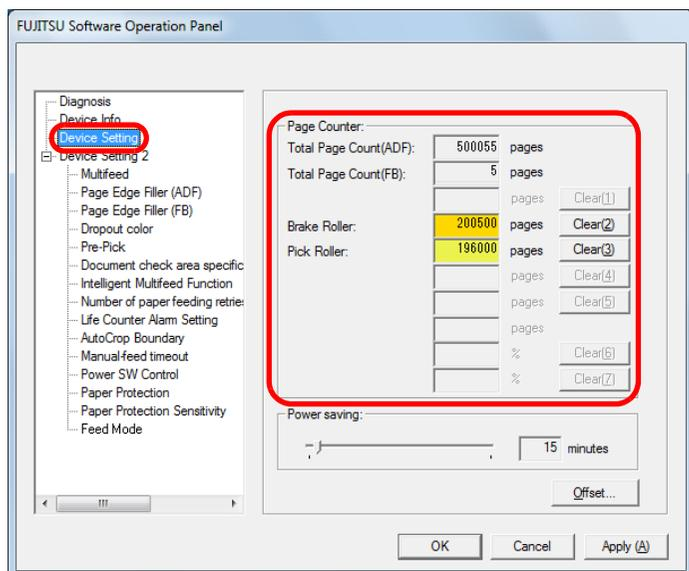

In this dialog box, you can check the following items:

Item	Description
Total Page Count (ADF)	Approximate total number of sheets scanned through the ADF
Total Page Count (FB) (fi-6230Z/fi-6240Z)	Approximate total number of sheets scanned on the flatbed (fi-6230Z/fi-6240Z)
Brake Roller	Number of sheets scanned after replacing the brake roller
Pick Roller	Number of sheets scanned after replacing the pick roller
Remaining Ink	Amount of ink remaining in the print cartridge of the imprinter (option) (Only displayed when imprinter is installed)



If the scanner was turned off by unplugging the power cable, or [Disable power switch] is selected, up to nine sheets may not be counted in [Total Page Count]. For details about disabling the power switch, refer to "[Method of Turning the Scanner ON/OFF \[Power SW Control\]](#)" (page 188).

Resetting the counters

When you have replaced a consumable, reset the corresponding counter in the following procedure.

- 1 Click the [Clear] button for the consumable that you replaced.

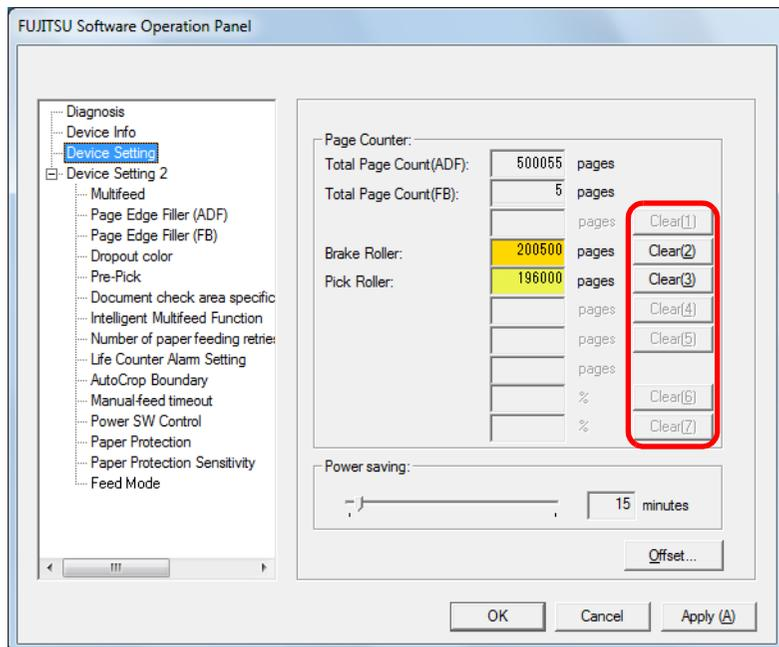

- ⇒ The counter is reset to 0.
For ink counter, the value will be set to 100.

- 2 Click the [OK] button in the Software Operation Panel.

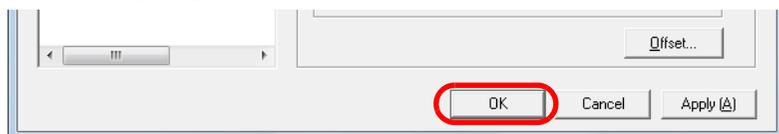

- ⇒ A confirmation message appears.

- 3 Click the [OK] button.
⇒ The settings are saved.

Message for replacing the consumable

The following message may appear while using the scanner.
Message

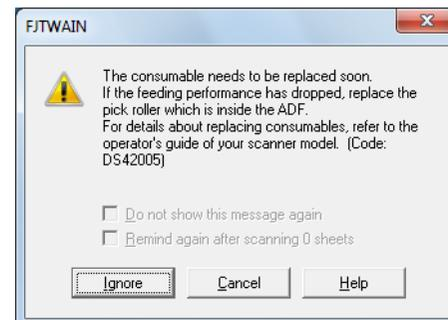

Check the message and replace the consumable accordingly.

If you click the [Ignore] button, the message disappears and the scan can be continued. However, it is recommended that you replace the consumable as soon as possible.

To stop the scan and replace the consumable right away, click the [Cancel] button.

For details about replacing consumables, refer to the following:

- ["7.2 Replacing the Brake Roller" \(page 119\)](#)
- ["7.3 Replacing the Pick Roller" \(page 121\)](#)

Replacement Cycle of Consumables [Life Counter Alarm Setting]

The replacement cycle for each consumable can be specified. The background color of the counter (in [Device Setting]) changes to light yellow when the page count after replacing the consumable reaches 95% of the value specified here, and turns yellow when it reaches 100%.

A message that prompts consumable replacement ([page 167](#)) also appears.

- 1 Start up the Software Operation Panel.
Refer to "9.1 Starting Up the Software Operation Panel" ([page 153](#)).
- 2 From the listing on the left, select [Device Setting 2] → [Life Counter Alarm Setting].

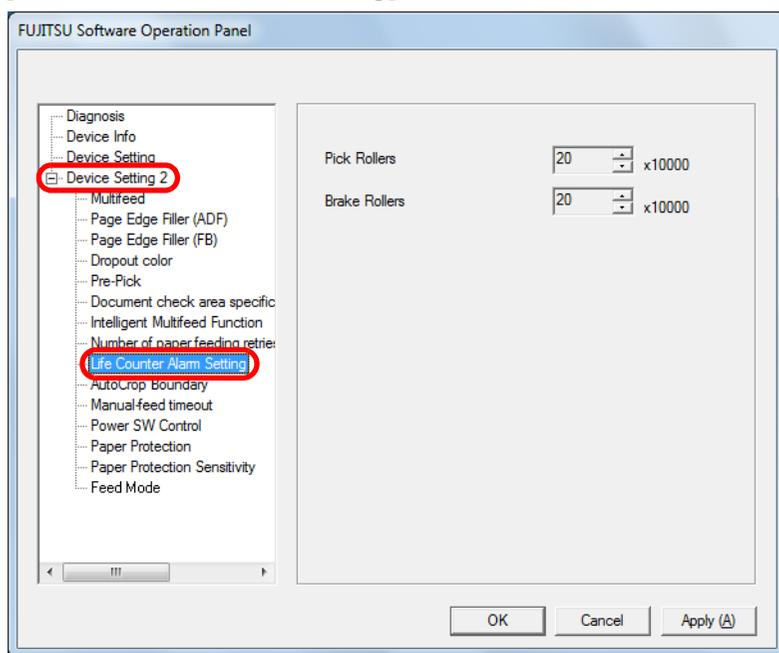

- 3 Specify a value as the replacement cycle.
The value can range from 10,000 to 2,550,000 sheets (in increments of 10,000).

TOP

Contents

Index

Introduction

Scanner
OverviewHow to Load
DocumentsConfiguring the
Scan SettingsHow to Use the
Operator PanelVarious Ways to
Scan

Daily Care

Replacing the
Consumables

Troubleshooting

Operational
Settings

Appendix

Glossary

9.5 Settings Related to Scanning

Adjusting the Position to Start the Scan [Offset/Vertical magnification Adjustment]

When the output position of the scanned image is not correct or the image appears shortened/elongated (vertically), adjust the offset and the vertical magnification in the following procedure.



Normally, you should not have to make any adjustments as the factory default settings are configured at appropriate values.

- 1 Start up the Software Operation Panel.
Refer to "9.1 Starting Up the Software Operation Panel" (page 153).

- 2 From the listing on the left, select [Device Setting] and click the [Offset] button.

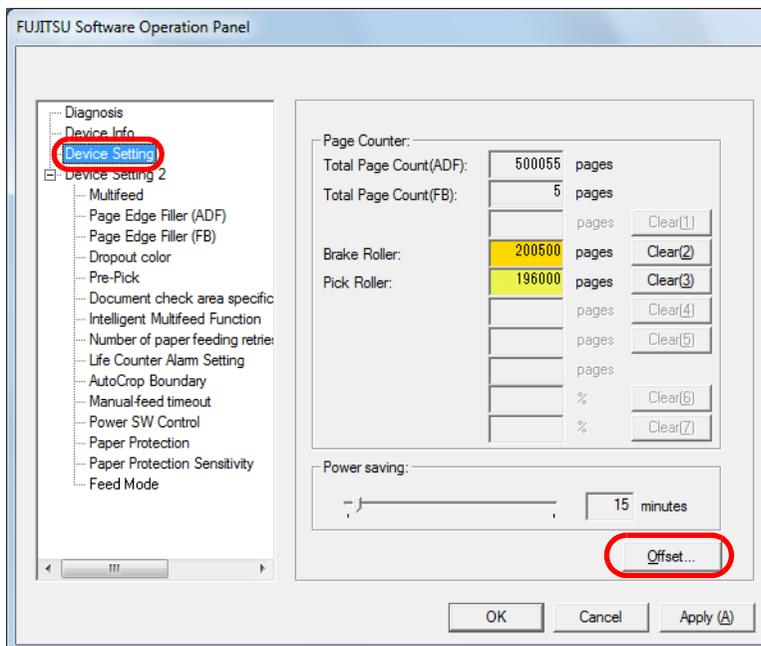

TOP

Contents

Index

Introduction

Scanner
OverviewHow to Load
DocumentsConfiguring the
Scan SettingsHow to Use the
Operator PanelVarious Ways to
Scan

Daily Care

Replacing the
Consumables

Troubleshooting

Operational
Settings

Appendix

Glossary

3 Adjust the level of offset/vertical magnification as needed.

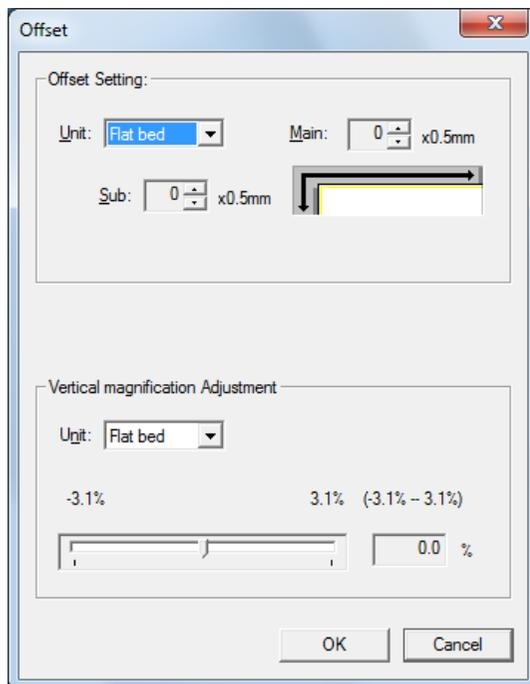

Offset Setting	Description
Unit	Select [Flat bed] (*1), [ADF (front)] or [ADF (back)] as the target for offset adjustment.
Main	Adjusts the horizontal (width) offset. The value can range from -2 to +2 mm (in increments of 0.5).
Sub	Adjusts the vertical (length) offset. The value can range from -2 to +2 mm (in increments of 0.5).

Vertical magnification Adjustment	Description
Unit	Select [Flat bed] (*1) or [ADF] as the target for vertical magnification adjustment.
Vertical magnification Adjustment (Sub: length)	Adjusts the vertical (length) magnification. The value can range from -3.1 to +3.1% (in increments of 0.1).

*1: Displayed when using fi-6230Z or fi-6240Z.

- TOP
- Contents
- Index
- Introduction
- Scanner Overview
- How to Load Documents
- Configuring the Scan Settings
- How to Use the Operator Panel
- Various Ways to Scan
- Daily Care
- Replacing the Consumables
- Troubleshooting
- Operational Settings
- Appendix
- Glossary

Removing Shadows/Streaks that Appear around the Scanned Image [Page Edge Filler (ADF)] / [Page Edge Filler (FB)] (fi-6230Z/fi-6240Z)

Depending on the condition of the documents that you scan, the shadow of the document may appear as black streaks. In that case, you can improve the image quality around the edges of the document by using the "Page Edge Filler" function to fill in the edges.

- 1 Start up the Software Operation Panel.
For details, refer to "9.1 Starting Up the Software Operation Panel" (page 153).
- 2 From the listing on the left, select [Device Setting 2] → [Page Edge Filler (ADF)] or [Page Edge Filler (FB)].

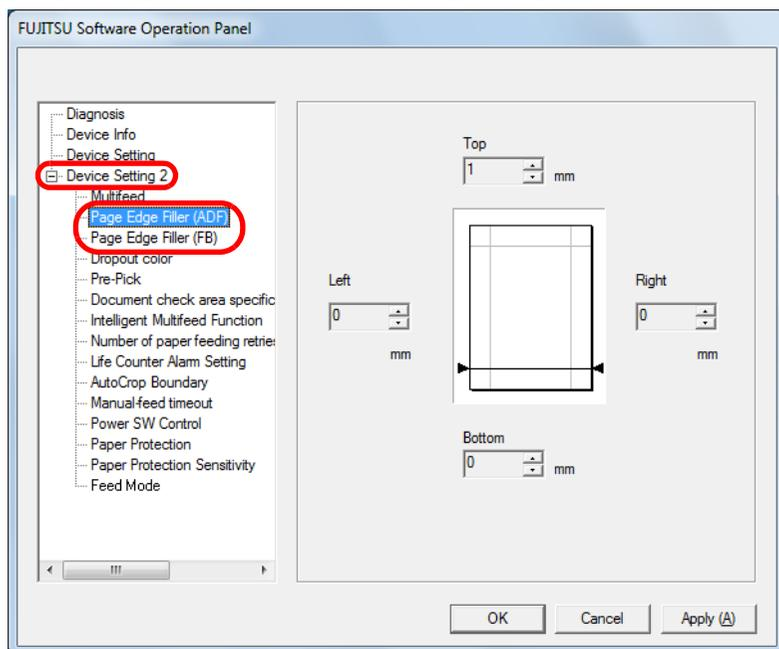

- 3 Specify the width of each margin to fill in: top/bottom/left/right.

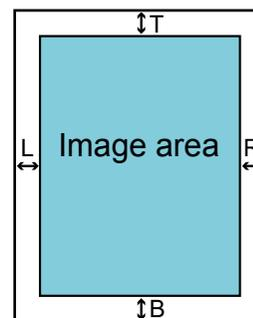

ADF

T : top = 0 to 15 mm
B : bottom = -7 to 7 mm
L : left = 0 to 15 mm
R : right = 0 to 15 mm

FB (fi-6230Z/fi-6240Z)

T : top = 0 to 15 mm
B : bottom = 0 to 15 mm
L : left = 0 to 15 mm
R : right = 0 to 15 mm

(in 1 mm increments)

The specified area is filled in white or black, according to the background color.



Note that if the target range of Page Edge Filler is too wide, some characters near the edge may appear missing.



- The color of the background is normally white. You can change it to [Black background] in the scanner driver. For example, in TWAIN driver, select the [Option] button → [Rotation] tab → [Automatic Size and Skew detection] and then specify [Black Background].
- Depending on the value you specify, the bottom edge is filled in as follows:
 - 1 to 7 mm
Fills the margin in white, from the detected page bottom.
 - -1 to -7 mm
Outputs the image without filling in the margin.
“Detected page bottom” refers to the bottom edge of the scanned document detected by the scanner.
- With TWAIN driver, this setting can also be configured from the scanner driver's setup dialog box. In that case, “Page Edge Filler” of the TWAIN driver is used on the output image.

TOP

Contents

Index

Introduction

Scanner
Overview

How to Load
Documents

Configuring the
Scan Settings

How to Use the
Operator Panel

Various Ways to
Scan

Daily Care

Replacing the
Consumables

Troubleshooting

Operational
Settings

Appendix

Glossary

Removing a Color from the Scanned Image [Dropout color]

With "Dropout color", you can select either green, red, or blue (primary colors) to remove the details of the selected color from a scanned image.

For example, if a document with black characters and a green background is scanned, only the black characters will appear on the scanned image if [Green] is selected.



Dropout works the best with light (low intensity) colors, and dark colors may not drop out.



Dropout color is only available in black & white or grayscale mode.

- 1 Start up the Software Operation Panel.
Refer to "9.1 Starting Up the Software Operation Panel" (page 153).

- 2 From the listing on the left, select [Device Setting 2] → [Dropout color].

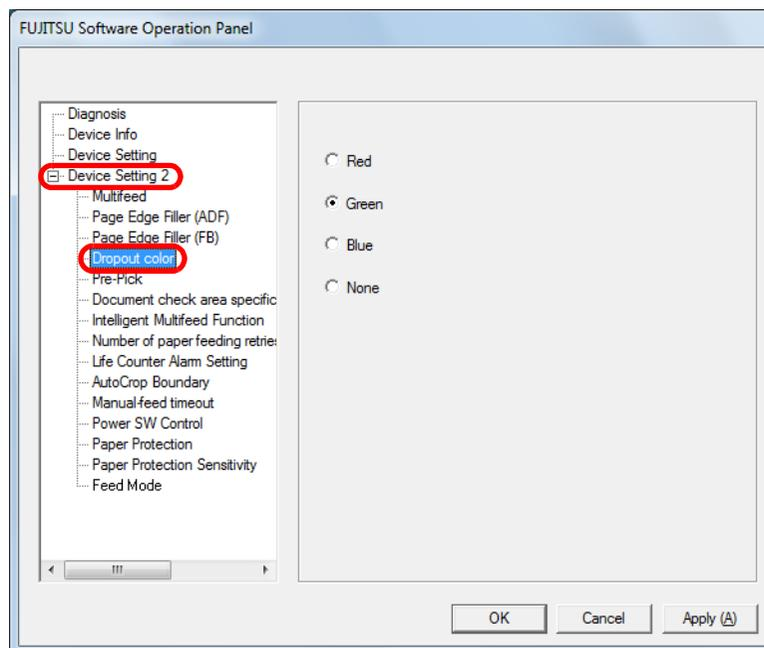

- 3 Select a color to drop out.

Red, Green, Blue : The selected color is dropped out.

None : No color is dropped out.



The Software Operation Panel allows you to choose the color from red, green, and blue only. To drop out a color of your choice, configure the setting from the scanner driver. For more details, refer to "[Removing a Color from the Scanned Image \(Dropout Color\)](#)" (page 82).



With TWAIN driver, this setting can also be configured from the scanner driver's setup dialog box. Note that priority is given to the scanner driver setting. With ISIS driver, the scanner driver setting is enabled at all times.

Shortening the Scanning Intervals [Pre-Pick]

"Pre-pick" refers to feeding the document to the starting position for scanning before the next scan.

Enabling [Pre-Pick] shortens the interval between scanning each document.

- 1 Start up the Software Operation Panel.
Refer to "9.1 Starting Up the Software Operation Panel" (page 153).
- 2 From the listing on the left, select [Device Setting 2] → [Pre-Pick].

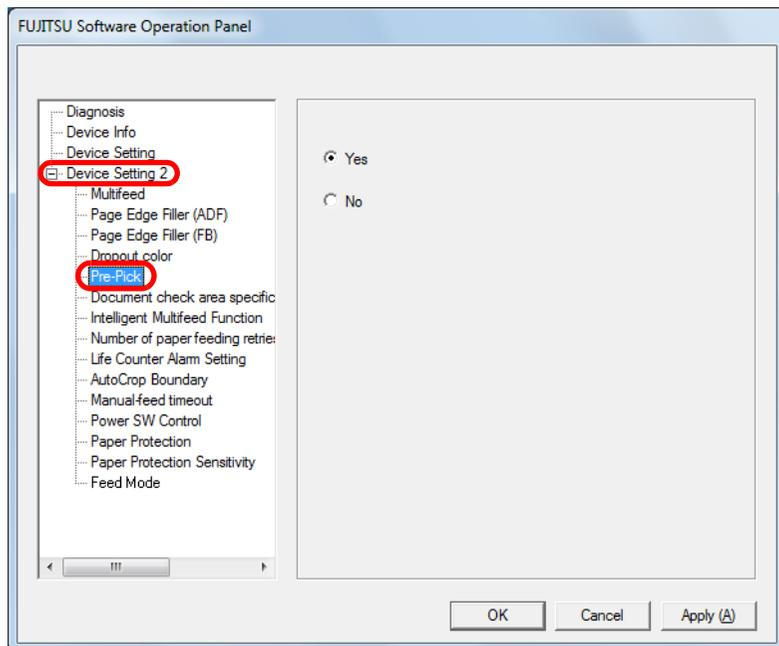

- 3 Select [Yes] or [No].



- If you cancel in the middle of scanning while pre-pick is enabled, you will have to remove the pre-picked document, then load the document again.
- This setting can also be configured from the scanner driver's setup dialog box. Note that priority is given to the scanner driver setting.

TOP

Contents

Index

Introduction

Scanner
OverviewHow to Load
DocumentsConfiguring the
Scan SettingsHow to Use the
Operator PanelVarious Ways to
Scan

Daily Care

Replacing the
Consumables

Troubleshooting

Operational
Settings

Appendix

Glossary

Number of Paper Feeding Retries

Configure this setting to change the number of feeding retries when a pick error occurs.

- 1 Start up the Software Operation Panel.
Refer to "9.1 Starting Up the Software Operation Panel" (page 153).
- 2 From the listing on the left, select [Device Setting 2] → [Number of paper feeding retries].

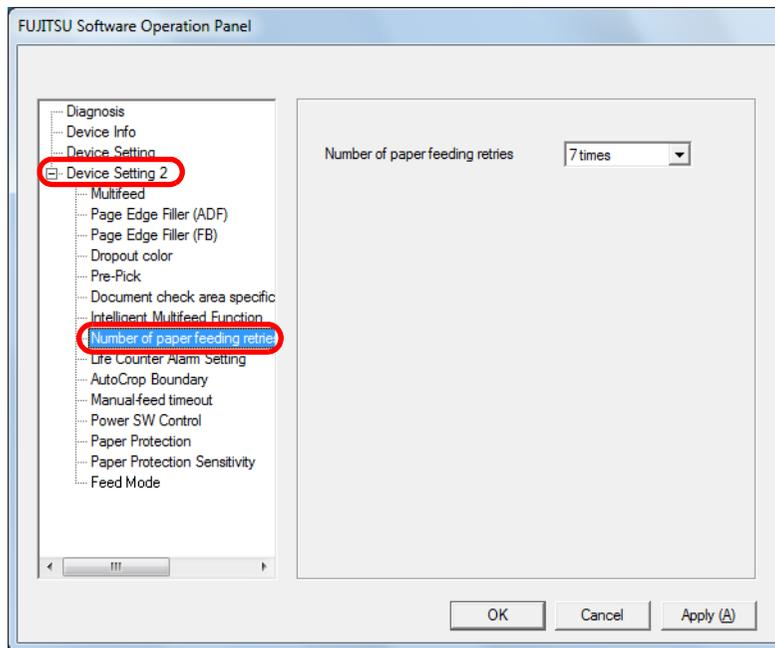

- 3 Specify the number of paper feeding retries.
The value can range from 1 to 12 times.

[TOP](#)[Contents](#)[Index](#)[Introduction](#)[Scanner
Overview](#)[How to Load
Documents](#)[Configuring the
Scan Settings](#)[How to Use the
Operator Panel](#)[Various Ways to
Scan](#)[Daily Care](#)[Replacing the
Consumables](#)[Troubleshooting](#)[Operational
Settings](#)[Appendix](#)[Glossary](#)

Cropping the Image Boundary [AutoCrop Boundary]

Some fractional data may be generated in the images in the process of scanning. You can specify whether to include or exclude such fractional data by using the "AutoCrop Boundary" function.

- 1 Start up the Software Operation Panel.
Refer to "9.1 Starting Up the Software Operation Panel" (page 153).
- 2 From the listing on the left, select [Device Setting 2] → [AutoCrop Boundary].

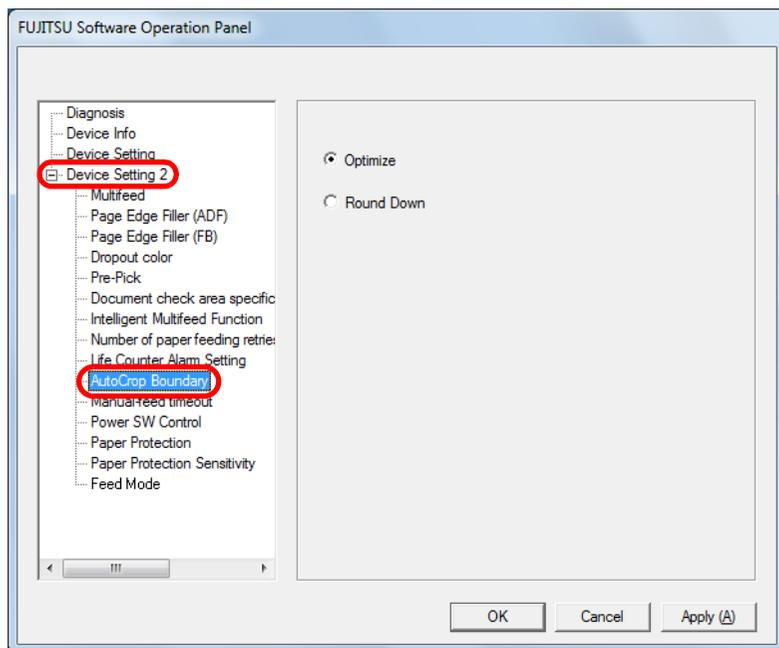

- 3 Select whether to include or exclude the fractional data. Select [Optimize] to prevent any exclusion of fractional data from scanned images.



- While selecting [Optimize] can prevent data loss, it may also generate black lines near the right edge.
- When you scan a document with text near the right edge while [Round Down] is selected, some pixel data there may be lost.
- For details about setting automatic page size detection, refer to "Automatically Correcting Skewed Images" (page 91).



This setting is only applied in black & white mode.

Protecting the Documents from Being Damaged [Paper Protection]

Specify whether to enable or disable paper protection.

Feeding errors during scanning could damage or tear valuable documents.

Enabling this setting reduces the risk of having the documents damaged upon feeding errors, by stopping the scan when the scanner detects a document that is unusually warped.

This function can be used to scan documents such as thin papers which are difficult to feed.

- 1 Start up the Software Operation Panel.
Refer to "9.1 Starting Up the Software Operation Panel" (page 153).
- 2 From the listing on the left, select [Device Setting 2] → [Paper Protection].

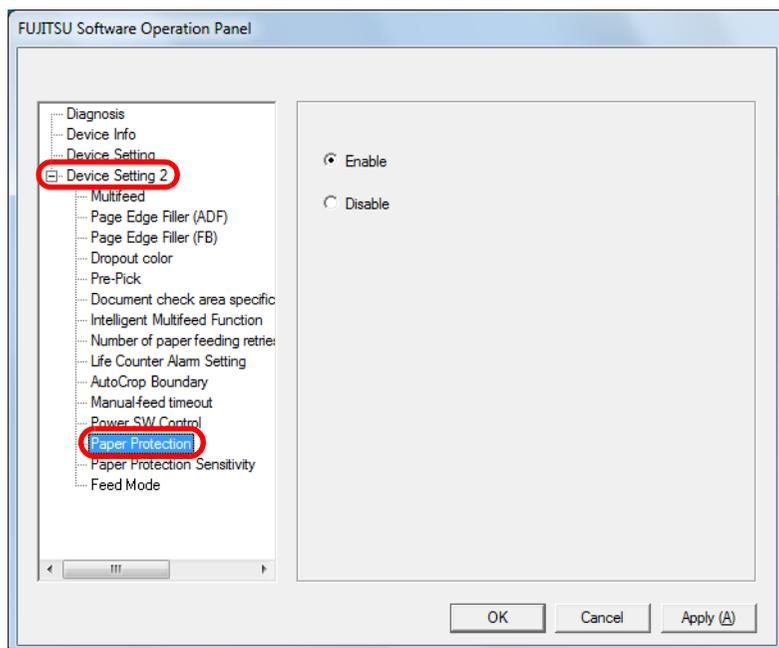

- 3 Specify whether to enable or disable paper protection.
When you select [Enable], the scanner stops the scan when it detects a document that is unusually warped.



- Note that paper protection is a function that suppresses the documents from being damaged, and does not guarantee all documents to be saved.
- When you enable paper protection, make sure to set the documents with their top edges aligned (especially for a mixed batch with different lengths). If the top edges are not aligned properly, the paper protection function may be activated and stop the scan even when the documents are being fed correctly.



- Paper protection is disabled in manual feed mode.
- This setting can also be configured from the scanner driver's setup dialog box. Note that priority is given to the scanner driver setting.

TOP

Contents

Index

Introduction

Scanner
OverviewHow to Load
DocumentsConfiguring the
Scan SettingsHow to Use the
Operator PanelVarious Ways to
Scan

Daily Care

Replacing the
Consumables

Troubleshooting

Operational
Settings

Appendix

Glossary

Specifying the Sensitivity Level for Paper Protection [Paper Protection Sensitivity]

You can specify the level of sensitivity to detect anomalies upon feeding the documents when paper protection is enabled.

Documents are deformed (e.g. warped, bent, creased) when they are not being fed by the rollers properly. To detect such a symptom and stop the scan, select [Low] to only detect documents that are highly deformed, and [High] to also detect documents that are slightly deformed.

- 1 Start up the Software Operation Panel.
Refer to "9.1 Starting Up the Software Operation Panel" (page 153).
- 2 From the listing on the left, select [Device Setting 2] → [Paper Protection Sensitivity].

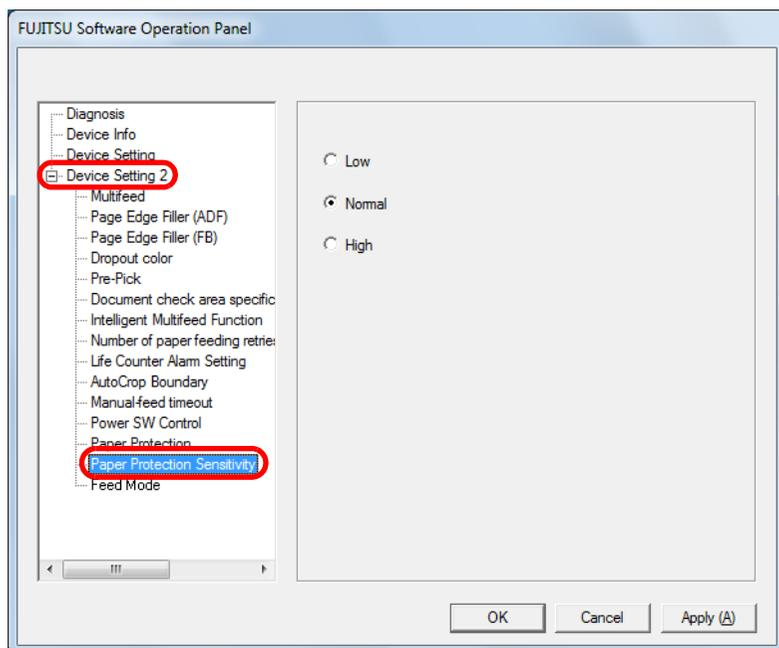

3 Specify the sensitivity level.

- Low : Decreases the sensitivity level to detect warped documents.
- Normal : Monitors the documents in normal sensitivity. Keep this setting for normal use.
- High : Increases the sensitivity level to detect warped documents.



If paper jams occur frequently, specify [Low].

TOP

Contents

Index

Introduction

Scanner
OverviewHow to Load
DocumentsConfiguring the
Scan SettingsHow to Use the
Operator PanelVarious Ways to
Scan

Daily Care

Replacing the
Consumables

Troubleshooting

Operational
Settings

Appendix

Glossary

Scanning Thick Plastic Cards [Feed Mode] (fi-6140Z/fi-6240Z)

When you use fi-6140Z/fi-6240Z to scan at 200 dpi (60 ppm) in landscape, plastic cards with a thickness up to 1.4 mm can be scanned.

- 1 Start up the Software Operation Panel.
Refer to "9.1 Starting Up the Software Operation Panel" (page 153).
- 2 From the listing on the left, select [Device Setting 2] → [Feed Mode].

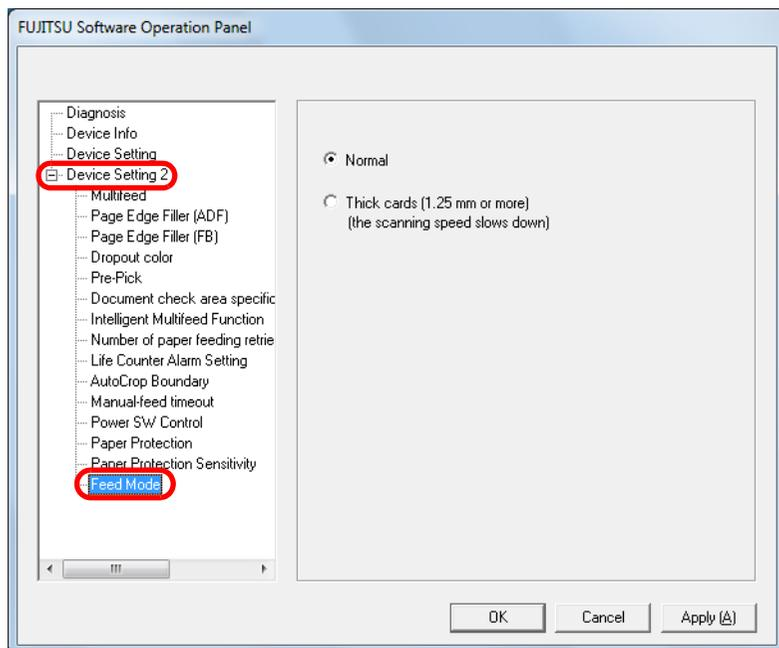

- 3 Specify the feed mode.
To scan a plastic card up to 1.4 mm thick, select [Thick cards (1.25 mm or more)].



Scanning speed slows down when you select [Thick cards (1.25 mm or more)].

TOP

Contents

Index

Introduction

Scanner
OverviewHow to Load
DocumentsConfiguring the
Scan SettingsHow to Use the
Operator PanelVarious Ways to
Scan

Daily Care

Replacing the
Consumables

Troubleshooting

Operational
Settings

Appendix

Glossary

9.6 Settings Related to Multifeed Detection

Specifying a Multifeed Detection Method [Multifeed]

Multifeed is an error where two or more sheets are fed through the ADF at once. It is also called a multifeed when a different document length is detected.

Not noticing multifeed errors while scanning may put you in a situation where important data are missing from the scanned images. Multifeed detection can be used to prevent such troubles. When this function is enabled, an error message is displayed as soon as it detects a multifeed, and stops the scan. Note that multifeed cannot be detected within 30 mm from the leading edge of the document.

- 1 Start up the Software Operation Panel.
Refer to "9.1 Starting Up the Software Operation Panel" (page 153).

- 2 From the listing on the left, select [Device Setting 2] → [Multifeed].

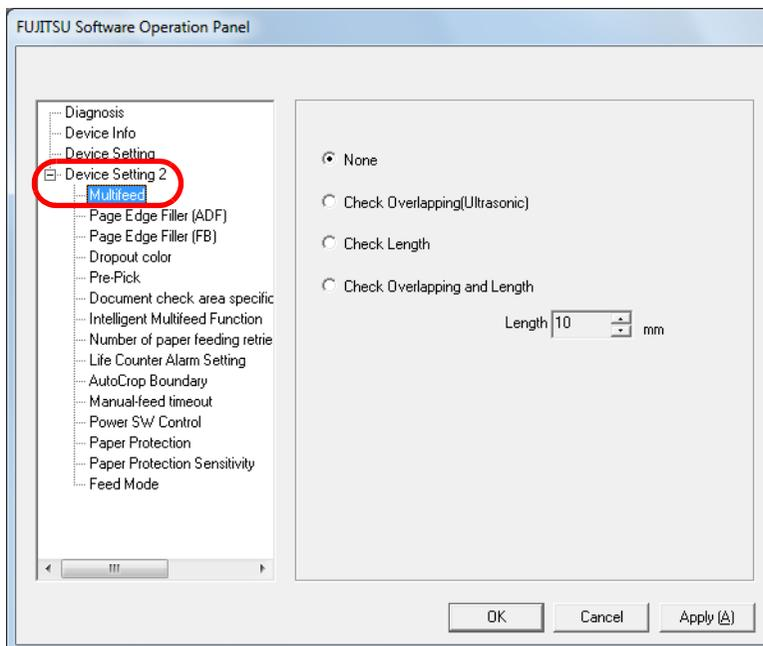

TOP

Contents

Index

Introduction

Scanner
OverviewHow to Load
DocumentsConfiguring the
Scan SettingsHow to Use the
Operator PanelVarious Ways to
Scan

Daily Care

Replacing the
Consumables

Troubleshooting

Operational
Settings

Appendix

Glossary

3 Select a detection method.

Method	Description
None	Does not detect multifeed.
Check Overlapping (Ultrasonic)	<p>Detects multifeed by the overlapping of documents. When this is selected, you can also specify the two following options:</p> <ul style="list-style-type: none"> Specify the detection range by the length from the top of the document. Proceed to "Specifying the Area to Detect Multifeed [Document check area specification for Multifeed Detection]" (page 182) for more details. Ignore the multifeed when there is paper of the same size attached to a designated location on the page. Proceed to "Ignoring Multifeed for a Set Pattern" (page 105) for more details.
Check Length	<p>Detects multifeed by the difference in length of the documents. Note that multifeeds cannot be detected accurately when scanning a mixed batch of different sizes.</p>

Method	Description
Check Overlapping and Length	<p>Detects multifeed by the combination of [Check Overlapping (Ultrasonic)] and [Check Length]. Note that multifeeds cannot be detected accurately when scanning a mixed batch of different sizes. When this is selected, you can also specify the two following options:</p> <ul style="list-style-type: none"> Specify the detection range by the length from the top of the document. Proceed to "Specifying the Area to Detect Multifeed [Document check area specification for Multifeed Detection]" (page 182) for more details. Ignore the multifeed when there is paper of the same size attached to a designated location on the page. Proceed to "Ignoring Multifeed for a Set Pattern" (page 105) for more details.
Length	Select a length difference from 10/15/20 mm. Any length under the specified value will not be detected as multifeed.



- To scan documents with different lengths, specify [Check Overlapping (Ultrasonic)].
- When a photograph or a piece of paper is attached on the document, the overlapping part of the document may be falsely detected as multifeed if [Check Overlapping (Ultrasonic)] is specified. In that case, specify [Check Length].
Note however that [Check Overlapping (Ultrasonic)] can still be used by restricting the detection range.
- Multifeed cannot be detected when using the Carrier Sheet.



This setting can also be configured from the scanner driver's setup dialog box. Note that priority is given to the scanner driver setting.

Specifying the Area to Detect Multifeed [Document check area specification for Multifeed Detection]

The following setting is only available when you specified [Check Overlapping (Ultrasonic)] or [Check Overlapping and Length].

- From the listing on the left, select [Device Setting 2] → [Document check area specification for Multifeed Detection].
Select the [Selected range] check box in the dialog box.

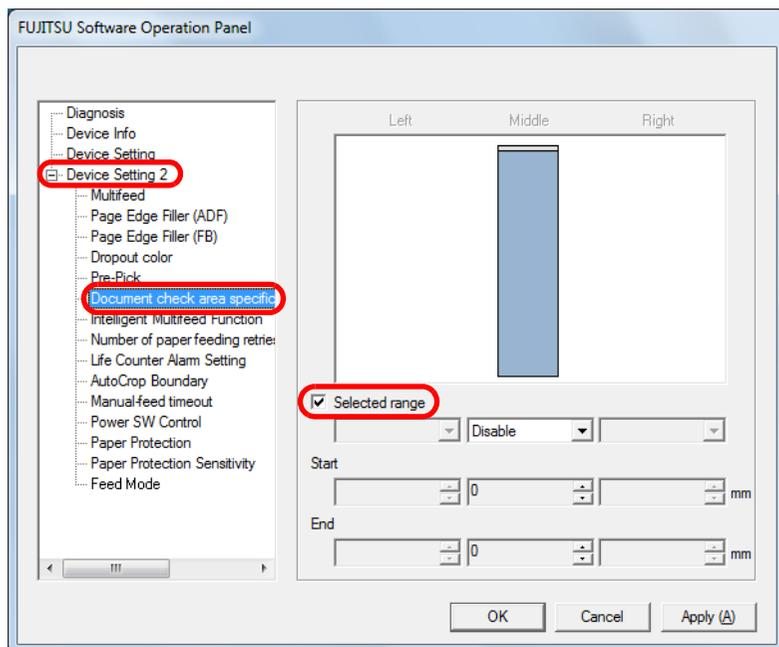

- Specify the detection range.

Range	Description
Selected range	<p>Select the check box to specify the detection range (colored in light blue) in the picture below.</p> <p style="text-align: center;">Middle</p> <p style="text-align: right;">Unit: mm</p> <p>Select the check box to enable the setting in this dialog box. Clear the check box to disable the setting. Clearing this check box sets both start and end positions to "0", making the whole document to be detected for multifeeds. The above condition applies when the document is set to the center of the pick roller width.</p>
Disable (Middle)	Does not detect multifeeds for the selected area.
Enable (Middle)	Detects multifeeds for the selected area.
Start (Middle)	Displays the start position of the detection by the length from the leading edge of the document. Range: 0 to 510 mm, in 2 mm increments, Start<End
End (Middle)	Displays the end position of the detection by the length from the leading edge of the document. Range: 0 to 510 mm, in 2 mm increments, Start<End



- When both [Start] and [End] are set to "0", multifeed detection is performed for the whole area regardless of whether it is enabled or disabled.
- To disable multifeed detection for the whole document, select [Disable] and set the start position to "0" and the end position to equal the document length or longer.
- If you set a value larger than the document length for the start position, selecting [Disable] detects the whole length of the document and selecting [Enable] disables the multifeed detection.
- To detect multifeeds, the detection range must be at least 5 mm in length. Configure the setting so that the value of the end position minus the start position is 6 mm or more.
- You can also set the start and the end positions by the following methods:
 - Draw an area with the mouse on the displayed image.
 - Drag the handles for [Start] and [End] positions on the displayed image.

Example 1:

Position: Middle

Selected range = Enable, Start = 50 mm, End = 200 mm

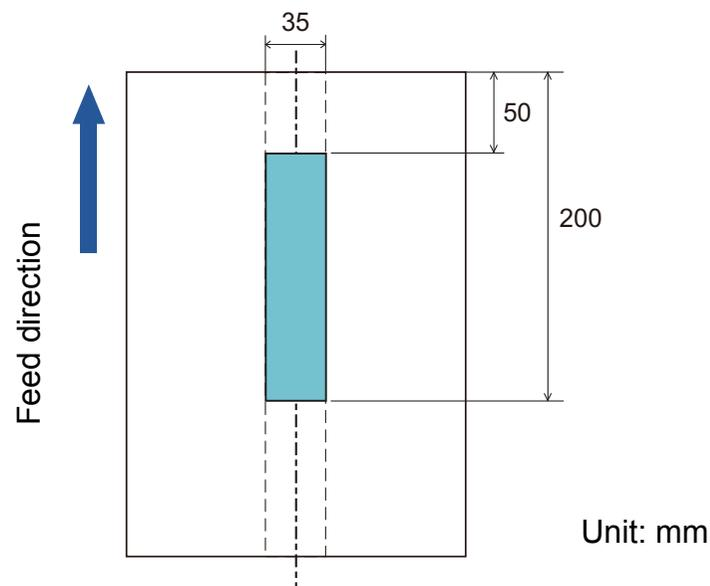

Multifeeds are detected for the area in light blue.

[TOP](#)
[Contents](#)
[Index](#)
[Introduction](#)
[Scanner
Overview](#)
[How to Load
Documents](#)
[Configuring the
Scan Settings](#)
[How to Use the
Operator Panel](#)
[Various Ways to
Scan](#)
[Daily Care](#)
[Replacing the
Consumables](#)
[Troubleshooting](#)
[Operational
Settings](#)
[Appendix](#)
[Glossary](#)

Example 2:

Position: Middle

Selected range = Enable, Start = 0 mm, End = 0 mm

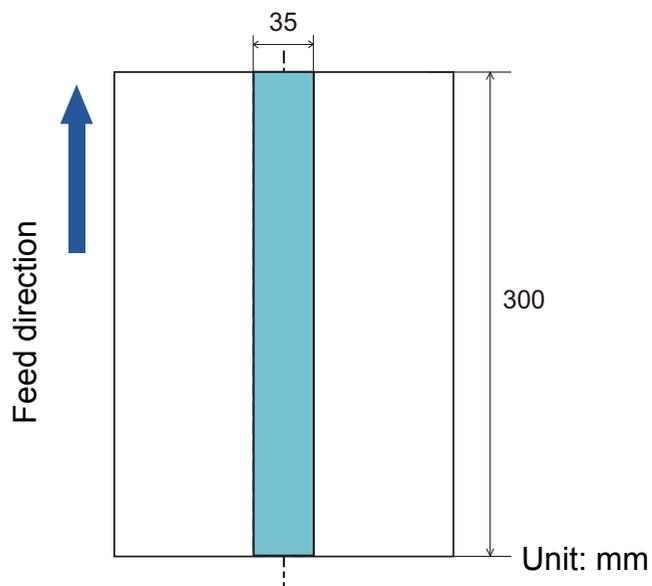

Multifeeds are detected for the area in light blue.

 When you use detection by overlapping, accuracy of multifeed detection may drop if the documents are glued tightly or attached together by static electricity.

Example 3: (Bad example)

Position: Middle

Selected range = Enable, Start = 100 mm, End = 102 mm

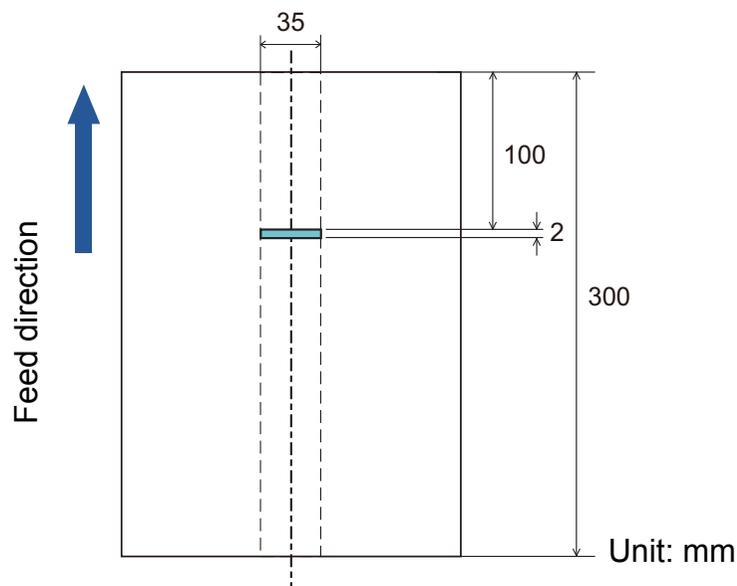

Since the detection range (length) is less than 5 mm, multifeeds cannot be detected accurately.

- TOP
- Contents
- Index
- Introduction
- Scanner Overview
- How to Load Documents
- Configuring the Scan Settings
- How to Use the Operator Panel
- Various Ways to Scan
- Daily Care
- Replacing the Consumables
- Troubleshooting
- Operational Settings
- Appendix
- Glossary

Specifying an Area Not to Detect Multifeed [Intelligent Multifeed Function]

When there is paper of the same size attached to a designated location on the page, the scanner memorizes the location of the attachment and can be configured not to detect multifeeds for that location. Note that you first need to select [Check Overlapping (Ultrasonic)] or [Check Overlapping and length] in either the scanner driver's setup dialog box or the multifeed detection setting in "[Specifying a Multifeed Detection Method \[Multifeed\]](#)" (page 180).

- 1 Start up the Software Operation Panel.
Refer to "[9.1 Starting Up the Software Operation Panel](#)" (page 153).
- 2 From the listing on the left, select [Device Setting 2] → [Intelligent Multifeed Function].

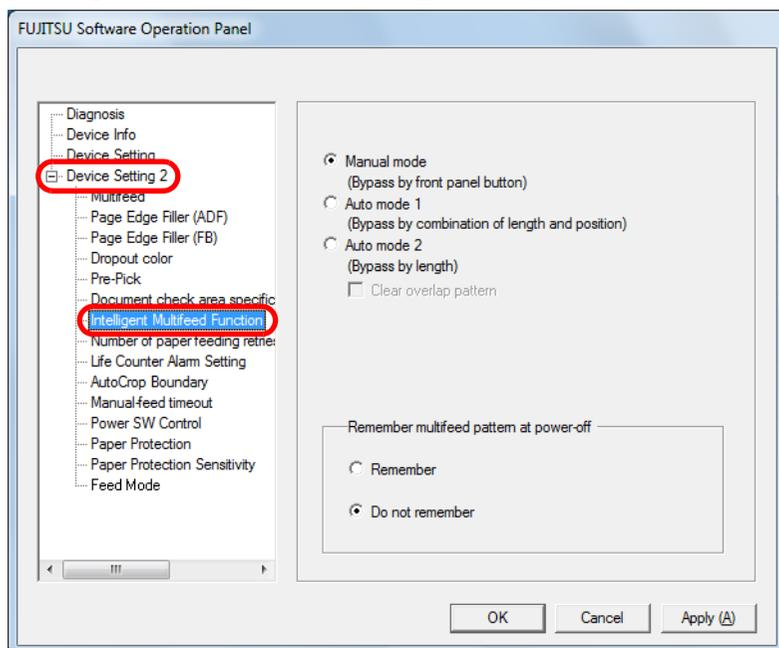

- 3 Select an operation mode and click the [OK] button.

Mode	Description
Manual mode	Does not memorize the size or location of the paper attachment when a multifeed is detected. Ignores the multifeed when you load the documents back in the ADF paper chute and scan them again.
Auto mode 1	Memorizes the size and location of the paper attachment when a multifeed is detected. The memorized pattern is ignored from the next scan.
Auto mode 2	Memorizes the size of the paper attachment when a multifeed is detected. The memorized pattern (including any length less than the attachment) is ignored from the next scan.



- By selecting the [Clear overlap pattern] check box, you can erase the overlapping patterns (length, position) that were memorized in Auto mode.
- In [Remember multifeed pattern at power-off], you can select whether or not to keep the multifeed pattern upon turning the power off. When [Remember] is selected, you can use eight (pages worth) of the most recent patterns the next time the scanner is powered on.

For details about the procedure after this step, refer to "[Ignoring Multifeed for a Set Pattern](#)" (page 105).

9.7 Settings Related to Waiting Time

Waiting Time in Manual Feed Mode [Manual-feed timeout]

When you scan by manually loading one sheet at a time, you can specify the waiting time (interval) for loading the next document in the ADF paper chute. This enables continuous scanning as long as you load a document within the set time. If not, the scan is finished automatically and manual feeding will be canceled. Note that you can also press the [Send to] button on the operator panel to cancel manual feeding.

- 1 Start up the Software Operation Panel.
Refer to "9.1 Starting Up the Software Operation Panel" (page 153).
- 2 From the listing on the left, select [Device Setting 2] → [Manual-feed timeout].

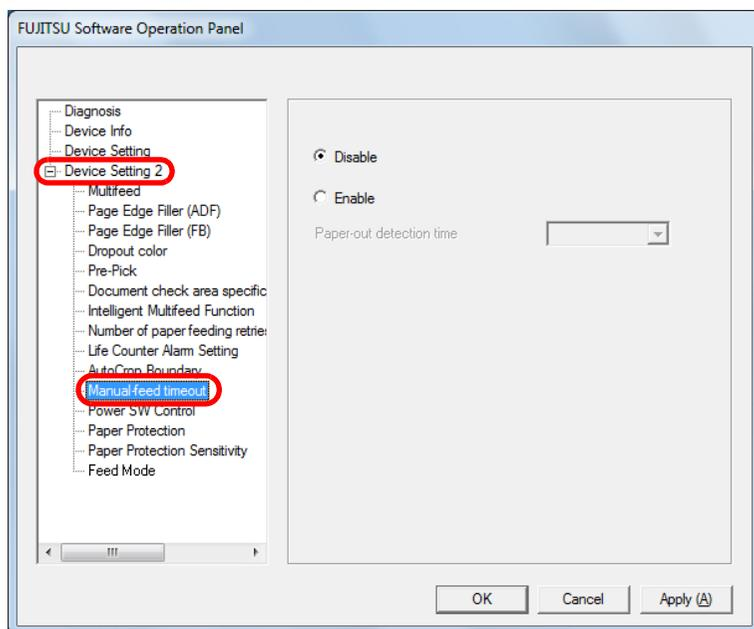

- 3 Specify whether to enable or disable [Manual-feed timeout].
If you selected [Enable], then also specify the time in [Paper-out detection time].



When [Manual-feed timeout] is enabled, the scanner will wait for the set time even if you start scanning with no document in the ADF paper chute.

TOP

Contents

Index

Introduction

Scanner
OverviewHow to Load
DocumentsConfiguring the
Scan SettingsHow to Use the
Operator PanelVarious Ways to
Scan

Daily Care

Replacing the
Consumables

Troubleshooting

Operational
Settings

Appendix

Glossary

Waiting Time to Enter Power Saving Mode [Power saving]

The waiting time for the scanner to enter power saving mode can be specified.

- 1 Start up the Software Operation Panel.
Refer to "9.1 Starting Up the Software Operation Panel" (page 153).
- 2 From the listing on the left, select [Device Setting].

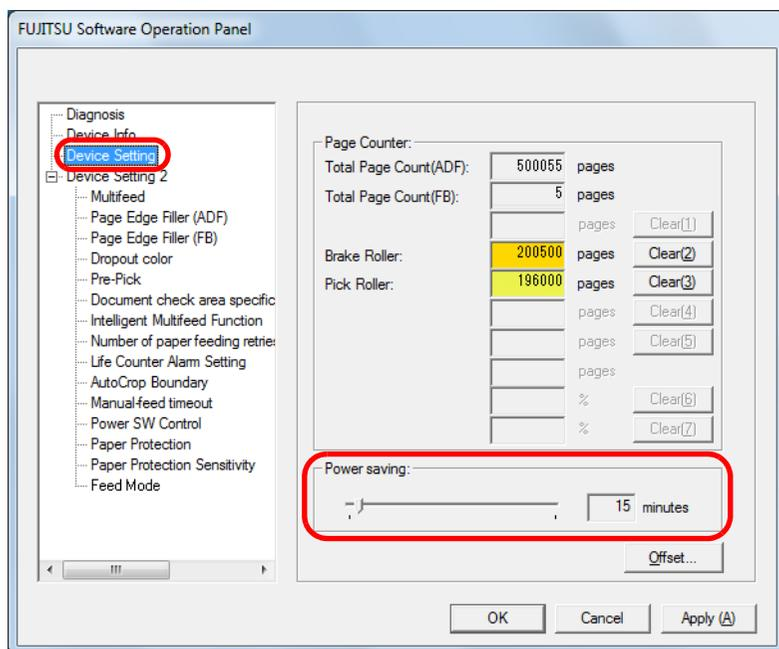

- 3 Use the slider to specify the waiting time before entering power saving mode.
The value can range from 5 to 235 minutes (in increments of 5).

TOP

Contents

Index

Introduction

Scanner
OverviewHow to Load
DocumentsConfiguring the
Scan SettingsHow to Use the
Operator PanelVarious Ways to
Scan

Daily Care

Replacing the
Consumables

Troubleshooting

Operational
Settings

Appendix

Glossary

9.8 Settings Related to Power ON/OFF

Method of Turning the Scanner ON/OFF [Power SW Control]

The method by which the scanner is powered on/off can be specified from one of the following:

- Press the [Power] button on the operator panel
- Unplug the power cable then plug it back in
- Have the scanner turn on/off in sync with the computer's power

- 1 Start up the Software Operation Panel.
Refer to "9.1 Starting Up the Software Operation Panel" (page 153).
- 2 From the listing on the left, select [Device Setting 2] → [Power SW Control].

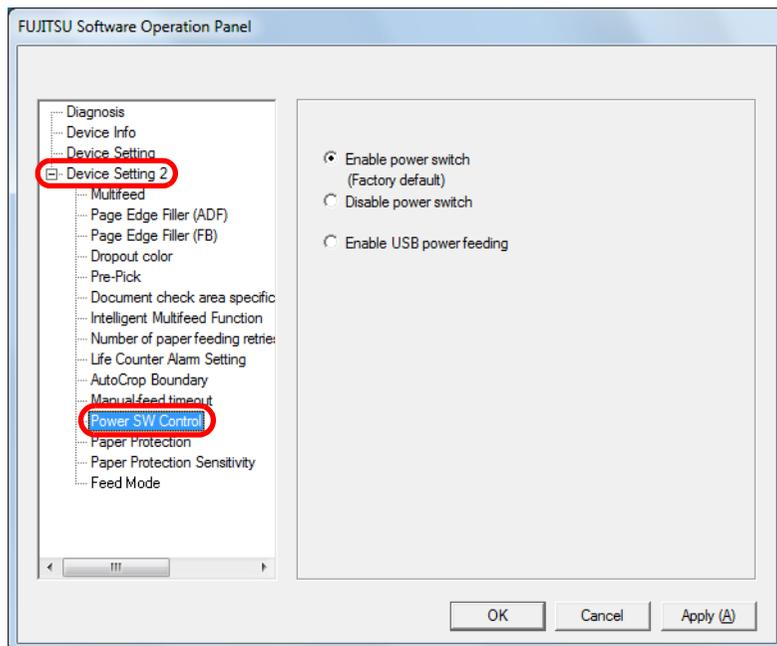

- 3 Select one of the following:
 - [Enable power switch] : Press the [Power] button on the operator panel.
 - [Disable power switch] : Unplug the power cable then plug it back in.
 - [Enable USB power feeding] : Have the scanner turn ON/OFF in sync with the computer's power.



Some types of computers and USB hubs keep supplying power to the USB bus even after the computer is turned off. In that case, the [Enable USB power feeding] mode may not work properly.

TOP

Contents

Index

Introduction

Scanner
OverviewHow to Load
DocumentsConfiguring the
Scan SettingsHow to Use the
Operator PanelVarious Ways to
Scan

Daily Care

Replacing the
Consumables

Troubleshooting

Operational
Settings

Appendix

Glossary

Appendix

This appendix provides the following information.

A.1 Basic Specification	190
A.2 Installation Specification	193
A.3 Outer Dimensions	195
A.4 Scanner Options	196
A.5 Uninstalling the Software	197

[TOP](#)

[Contents](#)

[Index](#)

[Introduction](#)

[Scanner
Overview](#)

[How to Load
Documents](#)

[Configuring the
Scan Settings](#)

[How to Use the
Operator Panel](#)

[Various Ways to
Scan](#)

[Daily Care](#)

[Replacing the
Consumables](#)

[Troubleshooting](#)

[Operational
Settings](#)

[Appendix](#)

[Glossary](#)

A.1 Basic Specification

Item			Specification				Notes
			fi-6130Z	fi-6230Z	fi-6140Z	fi-6240Z	
Scanner type			ADF	ADF + Flatbed	ADF	ADF + Flatbed	-
Image sensor			Color CCD ×2 (front, back)	Color CCD ×3 (front, back, flatbed)	Color CCD ×2 (front, back)	Color CCD ×3 (front, back, flatbed)	-
Light source			White cold cathode fluorescent lamp ×2 (front, back)	White cold cathode fluorescent lamp ×3 (front, back, flatbed)	White cold cathode fluorescent lamp ×2 (front, back)	White cold cathode fluorescent lamp ×3 (front, back, flatbed)	-
Scanning area	Minimum	ADF	52 × 74 (mm) / 2.05 × 2.91 (in.) (landscape/portrait)				(*1)
	Maximum	ADF	216 × 355.6 (mm) / 8.5 × 14 (in.)				(*2)
		Flatbed	-	216 × 297 (mm) / 8.5 × 11.69 (in.)	-	216 × 297 (mm) / 8.5 × 11.69 (in.)	-
Paper weight (thickness)			41 to 209 g/m ² (11 to 56 lb) 127 to 209 g/m ² (34 to 56 lb) for A8 size 1.4 mm or less for plastic cards (*3)				(*4)

Item		Specification				Notes
		fi-6130Z	fi-6230Z	fi-6140Z	fi-6240Z	
Scanning speed (A4 landscape) (*5)	Binary (black & white)	Simplex: 40 ppm Duplex : 80 ipm		Simplex: 60 ppm Duplex : 120 ipm		200 dpi
	Grayscale					
	Color					
	Binary (black & white)	Simplex: 30 ppm Duplex : 60 ipm		Simplex: 40 ppm Duplex : 80 ipm		300 dpi
	Grayscale					
	Color					
Loading capacity (*6)		50 sheets				Paper weight: 80 g/m ² (20 lb) Total thickness: 5 mm or less
Optical resolution		600 dpi				-
Output resolution	Binary (black & white)	50 to 600 dpi, 1200 dpi				50 to 600 dpi: configurable in 1 dpi increments 1200 dpi: available from scanner driver
	Grayscale					
	Color					
Grayscale level		8-bit for each color				10-bit during internal processing
Halftone pattern		Dither/error diffusion				-
Interface (*7)(*8)		USB 2.0/1.1 (*9)				B Type
		-		Ultra SCSI		Shielded 50-pin high-density type
Other		Hardware real-time JPEG compression				-

*1: The minimum scanning area (A8 size) only applies to using the ADF. There is no limitation when using the flatbed.

*2: Long page scanning supports documents with a length up to 3,048 mm (120 in.).

For documents longer than 864 mm (34.02 in.), the resolution must be set to 200 dpi or less.

*3: Up to 1.25 mm is supported for scanning at 200 dpi (60 ppm) in landscape when using fi-6140Z/fi-6240Z. This setting can be changed in the Software Operation Panel to scan plastic cards with a thickness up to 1.4 mm.

For details, refer to "[Scanning Thick Plastic Cards \[Feed Mode\] \(fi-6140Z/fi-6240Z\)](#)" (page 179).

*4: The paper weight only applies to using the ADF. There is no limitation when using the flatbed.

*5: Note that this is the hardware limitation, and the software's processing time such as data transfer time is added to the actual time of scanning.

*6: The capacity varies depending on the paper weight. See "[2.3 Documents for Scanning \(ADF\)](#)" (page 41) for details.

*7: USB 2.0/1.1 and Ultra SCSI interfaces cannot be used at the same time.

*8: You cannot connect multiple computers to the scanner using both types of interface cables at the same time.

*9: Connection with USB 2.0 requires the USB port and the hub to support USB 2.0. Also note that the scanning speed slows down when using USB 1.1.

TOP

Contents

Index

Introduction

Scanner
Overview

How to Load
Documents

Configuring the
Scan Settings

How to Use the
Operator Panel

Various Ways to
Scan

Daily Care

Replacing the
Consumables

Troubleshooting

Operational
Settings

Appendix

Glossary

A.2 Installation Specification

Item		Specification				
		fi-6130Z	fi-6230Z	fi-6140Z	fi-6240Z	
Outer dimensions (W × D × H) (*1)		301 × 160 × 158 (mm) / 15.75 × 31.5 × 17.72 (in.)	301 × 567 × 229 (mm) / 15.75 × 31.5 × 17.72 (in.)	301 × 160 × 158 (mm) / 15.75 × 31.5 × 17.72 (in.)	301 × 567 × 229 (mm) / 15.75 × 31.5 × 17.72 (in.)	
Installation space (W × D × H) (*2)		400 × 700 × 380 (mm) / 15.75 × 27.56 × 14.96 (in.)	400 × 800 × 450 (mm) / 15.75 × 31.5 × 17.72 (in.)	400 × 700 × 380 (mm) / 15.75 × 27.56 × 14.96 (in.)	400 × 800 × 450 (mm) / 15.75 × 31.5 × 17.72 (in.)	
Weight		4.2 kg (9.26 lb)	8.8 kg (19.4 lb)	4.2 kg (9.26 lb)	8.8 kg (19.4 lb)	
Input power	Voltage range	100 Vac ±10%				
	Phase	Single phase				
	Frequency range	50/60 ±3 Hz				
Power consumption	Operation	ADF	38 W or less		42 W or less	
		Flatbed	-	45 W or less	-	50 W or less
	Power saving		5.36 W or less		5.70 W or less	
	Power OFF		1.0 W or less			
Ambient condition	Temperature	Operating: 5 to 35°C (41 to 95°F), Not operating: -20 to 60°C (-4 to 140°F)				
	Humidity	Operating: 20 to 80% Not operating: 8 to 95%				
Calorific value	Operation	ADF	32.7 kcal/Hr or less		36.2 kcal/Hr or less	
		Flatbed	-	38.7 kcal/Hr or less	-	43.0kcal/Hr or less
	Power saving		5.2 kcal/Hr or less			
	Power OFF		0.86 kcal/Hr or less			
Shipping weight (*3)		6.5 kg (14.33 lb)	13.0 kg (28.66 lb)	6.5 kg (14.33 lb)	13.0 kg (28.66 lb)	

*1: The depth excludes the ADF paper chute and stacker.

*2: The required installation space is a reference for scanning A4 size documents.

*3: Includes the package weight.

TOP

Contents

Index

Introduction

Scanner
Overview

How to Load
Documents

Configuring the
Scan Settings

How to Use the
Operator Panel

Various Ways to
Scan

Daily Care

Replacing the
Consumables

Troubleshooting

Operational
Settings

Appendix

Glossary

A.3 Outer Dimensions

The outer dimensions are as follows:

fi-6130Z/fi-6140Z

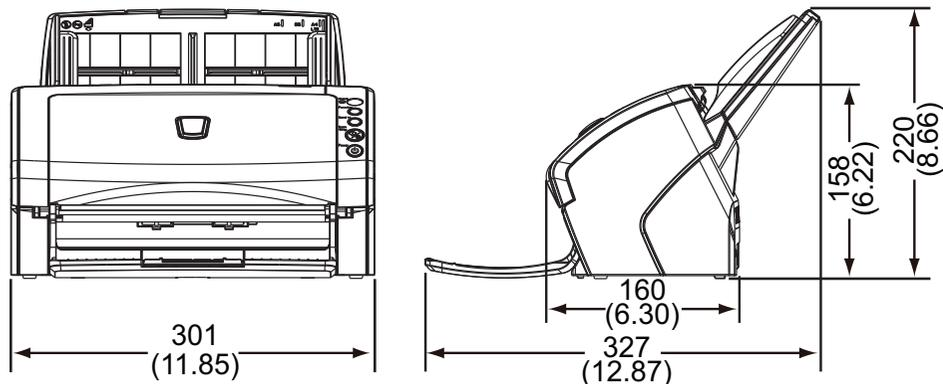

Unit: mm (in.)

fi-6230Z/fi-6240Z

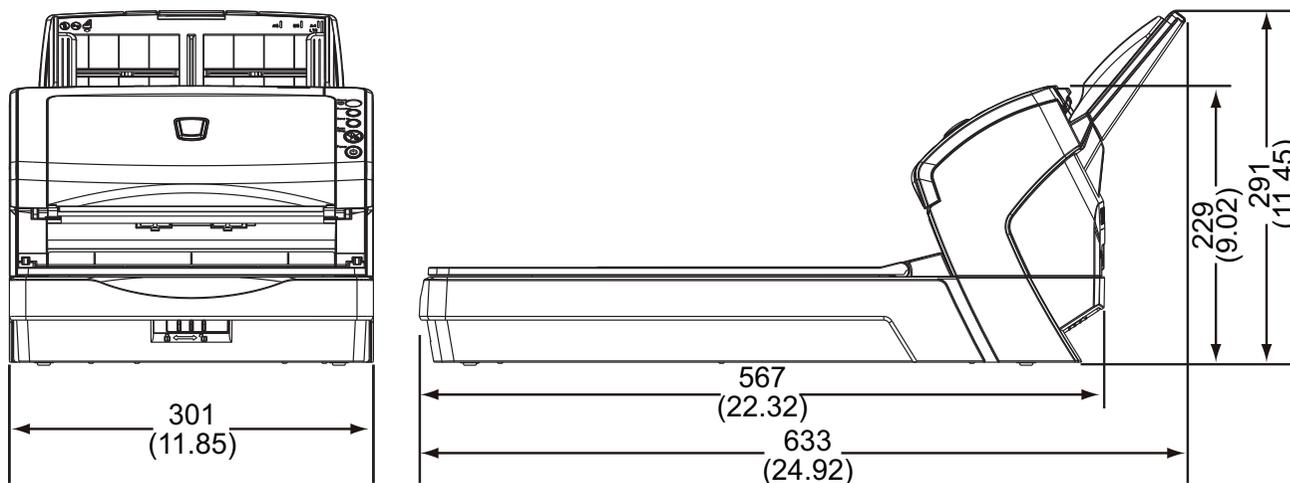

Unit: mm (in.)

TOP

Contents

Index

Introduction

Scanner
Overview

How to Load
Documents

Configuring the
Scan Settings

How to Use the
Operator Panel

Various Ways to
Scan

Daily Care

Replacing the
Consumables

Troubleshooting

Operational
Settings

Appendix

Glossary

A.4 Scanner Options

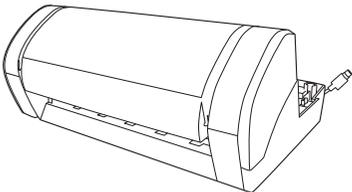
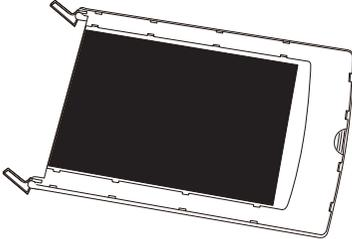
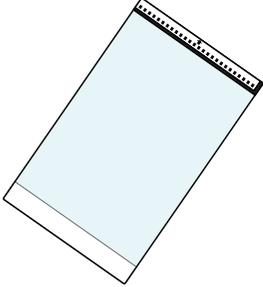
Name	Model	Supported model	Description
Imprinter 	FI-614PR	fi-6130Z fi-6140Z	An option imprinter that can print text (e.g. alphabets, numbers) on the back of the document after scanning. It can be used to organize your documents by printing a name, date or serial number on the scanned document. For more details, refer to the fi-614PR Imprinter Operator's Guide.
Black document pad 	FI-624BK	fi-6230Z fi-6240Z	An option that enables scanning in black background on the flatbed. It is available as a document cover with a black document pad, and can be replaced with the standard document cover that has a white document pad. It can be used to automatically correct skewed images or accurately detect the size of the document when scanning with the flatbed.
ScanSnap Carrier Sheet 	PA03360-0013	fi-6130Z fi-6230Z fi-6140Z fi-6240Z	Use this option to scan documents larger than A4/Letter size, as well as non-standard size documents such as photographs and clippings. When the bundled Carrier Sheet (×1) is too damaged or worn out to be used for scanning, it can be purchased separately (5 sheets per set). The Carrier Sheet should be replaced approximately every 500 scans. However, replace it if damage or dirt is noticeable.

For details about purchasing the scanner options and more information, contact your FUJITSU scanner dealer or an authorized FUJITSU scanner service provider.

A.5 Uninstalling the Software

1 Turn on the computer.



Log on as a user with administrator privileges.

2 Exit all running software.

3 Select the [Start] menu → [Control Panel].

⇒ The [Control Panel] dialog box appears.

4 Select [Uninstall a Program].

⇒ The [Programs and Features] dialog box appears with a list of the currently installed software.

5 Select a software to uninstall.

- TWAIN driver: [Scanner Utility for Microsoft Windows]
- ISIS driver: [ISIS Driver - Fujitsu fi-6x30Z/fi-6x40Z]
- Kofax VRS: [Kofax VRS]
- Software Operation Panel: [Software Operation Panel]
(Software Operation Panel is installed together with TWAIN driver/ ISIS driver/Kofax VRS)
- Error Recovery Guide: [Error Recovery Guide - Fujitsu fi-6x30Z/fi-6x40Z]
- Image Processing Software Option (Trial): Uninstall by referring to the Image Processing Software Option User's Guide.
- ScandAll PRO: [Fujitsu ScandAll PRO]
After ScandAll PRO and ScanSnap mode, you can also remove Scan to Microsoft SharePoint and ABBYY FineReader for ScanSnap™.
- ScanSnap mode: [Fujitsu ScandAll PRO ScanSnap mode Add-in]
- Microsoft SharePoint: [Scan to Microsoft SharePoint]
- ABBYY FineReader for ScanSnap™: [ABBYY FineReader for ScanSnap(TM)]
- QuickScan Pro: [QuickScan]
- Operating manuals: [fi-Scanner manuals for fi-6x30Z/fi-6x40Z]

- Scanner Central Admin Agent: Uninstall by referring to the Scanner Central Admin 4.0 User's Guide.

- Adobe® Reader®: [Adobe Reader]
- FUJITSU Scanner USB HotFix: [FUJITSU Scanner USB HotFix]

6 Click the [Uninstall] button or the [Uninstall/Change] button.

7 If a confirmation message appears, click [OK] or [Yes].

⇒ The software is uninstalled.



The windows that appear and the operations differ by the operating system that you are using.

TOP

Contents

Index

Introduction

Scanner
Overview

How to Load
Documents

Configuring the
Scan Settings

How to Use the
Operator Panel

Various Ways to
Scan

Daily Care

Replacing the
Consumables

Troubleshooting

Operational
Settings

Appendix

Glossary

Glossary

A

A4 size
A5 size
A6
A7
A8 size
ADF (Automatic Document Feeder)
Automatic size/skew detection

B

Blank Page Skip
Brake roller
Brightness

C

Canadian DOC
Carrier Sheet
CCD (Charge-Coupled Device) Image Sensor
Color balance

D

Default setting
Density
Device Errors
Dither
Double Letter size

dpi (dots per inch)
Driver
Dropout color
Duplex scanning mode

E

Edge Extract
Edge Processing
Eject roller
Energy Star
Error diffusion

F

FCC
Feed roller
Filter
Flatbed

G

Gamma
Grayscale

H

Halftone

I

Image processing
Imprinter
Intelligent Multifeed Function

Interface

Inversion

ISIS

J

Job Separator

L

Landscape
Letter size

M

Moiré patterns
Multi Image
Multifeed

N

Noise removal

O

OCR (Optical Character Recognition)
Operating environment
Operator panel
Optical sensor
Overscan

P

Paper jam
Paper protection
Patch code

Pick roller

Pick start time

Pixel

Portrait

Pre-pick

R

Resolution

S

SCSI
SCSI ID
Simplex scanning mode
Smoothing

T

Temporary error
Threshold

TÜV

TWAIN

U

Ultrasonic sensor
USB

W

White reference sheet

Z

Zone OCR

TOP

Contents

Index

Introduction

Scanner
Overview

How to Load
Documents

Configuring the
Scan Settings

How to Use the
Operator Panel

Various Ways to
Scan

Daily Care

Replacing the
Consumables

Troubleshooting

Operational
Settings

Appendix

Glossary

A

A4 size

A standard paper size which is 210 × 297 mm (8.27 × 11.7 in.).

A5 size

A standard paper size which is 148 × 210 mm (5.83 × 8.27 in.).

A6

A standard paper size which is 105 × 148 mm (4.13 × 5.83 in.).

A7

A standard paper size which is 74 × 105 mm (2.91 × 4.13 in.).

A8 size

A standard paper size which is 52 × 74 mm (2.05 × 2.91 in.).

ADF (Automatic Document Feeder)

A paper feeding mechanism which allows multiple sheets of documents to be scanned one sheet at a time.

Automatic size/skew detection

End of Page Detection:

Detects the end of the page and scans the length of the document.

Automatic Page Size Detection:

Detects the paper size and outputs the image data in the same size.

Black Background:

Sets the background color to black for scanning.

B

Blank Page Skip

A function that detects and automatically deletes blank (white or black) pages in a batch of documents.

Brake roller

A roller that prevents more than one sheet of documents to be fed into the ADF at once.

Brightness

Refers to the brightness of a scanned image.

C

Canadian DOC

A standard issued by Industry Canada, a department of the Canadian government, which sets out the technical requirements relative to the radiated and conducted radio noise emissions from digital apparatus.*****

Carrier Sheet

A transparent plastic sheet designed for scanning documents that are larger than A4/ Letter size.

CCD (Charge-Coupled Device) Image Sensor

A sensor which perceives the light reflected from the document and converts it into digital form. CCD technology is the basis of high quality image acquisition in scanners, cameras and other devices.

Color balance

The balance of colors in an image.

D

Default setting

(Hardware)

Preset values from the factory.

(Software)

Values set upon installation of software.

Density

Refers to the deepness of a color in an image.

Device Errors

The following are lists of device errors which require troubleshooting by a service engineer.

Dither

The process by which a group of dots is arranged to reproduce the density of grayscale. Grayscale density is reproduced by configuring preset dot patterns. This method requires less memory compared to multilevel gray.

Double Letter size

A standard paper size used in the United States and other countries (11 × 17 in.).

dpi (dots per inch)

A measurement of resolution which is used for scanners and printers. Higher dpi indicates better resolution.

Driver

A program specifically designed for operating systems, which enables interaction with a hardware device.

Dropout color

A function which removes a specified color from a scanned image.

Duplex scanning mode

A mode for scanning both sides of the document at once. (↔ simplex scanning mode)

E

Edge Extract

A function which traces the boundaries between black and white areas, and extracts them as outlines.

Edge Processing

A function which decreases the density of bright colors (except for white) around black areas. Increasing the value for this function removes dotted image noise and also produces “softened” images.

Eject roller

Rollers that feed documents from the ADF onto the stacker.

Energy Star

ENERGY STAR is an international standard for energy-efficient electronic equipment which was established by the US Environmental Protection Agency (EPA) in 1992. The standard program has now been adopted by countries around the world.

Error diffusion

Method of halftone (pseudo-grayscale) image processing which is based on black & white pixel binarization. It sums the optical density of a pixel and its adjacent pixels, then relocates black pixels in the order of density to minimize the difference between scanned and output images. By diffusing the errors onto other pixels, the density data of adjacent pixels can be binarized. This function suppresses moire patterns of dotted halftone images such as newspapers, and reproduces its grayscale gradation.

F

FCC

Acronym for "The Federal Communications Commission", an independent United States government agency which is in charge of regulating interstate and international communications via radio, television, wire, satellite and cable. The Part 15 of the FCC regulations mentioned in this manual is designed to prevent harmful interferences on radio communication of radio receivers and other devices which radiate radio frequency energy, and provides for the certification of radio receivers. It also provides the certification of low power transmitters and the operation of certified transmitters without a license.

Feed roller

A roller that feeds the document through the ADF.

Filter

Refers to the following types of processing on a scanned image.

Digital Endorser:

Adds alphanumeric character strings on the scanned image data.

Page Edge Filler:

Fills in the margins of the scanned image in a specified color.

Flatbed

An input device of the scanner.

Used to scan documents that cannot be scanned in the ADF, such as books and magazines.

[TOP](#)[Contents](#)[Index](#)[Introduction](#)[Scanner
Overview](#)[How to Load
Documents](#)[Configuring the
Scan Settings](#)[How to Use the
Operator Panel](#)[Various Ways to
Scan](#)[Daily Care](#)[Replacing the
Consumables](#)[Troubleshooting](#)[Operational
Settings](#)[Appendix](#)[Glossary](#)

G

Gamma

A unit which indicates the changes in the brightness of an image. It is expressed as a function of the electric input power to devices (e.g. scanner, display) and the brightness of the image. If the gamma rate is larger than 1, the brightness of an image increases and vice versa. Normally, the gamma rate is set to 1 when reproducing the same brightness as the original.

Grayscale

A method which expresses the gradation (density) from black to white in 256 levels. Suitable for scanning images such as photographs.

H

Halftone

Reproduces the color density in black & white by using dot patterns. This method is effective for scanning images such as photographs in black & white.

I

Image processing

Refers to processing and outputting the scanned image via specified scan parameters.

Imprinter

A printer that can print text (e.g. alphabets, numbers) on the back of the scanned document. It can be used to manage the documents by adding a name, date or serial number on the scanned document.

Intelligent Multifeed Function

A function that excludes certain patterns of overlapping of documents that is detected as multifeed, by letting the scanner memorize the overlap pattern. For instance, when there is paper of the same size attached to a designated location on the page, the scanner memorizes the location of the attachment and can be configured not to detect multifeeds for that location.

Interface

The connection that allows communication between the computer and the scanner.

Inversion

A scanning method in which the black part and the white part of the image are inverted.

ISIS

ISIS (Image Scanner Interface Specification) is an API (Application Program Interface) standard for imaging devices (e.g. scanners, digital cameras) which was developed by Captiva, a division of EMC Corporation (the former Pixel Translations) in 1990. In order to use devices that comply with this standard, it is necessary to install a driver software that supports ISIS standard.

J

Job Separator

A sheet to insert between documents in a batch for separating different jobs.

The following types of job separators are available:

Job separator with patch codes:

A sheet with patch codes printed.

Job separator with barcodes:

A sheet with barcode(s) printed.

L

Landscape

Orientation in which the short side of the document is set parallel to the feed direction.

Letter size

A standard paper size used in the United States and other countries (8.5 × 11 in.).

M

Moiré patterns

Recurrent patterns on scanned images caused by incorrect settings of angles.

Multi Image

A function which outputs the image in both color/grayscale and black & white at once.

Multifeed

Multifeed is an error when two or more sheets are fed through the ADF at once. It is also called a multifeed when a different document length is detected.

N

Noise removal

A function which improves the quality of an image by removing isolated noise that appear as black dots in a white area (or vice versa).

O

OCR (Optical Character Recognition)

A device or a technology that recognizes the text on documents and converts them into text data that can be edited. The shape of the characters are recognized by the differences in the light reflected off the documents.

Operating environment

Conditions (e.g. temperature, humidity) required to operate or store the scanner.

Operator panel

A panel that consists of a display and buttons. It is used for scanner operations such as selecting functions and changing settings.

Optical sensor

A sensor which detects the changes in the amount of light transmission. Paper feeding errors such as multifeed and paper jam are detected by monitoring the passing of documents.

Overscan

A function that scans the document in a size larger than the specified paper size.

P

Paper jam

Refers to an error in which a document is jammed inside the paper path or feeding is interrupted by documents slipping.

Paper protection

A function that detects anomalies in document feeding and stops the scan.

Patch code

A special code to let the scanner recognize the start and the end of each job or image mode.

Pick roller

A set of rollers which separates one sheet off the documents loaded in the ADF paper chute, and feeds the document into the ADF.

Pick start time

The period of time between setting the document and until picking starts after the document passes the hopper empty sensor.

Pixel

The dots that make up a scanned image.

Portrait

Orientation in which the long side of the document is set parallel to the feed direction. Documents/images are set/displayed vertically.

Pre-pick

Refers to feeding the document in advance to the position to start scanning.

It shortens the interval between setting the document and feeding the document to the starting position.

R

Resolution

A measurement to indicate the quality (fineness) of an image. Resolution is displayed by the number of pixels within an inch. Since image data is a collection of small dots (pixels), if the same image contains different amount of pixels, the one with more pixels can express greater details. Therefore, the higher the resolution, the finer the image becomes.

S

SCSI

SCSI (Small Computer System Interface) is a standard for interfaces, used to connect devices such as hard disks and scanners. Up to seven devices can be connected by this interface (daisy chain). The data transfer rate is 10 MB/sec. at maximum for Fast SCSI, and 20 MB/sec. at maximum for Wide SCSI.

SCSI ID

Used to specify a particular SCSI device when the initiator selects a target or the target reconnects to the initiator.

Simplex scanning mode

A mode for scanning only one side (front or back) of the document.(⇔ duplex scanning mode)

Smoothing

Refers to the removal of irregularities on diagonal lines and curves, which is a processing method commonly used in OCR applications.

T

Temporary error

An error that can be fixed by the operator.

Threshold

The value which is used to determine whether a certain color is black or white. Threshold value must be configured in order to scan images with grayscale gradation. Each pixel is converted into black or white according to the specified value.

TÜV

TWAIN (Technology Without Any Interesting Name) is an API (Application Program Interface) standard for imaging devices (e.g. scanners, digital cameras) developed by TWAIN Working Group. In order to use devices that comply with this standard, it is necessary to install a driver software that supports TWAIN standard.

TWAIN

An institution that controls products for conformity with various standards related to security, usability and environmental issues.

U

Ultrasonic sensor

A sensor that detects multifeed errors by ultrasonic soundwave. It detects multifeeds by monitoring the difference in the amount of ultrasonic waves transmitted through the documents.

[TOP](#)[Contents](#)[Index](#)[Introduction](#)[Scanner
Overview](#)[How to Load
Documents](#)[Configuring the
Scan Settings](#)[How to Use the
Operator Panel](#)[Various Ways to
Scan](#)[Daily Care](#)[Replacing the
Consumables](#)[Troubleshooting](#)[Operational
Settings](#)[Appendix](#)[Glossary](#)

USB

USB (Universal Serial Bus) is a standard for interfaces used to connect devices such as keyboards and scanners. Up to 127 devices can be connected by this interface. It can be connected and disconnected without powering off the devices. For USB 2.0, the data transfer rate is 1.5 Mbps in Low-Speed, 12 Mbps in Full-Speed, and a maximum of 480 Mbps in Hi-Speed mode.

For USB 1.1, the data transfer rate is 1.5 Mbps in Low-Speed and 12 Mbps in Full Speed mode.

W

White reference sheet

The white part located inside the ADF which the scanner defines as white, in order to adjust the brightness of all other areas accordingly.

Z

Zone OCR

A function which performs text recognition on the specified area of the scanned image.

TOP

Contents

Index

Introduction

Scanner
Overview

How to Load
Documents

Configuring the
Scan Settings

How to Use the
Operator Panel

Various Ways to
Scan

Daily Care

Replacing the
Consumables

Troubleshooting

Operational
Settings

Appendix

Glossary

Index

A	
ADF	
cleaning	111, 112
loading documents	38
open/close	24
ADF paper chute setup	26
automatic page size detection	49
B	
basic flow of scanning operation	32
before you contact the scanner service provider	149
black document pad	196
brake roller	119
C	
Carrier Sheet	196
cleaning	
ADF (with Cleaning Paper)	111
ADF (with cloth)	112
Carrier Sheet	116
flatbed	115
inside	111
outside	110
cleaning materials	109
configuring the scan settings	51
consumables	118
conventions	5
customizing the scanner settings	101
D	
daily care	108
documents for scanning	41
E	
error indications	126
F	
flatbed	
cleaning	115
loading documents	40
open/close	25
H	
how to use this manual	2
I	
image scanning application	35
imprinter	196
introduction	3
ISIS driver	56
L	
loading documents	37, 39
long page scanning	76

TOP

Contents

Index

Introduction

Scanner
OverviewHow to Load
DocumentsConfiguring the
Scan SettingsHow to Use the
Operator PanelVarious Ways to
Scan

Daily Care

Replacing the
Consumables

Troubleshooting

Operational
Settings

Appendix

Glossary

M		[Send to] button	101
main features	15	Software Operation Panel	153
manual feeding	90	configuration items	160
mixed batch scanning	47	Document check area specification for Multifeed Detection	182
multifeed detection	180	Dropout color	173
O		Feed Mode	179
operational settings	152	Intelligent Multifeed Function	185
operator panel	64	Manual-feed timeout	186
outer dimensions	195	Number of paper feeding retries	175
P		Offset/Vertical magnification Adjustment	169
page counter	166	Page Edge Filler	171
paper jam	125	Paper Protection	177
pick roller	121	password	154
post-scan operations and handling	91	Power SW Control	188
power saving mode	31	specifications	
product label	151	basic specification	190
R		documents	41
replacement cycles	118	scanner installation	193
replacing consumables	117	stacker setup	27
S		T	
[Scan/Stop] button	101	troubleshooting	124, 130
scanner		TWAIN driver	52
options	196	U	
parts and functions	16	uninstalling software	197
power on/off	23	W	
Scanner Central Admin	36	waiting time	186
scanning			
advanced scanning	82		
documents of different types and sizes	68		
ways of scanning	67		

TOP

Contents

Index

Introduction

Scanner
Overview

How to Load
Documents

Configuring the
Scan Settings

How to Use the
Operator Panel

Various Ways to
Scan

Daily Care

Replacing the
Consumables

Troubleshooting

Operational
Settings

Appendix

Glossary

fi-6130Z/fi-6230Z/fi-6140Z/fi-6240Z Image Scanner

Operator's Guide

P3PC-3342-02ENZ0

Issue date: July 2012

Issued by: PFU LIMITED

- The contents of this manual are subject to change without notice.
- PFU LIMITED is not liable whatsoever for any damages resulting from the use of this scanner and procedures described in this manual, profit loss due to defects, and any claims by a third party.
- Copying of the contents of this manual in whole or in part and copying of the scanner applications is prohibited under the copyright.