

fi-590PRB Imprinter

Operator's Guide

Contents

Introduction	1
1. Preparations	5
1.1 Names of Component Parts.....	5
2. Basic Operations	6
2.1 Installing the Print Cartridge	6
2.2 Operating Test	7
2.3 Positioning the Print Cartridge.....	8
2.4 How to Use the Paper Guides.....	8
2.5 Print Setup	9
2.6 Replacing the Print Cartridge	9
3. Daily Care	11
3.1 Cleaning the Print Cartridge	11
3.2 Cleaning the Imprinter.....	11
4. Error Messages	13
5. Specifications	14

The contents of this manual are subject to change without notice.

This manual may not be reproduced, adapted or translated without prior written permission.

READ ALL OF THIS MANUAL CAREFULLY BEFORE USING THIS PRODUCT. IF THIS PRODUCT IS NOT USED CORRECTLY, UNEXPECTED INJURY MAY BE CAUSED TO USERS OR BYSTANDERS.

While all efforts have been made to ensure the accuracy of all information in this manual, PFU Limited assumes no liability to any party for any damage caused by errors or omissions or by statements of any kind in this manual, its updates or supplements, whether such errors are omissions or statements resulting from negligence, accidents, or any other cause.

PFU Limited further assumes no liability arising from the application or use of any product or system described herein; nor any liability for incidental or consequential damages arising from the use of this manual.

PFU Limited disclaims all warranties regarding the information contained herein, whether expressed, implied, or statutory.

PFU Limited assumes no liability for incidental or consequential damages arising from the use of this product, and any claims by a third party.

Introduction

Thank you for purchasing the fi-590PRB Imprinter option for fi-5900C/fi-5950 Color Image Scanner.

This guide explains how to install and use the imprinter. (For further details about the functions and operations of fi-5900C/fi-5950 Image Scanner, refer to the “fi-5900C Image Scanner Operator’s Guide” or “fi-5950 Image Scanner Operator’s Guide” included in fi-5900C/fi-5950 SETUP DVD-ROM.)

This guide also contains other important information, such as procedures for replacement of consumables. Keep this guide in a convenient and safe place so that you can refer to it whenever necessary.

We hope this manual will be helpful in your future use of the fi-590PRB Imprinter.

Manufacturer

PFU Limited

YOKOHAMA i-MARK PLACE, 4-4-5 Minatomirai, Nishi-ku, Yokohama, Kanagawa 220-8567, Japan

Trademarks

Microsoft, Windows, and Windows Server are either registered trademarks or trademarks of Microsoft Corporation in the United States and/or other countries.

PaperStream is a registered trademark of PFU Limited in Japan.

Other company names and product names are the registered trademarks or trademarks of the respective companies.

How Trademarks Are Indicated In This Manual

References to operating systems (OS) are indicated as follows:

Product	Indication
Windows Server® 2008 Standard (32/64-bit) Windows Server® 2008 R2 Standard (64-bit)	Windows Server 2008 (*1)
Windows® 7 Home Premium (32/64-bit) Windows® 7 Professional (32/64-bit) Windows® 7 Enterprise (32/64-bit) Windows® 7 Ultimate (32/64-bit)	Windows 7 (*1)
Windows Server® 2012 Standard (64-bit)	Windows Server 2012 (*1)
Windows Server® 2012 R2 Standard (64-bit)	Windows Server 2012 R2 (*1)
Windows® 8 (32/64-bit) Windows® 8 Pro (32/64-bit) Windows® 8 Enterprise (32/64-bit)	Windows 8 (*1)

Product	Indication
Windows® 8.1 (32/64-bit) Windows® 8.1 Pro (32/64-bit) Windows® 8.1 Enterprise (32/64-bit)	Windows 8.1 (*1)
Windows® 10 Home (32/64-bit) Windows® 10 Pro (32/64-bit) Windows® 10 Enterprise (32/64-bit) Windows® 10 Education (32/64-bit)	Windows 10 (*1)
Windows Server® 2016 Standard (64-bit)	Windows Server 2016 (*1)

*1: Where there is no distinction between the different versions of the above operating system, the general term "Windows" is used.

Regulatory Information

FCC declaration

This equipment has been tested and found to comply with the limits for a Class A digital device, pursuant to Part 15 of the FCC Rules. These limits are designed to provide reasonable protection against harmful interference when the equipment is operated in a commercial environment. This equipment generates, uses, and can radiate radio frequency energy and, if not installed and used in accordance with the instruction manual, may cause harmful interference to radio communications. However, there is no guarantee that interference will not occur in a particular installation. If this equipment does cause harmful interference to radio or television reception, which can be determined by turning the equipment off and on, the user is encouraged to try to correct the interference by one or more of the following measures:

- Reorient or relocate the receiving antenna.
- Increase the separation between the equipment and receiver.
- Connect the equipment into an outlet on a circuit different from that to which the receiver is located.
- Consult your dealer or an experienced radio/TV technician.

FCC warning: Changes or modifications not expressly approved by the party responsible for compliance could void the user’s authority to operate the equipment.

Canadian DOC Regulations

This digital apparatus does not exceed the Class B limit for radio noise emissions from digital apparatus set out in the Radio interference Regulations of the Canadian Department of Communications. This Class B digital apparatus complies with Canadian ICES-003.

Le présent appareil numérique n'émet pas de parasites radioélectriques dépassant les limites applicables aux appareils numériques de la classe B, limites prescrites dans le Règlement pour le brouillage radioélectrique qui fut dicté par le Ministère des Communications du Canada. Cet appareil numérique de la classe B est conforme à la norme NMB-003 du Canada.

Bescheinigung des Herstellers / Importeurs

Für den fi-590PRB wird folgendes bescheinigt:

- In Übereinstimmung mit den Bestimmungen der EN45014(CE) funktentstört
- Maschinenlärminformationsverordnung 3.GPSGV: Der höchste Schalldruckpegel beträgt 70 dB (A) oder weniger, gemäß EN ISO 7779.

Dieses Gerät wurde nicht für die Benutzung in unmittelbarer Umgebung starker Lichtquellen (z. B. Projektoren) konzipiert.

Use in High-safety Applications

This product has been designed and manufactured on the assumption that it will be used in office, personal, domestic, regular industrial, and general-purpose applications. It has not been designed and manufactured for use in applications (simply called "high-safety applications" from here on) that directly involve danger to life and health when a high degree of safety is required, for example, in the control of nuclear reactions at nuclear power facilities, automatic flight control of aircraft, air traffic control, operation control in mass-transport systems, medical equipment for sustaining life, and missile firing control in weapons systems, and when provisionally the safety in question is not ensured. The user should use this product with adopting measures for ensuring safety in such high-safety applications. PFU Limited assumes no liability whatsoever for damages arising from use of this product by the user in high-safety applications, and for any claims or compensation for damages by the user or a third party.

Conventions

Warning Indications Used In This Manual



This indication alerts operators to an operation that, if not strictly observed, may result in severe injury or death.



This indication alerts operators to an operation that, if not strictly observed, may result in safety hazards to personnel or damage to equipment.

Symbols Used In This Manual

This manual uses the following symbols in addition to warning indications



This symbol alerts operators to particularly important information. Be sure to read this information first before proceeding.



This symbol alerts the operator to useful advice on operating the device.



The triangle indicates that special care and attention is required. A drawing inside the triangle shows what specific caution.



A circle with a slanted line through it indicates an action or step that should not be performed.



Outline characters on a colored background show instructions that users should follow. It may also include the drawing of the specific instruction.

Screen Examples In This Manual

Microsoft product screenshots are reprinted with permission from Microsoft Corporation. The screen examples in this manual are subject to change without notice in the interest of product improvement.

If the actual screen differs from the screen examples in this manual, operate by following the actual displayed screen while referring to the user's manual of the scanner application you are using.

The screen examples used in this manual are of the PaperStream IP (TWAIN) driver.

The screenshots used in this manual are of Windows 7. The windows that appear and the operations differ by the operating system. Also note that with some scanner models, the screens and operations may differ from this manual when you update the PaperStream IP (TWAIN) driver. In that case, refer to the manual provided upon updating the driver.

The Operator Panel Language Display

Apart from English, the operator panel can also display French, German, Italian, Spanish, and Chinese (Simplified). In this manual, the language display of the operator panel is shown in English.

About Maintenance

The user must not perform repairs on this product. Contact the store where you purchased the scanner or an authorized FUJITSU Image Scanner service provider to have repairs made on this product.

Safety Precautions

The following describes important warnings for using this product.

For the safe use of this product, make sure to follow the following descriptions.



Do not insert or drop any foreign objects (water, liquids, small metal objects, etc.) into the opening sections on the scanner.

If foreign objects get inside the scanner, immediately disconnect the power cable from the AC outlet.

Then, contact your FUJITSU scanner dealer or an authorized FUJITSU scanner service provider. Pay particular attention to this warning in households where there are small children.



If the scanner is damaged for any reason, immediately disconnect the power cable from the AC outlet. Then, contact your FUJITSU scanner dealer or an authorized FUJITSU scanner service provider.



In the following situation, immediately disconnect the power cable from the AC outlet. Not doing so may cause a fire or electric shock.

- Smoke or heat coming from the scanner is detected.
- Strange noise or smell is detected.
- Foreign objects (water, liquids, small metal objects, etc.) get inside the scanner.
- Other problems which indicate a scanner failure are detected.

Then, contact your FUJITSU scanner dealer or an authorized FUJITSU scanner service provider. Never try fixing such problems by yourself. Doing so is dangerous.



Do not take apart or modify the scanner as high-voltage components inside the scanner are dangerous. PFU assumes no liability to any damage caused by taking apart the scanner, as doing so is not covered under the warranty.



The area around the part to which this warning label is affixed can become very hot. To avoid burns, never touch around the area indicated by this label.



Firmly insert the power cable into the AC outlet. Not doing so may cause a fire or electric shock.



Use the scanner only at the indicated power voltage and current. Do not connect to multiple-power strips. Improper power voltage or current might cause a fire or electric shock.



Use only power cables provided with the scanner. Do not use any extension cords. Not following these instructions may cause abnormal heat or a fire. Do not also use the power cable provided with the scanner for other devices, since this might cause problems such as an equipment failure, or an electric shock.



Do not install in places that are damp or subject to smoke, steam, or dust, as this may cause a fire or electric shock.



Do not install the scanner in the following locations which are subject to high temperature, humidity, less ventilation, or dust. If placed in an area subject to high temperature, the cover may become overheated and deformed, causing the scanner to become hot, resulting in a fire.

- A place near heat-radiating devices such as stoves or electric heaters, or flammable items such as volatile inflammable materials or curtain.
- A place such as a bathroom, shower room, or swimming pool where it may easily get wet.
- A place under direct sunlight, in a car under the scorching sun, or near heating apparatus where it may get hot.



To avoid injuries, do not place the scanner in an area where small children may be able to reach.



Before moving the scanner, be sure to disconnect the power cable from the AC outlet, and all other interface cables. Make sure that the floor is free of any obstructions.
Do not move the scanner with the power and interface cables connected as this can damage the cables, which can later cause a fire, electric shock as well as injuries.



Do not touch the power cable with wet hands. Doing so might cause an electric shock.



When removing the power cable from the AC outlet, make sure to hold the power plug and not the cable. Pulling the power cable may damage it, which may cause a fire or electric shock.



Do not use a damaged power cable. Also, do not insert any cables or power plugs into loose sockets. Doing so may cause a fire or electric shock. Be careful of the following when handling the power cable:

- Do not modify the power cable.
- Do not place heavy objects on the power cable.
- Do not pull or bend the power cable.

If the power cable is damaged, contact your FUJITSU scanner dealer or an authorized FUJITSU scanner service provider.



Do not place heavy objects on the scanner or perform other work on top of the scanner. Doing so might cause injuries or an equipment failure.



Do not use the scanner while covered with a blanket, etc. Doing so may raise the temperature inside and cause a fire.



Avoid getting a sleeve, necktie, or hair caught up in any scanner mechanism during scanning since this may cause injuries.



Do not touch the heated section such as the bottom of the scanner for a long time. Doing so may cause a low-temperature burn on your skin.



When the scanner is not going to be used for a long period of time, be sure to disconnect the power cable from the AC outlet. Not doing so may cause a fire or electric shock.



Do not use any aerosol sprays or alcohol based sprays to clean the scanner. Dust blown up by strong air from the spray may enter the inside of the scanner. This may cause the scanner to fail or malfunction. Sparks, caused by static electricity, generated when blowing off dust and dirt from the outside of the scanner may cause a fire.



Check the following items once a month:

- The power cable is firmly inserted into the AC outlet.
- The power cable is not emitting abnormal heat, or the power cable is not rusted or bent.
- Dust is not accumulated on the power cable. If so, wipe off any dust with a soft, dry cloth.
- The power cable does not have any cracks or scratches.

If any abnormality is detected, contact your FUJITSU scanner dealer or an authorized FUJITSU scanner service provider.



Make sure to ground to avoid electric shock. Be sure to ground before plugging into the AC outlet. Unplug from the outlet before removing the ground connection.



When installing the scanner on a table, make sure that the table is flat and level. Place the scanner so that none of its parts extend beyond the edge of the table, otherwise it may fall or collapse and cause injuries.



Install the scanner away from strong magnetic fields and other sources of electronic noise. Protect the scanner against any static electricity and choose a static-free place to install the scanner. Static electricity can cause the scanner to malfunction.



If there is an electrical storm, disconnect the power cable from the AC outlet. Lightning can travel through wires and water pipes and damage the scanner, which may damage your property.



Do not supply the power from the AC outlet where the devices requiring much power such as copying machines or paper shredders are connected.



Do not block the ventilation ports. Blocking the ventilation ports generates heat inside of the scanner, which may result in a fire or scanner failure.



Do not use the scanner immediately after moving it from a cold place into a warm room. Condensation may occur, which might lead to scanning errors. Let the scanner dry for one or two hours before you use it.



When handling documents, be careful not to cut your fingers with them.



When carrying the scanner outside while it is raining or snowing, pay special attention so the scanner does not get wet.
If the scanner gets wet, wipe it or wait until it dries.



When transporting the scanner, never carry it alone. The scanner is heavy.

1. Preparations

1.1 Names of Component Parts

Open the top cover of the scanner (fi-5900C/fi-5950) and you can see the imprinter (fi-590PRB) installed in the front side.

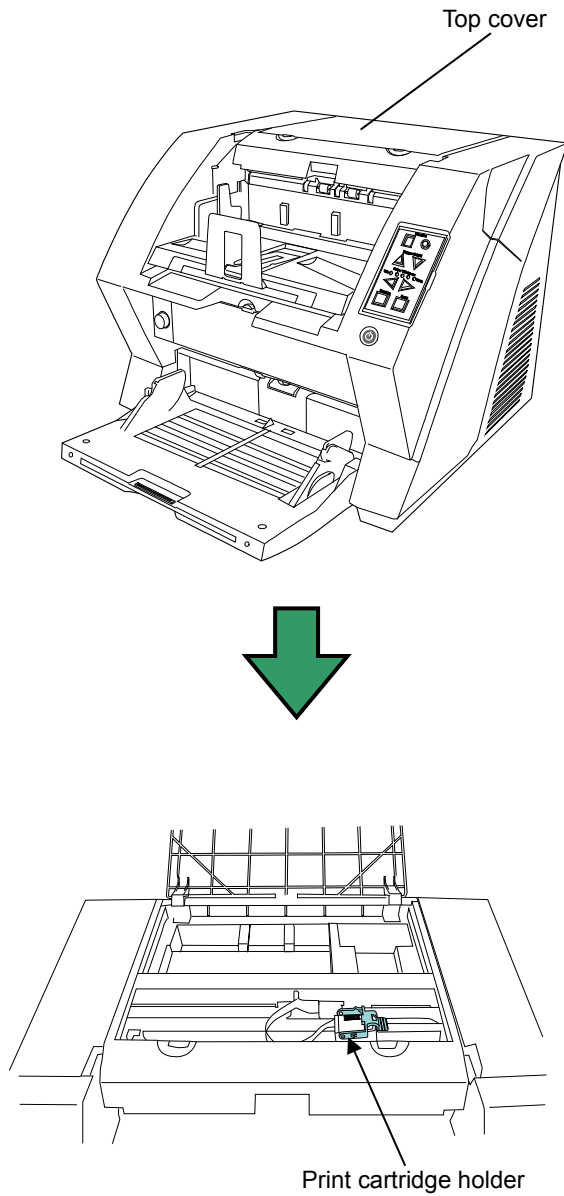

2. Basic Operations

2.1 Installing the Print Cartridge

Mount the print cartridge as follows:



When installing or replacing the print cartridge, be careful not to insert it out of place.

1. Confirm that the scanner is turned off.
2. Press the tabs on the left and right sides of the Top cover and lift to open the Top cover.

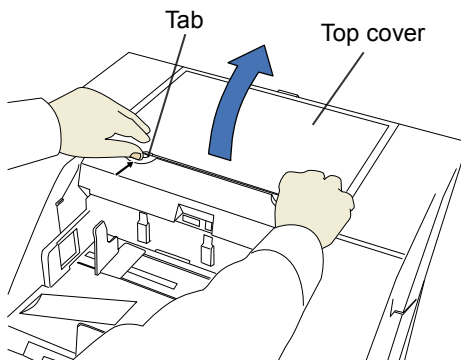

3. Remove the new print cartridge from its pouch.

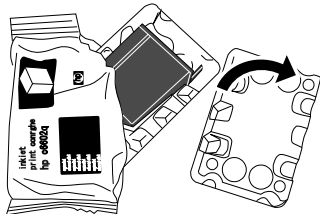

4. Remove protection tape from the print cartridge.

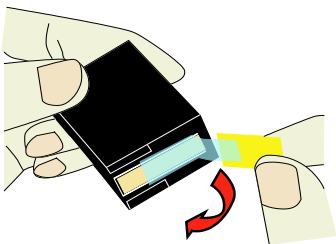

Do not touch the metal part of the cartridge nor put the tape back on again.

5. Open the print cartridge holder, rotating the lever to the left.

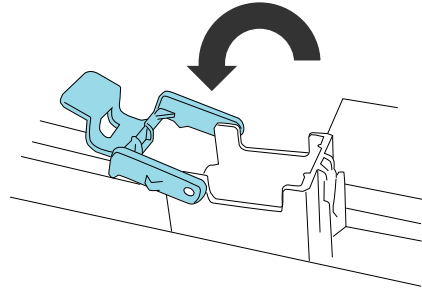

6. Insert the print cartridge in the holder.

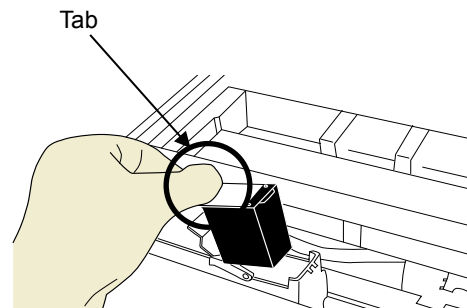

- Insert the cartridge with its tab positioned toward left side and install it.
- Be careful not to let the print cartridge touch or catch on to the print circuit film.
- Note that the cartridge cannot be inserted properly if it is inclined.

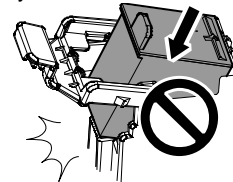

7. Turn the lever on the print cartridge toward right to fix it.

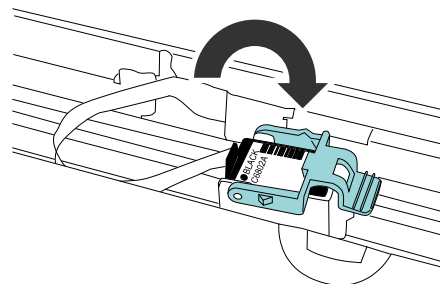

- Close the top cover and press lightly until it is fixed with the tabs.

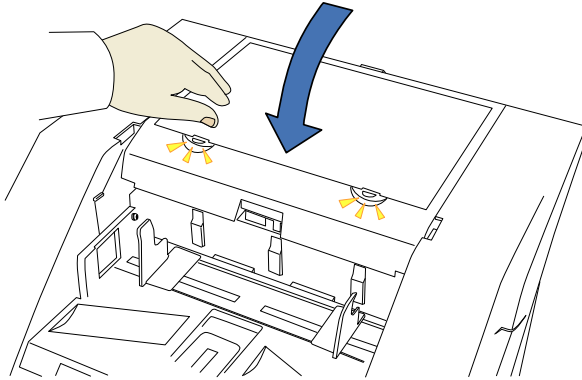

2.2 Operating Test

After installing the print cartridge, test to see if printing can be performed on the offline print test mode.

- While pressing the [Hopper Height] button (Δ or ∇) on the operator panel, switch on the scanner.

Continue pressing on the [Hopper Height] button.

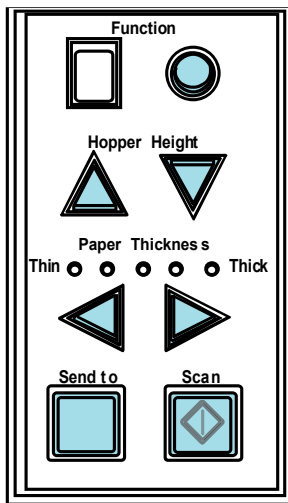

- Release the [Hopper Height] button when the function number display changes from [P] to [b].



- Place a blank document on the hopper.



- Use A4 or Letter size paper. If the size is smaller than A4 or Letter, printing may not successfully complete.
- Confirm that the print cartridge is positioned within the document width. For the details, please refer to "2.3 Positioning the Print Cartridge".

- Press [Scan] button to test.

⇒ Paper will be fed into ADF, and the imprinter will print out the print test characters starting at 5mm (± 4 mm) from the paper's edge.



Print test patterns

Test pattern 1 (Horizontal):
 ABCDEFGHIJKLMNOPQRSTUVWXYZ[¥]^_`00000000

Test pattern 2 (Horizontal):
 abcdefghijklmnopqrstuvwxyz{|}~ 00000000

Test pattern 3 (Horizontal):
 !"#%&'()*+,-./0123456789:;<=>?@00000000

Test pattern 4 (Vertical):
 ABCDEFGHIJKLMNOPQRSTUVWXYZ[¥]^_`00000000

Test pattern 5 (Vertical):
 abcdefghijklmnopqrstuvwxyz{|}~ 00000000

Test pattern 6 (Vertical):
 !"#%&'()*+,-./0123456789:;<=>?@00000000

When multiple sheets of documents are placed in the Hopper, the Test Print repeats patterns from 1 through 6.

The numbering data portion "00000000" changes from 0 (Zero) with increment of 1(one).

(One test pattern is printed at a time. Press the [Scan] button to continue printing the next test pattern.)

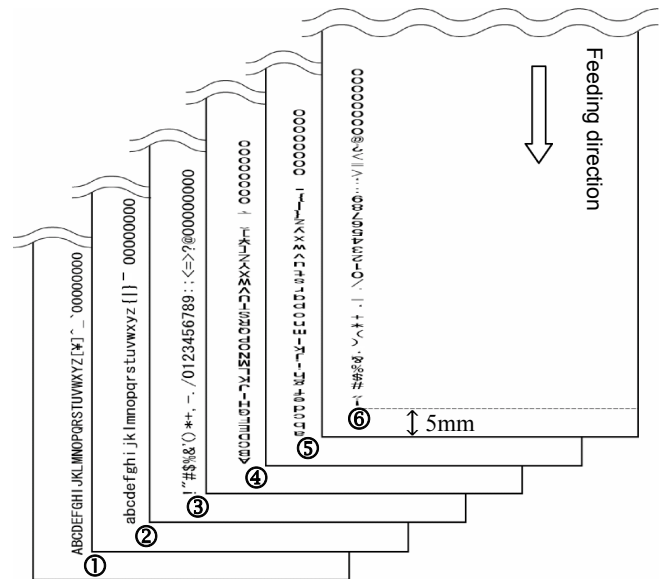

Test pattern print sample

- To stop offline print test mode, turn off the scanner.

2.3 Positioning the Print Cartridge

To position the print cartridge for printing:

1. Press the tabs on the left and right sides of the top cover, and lift to open the top cover.

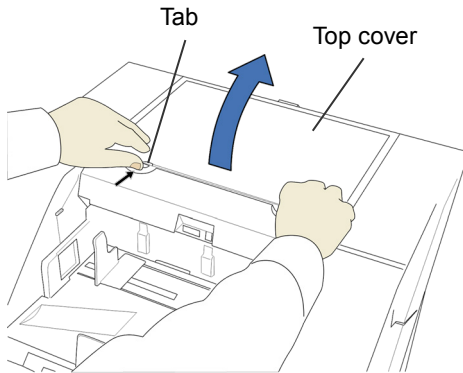

2. Place the print alignment mark to the position where you want to print.

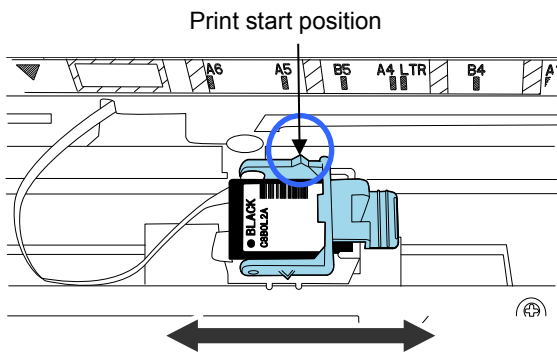

- The small "▼" protruding from the side of the print cartridge holder indicates the print start position on the page.
- Above the print cartridge tray are document paper size markings; please use them to adjust for printing positions.
- Do not set the print cartridge within the printing prohibited area (Fluorescent yellow shaded sections); otherwise, the document may stain with ink.
- Put the actual document in the Hopper and confirm that the print cartridge is positioned within the document's width.

3. Close the top cover and press lightly until it is fixed with the tabs.

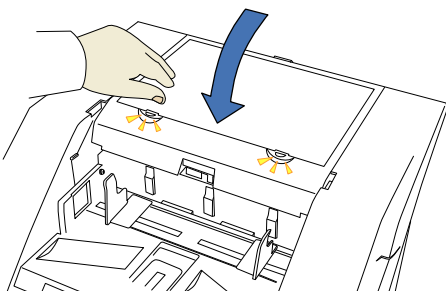

2.4 How to Use the Paper Guides

Use the paper guides to prevent paper jams due to curling of the edges, as shown below.

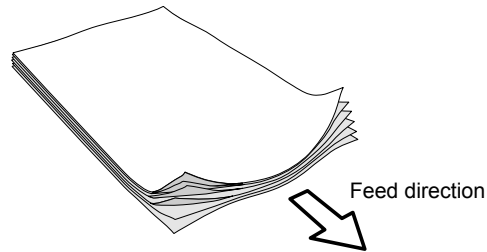

As shown below, place the paper guides at the ends where the paper edges will pass through.

1. Load the document on the scanner.
2. Open the top cover.
3. Slide the paper guides to the left and right page edges.

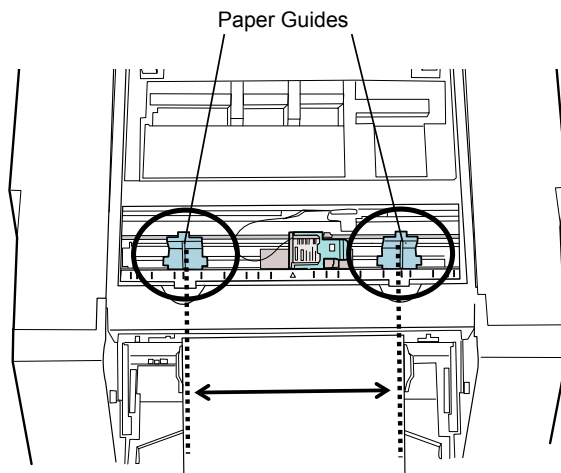

When you wish to print on the near the edges of a wide width paper, remove the paper guide in order to open space for the print cartridge, and attach it at the center.

For Right Side Edge Printing

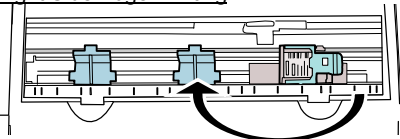

For Left Side Edge Printing

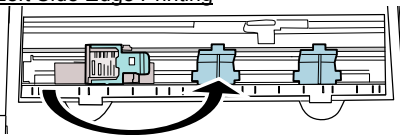

Be careful not to let the paper guide touch or catch onto the print circuit film.

To Attach the Paper Guide

As shown in the illustration below, place the paper guide on the rail (①), and push the guide's hook to engage it on to the rail (②).

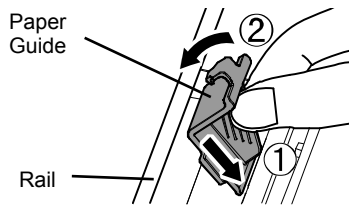

To Remove the Paper Guide

As shown below, hold the paper guide and pull towards you to unhook it.

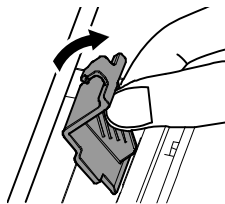

2.5 Print Setup

You can configure settings for the imprinter by using the scanner driver dialog box.



How to run the scanner driver differs depending on the application. For details, refer to the manual or help of the application being used.



- Available items are:
 - Y offset (Printing)
 - Font orientation (vertical, horizontal)/ width (normal/bold/narrow)
 - Strings definition (Max. 43 characters)
 - Counter Setup (column, add/subtract, step)
- For details, refer to the scanner driver's Help.

2.6 Replacing the Print Cartridge



Make sure that you turn off the scanner power and unplug the power cable from the outlet.

If the cartridge replacement is done with power turned on, it may cause electric shock or imprinter failure.

Replace the print cartridge as follows:



- When the following message appears, replace the print cartridge as soon as possible.

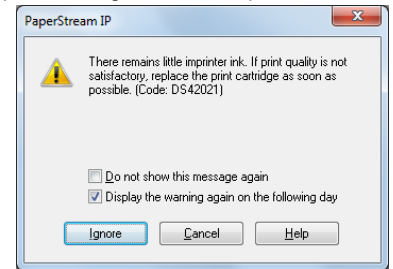

If you continue to print without replacing the cartridge, your print output will continue to appear lighter and lighter.

- When installing or replacing the print cartridge, be careful not to insert it out of place.

1. Confirm that the scanner is turned off.
2. Press the tabs on the left and right sides of the top cover and lift to open the top cover.

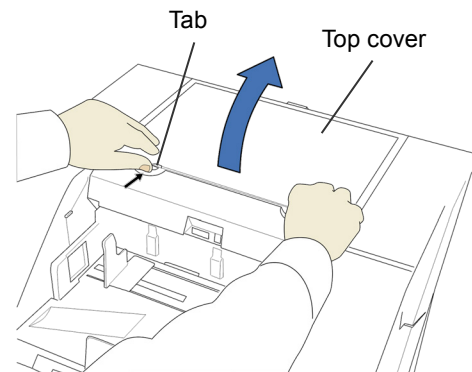

3. Turn the blue lever toward left and open the cartridge holder.

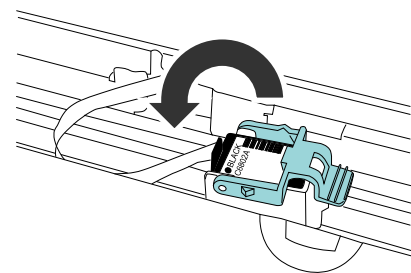

4. Take out the print cartridge from the holder.

- Take the new print cartridge out of its pouch and detach the protection tape from the print cartridge.

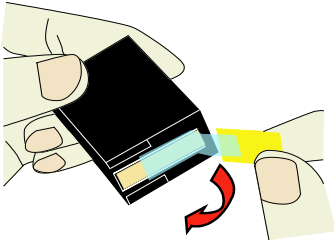

Do not touch the metal part of the cartridge nor put the tape back again.

- Insert the print cartridge.

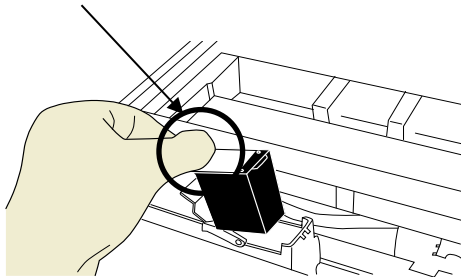

- Insert the cartridge with its Tab positioned toward left side and install it.
- Be careful not to let the print cartridge touch or catch on to the print circuit film.

- Turn the lever on the print cartridge toward right to fix it.

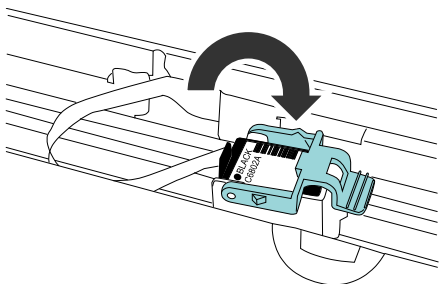

- Close the top cover and press lightly until it is fixed with the tabs.

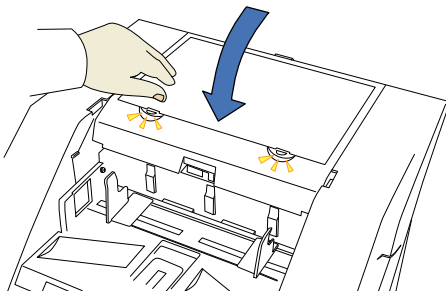

- Reset the Ink Remain Counter.



You must reset the Ink Remain Counter whenever you replace the print cartridge.

- Display the [Software Operation Panel] dialog box.
Windows Server 2008/Windows 7 or earlier
Click [Start] menu → [All Programs] → [fi Series] → [Software Operation Panel].

Windows Server 2012/Windows 8

Right-click the Start screen, and select [All apps] on the app bar → [Software Operation Panel] under [fi Series].

Windows Server 2012 R2/Windows 8.1

Click [!] on the lower left side of the Start screen → [Software Operation Panel] under [fi Series]. To display [!], move the mouse cursor.

Windows 10/Windows Server 2016

Click [Start] menu → [fi Series] → [Software Operation Panel].

- Click [Device Setting] from left side list in the window.

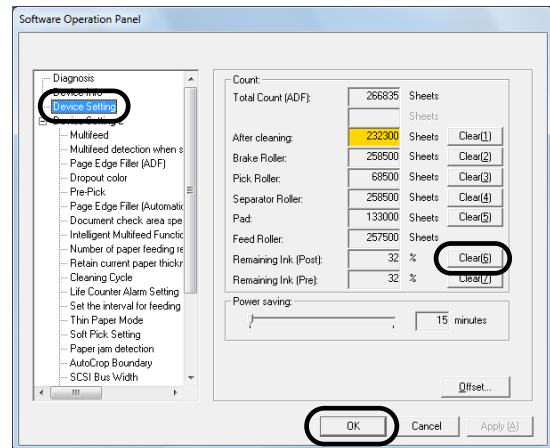

If the [Software Operation Panel] is password protected, enter the password to cancel the View Only mode. (fi-5950 only)

- Click the [Clear] button at the [Remaining Ink (Post)].

⇒ The Ink remain counter will reset to 100%.

- Click the [OK] button on the [Software Operation Panel] window.

3. Daily Care

3.1 Cleaning the Print Cartridge

Poor quality prints can occur due to blocked ink emission holes in the nozzle. Leaving the imprinter unused for long periods can also cause emission holes to become blocked. When the emission holes are blocked, clean the nozzle surface of the print cartridge.



For cleaning, use a dry lint-free cloth (DO NOT use tissue), and gently wipe any dirt and stains off the nozzle's surface.



If the ink emission holes are still blocked after cleaning the print cartridge, replace it with a new cartridge.

1. Turn off the scanner.
2. Remove the print cartridge.
(Refer to "2.6 Replacing the Print Cartridge")

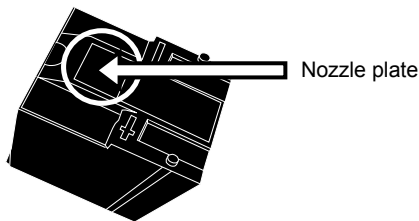

When cleaning, be careful not to touch the nozzle plate or the contact parts of the cartridge directly by hand.

3. Gently wipe any dirt and stains off the nozzle surface.

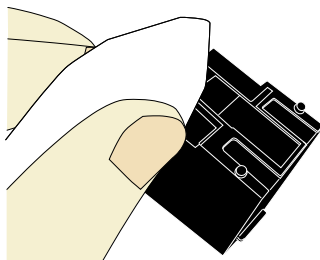

4. Make sure that all dirt and stains are removed, before installing the print cartridge.

(Refer to "2.6 Replacing the Print Cartridge")



When installing or replacing the print cartridge, be careful not to insert it out of place.

3.2 Cleaning the Imprinter

Ink may spatter the vicinity of the print cartridge holder.

We recommend you to clean the scanner after 5000 sheets scanning to avoid smudge on the scanned image. Note that the required cleaning cycle may vary depending upon document type to be scanned.

More frequent cleaning may be required when printing a document on which ink does not easily get dry.



When you do the cleaning, turn off the scanner power, and unplug the power cable from the outlet.

If cleaning is done with power turned on, it may cause electric shock or imprinter failure.



For cleaning, use a dry lint-free cloth (DO NOT use tissue).

1. Turn off the scanner.
2. Remove the print cartridge.
(Refer to "2.6 Replacing the Print Cartridge")
3. Press the ADF cover open button.

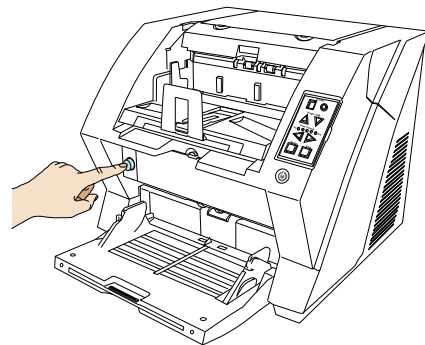

⇒ The cover is slowly opened.

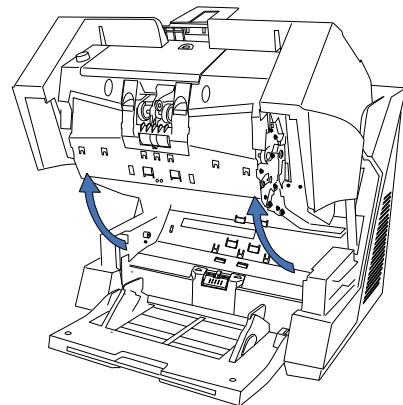

4. Wipe the following parts using a cloth moistened with Cleaner F1.



It may take long before the cleaner vaporizes if a large quantity is used. When cleaning the scanner parts, dampen a cloth with modest quantities of the cleaner. In addition, wipe off the cleaner completely with a soft lint-free cloth to leave no residue on the surface of the cleaned parts.

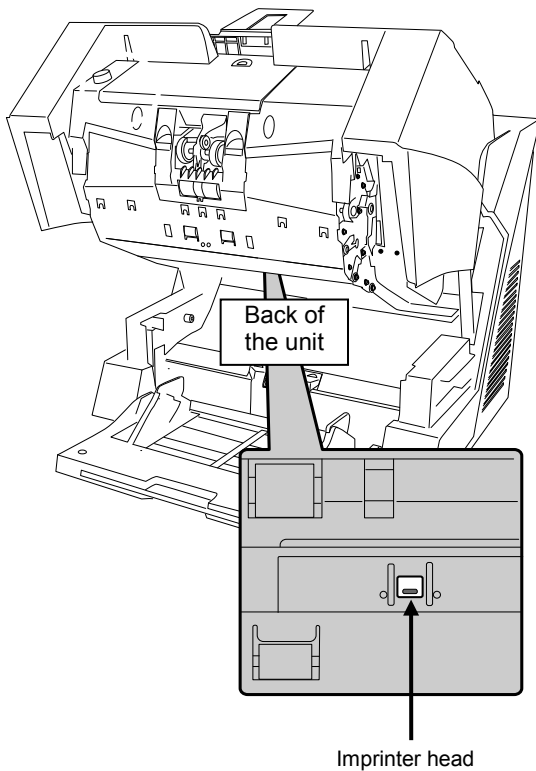

5. Hold the ADF cover with both hands and press it down slowly.

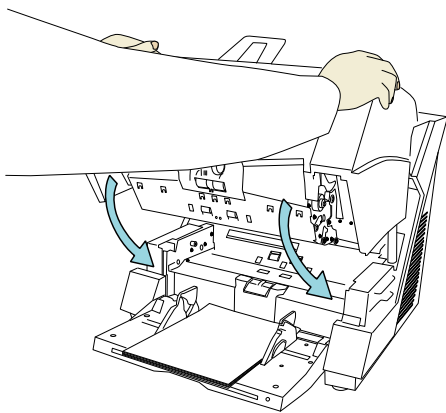

Press the ADF cover until it is fixed.

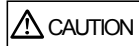

- When closing the ADF, be sure nothing is left inside of the ADF.
- Be careful not to pinch your fingers.

6. Insert the print cartridge.
(Refer to “2.6 Replacing the Print Cartridge”)

4. Error Messages

The following numbers or letters on the function number display indicates a malfunction in the imprinter.



Description: The print cartridge is not installed.

How to solve: Open the top cover and confirm that the print cartridge is installed correctly.



Description: A problem occurred to the imprinter.

How to solve: ①Open the top cover and confirm that the print cartridge has been installed correctly.

②Turn off the scanner and then turn it on again.
(If the problem occurs again, contact the store where you purchased the imprinter or contact an authorized FUJITSU scanner service provider.)

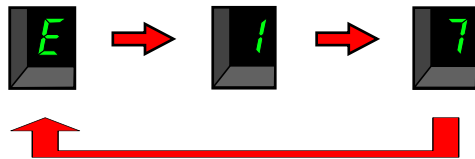

Description: The imprinter fuse has blown out.

How to solve: Contact the store where you purchased the scanner, or contact an authorized FUJITSU scanner service provider.



For other errors, refer to “fi-5900C Image Scanner Operator’s Guide” or “fi-5950 Image Scanner Operator’s Guide” included in fi-5900C/fi-5950 SETUP DVD-ROM.

5. Specifications

Item	Specification			
Printing Method	Thermal inkjet printing			
Print Timing	Post printing (Backside)			
Printing Characters	Alphabet : A to Z, a to z Numeric Characters : 0, 1 to 9 Symbols : ! " \$ # % & ' () * + , - . / : ; < = > ? @ [¥] ^ _ ` { } ~			
Maximum number of characters per line	43 characters			
Print orientation	Normal, Bold: 0°, 180° (horizontal orientation), 90°, 270° (vertical orientation) Narrow : 0°, 180° (horizontal orientation)			
Character size	Normal, Bold: Height 2.91mm × width 3.03mm/0.1146 × 0.1193 in (horizontal orientation) Height 3.03mm × width 2.91mm/0.1193 × 0.1146 in (vertical orientation) Narrow : Height 2.91mm × width 1.71mm/0.1146 × 0.0673 in (horizontal orientation)			
Character pitch	3.79mm/0.1492in (Normal, Bold), 2.46mm/0.0968in (Narrow)			
Font style	Regular, Bold			
Character width	Normal, Bold, Narrow			
	Character width	Print orientation	Font style	Printing
	Normal	Horizontal	Regular	Available
			Bold	Available
		Vertical	Regular	Available
			Bold	Available
	Narrow	Horizontal	Regular	Available
			Bold	NOT Available
		Vertical	Regular	NOT Available
			Bold	NOT Available
Document that can be scanned	<p>Documents supported by fi-5900C/fi-5950</p> <p>For the details, please refer to “fi-5900C Image Scanner Operator’s Guide” or “fi-5950 Image Scanner Operator’s Guide”-“Chapter 7 Document Specification.”</p> <hr/> <div style="display: flex; align-items: center;">  <p>Documents with glossy surface such as thermal paper, thermal transfer paper, coated paper, and art paper take longer time for the ink to dry and may cause poor print quality. The imprinter must be cleaned more frequently if you use these types of papers.</p> </div> <hr/>			

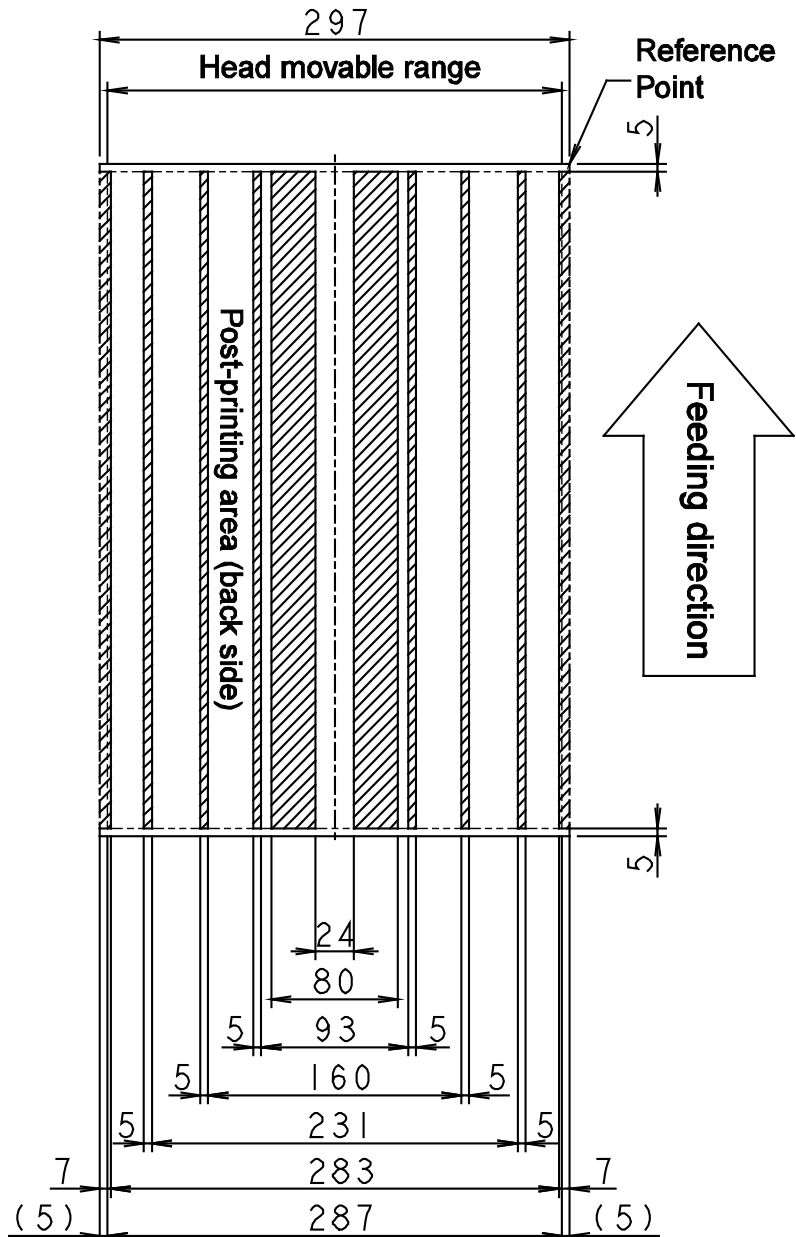
Item	Specification
Printing area	 <p>The diagram illustrates the printing area with various dimensions and a shaded 'Post-printing area (back side)'. The overall width is 297 mm. A 'Head movable range' is indicated at the top. A 'Reference Point' is marked with a 5 mm offset. The 'Feeding direction' is shown by an upward arrow. Dimensions for the shaded area include 24 mm, 80 mm, 93 mm, 160 mm, 231 mm, 283 mm, and 287 mm. Marginal dimensions of 5 mm and 7 mm are also shown.</p> <p style="text-align: right;">Unit: mm</p> <p>* The document stains with ink when printing in the shaded areas (shown in the illustration). Therefore, correct printing operations in such areas are not guaranteed.</p>
Character position accuracy	Vertical : ± 4 mm (at reference position) Horizontal : ± 4 mm (at reference position)
Ambient condition	Temperature: 15 to 35°C (59 to 95°F), Humidity: 20 to 80%
Consumable	Print Cartridge (P/N: CA00050-0262) The printable number of characters: 4,000,000 characters (May decrease depending on the font selection) Replacement cycle : 4,000,000 characters or six months after opening