

P3PC-E827-03EN

Color Image Scanner

ScanSnap™

fi-5110EOX

Getting Started



Please read this guide before connecting the scanner to your PC.

FUJITSU

Contents

Introduction	1
1. Preparation	5
1.1. Checking the Contents of the Package.....	5
1.2. Names and Functions of Parts.....	5
2. Connecting ScanSnap	6
2.1. Installing the Supplied Software	6
2.1.1. Installing Adobe Acrobat 6.0	6
2.1.2. Installing ScanSnap Manager, CardMinder and PDF Thumbnail View	6
2.2. Connecting the Scanner	7
2.2.1. Connecting the AC cable	7
2.2.2. Connecting the USB cable	7
3. How to Use ScanSnap	9
3.1. Scanning Documents	9
3.2. About the Scan Settings	9
3.3. Scanning Office Documents.....	9
3.4. Scanning Business Cards	10
3.5. About PDF Thumbnail View.....	10
4. Troubleshooting	11
4.1. Troubleshooting Checklist	11
4.2. Clearing Paper Jams	13
5. Daily Care	14
5.1. Cleaning Materials	14
5.2. Cleaning the Scanner Exterior	14
5.3. Cleaning Inside of the scanner	14
6. Replacing Consumables	16
6.1. Part Numbers and Replacement Cycle of Consumables.....	16
6.2. Replacing the Pad ASSY.....	16
6.3. Replacing the Pick Roller	17

All Rights Reserved, Copyright © PFU LIMITED 2004-2009.

The contents of this manual are subject to change without notice.

This manual may not be reproduced, adapted or translated without prior written permission.

READ ALL OF THIS MANUAL CAREFULLY BEFORE USING THIS PRODUCT. IF THIS PRODUCT IS NOT USED CORRECTLY, UNEXPECTED INJURY MAY BE CAUSED TO USERS OR BYSTANDERS.

While all efforts have been made to ensure the accuracy of all information in this manual, PFU LIMITED assumes no liability to any party for any damage caused by errors or omissions or by statements of any kind in this manual, its updates or supplements, whether such errors are omissions or statements resulting from negligence, accidents, or any other cause. PFU LIMITED further assumes no liability arising from the application or use of any product or system described herein; nor any liability for incidental or consequential damages arising from the use of this manual.

PFU LIMITED disclaims all warranties regarding the information contained herein, whether expressed, implied, or statutory.

PFU LIMITED assumes no liability for incidental or consequential damages arising from the use of this product, and any claims by a third party.

Introduction

Thank you for purchasing the ScanSnap fi-5110EOX Color Image Scanner product.

ScanSnap fi-5110EOX comes with a color image scanner and office applications. It is a complete Office Solution designed to improve your productivity and to solve scanning problems in your office. ScanSnap product has the following features.

- **Just pressing the Scanner button allows you to turn images on paper into PDFs!**

You can turn the documents that clutter up your desktop into PDFs, and manage and archive them on your computer. You can use the Adobe® Acrobat® software packaged with this scanner to display and these PDF documents.

ScanSnap product can also automatically recognize the type of document, color or black & white, so scanned image files can be made smaller when scanning documents containing a mixture of color and black & white pages. You can also have the scanner automatically remove blank pages in documents in order to reduce the size of files even more.

- **Effortless scanning!**

Double-sided color documents A4 or letter in size can be scanned at a speed of about 15 sheets/minute (when used with a computer with Intel® Pentium® 4 1.8GHz or higher that runs Windows® 98, Windows® Me, Windows® 2000 or Windows® XP, and with Scan mode Normal, Color mode Auto, and Compression rate 3).

- **Small desktop footprint!**

Smaller than a sheet of A4 or letter paper in size, ScanSnap scanner can be left on your desk all the time.

- **Business cards easily filed!**

Business cards can be easily filed and searched for using the OCR function by using the "CardMinder™ for ScanSnap" application supplied with the scanner.

(*ScanSnap fi-5110EOX Scanner does **NOT** comply with **TWAIN** or **ISIS** standards.)

Manufacturer

PFU LIMITED
International Sales Dept., Imaging Business
Division, Products Group
Solid Square East Tower, 580 Horikawa-cho,
Saiwai-ku, Kawasaki-shi Kanagawa 212-8563,
Japan
Phone : +81 (44) 540-4538

Trademarks

Microsoft, and Windows are registered trademarks of Microsoft Corporation in the United States

and/or other countries.

Adobe, the Adobe logo, and Acrobat are either registered trademarks of Adobe Systems Incorporated in the United States and/or other countries.

ScanSnap, the ScanSnap logo, and CardMinder are the trademarks of PFU LIMITED.

Other product names are the trademarks or registered trademarks of the respective companies.

How Trademarks Are Indicated In This Manual

References to operating systems (OS) are indicated as follows:

Windows 98:	Microsoft® Windows® 98 operating system.
Windows Me:	Microsoft® Windows® Millennium Edition operating system.
Windows 2000:	Microsoft® Windows® 2000 Professional operating system.
Windows XP:	Microsoft® Windows® XP Professional operating system, Microsoft® Windows® XP Home Edition operating system.

Where there is no distinction between the different versions of the above operating system, the general term "Windows" is used.

Adobe Acrobat 6.0: Adobe® Acrobat® 6.0 Standard

■ ScanSnap and the Manuals

ScanSnap fi-5110EOX consists of:

- 1) fi-5110EOX: Color image scanner
- 2) ScanSnap Manager: Image capturing software to scan and convert paper documents into PDF-format files
- 3) CardMinder application: Software with OCR engine to capture and manage business card data for Personal Information Manager software such as Microsoft® Outlook®.
- 4) Adobe® Acrobat®: De facto standard software for generating and manipulating PDF format electronic document.

Following manuals are prepared for you:

ScanSnap fi-5110EOX Getting Started

(This manual):

provides basic information to install and use ScanSnap solution.

ScanSnap fi-5110EOX Operator's Guide

(PDF manual included in ScanSnap Setup CD-ROM): provides detailed information about the installation of the ScanSnap software and hardware, operation of the scanner hardware and ScanSnap Manager.

CardMinder User's Guide

(PDF manual included in ScanSnap Setup CD-ROM): provides detailed information on how to use CardMinder.

For information on how to use Adobe Acrobat, please refer to "Adobe Acrobat Help."

■ Regulatory Information

FCC declaration

This equipment has been tested and found to comply with the limits for a Class B digital device, pursuant to Part 15 of the FCC Rules. These limits are designed to provide reasonable protection against harmful interference in a residential installation. This equipment generates, uses, and can radiate radio frequency energy and, if not installed and used in accordance with the instruction manual, may cause harmful interference to radio communications. However, there is no guarantee that interference will not occur in a particular installation. If this equipment does cause harmful interference to radio or television reception, which can be determined by turning the equipment off and on, the user is encouraged to try to correct the interference by one or more of the following measures:

- Reorient or relocate the receiving antenna.
- Increase separation between equipment and receiver.
- Connect equipment to an outlet on a circuit different from that to which the receiver is located.
- Consult your dealer or an experienced radio/TV technician.



Changes or modifications not expressly approved by the party responsible for compliance could void the user's authority to operate the equipment.



- The use of a USB interface cable and AC cable supplied with this product is required to comply with the Class B limits of Part 15 of FCC rules.

Canadian DOC Regulations

This digital apparatus does not exceed the Class B limit for radio noise emissions from digital apparatus set out in the Radio interference Regulations of the Canadian Department of Communications.

This Class B digital apparatus complies with Canadian ICES-003.

Le présent appareil numérique n'émet pas de bruits radioélectriques dépassant les limites applicables aux appareils numériques de la classe B prescrites dans le Règlement sur le brouillage radioélectrique dicté par le ministère des Communications du Canada.

Cet appareil numérique de la classe B est conforme à la norme NMB-003 du Canada.

Bescheinigung des Herstellers / Importeurs

Hiermit wird bescheinigt, daß *der/die/das* fi-5110EOX

- In Übereinstimmung mit den Bestimmungen der EN45014(CE) funkentstört ist.
- Laut Maschinenlärminformationsverordnung 3. GS GV, 18.01.1991: Der höchste Schalldruckpegel beträgt 70 dB (A) oder weniger gemäß ISO/7779.

International ENERGY STAR® Program

As an ENERGY STAR® Partner, PFU LIMITED has determined that this product meets the ENERGY STAR® guidelines for energy efficiency.



The International ENERGY STAR® Office Equipment Program is an international program that promotes energy saving through the penetration of energy efficient computers and other office equipment. The program backs the development and dissemination of products with functions that effectively reduce energy consumption. It is an open system in which business proprietors can participate voluntarily. The targeted products are office equipment such as computers, monitors, printers, facsimiles, copiers, scanners, and multifunction devices. Their standards and logos () are uniform among participating nations.

Use in High-safety Applications

This product has been designed and manufactured on the assumption that it will be used in office, personal, domestic, regular industrial, and general-purpose applications. It has not been designed and manufactured for use in applications (simply called "high-safety applications" from here on) that directly involve danger to life and health when a high degree of safety is required, for example, in the control of nuclear reactions at nuclear power facilities, automatic flight control of aircraft, air traffic control, operation control in mass-transport systems, medical equipment for sustaining life, and missile firing control in weapons systems, and when provisionally the safety in question is not ensured. The user should use this product with adopting measures for ensuring safety in such high-safety applications. PFU LIMITED assumes no liability whatsoever for damages arising from use of this product by the user in high-safety applications, and for any claims or compensation for damages by the user or a third party.

About the use of mercury

The scanner lamp contains mercury.

To avoid unexpected injury, read the following carefully.

Doing the following actions may result in serious personal injuries:

- Do not put the substance in the lamp in your mouth as it contains mercury.
- Do not incinerate, crush, or shred the scanner.
- Do not breathe the chemical liquid contained in the scanner parts.

Disposing of the scanner should be conducted as required by local ordinances or regulations.

■ Conventions

Warning Indications Used In This Manual



This indication alerts operators to an operation that, if not strictly observed, may result in severe injury or death.



This indication alerts operators to an operation that, if not strictly observed, may result in safety hazards to personnel or damage to equipment.

Symbols Used In This Manual

This manual uses the following symbols in explanations in addition to warning indications



This symbol alerts operators to particularly important information. Be sure to read this information.



This symbol alerts operators to helpful advice regarding operation.



A TRIANGLE symbol indicates that special care and attention is required.

The drawing inside the triangle shows the specific caution.



A CIRCLE with a diagonal line inside shows action which users may not perform.

The drawing inside or under the circle shows the specific action that is not allowed.



Outline characters on a colored background show instructions users should follow.

It may also include the drawing that shows the specific instruction.

Screen Examples In This Manual

The screen examples in this manual are subject to change without notice in the interest of product improvement.

If the actual displayed screen differs from the screen examples in this manual, operate by following the actual displayed screen while referring to the User's Manual of the scanner application you are using.

Furthermore, the screenshots in this manual are for the ScanSnap Manager, the CardMinder application, and Adobe Acrobat.













About Maintenance

The user must not perform repairs on this scanner. Contact the store where you purchased the scanner or an authorized FUJITSU Image Scanner service provider to make repairs to this product.

■ Safety Precautions













FOLLOW THESE INSTRUCTIONS AND BE SURE TO HEED ALL WARNINGS AND CAUTIONS DESCRIBED BELOW.

⚠ WARNING

	Do not touch the power plug with wet hands. Doing so might cause electric shock.
	
	A damaged AC cable may cause fire or electric shock. Do not place heavy objects on AC cables, or pull, bend, twist, heat, damage or modify AC cables. Also, do not use damaged AC cables or power plugs, and AC cables or power plugs when the wall socket is loose.
	Do not use cables other than the ones supplied with this product. Use only specified AC cables and connector cables. Failure to use the correct cables might cause electric shock and equipment failure.
	Use this scanner only at the indicated power voltage and current. Improper power voltage and current might cause fire or electric shock. Also, do not connect to multiple-power strips.
	Wipe off any dust from metal parts on the power plug or metal fittings with a soft, dry cloth. Accumulated dust might cause fire or electric shock.
	Do not install the scanner in locations subject to oil smoke, steam, humidity, and dust. Doing so might cause a fire or electric shock.
	If you detect heat coming from the device or detect other problems such as smoke, strange smells or noises, immediately turn off the scanner and then disconnect its power plug. Make sure that the smoking has stopped, and then contact the store where you bought the scanner or an authorized FUJITSU scanner service provider.
	If the scanner is damaged for any reason, turn off the scanner and unplug the power cable before contacting the store where you purchased the scanner.
	Do not insert or drop metal objects into the scanner. Do not scan wet documents or documents with paper clips or staples. Do not splash or allow the scanner to get wet.
	If foreign objects (water, small metal objects, liquids, etc.) get inside the scanner, immediately turn off the scanner and disconnect the power plug from the power outlet, then contact the store where you bought the scanner or the Maintenance Service Center. Pay particular attention to this warning in households where there are small children.
	
	Do not take apart or modify the scanner. The inside of the scanner contains high-voltage components. Touching these components might cause fire or electric shock.

⚠ CAUTION

The following describes important cautions.

	Install the scanner on a desk so that none of its parts protrude outside of the desktop. Also, make sure that the scanner is installed on a flat, level surface
	Do not install the scanner on unstable surfaces. Install the scanner on a level surface that is free of vibration to prevent it from falling. Install the scanner on a strong surface that will support the weight of the scanner and other devices.
	Firmly insert the power plug into the power outlet as far it can go.
	Install the scanner away from strong magnetic fields and other sources of electronic noise. Also, protect the scanner from static electricity as this might cause the scanner to malfunction.
	Do not use aerosol sprays to clean the scanner. Aerosol sprays cause dirt and dust to enter the scanner, resulting in scanner failure and malfunction.
	When the scanner is not used for a long period, be sure to disconnect the power plug from the power outlet for safety.
	Do not install the scanner in the direct sunlight or near heating apparatus. Doing so might cause excessive heat to build up inside the scanner, causing fire or scanner trouble. Install the scanner in a well-ventilated location.
	Do not block the ventilation ports. Blocking the ventilation ports generates heat inside of scanner, which may result in fire or scanner failure.
	Do not place heavy objects on the scanner or use the scanner's top surface for performing other work. Improper installation might cause injuries.
	Do not move the scanner with the power and interface cables connected as this might damage the cables, causing fire, electric shock or injuries. Before moving the scanner, be sure to disconnect the power plug from the power outlet, and disconnect data cables. Also, make sure that the floor is free of obstructions.
	Avoid touching any scanner mechanism when scanning as this may cause injuries.
	Do not use the device immediately after moving it from a cold place to a warm room. This may cause condensation, which might lead to scanning errors. Let the device dry about one or two hours before you use it.
	When you perform cleaning, make sure that the inside of the scanner is free of any foreign object, and be careful not to get your hand or the cloth caught on the pick spring (metal part) as a deformed pick spring (metal part) may cause injury.

1. Preparation

This chapter describes necessary preparations before using ScanSnap.



Do not connect the scanner to your PC before installing "ScanSnap Manager". If the scanner is connected before installing ScanSnap Manager, it will not operate correctly. Refer to Chapter 2 for the installation of ScanSnap Manager.

1.1. Checking the Contents of the Package

When you unpack the scanner package, make sure that all parts are included.

Refer to the package contents list included the scanner package box.

1.2. Names and Functions of Parts

This section describes the names and functions of parts.

■ Front Side

Paper chute cover

Open this cover when using the scanner.
→ Opening the cover turns ON the scanner.

ADF cover (ADF: Automatic Document Feeder)

Stacker
Place the scanner aligning the two front projection to the hollows on the bottom of the scanner.

Cover open lever
Pull this lever to open the ADF COVER.

Paper chute cover
Open this cover and load the documents onto this part when scanning documents.

Side guide
Adjust these guides to the documents width for preventing skewed images.

Stacker
For using this part, pull it out as shown in the figure.
→ Documents are ejected from the ADF onto this tray.

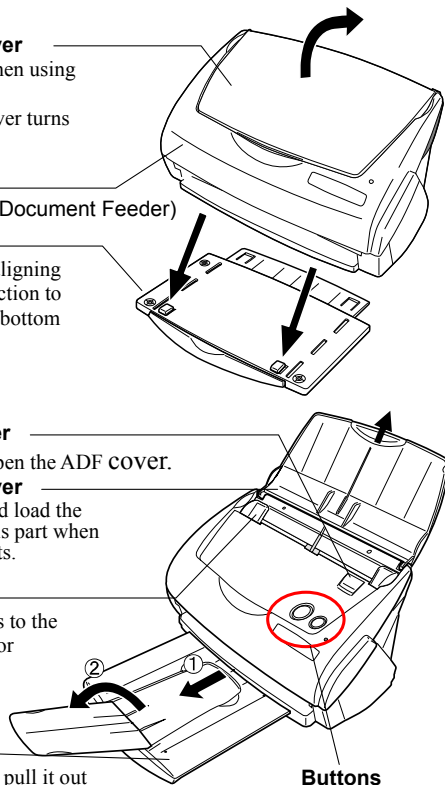

* You can also use the scanner without the Stacker.

■ Buttons



[SCAN] button

Starts scanning.

[POWER] button

Turns on/off the power supply.

Power lamp

Indicates the scanner status.

Green :Ready
Green (Blinking) :Scanning
Orange :Error
Light off :Power off

■ Rear Side

USB connector

AC adapter connector

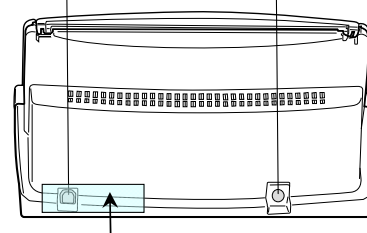

Seal: After installing ScanSnap Manager onto your computer, remove this seal to connect the scanner to the PC.



For the Document Specification, refer to the "ScanSnap fi-5110EOX Operator's Guide" stored in ScanSnap Setup CD-ROM.



The scanner is turned on/off automatically, when you open/close the Paper chute cover. To turn off the scanner when the cover is opened, press the [POWER] button.

2. Connecting ScanSnap

This chapter describes how to connect ScanSnap to your PC.

2.1. Installing the Supplied Software

Before connecting the scanner to your computer, please install the following software on your PC.

- ① Adobe Acrobat 6.0 (Application)
- ② ScanSnap Manager (Driver)
- ③ CardMinder (Application)
- ④ PDF Thumbnail View (Application)



- **Be sure to install “ScanSnap Manager” before connecting the scanner to your PC.**

If the scanner is connected before installing ScanSnap Manager, the “Found New Hardware Wizard” appears (This screen may differ depending on the used OS). In this case, click the **[Cancel]** button to close the wizard.

- It is not possible to simultaneously connect both ScanSnap fi-5110EOX and fi-4110EOX series scanners (or two or more fi-5110EOX scanners) to one computer.
- If any driver of the ScanSnap fi-4110EOX series has already been installed on your computer, uninstall it before starting the installation.
- In case of ScanSnap fi-4010CU, you can use it with this scanner without uninstall its driver.
- When using Windows 2000 or Windows XP, log on as a user with administrator privileges.
- ScanSnap fi-5110EOX is required as follows:
CPU: Intel® Pentium® III 600MHz or higher (recommended: Intel® Pentium® 4 1.8GHz or higher)*

Memory: 128MB or more (recommended: 256MB or more)*

* If the CPU and the memory do not meet the recommended requirements or the USB version is 1.1, the scanning speed will slow down.



ScanSnap Manager includes the driver software for ScanSnap! fi-4110EOX2. You can use this driver also for ScanSnap! fi-4110EOX2, if you have.

* It is not possible to simultaneously connect ScanSnap fi-5110EOX and ScanSnap! fi-4110EOX2 to one personal computer.

2.1.1. Installing Adobe Acrobat 6.0

Please prepare the Adobe Acrobat 6.0 CD-ROM.



Adobe Acrobat 6.0 is not supported by Windows 98 and Windows Me

1. Insert the “Adobe Acrobat 6.0 CD-ROM” into the CD-ROM drive.

⇒ The “Adobe Acrobat 6.0 AutoPlay” window appears.



This window is not displayed automatically when the “Auto play” setting of your computer is deactivated. In this case, please run “AutoPlay.exe” of this CD-ROM directly using the “Explore” or “My computer”.

2. Select [Install] and click the [Install Acrobat 6.0 Standard] button.



3. Click the [Next>] button.

⇒ The installation starts, and the setup window appears.

4. Follow the instructions to install the software.



Click the [How to install] button on the [Adobe Acrobat 6.0 AutoPlay] window to learn more about the Adobe Acrobat 6.0 installation. Refer to “**Adobe Acrobat Help**” about how to use Adobe Acrobat 6.0.



Support and User registration for Adobe products

For details, refer to the technical support information stored in the [Customer Support] folder on Adobe Acrobat 6.0 Standard CD-ROM. (Note that free person-to-person support is not available for this is bundled product.)

2.1.2. Installing ScanSnap Manager, CardMinder and PDF Thumbnail View

Please prepare the ScanSnap Setup CD-ROM.

1. Insert the “ScanSnap Setup CD-ROM” into the CD-ROM drive.

⇒ The “ScanSnap Setup” window appears.



This window is not displayed automatically when the "Autoplay" setting of your computer is disabled. In this case, run "Setup.exe" of this CD-ROM directly using the "Explore" or "My computer".

2. Click the [Install Products] button.

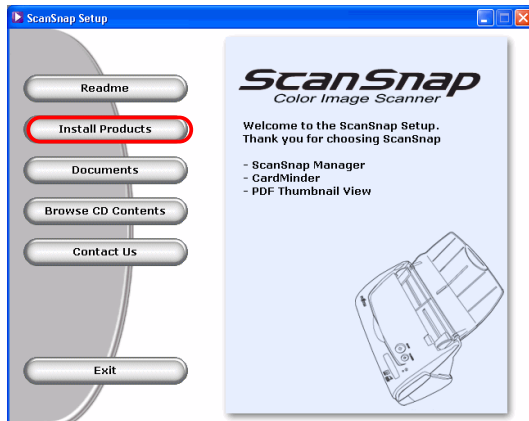

⇒ The installation of ScanSnap Manager, CardMinder and PDF Thumbnail View starts up, and the wizard window appears.

3. The setup window appears. Follow the instructions on the window to install the application.



The following window appears during the installation.

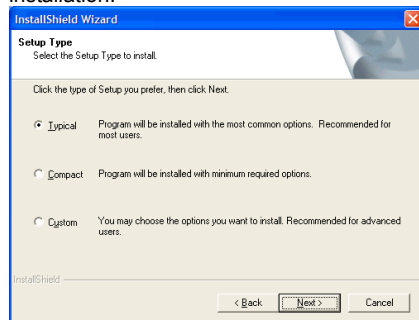

[Typical] <Recommended>
 "ScanSnap Manager", "CardMinder" and "PDF Thumbnail View" are installed including their manuals.
 [Compact]
 "ScanSnap Manager" is installed including its manual.
 [Custom]
 You can select the software and the manuals to install.

4. After the installation is completed, please restart your computer.



Refer to the "ScanSnap Operator's Guide" to learn more about ScanSnap Manager or the installation of CardMinder.

2.2. Connecting the Scanner

After the computer has been restarted, please connect the scanner.

2.2.1. Connecting the AC cable



Do not use cables other than the ones supplied with this product. Use only the specified AC cables and AC adapter.

1. Connect the AC cable to the AC adapter.

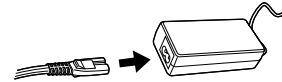

2. Insert the connectors of the AC adapter to the scanner inlet and a power outlet.

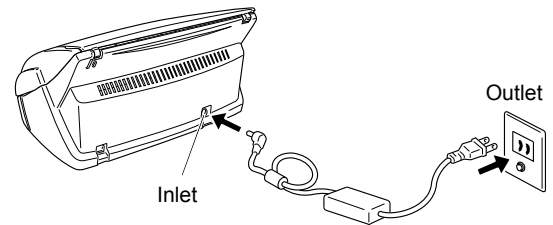

2.2.2. Connecting the USB cable

Follow the procedure below to connect the USB cable.



- Use the USB cable supplied with this scanner. The operation with a commercially available USB cable is not guaranteed.
- When connecting to a USB hub, be sure to connect the scanner to the hub nearest to your computer (first stage). If you connect it to a USB hub from the second stage onwards, ScanSnap may not operate correctly.

1. Remove the seal from the USB connector.
2. Connect the scanner and your computer with the USB cable.

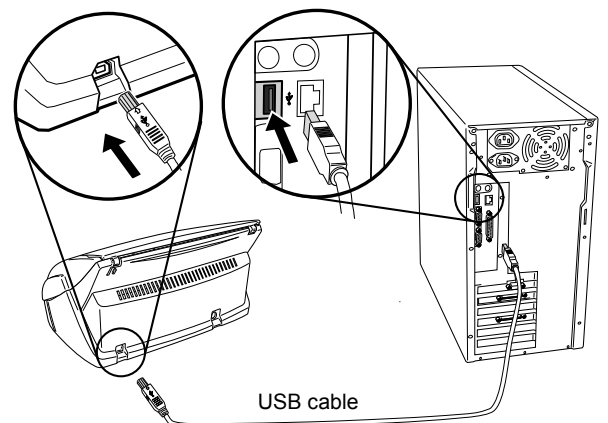

- Open the Paper chute cover of scanner.



If the scanner is not automatically turned on, press the [POWER] button on the scanner.

⇒ Your computer will automatically detect the scanner.

For Windows 98

There is a request to insert a disk. When such a message appeared, insert the Windows 98 CD-ROM into the CD-ROM drive.

Then click the [OK] button.

For Windows Me

The new hardware is detected and the installation will be completed automatically.

For Windows 2000

When [Digital Signature not Found] appears, click the [Yes] button.

For Windows XP

- When [Found New Hardware Wizard] appears, click the [Next >] button.

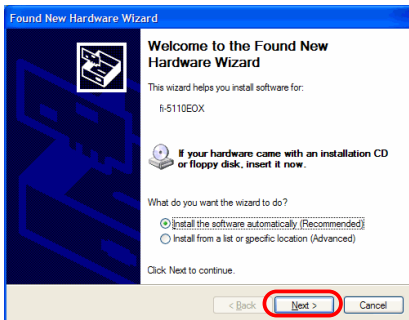

- When [Hardware Installation] appears, click the [Continue Anyway] button.

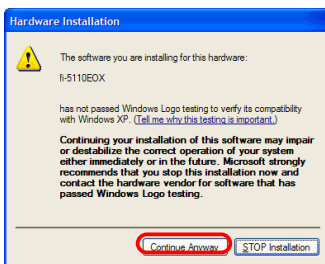

- Click the [Finish] button when the installation is completed.

The installation of ScanSnap is complete!



The "ScanSnap Manager" icon in the task tray is displayed as .

When the icon remains as , press the [POWER] button to turn off the scanner and then press the [POWER] button again to restart the scanner.



When you turn off/on the scanner, press the [POWER] button for longer than one second.
*For preventing mis-operation, the [POWER] button does not work unless it is pressed for longer than one second.

3. How to Use ScanSnap

This chapter describes basic operation of ScanSnap.

3.1. Scanning Documents

With “ScanSnap” you can turn paper office documents on your desk into digital files and save them just by pressing a single button. The scanned image can be viewed on the screen using the supplied applications (Adobe Acrobat, CardMinder).

Two typical usages are:

- ① Create digital backups of general office documents in PDF format. View or edit them later using “Adobe Acrobat”.
- ② Scan and manage business cards. With “CardMinder”, scan, recognize and edit business cards, and export the data to a popular personal information manager application such as Outlook.

3.2. About the Scan Settings

You can change ScanSnap settings by using “ScanSnap Manager”.

1. Right-click the “ScanSnap Manager icon”  on the task tray and select [Setting ...] from the following menu.

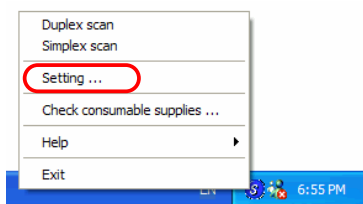

⇒ The “Scan and Save Settings” window opens.

2. Change the scan settings on the “Scan and Save Settings” window.

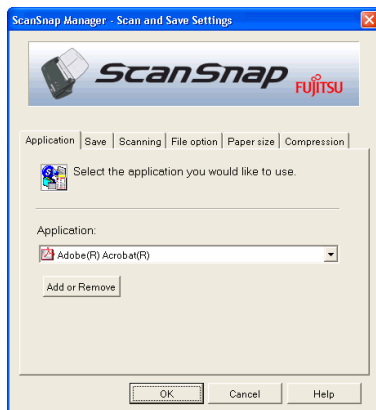

There are six tabs used to configure the scan options:

[Application]

Select the application for viewing/editing the scanned images.

[Save]

Specify the folder and file name to save the scanned images.

[Scanning]

Specify the quality of the scanned image.

[File option]

Select the file format (PDF, JPEG) for saving the scanned images.

[Paper size]

Select the size of the document to be scanned.

[Compression]

Select the compression rate of a file.



Refer to the “ScanSnap Operator’s Guide” in the “ScanSnap Setup CD-ROM” to learn more about these settings.

3. Click the [OK] button to finish the configuration.
⇒ The new settings are enabled.

3.3. Scanning Office Documents

1. Select “Adobe Acrobat” at [Application:] under the [Application] tab of “Scan and Save Settings”.
2. Load the documents onto the scanner.

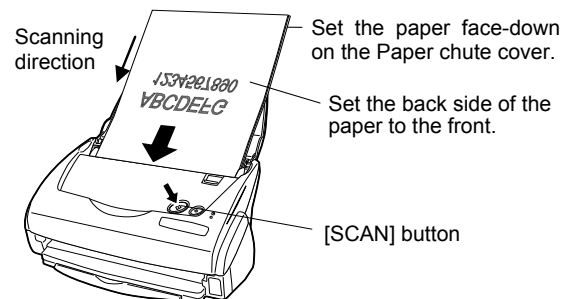

3. Press the [SCAN] button.

⇒ Scanning starts.

⇒ When the scanning is completed, Adobe Acrobat starts and displays the scanned images.



- You can also use another application to display scanned images.
- Pressing [SCAN] button, the documents are scanned in the “Duplex” mode. To scan the document in the “Simplex” mode, change this setting using the ScanSnap Manager .
- The ScanSnap scanner is able to scan documents using various settings. Refer to the “ScanSnap Operator’s Guide” on the “ScanSnap Setup CD-ROM” to learn more about scanning documents.

3.4. Scanning Business Cards

1. Select “CardMinder” at [Application:] under the [Application] tab of the “Scan and Save Settings” window.



- When “CardMinder” is selected, only the [Application] and [Scanning] tabs are enabled.
- Refer to the “ScanSnap Operator’s Guide” on the “ScanSnap Setup CD-ROM” to learn more about the settings.

2. Load the business cards onto the scanner. Adjust the side guides to the business card width.

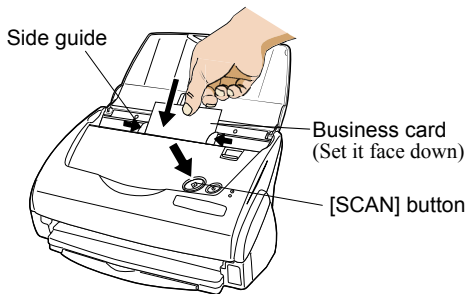

3. Press the [SCAN] button.
 - ⇒ Scanning starts.
 - ⇒ The “CardMinder” window appears and displays the recognized character data, name, company, and e-mail address.
4. The following window appears. Select a business card from the Data list. Check the data in the Recognition result field of this window. Correct the data if there is any recognition mistake.

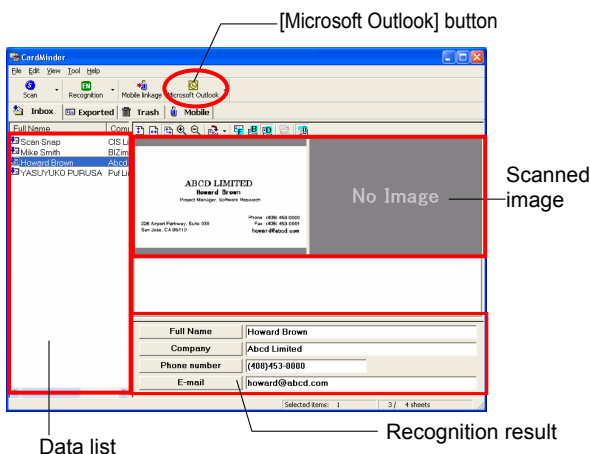

For Outlook, confirm the business card data and select the cards you wish to export to Outlook. Click the [Microsoft Outlook] button on the Toolbar. Then the data is exported to Outlook.



You can export the data (recognition results) to the following applications:

- Microsoft® Outlook®
- Outlook Express
- ACT!™
- GoldMine®

Or you can also save the data in CSV format to export them to other applications, such as Excel. Refer to the “CardMinder User’s Guide” for details.

5. Start Outlook to confirm the imported business card data.
6. To close “CardMinder”, select [Exit] in the [File] menu.



“CardMinder” provides also various other functions. Refer to “CardMinder User’s Guide” on the “ScanSnap Setup CD-ROM” for details.

3.5. About PDF Thumbnail View

“PDF Thumbnail View” is a program that allows you to use Windows Explorer for viewing PDF file thumbnails. However, this program is installed with ScanSnap Manager, but it is disabled by default.

(*This program is installed when the OS is Windows 2000 or Windows XP.)

Enabling PDF Thumbnail View

1. On the [Start] menu, select [Programs] – [PDF Thumbnail View] – [Configuration Tool].
 2. Select “Enable” and click the [OK] button on the “PDF Thumbnail View Function Settings” window.
- ⇒ You can see the thumbnail images of PDF files with the Windows Explorer just like bitmap or JPEG images.



Refer to the “ScanSnap Operator’s Guide” on the “ScanSnap Setup CD-ROM” for details.





4. Troubleshooting

This chapter describes common problems during the usage of ScanSnap and how to remedy them.

4.1. Troubleshooting Checklist

Before you ask for repair service, please check the following items.

If you cannot solve the problem even after checking the following items, contact the store where you purchased the scanner, or contact an authorized FUJITSU scanner service provider.

Symptom	Check This Item	Remedy
The scanner cannot be turned on.	Are the AC/USB cable and AC adapter connected correctly?	Correctly connect the AC/USB cable and AC adapter. Disconnect the AC adaptor/cable and reconnect them again.
	Is the Paper chute cover closed? (The scanner's power supply is controlled by closing/opening the Paper chute cover.)	Open the Paper chute cover.
	Is Windows started up completely? (The scanner's power supply is controlled by turning on/off the PC.)	Please wait until Windows has started up completely. The  LED may turn off when Windows is starting up or the scanner is in low power mode.
	Have you pushed the [POWR] button to turn off the scanner? (The scanner can be turned off by pressing the [POWER] button when the paper chute cover is opened.)	Press the [POWER] button on the scanner.
Scanning does not start.	Is the USB cable properly connected?	Correctly connect the USB cable. (When a hub is used, check the hub's power supply.)
	Does the  LED light blink repeatedly?	Disconnect the AC adaptor/cable and reconnect them again.
	Is ScanSnap Manager started? (If ScanSnap Manager is started successfully, the "ScanSnap Manager" icon  appears on the task tray.)	If the "ScanSnap Manager" icon is not displayed, on the [Start] menu, select [Programs] - [ScanSnap Manager] - [ScanSnap Manager] to start up ScanSnap Manager.
	Is ScanSnap Manager running normally? (If ScanSnap Manager is not running normally, the "ScanSnap Manager" icon in the task tray is displayed as  .)	Perform the following procedure: 1. Disconnect and reconnect the AC cable and AC adapter. If this does not change the state, perform step 2. 2. If a USB hub is being used, connect the scanner directly to your PC. If this does not change the state, perform step 3. 3. Restart your PC. 4. If none of the above trouble shootings remedies the problem, uninstall and re-install ScanSnap Manager.
	Is the "Scan and Save Settings" window still displayed?	Close the "Scan and Save Settings" window, and scan the document.
Vertical lines appear in the printed image.	Is the inside of the ADF dirty?	Clean the inside of the ADF following the instructions in "5. Daily Care".
The printed image shifts or is distorted.	Is the document loaded correctly?	Load the document correctly.
The image is printed white or dark.	When performing Black & White (B&W) scanning, is [Option...] - "Brightness" on the [Scanning] tab set extremely Light or Dark?	Adjust "Brightness" at [Scanning] - [Option...] in the "Scan and Save Settings" window.

Symptom	Check This Item	Remedy
Scanning speed is very slow.	Does your PC satisfies the recommended system requirements?	Check the system requirements in section 2.1, "Before Installing", of the Operator's Manual. Scanning speed will be slower whenever the CPU and memory requirements are not met. If this is the case, at [Scanning] - [Option...] in the "Scan and Save Settings" window, unmark the boxes of the following to increase the scanning speed. - Allow automatic image deskew - Allow automatic image rotation
	Is the USB 1.1 connected? Note: When using an USB1.1 interface, the data transfer rate may be slower due to large data sizes.	If your PC has an USB 2.0 port, connect the scanner to this port. (If using a USB hub, it must also support USB 2.0 interfaces.) (*1)
Double-feed frequently occurs. "Double-feed" is a phenomenon when two or more sheets of paper are fed simultaneously into the scanner.	Is the Pad ASSY dirty?	Clean the Pad ASSY following the instructions in "5.3. Cleaning Inside of the scanner".
	Is the Pad ASSY worn out?	Replace the Pad ASSY following the instructions in "6.2. Replacing the Pad ASSY".
	Is the document stack thicker than 5 mm?	Reduce the number of sheets of the document stack to 5 mm thickness or less.
Paper is not fed (stops midway).	Is the Pick roller dirty?	Clean the Pick roller following the instructions in "5.3. Cleaning Inside of the scanner".
	Is the Pick roller worn out?	Clean the Pick roller following the instructions in "6.3. Replacing the Pick Roller".
	Are there any debris on the document feeding path?	Remove any debris from the document feeding path.
The scanner is not recognized even if ScanSnap Manager is installed.	Did you connect the scanner to your PC before installing ScanSnap Monitor? Is the scanner registered as "Other device" in the "Device Manager"?	On the [Start] menu, select [Control panel] - [System] - [Hardware] - [Device Manager]. Delete the "Other Device" selection in the [Device Manager] and restart your PC.
The size of the scanned image file is the same as that for a color document even when you are scanning Black & White (B&W).	Is the B&W document scanned in the color mode?	Select "B&W" at [Color mode:] on the [Scanning] tab in the "Scan and Save Settings" window.
The back side of the document appears in the scanned image when scanning a double-sided document (noise of back side image).	Is the "Setting for text only document." checkbox unmarked at [Option...] on the [Scanning] tab in the "Scan and Save Settings" window?	Mark the "Setting for text only document." checkbox. (Available only in color mode)
Scanned images are not displayed on the screen (when "Allow automatic blank page removal" is enabled).	When "Allow automatic blank page removal" is enabled, documents containing only a few characters are recognized as blank pages and removed from the scanned image data accidentally.	Right click the "ScanSnap Manager" icon on the task tray, then select [Setting...] - [Scanning] tab and click the [Option...] button. Then unmark "Allow automatic blank page removal" check box.
Scanned images are skewed (when "Allow automatic image rotation" is enabled).	Are the documents fed into the ADF skewed +-5 degrees?	The "Allow automatic image rotation" function can correct skewed images up to +-5 degrees. Load the document onto the scanner so that document skews will not exceed this limit.

*1) To confirm whether the scanner is connected with USB1.1 or USB2.0, right-click ScanSnap icon on the task and select [Help] - [About ScanSnap Manager], then click [Detail] button on [Version Information] window. [USB type] is displayed in [Scanner information].

* Visit our Web site for your reference. Other useful information will be posted on the FAQ corner at the following Web site.

<http://scansnap.fujitsu.com>

4.2. Clearing Paper Jams

1. Open the ADF while pulling the Cover open lever.
2. Remove the jammed document.
3. Close the ADF cover.

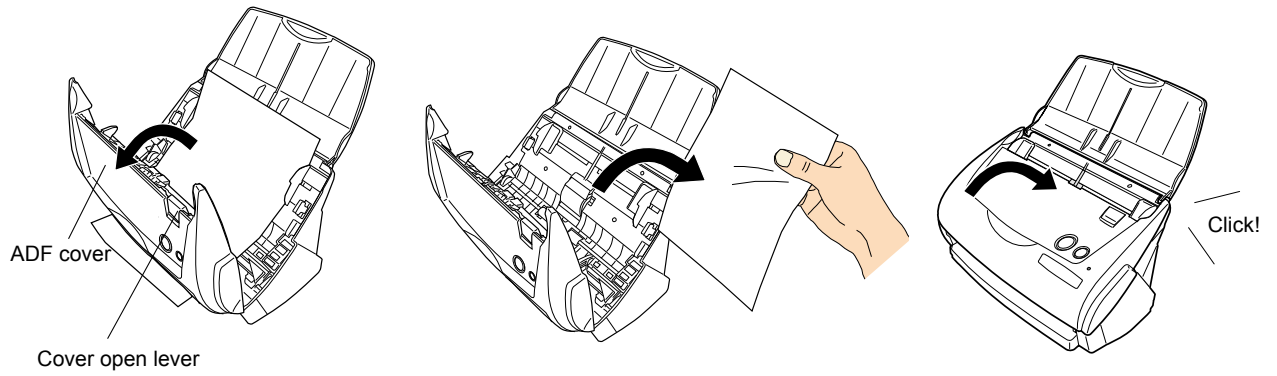

⇒ You should hear the ADF cover click into position when it returns to its original position.

5. Daily Care

This chapter describes how to clean the ScanSnap scanner.



Fire/Electric Shock

Before cleaning the scanner, disconnect the AC adapter from the power outlet.

5.1. Cleaning Materials

Cleaning Materials	Parts No.	Remarks
Cleaner F1	CA99501-0013	1 bottle (100ml) Moisten cloth with this fluid and wipe the scanner clean. (*1)

*1) To purchase the cleaning material, contact the FUJITSU scanner dealer where you purchased the scanner.

5.2. Cleaning the Scanner Exterior

Clean the scanner exterior and the Paper chute cover with a dry cloth moistened with a small amount of neutral detergent or Cleaner F1.



- Never use paint thinner or other organic solvents.
- During the cleaning, take care not to let water or other moistures getting into the inside of the scanner.
- Do not use aerosol sprays to clean the scanner. Aerosol sprays cause dirt and dust to enter the scanner, resulting scanner failure and malfunction.

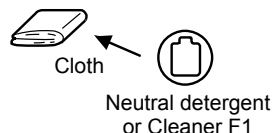
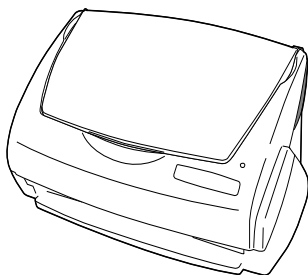

5.3. Cleaning Inside of the scanner

Clean inside of the scanner with a cloth moistened with cleaner F1.

In an alternating succession of scanning documents, the accumulated paper-powder and dust inside the scanner causes a scanning error.

As a guideline, clean the ADF every 1,000 scans. Note that this guideline varies according to the type of document you are scanning. For example, the ADF has to be cleaned more frequently when scanning photocopied documents on that the toner has not been sufficiently fixed on.

Clean the ADF according to the following procedure referring to the illustrations.



The glass surface inside the ADF becomes hot during the scanner operation.

Before you start cleaning the inside of the scanner, disconnect the AC adapter from the outlet, and wait at least 15 minutes to let the scanner cool down.

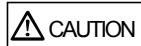

When you perform cleaning, make sure that the inside of the scanner is free of any foreign object, and be careful not to get your hand or the cloth caught on the pick spring (metal part) as a deformed pick spring (metal part) may cause injury.



- Never use water or neutral detergent to clean the inside of the scanner.
- Do not use aerosol sprays to clean the scanner. Aerosol sprays cause dirt and dust to enter the scanner, resulting scanner failure and malfunction.

1. Open the ADF cover while pulling the Cover open lever.

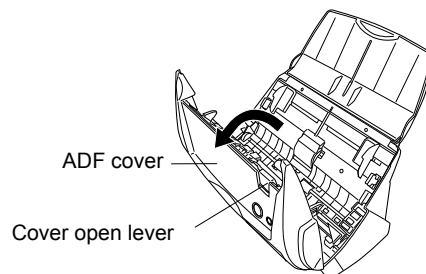

2. Clean the following locations with a cloth moistened with the Cleaner F1.

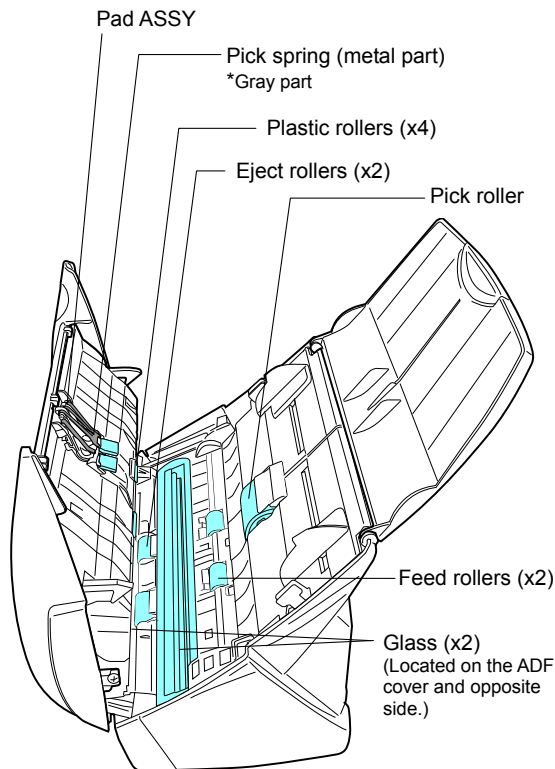

Pad ASSY (x1)

Clean the Pad ASSY downward. When cleaning the Pad ASSY, be careful not to get your hand or the cloth caught on the pick spring (metal part).

Glass (x2 on the ADF cover and the opposite side)

Clean lightly.

Pick roller (x1)

Clean lightly taking care not to scratch and damage the surface of the roller. Take particular care when cleaning the Pick roller as black debris on the roller adversely affects the pickup performance.

Plastic rollers (x4)

Clean them lightly while rotating the rollers with your fingers. Take care not to roughen the surface of the rollers. Take particular care when cleaning the plastic rollers, as black debris on the rollers adversely affects the pickup performance.

Turn on the scanner before cleaning the following locations. Clean the following rollers, while rotating them.

Feed rollers (x2)

Clean the rollers lightly taking care not to roughen the surface of the rollers. Take particular care when cleaning the feed rollers, as black debris on the rollers adversely affects the pickup performance.

Eject rollers (x2)

Clean the rollers lightly taking care not to roughen the surface of the rollers.

Take particular care when cleaning the exit rollers, as black debris on the rollers adversely affects the pickup performance.

To rotate the feed rollers and the eject rollers, press the [POWER] button while holding down the [SCAN] button.

As a guideline, six presses of the [POWER] button make the rollers to rotate one full turn.

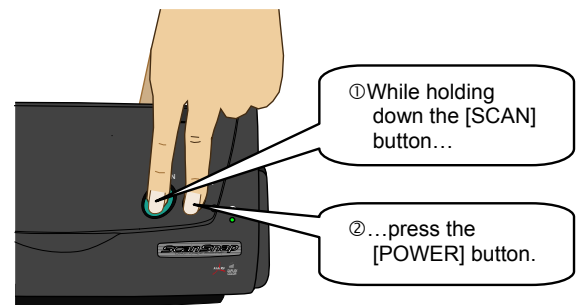

Connect the AC adapter and AC cable only when cleaning the Feed rollers and the Eject rollers.

3. Close the ADF cover.

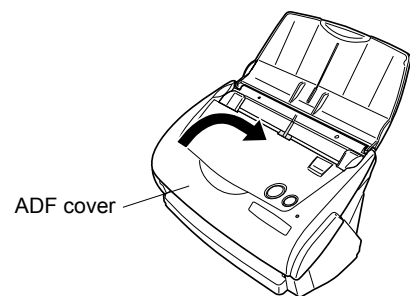

When you closed the ADF, make sure that it is completely closed. Otherwise, paper jams or other feeding troubles may occur.

6. Replacing Consumables

This chapter describes how to replace consumables.



Fire/Electric Shock

Before you replace the consumables of this scanner, disconnect the AC adapter from the outlet to turn off the scanner.

6.1. Part Numbers and Replacement Cycle of Consumables

The following table lists the part numbers of consumables and shows rough guidelines for replacing these parts.

No.	Description	P/N	Replacement Cycle
1	fi-5110EOX Pad ASSY	PA03360-0002	50,000 scan or one year
2	fi-5110EOX Pick roller	PA03360-0001	100,000 scans or one year

These replacement cycles are rough guidelines when A4/Letter wood-free paper 64 g/m² (17 lb) is used. The actual cycle may differ depending on the scanned paper. Use only the consumables specified by PFU LIMITED.



To estimate when the consumables will have to be replaced and to get an overlook of the already scanned pages, please refer to the following:

1. Right click the "ScanSnap Manager" icon on the task tray.
2. Click [Check consumable supplies] at the menu.

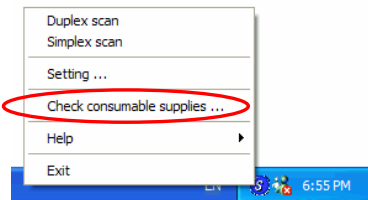

⇒ The screen ("Check consumable status" window) that indicates how many times consumables have been used will be displayed.

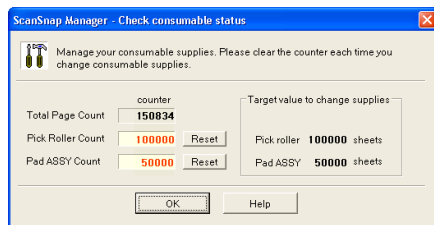

Replace the consumables referring to "Target to change supplies" as a rough guideline.

For details about consumables and where to purchase them, visit the following Website or contact the store where you purchased your scanner.

[Website] <http://scansnap.fujitsu.com/>

6.2. Replacing the Pad ASSY

Replace the Pad ASSY following the procedure below.

1. Remove the documents on the Paper chute cover.
2. Open the ADF cover while pulling the Cover open lever.

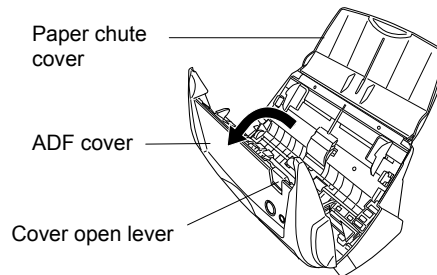

3. Remove the Pad ASSY. Pull out the Pad ASSY in the direction of the arrow while holding both ends of the Pad ASSY.

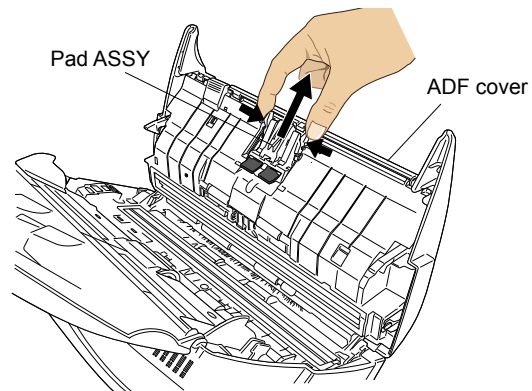

4. Attach the new Pad ASSY.

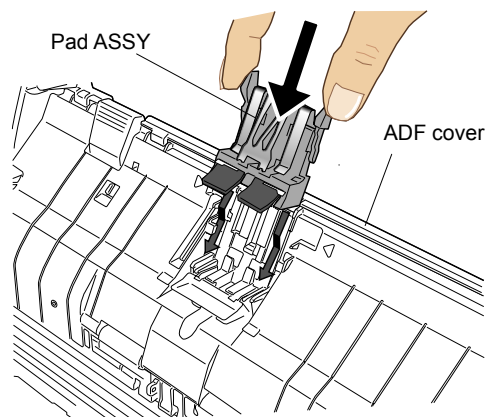

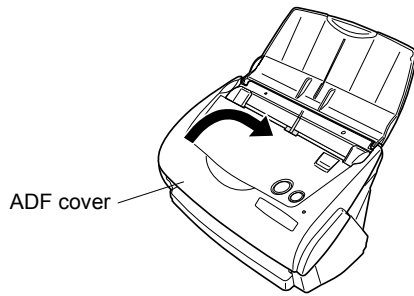

Make sure that the Pad ASSY is completely attached. Otherwise, document jams or other feeding errors may occur.

5. Close the ADF cover



⇒ You should hear the ADF cover click into position when it returns to its original position.

6. Turn on the scanner.

⇒ ScanSnap Manager icon changes from  to .

7. Right click the "ScanSnap Manager" icon  on the task tray, and select [Check consumable supplies] from the menu.

8. In the "Check consumable status" window, click the [Reset] button of the consumable you replaced.

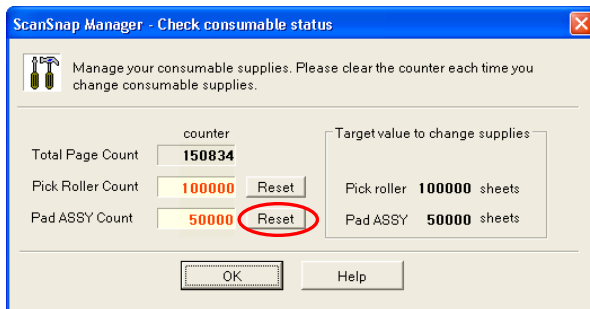

⇒ The counter is reset to "0".

6.3. Replacing the Pick Roller

Replace the Pick roller following the procedure below.

1. Remove the document on the Paper chute cover.
2. Open the ADF cover while pulling the Cover open lever.

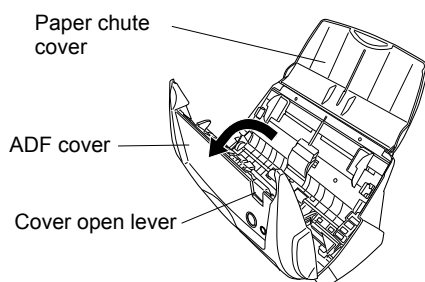

3. Remove the Sheet guide. Pinch the handle on the Sheet guide to remove it.

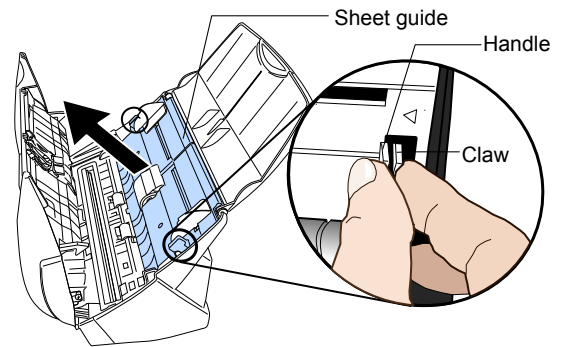

4. Rotate the Pick roller bushing (Left) in the direction of the arrow.

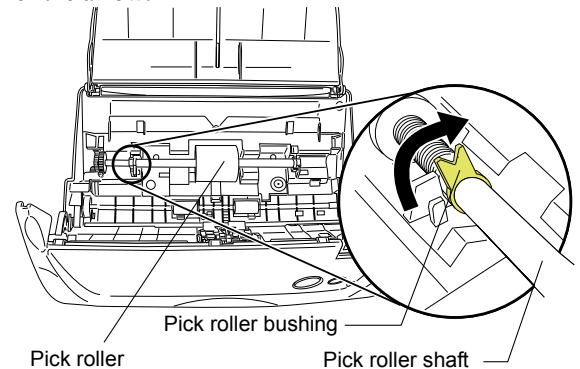

5. Remove the Pick roller with its shaft. Hold the left part of the shaft, and raise it to remove the shaft from the scanner while pulling the shaft to the left.

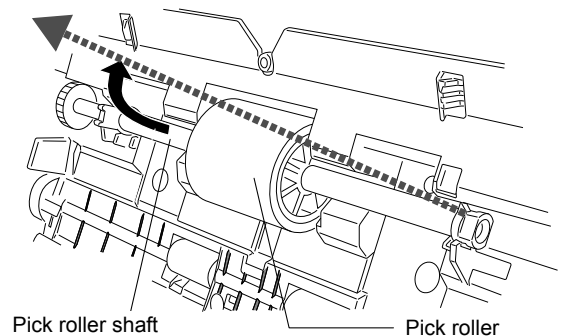

If the around the pick roller is dirty by paper-powder, it may cause a scanning error. Please remove the dirt using a dry cloth with dollop of Cleaner F1.
* Don't use water, mild detergent or air-spray.

6. Remove the Pick roller from the shaft.
Pull out the shaft from the Pick roller while lifting up its tab.

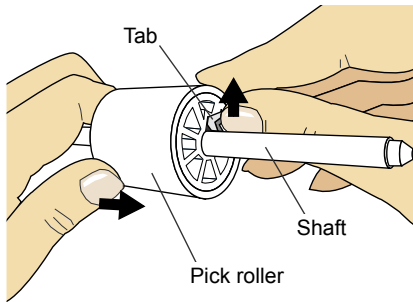

If you push up the pick roller tab using your fingernail, it may hurt or get chipped your fingernail. If you worry about that, you push up the pick roller tab using a paper clip.

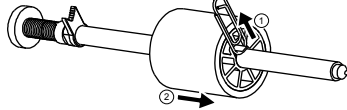

7. Attach the new Pick roller to the shaft.
Insert the new Pick roller aligning the protrusion with the slot on the Pick roller.

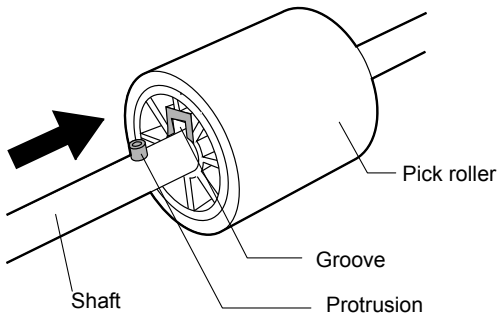

8. Install the Pick roller with its shaft into the scanner and set the shaft to the slot while lowering it.

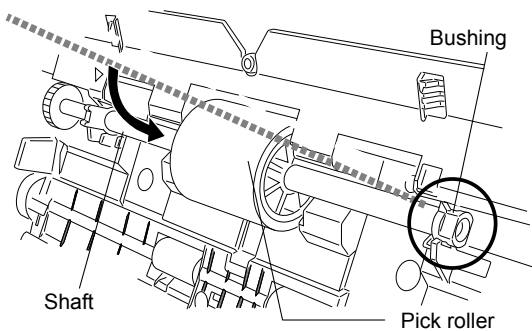

9. Fix the Pick roller bushing (left) by rotating it in the direction of the arrow.

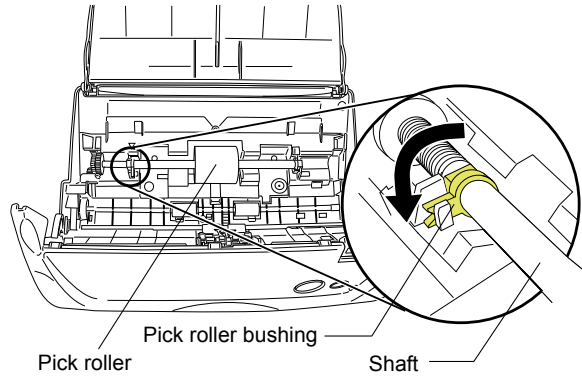

Make sure that the Pick roller is completely attached and correctly installed. Otherwise, document jams or other feeding errors may occur.

10. Attach the sheet guide to the scanner.
While holding the handle on the sheet guide, set the sheet guide into the scanner.

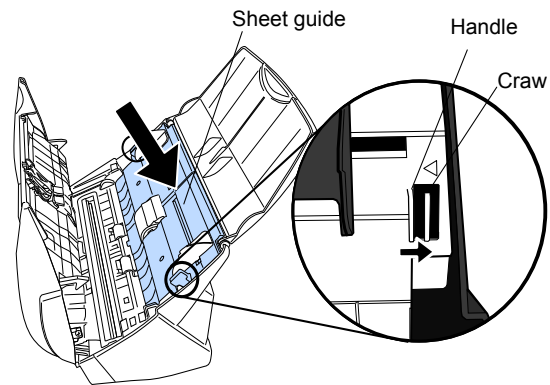

⇒ You should hear the sheet guide click when it returns to its original position.

11. Close the ADF.

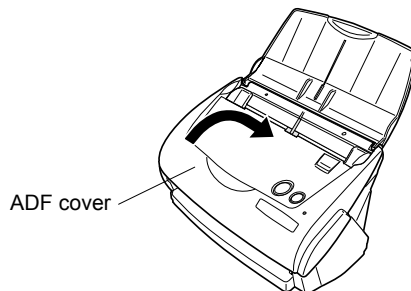

⇒ You should hear the ADF cover click when it returns to its original position.

12. Turn on the scanner.

⇒ ScanSnap Manager icon changes from to .

13. Right click the "ScanSnap Manager" icon  on the task tray, and select [Check consumable supplies] from the menu.
14. In the "Check consumable status" window, click the [Reset] button of the consumable you have replaced.

