

C150-E100-01EN

M3097DE/DG Image Scanner Operator's Guide

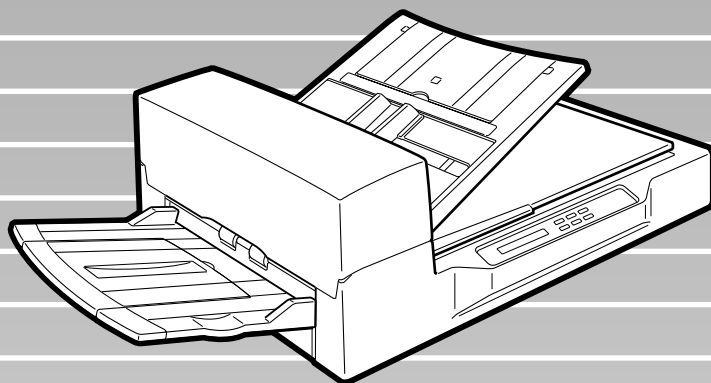

FUJITSU

M3097DE/DG
Image Scanner
Operator's Guide

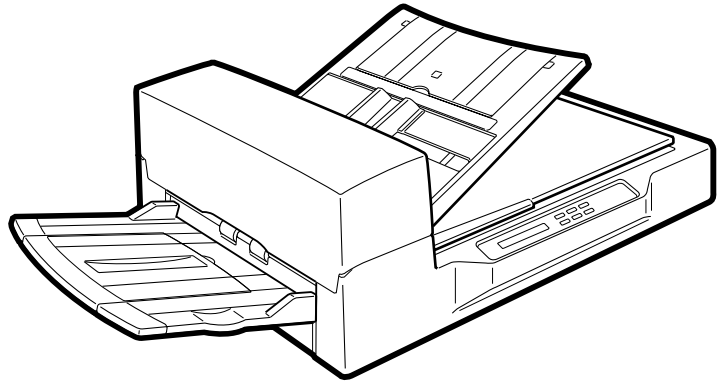

Edition	Date published	Revised contents
01	December, 1997	First edition
Specification No. C150-E101-01EN		

This equipment has been tested and found to comply with the limits for a Class A digital device, pursuant to Part 15 of the FCC Rules. These limits are designed to provide reasonable protection against harmful interference when the equipment is operated in a commercial environment. This equipment generates, uses, and can radiate radio frequency energy and, if not installed and used in accordance with the instruction manual, may cause harmful interference to radio communications. Operation of this equipment in a residential area is likely to cause harmful interference in which case the user will be required to correct the interference at his own expense.

This digital apparatus does not exceed the Class A limit for radio noise emissions from digital apparatus set out in the Radio interference Regulations of the Canadian Department of Communications.

Le présent appareil numérique n'émet pas de bruits radioélectriques dépassant les limites applicables aux appareils numériques de la classe A prescrites dans le Règlement sur le brouillage radioélectrique dicté par le ministère des Communications du Canada.

Maschinenlärminformationsverordnung 3. GSGV, 18.01.1991: Der arbeitsplatzbezogene Schalldruckpegel beträgt 70dB(A) oder weniger gemäß ISO 7779.

The contents of this manual may be revised without prior notice.

All Rights Reserved, Copyright © 1997 FUJITSU LIMITED.
Printed in Japan.

No part of this manual may be reproduced in any form without permission.

Please send your comments on this manual or on Fujitsu products to the following addresses:

FUJITSU COMPUTER PRODUCTS OF AMERICA, INC.
2904 Orchard Parkway, San Jose.
California 95134-2022, U.S.A.
TEL: 1-408-432-6333
FAX: 1-408-432-3908
Home page: <http://www.fcpa.com/>

FUJITSU AUSTRALIA LIMITED
475 Victoria Avenue Chatswood.
N.S.W2067, AUSTRALIA
TEL: 61-2-410-4555
FAX: 61-2-411-8603

FUJITSU CANADA, INC.
2800 Matheson Blvd. East, Mississauga.
Ontario 4X5, CANADA
TEL: 1-905-602-5454
FAX: 1-905-602-5457

FUJITSU DEUTSCHLAND GmbH.
Frankfurter Ring 211,
8000 München 40, F.R., GERMANY
TEL: 49-89-32378-0
FAX: 49-89-32378-100

FUJITSU ESPAÑA, S.A.
Edificio torre Europa 5ª
Paseo de la Castellana 95 Madrid 28046, SPAIN
TEL: 34-1-581-8400
FAX: 34-1-581-8125

FUJITSU EUROPE LTD.
2, Longwalk Road, Stockey Park, Uxbridge
Middlesex, UB11 1AB, U.K.
TEL: 44-81-573-4444
FAX: 44-81-573-2643
Home page: <http://www.fujitsu-europe.com/>

FUJITSU FRANCE S.A.
Bâtiment Aristote, 17 rue Olof palme
94006 Créteil cedex, FRANCE
TEL: 33-14-513-1616
FAX: 33-14-399-0700

FUJITSU HONG KONG Limited
Room 2521, Sum Hung Kai Centre
30 Harbour Road Wanchai, Hong Kong
TEL: 852-827-5780
FAX: 852-827-4724
TLX: 62667

FUJITSU ITALIA S.p.A.
Via Melchiorre Gioia, No.8-20124
Milano, ITALY
TEL: 39-2-6351
FAX: 39-2-6572257

FUJITSU NORDIC AB
Kung Hans vag, S-19176
Sollentuna, SWEDEN
TEL: 46-8-626-6000
FAX: 46-8-626-6711

FUJITSU LIMITED
International Operations
Marunouchi 1-6-1, Chiyoda-ku, Tokyo 100
JAPAN
TEL: (81-3)3216-3211
FAX: (81-3)3213-7174
TLX: J2283
Cable: "FUJITSU LIMITED TOKYO"
Home page: <http://www.fujitsu.co.jp/>

IMPORTANT NOTE TO USERS

READ CAREFULLY ALL OF THIS MANUAL BEFORE USING THIS PRODUCT. IF NOT USED CORRECTLY, UNEXPECTED DAMAGES MAY BE CAUSED TO THE USERS OR THE BYSTANDERS.

While all efforts have been made to ensure the accuracy of all information in this manual, FUJITSU assumes no liability to any party for any damage caused by errors or omissions or by statements of any kind in this manual, its updates or supplements, whether such errors are omissions or statements resulting from negligence, accidents, or any other cause. FUJITSU further assumes no liability arising from the application or use of any product or system described herein; nor any liability for incidental or consequential damages arising from the use of this manual. FUJITSU disclaims all warranties regarding the information contained herein, whether expressed, implied, or statutory.

FUJITSU reserves the right to make changes to any products herein, to improve reliability, function, or design, without further notice and without obligation.

Preface

This manual explains how to use the M3097DE/DG image scanner.

This manual contains COMPONENTS, INSTALLATION AND CONNECTION, OPERATING INSTRUCTION, DOCUMENT SPECIFICATION, SPECIFICATIONS and SETUP MODE.

Refer to “Cleaning and Maintenance” for the information about the routine operation of the M3097DE/DG.

Reference Guide contains OPERATING INSTRUCTION, CLEANING, REPLACEMENT OF PARTS, ADJUSTMENT and TROUBLESHOOTING.

The M3097DE/DG is very fast and highly functional image scanner developed for volume filing, using charge-coupled device (CCD) image sensors. This scanner features duplex scanning and high quality image, processing with an automatic document feeder (ADF).

Conventions

Special information, such as warnings, cautions are indicated as follows:

WARNING

WARNING indicates that personal injury may result if you do not follow a procedure correctly.

CAUTION

CAUTION indicates that damage to the scanner may result if you do not follow a procedure correctly.

The following symbols are used in this manual.



Used for general WARNING and CAUTION.



Be careful not to pinch your fingers or hands.

CONTENTS

□ CHAPTER 1	COMPONENTS	
	Checking the Components	1-1
	Units and Assemblies	1-2
	Operator Panel	1-5
□ CHAPTER 2	INSTALLATION AND CONNECTIONS	
	Precautions	2-1
	Inspection	2-2
	Removing the Carrier Fixing Bracket	2-4
	Cable Connection	2-5
	Mounting the Stacker	2-7
	SCSI-ID setting (M3097DG)	2-8
□ CHAPTER 3	OPERATING INSTRUCTION	
	Turning the Power On	3-1
	Reading Mode Setting (M3097DE)	3-2
	Manual Feed Mode Setting	3-8
□ CHAPTER 4	ADF DOCUMENT SPECIFICATION	
	Document Size	4-1
	Document Quality	4-2
□ CHAPTER 5	SPECIFICATIONS	
	Installation Specifications	5-1
	Dimensions	5-2
	Consumables	5-3
	Option	5-4
□ CHAPTER 6	SETUP MODE	
	Activating the Setup Mode	6-1
	Contents of the Setup Mode	6-2
□ GLOSSARY OF TERMS	GL-1
□ INDEX	IN-1

CHAPTER 1 COMPONENTS

COMPONENTS

CHAPTER 2 INSTALLATION AND CONNECTIONS

INSTALLATION AND CONNECTIONS

CHAPTER 3 OPERATING INSTRUCTION

OPERATING INSTRUCTION

CHAPTER 4 DOCUMENT SPECIFICATION

DOCUMENT SPECIFICATION

CHAPTER 5 SPECIFICATIONS

SPECIFICATIONS

CHAPTER 6 SETUP MODE

SETUP MODE

GLOSSARY OF TERMS

GLOSSARY OF TERMS

INDEX

INDEX

COMPONENTS

After unpacking the scanner, confirm that all the components have been received. This chapter describes the components of the scanner, part names, and operator panel arrangement and their function.

Checking the Components

Units and Assemblies

Operator Panel

Checking the Components

These high precision components must be handled with care. Confirm that all the components shown in the following figure have been received. If any component is missing, please contact your sales agent.

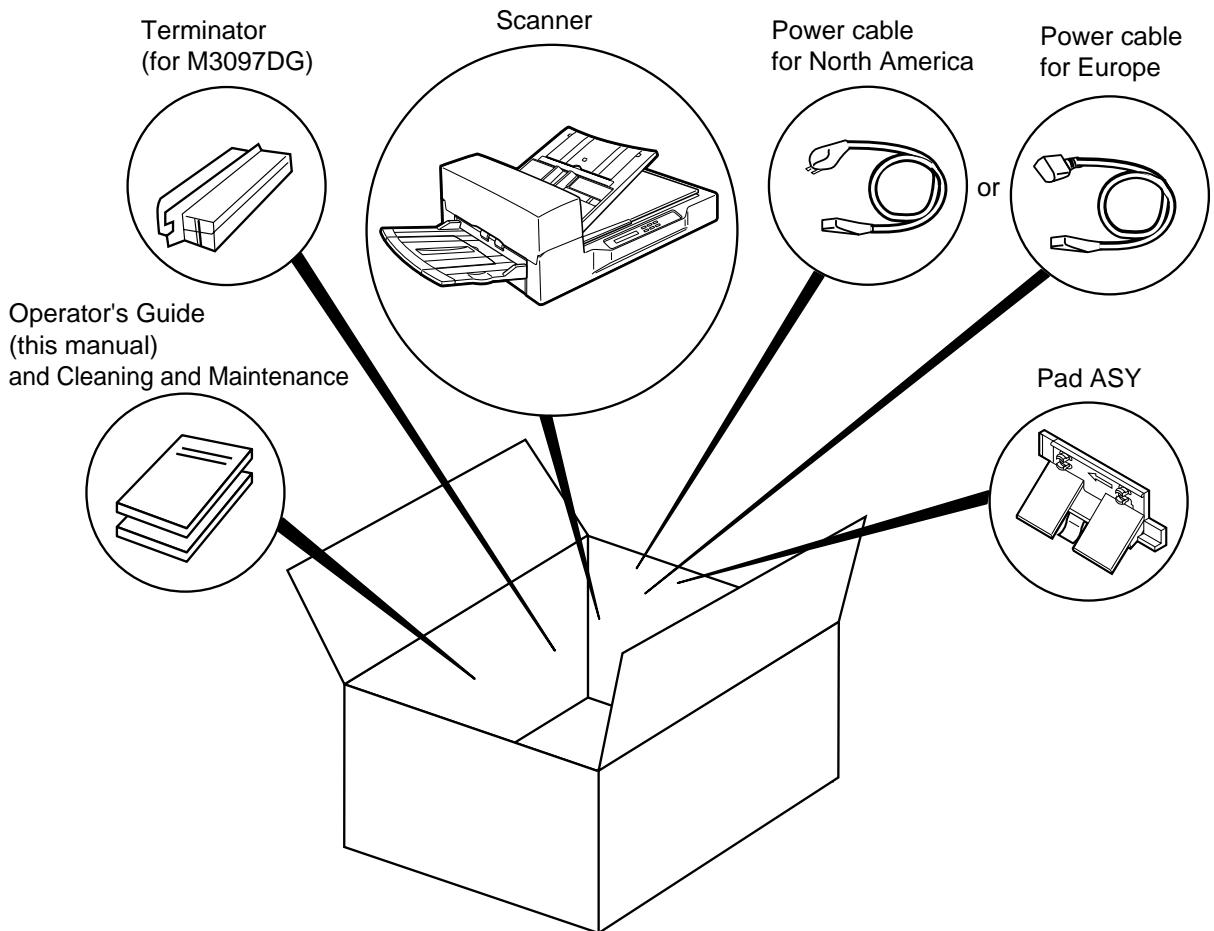

Units and Assemblies

This section shows the exterior view and assemblies of the scanner. This section also provides names of each part and describes their functions.

■ Units

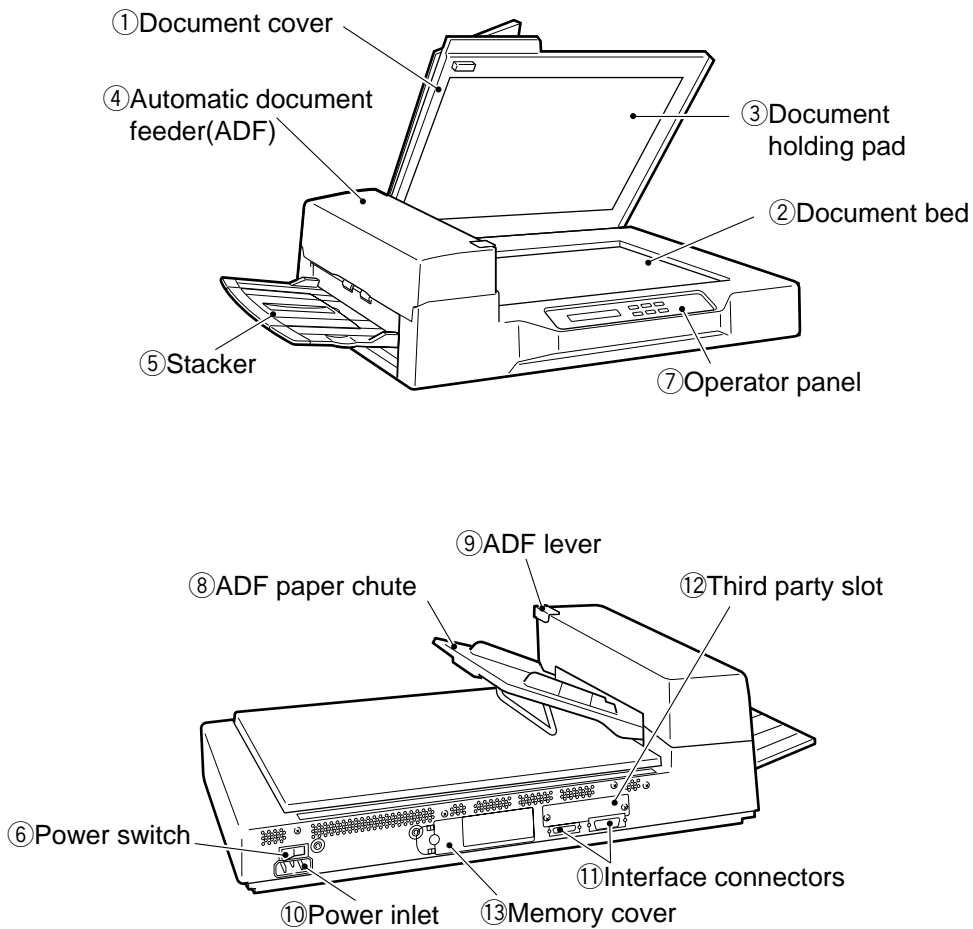

M3097DE

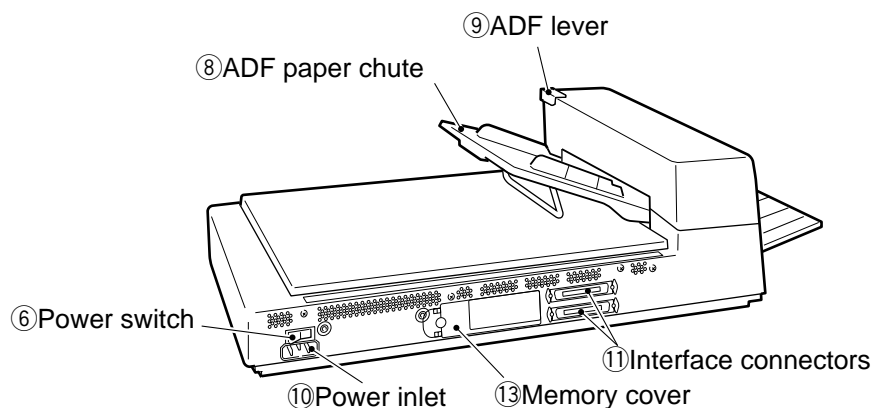

M3097DG

No.		Function
①	Document cover:	Closed over and holds a document to be read.
②	Document bed:	A document to be read is placed on the bed also called Flatbed (FB).
③	Document holding pad:	Presses a document to the document bed.
④	Automatic document feeder (ADF):	Automatically feeds documents to the reading position.
⑤	Stacker:	Stacks the read documents.
⑥	Power switch:	Turns the power on or off.
⑦	Operator panel:	The indication panel indicates the status of the scanner.
⑧	ADF paper chute:	Holds the documents to be fed by the automatic document feeder.
⑨	ADF lever:	Opens or closes the automatic document feeder to remove documents jammed in the feeder.
⑩	Power inlet:	To be connected to an AC power outlet with the power cable.
⑪	Interface connectors:	To be connected to the host system with interface cables.
⑫	Third party slot:	Reserved. (M3097DE)
⑬	Memory cover:	Reserved.

■ Assemblies

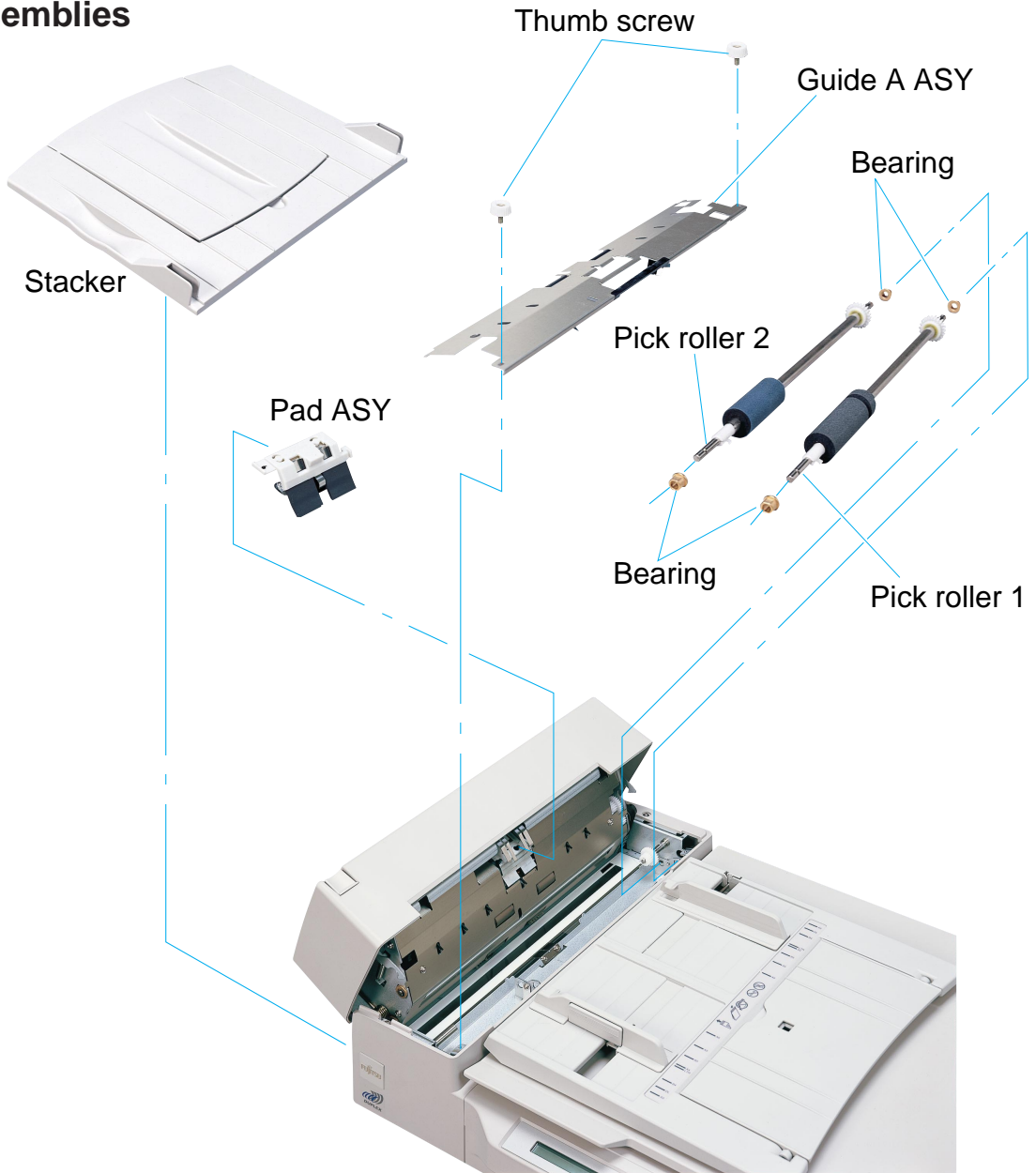

Operator Panel

The operator panel is located at the upper right hand side of the scanner. The panel consists of an LCD (24 character x 2 line), LEDs and buttons.

■ Arrangement

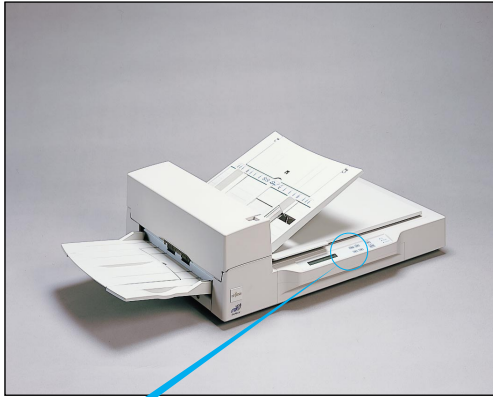

Operator panel



■ Button/LED Function

Name of the button and LED		Function
Button	Next	LCD displays the next screen.
	Previous	LCD displays the Previous screen.
	←	Moves the cursor to the left
	→	Moves the cursor to the right
	Exit	<ul style="list-style-type: none"> • When “CHECK” LED lights, pressing this button releases error status (turn off “CHECK” and returns to “Scanner Ready” screen). • When you are setting on the operator panel, pressing this button returns to “Scanner Ready” screen immediately.
	ENTER	The parameter selected by cursor becomes effective.
	(START)	When Manual start mode is set or “READ” lamp lights, this button is effective and starts the reading.
	(STOP)	This button is effective during reading operation and stops the reading.
LED		Indicates that the scanner is ON.
	READ	Indicates that the scanner is reading or ready to read.
	CHECK	<ul style="list-style-type: none"> • If it lights, it means that some alarm occurred. Pressing “Exit” button turns off “CHECK” lamp. • If it blinks at one second cycle, it means that jam or double feed is detected. Removing the jammed paper turns off “CHECK” lamp. At double feed, pressing “Exit” button turns off “CHECK” lamp. • If it blinks at four seconds cycle, it means that ADF cleaning is necessary.

■ Counter Display

The scanner is provided with the counter display.

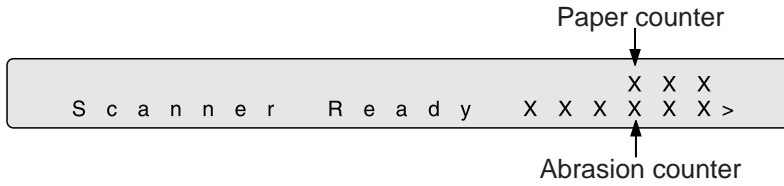

Counter	Function
Paper counter	Paper counter counts the scanned sheet from the start of reading to Paper Empty or an error detection. So this counter is automatically reset at the start of reading.
Abrasion counter	Abrasion counter counts the accumulated number of the scanned sheet. This counter increments at every 10 sheets. This counter is useful to check the cleaning cycle or parts replacement cycle. How to reset is described in Chapter 6.

Operation status

Operation status is indicated by the following message:

<Power-on>

W a r m i n g - u p N o w ! !

<Reading>

N o w R e a d i n g !

<Waiting for Start>
(Only M3097DE)

Scanner displays followig screen when waiting Start button pressed.

P l e a s e S t a r t S W O N

<Cleanig request>

When the Pick roller cleaning is necessary, the scanner displays as follows on the upper line.

P l e a s e C l e a n P i c k - r o l l e r
N o w R e a d i n g

When the ADF glass cleaning is necessary, the scanner displays as follows on the LCD.

P l e a s e C l e a n A D F g l a s s
N o w R e a d i n g

Clean the Pick roller or ADF glass in accordance with the manual, "Cleaning and Maintenance".

Temporary error

<Hopper empty>

P a p e r E m p t y

This message is displayed if there is no more paper on the ADF paper chute during a read operation in ADF mode. Fill the ADF paper chute with paper. To enable the read operation, press the stop button.

<Jam>

P a p e r J a m

This message is displayed if a document is jammed in the ADF. See “Cleaning and Maintenance” for removing jammed documents.

<ADF cover open>

A D F - C o v e r O p e n

This message is displayed if the ADF is not closed completely. Close the ADF completely, and enable the read operation.

<Double feed error>

D o u b l e F e e d E r r o r

This message is displayed when the ADF detects the Double feed error. Check the document and re-scan the document.

Alarm

One of the following message is displayed if an error occurs in the scanner. If one of the following error message is displayed, turn the power off and then on again. If the same message is displayed, contact your service representative.

<Optical alarm front>

O p t i c a l A l a r m (F)

<Optical alarm back>

O p t i c a l A l a r m (B)

<FB mechanism alarm>

M e c h a n i c a l A l a r m

<Motor fuse alarm>

M o t o r f u s e A l a r m

<Lamp fuse alarm>

L a m p f u s e A l a r m

<Image transfer alarm>
(M3097DG)

I m a g e T r a n s f e r A l a r m

<Memory alarm>

M e m o r y A l a r m

<EEPROM alarm>

E E P R O M A l a r m

INSTALLATION AND CONNECTIONS

The chapter describes how to install and connect the scanner.

Precautions

Inspection

Removing the Carrier Fixing Bracket

Cable Connection

Mounting the Stacker

SCSI-ID Setting (M3097DG)

Precautions

This section describes precautions when installing the scanner.

Do not install the scanner in the following places and environments.

- Place the scanner away from electrical noise sources, strong magnetic fields and air flow. If the scanner is used near an air conditioner, copying machine, or TV set, the scanner may operate incorrectly.
- Keep the scanner out of the sun and away from heaters. These environments may shorten the scanner life or cause hardware failures.
- Do not install the scanner in a place where vibrations may occur. This environment may cause hardware failures or may cause the scanner to operate incorrectly.
- Do not install the scanner in a humid, dusty, or damp places. These environments may shorten the scanner life or cause hardware failures. Do not place the scanner where liquid spills may occur.
- Be aware of the static electricity. Be sure that the flooring and the desk are made of materials that do not generate the static electricity.



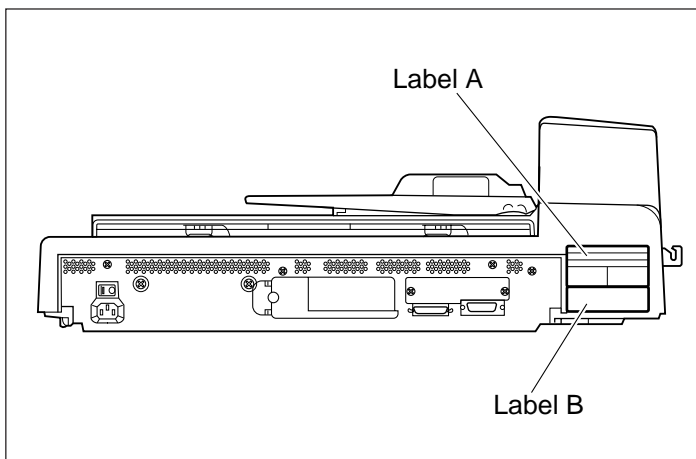

See Chapter 5 SPECIFICATIONS for the information such as the size of the installation space.

Inspection

This section describes how to check the labels.

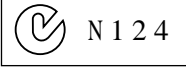

Label A (An example)

この装置は、クラスA情報技術装置です。この装置を家庭環境で使用すると、電磁妨害を引き起こすことがあります。この場合には使用者が適切な対策を講ずるよう要求されることがあります。		VCCI-A
This device complies with Part 15 of the FCC Rules. Operation is subject to the following two conditions: (1) This device may not cause harmful interference and (2) This device must accept any Interference received, including interference that may cause undesired operations:		
		FCC-A
This Class A digital apparatus meets all requirements of the Canadian Interference Causing Equipment Regulations. Cat. appareil numérique de la classe A respecte toutes les exigences du Règlement sur le matériel brouilleur du Canada.		CSA-EMI
 •LR 65408 NRTL-C	 N 1 2 4	  
$\sim 100 - 240 \text{ V}, 1 - 0.6 \text{ A}, 50/60 \text{ Hz}, 1\phi$		

Label B (An example)

IMAGE SCANNER																																																														
MODEL	M3097DE																																																													
PART NO.	CAO **** _ ****																																																													
SER. NO.	*****																																																													
DATE	1997- **		2*, * Kgf																																																											
FUJITSU LIMITED					<table border="1"> <tr> <td>Rev.</td> <td colspan="9">MODEL NAME</td> </tr> <tr> <td>Label</td> <td></td><td></td><td></td><td></td><td></td><td></td><td></td><td></td><td></td> </tr> <tr> <td></td> <td>0</td><td>1</td><td>2</td><td>3</td><td>4</td><td>5</td><td>6</td><td>7</td><td>8</td><td>9</td> </tr> <tr> <td></td> <td>0</td><td>1</td><td>2</td><td>3</td><td>4</td><td>5</td><td>6</td><td>7</td><td>8</td><td>9</td> </tr> <tr> <td></td> <td>0</td><td>1</td><td>2</td><td>3</td><td>4</td><td>5</td><td>6</td><td>7</td><td>8</td><td>9</td> </tr> </table>					Rev.	MODEL NAME									Label											0	1	2	3	4	5	6	7	8	9		0	1	2	3	4	5	6	7	8	9		0	1	2	3	4	5	6	7	8	9
Rev.	MODEL NAME																																																													
Label																																																														
	0	1	2	3	4	5	6	7	8	9																																																				
	0	1	2	3	4	5	6	7	8	9																																																				
	0	1	2	3	4	5	6	7	8	9																																																				
																																																														

Removing the Carrier Fixing Bracket

To keep the scanner from being damaged during shipping, the carrier unit is fixed with a bracket. After placing the carrier unit at the installation place, remove this bracket as explained below.

- ① Place the image scanner on the edge of the desk top so that the left side (where ADF is placed) of the scanner extends from the desk top. Do not set the image scanner upside down or on its side.

⚠ CAUTION

Do not extend the scanner more than 20cm (8 in.) from the desk.

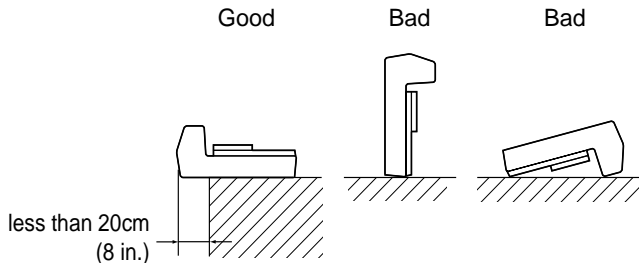

- ② Remove the carrier fixing bracket from position (A). Then install the carrier fixing bracket at position (B).

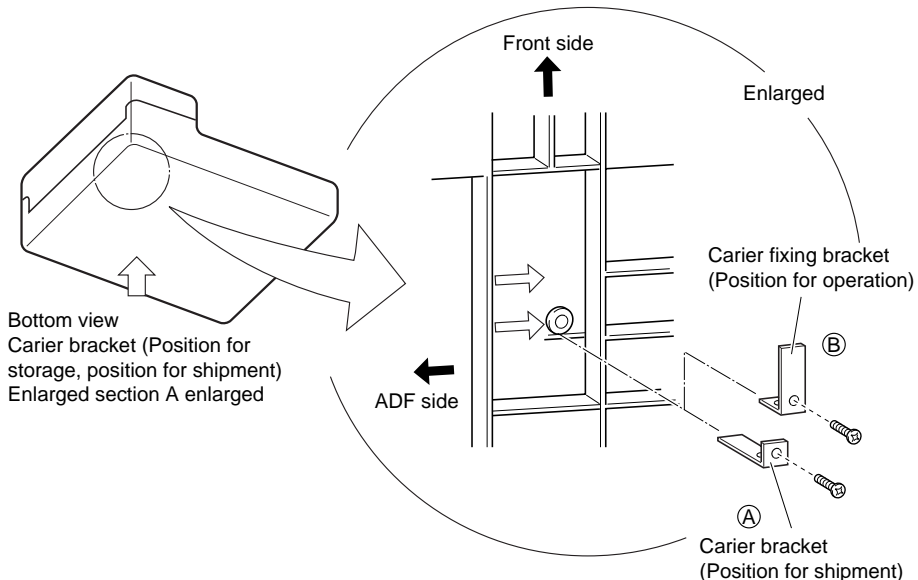

Cable Connection

This section describes how to connect the cables.
Connect the cables as follows:

■ Turning the power switch off

Press “O” side of the power switch to turn the power off.

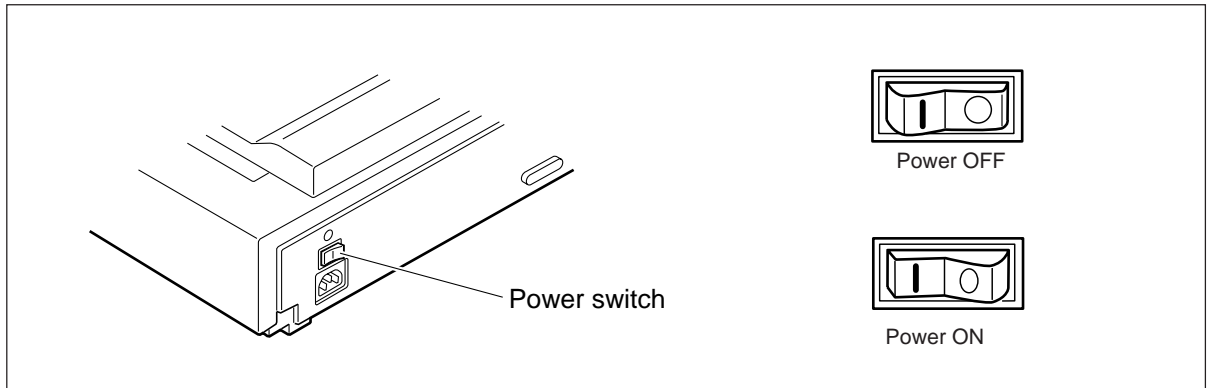

■ Connecting the power cable

Connect the power cable to the power inlet of the device and a power outlet.

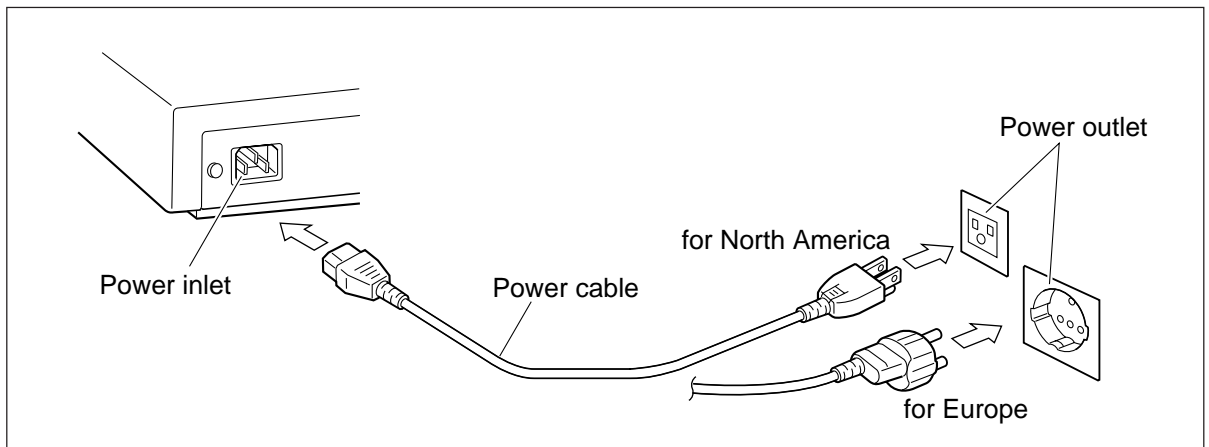

■ Connecting the interface cable

(M3097DE)

Connect the video interface and RS-232C interface cables and secure them with hooks and screws. Connect the other ends to the host machine.

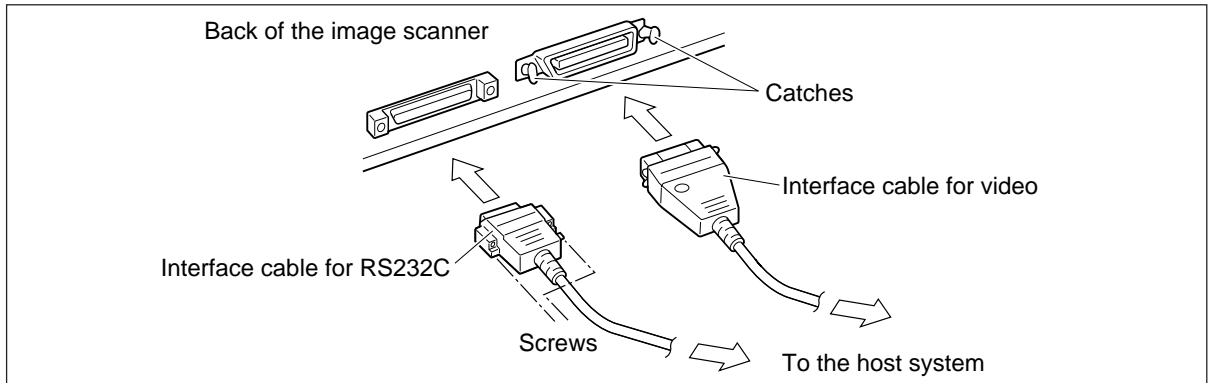

(M3097DG)

Connect the SCSI interface cables and secure them with hooks and connect the other ends to the host machine. When the scanner is at the terminal side, connect the terminator to the connector to which an interface cable is not connected.

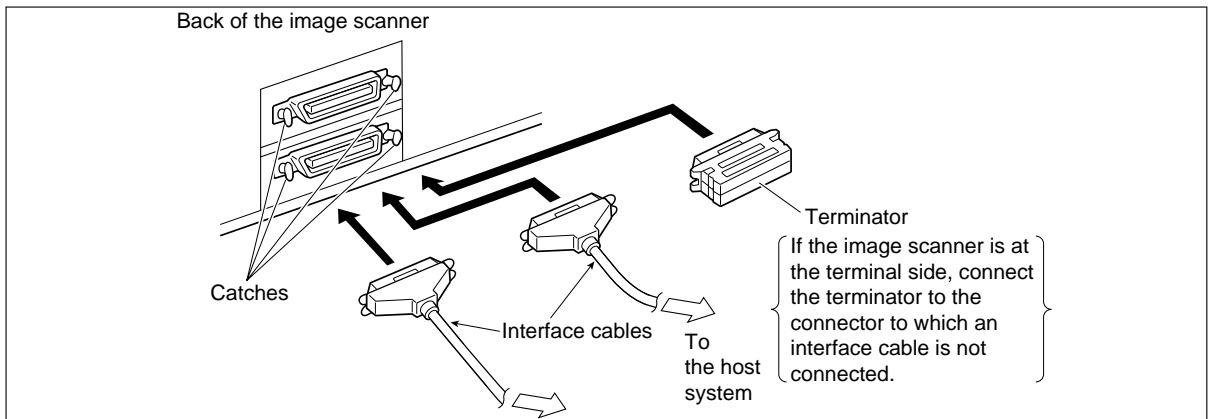

Mounting the Stacker

Mount the stacker using the following procedure.

- ① Mount the stacker.
Hook the pins on the stacker to the claws on the image scanner.

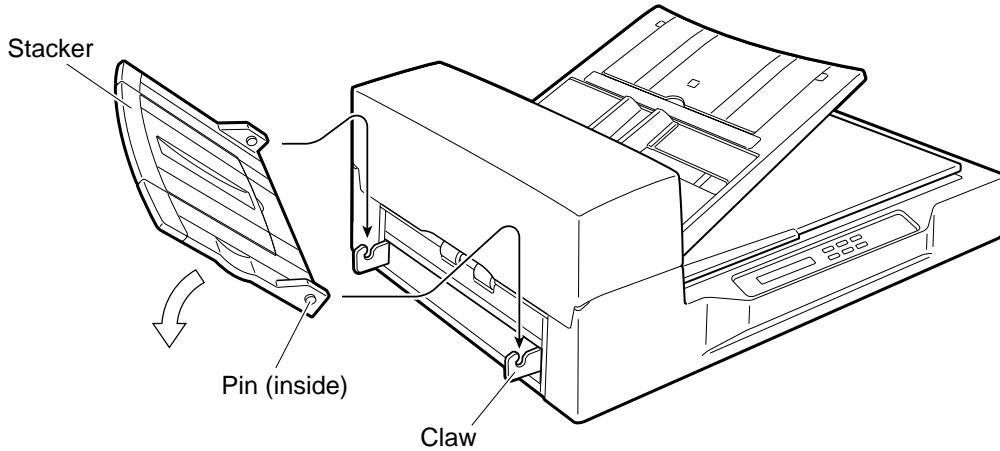

SCSI-ID setting (M3097DG)

The default of SCSI-ID is 5. SCSI-ID is set by Setup mode of the operator panel. The procedure to set SCSI ID is;

- 1 Turn the power ON by pressing “I” side of the power switch. The scanner displays “Scanner Ready” on the lower line of LCD.

```
S c a n n e r   R e a d y           >
```

- 2 Then press “Next” button. The scanner displays “Mode select 1”.

```
  M o d e   s e l e c t   1  
M M a n u a l   m o d e   C h a n g e   ?
```

- 3 Then press “Next” button. The scanner displays “Mode select 2” meaning that setup mode is ready. Then press “ENTER” button.

```
  M o d e   s e l e c t   2  
! S e t   u p   m o d e   C h a n g e   ?
```

- 4 Then press “ENTER” button. The scanner displays as follows.

```
! 0 1   D o u b l e   F e e d   C h c k  
= N o / Y e s - - >   1 0 / 1 5 / 2 0 m m
```

- 5 Press “Previous” once, then the scanner displays “SCSI ID” on the upper line of the LCD.

```
! 1 0   S C S   I D  
= 0 / 1 / 2 / 3 / 4 / 5 / 6 / 7
```

- 6 Select SCSI ID by pressing “→” or “←” button, and press “ENTER”. (SCSI ID is set.)
- 7 Press “Exit” to return to “Scanner Ready” screen.

OPERATING INSTRUCTION

*This chapter describes how to turn the power on, and also describes button specification and reading mode setting. Refer to *Cleaning and Maintenance* about information on loading document and maintenance.*

Turning the Power On

Reading Mode Setting (M3097DE)

Manual Feed Mode Setting

Turning the Power On

This section describes how to turn the power on.

Press “I” side of the power switch. The power goes on and the green Power lamp at the operator panel lights.

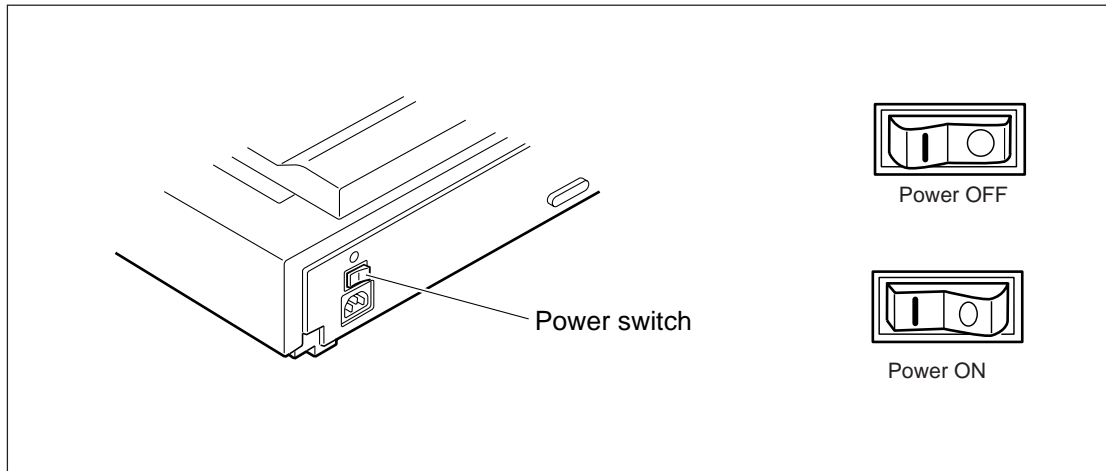

Reading Mode Setting (M3097DE)

This section describes the button specifications and setup details for each of the simplex (front-side), duplex (front-side) and duplex (back-side) reading modes.

When reading mode is set by the command from the host computer, the following button operation is not required.

At any time you press **[Exit]**, scanner returns to screen M1

- 1 Turn the power ON and verify that “Scanner Ready” is displayed on LCD.

<Screen M1>

Scanner Ready

- 2 Press **[Next]** then the scanner displays Screen M2.

<Screen M2>

Mode Select 0

Reading mode change?

- 3 Press **[ENTER]** then the scanner displays Screen 1.

- 4 Select ADF or FB by pressing **[←]** or **[→]** then press **[ENTER]**. The scanner displays Screen 2.

<Screen 1>

01 Reading device
= ADF / FB

- 5 Select “Simplex” or “Duplex” by pressing **[←]** or **[→]**. Then press Enter. The scanner displays Screen 3.

<Screen 2>

02 Reading face
= Simplex / Duplex

- 6 Select “Portrait” or “Landscape” by pressing **[←]** or **[→]**. Then press **[ENTER]**. The scanner displays Screen 4.

<Screen 3>

03 Paper Direction
= Portrait / Landscape

7 Select Size by pressing or . Then press **ENTER**. The scanner displays Screen 5.

<Screen 4>



8 Select Resolution by pressing or . As the cursor moves to left 100/150 may appear. Then press **ENTER**. The scanner displays Screen 6.

<Screen 5>

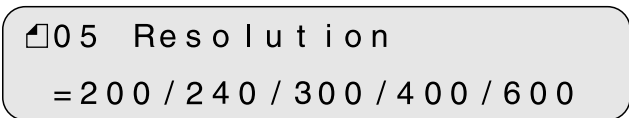

9 Select Front Density by pressing or . As the cursor moves to right, / / may appear. Then press Enter. Scanner displays Screen 7.



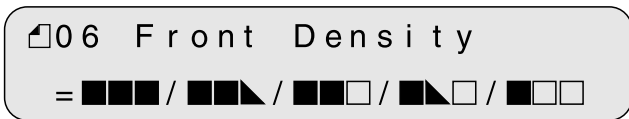





<Screen 6>



Density display



Without IPC option	With IPC-2D or IPC-3D option	Description
		Very dark
		Dark
	AT1	* Dynamic Threshold (DTC mode)
	AT2	* Simplified Dynamic Threshold (IPC mode)
		Normal
		Light
		Very light

* This parameter appears only when IPC-2D or IPC-3D is installed.

10 Select Back Density (when “Duplex” was Selected) by pressing  or . As the cursor moves to right,    /   may appear. Then press . Scanner displays Screen 8.

<Screen 7>



11 Select Front Halftone by pressing  or .

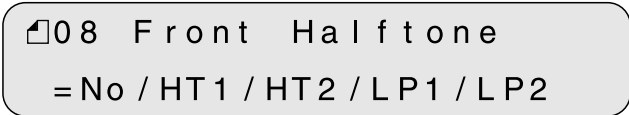

<Screen 8>



Parameter	Description
No	Halftone is OFF. Therefore binary reading is specified.
HT1	Halftone with dither is specified.
HT2	Halftone with error diffusion is specified.
LP1	* Automatic separation with dither is specified.
LP2	* Automatic separation with error diffusion is specified.



* This parameter appears only when the IPC-2D or IPC-3D is installed.

Press  to admit. Scanner displays Screen 9.

12 Select Back Halftone (when “Duplex” was specified) by pressing  or . The parameters are same as 11. Press  to admit. Then scanner displays Screen 10.

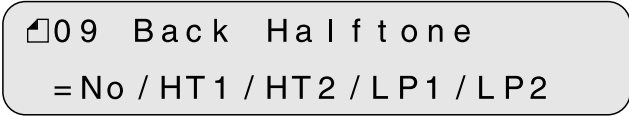
<Screen 9>



13 Select Front Document Type by pressing  or .

<Screen 10>

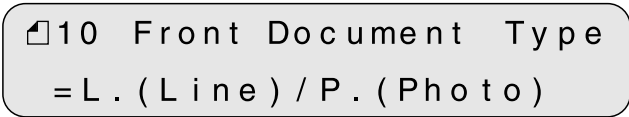

Parameter	Description
L.(Line)	White level following is ON. Top 3mm part of the document must be left blank (grounding color is dropout color). It is useful to read line art or text.
P.(Photo)	White level following is OFF. It is useful to read photograph.

Press **ENTER** to admit. The scanner displays Screen 11.

14 Select Back Document Type (when “Duplex” was specified) by pressing **←** or **→**. The parameters are same as (13). Press **ENTER** to admit. Then scanner displays Screen 12.

<Screen 12>

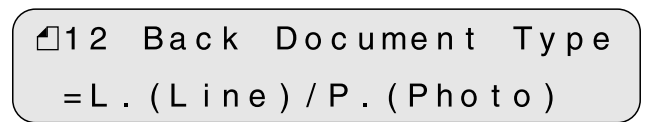

15 Confirm what you have specified. If some parameter needs to change, press **Next** or **Previous** to select screen and re-select the parameter by pressing **←** or **→** and finally press **ENTER**. If all parameter is acceptable, press **Exit** to return to “Scanner Ready” screen.

<Screen 12 (Example)>

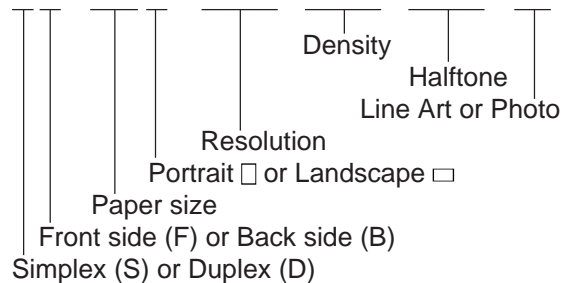

Manual Feed Mode Setting

In this mode, the scanner waits for some predetermined time without issuing “Paper Empty” after all documents are read. This predetermined time (time-out limit) is specified by Setup mode. Therefore you can set next documents on ADF chute without interrupting reading operation. The procedures for setting manual feed mode are as follows.

- 1 Turn the power ON and verify that “Scanner Ready” is displayed on LCD.

<Screen M1>

Scanner Ready

- 2 Press **Next** then the scanner displays Screen M2.

<Screen M2>

Mode Select 0

Reading mode Change?

- 3 Press **Next** then the scanner displays Screen M3.

<Screen M3>

Mode Select 1

M Manual mode Change?

- 4 Press **ENTER** then the scanner displays Screen M4.

<Screen M4>

M01 Manual feed

= No / Yes

- 5 Select “Yes” by pressing **→**. Then press **ENTER**.

- 6 Press **Exit** to return to “Scanner Ready” screen. Note that “Manual Feed” is shown on LCD. This means that the scanner is in Manual Feed mode.

<Screen M1>

Manual feed

Scanner Ready

ADF DOCUMENT SPECIFICATION

This chapter describes the document size and document quality of the ADF.

Document Size

Document Quality

Document Size

The following figure shows document sizes that the scanner can read.

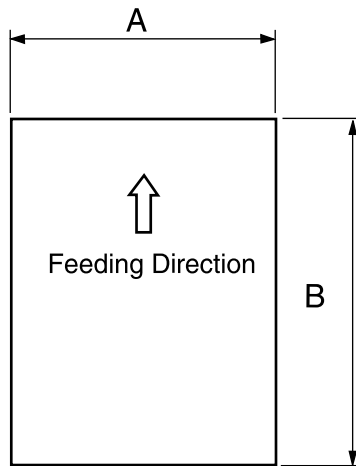

Scanner	Maximum		Minimum	
	A	B	A	B
M3097DE/DG	297 (11.7 in)	432 (17 in)	148 (5.8 in)	105 (4.1 in)
			105 (4.1 in)	148 (5.8 in)

(Unit : mm)

Document Quality

This section describes document types and weights available for the scanner, and precautions.

■ Document type

The recommended paper type for document is as follows:

- Woodfree paper
- Plain paper (for example, the paper specified for XEROX 4024)

When using all other type paper, check that it is successfully fed by ADF before performing a reading operation.

■ Paper weight

The paper weight is as follows :

- 52 to 104 g/m² (3.9 to 27.8 lb)

■ Precautions

The following documents may be hard to read by ADF. Preliminary document feed test may be necessary to avoid the unexpected errors. If the document slips in ADF (JAM error) or double feed occurs frequently, read them by flatbed.

- Paper with clips or staple
- Paper with wet ink
- Paper of which thickness is not constantly equal. (like envelope)
- Paper with large rumples or curl. (See NOTE on the next page.)
- Paper with folds or tears
- Tracing paper
- Coating paper
- Carbon paper
- Paper smaller than 148 mm x 105 mm size, or larger than A3 or Double Letter
- Other than paper ; clothes, metal foil, or OHP film
- Photographic paper
- Paper with notches on its side
- Other than rectangle paper
- Paper that is very thin



CAUTION

Do not feed an important original document to prevent damage to it on the off chance.

When scanning a translucent document, set the density to light mode.

Carbon-less papers have the chemical composition which damages the pad and pick roller. Therefore, note the following remarks

Cleaning: If the miss pick occurs frequently, clean the pad and pick roller in accordance with the "Cleaning and Maintenance".

Replacement of parts: The life of the pad and the pick roller may be shorter than the case that PPC document is fed.



NOTE

- Paper should be straightened to fit the condition below.

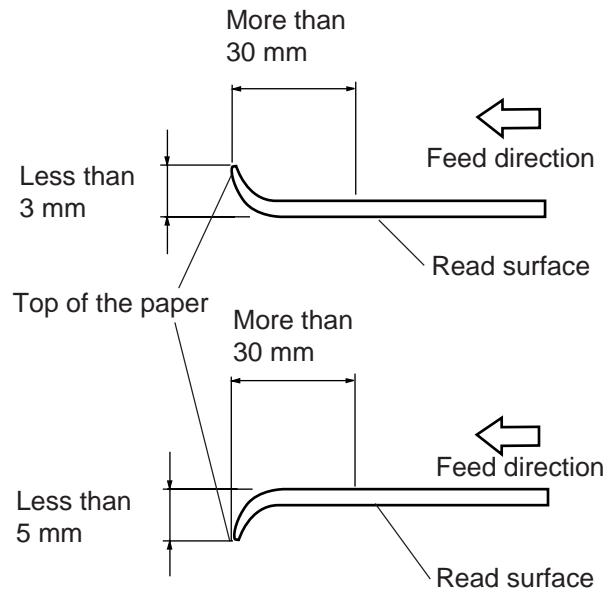

SPECIFICATIONS

This chapter describes the installation specifications, dimensions, consumables, option.

Installation Specifications

Dimensions

Consumables

Option

Installation Specifications

The following table lists the installation specifications of the scanner.

Item		Specification	
Dimensions (mm)		Width	Depth
		696 (27.4 in)	497 (19.6 in)
Height		234 (9.2 in)	
Weight (kg)		20 (44.2 lb.)	
Input power	Voltage	100 to 120 VAC, 220 to 240 VAC \pm 10 %	
	Phases	Single-phase	
	Frequency	50/60 + 2% -4% Hz	
Power consumption		120 VA or less	
Ambient condition	Device status	Operating	Not operating
	Temperature	5 to 35°C (41 to 95°F)	-20 to 60°C (-4 to 140°F)
	Humidity	20 to 80 %	8 to 95 %
Heat capacity		78 kcal/H (312 BTU/H)	

Dimensions

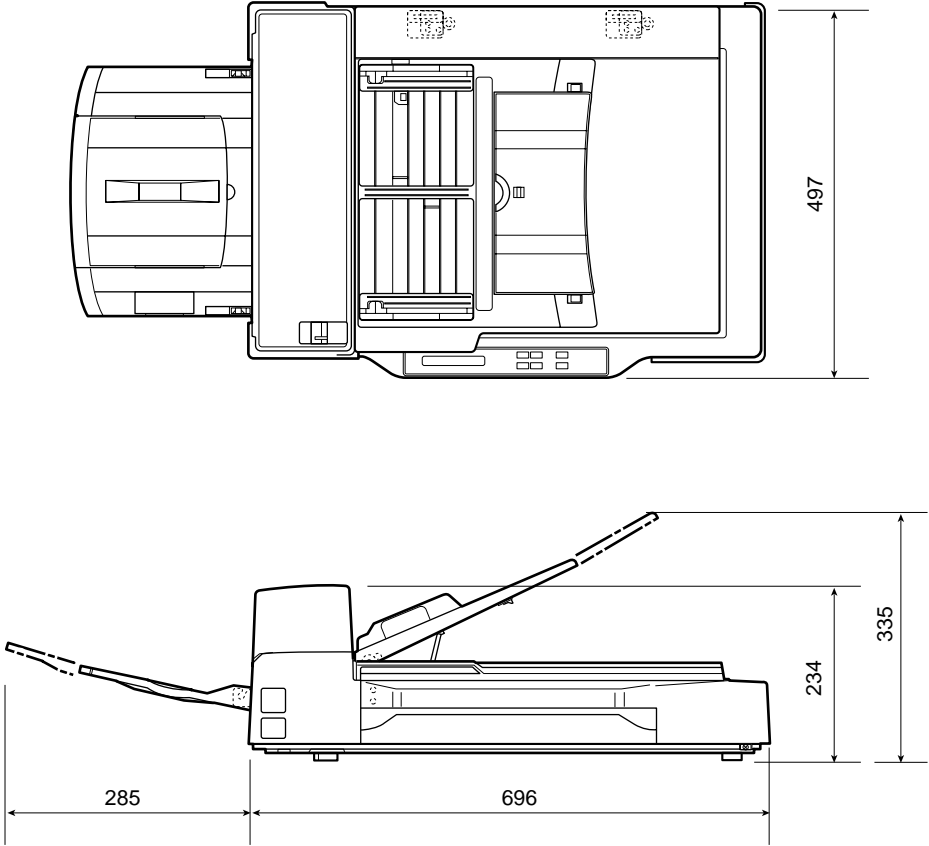

(unit: mm)

Consumables

The following table lists consumables used for the scanner. Be sure to keep some consumables in stock. Customer is responsible to change these items periodically. The abrasion counter can be used to check the number of scanned documents.

Name	Specification	Remark
Pad ASY	PA03951-0021	Up to 100,000 sheets or one year.
Pick roller	PA03951-0025	Up to 200,000 sheets or one year. (Two roller are included.)

Option

The following table lists options of the scanner.

Name	Specification	Remark
Extended Memory	TBD	16MB, EDO SIMM, 72pin, 60ns without parity One per unit
IPC-2D*	CA01952-0192	Image Processing Circuit One per unit
IPC-3D*	CA02919-0511	Image Processing Circuit One per unit

* One of these option can be installed at a time
Contact your Fujitsu sales agent for more information.

SETUP MODE

This chapter describes the setup mode of the scanner.

Activating the Setup Mode

Contents of the Setup Mode

Activating the Setup Mode

This section describes how to activate the setup mode.

- 1 Turn the power ON. Then the scanner displays “Scanner Ready” on LCD.

<Screen M1>

Scanner Ready

- 2 If the scanner is M3097DG, go to the procedure 3. Press **[Next]** then the scanner (M3097DE) displays Screen M2.

<Screen M2>

Mode Select 0
 Reading mode Change?

- 3 Press **[Next]** then the scanner displays Screen M3.

<Screen M3>

Mode Select 1
M Manual mode Change?

- 4 Press **[Next]** then the scanner displays Screen M4.

<Screen M4>

Mode Select 2
! Setup mode Change?

- 5 Press **[ENTER]**. Now the scanner is at Screen 41 (page 6-3) in Setup mode.

NOTE

Any time you press **[Exit]**, you can return to “Scanner Ready” screen.

Contents of the Setup Mode

This section describes the contents of the setup mode.

No	Item	Description	Selectable parameters	Default
1	Double feed check	Double feed is detected by checking the document length one by one.**	Tolerance: No/10/15/20mm	No
2	IPC pre-setting	Scanner automatically sets the recommended reading parameters. 5 sets of recommended parameters are available.	Document: No/1/2/3/4/5	No
3	Rest of abrasion counter	Abrasion counter can be reset.	-	-
4	Pick start time setting	The time from the document Insertion to the start of picking is specified. User can select most comfortable Pick start time for the job.	Time: 0.2 to 29.8 sec	1.0 sec
5	Time-out limit setting	The time that the scanner waits for next document insertion after last document scanned can be specified.	Time: 27 values from 1 to 1999 sec	30 sec
6	ADF front offset setting*	Horizontal and vertical offset of the front side image by ADF is specified.	Offset: H:-2 to +3mm V:-2 to +3mm	Offset: H: 0 mm V: 0 mm
7	ADF back offset setting*	Horizontal and vertical offset of the back side image by ADF is specified.	Offset: H:-2 to +3mm V:-2 to +3mm	Offset: H: 0 mm V: 0 mm
8	FB offset setting*	Horizontal and vertical offset of the FB image is specified.	Offset: H:-2 to +3mm V:-2 to +3mm	Offset: H: 0 mm V: 0 mm
9	IPC/Memory status display	The type of IPC option (IPC-2D or IPC-3D) and total memory installed are displayed.		
10	SCSI ID setting	SCSI ID is selectable.	SCSI ID: 0/1/2/3/4/5/6/7	5

* This offset means the deference from the value adjusted by automatic offset adjustment.

** The document length on ADF paper chute must be same. If the completely overlapped sheets are fed, the scanner cannot detects the double feed.

■ Setting double feed detection

When you set the using of double feed detection, you must set as follows:

- 1 Press **Next** or **Previous** and let the scanner display Screen 41.

<Screen 41>

! 0 1 Double Feed Check
= No / Yes → 1 0 / 1 5 / 2 0mm

- 2 At Screen 41, press **→** or **←** to select the tolerance (10 or 15 or 20mm) and press **ENTER** to activate the double feed detector. Scanner compares the length of the scanned document with the length of the first document. When the length of the scanned document is longer or shorter than the length of the first document exceeding the tolerance, double feed is detected. If you want to disable the double feed, select "No" then press **ENTER**. Press **Exit** to return to "Scanner Ready" screen.

NOTE

Double Feed detection is effective only when the length of the all document on ADF is same.

NOTE

Scanner stops document feeding at the double feed detection. When the document in ADF is not the double fed document, previous document may be double fed.

NOTE

If the completely overlapped sheets are fed, the scanner can not detect the double feed.

■ Setting IPC pre-set mode

When you set the using of IPC-2 pre-set mode, you must set as follows:

- 1 Press **[Next]** or **[Previous]** and let the scanner display Screen 42.
- 2 At Screen 42, press **[→]** or **[←]** to select the document number and press **[ENTER]** to activate the IPC pre-setting. Then the scanner displays Screen 42-1. Go to procedure 3. If you want to disable the IPC pre-setting, select "No" then press **[ENTER]**. Finally press **[Exit]** to return to "Scanner Ready" screen.
- 3 At Screen 42-1, select "Yes" to activate the IPC pre-setting or select "No" to disable the IPC pre-setting. Note that when you activate the IPC pre-setting, the IPC setting by Host computer is ignored. Finally press **[ENTER]**, then the scanner displays next item, Screen 43.

<Screen 42>

```
! 02 IPC Pre-Set
= No / Yes → 1 / 2 / 3 / 4 / 5
```

<Screen 42-1>

```
! 02-1 IPC Host Setting
Ignore Yes / No
```

<Classification of document number>

Document number are classified in line-art scanning as follows:

The horizontal axis shows the background density/color of paper.

The vertical axis shows the density of character/ line.

		Background density		Background color		
		Normal←	→Dark	Red	Green	Blue
Character density	Normal ↑	①: Normal background and character.	③: Dark background and normal-density character.			
	↓ Light	②: Normal background and light character.		④: Light character on red paper.	⑤: Light character on green paper.	

① - ⑤ are the document number set in setup mode.

 **NOTE**

- When IPC pre-set is executed in setup mode
Scanner checks that IPC-2D or IPC-3D are installed when the scanner enters in IPC pre-set.
If IPC-2D or IPC-3D is not installed, the scanner does not enter in IPC pre-set.
- When IPC pre-set mode is executed
When IPC pre-set mode is executed in online mode, the reading parameter is valid or invalid (Host setting is invalid) as follows:

	Reading parameter							
	Reading mode	Transfer mode	Transfer rate	Resolution	Start of reading	Density	Line-art / Photo	Halftone
Valid	<input type="radio"/>	<input type="radio"/>	<input type="radio"/>	<input type="radio"/>	<input type="radio"/>			
Invalid						<input type="radio"/>	<input type="radio"/>	<input type="radio"/>

	Reading parameter							
	DTC	Size	Portrait/ Landscape	Picking	Document selection	r patterns	Contrast	Automatic separation
Valid		<input type="radio"/>	<input type="radio"/>	<input type="radio"/>	<input type="radio"/>			
Invalid	<input type="radio"/>					<input type="radio"/>	<input type="radio"/>	<input type="radio"/>

	Reading parameter					
	Conversion	Sharpness	Outline extraction	Overlay	Simplified DTC	Zooming
Valid	<input type="radio"/>					<input type="radio"/>
Invalid		<input type="radio"/>	<input type="radio"/>	<input type="radio"/>	<input type="radio"/>	

■ Reset of abrasion counter

When you reset the abrasion counter, you must set as follows:

- 1 Press **Next** or **Previous** and let the scanner display Screen 43.
- 2 At Screen 43;
If you want to reset the abrasion counter, select “Yes” by **←** or **→** button and press **ENTER**. Go to procedure 3.
If you do not want to reset the abrasion counter, select “No” and press **ENTER**.
Finally press **Exit** to return to “Scanner Ready” screen.
- 3 At Screen 43-1;
If you want to reset the abrasion counter, select “Yes” and press **ENTER**. If you do not want to reset, select “No” and press **ENTER**.

<Screen 43>

```
! 0 3  A b r a s i o n  C o u n t e r  
= X X X X X X  R e s e t  N o / Y e s
```

<Screen 43-1>

```
! 0 3 - 1  A r e  y o u  s u r e ?  
N o / Y e s
```

■ Setting pick start time

When you set the pick start time, you must set as follows:

- 1 Press **Next** or **Previous** and let the scanner display Screen 44.
- 2 At Screen 44, press **→** to increase the Pick start time or press **←** to decrease the Pick start time. Then press **ENTER** to activate the setting. Finally press **Exit** to return to “Scanner Ready” screen.

<Screen 44>

```
! 0 4  P i c k  s t a r t  t i m e  
= 1 . 0  S e c
```

■ Setting time-out limit

- 1 Press **Next** or **Previous** and let the scanner display Screen 45.
- 2 At Screen 45, press **→** to increase the number or press **←** to decrease the time-out limit. Then press **ENTER** to activate the setting. Finally press **Exit** to return to “Scanner Ready” screen.

<Screen 45>

```
! 05 Time-out limit
= 30 Sec
```

■ Setting Offset

- 1 Press **Next** or **Previous** and let the scanner display as follows:
 - Front Offset by ADF : Screen 46.
 - Back Offset by ADF : Screen 47.
 - Offset of Flatbed : Screen 48.

<Screen 46>

```
! 06 ADF Front Offset
Change? No / Yes
```

<Screen 47>

```
! 07 ADF Back Offset
Change? No / Yes
```

<Screen 48>

```
! 08 FB Offset
Change? No / Yes
```

- 2 Select “Yes” by pressing **←** or **→** button, and press **ENTER**. Then scanner displays Screen A.

<Screen A>

```
! 0X-1 Return to default?
No / Yes
```

- 3 At Screen A, if you want to let the offset return to default, select “Yes” otherwise “No” then press **ENTER**. The scanner displays Screen B.

<Screen B (Example of ADF Front Offset)>

! 06-2 Front Offset H
H= + 0.0 mm (+ : Left)

<Screen B (Example of ADF Back Offset)>

! 07-2 Back Offset H
H= + 0.0 mm (+ : Left)

<Screen B (Example of FB Offset)>

! 08-2 FB Offset H
H= + 0.0 mm (+ : Left)

- 4 At Screen B, press **→** to increase the offset or press **←** to decrease offset. The increment or decrement is 0.5 mm. Then press **ENTER** to activate the setting. The scanner displays Screen C.

<Screen C (Example of ADF Front Offset)>

! 06-3 Front Offset V
V= + 0.0 mm (+ : Up)

<Screen C (Example of ADF Back Offset)>

! 07-3 Back Offset V
V= + 0.0 mm (+ : Up)

<Screen C (Example of FB Offset)>

! 08-3 FB Offset V
V= + 0.0 mm (+ : Up)

- 5 At Screen C, press **→** to increase the offset or press **←** to decrease offset. Then press **ENTER** to activate the setting. The scanner displays the next item of the setup mode.

■ Reviewing the IPC/Memory Status

- 1 Press **Next** or **Previous** and let the scanner display Screen 49.

<Screen 49 (Example of 32MB)>

```
! 0 9   I P C / M e m o r y   S t a t u s  
      I P C - 2 D / 3 2 M B ( T O T A L )
```

(An example)

- 2 Screen 49 displays the IPC option installed and total image memory installed. Press **Exit** to return to “Scanner Ready” screen.

■ Setting SCSI-ID (M3097DG)

- 1 Press **Next** or **Previous** and let the scanner display Screen 4A.
- 2 At Screen 4A, press **←** or **→** to select SCSI-ID. Then press **ENTER** to activate the setting. Finally press **Exit** to return to “Scanner Ready” screen.

<Screen 50>

```
! 1 0   S C S I - I D  
      = 0 / 1 / 2 / 3 / 4 / 5 / 6 / 7
```

GLOSSARY OF TERMS

A4 size

A standard paper size used in Japan and other countries. Paper size is 210 x 297 mm (8.25 x 11.6 inches).

Abrasion counter

Indicates when belts/rollers should be replaced. The number of read document accumulates until an operator resets the counter. It should be reset when consumables are replaced.

ASCII

The acronym for American Standard Code for Information Interchange.

ASCII is a set of 256 codes (numbered 0 to 255) used to communicate information between a computer and another device such as scanner.

Automatic separation

The image processing method to detect the difference between text and photos and choose the threshold accordingly. Automatic separation allows the scanner to switch between line mode and half tone mode in one pass.

Automatic start mode (<-> manual start mode)

In this mode the reading operation is activated only by START command.

Back-side reading = Back-side scanning

Refers to reading the back-side of the document, specifically in Duplex reading mode.

Bit

The smallest unit of information in computer memory. A bit is a single digit, either a 1 or a 0, in the binary numbering system.

Eight bits equal one byte.

Density

Refers to a measurement of the depth of the display in this manual.

Dither

Technique for producing halftone images representing the entire grayscale using two pixel levels black and white.

Double feed detection

A function which detects the status when multiple sheets are fed in the ADF unit.

dpi

Dots per inch.

Drop-out color

A color which is used to the document but does not appear in the read image.

Duplex reading mode

Both sides of the document are read in this mode.

Equipment Error

An error that is not recoverable by operator. Call CE.

Error diffusion

High-quality halftone (pseudo-grayscale) image production based on black-and-white pixel binarization. A pixel's optical density and that of adjacent pixels are summed, with black pixels relocated in their order of density as they relate to adjacent pixels.

The purpose of this technique is to minimize the average error between read and printed densities. Density data for adjacent pixels is modified by diffusing errors on the objective pixel into several pixels, which are then binarized. This maintains high grayscale levels and resolution during reading, while suppressing more patterns by dotted halftone images such as newspaper photo graphs.

Filtering

The quality of images written in pencil or ball-pointed pen and read depends on the reflective light characteristics of the ink or lead.

Dropped pixel's may produce out lines, gaps or thin, barely connected lines due to even optical density. Filtering detects areas lighter than their surroundings and increases their density to improve image clarity.

Front-side reading = Front-side scanning

Refers to reading the front-side of the document, specifically in Duplex reading mode.

Halftone processing

Used to reproduce a photograph which includes a shade as an image composed of dots, namely a binary image. Dithering and error diffusion processing are examples of the halftone processing.

Hexadecimal

A base-16 numbering system(also commonly referred to as hex numbers). Since a base-16 system requires 16 digits, numbers 0 through 9 and letters A through F are used. It is convenient to express binary numbers in hexadecimal because fewer digits are required.

Image emphasis

Density is decreased for lighter but not completely white areas adjacent to black areas. Weakening this emphasis eliminates spot noise or produces softened images.

Image processing

An image is read with specified parameters.

Interface

The connection that allows communication from one part of a system to another. For example, electrical signals are transferred between the computer and scanner over an interface cable.

Inversion (Reverse-image reading)

In reverse-image reading, data is changed from black to white and vice versa.

IPC pre-set mode

While reading binary images, it is necessary to set the scanner according to the quality of the sheet to be read. In this mode these settings can be performed in advance by corresponding each setting to a pattern number.

IPC-2D or IPC-3D

Image processing option of this scanner.

IRAS

Initialization of the hardware.

Landscape

A document is transported and read with the long side vertical to the moving direction.

Letter size

A standard paper size used in the U.S.A. and other countries. Paper size is 8-1/2 x 11 inches (215.9 x 279.4 mm).

Linedrawing mode

Selecting linedrawing mode makes threshold and contrast settings effective but prevents brightness from being set. The specified threshold value determines whether black or white pixels are scanned. Linedrawing mode is therefore appropriate for scanning text and line art images.

Manual Feed mode = Manual Mode

Requires the operator to feed each document manually to the ADF paper chute.

Manual start mode (<-> automatic start mode)

The reading operation is activated by pressing the START button in this mode.

Mirror image

The read image is symmetrically flipped to produce a mirror image of the original detected in the main scanning direction.

Noise removal

Isolated noise from an image appearing as black spots in white areas and voids in black areas is removed to improve image quality.

Operator panel

A panel containing the scanner indicators and buttons. The operator panel is used to control scanner operations such as loading document, selecting features, and changing setup options.

Outline extraction

The boundary between black and white areas is traced and the outline extracted for closed areas.

PAPER JAM

A warning informing the user that document is jammed in the transport unit, or that transportation is disabled because the transport unit is slippery. This warning also appears when a double fed is detected.

Photograph mode (White level follower OFF)

Selecting photograph mode makes brightness and contrast settings effective but prevents the threshold from being set. With photograph mode, the darkness of image corresponds to the black-pixel density, making it suitable in scanning images such as photographs having gradations.

Photo mode = photograph mode

A photograph is read properly in this mode.

Pick start time

The period from the manual insertion of the document until picking starts after the document passes the hopper empty sensor.

Portrait

A document is transported and read with the long side parallel to the moving direction.

Paper counter

Indicates the total number of read document from reading start until the hopper becomes empty.

Read operation

Refers to the reading operation including Simplex reading and Duplex reading.

RS-232C interface

A type of serial interface. See Serial interface.

SCSI-ID

Used to specify a particular SCSI device when the initiator selects a target or the target re-connects to the initiator.

Serial interface

A standard computer interface. Information is transferred between devices over a single wire (although other wires are used for control).

With a serial interface, an interface cable greater than 3 meters (10 feet) can be used. This is often necessary in networking environments, where the scanner may be shared.

SETUP mode

In this mode, users can view or set a variety of function in Off-line.

Simplex reading mode

Only the front side of the document is read in this mode. Place the documents face-up at the center of the hopper table.

Smoothing

Smoothing eliminates jaggies from slanted lines and curves. Irregular convexities are deleted and irregular concavities filled in. This is useful in OCR applications, for example.

Temporary Error

An error that is recoverable by operator.

Terminator

Devices with SCSI interface are daisy-chained. A resistor that includes terminal circuits needs to be placed at both ends of a cable when devices are daisy-chained.

Time-out limit

This is the time which the scanner waits for next document insertion after the last document feeding. The scanner returns Paper Empty when no document is set after time-out limit.

INDEX

A

- A3 3-3
- A4 3-3
- Abrasion counter 1-7
- Activating the Setup Mode 7-1
- ADF 1-2, 1-3
- ADF
 - Lever 1-2, 1-3
 - mode 1-6
 - paper chute 1-2
- Alarm 1-10
- Ambient condition 5-1
- Arrangement 1-5
- Assemblies 1-4

B

- Belt 5-3
- Button
 - /LED Function 1-6

C

- Cable Connection 2-5
- Carrier fixing bracket 2-4
- Checking the Components 1-1
- Connecting
 - the interface cable 2-6
 - the power cable 2-5
- Consumables 5-3
- Contents of the Setup Mode 6-2
- Conventions iii

D

- Density 3-3, 3-4
- Dimensions 5-1, 5-2
- DLT (Double letter) 3-3
- Document
 - bed 1-2, 1-3
 - holding pad 1-2, 1-3
 - Quality 4-2
 - Size 4-1
 - type 3-5, 4-2

Double

- feed check 6-2
- feed detection 6-3
- feed error 1-9

Duplex

- reading mode 3-2
- (back-side) reading mode 3-2
- (front-side) reading mode 3-2

E

- ENTER button 1-6
- Exit button 1-6

F

- Feeding direction 4-1

H

- Halftone processing 3-4
- Heat capacity 5-1
- Hopper empty 1-9

I

- Image processing circuit 5-4
- IMPORTANT NOTE TO USERS i
- input power 5-1
- Inspection 2-2
- Installation Specifications 5-1
- Interface connectors 1-2, 1-3
- IPC
 - pre-setting 6-2, 6-4
 - status 6-2, 6-9

L

Label

A 2-2

B 3-3

Landscape 3-2

LCD 1-5

LCD Display 1-6

LED 1-6

LG (Legal) 3-3

LT (Letter) 3-3

M

Manual

feed mode 3-6

start mode 1-6

Memory

cover 1-2, 1-3

status 6-2, 6-9

N

Next button 1-6

O

Offset setting 6-2, 6-7

Operation Status 1-8

Operator's Guide 1-1

Operator panel 1-2, 1-5

Option 5-4

P

Pad ASY 5-3

Paper

counter 1-7

direction 3-2

weight 4-2

Perface ii

Pick

roller 1-4, 5-3

start time 6-2, 6-6

Plain paper 4-2

Portrait 3-2

Power

cable 1-1, 2-5

consumption 5-1

inlet 1-2, 1-3

switch 2-5, 3-1

Precautions 2-1, 4-2

Previous button 1-6

R

Reading

mode 3-2

face 3-2

Reset of abrasion counter 6-6

Resolution 3-3

Reviewing the IPC/Memory Status 6-9

S

Scanner 1-1

Setting

double feed detection 6-3

IPC pre-set mode 6-4

Offset 6-7

picking start time 6-6

SCSI-ID 6-9

time-out limit 6-7

Setup mode 6-1, 6-2

Simplex 3-2

Size 3-3

Specifications 5-1

Stacker 1-2, 2-7

Start button 1-5, 1-6

Stop button 1-5, 1-6

T

Terminator 1-1

Temporary error 1-9

Third party slot 1-2, 1-3

Turning

U the Power On 3-1
the power switch off 2-5

W Units 1-2
Units and Assemblies 1-2

Weight 5-1

 button 1-6

 button 1-6

(START) button 1-6

(STOP) button 1-6

FUJITSU