

C150-E045-05EN

# ***M3099EX/GX/EH/GH Image Scanner***

## Operator's Guide

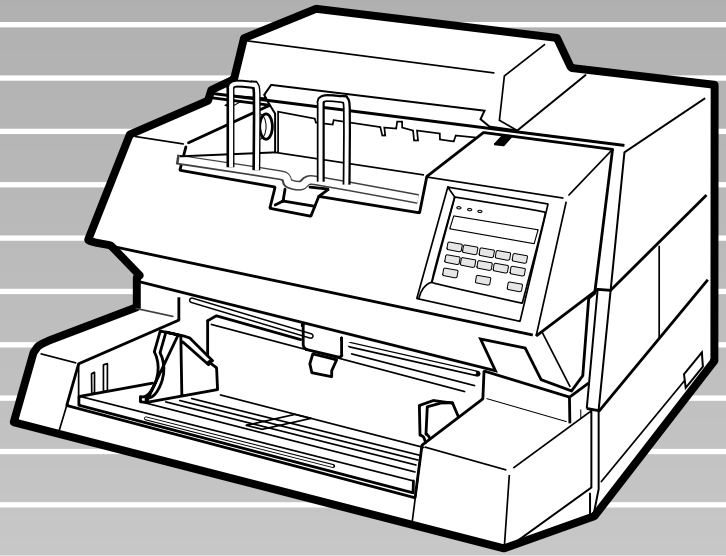

**FUJITSU**

**M3099EX/GX/EH/GH**  
**Image Scanner**  
Operator's Guide

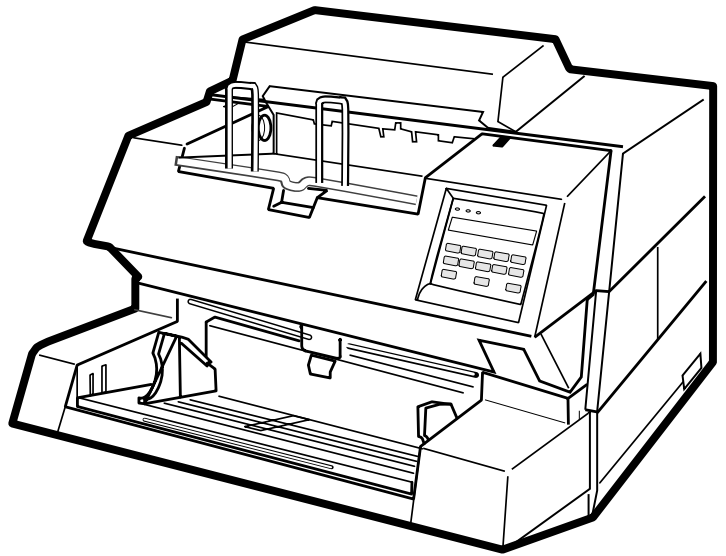

# ***IMPORTANT NOTE TO USERS***

---

READ CAREFULLY ALL OF THIS MANUAL BEFORE USING THIS PRODUCT. IF NOT USED CORRECTLY, UNEXPECTED DAMAGES MAY BE CAUSED TO THE USERS OR THE BYSTANDERS.

While all efforts have been made to ensure the accuracy of all information in this manual, FUJITSU assumes no liability to any party for any damage caused by errors or omissions or by statements of any kind in this manual, its updates or supplements, whether such errors are omissions or statements resulting from negligence, accidents, or any other cause. FUJITSU further assumes no liability arising from the application or use of any product or system described herein; nor any liability for incidental or consequential damages arising from the use of this manual. FUJITSU disclaims all warranties regarding the information contained herein, whether expressed, implied, or statutory.

FUJITSU reserves the right to make changes to any products herein, to improve reliability, function, or design, without further notice and without obligation.

# Preface

---

This manual explains how to use the M3099EX/GX/EH/GH image scanner.

This manual contains COMPONENTS, INSTALLATION AND CONNECTION, OPERATING INSTRUCTION, DOCUMENT SPECIFICATION, SPECIFICATIONS, ENDORSER and SETUP MODE.

Refer to Reference Guide for the information about the routine operation of the M3099EX/GX/EH/GH.

Reference Guide contains OPERATING INSTRUCTION, CLEANING, REPLACEMENT OF PARTS, ADJUSTMENT and TROUBLESHOOTING.

The M3099EX/GX/EH/GH is very fast and highly functional image scanner developed for volume filing, using charge-coupled device (CCD) image sensors. This scanner features duplex scanning and high quality image, processing with an automatic document feeder (ADF).

# Conventions

---

Special information, such as warnings, cautions are indicated as follows:

## **WARNING**

WARNING indicates that personal injury may result if you do not follow a procedure correctly.

## **CAUTION**

CAUTION indicates that damage to the scanner may result if you do not follow a procedure correctly.

The following symbols are used in this manual.



Used for general WARNING and CAUTION.



Be careful not to pinch your fingers or hands.



# CONTENTS

❑	<b>CHAPTER 1 COMPONENTS</b>	
	Checking the Components .....	1-1
	Units and Assemblies .....	1-2
	Operator Panel(M3099EX/EH) .....	1-4
	Operator Panel(M3099GX/GH) .....	1-10
	Buzzer Functions .....	1-14
❑	<b>CHAPTER 2 INSTALLATION AND CONNECTIONS</b>	
	Precautions .....	2-1
	Inspection .....	2-2
	Cable Connection .....	2-4
❑	<b>CHAPTER 3 OPERATING INSTRUCTION</b>	
	Turning the Power On .....	3-1
	Button Specification and Reading Mode Setting(M3099EX/EH) .....	3-2
	Button Specification(M3099GX/GH) .....	3-17
❑	<b>CHAPTER 4 DOCUMENT SPECIFICATION</b>	
	Document Size .....	4-1
	Document Quality .....	4-2
❑	<b>CHAPTER 5 SPECIFICATIONS</b>	
	Installation Specifications .....	5-1
	Dimensions .....	5-2
	Consumables .....	5-3
	Option .....	5-4
❑	<b>CHAPTER 6 ENDORSER</b>	
	Specifications .....	6-1
	Panel Operation .....	6-2
❑	<b>CHAPTER 7 SETUP MODE</b>	
	Activating the Setup Mode .....	7-1
	Contents of the Setup Mode .....	7-2
❑	<b>GLOSSARY OF TEAMS</b> .....	GL-1
❑	<b>INDEX</b> .....	IN-1





**CHAPTER 1 COMPONENTS**

COMPONENTS

**CHAPTER 2 INSTALLATION AND CONNECTIONS**

INSTALLATION AND CONNECTIONS

**CHAPTER 3 OPERATING INSTRUCTION**

OPERATING INSTRUCTION

**CHAPTER 4 DOCUMENT SPECIFICATION**

DOCUMENT SPECIFICATION

**CHAPTER 5 SPECIFICATIONS**

SPECIFICATIONS

**CHAPTER 6 ENDORSER**

ENDORSER

**CHAPTER 7 SETUP MODE**

SETUP MODE

**GLOSSARY OF TEAMS**

GLOSSARY OF TEAMS

**INDEX**

INDEX

Edition	Date published	Revised contents
01	December, 1995	First edition
02	April, 1996	M3099EX/GX added
03	May, 1996	Manual modified
04	March, 1999	Consumables and Setup Mode revised
05	June, 1999	Consumables and Setup Mode revised
Specification No. C150-E045-05EN		

This equipment has been tested and found to comply with the limits for a Class A digital device, pursuant to Part 15 of the FCC Rules. These limits are designed to provide reasonable protection against harmful interference when the equipment is operated in a commercial environment. This equipment generates, uses, and can radiate radio frequency energy and, if not installed and used in accordance with the instruction manual, may cause harmful interference to radio communications. Operation of this equipment in a residential area is likely to cause harmful interference in which case the user will be required to correct the interference at his own expense.

This digital apparatus does not exceed the Class A limit for radio noise emissions from digital apparatus set out in the Radio interference Regulations of the Canadian Department of Communications.

Le présent appareil numérique n'émet pas de bruits radioélectriques dépassant les limites applicables aux appareils numériques de la classe A prescrites dans le Règlement sur le brouillage radioélectrique dicté par le ministère des Communications du Canada.

Maschinenlärm-Informationsverordnung 3. GSGV, 18-01. 1991: Der arbeitsplatz-bezogene Schalldruckpegel beträgt 70 dB (A) oder weniger gemäß ISO7779.

The contents of this manual may be revised without prior notice.P

---

Please send your comments on this manual or on Fujitsu products to the following addresses:

FUJITSU COMPUTER PRODUCTS OF AMERICA, INC.  
2904 Orchard Parkway, San Jose.  
California 95134-2022, U.S.A.  
TEL: 1-408-432-6333  
FAX: 1-408-432-3908

FUJITSU AUSTRALIA LIMITED  
475 Victoria Avenue Chatswood.  
N.S.W.2067, AUSTRALIA  
TEL: 61-2-410-4555  
FAX: 61-2-411-8603

FUJITSU CANADA, INC.  
2800 Matheson Blvd. East, Mississauga.  
Ontario 4X5, CANADA  
TEL: 1-905-602-5454  
FAX: 1-905-602-5457

FUJITSU DEUTSCHLAND GmbH.  
Frankfurter Ring 211,  
8000 München 40, F.R., GERMANY  
TEL: 49-89-32378-0  
FAX: 49-89-32378-100

FUJITSU ESPAÑA, S.A.  
Edificio torre Europa  
Paseo de la Castellana 95 Madrid 28046, SPAIN  
TEL: 34-1-581-8400  
FAX: 34-1-581-8125

FUJITSU EUROPE LTD.  
2, Longwalk Road, Stockey Park, Uxbridge  
Middlesex, UB11 1AB, U.K.  
TEL: 44-81-573-4444  
FAX: 44-81-573-2643

FUJITSU FRANCE S.A.  
Bâtiment Aristote, 17 rue Olof palme  
94006 Créteil cedex, FRANCE  
TEL: 33-14-513-1616  
FAX: 33-14-399-0700

FUJITSU HONG KONG Limited  
Room 2521, Sum Hung Kai Centre  
30 Harbour Road Wanchai, Hong Kong  
TEL: 852-827-5780  
FAX: 852-827-4724  
TLX: 62667

FUJITSU ITALIA S.p.A.  
Via Melchiorre Gioia, No.8-20124  
Milano, ITALY  
TEL: 39-2-6351  
FAX: 39-2-6572257

FUJITSU NORDIC AB  
Kung Hans vag, S-19176  
Sollentuna, SWEDEN  
TEL: 46-8-626-6000  
FAX: 46-8-626-6711

FUJITSU LIMITED  
International Operations  
Marunouchi 1-6-1, Chiyoda-ku, Tokyo 100  
JAPAN  
TEL: (81-3)3216-3211  
FAX: (81-3)3213-7174  
TLX: J2283  
Cable: "FUJITSU LIMITED TOKYO"

# ***COMPONENTS***

---

*After unpacking the scanner, confirm that all the components have been received. This chapter describes the components of the scanner, part names, and operator panel arrangement and their function.*

## **Checking the Components**

### **Units and Assemblies**

#### **Operator Panel (M3099EX/EH)**

#### **Operator Panel (M3099GX/GH)**

### **Buzzer Functions**

# Checking the Components

These high precision components must be handled with care. Confirm that all the components shown in the following figure have been received. If any component is missing, please contact your sales agent.

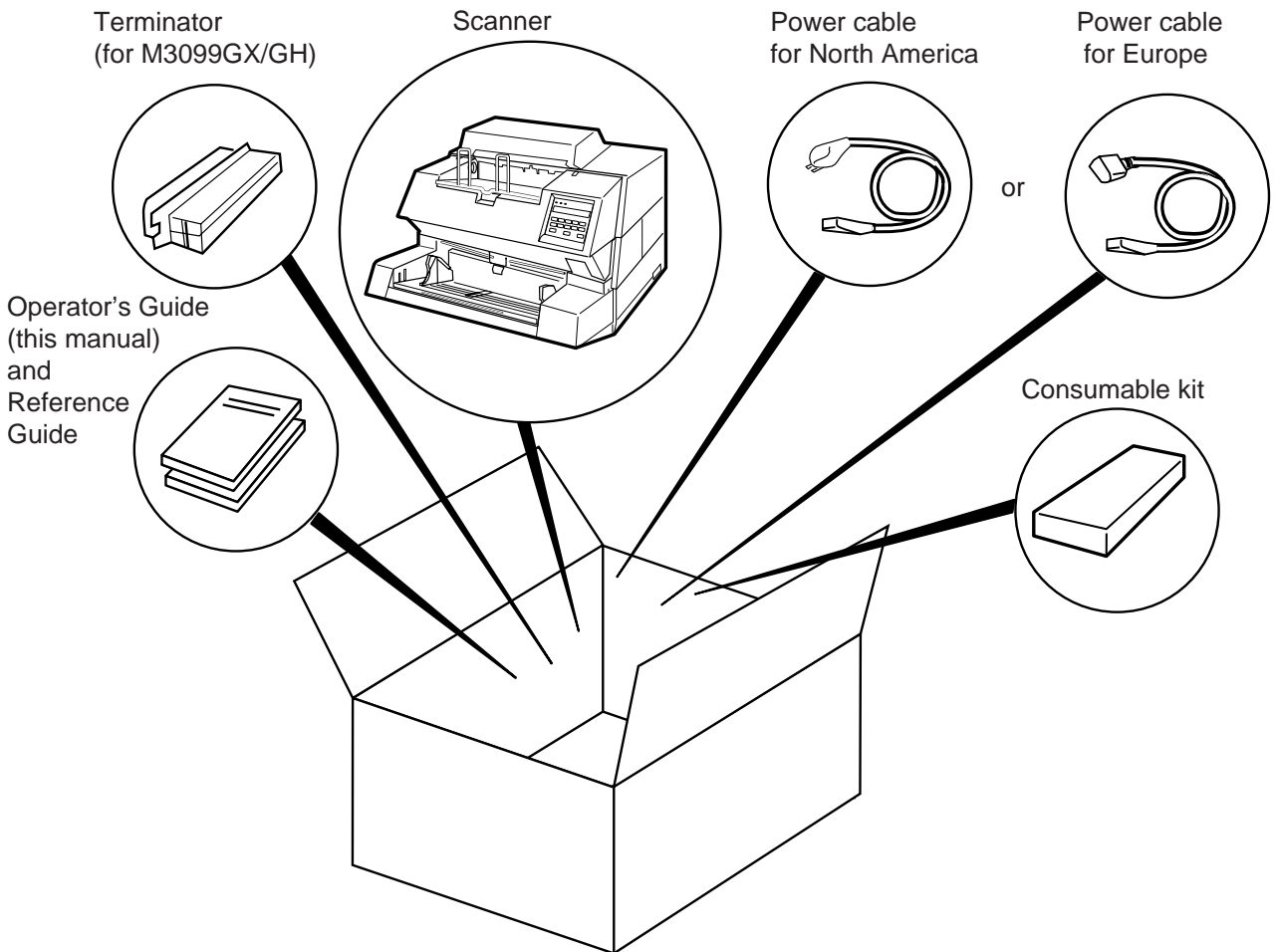

# Units and Assemblies

This section shows the exterior view and assemblies of the scanner. This section also provides names of each part and describes their functions.

## ■ Units

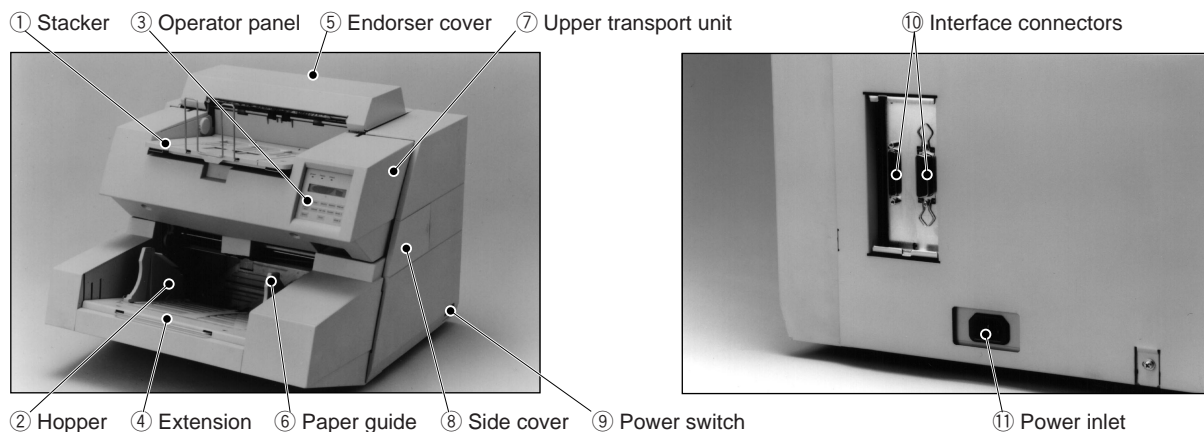

No.	Function
①	Stacker.
②	Hopper.
③	Used to operate the scanner.
④	Used to prevent documents from hanging down.
⑤	Open here when adjusting the print head position or when replacing the print head.
⑥	Used to adjust the document size.
⑦	Scans while feeding documents.
⑧	Open here when replacing the back-side lamp.
⑨	Turns on or off the power.
⑩	Video and RS-232C (M3099EX/EH) or SCSI (M3099GX/GH) interface connectors.
⑪	Connect the power cable from an AC power outlet here.

## ■ Assemblies

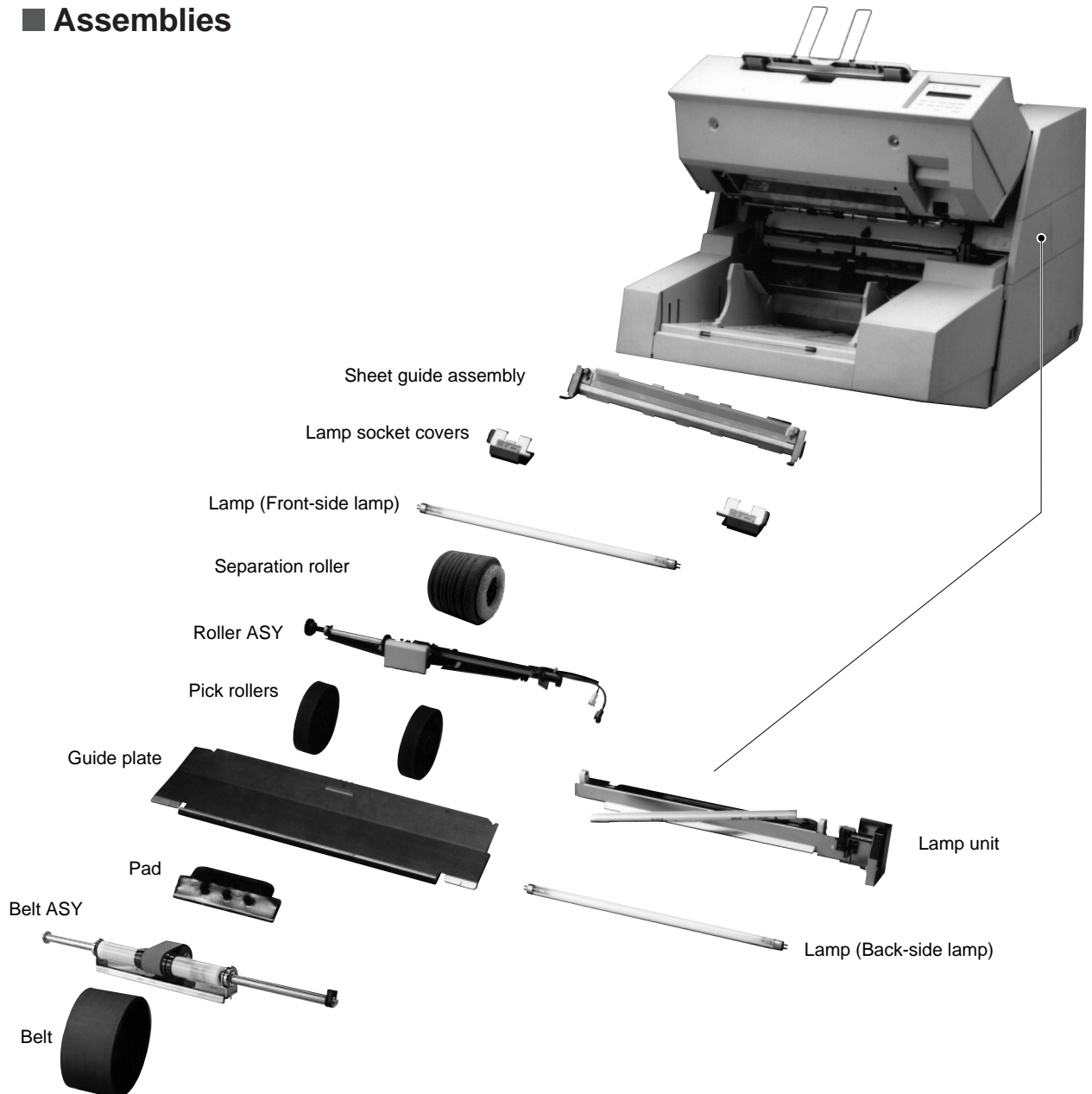

# Operator Panel(M3099EX/EH)

The operator panel is located at the upper right hand side of the scanner. The panel consists of an LCD (24 character x 2 line), LEDs and buttons.

## ■ Arrangement

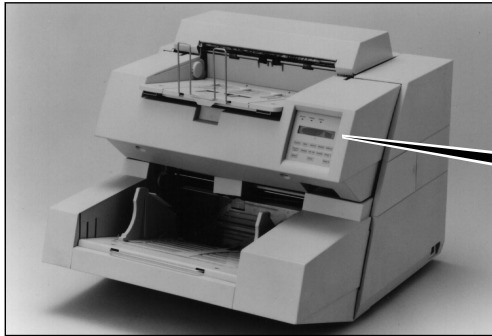

Operator panel

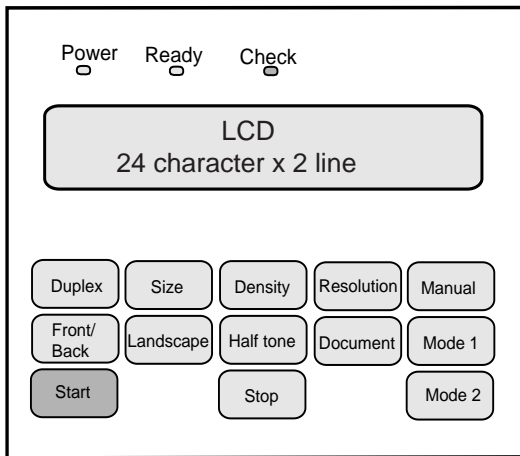
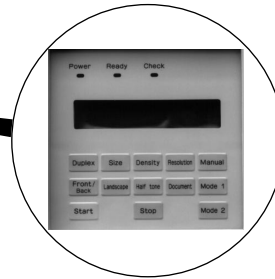



## ■ Button/LED Function

Button name	Function
<b>Start</b>	When the Ready lamp is lit in the manual start mode, pressing this button starts a scanning operation.
<b>Stop</b>	When pressed during scanning: The scanning operation immediately stops and the document under transport is ejected to the stacker. A picked document, if any, is ejected to the stacker. The hopper table is lowered to the bottom. When pressed while waiting for Hopper-timer: The hopper table is lowered to the bottom. When pressed displaying the initial screen: The abrasion counter is displayed. When pressed occurring the temporary error: The temporary error is recovered. When pressed while setting the scanning mode: The display returns to the initial screen.
<b>Duplex</b>	Toggles the LCD screen between simplex and duplex reading mode.
<b>Size</b>	Sets the document size.
<b>Density</b>	Sets the scanning density.
<b>Resolution</b>	Sets the scanning resolution.
<b>Manual</b>	Sets the manual mode. Pressing this button lifts the hopper table to the level for manual mode. Pressing the button again releases the mode and lowers the hopper table to the bottom.
<b>Front/Back</b>	Toggles the LCD screen between front-side and back-side reading mode.
<b>Landscape</b>	Toggles the document scanning direction between the portrait and landscape mode.
<b>Half tone</b>	Sets whether to execute halftone processing (dither or error diffusion) and also sets automatic separation processing (dither or error diffusion if the image processing option is installed).
<b>Document</b>	Toggles the document scanning mode between the photo and linedrawing mode.
<b>Mode 1</b>	Activates the setup mode. (See Chapter 7)
<b>Mode 2</b>	Activates the maintenance mode.
LED	Function
<b>Power</b>	Lights to indicate the power is on.
<b>Ready</b>	Lights when the image scanner becomes ready to read a document in the manual mode and manual start mode. This indicator turns off when the Start button is pressed to read a document.
<b>Check</b>	Lights when an equipment error occurs. An error messages is displayed on the LCD screen. This indicator blinks when a document is jammed in the ADF. This indicator turns off when the jammed documents are removed from the ADF and the upper transport unit is closed.

## ■ LCD Display

The scanner is provided with simplex and duplex reading modes.

### Simplex reading mode

The upper line (line 1) displays the current read mode for simplex reading.

The lower line (line 2) displays the mode set and messages when the buttons are pressed.

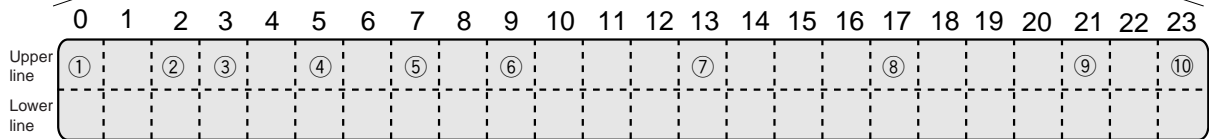
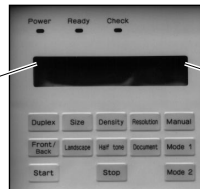

No.	Function	Description
①	Manual mode	:ADF mode M :Manual mode
②	Reading mode	D :Duplex reading S :Simplex (front-side) reading
③	Read side	F :Front-side reading mode B :Back-side reading mode
④	Size	DL :Double-letter (only for M3099EX) LT :Letter LG :Legal A3 :A3 (only for M3099EX) A4 :A4
⑤	Document orientation	□ :Portrait □ :Landscape
⑥	Density	■■■■ :Very dark ■■■□ :Dark AT1 :Dynamic threshold AT1* AT2 :Dynamic threshold AT2* ■■■□ :Normal ■■□□ :Light ■□□□ :Very light *Only when the image processing option is available.

No.	Function	Description
⑦	Resolution	400 :400dpi 300 :300dpi 240 :240dpi 200 :200dpi
⑧	Halftone processing	:No halftone processing HT1 :Dithering HT2 :Error diffusion LP1 :Automatic separation (dither)* LP2 :Automatic separation (error diffusion)* When the image processing option is not installed, automatic separation is not available.
⑨	Photo/linedrawing mode	P. :Photo mode L. :Linedrawing mode* *When linedrawing mode is selected, check that the 3 mm margin of the read area is specified as a drop-out color.
⑩	Image processing option	:No > :Yes

## Duplex reading mode

The upper line (line 1) displays the current read mode for front-side reading.

The displayed messages are the same as those in the simplex reading mode.

The lower line (line 2) displays the current read mode for back-side reading.

Only the density, halftone processing, photo/linedrawing mode and image processing option can be specified independently.

The other mode is the same as that for front-side reading.

	0	1	2	3	4	5	6	7	8	9	10	11	12	13	14	15	16	17	18	19	20	21	22	23
Upper line	M		D	F		A	4	□		■	□	□		4	0	0						L	.	>
Lower line			D	B						①												③		④

No.	Function	Description
①	Density	■■■■:Very dark ■■■■:Dark AT1 :Dynamic threshold AT1* AT2 :Dynamic threshold AT2* ■■■□:Normal ■■□□:Light ■□□□:Very light *Only when the image processing option is available.
②	Halftone processing	:No halftone processing HT1:Dithering HT2:Error diffusion AT1:Automatic separation (dither)* AT2:Automatic separation (errordiffusion)* *Only when the image processing option is available.
③	Photo/linedrawing mode	P. :Photo mode L. :Linedrawing mode* *When linedrawing mode is selected, check that the 3 mm margin of the read area is specified as if a drop-out color.
④	Image processing option	:No > :Yes

## Operation status

Operation status is indicated by the following message:

### <Power-on>

When the lamps are ready to read, the screen changes to the initial screen of the simplex or duplex reading mode.

```
W a r m i n g   -   u p   N o w ! !
```

### <Warning>

```
  X X   X X X   X X X           X X X  
                I N K   E M P T Y
```

The upper line displays the current read mode for front-side reading. The lower line is blinking and displays the ink empty of print head after the scanning operation.

This warning display will be reset, when the covers are opened, or **Stop** is pressed, or Start command is issued. The operator must change the print head and reset the life counter. (See Chapter 6 ENDORSER.)

### <Reading counter>

Example of simplex reading:

```
S F   A 4 □   ■ □ □   4 0 0           L . >  
                                           X X X
```

Reading  
counter

The reading counter is displayed after a read operation starts.

The reading counter disappears when:

- The next scanning starts.
- The valid switches are pressed.
- The error is cleared.

<Abrasion counter>



The abrasion counter is displayed when  is pressed in the initial screen.

The abrasion counter disappears when:

- The next scanning starts.
- The valid switches are pressed.
- The error is cleared.

The abrasion counter is not displayed if  is pressed during blinking.

The abrasion counter displays the accumulative number of read document.

This counter can be reset to zero by following the procedure shown in Chapter 7 (page 7-7).

<IPC pre-set mode>

Simplex reading mode



Duplex reading mode



When IPC pre-set mode is set, an asterisk ( \* ) is displayed. The method of IPC pre-set mode is shown in setup mode.





# Operator Panel(M3099GX/GH)

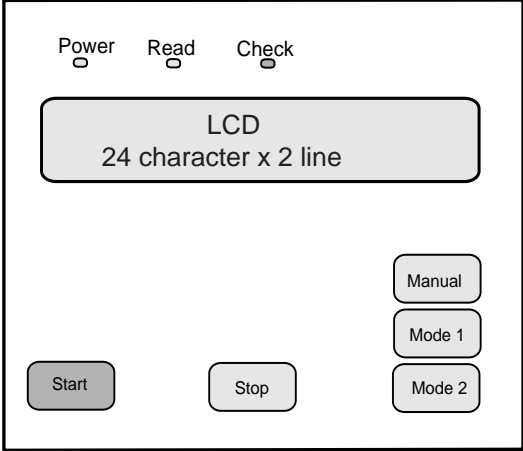

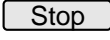

The operator panel is located at the upper right hand side of the scanner. The panel consists of an LCD (24 character x 2 line), LEDs and buttons.

## ■ Operator panel

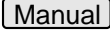
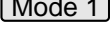
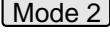

## ■ Button/LED Function

Button name	Function
	This button is used to indicate  to scanner in maintenance mode or SETUP mode at Off-line. This button is disabled while scanner operates in On-line.
	This button is used to indicate  to scanner in maintenance mode or SETUP mode at Off-Line. This button is used to cancel temporary error while operating at On-line.
	This button is used to select manual feeding mode. By pressing this button, setting is switched between manual feeding and ADF mode.
	Activates the setup mode. (See Chapter 7)
	Activates the maintenance mode.

LED	Function
	When the Power switch is turned on, this LED is turned on.
	While scanning, this LED is turned on.
	When a scanner malfunction is detected, this LED is turned on. When temporary error (Paper Jam, and so on) is detected, this LED is blinked. When temporary error is cleared and  button is pressed, this LED will be turned off.

## ■ LCD Display

When the Power switch is turned on, the following messages appear on LCD at On-line.

<Power-On to Ready>

W a r m i n g - u p N o w ! !

<Operation Ready>

S c a n n e r R e a d y

<Operation Ready in Manual  
Feed mode>

M a n u a l F e e d  
S c a n n e r R e a d y

<Warning>

I N K E M P T Y

The lower line is blinking and displays the ink empty of print head after the scanning operation.

This warning display will be reset, when the covers are opened, or **Stop** is pressed, or Start command is issued. The operator must change the print head and reset the ink counter.

<Reading counter and  
Abrasion counter>

S c a n n e r R e a d y X X X

Reading  
counter

The reading counter is displayed after a read operation starts.



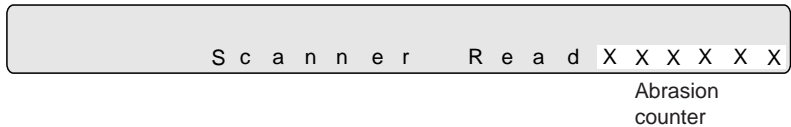

The abrasion counter is displayed when  is pressed in the Ready screen.

The abrasion counter displays the accumulative number of read document.

This counter can be reset to zero by following the procedure shown in Chapter 7 (page 7-7).

The reading counter or abrasion counter disappears when:

- The next start command is issued.
- The valid switches are pressed.
- The error is cleared.

<IPC pre-set mode>

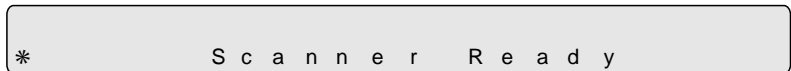

When IPC pre-set mode is set, an asterisk ( \* ) is displayed. The method of IPC pre-set mode is shown in setup mode.

# Buzzer Functions

The scanner has a buzzer to indicate that an error has occurred.

Error	Function
Equipment error	Sounds for 3 seconds. The buzzer turns off when any button is pressed or the power is turned off. Even when a button is pressed, the scanner continues to display the error.
Temporary error	Sounds during 3 seconds with 0.5 second interval. The buzzer turns off when any button is pressed or power is turned off. Even when a button is pressed, the scanner continues to display the error.

The buzzer function can be set on or off by following the procedure in Chapter 7 SETUP MODE.

# ***INSTALLATION AND CONNECTIONS***

---

*The chapter describes how to install and connect the scanner.*

**Precautions**

**Inspection**

**Cable Connection**

# Precautions



## **WARNING**

Place the machine with no portion of the scanner hangs over the desktop. Never attempt to move or relocate the machine without help. And hold the horizontal plane of the scanner bottom. (Not inclined plane)



## **ACHTUNG**

Stellen Sie den Scanner sicher auf eine waagerechte, ebene Fläche. Bewegen Sie den Scanner nicht ohne Hilfe.

This section describes precautions when installing the scanner.

Do not install the scanner in the following places and environments.

- Place the scanner away from electrical noise sources, strong magnetic fields and air flow. If the scanner is used near an air conditioner, copying machine, or TV set, the scanner may operate incorrectly.
- Keep the scanner out of the sun and away from heaters. These environments may shorten the scanner life or cause hardware failures.
- Do not install the scanner in a place where vibrations may occur. This environment may cause hardware failures or may cause the scanner to operate incorrectly.
- Do not install the scanner in a humid, dusty, or damp places. These environments may shorten the scanner life or cause hardware failures. Do not place the scanner where liquid spills may occur.
- Be aware of the static electricity. Be sure that the flooring and the desk are made of materials that do not generate the static electricity.

See Chapter 5 SPECIFICATIONS for the information such as the size of the installation space.

# Inspection

This section describes how to check the labels.

Make sure that the input voltage indicated on the temporary label agree with your power source.

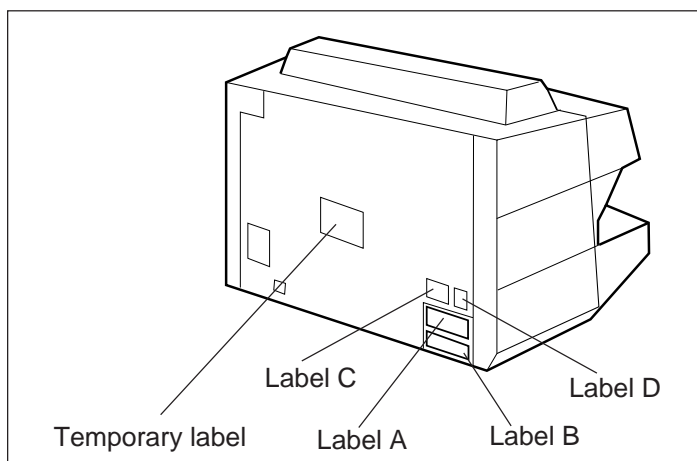

After checking the power voltage rating of the scanner with the temporary label, connect the correct power supply to the scanner.

## Label A (An example)

この装置は、商工業地域で使用されるべき第一種情報装置です。住宅地域、又はその隣接した地域で使用するとラジオ、テレビジョン受信機等に受信障害を与えることがあります。 VCCI-1	
This device complies with Part 15 of the FCC Rules. Operation is subject to the following two conditions. (1) This device may not cause harmful interference, and (2) this device must accept any interference received, including interference that may cause undesired operation.	
 LR53350	 
電源を接続する前に必ず設置説明書をご覧ください。 See installation instructions before connecting to the supply. Voir la notice d'installation avant de raccorder au réseau. Bitte lesen sie die Bedienungs Anleitung bevor sie das Gerät in Betrieb setzen.	

Label B (An example)

MODEL M3099EH	IMAGE SCANNER
PART NO. CA02869-B202	AC100-120/200-240V
SER. NO.	1 phase 50/60Hz
DATE 1993-11	2.5/1.25A 65 kgf
<b>FUJITSU LIMITED</b>	MADE IN JAPAN 

Label C (An example)

MODEL NAME	HLS-001E
PART NO.	CA02869-B001
MODEL	- 0 1 2 3 4 5 6 7 8 9
REV.	- 0 1 2 3 4 5 6 7 8 9
	- 0 1 2 3 4 5 6 7 8 9

Label D (An example)



Temporary Label (An example)

この装置は AC100-120V に設定されています。 電源の電圧を変更する場合は保守説明書をご覧ください。
This machine is wired for AC100-120V. To change the Voltage setting, call the service personnel.

 CAUTION

*If the power voltage rating of the scanner is different from your power source, please contact manufacturer's authorized service center.*

# Cable Connection

This section describes how to connect the cables.

Connect the cables as follows:

## ■ Turning the power switch off

Press “O” side of the power switch to turn the power off.

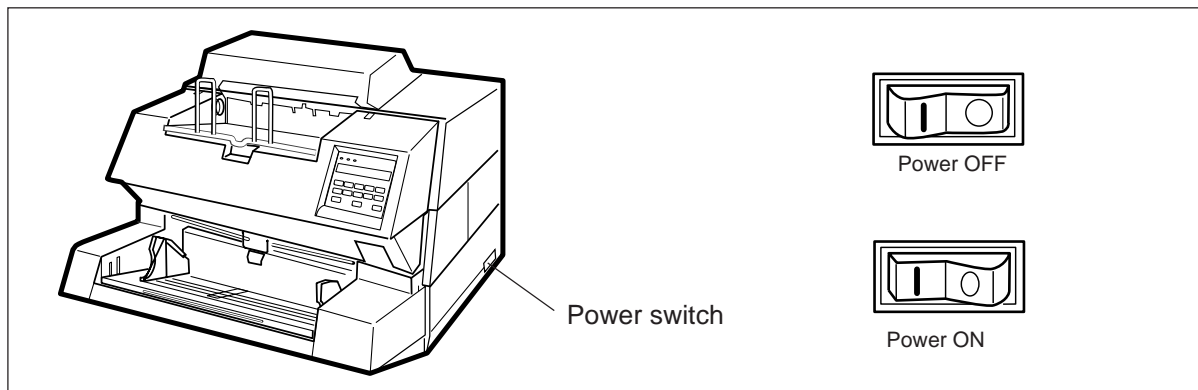

## ■ Connecting the power cable

Connect the power cable to the power inlet of the device and a power outlet.

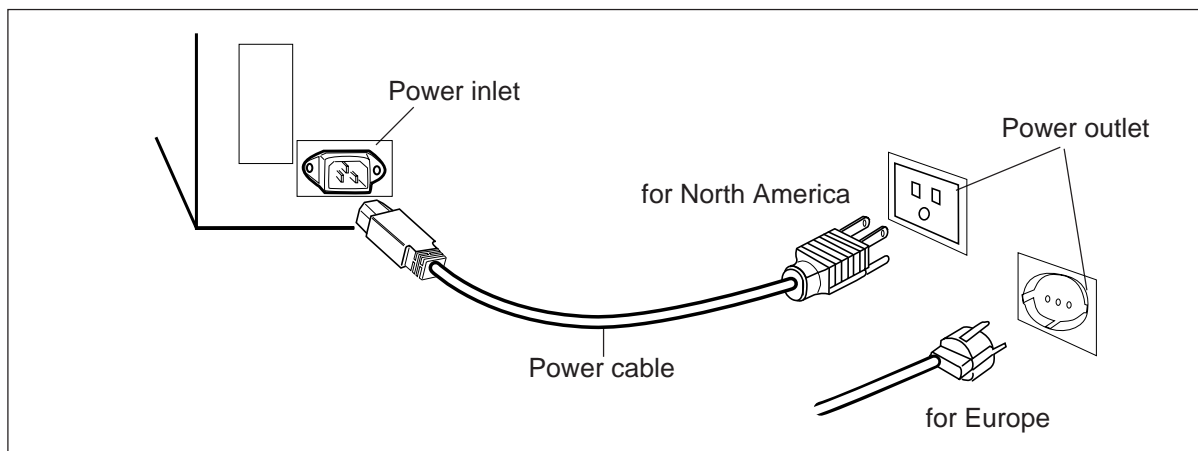

## ■ Connecting the interface cable

(M3099EX/EH)

Connect the video interface and RS-232C interface cables and secure them with hooks and screws. Connect the other ends to the host machine.

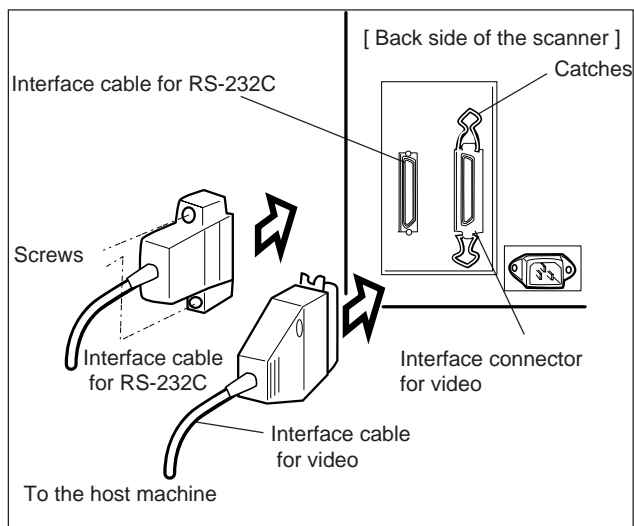

(M3099GX/GH)

Connect the SCSI interface cables and secure them with hooks and connect the other ends to the host machine. When the scanner is at the terminal side, connect the terminator to the connector to which an interface cable is not connected.

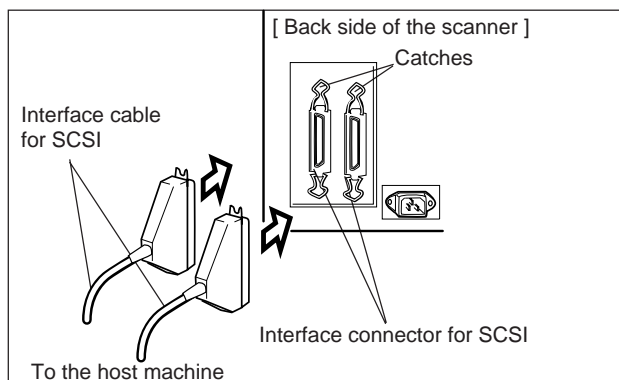

### NOTE

SCSI-ID is set to No. 5. Refer to Chapter 7 when changing the setting.





# ***OPERATING INSTRUCTION***

---

*This chapter describes how to turn the power on, and also describes button specification and reading mode setting. Refer to Reference Guide about information on loading document and opening/closing the upper transport unit.*

**Turning the Power On**

**Button Specification and Reading Mode Setting  
(M3099EX/EH)**

**Button Specification (M3099GX/GH)**

# Turning the Power On

This section describes how to turn the power on.

Press “I” side of the power switch. The power goes on and the green Power lamp at the operator panel lights.

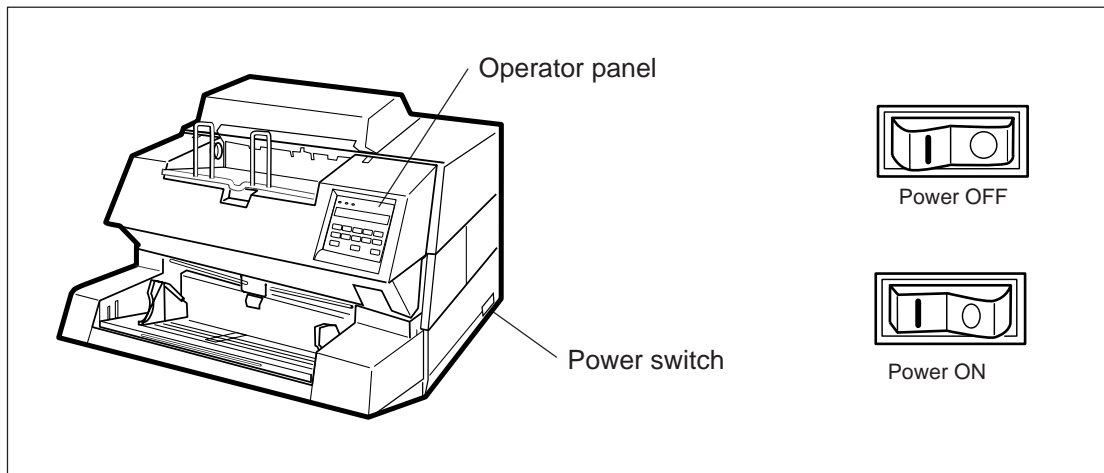

# Button Specification and Reading Mode Setting (M3099EX/EH)

This section describes the button specifications and setup details for each of the simplex (front-side), duplex (front-side) and duplex (back-side) reading modes.

When reading mode is set by the command from the host computer, the following button operation is not required.

## ■ **Duplex** button

This button is used to select simplex or duplex document reading mode. Press this button to toggle the display between the initial screens of the simplex and duplex reading modes.

<Initial screen of the simplex reading mode>

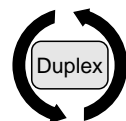

button pressed



<Initial screen of the duplex reading mode>

## ■ **Front/Back** button

This button is valid only in the duplex reading mode. Press this button to toggle the read side between front and back. "F" and "B" blink alternately for the setting of front or back-side.

<Initial screen of the duplex reading mode>

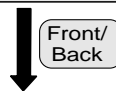
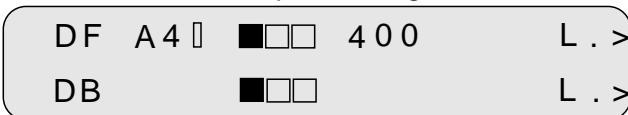

button pressed

<Screen 1>  
(Blinking)

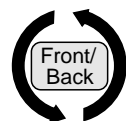
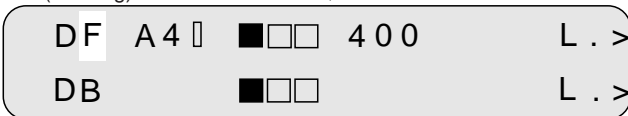

button pressed

<Screen 2>

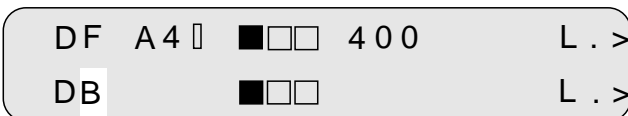

(Blinking)

## Simplex (front-side) reading mode setting

<Initial screen of the simplex reading mode>

SF A4    400 L . >

### ■ button

Selects a document size. When this button is pressed the lower line is displayed as shown in Screen 3.

(M3099EX)

Each time this button is pressed, "DLT", "LT", "LG", "A3" or "A4" starts blinking in turn and the size displayed on the upper line changes accordingly. If the direction indicated on the upper line is "", only "LT" or "A4" can be selected.

<Screen 3>

SF A4    400 L . >  
Size: DLT LT LG A3 A4

(Blinking)

(M3099EH)

Each time this button is pressed, "LT", "LG", or "A4" starts blinking in turn and the size displayed on the upper line changes accordingly.

SF A4    400 L . >  
Size: LT LG A4

(Blinking)

## ■ Density button

Selects a density for the read operation. When this button is pressed, the lower line is displayed as shown in Screen 4. Each time this button is pressed, the blinking part in the lower line changes, and the density indicated on the upper line changes according to the blinking part.

<Screen 4>

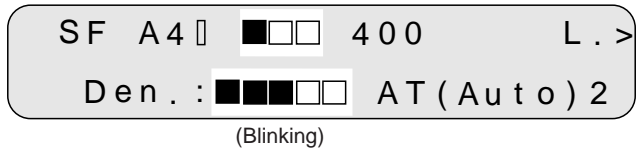

The lower line is displayed as shown below.

Lower line display		Description
Without image processing option	With image processing option	
		Very dark Dark Dynamic threshold Simplified dynamic threshold
	Auto 1 	
	Auto 2 	Normal Light Very light

Blinking order  
↓

## ■ Resolution button

Selects a resolution for the read operation. When this button is pressed, the lower line is displayed as shown in Screen 5. Each time this button is pressed, "400", "300", "240" or "200" starts blinking in turn and the resolution indicated on the upper line changes accordingly.

<Screen 5>

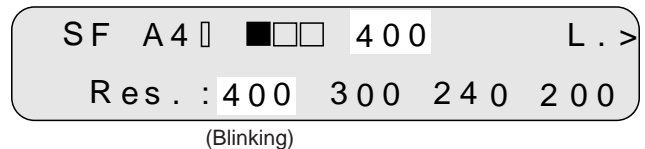

■ **Landscape button (\*1)**

Specifies landscape or portrait mode for reading. When this button is pressed, the lower line is displayed as shown in Screen 6. Each time this button is pressed, the blinking part changes in turn and the mode indicated on the upper line changes accordingly.

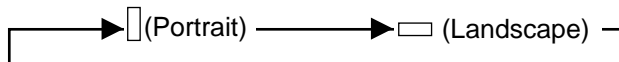

\*1; This button is available only for M3099EX.

 **NOTE**

Landscape mode can be selected only when the document size is LT or A4.

(M3099EX)

<Screen 6>



(Blinking)

(M3099EH)



(Blinking)

■ **Half tone** button

Specifies the halftone processing (dither or error diffusion). When this button is pressed, the lower line is displayed as shown in Screen 7. Each time this button is pressed, the blinking part changes in turn, and the halftone indicated on the upper line changes accordingly.

<Screen 7>

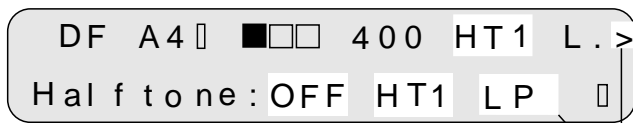

① ② ③  
(Blinking)

Not displayed unless the image processing option is installed.

Blinking order	Display			Explanation
	①	②	③	
1	OFF blinking	HT1	LP1	Line Art (Halftone processing off)
2	OFF	HT1 blinking	LP1	Halftone processing (dither) *1
3	OFF	HT2 blinking	LP2	Halftone processing (error diffusion)
4	OFF	HT1	LP1 blinking	Automatic separation (dither) *2
5	OFF	HT2	LP2 blinking	Automatic separation (error diffusion) *2

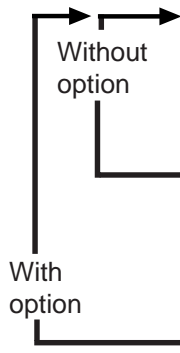

\*1: Select one of these settings to read data such as photographs, illustration, or colored maps.

\*2: If photographs and characters are mixed in a document, the characters are read clearly and the photographs are read in halftone. This setting is only available when the image processing option is installed.





Document

## button

Selects the type of document. When this button is pressed, the lower line is displayed as shown in Screen 8. Each time this button is pressed, "LINE" or "PHOTO" starts blinking in turn and the document selection indication displayed on the upper line changes accordingly.

<Screen 8>

SF	A4	<input type="checkbox"/>	<input type="checkbox"/>	400	HT1	P. >
DOC . :	L. (Line)					P. (Photo)

(Blinking)

Display	Explanation
P. (Photo)	For light adjustment or when there is a dark background color on the document.
L. (Line)	Select this setting to read line drawing. *1

\*1; Top 3mm part of the read area should be left blank (grounding color ) by specifying a drop-out color.

## ■ Manual button

This button is used to set or release the manual mode.

Pressing this button displays <Screen 9>. The manual mode is set and the hopper goes up. Pressing this button again releases the manual mode and lowers the hopper to the bottom position.

<Screen 9>



(Manual mode set)

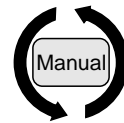

button pressed

<Initial screen of the simplex reading mode>



(Manual mode released)

## ■ Screen transition

<Initial screen of the simplex reading mode>

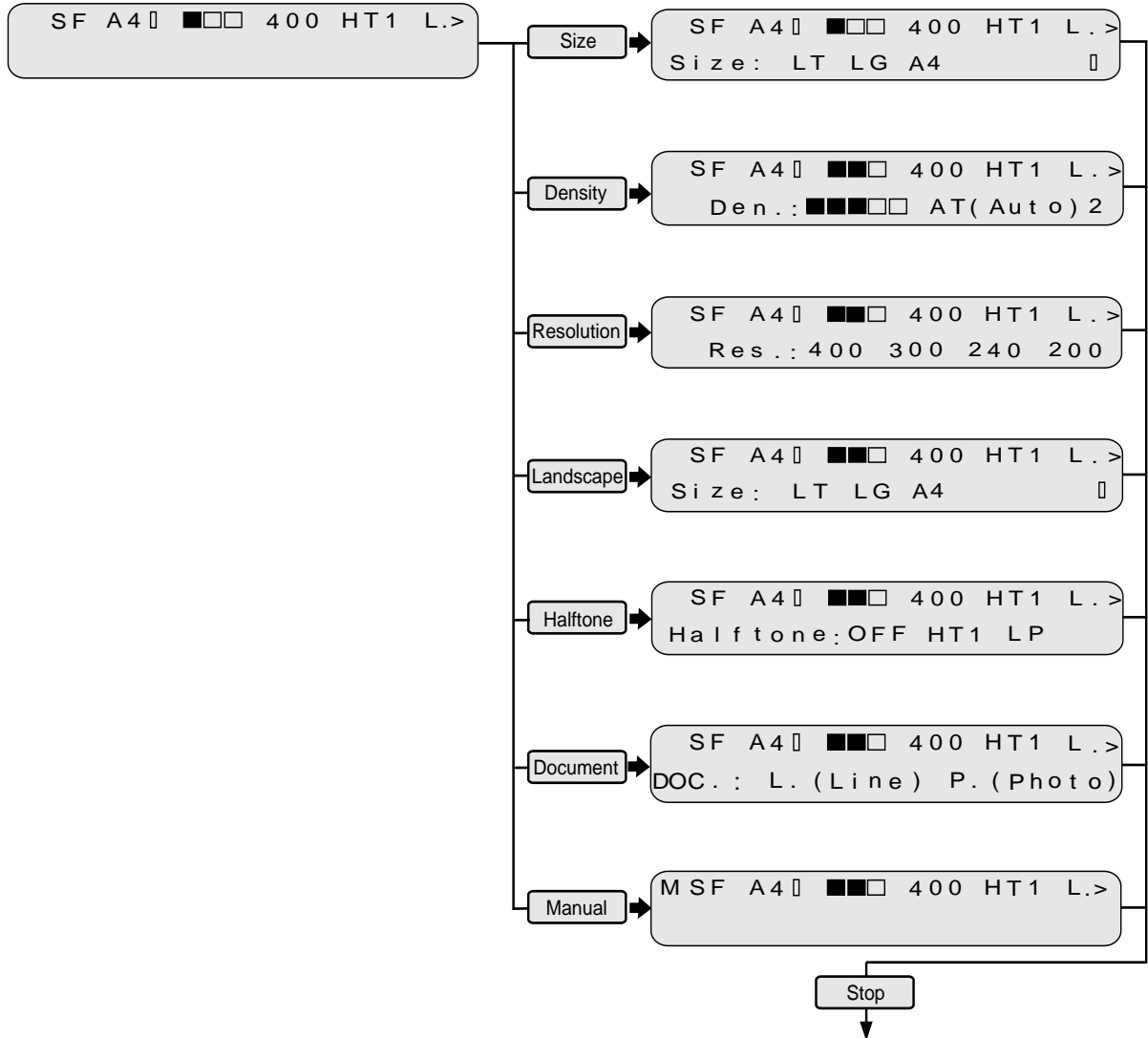

To the initial screen of the simplex reading mode (\*1)

\*1: Pressing the **Stop** button during reading mode returns the display to the initial screen of the simplex reading mode.

## Duplex (front-side) reading mode setting

<Initial screen of the duplex reading mode>

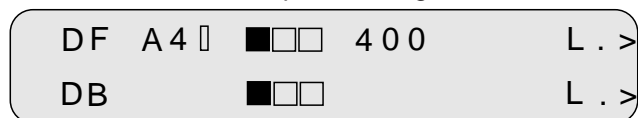

Use the following buttons to set the scanner when it reads the front-side of a document in duplex mode. This description applies to the case when reading the back-side except Density, Halftone and Document buttons.

### ■ **Size** button

This button is used to select a document size.  
For details, see the explanation of <Screen 3>.

(M3099EH)

<Screen 10>



(Blinking)

(M3099EX)



(Blinking)

### ■ **Density** button

This button is used to select a scanning density.  
For details, see the explanation of <Screen 4>.

<Screen 11>



(Blinking)

### ■ **Resolution** button

This button is used to select a scanning resolution.  
For details, see the explanation of <Screen 5>.

<Screen 12>

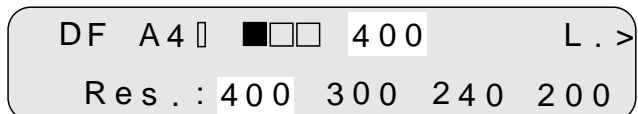

(Blinking)

## ■ Landscape button

This button is used to select document reading direction in portrait or landscape mode. For details, see the explanation of <Screen 6>.

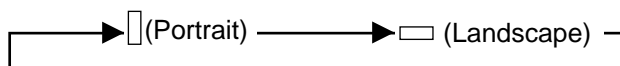

### NOTE

The landscape mode can be selected only when the document size is LT or A4. (M3099EH)

<Screen 13>



(Blinking)

(M3099EX)



(Blinking)

## ■ Half tone button

This button is used to select whether or not to perform halftone (dither or diffusion) processing. For details, see the explanation of <Screen 7>.

<Screen 14>



(Blinking)

Not displayed unless the image processing option is installed.

■ **Document button**

This button is used to select linedrawing mode or photo mode.  
For details, see the explanation of <Screen 8>.

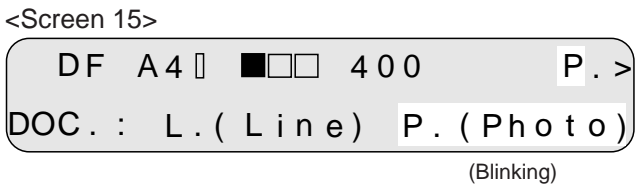

■ **Manual button**

This button is used to set or release the manual mode.  
For details, see the explanation of <Screen 9>.

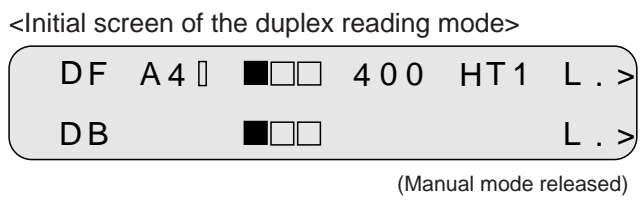
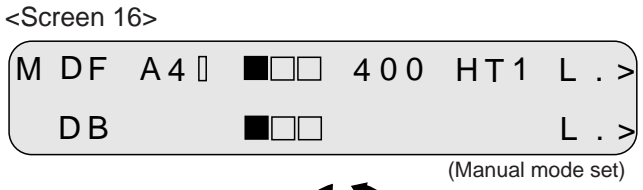

## ■ Screen transition

<Initial screen of the duplex reading mode>

```
DF A4 [ ] [ ] [ ] 400 HT1 L.>
DB [ ] [ ] [ ] [ ]
```

(Blinking) Front/  
Back button pressed

```
D [ ] A4 [ ] [ ] [ ] 400 HT1 L.>
DB [ ] [ ] [ ] [ ] L.>
```

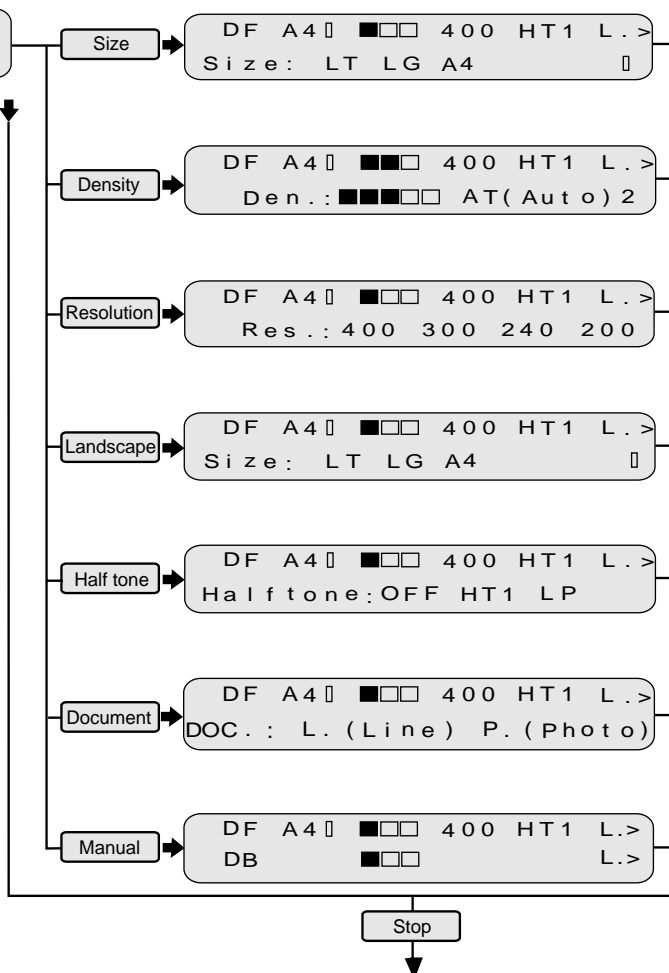

To the initial screen of the duplex reading mode (\*1)

\*1: Pressing the Stop button during reading mode returns the display to the initial screen of the duplex reading mode.

## Duplex (back-side) reading mode setting

Density, Halftone and Document buttons are available when reading the back-side.

<Initial screen of the duplex reading mode>

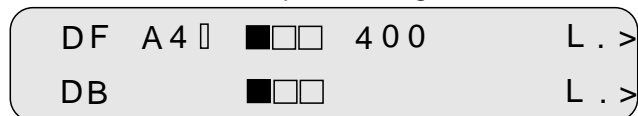

### **Density button**

This button is used to select a reading density. For details, see the explanation of <Screen 4>.

<Screen 17> (Blinking)



### **Half tone button**

This button is used to select whether or not to perform the halftone (dither or error diffusion) processing. For details, see the explanation of <Screen 7>.

Not displayed unless the image processing option is installed.

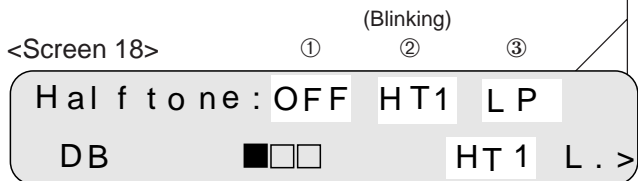

### **Document button**

This button is used to select line drawing mode or photo mode. For details, see the explanation of <Screen 8>.

<Screen 19> (Blinking)

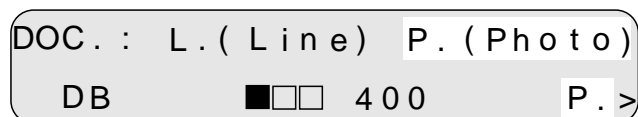



## ■ Screen transition

<Initial screen of the duplex reading mode>

```
DF A4 [ ] ■□□ 400 HT1 L.>
DB      ■□□ L.>
```

Front/Back button pressed

```
DF A4 [ ] ■□□ 400 HT1 L.>
DB      ■□□ L.>
```

Front/Back button pressed

```
DF A4 [ ] ■□□ 400 HT1 L.>
DB      ■□□ L.>
```

(Blinking)

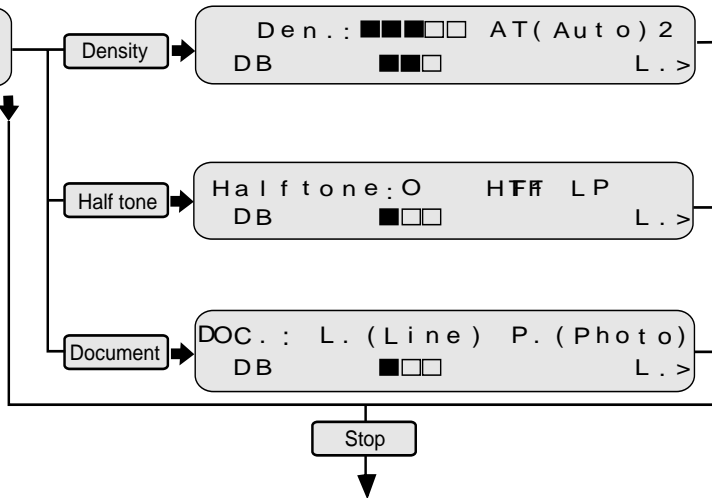

To the initial screen of the duplex reading mode (\*1)



\*1: Pressing the **Stop** button during reading mode returns the display to the initial screen of the duplex reading mode.



Press each button to start or stop reading.

### ■ **button**

Read operation can be started in either manual or automatic start mode. To start reading in manual start mode, press this button while the ready indicator is lit. (\*1)

\*1: Make sure that the LCD is the initial screen of simplex or duplex reading mode. If not, press  button once, then press  button.

Manual start mode: Reading is started by  button.

Automatic start mode: Reading is started by a command from the host machine.

---

### ■ **button**

This button is effective regardless of mode: manual or automatic mode.

Press this button to stop read operation.

When  button is pressed:

During reading: Reading immediately stops and the document being fed is ejected to the stacker. The hopper table is lowered to the bottom.

Before reading: A picked document, if any, is ejected to the stacker. The button works only when a document is picked. The hopper table is lowered to the bottom.

### **NOTE**

If a document which is not picked remains in front of ADF, set the document on the hopper again.

# Button Specification(M3099GX/GH)

This section describes the button specifications.

## ■ **Manual** button

This button is used to select manual feed mode. Pressing this button switches the setting between Manual mode and ADF mode.

When this button is pressed, the scanner enters manual feed mode and the hopper goes up. If the button is pressed again, the scanner exits manual feed mode and the hopper goes down.

---

## ■ **Start / Stop** button

These buttons are used in Off-line mode. When **Start** button is pressed in Off-line mode, the scanner starts document feeding. When **Stop** button is pressed in Off-line mode, the scanner stops document feeding.

**Stop** button is also used in On-line mode to cancel the temporary error condition.

---

## ■ **Mode 1** button

This button is used to transit to SETUP mode when the power is on. When **Mode 1** button is pressed and power is turned on, the scanner enters SETUP mode.

---

## ■ **Mode 2** button

This button is used to transit to maintenance mode when the power is on. When **Mode 2** button is pressed and power switch is turned on, the scanner enters maintenance mode. Maintenance mode is used for maintenance/diagnostic purpose. See M3099EX/GX/EH/GH IMAGE SCANNER CE MANUAL.



# ***DOCUMENT SPECIFICATION***

---

*This chapter describes the document size and document quality of the scanner.*

**Document Size**

**Document Quality**

# Document Size

The following figure shows document sizes that the scanner can read.

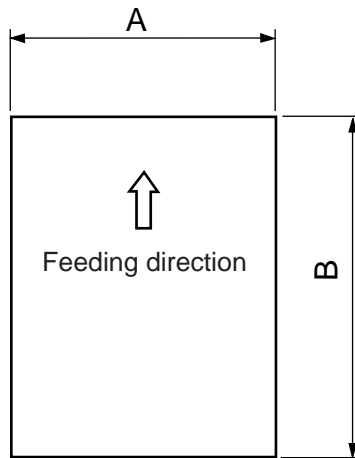

Scanner	Maximum		Minimum	
	A	B	A	B
M3099EX/GX	297 (11.7 in)	432 (17 in)	76 (3 in)	63 (2.5 in)
M3099EH/GH*	216 (8.5 in)	356 (14 in)	76 (3 in)	63 (2.5 in)

(Unit : mm)

\* The size that M3099EH/GH can read is shown in the table above. However, a document of up to A3 size can be fed.

# Document Quality

This section describes document types and weights available for the scanner, and precautions.

## ■ Document type

The recommended paper type for document is as follows:



Use the specified paper only. (In rare occasion, double feeding may occur or document damage may occur.)

- Fine paper
- Plain paper (for example, the paper specified for XEROX4024)
- OCR paper

When using all other type paper, check that it is successfully fed by ADF before performing a reading operation.

## ■ Paper weight

The paper weight is as follows :

- 52 to 127 g/m<sup>2</sup> 3.9 to 34 lb)

## ■ Precautions

Be careful not to scan the following document. Preliminary document feed test may be necessary to avoid the unexpected errors. If the document slips in ADF (JAM error) or double feed occurs frequently, separation pressure adjustment in Reference Guide may be effective.

- Paper with clips
- Paper with wet ink
- Paper of which thickness is not constantly equal. (like envelope)
- Paper with large rumples or curl. (See NOTE on the next page.)
- Paper with folds or tears
- Tracing paper
- Coating paper
- Carbon paper
- Carbonless paper
- Paper smaller than 76 mm x 63 mm size, or larger than A3
- Other than paper ; clothes, metal foil, or OHP film
- Photographic paper
- Paper with notches on its side
- Other than rectangle paper



### CAUTION

*Do not feed an important original document to prevent damage to it in rare case.*

When scanning a translucent document, set the density to light mode.

To prevent roller smudging, avoid scanning a document filled out in pencil. Clean the roller as often as possible when scanning many document. Once every 1000 sheets is recommended.

The chemical composition of some carbonless papers may react with the roller rubber and damage the rubber. Check the carbonless papers before use.

The carbonless papers may be used if:

- Paper weight is 52 g/m<sup>2</sup> (13.9 lb) or more.
- Hopper load is 500 sheets or fewer.



### NOTE

- If carbonless papers are used, clean the roller twice as often as usual.
- Paper should be straightened to fit the condition below.

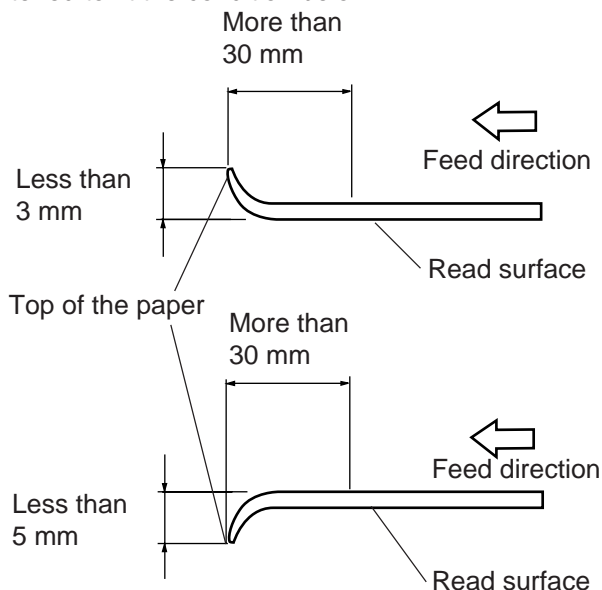

- Some papers might have a curl on the stack when you use curled paper having some fold wrinkle.





# ***SPECIFICATIONS***

---

*This chapter describes the installation specifications, dimensions, consumables, option.*

**Installation Specifications**

**Dimensions**

**Consumables**

**Option**

# Installation Specifications

The following table lists the installation specifications of the scanner.

Item		Specification		
Dimensions (mm)		Width	Depth	Height
		610 (24 in)	680 (26.8 in)	530 (20.9 in)
Weight (kg)		65 (143 lb.)		
Input power	Voltage	100 to 120 VAC, 220 to 240 VAC $\pm$ 10 %		
	Phases	Single-phase		
	Frequency	50/60 + 2% -4% Hz		
Power consumption		250 VA or less		
Ambient condition	Device status	Operating	Not operating	
	Temperature	5 to 35°C (41 to 95°F)	-20 to 60°C (-4 to 140°F)	
	Humidity	20 to 80 %	8 to 95 %	
Heat capacity		110 kcal/H (440 BTU/H)		

# Dimensions

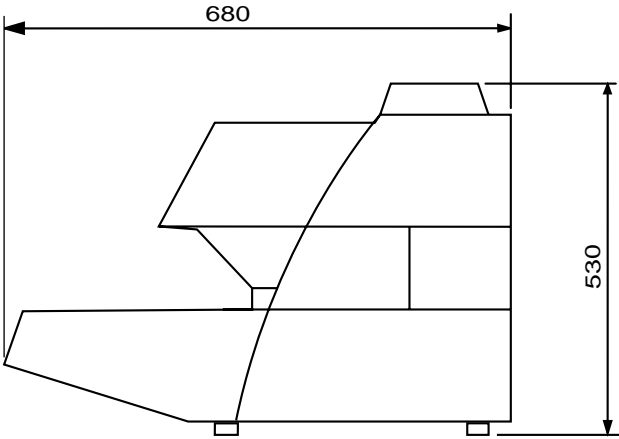
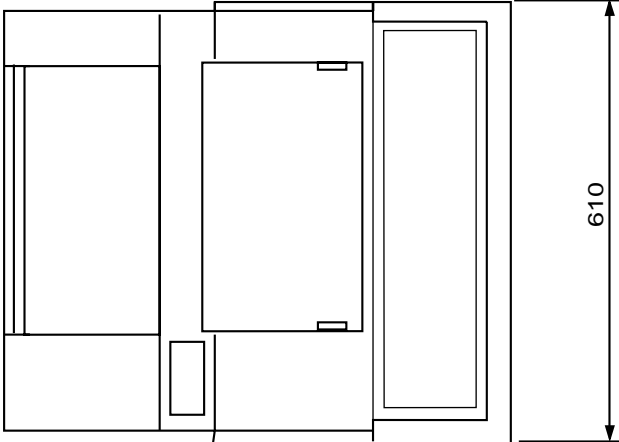

(unit: mm)

# Consumables

The following table lists consumables used for the scanner. Be sure to keep some consumables in stock. Customer is responsible to change these items periodically. The abrasion counter can be used to check the number of scanned documents. (See page 1-9 for M3099EX/EH or page 1-12 for M3099GX/GH.)

Name	Specification	Remark
Lamp	CA02950-0548	Up to 500 hours or more. Two lamps per scanner.
Pick roller	CA01023-F242	Up to 300,000 sheets or one year. Requires two per scanner.
Belt	CA02869-Y223	Up to 300,000 sheets or one year.
Belt ASY	CA02869-F220	Up to 600,000 sheets or one year. This part includes Separation Belt but the life of the Belt Assembly does not include the life of the Separation Belt.
Pad	CA01023-G290	Up to 300,000 sheets or more.
Print head	CA01023-0701	CA01023-0701 Black ink for endorser option. Ten print heads are packed. Each print head has the life of 20,000 sheets at 10 characters per sheet.
Separation Roller	CA02869-G236	Up to 600,000 sheets or one year.
Roller ASY	CA02869-F231	Up to 1,200,000 sheets. This part contains Pick Roller but the life of the Roller ASY does not include the life of the Pick Roller.

# Option

The following table lists options of the scanner.

Name	Specification	Remark
Endorser	CA01023-D004	Ink-jet back-side print max. 20 characters (See Chapter 6 ENDORSER.)

Contact your Fujitsu sales agent for more information.

# ***ENDORSER***

---

*This chapter describes the specifications of the endorser and panel operation.*

**Specifications**

**Panel Operation**

# Specifications

This section describes the specifications of the endorser.

Refer to Reference Guide about information on adjusting the print head position and replacing the print head.

The following table lists the endorser specifications.

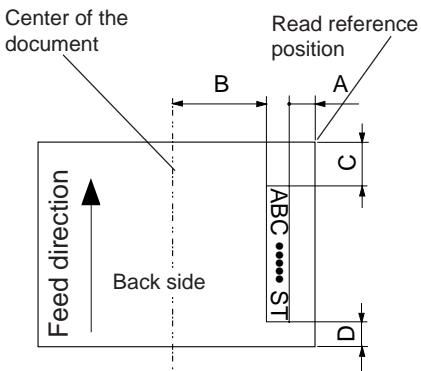
Item	Specification
Printing method	Ink jet printing method
Characters	Alphabet : A to Z, a to z Number : 0, 1, to 9 Symbol : ! " # \$ % & ' ( ) * + - . / : ; < = > ? @ [ ¥ ] ^ _ - { } (blank)
Maximum number of characters	20
Character size	2.9 x 1.5mm (0.11 in x 0.06 in)(height x width)
Character pitch	Approx. 2.54 mm (0.1 in)
Print area	Back-side of the document A ≥ 5 mm (0.2 in) B ≥ 28 mm (1.1 in) C ≥ 20 mm (0.79 in) D ≥ 5 mm (0.2 in) 



# Panel Operation

You can set the following conditions using the operator panel. Other conditions such as print offset or print characters can be set by the host machine.

## ■ How to set the endorser ON (or OFF)

When you use the endorser, you must set the endorser on as follows:

- 1 While pressing **Mode 1**, turn on the power of the scanner. Then the LCD displays SETUP MODE initial screen. <Screen 1>

<Screen 1>

<< SETUP MODE >>

- 2 Press **Mode 1** 8 times to display ENDORSER INITIAL screen. <Screen 2>  
Then press **Mode 2**. If "ON" is displayed, the endorser is already turned on.  
<Screen 3>

<Screen 2>

<< SETUP MODE >>  
ENDORSER INITIAL

- 3 If "OFF" is displayed, press **Mode 1** until "OFF" blinks. Then press **Mode 2** to turn the endorser on. <Screen 3>  
Go to **5** to store the settings in EEPROM.  
Go to **6** and **7** to close the job.

<Screen 3>

ENDORSER VALUE  
\* ON 00001

(Blinking)

### NOTE

Set the endorser on only when you use it, or characters may be printed on every scanned document.

## ■ How to set the initial number

The initial number is the number which the scanner starts printing or returns after the reset of the print number.

- 4 In Screen 3, press **Mode 1** until the number you want to display appears.  
(Ex. The initial number is **5** in Screen 4.)
- 5 To store the settings in EEPROM, press **Mode 1** until \* blinks. Then press **Mode 2** to change the LCD display into Screen 5.  
Press **Mode 2** to store the settings. Screen 6 appears for about 3 seconds.
- 6 Press **Mode 1** and **Mode 2** at the same time to return to ENDORSER INITIAL screen.  
<Screen 2>
- 7 Press **Stop** to return to the initial setting to read.

<Screen 4>

```
ENDORSER VALUE
* ON          0 0 0 0 5
```

(Blinking)

<Screen 5>

```
EEPROM WRITE ?
( M o d e 2 W r i t e )
```

<Screen 6>

```
EEPROM Writing !!
```

## ■ How to select the print number reset method

You can choose whether to reset or not the print number when "HOPPER EMPTY" is detected.

- 8 In Screen 1, press **[Mode 1]** 9 times to display ENDORSER RESET METHOD screen. <Screen 7>
- 9 Press **[Mode 2]** to display Screen 8. Press **[Mode 1]** to display "ON" or "OFF". Each time you press **[Mode 1]**, "ON" and "OFF" appear alternately. Select "ON" to reset the print number when "HOPPER EMPTY" appears and select "OFF" not to reset. The setting is automatically stored in EEPROM.
- 10 Press **[Mode 2]** to return to Screen 7. Go to **7** to close the job.

<Screen 7>

```
<< SETUP MODE >>
ENDORSER RESET METHOD
```

<Screen 8>

```
HOP - EMPTY RESET
ON
```

## ■ How to reset the print number manually

You can reset the print number to the initial number using the operator panel.

- 11 In Screen 1, press **[Mode 1]** 10 times to display ENDORSER RESET screen. <Screen 9>
- 12 Press **[Mode 2]** to display Screen 10 where "OFF" and the current print number are displayed. If you want to reset the number, press **[Mode 2]**. And you can see Screen 11 for 3 seconds. If you do not want it, press **[Mode 1]** to go Screen 9. Go to **7** to close the job.

<Screen 9>

```
<< SETUP MODE >>
ENDORSER RESET
```

<Screen 10>

```
RESET VALUE 00001
No - Mode 1 Yes - Mode 2
```

<Screen 11>

```
RESET Finish!! 00001
```

## ■ How to reset the print head life counter

You must reset the print head life counter when you replace the print head.

**13** In Screen 1, press **[Mode 1]** 11 times to display INK RESET screen. <Screen 12>

<Screen 12>

<< SETUP MODE >>  
I N K R E S E T

**14** Press **[Mode 2]** to display Screen 13. If you want to reset the counter, press **[Mode 2]**. And you can see Screen 14 for 3 seconds. If you do not want it, press **[Mode 1]** to go Screen 12.

<Screen 13>

I N K R E S E T  
N o - M o d e 1 Y e s - M o d e 2

Go to **7** to close the job.

<Screen 14>

R E S E T F i n i s h ! !

## ■ How to test the printing using the operator panel

You can check the print result as follows:

**15** Turn the endorser on by following the procedure of “page 6-2, How to set the endorser ON (or OFF)”.

<Screen 15>

<< CE MODE >>  
T E S T x x : S T A R T

**16** Turn the power of the scanner on while pressing **[Mode 2]**. The LCD displays MAIN-TENANCE MODE initial screen.  
<Screen 15>

**17** Press **[Mode 2]** once, then press **[Mode 1]** once. Place a document on the stacker, then press **[Start]**.

### NOTE

- The scanner prints 5-digit numbers counting in increment of one from the initial number.
- Before pressing **[Start]** you can set the document size, resolution and so on (See Chapter 3).



# ***SETUP MODE***

---

*This chapter describes the setup mode of the scanner.*

**Activating the Setup Mode**

**Contents of the Setup Mode**

# Activating the Setup Mode

This section describes how to activate the setup mode.

- 1 Turn the power of the scanner on while pressing **Mode 1**. The LCD displays Screen 1.
- 2 After a while, LCD displays SETUP MODE initial screen. <Screen 2> (In case of M3099EX/EH, pressing **Mode 1** after turning power on displays Screen 2.)
- 3 Press **Mode 1** to select the menu of SETUP MODE. Press **Stop** to go to the readable status. (In case of M3099GX/GH, Screen 3 indicates the readable status.)

<Screen 1>

W a r m i n g - u p   N o   ! !   T

<Screen 2>

< < S E T U P   M O D E > >

<Screen 3>

S c a n n e r   R e a d y

# Contents of the Setup Mode

This section describes the contents of the setup mode.

The setup mode can be classified into 18 (M3099EX/EH) or 19 (M3099GX/GH) types.

Mode	Setup type	Contents
1	Setting double feed detection	Set in EEPROM whether double feed detection is done or not.
2	Setting IPC pre-set	Set in EEPROM the pattern No.of IPC pre-set mode.
3	Reset of abrasion counter	Reset the abrasion counter after Belt/Roller are exchanged.
4	Setting buzzer	Set in EEPROM whether the buzzer function is on or off.
5	Setting pre-pick	Set in EEPROM whether pre-picking is done for fast reading or not.
6	Adjusting LCD contrast	Set in EEPROM the LCD contrast.
7	Setting pick speed	Set in EEPROM whether pick speed is fast or slow.
8	Setting initial value of endorser	Set the initial number. The set value can be stored in EEPROM.
9	Setting reset method of endorser reset	Set in EEPROM whether the number is reset by hopper empty detection.
10	Resetting of endorser	Reset the number to the initial value.
11	Resetting of ink counter	Reset the ink counter after the print head is replaced.
12	Setting RS-232C transfer rate *1	Set the transfer rate in EEPROM. (1200/2400/4800/9600).
13	Setting SCSI-ID *2	Set the SCSI-ID. (0-7)
14	Setting Product-ID *2	Set the Product-ID. (M3096G/M3099G/M3099GH)
15	Setting picking start time	Set in EEPROM the time from when the hopper empty sensor is blocked in manual mode until picking begins.
16	Setting picking time	Set the time from when picking begins until the SF1 sensor is blocked by paper.
17	Setting time-out limit	Set the time from when a command is issued in manual mode until paper is actually detected.
18	Setting hopper time	Set the time from when Start Command Time-out limits until hopper table is lowered.
19	Setting heater control	Set in EEPROM whether heater control is on or off.
20	Setting hopper height	Set the hopper height at scanner ready.

\*1 Available for only M3099EX/EH.

\*2 Available for only M3099GX/GH.



## ■ Setting double feed detection

When you set the using of double feed detection, you must set as follows:

- 4 In Screen 2, press **Mode 1** once to display DOUBLE FEEDCHECK screen <Screen 4>.

<Screen 4>



- 5 Press **Mode 2** to display Screen 5. Select "ON" to set the error detection when the double feed occurs. Each time **Mode 2** is pressed, "ON" and "OFF" appear alternately.

<Screen 5>



(Blinking)

- 6 Press **Mode 1** to display Screen 6. This screen determines how to detect the double feed. "1" means the method by comparing with the length of the first paper. "2" means the method by the output of document detection sensor in addition to "1".

In Screen 6, press the **Mode 2** until the number you select appears.

- 7 Press **Mode 1** to display Screen 7. This screen determines the length to compare with the paper based on. If you choose "1" or "2" set "15 mm", the double feed is detected when the scanned paper length is 15 mm longer than the first paper.

In Screen 7, press the **Mode 2** until the number you want to select appears. (You can choose 10,15, or 20 mm. The default is 15 mm.)

<Screen 6>



(Blinking)

<Screen 7>



(Blinking)

- 8 Press **[Mode 1]** and **[Mode 2]** at the same time to display Screen 4. The settings are stored in EEPROM.  
When you close, press **[Stop]**.

Mode	Details
ON/OFF	“OFF” is default setting.
1	“1” is default setting. This mode is used when a batch of documents whose length are same is scanned. When a document with tears and wrinkles is scanned, the scanner may also fail to detect the double-feed.
2	This mode is used when a batch of documents whose length and thickness are same is scanned. However, when a thin document is scanned, the scanner may fail to detect the double-feed rarely. \\n In this case, please test scanning of a thin document in advance.

## ■ Setting IPC pre-set mode

When you set the using of IPC pre-set mode, you must set as follows:

- 1 AT Screen 2, press **[Mode 1]** twice to go to the IPC-3 SET screen. <Screen 8>
- 2 Press **[Mode 2]** to see Screen 9 or 10.  
If “No” is displayed, IPC pre-set mode is not used.  
If pattern number (“1”-“5”) is displayed, IPC pre-set mode is used.  
“No” or number status flips each time you press **[Mode 1]**.  
(The default setting is “No”.)

<Screen 8>

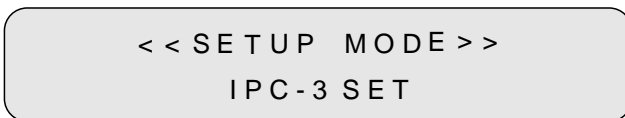

<Screen 9>

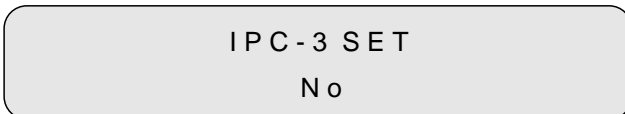

- 3 If you press the **Mode 2** at Screen 9, you return to screen 8.  
The setting is stored to EEPROM.  
If you press the **Mode 2** at screen 10, you go to screen 11. (Screen 12 in case of M3099GH/GX)

<Screen 10>

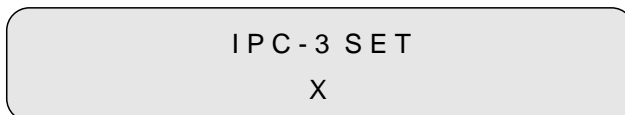

- 4 If you press the **Mode 1** at screen 11/12, IPC pre-set mode can be not used. Also the setting is changed to "No" obligatory and stored to EEPROM. If you press the **Mode 2** at screen 11/12, IPC pre-set mode can be used and the setting number is stored to EEPROM.  
When you close the setup mode, press **Stop**.

<Screen 11>

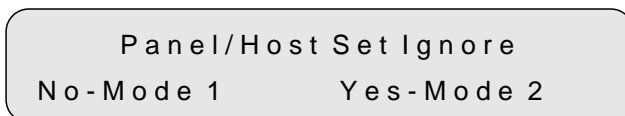

<Screen 12>



<Classification of user's paper>

User's paper are classified in line-art scanning as follows:

The horizontal axis shows the background density/color of paper.

The vertical axis shows the density of character/ line.

		Background density		Background color		
		Normal←	→Dark	Red	Green	Blue
Character density	Normal ↑	①: Normal background and character.	③: Dark background and normal-density character.			
	↓ Light	②: Normal background and light character.		④: Light character on red paper.	⑤: Light character on green paper.	

① - ⑤ are the pattern number set in setup mode.

 **NOTE**

- For patterns “1” to “5” when the power is turned on  
Scanner checks that IPC-3 for front/back sides are installed during initialization.  
If IPC-3 for either the front or back side is not installed, the scanner regards as no setting obligatory and changes the memory of EEPROM.
- When IPC pre-set is executed in setup mode  
Scanner checks that IPC-3 for front/back sides are installed when the scanner enters in IPC pre-set.  
If IPC-3 for either the front or back side is not installed, the scanner does not enter in IPC pre-set.
- When IPC pre-set mode is executed  
When IPC pre-set mode is executed in online mode, the reading parameter is valid or invalid (Host setting is invalid) as follows:

	Reading parameter							
	Reading mode	Transfer mode	Transfer rate	Reduction	Start of reading	Density	Line-art / Photo	Halftone
Valid	<input type="radio"/>	<input type="radio"/>	<input type="radio"/>	<input type="radio"/>	<input type="radio"/>			
Invalid						<input type="radio"/>	<input type="radio"/>	<input type="radio"/>

	Reading parameter							
	DTC	Size	Portrait/ Landscape	Picking	Document selection	r patterns	Contrast	Automatic separation
Valid		<input type="radio"/>	<input type="radio"/>	<input type="radio"/>	<input type="radio"/>			
Invalid	<input type="radio"/>					<input type="radio"/>	<input type="radio"/>	<input type="radio"/>

	Reading parameter					
	Conversion	Sharpness	Outline extraction	Overlay	Simplified DTC	Zooming
Valid	<input type="radio"/>					<input type="radio"/>
Invalid		<input type="radio"/>	<input type="radio"/>	<input type="radio"/>	<input type="radio"/>	

## ■ Reset of abrasion counter

When you reset the abrasion counter, you must set as follows:

- 1 In Screen 2, press **Mode 1** 3 times to display PAPER COUNT RESET screen.  
<Screen 13>
- 2 Press **Mode 2** to display Screen 14.  
You may see current paper count.  
If you want to reset the count, press **Mode 2**. And you can see Screen 15 for 3 seconds.  
If you do not want it, press **Mode 1** to go to Screen 13.
- 3 When you close the setup mode, press **Stop**.

<Screen 13>

```
<< SETUP MODE >>  
PAPER COUNT RESET
```

<Screen 14>

```
RESET COUNT 1 2 3 4 5 6  
No - Mode 1 Yes - Mode 2
```

<Screen 15>

```
RESET Finish!! 00000
```

## ■ Setting buzzer

When you set the using of buzzer, you must set as follows:

- 1 In Screen 2, press **Mode 1** 4 times to display BUZZER SET screen.  
<Screen 16>
- 2 Press **Mode 2** to display Screen 17.  
Select "ON" to ring the buzzer when an error occurs. Each time **Mode 1** is pressed, "ON" and "OFF" appear alternately. The setting is stored in EEPROM automatically.
- 3 Press **Mode 2** to return to Screen 16.  
When you close the setup mode, press **Stop**.

<Screen 16>

```
<< SETUP MODE >>  
PREPICK SET
```

<Screen 17>

```
BUZZER SET  
ON
```

## ■ Setting pre-pick

When you set the using of buzzer, you must set as follows:

- 1 In Screen 2, press **[Mode 1]** 5 times to display PREPICK SET screen.  
<Screen 18>
- 2 Press **[Mode 2]** to display Screen 19. Select "ON" to set the pre-picking when the document is fed. Each time **[Mode 1]** is pressed, "ON" and "OFF" appear alternately. The setting is stored in EEPROM automatically.
- 3 Press **[Mode 2]** to return to Screen 18. When you close the setup mode press **[Stop]**.

<Screen 18>

<< SETUP MODE >>  
PREPICK SET

<Screen 19>

PREPICK SET  
ON

## ■ Adjusting LCD contrast

When you adjust the LCD contrast, you must set as follows:

- 1 In Screen 2, press **[Mode 1]** 6 times to display LCD CONTRAST screen.  
<Screen 20>
- 2 Press **[Mode 2]** to display Screen 21. As the number of "■" increases, the LCD contrast gets darker.
- 3 In Screen 21, the LCD contrast is set to one of the 16 steps. Each time **[Mode 1]** is pressed, the number of "■" increases. When all fields are filled by "■", next pressing **[Mode 1]** starts from all "□" (The lightest contrast).
- 4 Press **[Mode 2]** to display Screen 20. The settings are stored in EEPROM.
- 5 When you close the setup mode, press **[Stop]**.

<Screen 20>

<< SETUP MODE >>  
LCD CONTRAST

<Screen 21>

LCD CONTRAST  
■■■■■■■■■■■■■■■■□□□□

## ■ Setting pick speed

When you set the pick speed, you must set as follows:

- 1 In Screen 2, press **Mode 1** 7 times to display PICK SPEED SET screen.  
<Screen 22>
- 2 Press **Mode 2** to display Screen 23. (The default setting is "FAST".)  
If "FAST" is displayed, the pick speed is fast. If "SLOW" is displayed, the pick speed is slow.  
Each time **Mode 1** is pressed, "FAST" and "SLOW" appear alternately. The setting is stored in EEPROM automatically.
- 3 Press **Mode 2** to return to Screen 22.  
When you close the setup mode, press **Stop**.

<Screen 22>

<< SETUP MODE >>  
PICK SPEED SET

<Screen 23>

PICK SPEED SET  
FAST SLOW

(Blinking)

## ■ Setting initial value of endorser

Before setting, see page 6-2, "Chapter 6 ENDORSER, Panel Operation".

- The use of Endorser (ON/OFF)  
The default setting is "OFF" (Endorser is not used.)
- The initial number  
The default setting is "00000".  
The selectable range is from 00000 to 65535.

### NOTE

If the specified value is equal or greater than 65536, returning to SETUP menu will be failed.

<Method of Increment >

When the initial value is "00001".

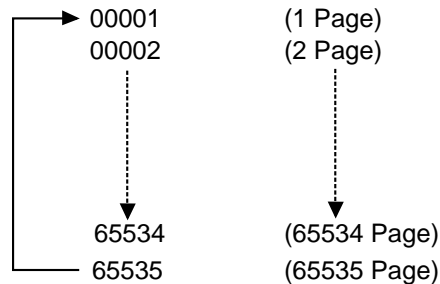

 **NOTE**

- If "depending on operator panel" is not set by host machine, you can not change the setting.
- When "depending on operator panel" is selected, printing starts at the position 20 mm back from the top end of the back side.

## ■ Setting reset method of endorser

Before setting, see page 6-2, "Chapter 6 ENDORSER, Panel Operation".

The default setting is "ON" (The print number will be reset when HOPPER EMPTY is detected.)

## ■ Resetting of endorser

Before setting, see page 6-2, "Chapter 6 ENDORSER, Panel Operation".

## ■ Resetting of ink counter

Before setting, see page 6-2, "Chapter 6 ENDORSER, Panel Operation".



## ■ Setting RS-232C transfer rate (M3099EX/EH)

When you set RS-232C transfer rate, you must set as follows:

- 1 In Screen 2, press **Mode 1** 12 times to display RS-232C BAUD screen.  
<Screen 24>
- 2 Press **Mode 2** to display Screen 25.  
(The default setting is 4800 bps.)
- 3 In Screen 25, press **Mode 1** until the rate you want to select blinks.
- 4 Press **Mode 2** to display Screen 24.  
The settings are stored in EEPROM.
- 5 When you close the setup mode, press **Stop**.

<Screen 24>

```
<< SETUP MODE >>  
RS232C BAUD
```

<Screen 25>

```
<< SETUP MODE >>  
9600 : 4800 : 2400 : 1200
```

(Blinking)

## ■ Setting SCSI-ID (M3099GX/GH)

When you set the picking start time, you must set as follows:

- 1 In Screen 2, press **Mode 1** 12 times to display SCSI-ID SET screen.  
<Screen 26 >
- 2 Press **Mode 2** to display Screen 27.  
(The default setting is "5".)
- 3 In Screen 27, press **Mode 1** to change SCSI-ID. Each time **Mode 1** is pressed, SCSI-ID changed from 0 to 7.
- 4 Press **Mode 2** to display Screen 26.  
The settings are stored in EEPROM.
- 5 When you close the setup mode, press **Stop**.

<Screen 26>

```
<< SETUP MODE >>  
SCSI - I D SET
```

<Screen 27>

```
SCSI - I D SET  
5
```

## ■ Setting Product-ID (M3099GX/GH)

When you set Product-ID, you must set as follows:

- 1 In Screen 2, press **[Mode 1]** 13 times to display PRODUCT-ID SET screen. <Screen 28>
- 2 Press **[Mode 2]** to display Screen 29.  
(The default setting is "M3099GH" in case of M3099GH and "M3099G" in case of M3099GX.)
- 3 In Screen 29, press **[Mode 1]** to select Product-ID. Each time **[Mode 1]** is pressed, M3099G, M3099GH or M3096G appear in case of M3099GH, and M3099G or M3096G at each time you press **[Mode 1]** in case of M3099GX.
- 4 Press **[Mode 2]** to display Screen 28.  
The settings are stored in EEPROM.
- 5 When you close the setup mode, press **[Stop]**.

<Screen 28>

```
<< SETUP MODE >>  
PRODUCT - I D SET
```

<Screen 29>

```
PRODUCT - I D SET  
XXXXXXXX
```

## ■ Setting picking start time

When you set the picking start time, you must set as follows:

- 1 In Screen 2, press **[Mode 1]** 13 times (14 times for M3099GX/GH) to display PICK START TIMER screen. <Screen 30 >
- 2 Press **[Mode 2]** to display Screen 31.  
(The default setting is 1 second.)
- 3 In Screen 31, press **[Mode 1]** until the digit you want to change blinks. Then press **[Mode 2]** until the value you want to select appears.  
(The selectable range is from 0.2 to 29.8 seconds in steps of 0.2 seconds.)
- 4 Press **[Mode 1]** and **[Mode 2]** at the same time to display Screen 30.  
The settings are stored in EEPROM.
- 5 When you close the setup mode, press **[Stop]**.

<Screen 30>

```
<< SETUP MODE >>  
PICK START TIMER
```

<Screen 31>

```
PICK START TIMER  
XX.X S
```

(Blinking)

## ■ Setting picking time

When you set the picking time, you must set as follows:

- 1 In Screen 2, press **Mode 1** 14 times (15 times for M3099GX/GH) to display PICK TIMER screen. <Screen 32>
- 2 Press **Mode 2** to display Screen 33. (The default setting is 2 seconds.)
- 3 In Screen 33, press **Mode 1** until the digit you want to change blinks. Then press **Mode 2** until the value you want to select appears. (The selectable range is from 0.5 to 99.5 seconds in steps of 0.5 seconds.)
- 4 Press **Mode 1** and **Mode 2** at the same time to display Screen 32. The settings are stored in EEPROM.
- 5 When you close the setup mode, press **Stop**.

<Screen 32>

```
<< SETUP MODE >>  
PICK TIMER
```

<Screen 33>

```
<< SETUP MODE >>  
  XX.X S
```

(Blinking)

## ■ Setting time-out limit

- 1 In Screen 2, press **Mode 1** 15 times (16 times for M3099GX/GH) to display TIME-OUT SET screen. <Screen 34>
- 2 Press **Mode 2** to display Screen 35. (The default setting is 30 seconds.)
- 3 In Screen 35, press **Mode 1** until the digit you want to change blinks. Then press **Mode 2** until the value you want to select appears. (The selectable range is from 1 to 1999 seconds in steps of 1 second.)
- 4 Press **Mode 1** and **Mode 2** at the same time to display Screen 34. The settings are stored in EEPROM.
- 5 When you close the setup mode, press **Stop**.

<Screen 34>

```
<< SETUP MODE >>  
TIME - OUT SET
```

<Screen 35>

```
TIME - OUT SET  
  XXXX S
```

(Blinking)

## ■ Setting hopper time

When you set the picking time, you must set as follows:

- 1 In Screen 2, press **Mode 1** 16 times (17 times for M3099GX/GH) to display HOPPER TIMER screen. <Screen 36>
- 2 Press **Mode 2** to display Screen 37.  
(The default setting is 7 seconds.)
- 3 In Screen 37, press **Mode 1** until the digit you want to change blinks. Then press **Mode 2** until the value you want to select appears.  
(The selectable range is from 0 to 30 seconds in steps of 1 second.)
- 4 Press **Mode 1** and **Mode 2** at the same time to display Screen 36. The settings are stored in EEPROM.
- 5 When you close the setup mode, press **Stop**.

<Screen 36>

<< SETUP MODE >>  
HOPPER TIMER

<Screen 37>

HOPPER TIMER  
XX S

(Blinking)

## ■ Setting heater control

When you set the heater control, you must set as follows:

- 1 In Screen 2, press **Mode 1** 17 times (18 times for M3099GX/GH) to go to the HEATER CONTROL screen. <Screen 38>
- 2 Press **Mode 2** to display Screen 39. If "ON" is displayed, the heater control will be done. If "OFF" is displayed, warming-up will finish within 30 seconds, if necessary. When the heater is broken, please set "OFF". Each time **Mode 1** is pressed, "ON" and "OFF" appear alternately. The setting is stored in EEPROM automatically.
- 3 Press **Mode 2** to display Screen 38. When you close the setup mode, press **Stop**.

<Screen 38>

<< SETUP MODE >>  
HEATER CONTROL

<Screen 39>

HEATER CONTROL  
ON

## ■ Setting hopper height

When you set the hopper height, you must set it as follows:

- 1 At Screen 2, press **Mode 1** 18 times (or 19 times for the M3099GX/GH) to go to the HOPPER HEIGHT SET screen. <Screen 40>
- 2 Press **Mode 2** to see Screen 41.  
Then, press **Mode 2** to set a hopper height at which 1,000 documents can be set and go back to Screen 40.  
Alternatively, press **Mode 1** to go to Screen 42.
- 3 At Screen 42, press **Mode 2** to set a hopper height at which 500 documents can be set and go back to Screen 40.  
At Screen 42, press **Mode 1** to go to Screen 43.
- 4 At Screen 43, press **Mode 2** to set a hopper height at which 250 documents can be set and go back to Screen 40.  
At Screen 43, press **Mode 1** to go back to Screen 41.

<Screen 40>

```
<< SETUP MODE >>
HOPPER HEIGHT SET
```

<Screen 41>

```
HOPPER HEIGHT SET
1 0 0 0 SHEETS
```

(Blinking)

<Screen 42>

```
HOPPER HEIGHT SET
5 0 0 SHEETS
```

(Blinking)

<Screen 43>

```
HOPPER HEIGHT SET
2 5 0 SHEETS
```

(Blinking)



# ***GLOSSARY OF TERMS***

---

## **A4 size**

A standard paper size used in Japan and other countries. Paper size is 210 x 297 mm (8.25 x 11.6 inches).

## **Abrasion counter**

Indicates when belts/rollers should be replaced. The number of read document accumulates until an operator resets the counter. It should be reset when consumables are replaced.

## **ASCII**

The acronym for American Standard Code for Information Interchange.

ASCII is a set of 256 codes (numbered 0 to 255) used to communicate information between a computer and another device such as scanner.

## **Automatic separation**

The image processing method to detect the difference between text and photos and choose the threshold accordingly. Automatic separation allows the scanner to switch between line mode and half tone mode in one pass.

## **Automatic start mode (<--> manual start mode)**

In this mode the reading operation is activated only by START command.

## **Back-side reading = Back-side scanning**

Refers to reading the back-side of the document, specifically in Duplex reading mode.

## **Bit**

The smallest unit of information in computer memory. A bit is a single digit, either a 1 or a 0, in the binary numbering system.

Eight bits equal one byte.

## **Density**

Refers to a measurement of the depth of the display in this manual.

## **Dither**

Technique for producing halftone images representing the entire grayscale using two pixel levels black and white.

---

## **Double feed detection**

A function which detects the status when multiple sheets are fed in the transport unit.

## **dpi**

Dots per inch.

## **Drop-out color**

A color which is used to the document but does not appear in the read image.

## **Duplex reading mode**

Both sides of the document are read in this mode.

## **Endorser**

The unit for printing characters before or after scanning. These character may be used for collation of the documents and the image data. (See Chapter 6 ENDORSER.)

## **Endorser value**

The number printed by the endorser.

## **Equipment Error**

An error that is not recoverable by operator. Call CE.

## **Error diffusion**

High-quality halftone (pseudo-grayscale) image production based on black-and-white pixel binarization. A pixel's optical density and that of adjacent pixels are summed, with black pixels relocated in their order of density as they relate to adjacent pixels.

The purpose of this technique is to minimize the average error between read and printed densities. Density data for adjacent pixels is modified by diffusing errors on the objective pixel into several pixels, which are then binarized. This maintains high grayscale levels and resolution during reading, while suppressing more patterns by dotted halftone images such as newspaper photo graphs.

## **Filtering**

The quality of images written in pencil or ball-pointed pen and read depends on the reflective light characteristics of the ink or lead.

Dropped pixel's may produce out lines, gaps or thin, barely connected lines due to even optical density. Filtering detects areas lighter than their surroundings and increases their density to improve image clarity.



---

## **Front-side reading = Front-side scanning**

Refers to reading the front-side of the document, specifically in Duplex reading mode.

## **Halftone processing**

Used to reproduce a photograph which includes a shade as an image composed of dots, namely a binary image. Dithering and error diffusion processing are examples of the halftone processing.

## **Heater control**

The heater is set to ON or OFF to keep the lamp at a constant temperature and stabilize the intensity of the lamp.

## **Hexadecimal**

A base-16 numbering system(also commonly referred to as hex numbers). Since a base-16 system requires 16 digits, numbers 0 through 9 and letters A through F are used. It is convenient to express binary numbers in hexadecimal because fewer digits are required.

## **Image emphasis**

Density is decreased for lighter but not completely white areas adjacent to black areas. Weakening this emphasis eliminates spot noise or produces softened images.

## **Image processing**

An image is read with specified parameters.

## **Initial screen**

A screen displayed when the power is turned on or when reading is activated by the command from the host computer.

## **INK EMPTY**

A warning issued when the number of dots printed by the print head exceeds a specified value. It indicates that the life of the print head is near to the end and the replacement of the print head is soon necessary.

## **Interface**

The connection that allows communication from one part of a system to another. For example, electrical signals are transferred between the computer and scanner over an interface cable.

---

## **Inversion (Reverse-image reading)**

In reverse-image reading, data is changed from black to white and vice versa.

## **IPC pre-set mode**

While reading binary images, it is necessary to set the scanner according to the quality of the sheet to be read. In this mode these settings can be performed in advance by corresponding each setting to a pattern number.

## **IRAS**

Initialization of the hardware.

## **Landscape**

A document is transported and read with the long side vertical to the moving direction.

## **Letter size**

A standard paper size used in the U.S.A. and other countries. Paper size is 8-1/2 x 11 inches (215.9 x 279.4 mm).

## **Linedrawing mode**

Selecting linedrawing mode makes threshold and contrast settings effective but prevents brightness from being set. The specified threshold value determines whether black or white pixels are scanned. Linedrawing mode is therefore appropriate for scanning text and line art images.

## **Manual Feed mode = Manual Mode**

Requires the operator to feed each document manually to the hopper table.

## **Manual start mode (<→ automatic start mode)**

The reading operation is activated by pressing the START button in this mode.

## **Mirror image**

The read image is symmetrically flipped to produce a mirror image of the original detected in the main scanning direction.

---

## Noise removal

Isolated noise from an image appearing as black spots in white areas and voids in black areas is removed to improve image quality.

## Operator panel

A panel containing the scanner indicators and buttons. The operator panel is used to control scanner operations such as loading document, selecting features, and changing setup options.

## Outline extraction

The boundary between black and white areas is traced and the outline extracted for closed areas.

## PAPER JAM

A warning informing the user that document is jammed in the transport unit, or that transportation is disabled because the transport unit is slippery. This warning also appears when a double fed is detected.

## Photograph mode (White level follower ON)

Selecting photograph mode makes brightness and contrast settings effective but prevents the threshold from being set. With photograph mode, the darkness of image corresponds to the black-pixel density, making it suitable in scanning images such as photographs having gradations.

## Photo mode = photograph mode

A photograph is read properly in this mode.

## Picking start time

The period from the manual insertion of the document until picking starts after the document passes the hopper empty sensor.

## Picking time

The period from the start of picking until the document reaches SF1 sensor. Specify a little longer picking time for the document with a large friction factor.

## Pick speed

A speed when a document is picked. Set the pick speed to SLOW to prevent JAM or MISS PICK.

## Portrait

A document is transported and read with the long side parallel to the moving direction.

---

## **Pre-picking**

A setting in which a document to be read next is placed at the front of the reading unit while the previous document is read. Setting the pre-picking makes the process speedier.

## **Print head**

A cartridge located in the endorser (optional). It contains the ink reservoirs and creates the ink droplets. It is replaceable by operator.

## **Print head life counter = ink counter**

A counter which accumulates the number of the printed dots. When the accumulated number exceeds a specified value, "INK EMPTY" appears.

## **Print number reset method**

Determines whether or not to reset the number printed by the endorser to zero. This scanner can be set so that the number is reset when the hopper empty is detected.

## **Readable status**

A status when the power is turned on or when reading is activated by the command from the host computer.

## **Reading counter**

Indicates the total number of read document from reading start until the hopper becomes empty.

## **Read operation**

Refers to the reading operation including Simplex reading and Duplex reading.

## **Reset method of endorser**

Refer to "Print number reset method".

## **RS-232C interface**

A type of serial interface. See Serial interface.

## **SCSI-ID**

Used to specify a particular SCSI device when the initiator selects a target or the target re-connects to the initiator.

---

## **Serial interface**

A standard computer interface. Information is transferred between devices over a single wire (although other wires are used for control).

With a serial interface, an interface cable greater than 3 meters (10 feet) can be used. This is often necessary in networking environments, where the scanner may be shared.

## **SETUP mode**

In this mode, users can view or set a variety of function in Off-line.

## **SFI sensor**

The document detection sensor. It detects the light that transmits the paper. It also detects the double feed error.

## **Simplex reading mode**

Only the front side of the document is read in this mode. Place the documents face-up at the center of the hopper table.

## **Smoothing**

Smoothing eliminates jaggies from slanted lines and curves. Irregular convexities are deleted and irregular concavities filled in. This is useful in OCR applications, for example.

## **Start command time-out**

Occurs if START command does not arrive before the specified time after reading the previous document is complete. In this case the hopper table is lowered.

## **Temporary Error**

An error that is recoverable by operator.

## **Terminator**

Devices with SCSI interface are daisy-chained. A resistor that includes terminal circuits needs to be placed at both ends of a cable when devices are daisy-chained.



# INDEX

- A**
  - A3 1-6
  - A4 1-6
  - Abrasion counter 1-9
  - Activating the Setup Mode 7-1
  - ADF mode 1-6
  - Adjusting LCD contrast 7-8
  - Ambient condition 5-1
  - Arrangement 1-4
  - Assemblies 1-3
  
- B**
  - Back-side reading mode 1-6
  - Belt 5-3
  - Belt ASY 5-3
  - Button
    - /LED Function 1-5, 1-11
    - Specification (M3099GX/GH) 3-17
    - Specification and Reading Mode Setting (M3099 EX/EH) 3-2
  - Buzzer functions 1-14
  
- C**
  - Cable Connection 2-4
  - Checking the Components 1-1
  - Connecting
    - the interface cable 2-5
    - the power cable 2-4
  - Consumables 5-3
  - Consumable kit 1-1
  - Contents of the Setup Mode 7-2
  - Conventions iii
  
- D**
  - Density 1-6, 1-7
  - Density button 3-4, 3-10, 3-14
  - Dimensions 5-1, 5-2
  - Document
    - button 3-7, 3-12, 3-14
    - orientation 1-6
    - Quality 4-2
    - Size 4-1
    - Document type 4-2
    - Double letter 1-6
  - Duplex
    - button 3-2
    - reading mode 1-7
    - (back-side) reading mode 3-14
    - (front-side) reading mode 3-10
  
- E**
  - Endorser 5-4, 6-1
  - Equipment error 1-14
  
- F**
  - Fedding direction 4-1
  - Fine paper 4-2
  - Front-side reading mode 1-6
  - Front/Back button 3-2
  
- H**
  - Halftone
    - button 3-6, 3-11, 3-14
    - processing 1-6, 1-7
  - Heat capacity 5-1
  - Hopper 1-2
  
- I**
  - Image processing option 1-6, 1-7
  - IMPORTANT NOTE TO USERS i
  - Input power 5-1
  - Inspection 2-2
  - Installation Specifications 5-1
  - IPC pre-set mode 1-9, 1-13

**L**

Label

- A 2-2
- B 2-3
- C 2-3
- D 2-3

Lamp 5-3

Landscape 1-6

Landscape button 3-5, 3-11

LCD 1-4, 1-10

LCD Display 1-6, 1-12

LED 1-5, 1-11

Legal 1-6

Letter 1-6

**M**

Manual

- button 3-8, 3-12, 3-17
- mode 1-6

Mode

- 1 button 3-17
- 2 button 3-17

**O**

OCR paper 4-2

Operation Status 1-8

Operator's Guide 1-1

Operator

- panel 1-4, 1-10, 3-1
- Panel (M3099 EX/EH) 1-4,
- Panel (M3099 GX/GH) 1-10

Option 5-4

**P**

Pad 5-3

Panel Operation 6-2

Paper weight 4-2

Perface ii

Photo/linedrawing mode 1-6, 1-7

Pick roller 5-3

Plain paper 4-2

Portrait 1-6

Power

- cable 1-1
- consumption 5-1
- switch 2-4, 3-1

Precautions 2-1, 4-2

Print Head 5-3

**R**

Reading

- counter 1-8,
- counter and Abrasion counter 1-12
- mode 1-6

Read side 1-6

Reset of abrasion counter 7-7

Resetting

- of endorser 7-10
- of ink counter 7-10

Resolution 1-6

Resolution button 3-4, 3-10

Roller ASY 5-3



**S**

Scanner 1-1  
Screen transition 3-9, 3-13, 3-15  
Setting  
    buzzer 7-7  
    double feed detection 7-3  
    heater control 7-14  
    hopper height 7-15  
    hopper time 7-14  
    initial value of endorser 7-9  
    IPC-2 pre-set mode 7-4  
    pick speed 7-9  
    picking time 7-13  
    picking start time 7-12  
    pre-pick 7-8  
    product-ID 7-12  
    reset method of endorser 7-10  
    RS-232C transfer rate 7-11  
    SCSI-ID 7-11  
    time-out limit 7-13  
Simplex  
    (front-side) reading 1-6  
    (front-side) reading mode 3-3  
    reading mode 1-6  
Size 1-6  
Size button 3-3, 3-10  
Specifications 6-1  
Stacker 1-2  
Start button 3-16, 3-17  
Stop button 3-16, 3-17

**T**

Terminator 1-1  
Temporary  
    error 1-14  
    Lable (An Example) 2-3  
Turning  
    the Power On 3-1  
    the power switch off 2-4  
Types 1-2

**U**

Units 1-2  
Units and Assemblies 1-2

**W**

Weight 5-1



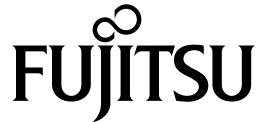

## DECLARATION OF CONFORMITY

(according to EN45014)

according to Electromagnetic Compatibility Directive 89/336/EEC and Low Voltage Directive 73/23/EEC, Annex III B.

FUJITSU LIMITED, 1-1, Kamikodanaka 4-Chome, Nakahara-Ku, Kawasaki 211-88, Japan

declares, in sole responsibility, that the following product, including the options or accessories

Product Type : IMAGE SCANNER  
Model Number : M3099EH, M3099EX  
Approval ID Number : S9451194

referred to in this declaration, conforms with the following directives and standards ;

Electromagnetic Compatibility Directive 89/336/EEC, 92/31/EEC, 93/68/EEC  
Low Voltage Directive 73/23/EEC, 93/68/EEC

EN55022 1994 Class B  
EN50082-1 1992 (IEC801-2 1984/ IEC801-3 1984/ IEC801-4 1988)  
EN60950 1992/A1:1993/A2:1993

The product on safety has been evaluated to EN60950 and has been confirmed to comply with all related requirements of EN60950.

Importer / Distributor in EU :

Fujitsu Europe Ltd.,

2, Longwalk Road, Stockley Park, Uxbridge, Middlesex UB11 1AB, England, U.K.

Japan, June 04 1996

Reference No. : DOC-1184-101-96

  
Nobuo Takeda  
Department Manager  
Quality assurance Department  
Printer and Scanner Division



## DECLARATION OF CONFORMITY

(according to EN45014)

according to Electromagnetic Compatibility Directive 89/336/EEC and Low Voltage Directive 73/23/EEC, Annex III B.

FUJITSU LIMITED, 1-1, Kamikodanaka 4-Chome, Nakahara-Ku, Kawasaki 211-88, Japan

declares, in sole responsibility, that the following product, including the options or accessories

Product Type : IMAGE SCANNER

Model Number : M3099GH, M3099GX

Approval ID Number : S9451194

referred to in this declaration, conforms with the following directives and standards :

Electromagnetic Compatibility Directive 89/336/EEC, 92/31/EEC, 93/68/EEC  
Low Voltage Directive 73/23/EEC, 93/68/EEC

EN55022 1994 Class B

EN50082-1 1992 (IEC801-2 1984/ IEC801-3 1984/ IEC801-4 1988)

EN60950 1992/A1:1993/A2:1993

The product on safety has been evaluated to EN60950 and has been confirmed to comply with all related requirements of EN60950.

Importer / Distributor in EU :

Fujitsu Europe Ltd.,

2, Longwalk Road, Stockley Park, Uxbridge, Middlesex UB11 1AB, England, U.K.

Japan, June 04 1996

Reference No. : DOC-1184-102-96

Nobuo Takeda  
Department Manager  
Quality assurance Department  
Printer and Scanner Division

FUJITSU